

# FPM/FLS/FOT-600

Power Meter/Light Source/  
Optical Loss Test Set



---

Copyright © 2003–2013 EXFO Inc. All rights reserved. No part of this publication may be reproduced, stored in a retrieval system or transmitted in any form, be it electronically, mechanically, or by any other means such as photocopying, recording or otherwise, without the prior written permission of EXFO Inc. (EXFO).

Information provided by EXFO is believed to be accurate and reliable. However, no responsibility is assumed by EXFO for its use nor for any infringements of patents or other rights of third parties that may result from its use. No license is granted by implication or otherwise under any patent rights of EXFO.

EXFO's Commerce And Government Entities (CAGE) code under the North Atlantic Treaty Organization (NATO) is 0L8C3.

The information contained in this publication is subject to change without notice.

### ***Trademarks***

EXFO's trademarks have been identified as such. However, the presence or absence of such identification does not affect the legal status of any trademark.

### ***Units of Measurement***

Units of measurement in this publication conform to SI standards and practices.

### ***Patents***

EXFO's Universal Interface is protected by US patent 6,612,750.

Version number: 7.0.0

---

# Contents

Certification Information .....	v
<b>1 Introducing the FPM/FLS/FOT-600 .....</b>	<b>1</b>
Main Features .....	1
Power Sources .....	3
Typical Applications .....	4
Conventions .....	5
<b>2 Safety Information .....</b>	<b>7</b>
Laser Safety Information	
(FLS-600 and FOT-600 without VFL) .....	8
Laser Safety Information (Units with VFL) .....	9
Electrical Safety Information .....	9
<b>3 Getting Started .....</b>	<b>11</b>
Turning the Unit On and Off .....	11
Activating Automatic Shutdown (Auto-Off) .....	13
Activating the Backlight .....	14
Accessing and Navigating Setup Menus .....	14
Installing the EXFO Universal Interface (EUI) .....	16
Cleaning and Connecting Optical Fibers .....	17
<b>4 Measuring Power or Loss (FPM-600 and FOT-600) .....</b>	<b>19</b>
Nulling Electrical Offsets .....	19
Setting Power Correction Factor .....	20
Defining a List of Favorite Wavelengths .....	22
Referencing Your Power Meter to a Source .....	24
Measuring Power or Loss .....	27
Automatically Detecting Wavelength .....	29
Activating Hold Min/Max Power Mode .....	30
Setting Pass/Fail Thresholds .....	31
<b>5 Using a Light Source (FLS-600 and FOT-600) or VFL .....</b>	<b>33</b>
Defining a List of Favorite Wavelengths .....	33
Activating/Deactivating a Light Source or VFL .....	34
Modulating the Source Signal .....	34
Using Auto-Switching Mode .....	35
Sending Source Power Value with Signal .....	36

---

<b>6 Saving and Recalling Power/Loss Values .....</b>	<b>39</b>
Setting Autonoming Scheme .....	39
Saving, Recalling and Deleting Data .....	40
Transferring Data to a Computer .....	43
<b>7 Maintenance .....</b>	<b>45</b>
Cleaning EUI Connectors .....	45
Cleaning Fixed Connectors .....	48
Cleaning VFL-Type Connectors .....	50
Cleaning Detector Ports .....	51
Recharging and Replacing the Battery .....	52
Recalibrating the Unit .....	54
Recycling and Disposal (Applies to European Union Only) .....	54
<b>8 Troubleshooting .....</b>	<b>55</b>
Solving Common Problems .....	55
Reverting Unit to Factory Settings .....	56
Error Codes and Descriptions .....	57
Contacting the Technical Support Group .....	58
Transportation .....	59
<b>9 Warranty .....</b>	<b>61</b>
General Information .....	61
Liability .....	62
Exclusions .....	63
Certification .....	63
Service and Repairs .....	64
EXFO Service Centers Worldwide .....	65
<b>A Technical Specifications .....</b>	<b>67</b>
FPM-600 .....	67
FLS-600 .....	68
FOT-600 .....	69

## Certification Information

### North America Regulatory Statement

This unit was certified by an agency approved in both Canada and the United States of America. It has been evaluated according to applicable North American approved standards for product safety for use in Canada and the United States.

Electronic test and measurement equipment is exempt from FCC part 15, subpart B compliance in the United States of America and from ICES-003 compliance in Canada. However, EXFO Inc. makes reasonable efforts to ensure compliance to the applicable standards.

The limits set by these standards are designed to provide reasonable protection against harmful interference when the equipment is operated in a commercial environment. This equipment generates, uses, and can radiate radio frequency energy and, if not installed and used in accordance with the user guide, may cause harmful interference to radio communications. Operation of this equipment in a residential area is likely to cause harmful interference in which case the user will be required to correct the interference at his own expense.

Modifications not expressly approved by the manufacturer could void the user's authority to operate the equipment.

## European Community Declaration of Conformity

### DECLARATION OF CONFORMITY

**Application of Council Directive(s):** 1999/5/EC – The R&TTE Directive  
2011/65/UE – Restriction of the use of certain hazardous substances (RoHS)  
And their amendments

**Manufacturer's Name and Address:**

<b>EXFO Inc.</b> 400 Godin Avenue Quebec City, Quebec G1M 2K2, CANADA Tel.: +1 418 683-0211	<b>EXFO Europe Ltd.</b> Winchester House School Lane, Chandlers Ford SO53 4DG, UK Tel.: +44 2380 246 800
---	--

**Equipment Type/Environment:** Test & Measurement / Industrial  
**Trade Name/Model No.:** OLTS / FOT-600, Power Meter / FPM-600 & Light Source / FLS-600

**Standard(s) to which Conformity is declared:**

<b>EN 61010-1:2010 Edition 3.0</b>	<b>Safety requirements for electrical equipment for measurement, control, and laboratory use – Part 1: General requirements</b>
<b>EN 61326-1:2006</b>	<b>Electrical equipment for measurement, control and laboratory use – EMC requirements – Part 1: General requirements</b>
<b>EN 60825-1:2007 Edition 2.0</b>	<b>Safety of laser products – Part 1: Equipment classification and requirements</b>

I, the undersigned, hereby declare that the equipment specified above conforms to the above Directive and Standards.

**Manufacturer:**



*Stephen Bull, E. Eng*  
Vice-President Research and Development

400 Godin Avenue,  
Quebec City, Quebec  
G1M 2K2 CANADA  
November 12, 2012



# 1 **Introducing the FPM/FLS/FOT-600**

This user guide covers the following products (unless otherwise specified, descriptions apply to all):

- FPM-600 Power Meter
- FLS-600 Light Source
- FOT-600 Optical Loss Test Set: combines both a power meter and a light source

## Main Features

	FPM	FLS	FOT
Ge or GeX detector with 44 and 45 calibrated wavelengths respectively	X		X
Absolute power and link loss measurements	X		X
Editable list of favorite power meter wavelengths	X		X
Editable list of favorite source wavelengths		X	X
Automatic wavelength detection	X		X
No offset nulling of detectors required in normal operation	X		X
Multiple source configurations on a single port [FOT-600] or on one or two ports [FLS-600]		X	X
Optional visual fault locator			X
Transmission of editable power value with source's signal for automatic reference with compatible power meter		X	X
Transmission of wavelength to compatible power meter in automatic wavelength or auto-switching mode		X	X

# Introducing the FPM/FLS/FOT-600

## Main Features

	FPM	FLS	FOT
Modulated signal emission or detection (270 Hz, 1 kHz and 2 kHz) compatible with other EXFO units	X	X	X
Data storage on unit and USB transfer to a computer	X		X
User-configurable pass/fail thresholds with LED indicator	X		X
Automatic shutdown after 10 minutes of idle time (auto-off)	X	X	X

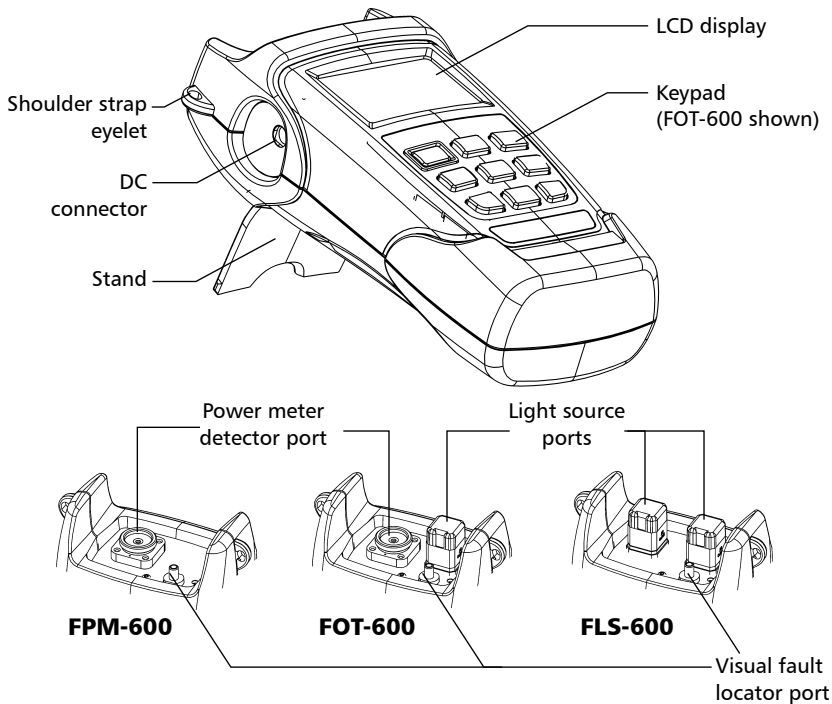



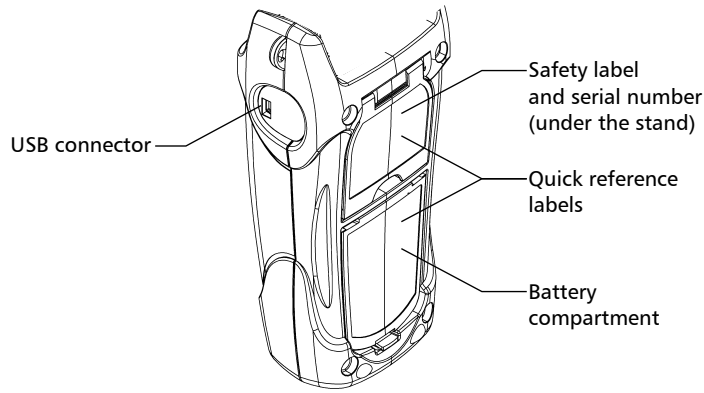



## Power Sources

The units operate with the following power sources:

- AC adapter (connected to standard power outlet—indoor use only)   
Compatible car outlet adapter available upon request.
- Li-Ion rechargeable battery (automatically takes over if you unplug the AC adapter) 



### IMPORTANT

If the battery level becomes too low, the unit turns itself off.

**Note:** *When it is connected with the AC adapter/charger, the unit will function even if the battery is not present.*

- Possible to switch from AC adapter/charger to battery power or vice versa without affecting operation.
- The battery recharges automatically when the AC adapter/charger is connected.

### **Typical Applications**

- Transmitter power measurements (dBm and W)
- Fiber-link loss testing (dB)
- Component insertion-loss testing (dB)
- Fiber identification with 270-Hz, 1-kHz and 2-kHz signals
- Fiber installation and maintenance applications
- FTTx: testing of passive optical networks (PONs)

## Conventions

Before using the product described in this guide, you should understand the following conventions:



### **WARNING**

Indicates a potentially hazardous situation which, if not avoided, could result in *death or serious injury*. Do not proceed unless you understand and meet the required conditions.



### **CAUTION**

Indicates a potentially hazardous situation which, if not avoided, may result in *minor or moderate injury*. Do not proceed unless you understand and meet the required conditions.



### **CAUTION**

Indicates a potentially hazardous situation which, if not avoided, may result in *component damage*. Do not proceed unless you understand and meet the required conditions.



### **IMPORTANT**

Refers to information about this product you should not overlook.



## 2 **Safety Information**



### **WARNING**

Do not install or terminate fibers while a light source is active. Never look directly into a live fiber and ensure that your eyes are protected at all times.



### **WARNING**

The use of controls, adjustments and procedures other than those specified herein may result in exposure to hazardous situations or impair the protection provided by this unit.



### **IMPORTANT**

When you see the following symbol on your unit , make sure that you refer to the instructions provided in your user documentation. Ensure that you understand and meet the required conditions before using your product.

## Safety Information

*Laser Safety Information (FLS-600 and FOT-600 without VFL)*

---

### Laser Safety Information (FLS-600 and FOT-600 without VFL)

Your instrument is a Class 1M laser product in compliance with standards IEC 60825-1 2007 and 21 CFR 1040.10. Invisible laser radiation may be encountered at the output port.

The product is safe under reasonably foreseeable conditions of operation but it may be hazardous if you use optics within a diverging or collimated beam. *Do not view directly with optical instruments.*

The following label(s) indicate that the product contains a Class 1M source:



## Laser Safety Information (Units with VFL)

Your instrument is a Class 3R laser product in compliance with standards IEC 60825-1 2007 and 21 CFR 1040.10. It is potentially harmful in direct intrabeam viewing.

The following label(s) indicate that the product contains a Class 3R source:



Affixed to back  
(under the stand)

**VFL LASER APERTURE**

Indicated on  
connector panel

## Electrical Safety Information

The AC adapter/charger provided with this unit is specifically designed to work with your product.



### **WARNING**

Use only accessories that meet EXFO expectations.



### **CAUTION**

EXFO guarantees the specifications and viability of the products **ONLY** if they are used with chargers and batteries provided by EXFO.

## Safety Information

### Electrical Safety Information

Equipment Ratings	
Temperature	
▶ Operation	-0 °C to 40 °C (32 °F to 104 °F)
▶ Storage	-40 °C to 70 °C (-40 °F to 158 °F)
Relative humidity <sup>a</sup>	
▶ unit	≤ 95 % non-condensing
▶ AC adapter	0 % to 80 % non-condensing
Maximum operation altitude	5000 m (6562 ft)
Pollution degree	2 (connected to AC mains) <sup>b</sup> 3 (powered by batteries) <sup>c</sup>
Overvoltage category	II
Input power <sup>d</sup>	
▶ unit	--- 9 V; 9 W
▶ AC adapter	~ 120 V, 14.4 W, 60 Hz ~ 230 V, 17 W, 50 Hz

- a. Measured in 0 °C to 31 °C (32 °F to 87.8 °F) range, decreasing linearly to 50 % at 40 °C (104 °F)
- b. For indoor use only.
- c. Equipment is normally protected against exposure to direct sunlight, precipitations and full wind pressure.
- d. Not exceeding ± 10 % of the nominal voltage



# 3 Getting Started

## Turning the Unit On and Off

When you turn off the FPM-600 or the FOT-600, it saves the current wavelength, unit and reference power. It also saves the Hold Min/Max power mode if activated.



### IMPORTANT

If you remove batteries (and the AC adapter is unplugged), the unit will turn off *without saving the above values*.

If batteries are low (and the AC adapter is unplugged), the unit will save the above values and turn off.

**Note:** *Offset nulling values are always returned to factory settings.*

#### **To turn on the unit:**

Press . The unit displays EXFO Inc. for a few seconds. You may use it immediately under normal conditions.

#### **To turn off the unit:**

From normal operating mode, hold down  a few seconds.



### WARNING

When the ACTIVE LED on your unit is on, the laser source is active and emitting light. Do not look directly into a live fiber, and ensure that your eyes are protected at all times.

# Getting Started

## Turning the Unit On and Off

### LED Indicators



#### FPM/FOT-600:

Whether the test passed or failed according to the thresholds

#### FLS/FOT-600:

The laser source is active.

### Display

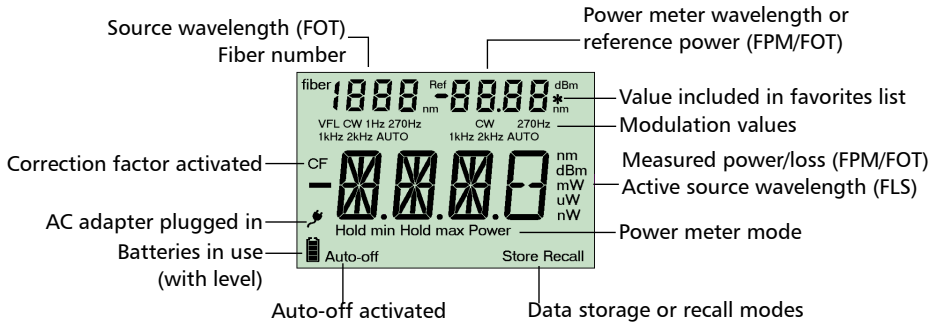

### Keypad

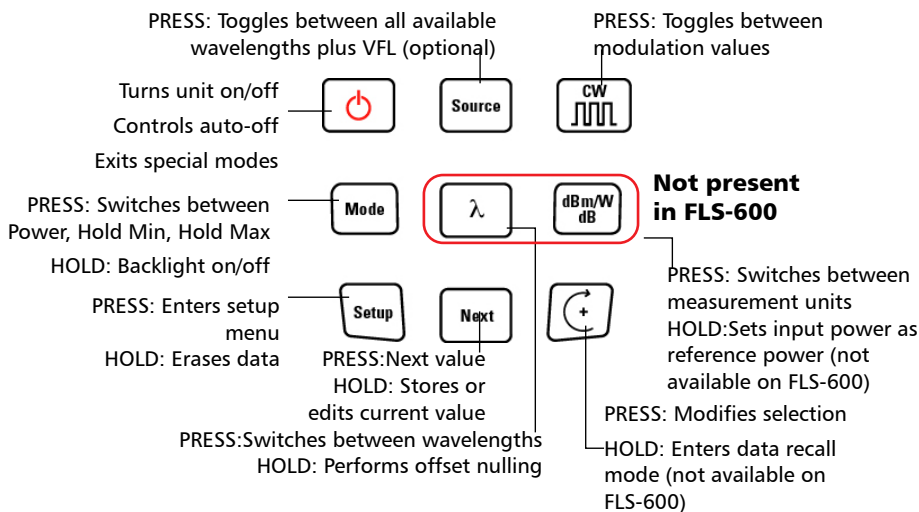

## Activating Automatic Shutdown (Auto-Off)

When auto-off is activated, the unit will turn off after 10 minutes of idle time.

Auto-off is activated by default when you turn on the unit.

### To deactivate/reactivate auto-off:

When unit is on, press .

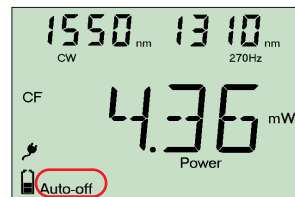

## Getting Started

### Activating the Backlight



---

## Activating the Backlight

When operating the unit in the dark, use the backlight to make data on the display more visible. The keypad buttons will also light for about 10 seconds.



**Note:** *When backlight is activated, you must always press a button once to light the keypad, then press the actual button you want.*

### **To activate/deactivate the backlight:**

From normal operating mode, hold down  ( on FLS-600) a few seconds.

## Accessing and Navigating Setup Menus

Setup menus differ in each model. You may access and navigate menus as follows:

- Press  repeatedly to switch between options in a menu level.
- Press  once to access a submenu from the main level.
- Press  to exit menus (one level at a time).

**Note:** *Details about each menu option are given in this user guide.*

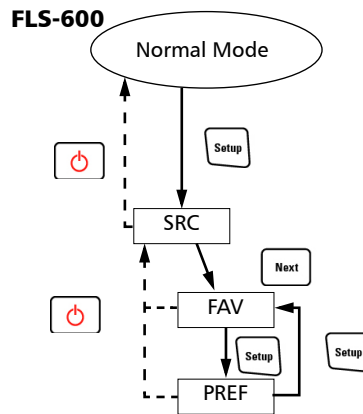
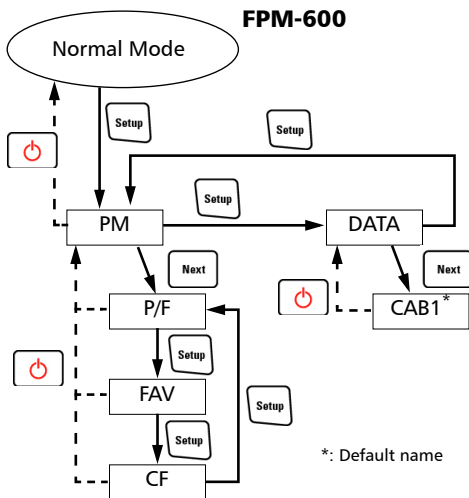
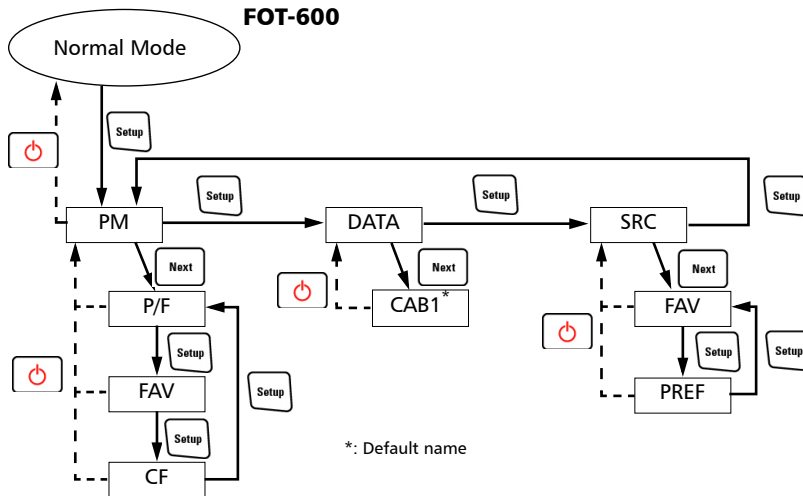

## Getting Started

### Installing the EXFO Universal Interface (EUI)

---

## Installing the EXFO Universal Interface (EUI)

The EUI fixed baseplate is available for connectors with angled (APC) or non-angled (UPC) polishing. A green border around the baseplate indicates that it is for APC-type connectors.

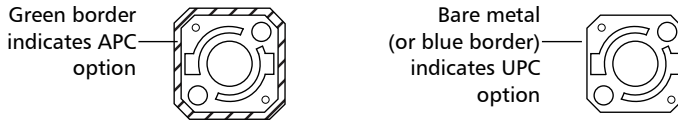

### **To install an EUI connector adapter onto the EUI baseplate:**

1. Hold the EUI connector adapter so the dust cap opens downwards.

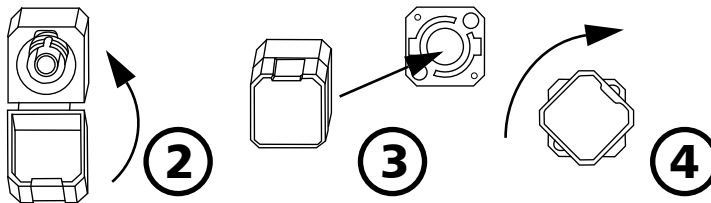

2. Close the dust cap in order to hold the connector adapter more firmly.
3. Insert the connector adapter into the baseplate.
4. While pushing firmly, turn the connector adapter clockwise on the baseplate to lock it in place.

## Cleaning and Connecting Optical Fibers



### IMPORTANT

To ensure maximum power and to avoid erroneous readings:

- Always inspect fiber ends and make sure that they are clean as explained below before inserting them into the port. EXFO is not responsible for damage or errors caused by bad fiber cleaning or handling.
- Ensure that your patchcord has appropriate connectors. Joining mismatched connectors will damage the ferrules.

#### ***To connect the fiber-optic cable to the port:***

- 1.** Inspect the fiber using a fiber inspection microscope. If the fiber is clean, proceed to connecting it to the port. If the fiber is dirty, clean it as explained below.
- 2.** Clean the fiber ends as follows:
  - 2a.** Gently wipe the fiber end with a lint-free swab dipped in isopropyl alcohol.
  - 2b.** Use compressed air to dry completely.
  - 2c.** Visually inspect the fiber end to ensure its cleanliness.

## Getting Started

### *Cleaning and Connecting Optical Fibers*

---

3. Carefully align the connector and port to prevent the fiber end from touching the outside of the port or rubbing against other surfaces.

If your connector features a key, ensure that it is fully fitted into the port's corresponding notch.

4. Push the connector in so that the fiber-optic cable is firmly in place, thus ensuring adequate contact.

If your connector features a screwsleeve, tighten the connector enough to firmly maintain the fiber in place. Do not overtighten, as this will damage the fiber and the port.

**Note:** *If your fiber-optic cable is not properly aligned and/or connected, you will notice heavy loss and reflection.*

EXFO uses good quality connectors in compliance with EIA-455-21A standards.

To keep connectors clean and in good condition, EXFO strongly recommends inspecting them with a fiber inspection probe before connecting them. Failure to do so will result in permanent damage to the connectors and degradation in measurements.



# 4 **Measuring Power or Loss** **(FPM-600 and FOT-600)**

## **Nulling Electrical Offsets**

Temperature and humidity variations affect the performance of electronic circuits and optical detectors. Nulling the electrical offsets eliminates these effects. *Your unit has been designed not to require offset nulling under normal operation*, but you should perform it whenever environmental conditions change significantly or when measuring very low power values.



### **IMPORTANT**

If light reaches the detector when nulling offsets, *LIGH* appears on the display and the nulling is not performed. You will need to press a key to return to the previous display.

**Note:** *Factory-defined values will be reinstated when you turn off the unit.*

#### **To perform an offset nulling:**

Hold down  a few seconds. The unit displays **NULL** while nulling the offsets, then returns to normal mode.

**Note:** *Keypad is disabled during the operation.*



## Measuring Power or Loss (FPM-600 and FOT-600)

### Setting Power Correction Factor

---

## Setting Power Correction Factor





You may apply a correction factor (CF) to measured power to compensate for inaccuracies or drifts. You should change the CF after performing an offset nulling.

$$\text{Power}_{\text{corrected}} = \text{Power}_{\text{measured}} \times \text{CF}$$

For each favorite wavelength, the CF is set to 1.00 at the factory (even if the unit indicates “----”), but allowed values range between 0.85 and 1.15.

**Note:** Some other products express the CF in dB, so the CF would be added to measured power.

### To set a correction factor for one or more wavelengths:







1. From normal operating mode, press  repeatedly until you reach **PM**.
2. Press  to access the first submenu, then press  repeatedly until you reach the **CF** menu.
3. Press  to switch between available wavelengths. An asterisk (\*) appears beside activated correction factors. If no correction factor is set for a wavelength, the unit indicates “----”.
4. Press  to activate/deactivate the displayed correction factor. A “CF” indicator will appear next to measured power in normal mode.



## Measuring Power or Loss (FPM-600 and FOT-600)

### *Setting Power Correction Factor*

---

5. Edit the correction factor as follows:
  - 5a. Hold down  a few seconds. The first digit of the CF blinks.
  - 5b. Clear all digits by holding down  for a few seconds.  
AND/OR  
Select a digit to change by holding  until it blinks, then increase its value by pressing  (it returns to 0 after 9).
  - 5c. While a digit blinks, hold down  for a few seconds to save the modified value (it remains in memory even when you turn off the unit) or press  to return to the previous value without saving.
6. Press  twice to exit setup menus.

## Measuring Power or Loss (FPM-600 and FOT-600)

### Defining a List of Favorite Wavelengths





You must put the wavelengths you want to use on a list of favorite wavelengths (the FAV list). Only wavelengths on this list are available for measurements. You may enter up to 40 favorite wavelengths.

Specifications are guaranteed for calibrated wavelengths only. For other wavelengths, the unit will determine values based on the calibrated wavelengths (3-point interpolation).

#### To add wavelengths to the FAV list (or to remove them):

Detector Type	Calibrated Wavelengths (nm)	Default Favorite Wavelengths <sup>a</sup> (nm)
► Ge	800, 820, 830, 840, 850, 860, 870, 880, 910, 980, 1270, 1280, 1290, 1300, 1310, 1320, 1330, 1340, 1350, 1370, 1390, 1410, 1430, 1450, 1460, 1470, 1480, 1490, 1500, 1510, 1520, 1530, 1540, 1550, 1560, 1570, 1580, 1590, 1600, 1610, 1620, 1630, 1640, 1650.	
► GeX	All the above plus 1060.	Same as above

a. To revert to default favorite wavelengths see *Reverting Unit to Factory Settings* on page 56.



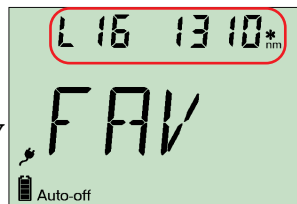





1. From normal operating mode, press  repeatedly until you reach **PM**.
2. Press  to access the first submenu, then press  repeatedly until you reach the **FAV** menu.
3. Press  to switch between available wavelengths. An asterisk (\*) appears beside wavelengths already on the list. If no wavelength is set for a position, the unit indicates “----”. You may also press  to switch between defined wavelengths only.



## Measuring Power or Loss (FPM-600 and FOT-600)

*Defining a List of Favorite Wavelengths*

---

4. Press  to include/exclude the displayed wavelength.
5. Edit the wavelength value as follows:
  - 5a. Hold down  a few seconds. The first digit of the wavelength blinks.
  - 5b. Clear all digits by holding down  for a few seconds.  
AND/OR  
Select a digit to change by holding  until it blinks, then increase its value by pressing  (it returns to 0 after 9).
  - 5c. While a digit blinks, hold down  for a few seconds to save the modified value (it remains in memory even when you turn off the unit) or press  to return to the previous value without saving.
6. Press  twice to exit setup menus.

## Measuring Power or Loss (FPM-600 and FOT-600)

*Referencing Your Power Meter to a Source*

---

### Referencing Your Power Meter to a Source

In reference mode, your unit displays the loss created by the fiber under test only, since a reference value is subtracted from the measured power.

**Note:** *You must set a reference value separately for each wavelength.*

Compatible sources (such as FOT-600 and FLS-600) can transmit a power value to your power meter, avoiding the need for manual referencing.



### IMPORTANT

The value sent is not the source's actual power. It is a user-defined value that may not take the optical link's loss into account.

#### ***To receive the reference power value from a compatible source:***

1. Connect a compatible source to your power meter (as shown below, with or without a fiber under test).
2. Use the source to emit the signal that contains its power value (see *To change the signal modulation:* on page 35).

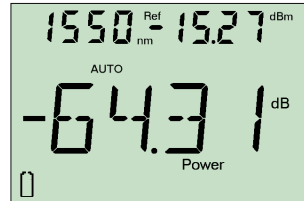

- If reference value or units change, the power meter beeps.
- The new reference power is displayed in the top right corner (in dBm) and current loss reading is automatically switched to dB.

**Note:** *When using this feature, you cannot change the power meter's wavelength manually. The power meter behavior is totally determined by the source.*

## Measuring Power or Loss (FPM-600 and FOT-600)

Referencing Your Power Meter to a Source

### To reference the power meter to a source manually:

1. Using the proper adapter, connect a light source (such as FLS-600 or FOT-600) to the detector port of your power meter.

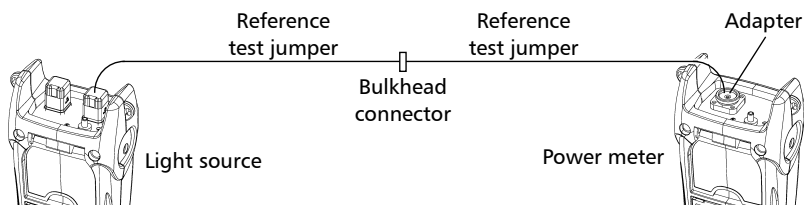

2. Activate the source at the desired wavelength.
3. Match the source and power meter wavelengths:

- If the source emits an auto-wavelength signal or is in auto-switching mode (see *Automatically Detecting Wavelength* on page 29 and *Using Auto-Switching Mode* on page 35), the power meter automatically matches the source wavelength.

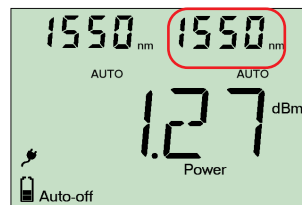

OR

- Press  $\lambda$  to switch between pre-selected wavelengths (see *Defining a List of Favorite Wavelengths* on page 22).
4. Hold down  $\frac{\text{dBm/W}}{\text{dB}}$  for a few seconds. The power meter stores the currently detected power as the new reference power. Reference power is displayed in the top right corner (in dBm) and current loss reading is automatically switched to dB.

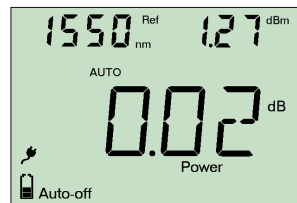

## Measuring Power or Loss (FPM-600 and FOT-600)

### *Referencing Your Power Meter to a Source*

---

5. Repeat the procedure for each wavelength you want to reference (if you use auto-switching mode, the power meter automatically references wavelengths one at a time).

**Note:** When using dB units, press  to display the current wavelength for a few seconds. To change this wavelength, press  again while it is displayed.

**Note:** Once all desired wavelengths have been referenced, do not disconnect the Reference Test Jumper from the source port.



### Measuring Power or Loss

Measuring absolute power or link loss is done the same way, except for the referencing step.

**To perform power or loss measurements:**

1. If necessary, perform an offset nulling (see *Nulling Electrical Offsets* on page 19).
2. Check and clean your fibers appropriately for optimum performance (see *Cleaning and Connecting Optical Fibers* on page 17).
3. For loss measurements, reference your power meter to a light source (see *Referencing Your Power Meter to a Source* on page 24), then deactivate the light source.
4. Using the proper adapter and test jumpers, connect a fiber under test to a light source (such as FLS-600 or FOT-600) and to the detector port of your unit.

**Note:** *If you have referenced your power meter to a source, simply connect a fiber under test to the test jumpers used for referencing.*

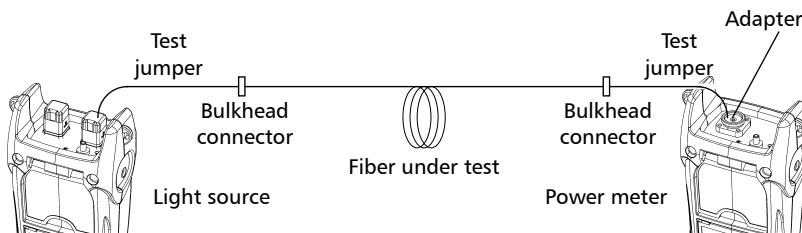

5. Activate the source at the desired wavelength.

## Measuring Power or Loss (FPM-600 and FOT-600)

### Measuring Power or Loss

6. Match the source and power meter wavelengths:

- If the source emits an auto-wavelength signal or is in auto-switching mode (see *Automatically Detecting Wavelength* on page 29 and see *To receive the auto-wavelength signal or detect the source's auto-switching mode*: on page 29), the power meter automatically matches the source wavelength.

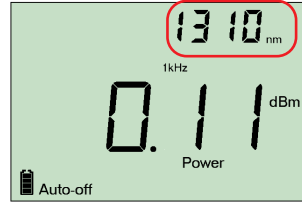

OR

- Press  $\lambda$  to switch between pre-selected wavelengths (see *Defining a List of Favorite Wavelengths* on page 22).

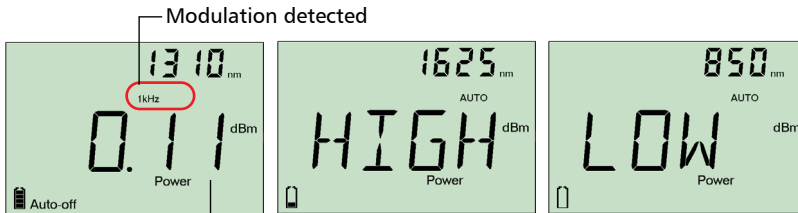

Actual power or loss of fiber under test

When power or loss is outside power limits (see *Technical Specifications* on page 67)

When the unit detects a modulated signal, it beeps and displays the modulation value and *average* measured power or loss (see left illustration above). You may notice a slightly unstable last digit.

7. If necessary, change the displayed units by pressing  $\frac{\text{dBm/W}}{\text{dB}}$ .
8. Repeat the procedure for other wavelengths.

### Automatically Detecting Wavelength

Compatible sources (such as FOT-600 and FLS-600) can transmit their wavelength value through the fiber, avoiding the need to manually match the source and power meter wavelengths.

**Note:** *When you receive an auto-wavelength signal or when the source is in auto-switching mode, you cannot manually change the power meter wavelength. The power meter behavior is totally determined by the source.*

#### **To receive the auto-wavelength signal or detect the source's auto-switching mode:**

1. Connect a compatible source to your power meter.
2. Activate the source in Auto mode (FOT-600 and FLS-600: see *Modulating the Source Signal* on page 34) or in auto-switching mode.

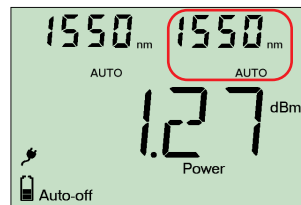

Your power meter automatically matches the source wavelength. If the wavelengths differ, it also beeps and returns you to normal operating mode.

## Measuring Power or Loss (FPM-600 and FOT-600)

### Activating Hold Min/Max Power Mode

---

## Activating Hold Min/Max Power Mode

With the Hold Min/Max mode you can record extreme values of a varying power signal. You could use it to test the stability of a light source over time.

In this mode, the unit displays the minimum or maximum power value read up to now. It continuously updates the display if a new min/max is measured.

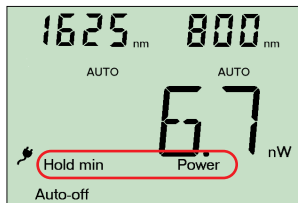

### **To activate the Hold Min or Hold Max mode:**

Press **Mode** to switch between Hold Max, Hold Min and regular power measurement.

### **To reset the maximum or minimum value:**

Hold down **Setup** for a few seconds. The unit displays “\_ \_ \_ \_”.







## Setting Pass/Fail Thresholds

You can define thresholds to specify acceptable power (dBm) or loss (dB) values for each wavelength. Thresholds are often supplied by system manufacturers and depend on the system deployed.

When a threshold is activated, the PASS/FAIL LED is turned on. If it is green, the threshold succeeded, if the PASS/FAIL LED is red, the threshold failed.



### To set pass/fail thresholds:



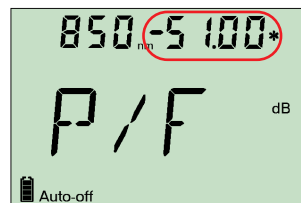





1. From normal operating mode, press  repeatedly until you reach **PM**.
2. Press  to access the first submenu, then press  repeatedly until you reach the **P/F** menu.
3. Press  to switch between power (dBm) and loss (dB) values.
4. Press  to switch between available wavelengths. An asterisk (\*) appears beside activated thresholds. If no threshold is set for a wavelength, the unit indicates “----”.
5. Press  to activate/deactivate the displayed threshold. The PASS/FAIL LED will light (green or red) when you return to normal mode.



## Measuring Power or Loss (FPM-600 and FOT-600)

### Setting Pass/Fail Thresholds

---

6. Edit the pass/fail threshold as follows:
  - 6a. Hold down  for a few seconds. The first digit of the threshold blinks.
  - 6b. Clear all digits by holding down  for a few seconds.  
AND/OR  
Select a digit to change by holding  until it blinks, then increase its value by pressing  (it returns to 0 after 9). After the last digit, all digits blink: you may add/remove the “-” sign by pressing .
  - 6c. While a digit blinks, hold down  for a few seconds to save the modified value (it remains in memory even when you turn off the unit) or press  to return to the previous value without saving.
7. Press  twice to exit setup menus.

# 5 Using a Light Source (FLS-600 and FOT-600) or VFL

The FLS-600 may contain up to three sources (one-port models) or up to four sources (two-port models). The FOT-600 may contain up to three sources.

**Note:** The VFL option may also be present on the FPM-600.







## Defining a List of Favorite Wavelengths

You may put the wavelengths you want to use on a list of favorite wavelengths (the FAV list). Only wavelengths on this list are available for measurements.

At the factory (or after recalibration), the list contains all source wavelengths.

**Note:** The list must always contain at least one wavelength. When you empty the list, the first source wavelength is automatically added.

### To add wavelengths to the FAV list (or to remove them):

1. From normal operating mode, press  repeatedly until you reach **SRC**.
2. Press  to access the first submenu, then press  repeatedly until you reach the **FAV** menu.
3. Press  to switch between available wavelengths. An asterisk (\*) appears beside wavelengths already on the list.
4. Press  to include/exclude the displayed wavelength.
5. Press  twice to exit setup menus.

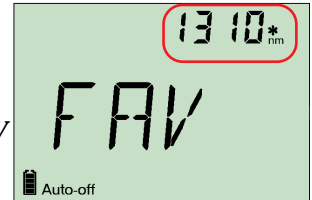

## Using a Light Source (FLS-600 and FOT-600) or VFL

Activating/Deactivating a Light Source or VFL

### Activating/Deactivating a Light Source or VFL

Only one source may be active at a time. When no source is active, the unit displays **OFF**.

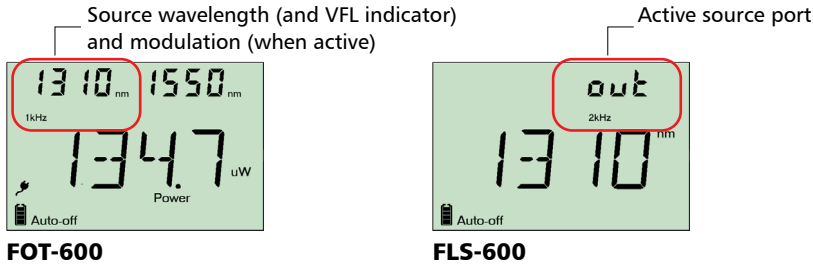

**To activate a light source (or VFL) and change the wavelength:**

Press  to activate each available source in turn, including the VFL. The unit displays the wavelength and modulation.

**To deactivate the light source:**

Press  until you get past the last source.

### Modulating the Source Signal

When you activate the first source (after turning on the unit), the signal is always CW (unmodulated). When you switch sources, the modulation remains the same (VFL remembers its own modulation). Modulation is indicated in the top left (port #1) or top right (port #2) corner.

Available modulation values are: CW, Auto, auto-switching mode, 270 Hz, 1 kHz and 2 kHz (VFL: CW and 1 Hz only).

**Note:** *Auto is a modulated signal detected by compatible units (see Automatically Detecting Wavelength on page 29). It provides longer battery life than CW, but covers a reduced power range.*



**Note:** Auto-switching mode is a special signal detected by compatible units (see *Using Auto-Switching Mode* on page 35).

#### To change the signal modulation:

1. Activate the source.
2. Press  to switch between available modulations.

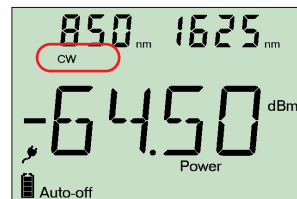

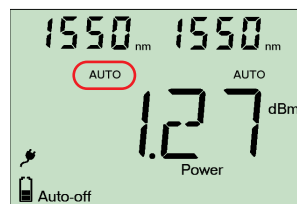

## Using Auto-Switching Mode

In auto-switching mode, your source automatically switches from one wavelength to another. When connected to the light source, a compatible power meter displays the power value for each wavelength one at a time. The wavelength value appearing on the display changes every two seconds.



The unit will show the source's favorite wavelengths one at a time (see *Defining a List of Favorite Wavelengths* on page 33).

#### To activate auto-switching mode:

1. Press  to activate the source.
2. Press  to switch between available modulations until the **Auto** indicator blinks on your display.

## Using a Light Source (FLS-600 and FOT-600) or VFL

### *Sending Source Power Value with Signal*

---

## Sending Source Power Value with Signal

Your source can transmit a user-defined power value to compatible power meters (such as FOT-600 and FPM-600) through the fiber. If the reference source is far from the power meter, you can connect your source to the power meter to send the reference value. With this feature you can also correct for power variations.

**Note:** *If you connect a fiber between FOT-600's source and detector ports, the unit can use the actual source output power as reference power.*













**Note:** *For details about how compatible power meters receive this power value, see Referencing Your Power Meter to a Source on page 24.*



### IMPORTANT

The value sent is not (and will not affect) the source's actual power. It is a user-defined value that may not take the optical link's loss into account.

### **To define the source power value to use as reference:**

1. From normal operating mode, press  repeatedly until you reach **SRC**.
2. Press  to access the first submenu, then press  repeatedly until you reach the **PREF** menu.
3. Press  to switch between available source wavelengths and select one. The unit displays the currently defined power value for this wavelength.
4. Edit the power value as follows:
  - 4a. Hold down  for a few seconds. The first digit of the power value blinks.
  - 4b. Revert all digits to 0 by holding down  for a few seconds.  
AND/OR  
Select a digit to change by pressing  until it blinks, then increase its value by pressing  (it returns to 0 after 9). After the last digit, all digits blink: you may add/remove the “-” sign by pressing .
  - 4c. While a digit blinks, hold down  for a few seconds to save the modified value (it remains in memory even when you turn off the unit) or press  to return to the previous value without saving.
5. Press  twice to exit setup menus.

## Using a Light Source (FLS-600 and FOT-600) or VFL

### *Sending Source Power Value with Signal*

---

#### **To use the source's actual output power as reference (FOT-600 only):**

1. Connect a fiber between the source and power meter of same unit.
2. Activate the source at the desired wavelength.
3. Match the source and power meter wavelengths:

- If the source emits an auto-wavelength signal or is in auto-switching mode (see *Automatically Detecting Wavelength* on page 29 and *Using Auto-Switching Mode* on page 35), the power meter automatically matches the source wavelength.

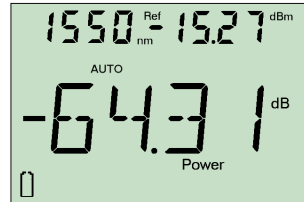

OR

- Press  $\lambda$  to switch between pre-selected wavelengths (see *Defining a List of Favorite Wavelengths* on page 22).
4. From normal operating mode, hold down **Source** and **dBm/W dB**. The unit displays **PREF** for a few seconds while saving the value, then returns to normal mode.

#### **To send the source power value:**

1. Activate the source.
2. Change the modulation signal to AUTO or auto-switching.

If you use auto-switching mode, the power value of each wavelength will automatically be sent.









## 6 Saving and Recalling Power/Loss Values

You can save 1000 power/loss values in your unit, along with references. You will save and recall this data according to cable names and fiber numbers. To free up memory, you can transfer saved data to a computer or simply delete all.

### Setting Autonaming Scheme

When saving data, the unit suggests fiber IDs based on autonaming settings. After saving a value, the unit prepares the next fiber ID according to the selected increment (0, 1 or 2).

**To define the cable name and the starting fiber ID and increment value:**

1. From normal operating mode, press  repeatedly until you reach DATA.
2. Press  to access **CAB1** or the last cable name edited.
3. Hold down  until the first character of the cable name blinks.
4. Select a character to change by holding  until it blinks, then increase its value by pressing  (it returns to 0 after Z).
5. While a digit blinks, hold down  for a few seconds to save the modified value (it remains in memory even when you turn off the unit) or press  to return to the previous value without saving.
6. Press  twice to exit setup menus.

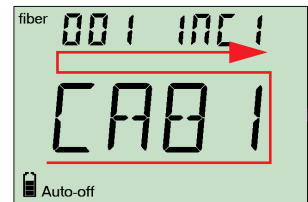

## Saving and Recalling Power/Loss Values

*Saving, Recalling and Deleting Data*

---





### Saving, Recalling and Deleting Data



#### IMPORTANT

- ▶ You cannot recover deleted data. Ensure that you transfer your data to a computer if you intend to use it later.
- ▶ Deleting a single value does not free memory. To free memory, you must delete all data at once.

#### **To save a power/loss value:**

1. If you want to view or change the fiber ID before saving:
  - 1a. From normal operating mode, press  or  to view the fiber ID that will be used next.
  - 1b. Change the fiber ID by using  and  to move forward or backward in the list.
2. Hold down  for a few seconds to save the measured value under the selected fiber ID.

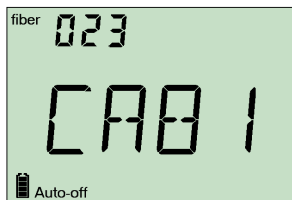



### IMPORTANT









When the power meter is connected to the fiber or DUT, you must wait until at least one loss measurement is displayed on the power meter before pressing the  button.

Once you have pressed the button, you must wait until the Store indicator on-screen disappears before disconnecting the power meter or light source to test the next fiber or DUT.

When in Auto-Switching mode, it is important NOT to disconnect the power meter or light source from the fiber or DUT before the storage sequence is complete. The storage sequence is complete when the Store indicator turns off.

The storage process will save the upcoming values, not the preceding ones.

#### **To recall saved data:**

1. From normal operating mode, hold down  for a few seconds. The **Recall** indicator is displayed with the cable name, then the last saved value and its fiber ID.
2. When fiber ID is displayed, hold down  for a few seconds to return to the cable name list. Select the cable in which you want to recall saved data by using  and  to move forward or backward. The last saved value in the selected cable and its fiber ID will be displayed after 3 seconds.
3. View values you want by using  and  to move forward or backward in saved data. You can also change the units by pressing .
4. Press  to return to normal mode.

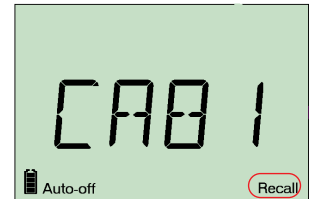









## Saving and Recalling Power/Loss Values







### *Saving, Recalling and Deleting Data*

---

#### **To delete a single saved value from the unit:**



1. From normal operating mode, hold down  for a few seconds. The **Recall** indicator is displayed with the cable name, then the last saved value and its fiber ID. 
2. When fiber ID is displayed, hold down  a few seconds to return to the cable name list. Select the cable in which you want to delete saved data by using  and  to move forward or backward. The last saved value in the selected cable and its fiber ID will be displayed after 3 seconds.
3. Select the value to delete by using  and  to move forward or backward in saved data.
4. Hold down  a few seconds. The unit displays “dEL”, then displays another saved data.
5. Press  to return to normal mode.

#### **To delete a cable name:**

1. From normal operating mode, hold down  a few seconds. The **Recall** indicator is displayed with the last cable name, then the last saved value and its fiber ID. 
2. When fiber ID is displayed, hold down  for a few seconds to return to the cable name list, then, select the cable you want to delete by using  and  to move forward or backward.
3. Hold down  a few seconds. The unit displays “dEL”, then displays another cable name.
4. Press  to return to normal mode.



#### To delete all saved data from the unit:

1. From normal operating mode, hold down  a few seconds. The **Recall** indicator is displayed with the last cable name, then the last saved value and its fiber ID.
2. When fiber ID is displayed, hold down both  and  for a few seconds. The unit displays “dEL” and “ALL”, then automatically returns to normal mode.



## Transferring Data to a Computer

Using an appropriate USB cable and the Handheld Data Transfer software, you can transfer saved data from your handheld unit to a computer. This way, you can increase storage capacity, perform better analyses on your data and create reports.



### IMPORTANT

Transferred data is not automatically deleted from your unit.

#### To transfer data to a computer:

1. Using a USB cable, connect your unit to an available USB port of the computer.
2. Turn on both the computer and your handheld unit. Connect your unit to a power outlet to ensure that your unit will remain on during the transfer.
3. On the computer, launch the Handheld Data Transfer application and start the operation.

The unit displays “REM” and temporarily deactivates the keyboard and auto-off.

**Note:** For details about setting up the software and transferring data, refer to the Handheld Data Transfer *online help*.



# 7 Maintenance

This product contains no user-serviceable parts. However, it contains sensitive electronic and optical components, and should be handled carefully and stored in its carrying case when not in use.

To help ensure long, trouble-free operation:

- Always inspect fiber-optic connectors before using them and clean them if necessary.
- Keep the unit free of dust.
- Clean the unit casing and front panel with a cloth slightly dampened with water.
- Store unit at room temperature in a clean and dry area. Keep the unit out of direct sunlight.
- Avoid high humidity or significant temperature fluctuations.
- Avoid unnecessary shocks and vibrations.
- If any liquids are spilled on or into the unit, turn off the power immediately, disconnect from any external power source, remove the batteries and let the unit dry completely.



## WARNING

The use of controls, adjustments and procedures other than those specified herein may result in exposure to hazardous situations or impair the protection provided by this unit.

## Cleaning EUI Connectors

Regular cleaning of EUI connectors will help maintain optimum performance. There is no need to disassemble the unit.



## IMPORTANT

If any damage occurs to internal connectors, the module casing will have to be opened and a new calibration will be required.

## Maintenance

### Cleaning EUI Connectors



## WARNING

Looking into the optical connector while the light source is active **WILL** result in permanent eye damage. EXFO strongly recommends to **TURN OFF** the unit before proceeding with the cleaning procedure.

### To clean EUI connectors:

1. Remove the EUI from the instrument to expose the connector baseplate and ferrule.

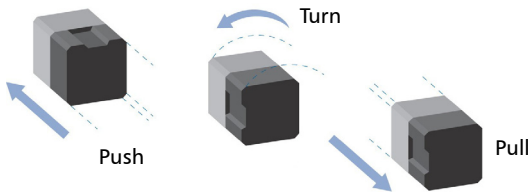

2. Moisten a 2.5 mm cleaning tip with *one drop* of isopropyl alcohol (alcohol may leave traces if used abundantly).
3. Slowly insert the cleaning tip into the EUI adapter until it comes out on the other side (a slow clockwise rotating movement may help).

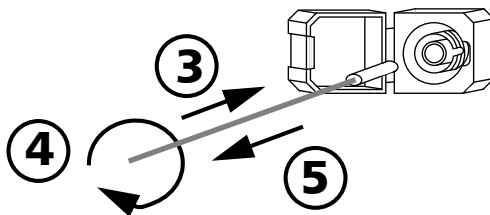

4. Gently turn the cleaning tip one full turn, then continue to turn as you withdraw it.
5. Repeat steps 3 to 4 with a dry cleaning tip.

**Note:** Make sure you don't touch the soft end of the cleaning tip.

**6.** Clean the ferrule in the connector port as follows:

**6a.** Deposit *one drop* of isopropyl alcohol on a lint-free wiping cloth.



## **IMPORTANT**

Isopropyl alcohol may leave residues if used abundantly or left to evaporate (about 10 seconds).

**Avoid contact between the tip of the bottle and the wiping cloth, and dry the surface quickly.**

**6b.** Gently wipe the connector and ferrule.

**6c.** With a dry lint-free wiping cloth, gently wipe the same surfaces to ensure that the connector and ferrule are perfectly dry.

**6d.** Verify connector surface with a portable fiber-optic microscope (for example, EXFO's FOMS) or fiber inspection probe (for example, EXFO's FIP).

**7.** Put the EUI back onto the instrument (push and turn clockwise).

**8.** Throw out cleaning tips and wiping cloths after one use.

## **Cleaning Fixed Connectors**

Regular cleaning of connectors will help maintain optimum performance. *Do not try to disassemble the unit. Doing so would break the connector.*



### **WARNING**

Looking into the optical connector while the light source is active **WILL** result in permanent eye damage. EXFO strongly recommends to **TURN OFF** the unit before proceeding with the cleaning procedure.

#### **To clean fixed connectors:**

1. Fold a lint-free wiping cloth in four to form a square.
2. Moisten the center of the lint-free wiping cloth with *only one drop* of isopropyl alcohol.



### **IMPORTANT**

Alcohol may leave traces if used abundantly. Avoid contact between the tip of the bottle and the wiping cloth, and do not use bottles that distribute too much alcohol at a time.

3. Gently wipe the connector threads three times with the folded and moistened section of the wiping cloth.



### **IMPORTANT**

Isopropyl alcohol takes approximately ten seconds to evaporate. Since isopropyl alcohol is not absolutely pure, evaporation will leave microscopic residue. Make sure you dry the surfaces before evaporation occurs.

4. With a dry lint-free wiping cloth, gently wipe the same surfaces three times with a rotating movement.

5. Throw out the wiping cloths after one use.
6. Moisten a cleaning tip (2.5 mm tip) with *only one drop* of isopropyl alcohol.



## IMPORTANT

Alcohol may leave traces if used abundantly. Avoid contact between the tip of the bottle and the cleaning tip, and do not use bottles that distribute too much alcohol at a time.

7. Slowly insert the cleaning tip into the connector until it reaches the ferrule inside (a slow clockwise rotating movement may help).

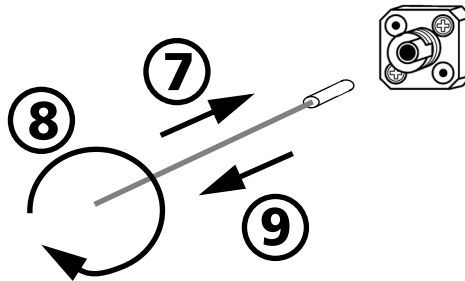

8. Gently turn the cleaning tip one full turn.
9. Continue to turn as you withdraw the cleaning tip.
10. Repeat steps 7 to 9, but this time with a dry cleaning tip (2.5 mm tip provided by EXFO).

**Note:** Make sure you don't touch the soft end of the cleaning tip and verify the cleanliness of the cotton tip.

11. Throw out the cleaning tips after one use.

## Maintenance

### Cleaning VFL-Type Connectors

---

## Cleaning VFL-Type Connectors

VFL-type connectors are fixed on your unit and can be cleaned using a mechanical cleaner.



## WARNING

Verifying the surface of the connector with a fiber-optic microscope WHILE THE UNIT IS ACTIVE WILL result in permanent eye damage.

### ***To clean a connector using a mechanical cleaner:***

1. Insert the mechanical into the optical adapter, and push the outer shell into the cleaner.

**Note:** *The cleaner makes a clicking sound to indicate that the cleaning is done.*

2. Verify connector surface with a portable fiber-optic microscope (for example, EXFO's FOMS) or fiber inspection probe (for example, EXFO's FIP).



## Cleaning Detector Ports

Regular cleaning of detectors will help maintain measurement accuracy.



### **IMPORTANT**

Always cover detectors with protective caps when unit is not in use.

#### ***To clean detector ports:***

- 1.** Remove the protective cap and adapter (FOA) from the detector.
- 2.** If the detector is dusty, blow dry with compressed air.
- 3.** Being careful not to touch the soft end of the swab, moisten a cleaning tip with *only one drop* of isopropyl alcohol.



### **IMPORTANT**

Alcohol may leave traces if used abundantly. Do not use bottles that distribute too much alcohol at a time.

- 4.** While applying light pressure (to avoid breaking the detector window), gently rotate the cleaning tip on the detector window.
- 5.** Repeat step 4 with a dry cleaning tip or blow dry with compressed air.
- 6.** Discard the cleaning tips after one use.

## Maintenance

### Recharging and Replacing the Battery

---

## Recharging and Replacing the Battery

The Li-Ion battery will last about 70 hours (power meter) or 50 hours (source in Auto mode) in normal operation. The charge status is shown on the unit display (lower left corner).



### IMPORTANT

- ▶ The battery is not charged at the factory. Fully charge it (about 4 hours) before using it for the first time.
- ▶ The battery functions and charges properly between 0 °C and 45 °C (32 °F and 113 °F). It will not charge if the temperature is below -10 °C (14 °F) or above 45 °C (113 °F).
- ▶ Never store battery at temperatures above 60 °C (140 °F).
- ▶ Charge only with specified charger.

**Note:** *Charging your unit's battery can take up to 5 hours. This battery was custom-made for your unit; replacement batteries must be purchased from EXFO.*

#### **To recharge the Li-Ion battery:**

Connect the unit to a power outlet (or car outlet) using the AC adapter/charger. The charge cycle will start and end automatically.

**Note:** *While charging, the battery indicator animates continuously. It does not reflect the actual charge status until charging is complete.*

#### **To replace the battery:**

1. Turn off the unit (if the AC adapter is plugged in, you may replace the battery while unit is on).
2. Remove the battery compartment cover, located at the back of the unit.
3. Pull out the old battery using your fingers. Flipping the unit, battery-side down, will ease removal. Do not use tools in order to prevent damage to the battery envelope. Pull out the electrical connector. Put aside the old battery.
4. Remove the new battery from its package (keep the package for future use). Connect the electrical connector, ensuring that the pins are correctly aligned. Place the new battery into the unit.
5. Inspect the inside rib around the unit battery compartment to make sure it is free from any debris. Remove any debris using a dry cloth. Replace the battery compartment cover.

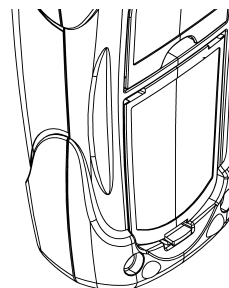

### **WARNING**

Only use an EXFO battery. Batteries from other suppliers could result in serious damage to your unit, or personal injuries. See *Contacting the Technical Support Group* on page 58 for more information on contacting EXFO.



### **WARNING**

Do not throw batteries into fire or water and do not short-circuit the batteries' electrical contacts. Do not disassemble.

## Recalibrating the Unit





Manufacturing and service center calibrations are based on the ISO/IEC 17025 Standard, which states that calibration documents must not contain a recommended calibration interval, unless this has been previously agreed upon with the customer.

Validity of specifications depends on operating conditions. For example, the calibration validity period can be longer or shorter depending on the intensity of use, environmental conditions and unit maintenance. You should determine the adequate calibration interval for your unit according to your accuracy requirements.

Under normal use, EXFO recommends calibrating your unit every three years.

**Note:** *The FlexCare warranty program includes Calibration/Verification packages (see Service and Repairs on page 64).*

### **To view the last calibration date (FOT-600 and FPM-600 only):**

1. From normal operating mode, hold down  and  for a few seconds. The unit displays the first embedded software version.
2. Press  until you reach the calibration date (and version) of the power meter.
3. Press  to return to normal mode.

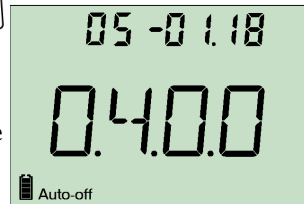



## Recycling and Disposal (Applies to European Union Only)

For complete recycling/disposal information as per European Directive WEEE 2012/19/UE, visit the EXFO Web site at [www.exfo.com/recycle](http://www.exfo.com/recycle).

# 8 Troubleshooting

## Solving Common Problems

Problem	Possible Cause	Solution
The unit does not turn on.	<ul style="list-style-type: none"> <li>▶ You did not press  long enough.</li> <li>▶ AC adapter/charger not connected.</li> <li>▶ Main battery discharged.</li> <li>▶ Weather too cold.</li> </ul>	<p>Press  for 2 seconds.</p> <p>Connect AC adapter/charger and charge battery.</p>
The unit takes very long to turn on.	Too many values saved in memory.	Delete all data from the unit.
Battery does not charge as expected.	<ul style="list-style-type: none"> <li>▶ Temperature too high.</li> <li>▶ Battery incorrectly connected.</li> <li>▶ Incorrect charger used.</li> </ul>	<p>Ensure temperature is within specifications.</p> <p>Ensure battery is connected properly.</p> <p>Use the correct charger.</p>
Unable to change power meter wavelength.	<ul style="list-style-type: none"> <li>▶ Unit receiving Auto (or REF) signal from source.</li> <li>▶ Only one wavelength in list.</li> </ul>	<p>Change source mode (see <i>Modulating the Source Signal</i> on page 34), then retry.</p> <p>Add wavelengths.</p>

## Troubleshooting

### Reverting Unit to Factory Settings

---

Problem	Possible Cause	Solution
Unable to change power meter dB unit or reference power. OR Changed unit or reference value are replaced by other values after a while.	Unit receiving REF signal from source. See <i>Sending Source Power Value with Signal</i> on page 36.	Wait a few seconds until power value is received, then retry.
Many beeps, unstable optical power and blinking <b>Auto</b> (or modulation) indicator.	Power too low to recognize Auto mode (or modulation).	Increase source power or switch source to CW.
Reference power different than source output power.	Received power outside detector's range.	Change source output power.
Unit displays FULL even after you deleted a few values.	You must delete <i>all</i> values from the unit to free memory.	Delete all values as explained in <i>Saving, Recalling and Deleting Data</i> on page 40.
Going from the first value to the last value in recalled data is very slow.	Too many values saved in memory.	Delete all data from the unit.

## Reverting Unit to Factory Settings

You can revert most parameters on your unit to their factory state. *When you perform this operation, you will lose all customized parameters.*

### **To revert unit to factory settings:**

1. Turn off your unit.
2. While holding down , press . When your unit beeps, release .

## **Error Codes and Descriptions**

- ER: error code displayed until you press a key.
- WR: warning code displayed for 3 seconds, then unit returns to normal.

<b>Error Code</b>	<b>Description</b>	<b>Solution</b>
LIGH	Light detected while nulling offsets. Nulling is not performed.	Correctly place protective cap on detector port, then retry.
FULL	Storage memory full.	Delete data.
EMPt	Storage memory empty: <ul style="list-style-type: none"> <li>➤ You pressed <i>Recall</i> but no data was saved.</li> <li>➤ Last saved data deleted.</li> <li>➤ All data deleted.</li> </ul>	Add data.
29/30/ 34/36/ 56/57	Calibration errors.	Contact EXFO.
18/52	Incompatible wavelengths or power too low in PREF on FOT-600.	Match source and power meter wavelengths or increase source power.

## Troubleshooting

Contacting the Technical Support Group

---

# Contacting the Technical Support Group

To obtain after-sales service or technical support for this product, contact EXFO at one of the following numbers. The Technical Support Group is available to take your calls from Monday to Friday, 8:00 a.m. to 7:00 p.m. (Eastern Time in North America).

### Technical Support Group

400 Godin Avenue  
Quebec (Quebec) G1M 2K2  
CANADA



1 866 683-0155 (USA and Canada)  
Tel.: 1 418 683-5498  
Fax: 1 418 683-9224  
support@exfo.com

For detailed information about technical support, and for a list of other worldwide locations, visit the EXFO Web site at [www.exfo.com](http://www.exfo.com).

To accelerate the process, please have information such as the name and the serial number (see the product identification label), as well as a description of your problem, close at hand.

You may also be requested to provide the embedded software's version numbers.

### **To display the embedded software version:**

1. From normal operating mode, hold down  and  for a few seconds. The unit displays the first software version.
2. Press  to switch between the software and hardware versions.



Press  to return to normal mode.



## **Transportation**

Maintain a temperature range within specifications when transporting the unit. Transportation damage can occur from improper handling. The following steps are recommended to minimize the possibility of damage:

- Pack the unit in its original packing material when shipping.
- Avoid high humidity or large temperature fluctuations.
- Keep the unit out of direct sunlight.
- Avoid unnecessary shocks and vibrations.



# 9 **Warranty**

## **General Information**

EXFO Inc. (EXFO) warrants this equipment against defects in material and workmanship for a period of three years from the date of original shipment. EXFO also warrants that this equipment will meet applicable specifications under normal use.

During the warranty period, EXFO will, at its discretion, repair, replace, or issue credit for any defective product, as well as verify and adjust the product free of charge should the equipment need to be repaired or if the original calibration is erroneous. If the equipment is sent back for verification of calibration during the warranty period and found to meet all published specifications, EXFO will charge standard calibration fees.



### **IMPORTANT**

The warranty can become null and void if:

- **unit has been tampered with, repaired, or worked upon by unauthorized individuals or non-EXFO personnel.**
- **warranty sticker has been removed.**
- **case screws, other than those specified in this guide, have been removed.**
- **case has been opened, other than as explained in this guide.**
- **unit serial number has been altered, erased, or removed.**
- **unit has been misused, neglected, or damaged by accident.**

THIS WARRANTY IS IN LIEU OF ALL OTHER WARRANTIES EXPRESSED, IMPLIED, OR STATUTORY, INCLUDING, BUT NOT LIMITED TO, THE IMPLIED WARRANTIES OF MERCHANTABILITY AND FITNESS FOR A PARTICULAR PURPOSE. IN NO EVENT SHALL EXFO BE LIABLE FOR SPECIAL, INCIDENTAL, OR CONSEQUENTIAL DAMAGES.

## **Warranty**

### *Liability*

---

## **Liability**

EXFO shall not be liable for damages resulting from the use of the product, nor shall be responsible for any failure in the performance of other items to which the product is connected or the operation of any system of which the product may be a part.

EXFO shall not be liable for damages resulting from improper usage or unauthorized modification of the product, its accompanying accessories and software.

## Exclusions

EXFO reserves the right to make changes in the design or construction of any of its products at any time without incurring obligation to make any changes whatsoever on units purchased. Accessories, including but not limited to fuses, pilot lamps, batteries and universal interfaces (EUI) used with EXFO products are not covered by this warranty.

This warranty excludes failure resulting from: improper use or installation, normal wear and tear, accident, abuse, neglect, fire, water, lightning or other acts of nature, causes external to the product or other factors beyond the control of EXFO.



### **IMPORTANT**

In the case of products equipped with optical connectors, EXFO will charge a fee for replacing connectors that were damaged due to misuse or bad cleaning.

## Certification

EXFO certifies that this equipment met its published specifications at the time of shipment from the factory.

# Service and Repairs

EXFO commits to providing product service and repair for five years following the date of purchase.

**To send any equipment for service or repair:**

1. Call one of EXFO's authorized service centers (see *EXFO Service Centers Worldwide* on page 65). Support personnel will determine if the equipment requires service, repair, or calibration.
2. If equipment must be returned to EXFO or an authorized service center, support personnel will issue a Return Merchandise Authorization (RMA) number and provide an address for return.
3. If possible, back up your data before sending the unit for repair.
4. Pack the equipment in its original shipping material. Be sure to include a statement or report fully detailing the defect and the conditions under which it was observed.
5. Return the equipment, prepaid, to the address given to you by support personnel. Be sure to write the RMA number on the shipping slip. *EXFO will refuse and return any package that does not bear an RMA number.*

**Note:** *A test setup fee will apply to any returned unit that, after test, is found to meet the applicable specifications.*

After repair, the equipment will be returned with a repair report. If the equipment is not under warranty, you will be invoiced for the cost appearing on this report. EXFO will pay return-to-customer shipping costs for equipment under warranty. Shipping insurance is at your expense.

Routine recalibration is not included in any of the warranty plans. Since calibrations/verifications are not covered by the basic or extended warranties, you may elect to purchase FlexCare Calibration/Verification Packages for a definite period of time. Contact an authorized service center (see *EXFO Service Centers Worldwide* on page 65).

## **EXFO Service Centers Worldwide**

If your product requires servicing, contact your nearest authorized service center.

### **EXFO Headquarters Service Center**

400 Godin Avenue  
Quebec (Quebec) G1M 2K2  
CANADA

1 866 683-0155 (USA and Canada)  
Tel.: 1 418 683-5498  
Fax: 1 418 683-9224  
support@exfo.com

### **EXFO Europe Service Center**

Winchester House, School Lane  
Chandlers Ford, Hampshire S053 4DG  
ENGLAND

Tel.: +44 2380 246800  
Fax: +44 2380 246801  
support.europe@exfo.com

### **EXFO Telecom Equipment (Shenzhen) Ltd.**

3rd Floor, Building 10,  
Yu Sheng Industrial Park (Gu Shu  
Crossing), No. 467,  
National Highway 107,  
Xixiang, Bao An District,  
Shenzhen, China, 518126

Tel: +86 (755) 2955 3100  
Fax: +86 (755) 2955 3101  
support.asia@exfo.com





# A Technical Specifications



## IMPORTANT

The following technical specifications can change without notice. The information presented in this section is provided as a reference only. To obtain this product's most recent technical specifications, visit the EXFO Web site at [www.exfo.com](http://www.exfo.com).

## FPM-600

### SPECIFICATIONS<sup>a</sup>

Model	FPM-602	FPM-602X
Detector	Ge	GeX
Power range (dBm) <sup>b</sup>	10 to -70	26 to -55
Wavelength range (nm)	800 to 1650	800 to 1650
Calibrated wavelengths (nm)	800, 820, 830, 840, 850, 860, 870, 880, 910, 980, 1270, 1280, 1290, 1300, 1310, 1320, 1330, 1340, 1350, 1370, 1390, 1410, 1430, 1450, 1460, 1470, 1480, 1490, 1500, 1510, 1520, 1530, 1540, 1550, 1560, 1570, 1580, 1590, 1600, 1610, 1620, 1630, 1640, 1650	Same calibrated wavelengths as the FPM-602, plus 1060
Power uncertainty <sup>c</sup>	±5 % ± 0.1 nW	±5 % ± 3 nW
Resolution (dB)	±0.01 (10 dBm to -60 dBm)	±0.01 (26 dBm to -45 dBm)
Automatic offset nulling <sup>d</sup>	Yes	Yes
Display units	dB, dBm, W	dB, dBm, W
Tone detection	270 Hz, 1 kHz and 2 kHz	270 Hz, 1 kHz and 2 kHz
Auto-switching <sup>e</sup>	Yes	Yes
Warm-up period (min) <sup>f</sup>	0	0
Data storage (items)	more than 1000	more than 1000
Battery life (hours) (typical)	72	72
Warranty and recommended recalibration interval (years)	3	3

### GENERAL SPECIFICATIONS

Size (H x W x D)	190 mm x 100 mm x 62 mm	(7 1/2 in x 4 in x 2 1/2 in)
Weight	0.48 kg	(1.1 lb)
Temperature	operating -10 °C to 50 °C storage -40 °C to 70 °C	(14 °F to 122 °F) (-40 °F to 158 °F)
Relative humidity	0 % to 95 % non-condensing	

### NOTES

- Guaranteed unless otherwise specified. All specifications valid at 1550 nm and 23 °C ± 1 °C, with an FC connector.
- In CW mode; sensitivity defined as 6 x rms noise level.
- For calibrated wavelengths. Valid up to 20 dBm for FPM-602X.
- For power > -40 dBm for FPM-602, and > -25 dBm for FPM-602X.
- At 850 nm, 1300 nm, 1310 nm, 1490 nm, 1550 nm and 1650 nm; for power > -50 dBm for FPM-602 and > -40 dBm (typical) for FPM-602X.
- For a variation of ± 0.06 dB at power levels ≥ -40 dBm for FPM-602 and ≥ -25 dBm for FPM-602X.

# Technical Specifications

FLS-600

## FLS-600

SPECIFICATIONS <sup>a</sup>				
Model	12D	23BL	234BL	235BL
Central wavelength (nm)	850 ± 25 1300 +50/-10	1310 ± 20 1550 ± 20	1310 ± 20 1550 ± 20 1625 ± 15	1310 ± 20 1490 ± 10 1550 ± 20
Spectral width <sup>b</sup> (nm)	50/135	≤5	≤5	≤5
Output power (dBm)	≥-20/≥-20 (62.5/125 μm)	≥1/≥1	≥1/≥-3/≥-5	≥1/≥-4.5/≥-3
Power stability <sup>c</sup> (dB)				
15 min	±0.05	±0.03	±0.03	±0.03
8 h	±0.1	±0.1	±0.1	±0.1
Auto-switching	Yes	Yes	Yes	Yes
Tone generation	270 Hz, 1 kHz, 2 kHz	270 Hz, 1 kHz, 2 kHz	270 Hz, 1 kHz, 2 kHz	270 Hz, 1 kHz, 2 kHz
Battery life (hours) (typical in Auto mode)	50	50	50	50
Warranty (years)	3	3	3	3

GENERAL SPECIFICATIONS <sup>a</sup>		
Size (H x W x D)	190 mm x 100 mm x 62 mm	(7 1/2 in x 4 in x 2 1/2 in)
Weight	0.48 kg	(1.1 lb)
Temperature		
operating	-10 °C to 50 °C	(14 °F to 122 °F)
storage	-40 °C to 70 °C	(-40 °F to 158 °F)
Relative humidity	0 % to 95 % non-condensing	

# FOT-600

### SPECIFICATIONS<sup>a</sup>

Model	<b>FOT-602X</b>
Detector	GeX
Power range (dBm) <sup>b</sup>	26 to -55
Wavelength range (nm)	800 to 1650
Calibrated wavelengths (nm)	800, 820, 830, 840, 850, 860, 870, 880, 910, 980, 1270, 1280, 1290, 1300, 1310, 1320, 1330, 1340, 1350, 1370, 1390, 1410, 1430, 1450, 1460, 1470, 1480, 1490, 1500, 1510, 1520, 1530, 1540, 1550, 1560, 1570, 1580, 1590, 1600, 1610, 1620, 1630, 1640, 1650, 1060
Power uncertainty <sup>c</sup>	±5 % ± 3 nW
Resolution (dB)	±0.01 (26 dBm to -45 dBm)
Automatic offset nulling <sup>d</sup>	Yes
Display units	dB, dBm, W
Tone detection	270 Hz, 1 kHz and 2 kHz
Auto-switching <sup>e</sup>	Yes
Warm-up period (min) <sup>f</sup>	0
Data storage (items)	More than 1000
Battery life (hours) (typical)	72
Warranty and recommended calibration period (years)	3
Model	<b>23BL</b>
Central wavelength (nm)	1310 ± 20 1550 ± 20
Spectral width (nm) <sup>g</sup>	≤5
Output power (dBm)	≥1
Power stability (dB) <sup>h</sup>	
15 min	±0.03
8 h	±0.1
Tone generation	270 Hz, 1 kHz, 2 kHz
Automatic wavelength recognition	Yes
Battery life (hours) (typical in Auto mode)	50
Warranty and recommended calibration period (years)	3

#### NOTES

- a. Guaranteed unless otherwise specified. All specifications valid at 23 °C ± 1 °C, with an FC connector and at 1550 nm for detector.
- b. In CW mode; sensitivity defined as 6 x rms noise level.
- c. For calibration wavelengths. Valid up to 20 dBm for FOT-602X.
- d. For power > -25 dBm for FOT-602X.
- e. At 850 nm, 1300 nm, 1310 nm, 1490 nm, 1550 nm and 1625 nm; for power > -40 dBm (typical) for FOT-602X.
- f. For a variation of ± 0.06 dB at power levels ≥ -25 dBm for FOT-602X.
- g. rms for FP lasers.

- h. After a 15-minute warm-up period, and using an APC connector on the power meter (except for multimode sources, for which a PC connector is used). Expressed as ± half the difference between the maximum and minimum values measured during the period.
- i. Typical values in 62.5/125 μm fiber.



## NOTICE

### 通告

#### CHINESE REGULATION ON RESTRICTION OF HAZARDOUS SUBSTANCES

#### 中国关于有害物质限制的规定

#### NAMES AND CONTENTS OF THE TOXIC OR HAZARDOUS SUBSTANCES OR ELEMENTS CONTAINED IN THIS EXFO PRODUCT

#### 包含在本 EXFO 产品中的有毒有害物质或元素的名称和含量



O	Indicates that this toxic or hazardous substance contained in all of the homogeneous materials for this part is below the limit requirement in SJ/T11363-2006 表示该有毒有害物质在该部件所有均质材料中的含量均在 SJ/T11363-2006 标准规定的限量要求以下。
X	Indicates that this toxic or hazardous substance contained in at least one of the homogeneous materials used for this part is above the limit requirement in SJ/T11363-2006 表示该有毒有害物质至少在该部件的某一均质材料中的含量超出 SJ/T11363-2006 标准规定的限量要求。

Part Name 部件名称	Toxic or hazardous Substances and Elements 有毒有害物质和元素					
	Lead 铅 (Pb)	Mercury 汞 (Hg)	Cadmium 镉 (Cd)	Hexavalent Chromium 六价铬 (Cr VI)	Polybrominated biphenyls 多溴联苯 (PBB)	Polybrominated diphenyl ethers 多溴二苯醚 (PBDE)
Enclosure 外壳	O	O	O	O	O	O
Electronic and electrical sub-assembly 电子和电子组件	X	O	X	O	X	X
Optical sub-assembly <sup>a</sup> 光学组件 <sup>a</sup>	X	O	O	O	O	O
Mechanical sub-assembly <sup>a</sup> 机械组件 <sup>a</sup>	O	O	O	O	O	O

a. If applicable.  
如果适用。

## MARKING REQUIREMENTS

### 标注要求

Product 产品	Environmental protection use period (years) 环境保护使用期限 (年)	Logo 标志
This Exfo product 本 EXFO 产品	10	
Battery <sup>a</sup> 电池 <sup>a</sup>	5	

- a. If applicable.  
如果适用。

P/N: 1064230

[www.EXFO.com](http://www.EXFO.com) · [info@exfo.com](mailto:info@exfo.com)

<b>CORPORATE HEADQUARTERS</b>	400 Godin Avenue	Quebec (Quebec) G1M 2K2 CANADA Tel.: 1 418 683-0211 · Fax: 1 418 683-2170
<b>EXFO AMERICA</b>	3400 Waterview Parkway Suite 100	Richardson, TX 75080 USA Tel.: 1 972-761-927 · Fax: 1 972-761-9067
<b>EXFO EUROPE</b>	Winchester House, School Lane	Chandlers Ford, Hampshire S053 4DG ENGLAND Tel.: +44 2380 246 800 · Fax: +44 2380 246 801
<b>EXFO ASIA-PACIFIC</b>	100 Beach Road, #25-01/03 Shaw Tower	SINGAPORE 189702 Tel.: +65 6333 8241 · Fax: +65 6333 8242
<b>EXFO CHINA</b>	Beijing Global Trade Center, Tower C, Room 1207, 36 North Third Ring Road East, Dongcheng District	Beijing 100013 P. R. CHINA Tel.: +86 (10) 5825 7755 · Fax: +86 (10) 5825 7722
<b>EXFO SERVICE ASSURANCE</b>	270 Billerica Road	Chelmsford MA, 01824 USA Tel.: 1 978 367-5600 · Fax: 1 978 367-5700
<b>EXFO FINLAND</b>	Elektroniikkatie 2	FI-90590 Oulu, FINLAND Tel.: +358 (0) 403 010 300 · Fax: +358 (0) 8 564 5203
<b>TOLL-FREE</b>	(USA and Canada)	1 800 663-3936

© 2013 EXFO Inc. All rights reserved.  
Printed in Canada (2013-03)



**EXFO**  
EXPERTISE REACHING OUT