

FTB-1



Copyright © 2010–2015 EXFO Inc. All rights reserved. No part of this publication may be reproduced, stored in a retrieval system or transmitted in any form, be it electronically, mechanically, or by any other means such as photocopying, recording or otherwise, without the prior written permission of EXFO Inc. (EXFO).

Information provided by EXFO is believed to be accurate and reliable. However, no responsibility is assumed by EXFO for its use nor for any infringements of patents or other rights of third parties that may result from its use. No license is granted by implication or otherwise under any patent rights of EXFO.

EXFO's Commerce And Government Entities (CAGE) code under the North Atlantic Treaty Organization (NATO) is 0L8C3.

The information contained in this publication is subject to change without notice.

Trademarks

EXFO's trademarks have been identified as such. However, the presence or absence of such identification does not affect the legal status of any trademark.

Units of Measurement

Units of measurement in this publication conform to SI standards and practices.

Version number: 19.0.1.1

End-User License Agreement

You have acquired a device ("DEVICE") that includes software licensed by EXFO Inc. (EXFO) from an affiliate of Microsoft Corporation ("MS"). Those installed software products of MS origin, as well as associated media, printed materials, and "online" or electronic documentation ("SOFTWARE") are protected by international intellectual property laws and treaties. Manufacturer, MS and its suppliers (including Microsoft Corporation) own the title, copyright, and other intellectual property rights in the SOFTWARE. The SOFTWARE is licensed, not sold. All rights reserved.

This EULA is valid and grants the end-user rights ONLY if the SOFTWARE is genuine and a genuine Certificate of Authenticity for the SOFTWARE is included. For more information on identifying whether your software is genuine, please see <http://www.microsoft.com/piracy/howtotell>.

IF YOU DO NOT AGREE TO THIS END USER LICENSE AGREEMENT ("EULA"), DO NOT USE THE DEVICE OR COPY THE SOFTWARE. INSTEAD, PROMPTLY CONTACT EXFO FOR INSTRUCTIONS ON RETURN OF THE UNUSED DEVICE(S) FOR A REFUND. **ANY USE OF THE SOFTWARE, INCLUDING BUT NOT LIMITED TO USE ON THE DEVICE, WILL CONSTITUTE YOUR AGREEMENT TO THIS EULA (OR RATIFICATION OF ANY PREVIOUS CONSENT).**

GRANT OF SOFTWARE LICENSE. This EULA grants you the following license:

- You may use the SOFTWARE only on the DEVICE.
- **Restricted Functionality.** You are licensed to use the SOFTWARE to provide only the limited functionality (specific tasks or processes) for which the DEVICE has been designed and marketed by EXFO. This license specifically prohibits any other use of the software programs or functions, or inclusion of additional software programs or functions that do not directly support the limited functionality on the DEVICE. Notwithstanding the foregoing, you may install or enable on a DEVICE, systems utilities, resource management or similar software solely for the purpose of administration, performance enhancement and/or preventive maintenance of the DEVICE.
- If you use the DEVICE to access or utilize the services or functionality of Microsoft Windows Server products (such as Microsoft Windows Server 2003), or use the DEVICE to permit workstation or computing devices to access or utilize the services or functionality of Microsoft Windows Server products, you may be required to obtain a Client Access License for the DEVICE and/or each such workstation or computing device. Please refer to the end user license agreement for your Microsoft Windows Server product for additional information.
- **NOT FAULT TOLERANT.** THE SOFTWARE IS NOT FAULT TOLERANT. EXFO HAS INDEPENDENTLY DETERMINED HOW TO USE THE SOFTWARE IN THE DEVICE, AND MS HAS RELIED UPON EXFO TO CONDUCT SUFFICIENT TESTING TO DETERMINE THAT THE SOFTWARE IS SUITABLE FOR SUCH USE.
- **NO WARRANTIES FOR THE SOFTWARE.** THE SOFTWARE is provided "AS IS" and with all faults. THE ENTIRE RISK AS TO SATISFACTORY QUALITY, PERFORMANCE, ACCURACY, AND EFFORT (INCLUDING LACK OF NEGLIGENCE) IS WITH YOU. ALSO, THERE IS NO WARRANTY AGAINST INTERFERENCE WITH YOUR ENJOYMENT OF THE SOFTWARE OR AGAINST INFRINGEMENT. IF YOU HAVE RECEIVED ANY WARRANTIES REGARDING THE DEVICE OR THE SOFTWARE, THOSE WARRANTIES DO NOT ORIGINATE FROM, AND ARE NOT BINDING ON, MS.
- **No Liability for Certain Damages. EXCEPT AS PROHIBITED BY LAW, MS SHALL HAVE NO LIABILITY FOR ANY INDIRECT, SPECIAL, CONSEQUENTIAL OR INCIDENTAL DAMAGES ARISING FROM OR IN CONNECTION WITH THE USE OR PERFORMANCE OF THE SOFTWARE. THIS LIMITATION SHALL APPLY EVEN IF ANY REMEDY FAILS OF ITS ESSENTIAL PURPOSE. IN NO EVENT SHALL MS BE LIABLE FOR ANY AMOUNT IN EXCESS OF U.S. TWO HUNDRED FIFTY DOLLARS (U.S.\$250.00).**
- **Restricted Uses.** The SOFTWARE is not designed or intended for use or resale in hazardous environments requiring fail-safe performance, such as in the operation of nuclear facilities, aircraft navigation or communication systems, air traffic control, or other devices or systems in which a malfunction of the SOFTWARE would result in foreseeable risk of injury or death to the operator of the device or system, or to others.
- **Limitations on Reverse Engineering, Decompilation, and Disassembly.** You may not reverse engineer, decompile, or disassemble the SOFTWARE, except and only to the extent that such activity is expressly permitted by applicable law notwithstanding this limitation.
- **SOFTWARE as a Component of the DEVICE - Transfer.** This license may not be shared, transferred to or used concurrently on different computers. The SOFTWARE is licensed with the DEVICE as a single integrated product and may only be used with the DEVICE. If the SOFTWARE is not accompanied by a DEVICE, you may not use the SOFTWARE. You may permanently transfer all of your rights under this EULA only as part of a permanent sale or transfer of the DEVICE, provided you retain no copies of the SOFTWARE. If the SOFTWARE is an upgrade, any transfer must also include all prior versions of the SOFTWARE. This transfer must also include the Certificate of Authenticity label. The transfer may not be an indirect transfer, such as a consignment. Prior to the transfer, the end user receiving the SOFTWARE must agree to all the EULA terms.
- **Consent to Use of Data.** You agree that MS, Microsoft Corporation and their affiliates may collect and use technical information gathered in any manner as part of product support services related to the SOFTWARE. MS, Microsoft Corporation and their affiliates may use this information solely to improve their products or to provide customized services or technologies to you. MS, Microsoft Corporation and their affiliates may disclose this information to others, but not in a form that personally identifies you.

-
- **Internet Gaming/Update Features.** If the SOFTWARE provides, and you choose to utilize, the Internet gaming or update features within the SOFTWARE, it is necessary to use certain computer system, hardware, and software information to implement the features. By using these features, you explicitly authorize MS, Microsoft Corporation and/or their designated agent to use this information solely to improve their products or to provide customized services or technologies to you. MS or Microsoft Corporation may disclose this information to others, but not in a form that personally identifies you.
 - **Internet-Based Services Components.** The SOFTWARE may contain components that enable and facilitate the use of certain Internet-based services. You acknowledge and agree that MS, Microsoft Corporation or their affiliates may automatically check the version of the SOFTWARE and/or its components that you are utilizing and may provide upgrades or supplements to the SOFTWARE that may be automatically downloaded to your DEVICE. Microsoft Corporation or their affiliates do not use these features to collect any information that will be used to identify you or contact you. For more information about these features, please see the privacy statement at <http://go.microsoft.com/fwlink/?LinkId=25243>.
 - **Links to Third Party Sites.** You may link to third party sites through the use of the SOFTWARE. The third party sites are not under the control of MS or Microsoft Corporation, and MS or Microsoft are not responsible for the contents of any third party sites, any links contained in third party sites, or any changes or updates to third party sites. MS or Microsoft Corporation is not responsible for webcasting or any other form of transmission received from any third party sites. MS or Microsoft Corporation are providing these links to third party sites to you only as a convenience, and the inclusion of any link does not imply an endorsement by MS or Microsoft Corporation of the third party site.
 - **Notice Regarding Security.** To help protect against breaches of security and malicious software, periodically back up your data and system information, use security features such as firewalls, and install and use security updates.
 - **No Rental/Commercial Hosting.** You may not rent, lease, lend or provide commercial hosting services with the SOFTWARE to others.
 - **Separation of Components.** The SOFTWARE is licensed as a single product. Its component parts may not be separated for use on more than one computer.
 - **Additional Software/Services.** This EULA applies to updates, supplements, add-on components, product support services, or Internet-based services components ("Supplemental Components"), of the SOFTWARE that you may obtain from EXFO, MS, Microsoft Corporation or their subsidiaries after the date you obtain your initial copy of the SOFTWARE, unless you accept updated terms or another agreement governs. If other terms are not provided along with such Supplemental Components and the Supplemental Components are provided to you by MS, Microsoft Corporation or their subsidiaries then you will be licensed by such entity under the same terms and conditions of this EULA, except that (i) MS, Microsoft Corporation or their subsidiaries providing the Supplemental Components will be the licensor with respect to such Supplemental Components in lieu of the "COMPANY" for the purposes of the EULA, and (ii) TO THE MAXIMUM EXTENT PERMITTED BY APPLICABLE LAW, THE SUPPLEMENTAL COMPONENTS AND ANY (IF ANY) SUPPORT SERVICES RELATED TO THE SUPPLEMENTAL COMPONENTS ARE PROVIDED AS IS AND WITH ALL FAULTS. ALL OTHER DISCLAIMERS, LIMITATION OF DAMAGES, AND SPECIAL PROVISIONS PROVIDED BELOW AND/OR OTHERWISE WITH THE SOFTWARE SHALL APPLY TO SUCH SUPPLEMENTAL COMPONENTS. MS, Microsoft Corporation or their subsidiaries reserve the right to discontinue any Internet-based services provided to you or made available to you through the use of the SOFTWARE.
 - **Recovery Media.** If SOFTWARE is provided by EXFO on separate media and labeled "Recovery Media" you may use the Recovery Media solely to restore or reinstall the SOFTWARE originally installed on the DEVICE.
 - **Backup Copy.** You may make one (1) backup copy of the SOFTWARE. You may use this backup copy solely for your archival purposes and to reinstall the SOFTWARE on the DEVICE. Except as expressly provided in this EULA or by local law, you may not otherwise make copies of the SOFTWARE, including the printed materials accompanying the SOFTWARE. You may not loan, rent, lend or otherwise transfer the backup copy to another user.
 - **End User Proof of License.** If you acquired the SOFTWARE on a DEVICE, or on a compact disc or other media, a genuine Microsoft "Proof of License"/Certificate of Authenticity label with a genuine copy of the SOFTWARE identifies a licensed copy of the SOFTWARE. To be valid, the label must be affixed to the DEVICE, or appear on [COMPANY'S] software packaging. If you receive the label separately other than from EXFO, it is invalid. You should keep the label on the DEVICE or packaging to prove that you are licensed to use the SOFTWARE.
 - **Product Support.** Product support for the SOFTWARE is not provided by MS, Microsoft Corporation, or their affiliates or subsidiaries. For product support, please refer to EXFO support number provided in the documentation for the DEVICE. Should you have any questions concerning this EULA, or if you desire to contact EXFO for any other reason, please refer to the address provided in the documentation for the DEVICE.
 - **Termination.** Without prejudice to any other rights, EXFO may terminate this EULA if you fail to comply with the terms and conditions of this EULA. In such event, you must destroy all copies of the SOFTWARE and all of its component parts.
 - **EXPORT RESTRICTIONS.** You acknowledge that SOFTWARE is subject to U.S. and European Union export jurisdiction. You agree to comply with all applicable international and national laws that apply to the SOFTWARE, including the U.S. Export Administration Regulations, as well as end-user, end-use and destination restrictions issued by U.S. and other governments. For additional information see <http://www.microsoft.com/exporting/>.

Contents

Certification Information	viii
1 Introducing the FTB-1	1
Main Features	1
LED Indicators Description	5
Keypad Description	6
Power Sources	8
Optional Software Package	9
Product Registration	10
Conventions	11
2 Safety Information	13
Other Safety Symbols on Your Unit	14
Laser Safety Information	15
Electrical Safety Information	16
3 Getting Started with Your Unit	21
Inserting and Removing Test Modules	21
Using the Supports	25
Securing Your Unit Using a Kensington Lock	26
Using a Keyboard, Mouse or Other USB Devices	27
Using the On-Screen (Virtual) Keyboard	30
Right-Clicking with the Touchscreen	30
Turning On Your Unit	31
Turning Off Your Unit	31
Installing or Upgrading the Applications	35
Installing Third-Party Applications	38
Activating Software Options	40
Starting Module Applications	45

Contents

- 4 Setting Up Your Unit47**
 - Adjusting Brightness47
 - Adjusting Microphone and Speaker Volume48
 - Recalibrating the Touchscreen52
 - Enabling or Disabling the Touchscreen Right-Click Feature55
 - Customizing the On-Screen Keyboard58
 - Enabling or Disabling the Automatic Logon60
 - Selecting the Startup Application63
 - Configuring Network Printers65
 - Selecting the Language of Operation68
 - Setting Date and Time Formats73
 - Adjusting the Date, Time and Time Zone76
 - Configuring the Power Management Options79
 - Configuring the Internet Options83
 - Getting Ready to Retrieve Geolocation Information84
 - Setting Other Parameters88

- 5 Working with Your Unit89**
 - Printing Documents89
 - Viewing PDF Files90
 - Taking Screen Captures91
 - Setting Storage Parameters for Screen Captures94
 - Reading Audio and Video Files98
 - Installing Adobe Flash Player on Your Unit100
 - Browsing the Web102
 - Accessing the Internet with a 3G USB Modem Key104
 - Retrieving the GPS Location of Your Unit108
 - Using the Calculator110
 - Using the Text Editor110
 - Accessing Other Tools110

- 6 Using the Optional Built-In Power Meter and VFL111**

- 7 Inspecting Fibers with a Probe113**

- 8 Managing Data115**
 - Transferring Data via Bluetooth118
 - Connecting to a Wireless Network125
 - Using the USB to RS-232 Adapter130
 - Enabling or Disabling the Bluetooth and Wi-Fi Devices135
 - Connecting to a VPN from Your Unit137

9	Accessing Your Unit Remotely	145
	Working with Remote Desktop	146
	Working With TightVNC	153
	Configuring TightVNC Server to Start Automatically	160
	Adding Exceptions to the Firewall	162
10	Testing Network Connections	165
	Performing a Ping Test	165
	Performing a Trace Route Test	168
	Exporting the Results	170
11	Maintenance	171
	Cleaning Detector Ports	172
	Cleaning the Touchscreen of Your FTB-1 Unit	173
	Recharging the Main Battery	173
	Recalibrating the Battery	175
	Replacing Batteries	178
	Recycling and Disposal (Applies to European Union Only)	182
12	Troubleshooting	183
	Solving Common Problems	183
	Restoring Your Unit to Normal Operation	190
	Contacting the Technical Support Group	199
	Transportation	199
13	Warranty	201
	General Information	201
	Liability	202
	Exclusions	202
	Certification	202
	Service and Repairs	203
	EXFO Service Centers Worldwide	204
A	Technical Specifications	205
	Index	207

Certification Information

North America Regulatory Statement

This unit was certified by an agency approved in both Canada and the United States of America. It has been evaluated according to applicable North American approved standards for product safety for use in Canada and the United States.

Electronic test and measurement equipment is exempt from FCC part 15, subpart B compliance in the United States of America and from ICES-003 compliance in Canada. However, EXFO Inc. makes reasonable efforts to ensure compliance to the applicable standards.

The limits set by these standards are designed to provide reasonable protection against harmful interference when the equipment is operated in a commercial environment. This equipment generates, uses, and can radiate radio frequency energy and, if not installed and used in accordance with the user guide, may cause harmful interference to radio communications. Operation of this equipment in a residential area is likely to cause harmful interference in which case the user will be required to correct the interference at his own expense.

Modifications not expressly approved by the manufacturer could void the user's authority to operate the equipment.

If you purchased the Wi-Fi and Bluetooth options, your unit comes with an internal wireless module and antenna for which the following information applies:

- This equipment has been tested and found to comply with the limits for a Class A digital device, pursuant to Part 15 of the FCC Rules. Operation is subject to the following two conditions: (1) This device may not cause harmful interference, and (2) this device must accept any interference received, including interference that may cause undesired operation.
- This device complies with Industry Canada license-exempt RSS standard(s). Operation is subject to the following two conditions: (1) this device may not cause interference, and (2) this device must accept any interference, including interference that may cause undesired operation of the device.
- This device complies with the US/Canada portable RF exposure limit set forth for an uncontrolled environment and is safe for intended operation as described in this user documentation. The further RF exposure reduction can be achieved if the device can be kept as far as possible from the user's body.
- This device does not contain any user-serviceable components. Any unauthorized product changes or modifications will invalidate warranty and all applicable regulatory certifications and approvals.

Certification Information

CSA Information

This unit is certified by the CSA (certificate number 162451) and was evaluated according to applicable CSA standards (as confirmed by cCSAus mark) as well as applicable IEC standards for use in Canada, the United States, and other countries.

European Community Declaration of Conformity

Warning: This is a class A product. In a domestic environment, this product may cause radio interference in which case the user may be required to take adequate measures.

An electronic version of the declaration of conformity for your product is available on our website at www.exfo.com. Refer to the product's page on the Web site for details.

1 Introducing the FTB-1

The FTB-1 platform is a modular platform, optimized for network infrastructure construction and troubleshooting via its dedicated FTTH and Ethernet test applications.

Note: *In this documentation, the words “tap” and “double-tap” (related to the use of a touchscreen) replace the words “click” and “double-click”.*

Main Features

Your FTB-1 platform includes the following:

- Multitasking possibilities
- Seven-inch color touchscreen (LCD and touchscreen optimized for outdoor use available as an option)
- Optional built-in power meter and VFL
- Optional internal Wi-Fi and Bluetooth devices
- Two USB 2.0 ports (host)
- Ethernet port (10/100/1000 Base-T)
- Headset/microphone port (for any commercially available headset equipped with a microphone, and having a 2.5 mm connector)
- Optional 3G USB modem key
- Windows Embedded Standard operating system
- VPN capability
- Remote access to your unit (via TightVNC or Remote Desktop)
- Direct Web access from your unit
- Possibility to take screen captures
- PDF file generator and viewer available from your unit
- Easy transfer of files and folders to a USB storage device
- Easy updates for applications via Update Manager

Introducing the FTB-1

Main Features

Front

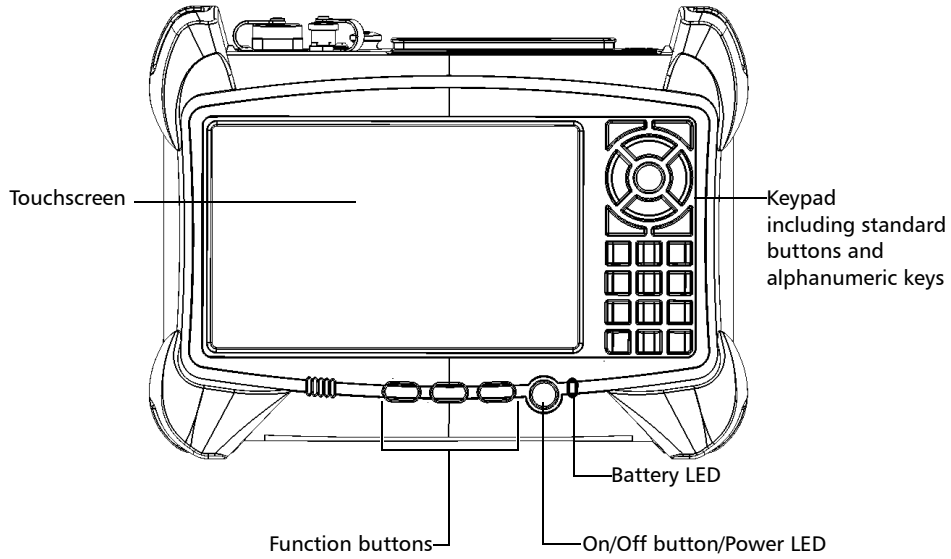

Top

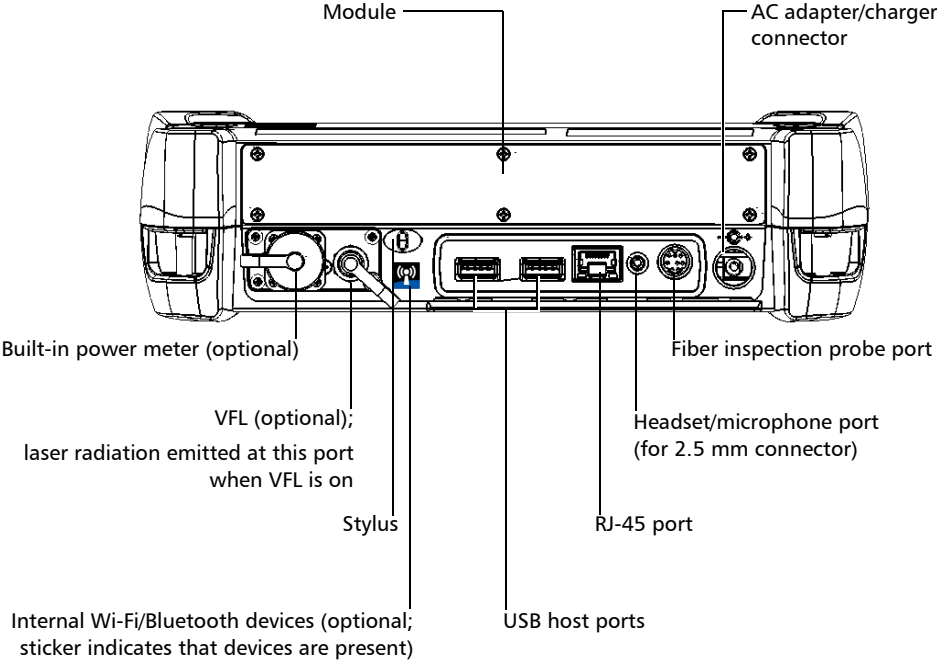

Introducing the FTB-1

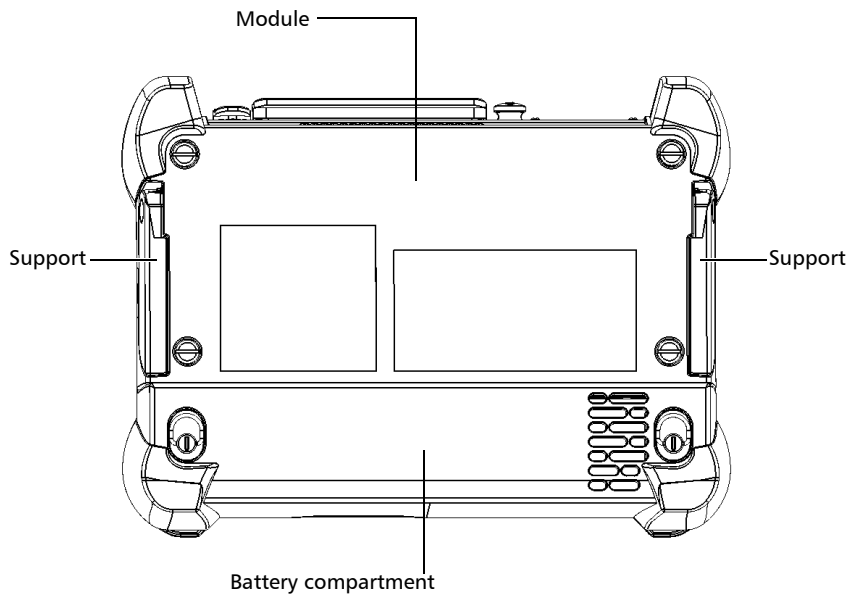

Main Features

Back



LED Indicators Description

There are two LED indicators located on the front panel of your unit, providing you with information about the power and battery statuses.

LED	Status	Meaning
	Green	Unit is on.
	Green, blinking	Unit is in Standby mode.
	Off	Unit is off or in Hibernation mode.
	Green	Battery is fully charged.
	Green, blinking	Battery is charging.
	Yellow, blinking	Unit is not powered by AC and battery is low.
	Red	No battery in the unit or battery error.
	Off	Unit is off or unit is not powered by AC and battery level is above the “low-battery threshold”.

Introducing the FTB-1

Keypad Description





Keypad Description





In addition to the on-screen keyboard, your unit is equipped with a keypad which gives you access to various tools at all times.

The keypad comprises arrow keys for navigation (left, right, up, down), alphanumeric keys (similar to phone keys to enter both numbers and text), and other hardware buttons.

Note: *Not all applications support text entry with the alphanumeric keys.*

The table below shows an overview of their purpose.

Button	Meaning
	Adjusts screen brightness (5 levels).
	<ul style="list-style-type: none">▶ Displays the on-screen keyboard▶ Takes a screen capture (button held down for a few seconds)
	Enables you to switch from one task to another.
	Turns your unit on and off. For more information on the various ways to turn off your unit, see <i>Turning Off Your Unit</i> on page 31.
	Starts/stops a test.

Button	Meaning
	Moves to the next group of features.
	Confirms last entry; equivalent of the ENTER button.
	Deletes the item/character.
	Exits or cancels last entry.

Power Sources

Your unit operates with the following power sources:

- AC adapter/charger (connected to standard power outlet—indoor use only). Compatible car outlet adapter available upon request.
- One lithium-ion rechargeable battery (automatically takes over if you disconnect the AC adapter/charger).

Note: *When it is connected with the AC adapter/charger, the unit will function even if the battery is not present.*

- Possible to switch from AC adapter/charger to battery power or vice versa without affecting operation.
- The battery recharges automatically when the AC adapter/charger is connected.
- The battery is offered in two formats: four-cell (small) and eight-cell (large).
- Rechargeable battery (for clock). This battery can keep the date and time for weeks even if AC power and the lithium-ion battery (main battery) are not connected.

Optional Software Package

The following software options are offered for the platform itself.

Name of the Option	Description
IPT	Enables you to perform <i>ping</i> and <i>trace route</i> tests.
SMARTGPS	Enables you to retrieve geolocation information (latitude and longitude coordinates) from a smart device on which the EXFO Link application is running. This geolocation information can then be saved along with test results to identify the position of your unit, or viewed in the GPS Coordinate Viewer (see <i>Retrieving the GPS Location of Your Unit</i> on page 108).

For more information on how to activate software options for your unit, see *Activating Software Options* on page 40.

For more information on the software options available for modules, test instruments, or dedicated applications, refer to the user documentation that comes with these products.

Product Registration

You can now register your new EXFO products either online or directly from your unit (if it is connected to the Internet), and benefit from every possible opportunity to optimize their performance. By doing so, you will always be notified of the latest software updates, key product enhancements and up-to-date support information related to your products.

To register your product directly from your unit:

1. Ensure that your unit can access the Internet.
2. From Mini ToolBox, tap **Utilities**, and then **Product Registration**.
3. Follow the on-screen instructions.

To register your product online:

1. Open a Web browser and go to www.exfo.com.
2. Log in to your EXFO account.
3. Tap **Support**.
4. Under **Tools**, tap **Manage My Products**.
5. Tap **Register**.
6. Follow the on-screen instructions.

Conventions

Before using the product described in this guide, you should understand the following conventions:



WARNING

Indicates a potentially hazardous situation which, if not avoided, could result in *death or serious injury*. Do not proceed unless you understand and meet the required conditions.



CAUTION

Indicates a potentially hazardous situation which, if not avoided, may result in *minor or moderate injury*. Do not proceed unless you understand and meet the required conditions.



CAUTION

Indicates a potentially hazardous situation which, if not avoided, may result in *component damage*. Do not proceed unless you understand and meet the required conditions.



IMPORTANT

Refers to information about this product you should not overlook.

2 **Safety Information**



WARNING

Do not install or terminate fibers while a light source is active. Never look directly into a live fiber and ensure that your eyes are protected at all times.



WARNING

The use of controls, adjustments and procedures, namely for operation and maintenance, other than those specified herein may result in hazardous radiation exposure or impair the protection provided by this unit.



IMPORTANT

When you see the following symbol on your unit , make sure that you refer to the instructions provided in your user documentation. Ensure that you understand and meet the required conditions before using your product.



IMPORTANT











Other safety instructions relevant for your product are located throughout this documentation, depending on the action to perform. Make sure to read them carefully when they apply to your situation.

Safety Information

Other Safety Symbols on Your Unit

Other Safety Symbols on Your Unit

One or more of the following symbols may also appear on your unit.

Symbol	Meaning
	Direct current
	Alternating current
	The unit is equipped with an earth (ground) terminal.
	The unit is equipped with a protective conductor terminal.
	The unit is equipped with a frame or chassis terminal.
	On (Power)
	Off (Power)
 OR 	On/Off (Power)
	Fuse

Laser Safety Information

Units with a Built-In VFL

Your instrument is a Class 3R laser product in compliance with standards IEC 60825-1: 2007 and 21 CFR 1040.10, except for deviations pursuant to Laser Notice No. 50, dated June 24, 2007. Laser radiation is emitted at the output port. It is potentially harmful in direct intrabeam viewing.

The following label(s) indicate that the product contains a Class 3R source:



Affixed to bottom panel of unit.

The VFL laser is active when the  symbol is displayed in the power meter and VFL application.

Units without a Built-In VFL

If your unit is not equipped with a VFL, the laser class of your unit depends on the modules that you use. Refer to the user guide or the online help of the different modules for the exact information.

Electrical Safety Information

If you need to ensure that the unit is completely turned off, disconnect the power cable and remove the battery. For more information on how to remove the battery, see the section about replacing the battery in this user documentation.



WARNING

- Never connect the unit to the AC mains (with the adapter/charger) when it is used outdoors.
- Position the unit so that the air can circulate freely around it.
- Operation of any electrical instrument around flammable gases or fumes constitutes a major safety hazard.
- To avoid electrical shock, do not operate the unit if any part of the outer surface (covers, panels, etc.) is damaged.
- Only authorized personnel should carry out adjustments, maintenance or repair of opened units under voltage. A person qualified in first aid must also be present. Do not replace any components while the power cable and battery are connected.
- Unless otherwise specified, all interfaces are intended for connection to Safety Extra Low Voltage (SELV) circuits only.
- Capacitors inside the unit may be charged even if the unit has been disconnected from its electrical supply.



WARNING

- Use only the listed and certified AC adapter/charger provided by EXFO with your unit. It provides reinforced insulation between primary and secondary, and is suitably rated for the country where the unit is sold.
- Use only accessories (such as the car outlet adapter, batteries, and fiber inspection probe) designed for your unit and approved by EXFO. For a complete list of accessories available for your unit, refer to its technical specifications.
- When you use the unit outdoors, ensure that it is protected from liquids, dust, direct sunlight, precipitation, and full wind pressure.

Safety Information

Electrical Safety Information

Equipment Ratings	
Temperature	
<ul style="list-style-type: none"> ➤ Operation 	<ul style="list-style-type: none"> ➤ unit powered by battery: 0 °C to 50 °C (32 °F to 122 °F) ➤ unit connected to AC adapter: 5 °C to 40 °C (41 °F to 104 °F)
<ul style="list-style-type: none"> ➤ Storage 	<ul style="list-style-type: none"> ➤ unit without battery: -40 °C to 70 °C (-40 °F to 158 °F) ➤ unit with battery: -20 °C to 60 °C (-4 °F to 140 °F) ➤ AC adapter: -20 °C to 60 °C (-4 °F to 140 °F)
Relative humidity ^a	<ul style="list-style-type: none"> ➤ unit: ≤ 95 % non-condensing ➤ AC adapter: 10 % to 80 % non-condensing
Maximum operation altitude	<ul style="list-style-type: none"> ➤ 2000 m (6562 ft) (unit connected to external power supply) ➤ 5000 m (16405 ft) (unit operated from battery)
Pollution degree	<ul style="list-style-type: none"> ➤ 2 (unit connected to external power supply) ➤ 3 (unit operated from battery)^b
Overtoltage category	<ul style="list-style-type: none"> ➤ unit: I ➤ AC adapter: II
Measurement category	Not rated for measurement categories II, III, or IV
Input power ^c	<ul style="list-style-type: none"> ➤ unit: --- 24 V; 3.75 A ➤ AC adapter: ~ 100 - 240 V; 50/60 Hz; 1.6 A

- a. Measured in 0 °C to 31 °C (32 °F to 87.8 °F) range, decreasing linearly to 50 % at 40 °C (104 °F).
- b. Equipment must be normally protected against exposure to direct sunlight, precipitation and full wind pressure.
- c. Not exceeding ± 10 % of the nominal voltage.



CAUTION

The use of voltages higher than those indicated on the label affixed to your unit may damage the unit.



CAUTION

The operation and storage temperatures, as well as the altitude and relative humidity values of some modules may differ from those specified for your platform. In this case, always ensure that you comply with the most restrictive conditions (either module or platform).

3 Getting Started with Your Unit

Inserting and Removing Test Modules



CAUTION

Never insert or remove a module while the FTB-1 is turned on. This will result in immediate and irreparable damage to both the module and unit.



CAUTION

To avoid damaging your unit, use it only with modules approved by EXFO.

To insert a module into the FTB-1:

1. Turn off your unit (Shutdown).
2. Position the unit so that its front panel rests on a flat surface such as a table.
3. Place the module on the platform making sure that the bumpers and the shorter sides of the module are flush with those of the platform. If necessary, slightly move the module until alignment is correct.

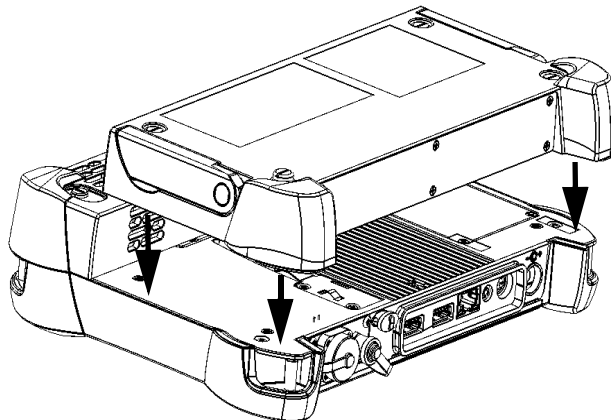

Getting Started with Your Unit

Inserting and Removing Test Modules

4. Using a flat screwdriver, turn the screws (4) clockwise until they are tightened.

This will secure the module into its “seated” position.

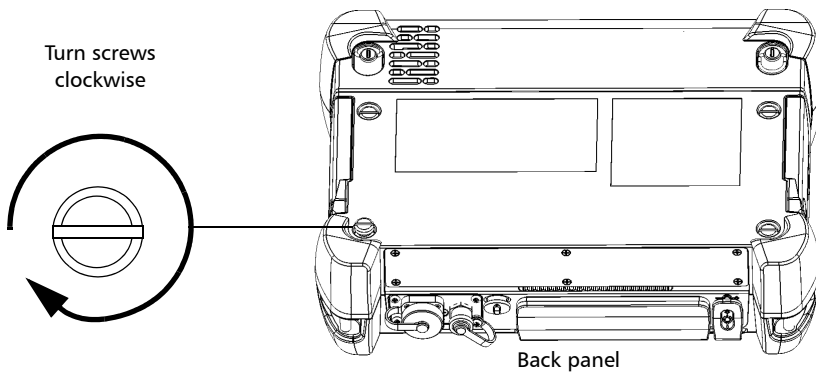

When you turn on the unit, the startup sequence will automatically detect the module.

Getting Started with Your Unit

Inserting and Removing Test Modules

To remove a module from the FTB-1:

- 1. Turn off your unit (Shutdown).
- 2. Position the unit so that its front panel rests on a flat surface such as a table.
- 3. Using a flat screwdriver, turn the screws (4) counterclockwise until they are loose. Since they are captive screws, you cannot remove them completely.

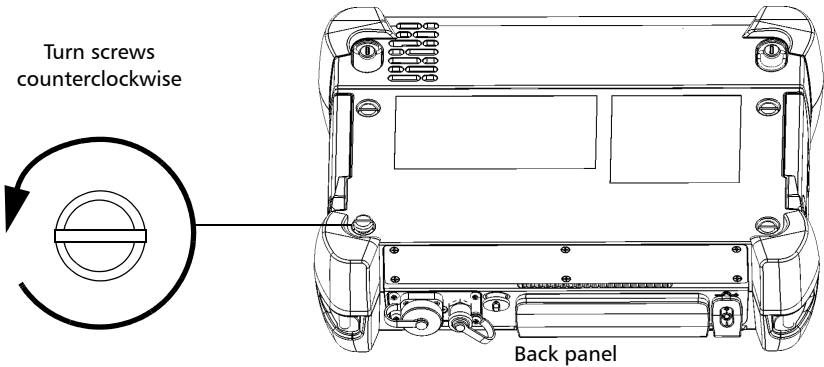

Getting Started with Your Unit

Inserting and Removing Test Modules

4. Hold the module by its sides (*NOT by the connectors*) and pull it up.

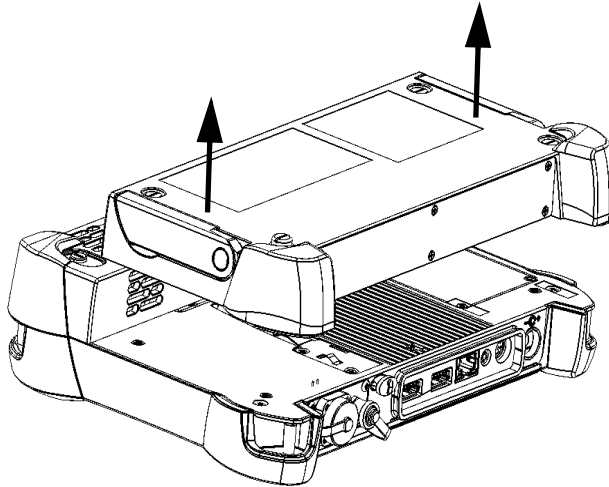

CAUTION

Pulling a module by its connectors could seriously damage both the module and connectors. Always pull a module by its casing.

Using the Supports

Your unit has been designed to stand either vertically (with the screen facing you), or at an angle, using the two supports.

All the modules that you can use with your unit are equipped with two supports with which you can change the orientation of your unit. Once the module is inserted in your FTB-1, you can use the supports.

Note: *The supports ensure optimum stability to the unit during your tests.*

To change the orientation of the unit using the supports:

Pull out the two supports.

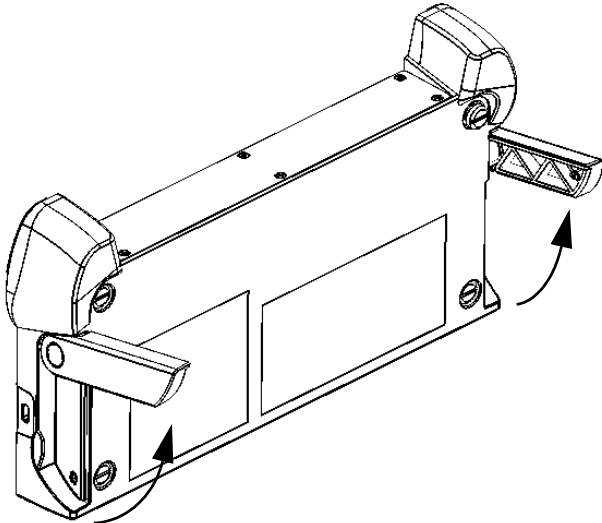

Getting Started with Your Unit

Securing Your Unit Using a Kensington Lock

Securing Your Unit Using a Kensington Lock

All the modules that you can use with your unit are equipped with a security slot to which you can connect an optional Kensington lock (security cable). Once the module is inserted in your FTB-1, you can secure your unit with this lock to help prevent theft.

To secure your unit:

Connect your lock to the security slot located on the side of your module.

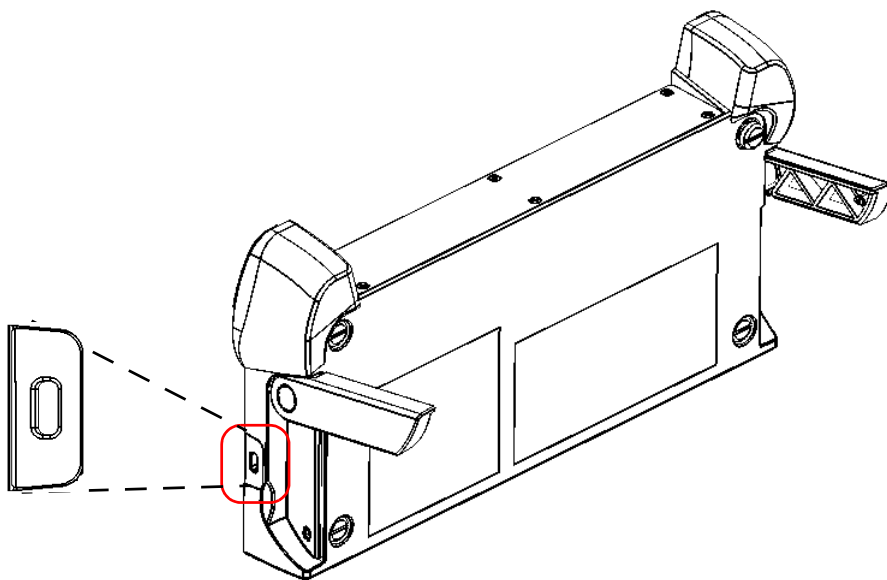

Using a Keyboard, Mouse or Other USB Devices

Your unit supports many USB devices. The table below lists the supported USB devices.

Device	Details
Memory key	For data transfer between your unit and a computer when you do not have access to a network. If you need information on how to transfer data using a memory key, see <i>Managing Data</i> on page 115.
Keyboard	When you are required to enter alphanumeric data, an on-screen (virtual) keyboard is displayed. However, if you prefer, you can use a hardware keyboard. Note: <i>Even if a keyboard is connected, the on-screen keyboard will still be displayed when you work in Mini Toolbox.</i>
Mouse	If you prefer to use a mouse instead of the touchscreen, you can connect one.
Composite device	You can use composite devices, that is devices that input information to your unit using more than one mean (for example, combinations of keyboard and mouse).
Hub	This device will be particularly useful to you if you need extra USB ports.

Getting Started with Your Unit

Using a Keyboard, Mouse or Other USB Devices

Device	Details
USB to RS-232 adapter (purchased from EXFO)	To be able to transfer data between your unit and a device only equipped with RS-232 (serial) ports. For more information, see <i>Using the USB to RS-232 Adapter</i> on page 130.
3G USB modem key (purchased from EXFO)	To access the Internet without having to connect to a Wi-Fi or an Ethernet network. For more information, see <i>Accessing the Internet with a 3G USB Modem Key</i> on page 104.

You can connect several devices at the same time.



IMPORTANT

Your unit does not support USB printers. If you want to print documents, you must use the provided PDF creation tool or a network printer (see *Printing Documents* on page 89), or transfer your files to a computer (see *Managing Data* on page 115) that has access to a network printer.

Getting Started with Your Unit

Using a Keyboard, Mouse or Other USB Devices

To use a USB device with your unit:

Connect the USB device to any of the USB ports (located on top of the unit).

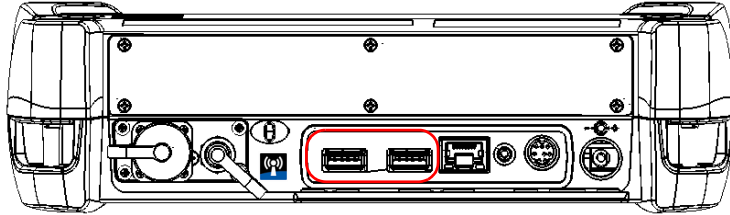

Note: *It is not necessary to turn off the unit before connecting the USB device. The software will automatically detect its presence.*

Your device is automatically recognized and immediately usable (provided that it uses the drivers already available on your unit).

Using the On-Screen (Virtual) Keyboard

Your unit is equipped with an on-screen keyboard that supports multilingual features. This keyboard functions according to the keyboard settings of Windows.

To use the on-screen keyboard:

1. From the unit's keypad, press the  button.
2. Select the location where you want to enter text.
3. Enter the data as required.
4. Exit the location when you have finished entering data.

Right-Clicking with the Touchscreen

If you are used to work with a mouse, you may find it useful to be able to perform a right-click on your touchscreen.

To right-click with the touchscreen:

From the location where you want to right-click, using the stylus or any blunt pointing device, press the screen for a few seconds until the shortcut menu appears.

If you want to hide the shortcut menu without performing any action, simply tap anywhere outside the menu.

Turning On Your Unit

To turn on the unit:

Press the On/Off button.

Turning Off Your Unit

There are several ways to turn off the unit, including the following:

- *Standby*: keeps the unit's status information in memory (RAM). The next time you turn your unit on, you will quickly return to your work environment (running applications will still be running). This mode will take more battery power while the unit is off.
- *Hibernation*: saves the unit's status information that was in memory (RAM) to a special file on the disk. The next time you turn your unit on, this file will be used to ensure that you return to your work environment (running applications will still be running). The unit will take longer to start up than in *Standby* mode, but it requires less battery power when the unit is off. You can configure your unit to switch automatically from *Standby* to *Hibernation* mode after the specified delay.
- *Shutdown*: completely cuts power to the test modules and platform; the unit will perform a complete restart routine the next time you use it. You should perform a shutdown if you do not intend to use your unit for a week or more.

After a shutdown, the unit will start in Mini Toolbox or in the application you defined as the startup application.

Note: *Should the unit ever stop responding, you can force a hardware reset by pressing and holding down the power button for more than 10 seconds.*

Getting Started with Your Unit

Turning Off Your Unit

By default, your unit will display the standard shutdown window from which you can select the desired shutdown mode. However, you can configure your unit to perform a different action when the power button is pressed.

You can also configure your unit to automatically restart when AC power comes back after the unit has turned off (power outage, emergency shutdown, standby, or hibernation modes) when battery level is too low.

To turn off the unit:

1. Press the On/Off button.

OR

On the Windows taskbar, tap **Start**.

This will display the standard shutdown window, from which you have a choice of actions or shutdown modes.

2. Select **Shutdown**.

To define the behavior of the power button:

1. From the **Main Menu**, tap **Setup**.
2. Double-tap **Power Options**.

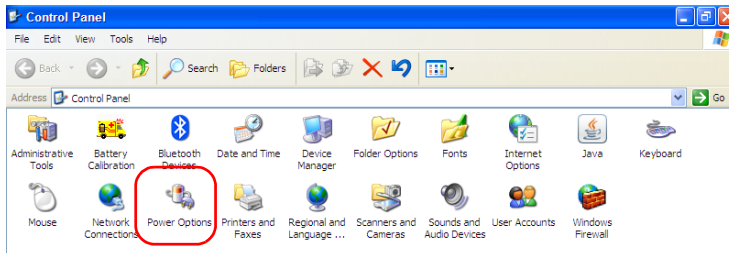

- 3. Select the **Advanced** tab.

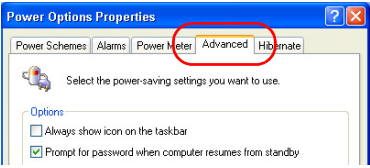

- 4. From the **When I press the power button on my computer** list, select the desired behavior (**Ask me what to do** option is selected by default).

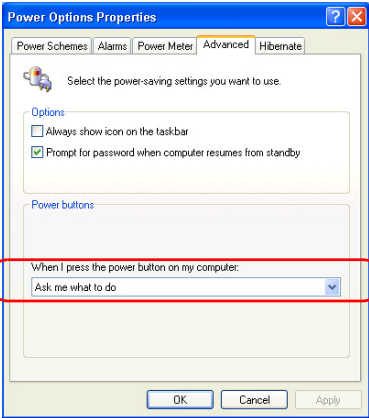

- 5. Tap **Apply** to confirm the changes, and then **OK** to return to **Control Panel**.

Getting Started with Your Unit

Turning Off Your Unit

To configure your unit to automatically restart after AC power comes back:

1. From the **Main Menu**, tap **System Settings**.
2. From the **System Settings** window, tap **Startup Applications**.

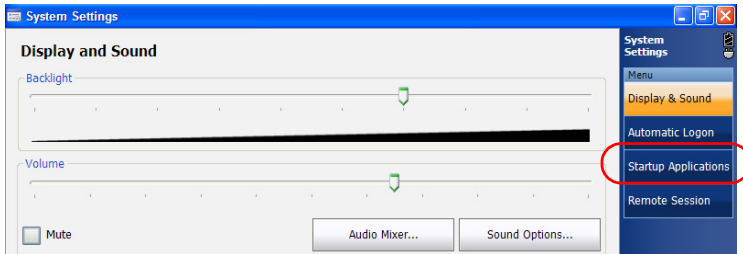

3. Select the **Power on the unit when AC outlet is connected or after power outage** box to enable the corresponding option.

OR

Clear the box if you prefer that your unit does not restart automatically after AC power comes back.

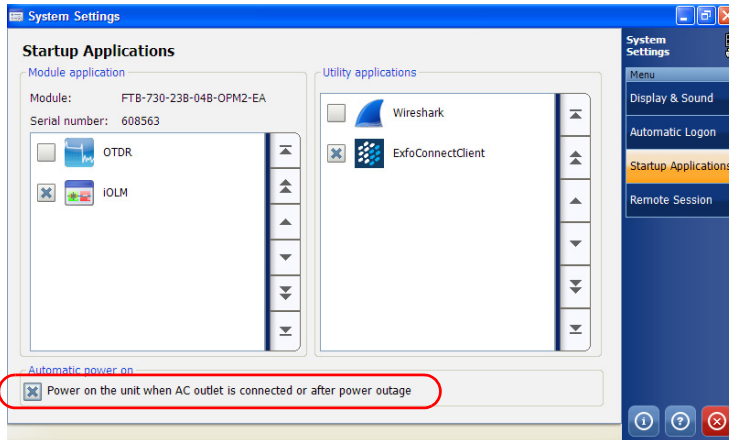

4. Tap  to confirm the changes and return to the main window.

Installing or Upgrading the Applications

All the necessary applications have been preinstalled and configured at the factory. However, you may have to upgrade some applications when new versions become available or to reinstall them.

Note: *Only administrator-level users can install software under Windows.*

Each time you purchase a new module, it could be a good idea to verify that the most recent Update Manager application is installed on your unit.

When updates are available for an application, you will need to download them from Internet, either directly on your unit or on a computer. The update files must be copied to the location that has been specified for the deployment packages in Update Manager.

For the installation or upgrade, you will need:

- your unit
- a computer equipped with a USB port; Windows must be installed on the computer
- a USB memory key

Note: *The computer and USB key are only necessary if you do not wish to download the files directly on your unit.*

Note: *For more information on the installation, refer to the Update Manager online help.*

Getting Started with Your Unit

Installing or Upgrading the Applications

To update or reinstall Update Manager:

- 1.** If necessary, retrieve the desired installation files from the Internet.

If you do not intend to download files directly on your unit, connect a USB memory key to one of the USB ports of the computer and copy the installation files to this USB key.
- 2.** If it is not already done, turn on your unit.
- 3.** Exit Mini Toolbox and the module's applications.
- 4.** If you want to install Update Manager using the USB key, disconnect it from the computer and connect it to one of the USB ports of your unit.
- 5.** On your unit, create a folder on the Windows desktop.
- 6.** Copy the installation files (from the USB key) to the newly created folder.
- 7.** From the newly created folder, double-tap the Update Manager setup file to start the installation.
- 8.** Follow the on-screen instructions.
- 9.** When the installation is complete, simply disconnect the USB memory key.

To install or upgrade the applications:

- 1.** If necessary, retrieve the desired installation files from the Internet.

If you do not intend to download files directly on your unit, connect a USB memory key to one of the USB ports of the computer and copy the installation files to this USB key.
- 2.** If it is not already done, turn on your unit.
- 3.** Exit Mini Toolbox and the modules' applications.
- 4.** If you want to install or update applications using the USB key, disconnect it from the computer and connect it to one of the USB ports of your unit.
- 5.** Copy the installation files (from the USB key) to the folder containing the update and installation packages on your unit. By default, Update Manager will search for files at the root of the USB key. For more information, refer to the Update Manager online help.
- 6.** On your unit, from Windows desktop, double-tap the **Update Manager** icon to start the corresponding application. For more information on how to install or upgrade applications, refer to the Update Manager online help.
- 7.** When the installation is complete, simply disconnect the USB memory key.

Installing Third-Party Applications

Note: Only administrator-level users can install software under Windows Embedded Standard.

By default, your unit is locked to prevent the installation of unwanted applications and components. However, in some cases, you may need to install third-party applications such as those allowing you to connect to the 3G/4G network of your Internet services provider.

The Write Filter Manager enables you to unlock your unit to let you install third-party applications. The lock status of your unit (locked or unlocked) is displayed in the main window of the Write Filter Manager.

Note: If you intend to work with the standard Sierra Wireless 319U USB key, you do not need to use the Write Filter Manager. For more information on the configuration and use of this USB key, see *Accessing the Internet with a 3G USB Modem Key* on page 104.



CAUTION

- Installing applications that have not been previously approved by EXFO may prevent your unit from working properly.
- To preserve the integrity and stability of your unit, do not forget to lock it once the installation of the third-party application is complete.



CAUTION

DO NOT CONNECT any new 3G USB modem key to the unit before the unit has been unlocked with the Write Filter Manager.

To install third-party applications on your unit:

- 1.** Unlock your unit:
 - 1a.** On the Windows taskbar, tap **Start**, then select **All Programs > EXFO > Write Filter Manager > Write Filter Manager** to start the application.
 - 1b.** Tap the **Unlock** button. The button label switches to “Lock”.
 - 1c.** When the application prompts you to restart the unit, select **Yes**.
Wait for the startup sequence to complete.
- 2.** Install your third-party application by following the instructions provided with it.
- 3.** Lock your unit:
 - 3a.** On the Windows taskbar, tap **Start**, then select **All Programs > EXFO > Write Filter Manager > Write Filter Manager** to start the application.
 - 3b.** Tap the **Lock** button. The button label switches to “Unlock”.
 - 3c.** When the application prompts you to restart the unit, select **Yes**.
Wait for the startup sequence to complete.

You are now ready to work with your third-party application.

Activating Software Options

The software options purchased at the same time as your unit have been activated for you already. However, if you purchase options afterwards, you will have to activate them yourself.

Before being able to activate options, you need to contact EXFO with the following information:

- Purchase order number of the newly purchased options
- Module or platform serial number (depending on whether the software options were purchased for a module or the platform)
- Customer's name
- Customer's company name
- Customer's phone number
- Customer's e-mail address
- Module or platform on which the option will be installed

You will receive a single key (.key) file with which you will be able to unlock all the new options that you have purchased.

To activate the options for your unit:

1. Connect a USB memory key to one of the USB ports of your computer.
2. Copy the key file to the USB memory key.
3. Disconnect the USB key from the computer and connect it to your unit.
4. From Mini ToolBox, select the **Utilities** tab, then tap **Options Activation**.

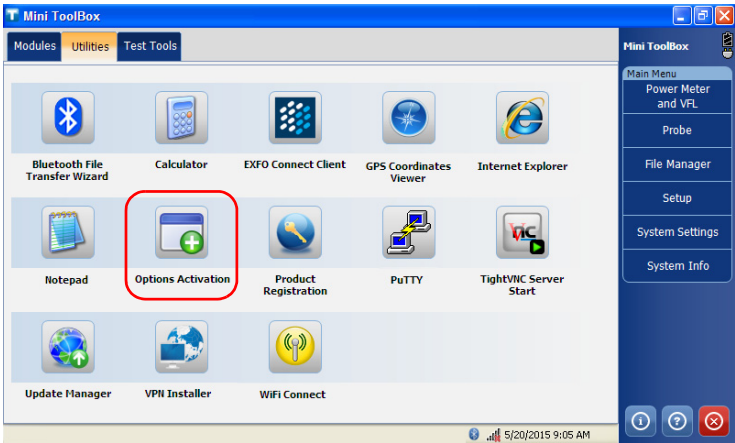

Getting Started with Your Unit

Activating Software Options

5. In the **Platform Options** tab, use the **Browse** button to locate the key file that you want to use.

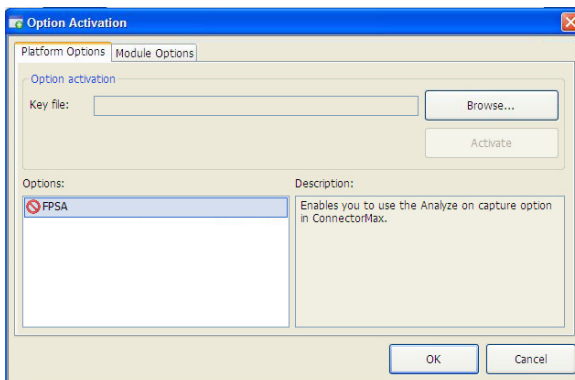

6. Tap **Activate**.

The option indicator will turn into a green check mark to confirm that the option is now active.

7. Tap **OK** to close the confirmation message, and then **Close** to exit.

Note: *At this point, if you have used a USB key to copy your key file, you can remove it as it is not required to use your new options.*

To activate software options for your module:

1. Connect a USB memory key to one of the USB ports of your computer.
2. Copy the key file to the USB memory key.
3. Disconnect the USB key from the computer and connect it to your unit.
4. From Mini ToolBox, select the **Utilities** tab, then tap **Options Activation**.

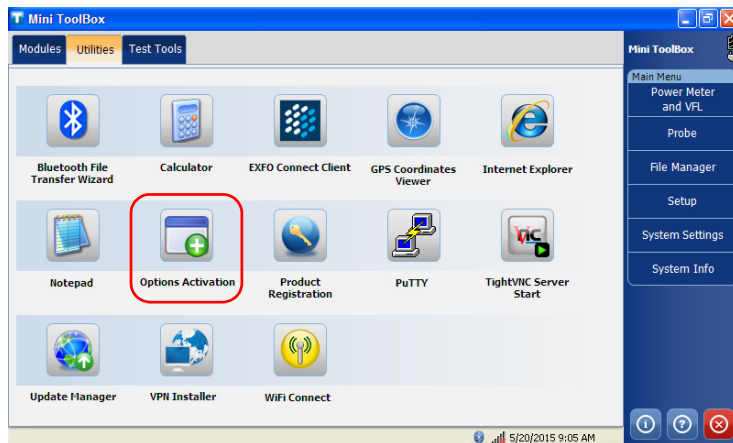

Getting Started with Your Unit

Activating Software Options

5. In the **Module Options** tab, use the **Browse** button to locate the key file that you want to use.

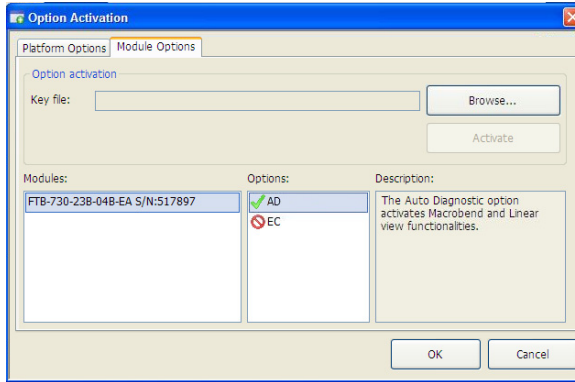

6. Tap **Activate**.

The option indicator will turn into a green check mark to confirm that the option is now active.

Note: You can see the supported options for the module in the **Options** list.

7. Tap **OK** to close the confirmation message, and then **Close** to exit.

Note: At this point, if you have used a USB key to copy your key file, you can remove it as it is not required to use your new options.

Starting Module Applications

Your modules can be configured and controlled from their dedicated applications in Mini Toolbox.

To start a module application:

From Mini Toolbox, at the bottom of the window, press the button corresponding to the desired application.

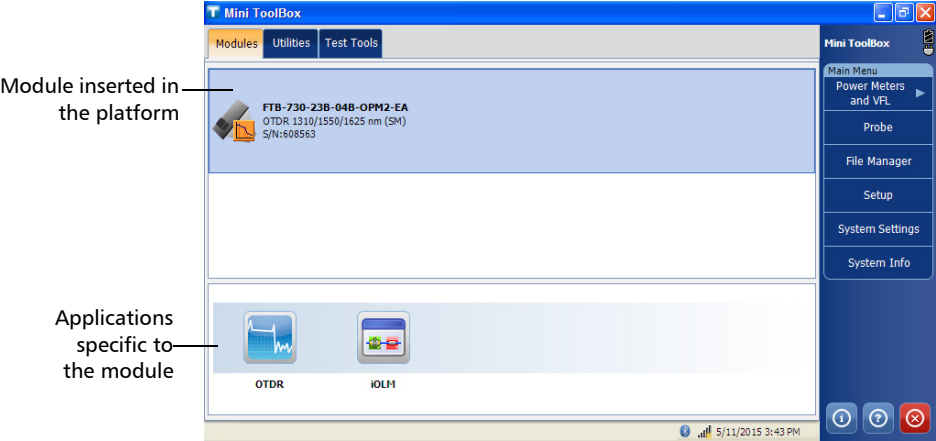

To start the Power Meter or Probe application:

From Main Menu, press Power Meter or Probe.

4 Setting Up Your Unit

Adjusting Brightness

To fit your work environment, you may adjust the LCD brightness. Values are kept in memory even when you turn the unit off.

Note: These settings do not apply to a fiber inspection probe display.

To adjust the display brightness:

Press the  key repeatedly to switch between brightness levels.

OR

1. From the **Main Menu**, tap **System Settings**.
2. If necessary, from **System Settings**, tap **Display & Sound**.

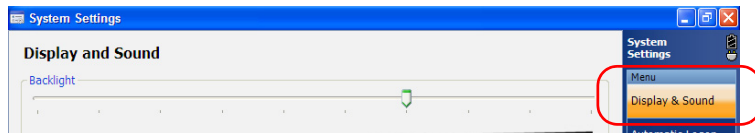

3. Move the slider until the screen appearance is to your liking.

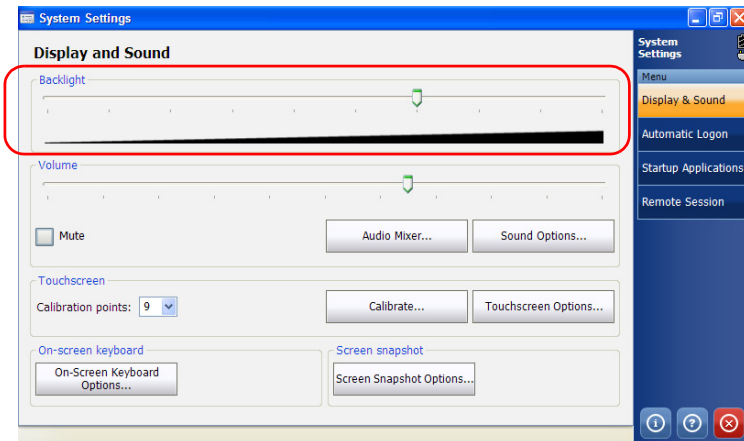

4. Tap  to return to the Mini Toolbox window.

Setting Up Your Unit

Adjusting Microphone and Speaker Volume

Adjusting Microphone and Speaker Volume

To fit your work environment, you may adjust the microphone and speaker volume. Values are kept in memory even when you turn the unit off.

To adjust the microphone volume:

1. From the **Main Menu**, tap **System Settings**.
2. If necessary, from **System Settings**, tap **Display & Sound**.

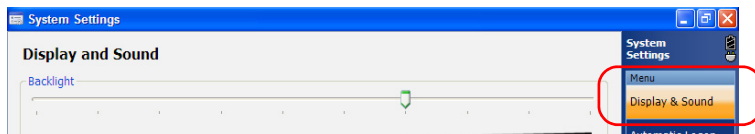

3. Under **Volume**, tap the **Sound Options** button.

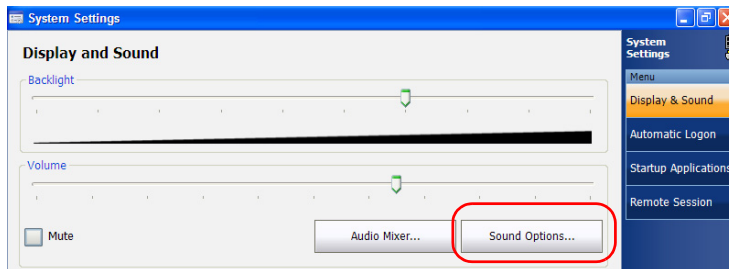

4. Select the **Voice** tab.

5. Under **Voice recording**, tap **Volume**.

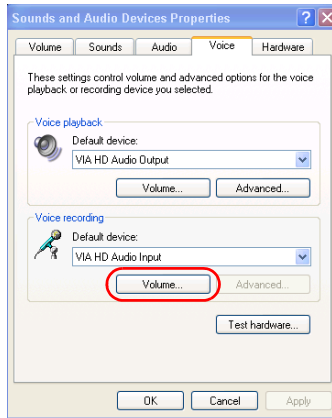

6. Ensure that the microphone boost option is selected:
 - 6a. From the **Options** menu, select **Advanced Controls**.

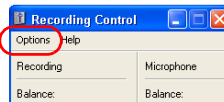

- 6b. Tap the **Advanced** button.

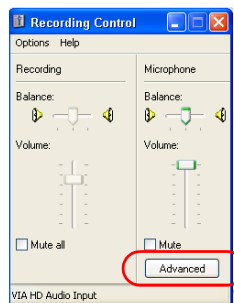

Setting Up Your Unit

Adjusting Microphone and Speaker Volume

- Under **Other Controls**, select the **1 Microphone Boost** check box.

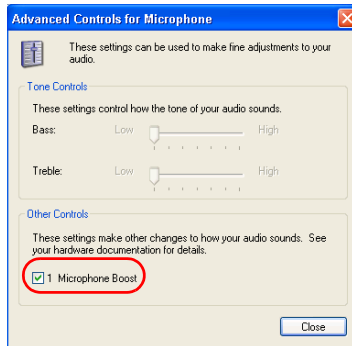

- Tap **Close**.

Note: Normally, you only have to select this option the first time that you adjust the microphone volume (the option will be selected for all other users as well). Once it is done, you can control the volume with the slider as explained at the next step.

- Under **Microphone**, use the slider to adjust the sound of your microphone. Close the window when your settings are complete.

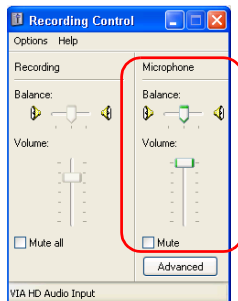

- Tap **OK** to return to the **Display & Sound** window.
- Tap  to return to the Mini Toolbox window.

To adjust the speaker volume:

1. From the **Main Menu**, tap **System Settings**.
2. If necessary, from **System Settings**, tap **Display & Sound**.

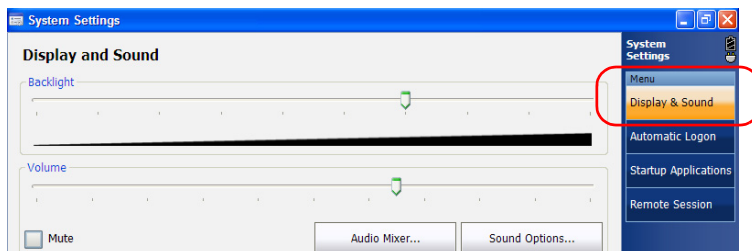

3. Under **Volume**, use the slider to adjust the sound of your speaker.

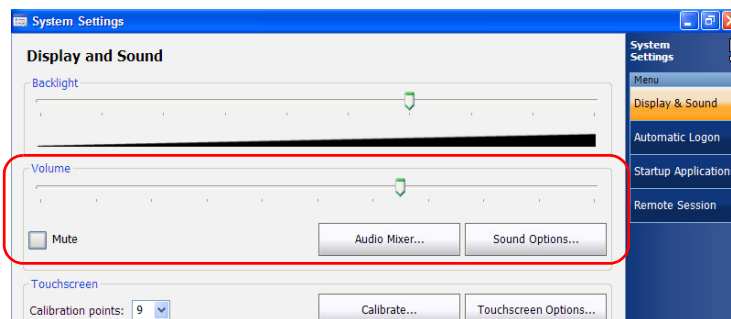

Note: You can also select the **Mute** check box if you want to quickly turn off the sound.

Note: You can tap the **Audio Mixer** button if you want to refine the volume according to the source of the sound (**Master Volume** and **Wave** controls).

4. Tap  to return to the Mini Toolbox window.

Setting Up Your Unit

Recalibrating the Touchscreen

Recalibrating the Touchscreen

If you notice the touchscreen does not behave in the way it used to (for example, it is now difficult to select items) it probably needs a recalibration.

The default calibration method is performed using nine points, but you can also perform a 4-point, or even a 25-point calibration (linearization) if you need more accuracy.

You can stop the calibration process at any time, but the touchscreen will still need calibration. The parameters are taken into account only when the process is complete.

To recalibrate the touchscreen:

1. From the **Main Menu**, tap **System Settings**.
2. If necessary, from **System Settings**, tap **Display & Sound**.

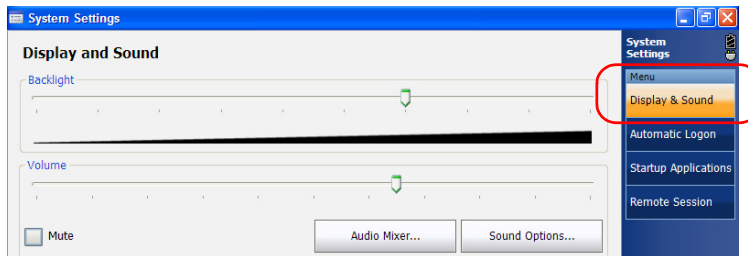

- From the **Calibration points** list, select the desired number of points for the calibration.

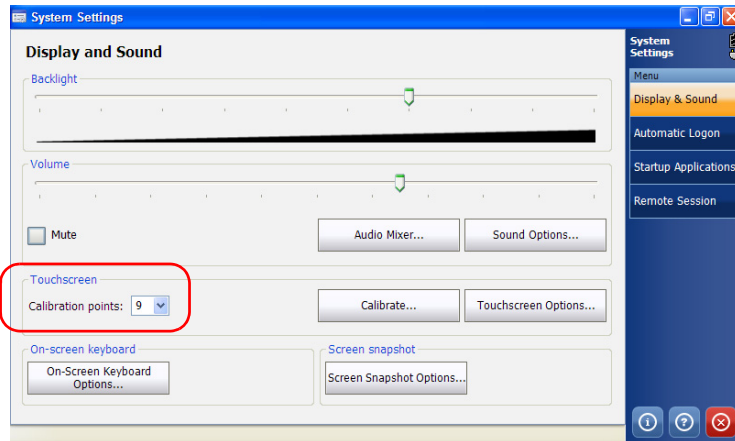

- Tap **Calibrate**.

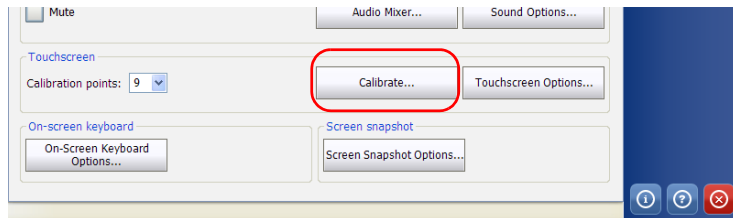

Setting Up Your Unit

Recalibrating the Touchscreen

- Using the stylus (or any blunt pointing device), simply press the center of the different targets that appear on the screen. Keep pressing until the application displays **OK** to indicate that the new parameters have been taken into account.

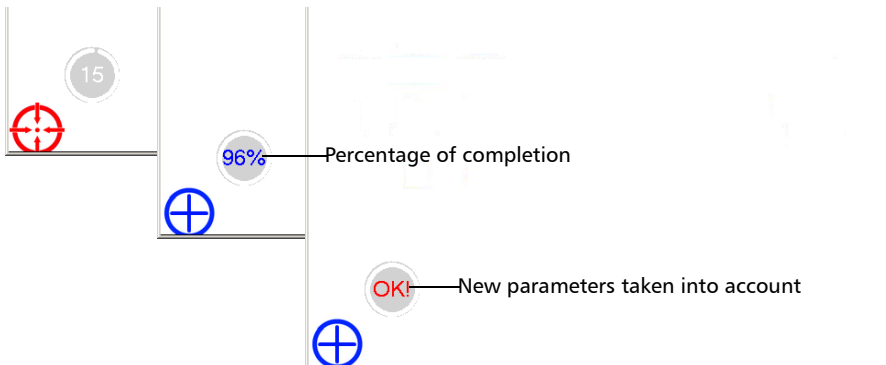

Note: If you want to stop the calibration process, press  from the unit's keypad. The application will close automatically and you will return to the **Display & Sound** window.

When the calibration is complete, you will return to the **Display & Sound** window automatically.

- Tap  to return to the Mini Toolbox window.

Enabling or Disabling the Touchscreen Right-Click Feature

By default, you can right-click with your touchscreen (see *Right-Clicking with the Touchscreen* on page 30). However, you can disable this feature if you prefer.

To enable or disable the right-click of the touchscreen:

1. From the **Main Menu**, tap **System Settings**.
2. If necessary, from System Settings, tap **Display & Sound**.

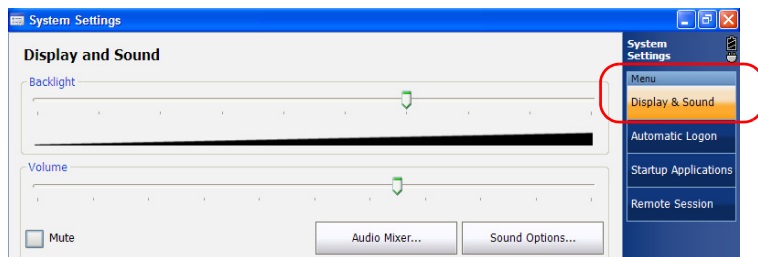

3. Under **Touchscreen**, tap the **Touchscreen Options** button.

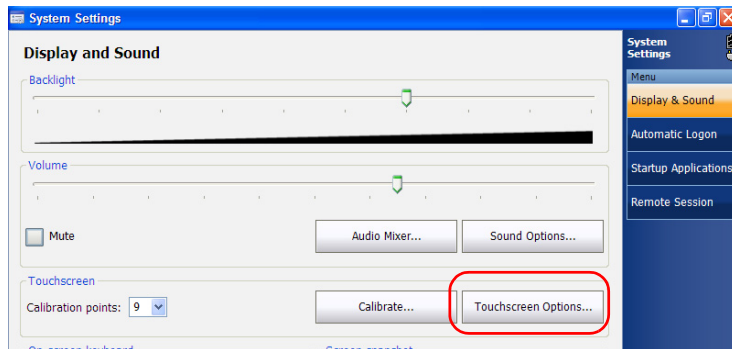

Setting Up Your Unit

Enabling or Disabling the Touchscreen Right-Click Feature

4. Select the **Setting** tab.

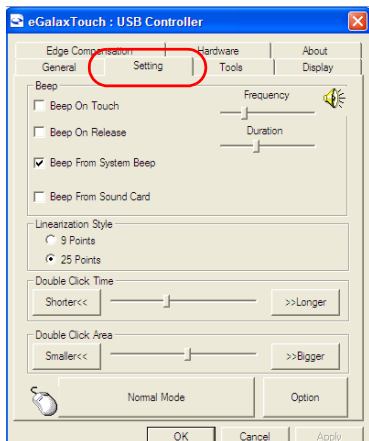

5. Tap the **Option** button.

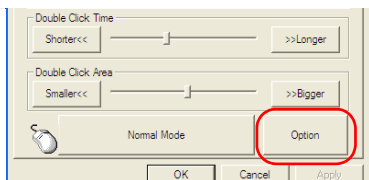

- From the **Option** tab, select the **Enable Auto Right Click** check box to enable the option.

OR

Clear the check box if you prefer to disable the right-click.

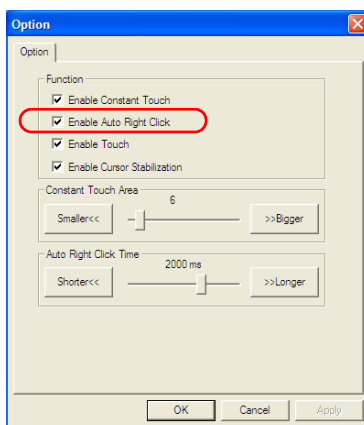

- Tap **OK** to confirm the changes.
- Tap **OK** once again to close the touchscreen parameters window.
- Tap  to return to the Mini Toolbox window.

Setting Up Your Unit

Customizing the On-Screen Keyboard

Customizing the On-Screen Keyboard

You can customize the appearance and behavior of the on-screen keyboard. For more information on the various parameters that you can set, refer to the on-screen keyboard online help.

For information on how to switch from one of the available languages to another, see *Selecting the Language of Operation* on page 68.

To customize the appearance and behavior of the on-screen keyboard:

1. From the **Main Menu**, tap **System Settings**.
2. If necessary, from **System Settings**, tap **Display & Sound**.

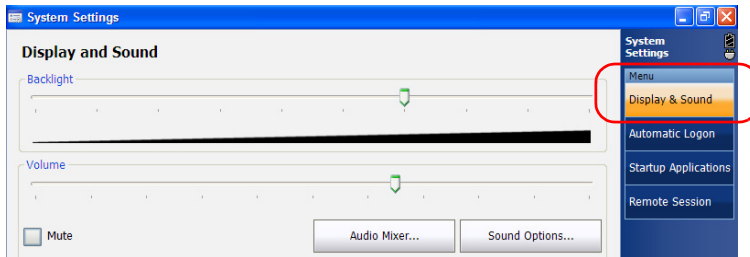

3. Under **On-screen keyboard**, tap the **On-Screen Keyboard Options** button.

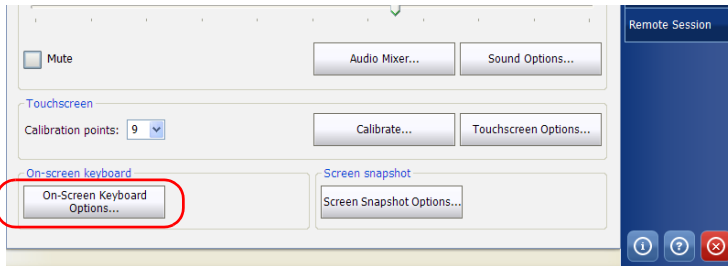

4. Configure the keyboard according to your needs.

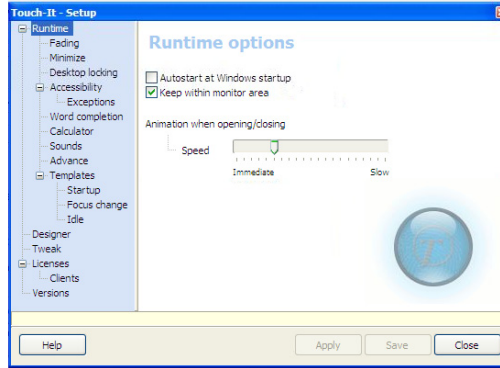

Note: You can access the online help related to the keyboard options by tapping the **Help** button.

5. When you have finished, tap **Close**.
6. Tap  to return to the Mini Toolbox window.

Setting Up Your Unit

Enabling or Disabling the Automatic Logon

Enabling or Disabling the Automatic Logon

Note: *Only administrator-level users can enable or disable the automatic logon feature.*

You can configure your unit to automatically log on to Windows at startup (no need to select a user and enter a password). You can also disable this feature if you prefer to define separate user accounts with different user access rights and passwords.

Note: *For security reasons, when the unit comes back from standby or hibernate modes, the application will prompt you to select a user and enter a password, even if you have enabled the automatic logon feature.*

By default, the automatic logon is enabled for the *Supervisor* user account, with an empty password. If you want to create (or modify) a password for the user account for which the automatic logon is enabled, you will have to disable the feature first, and then enable it again once the new password is defined.

If you want to modify the account used for the automatic logon, you will also have to disable the feature first, and then enable it again for the new account.

To enable (or modify) the automatic logon:

1. From the **Main Menu**, tap **System Settings**.
2. From **System Settings**, tap **Automatic Logon**.

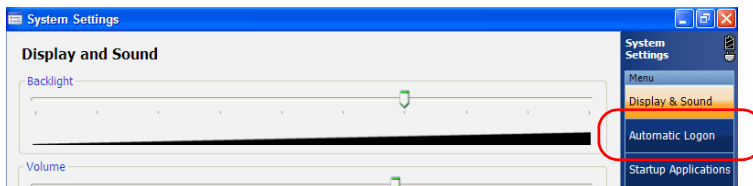

3. Enter the desired user name (account) and the corresponding password.

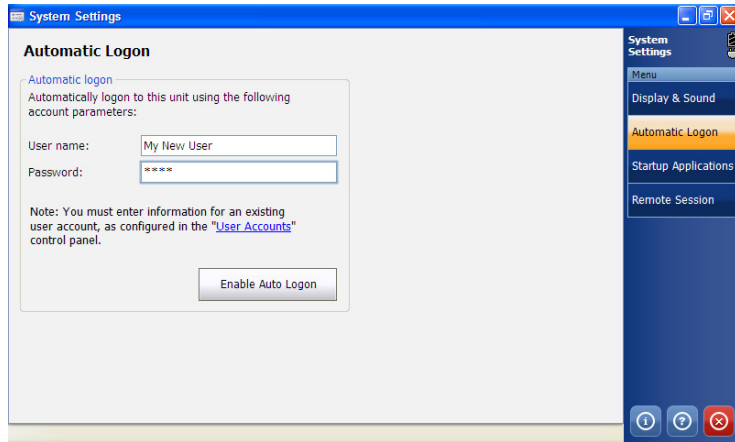

IMPORTANT

You cannot create user accounts or modify passwords from the Automatic Logon window.

The user name and password that you specify must correspond to those of an account that has been defined from User Accounts in Control Panel.

4. Tap **Enable Auto Logon**.
5. Tap  to return to the Mini Toolbox window.

At next startup, you will no longer need to specify a user name and password (except if the unit comes back from standby or hibernate modes).

Setting Up Your Unit

Enabling or Disabling the Automatic Logon

To disable the automatic logon:

1. From the **Main Menu**, tap **System Settings**.
2. From **System Settings**, tap **Automatic Logon**.

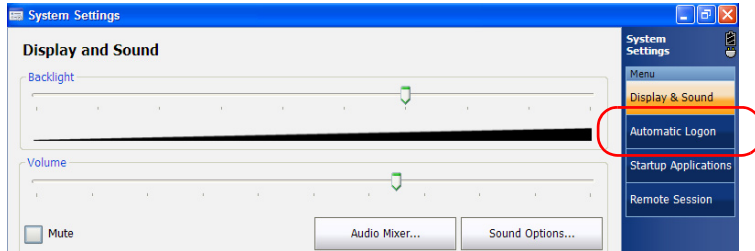

3. Tap **Disable Auto Logon**.

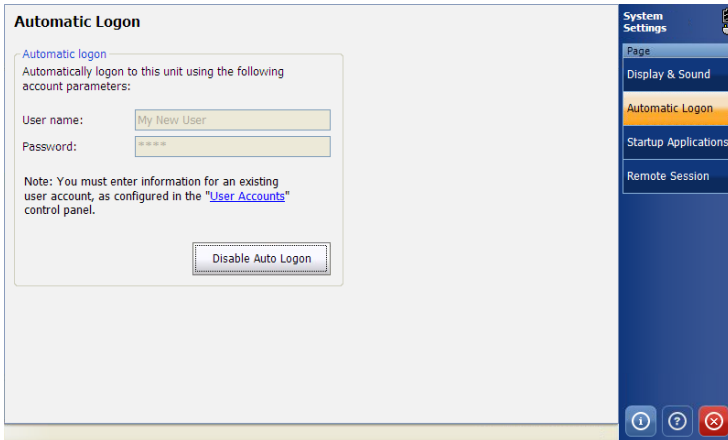

4. When the application prompts you, confirm with **Yes**.
5. Tap  to return to the Mini Toolbox window.

At next startup, you will have to specify the user name and password.

Selecting the Startup Application

The first time you start your unit, Mini Toolbox is displayed. However, you can configure your unit to automatically start in any of the available applications.

The selected application or applications will start automatically the next time you turn on your unit after a shutdown (not in standby or hibernate mode). For more information, see *Turning Off Your Unit* on page 31.

If you want to configure your unit to start the TightVNC server automatically at startup (for remote control), see *Working With TightVNC* on page 153.

If the specified application cannot be started (for example, the required module is not present in the unit), Mini Toolbox is started automatically. You will have to select the application again when the module is inserted into the unit.

To select a startup application:

1. From the **Main Menu**, tap **System Settings**.
2. From **System Settings**, tap **Startup Applications**.

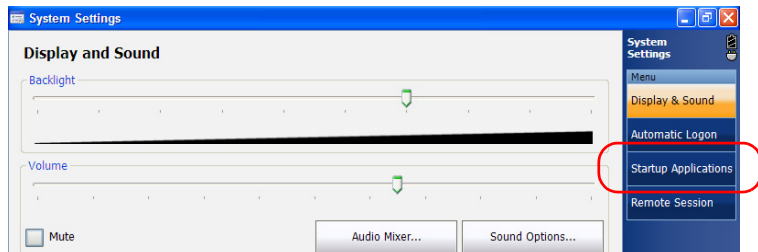

Setting Up Your Unit

Selecting the Startup Application

- Under **Module application** or **Utility applications**, select the application or applications you want to start automatically when you turn on your unit.

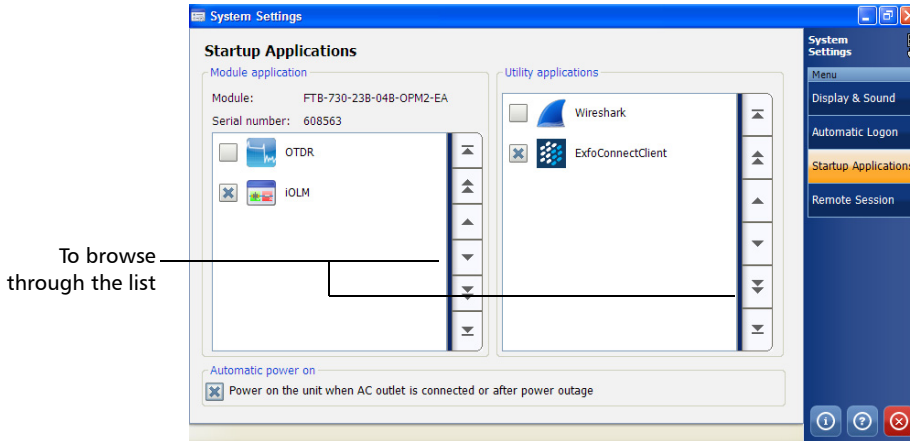

Note: You can select several utility applications, but only one module application at a time.

Note: If necessary, you can use the scrolling arrows located at the right of the **Module application** and **Utility applications** lists to browse through the available items.

Your changes are automatically saved.

- Tap  to return to the Mini Toolbox window.

Your changes are automatically saved.

Configuring Network Printers

To print documents and images on a network printer, you must configure the printer first. You must know the IP address of the network printer that you want to configure (contact your network administrator).



IMPORTANT

- ▶ Your unit does not support USB printers.
- ▶ Your unit only supports network printers compatible with PCL 6 (which is a "Printer Control Language"). If you are not sure whether a specific printer is compatible or not, contact your network administrator.

For more information on printing, see *Printing Documents* on page 89.

To configure the printer:

1. On your unit, from the **Main Menu**, tap **Setup**.
2. Double-tap **Printers and Faxes**.

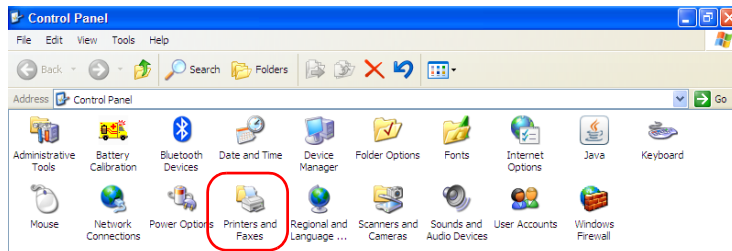

Setting Up Your Unit

Configuring Network Printers

3. Select the **HP Universal Printing PCL 6** item.

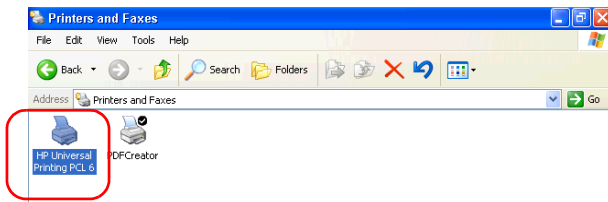

4. From the menu, select **File > Printing Preferences**.
5. Under **Find a Printer**, select **Enter a Printer Address**.

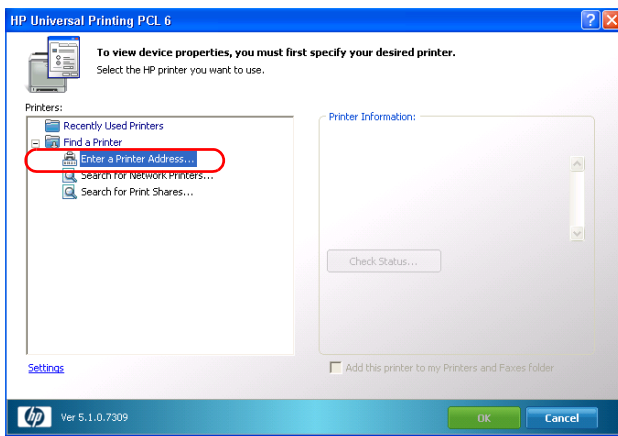

6. Enter the IP address of the printer that you want to configure, and then tap **OK**.

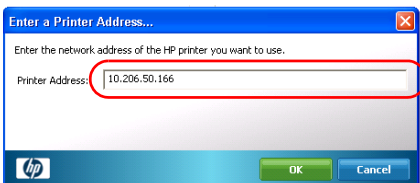

7. Select the **Add this printer to my Printers and Faxes** folder check box.

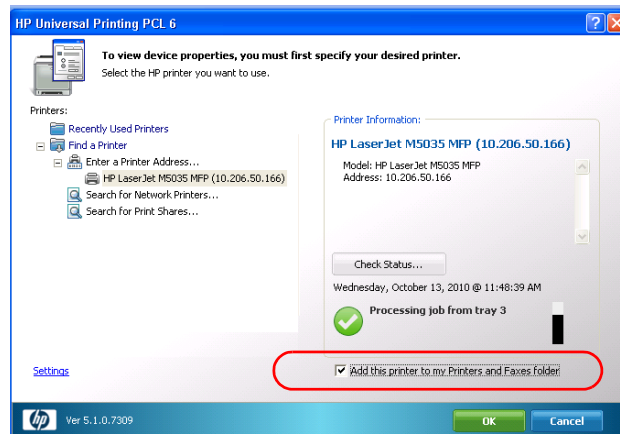

8. Tap **OK** to confirm. The operation can take several minutes to complete.
9. When the application prompts you, click **OK** to acknowledge the message.
10. If desired, modify the printer preferences to your liking. You can save the whole set of preferences for future use with the **Save As** button or press  from the unit's keypad to save the parameters for the current work session.
11. Close the **Printing Preferences** window, and then close the **Printers and Faxes** window to return to Mini Toolbox.

The printer is now ready to use.

Setting Up Your Unit

Selecting the Language of Operation

Selecting the Language of Operation

You may display the user interface in one of the available languages (default is English).

When you change the interface language, the corresponding keyboard is not automatically added to the list of available keyboards. You must add the desired keyboard separately if you want to enter text in a specific language (both on-screen or “real” keyboards). Once the keyboards are added, you can switch easily from one input language to another.



IMPORTANT

The keyboards that you add will not be available from the logon window.

To avoid problems, when you define or modify passwords, EXFO recommends that you always use the keyboard corresponding to the language of the unit at time of purchase. Otherwise, you might not be able to log on to your user account (unsupported characters, different keyboard layout, etc.)

Values are kept in memory even when you turn the unit off.



IMPORTANT

The language setting of the VLC media player is independent of the language setting of Mini Toolbox. You must configure both separately.

To select a new interface language:

1. From the **Main Menu**, tap **Setup**.
2. Double-tap **Regional and Language Options**.



3. Select the **Languages** tab.

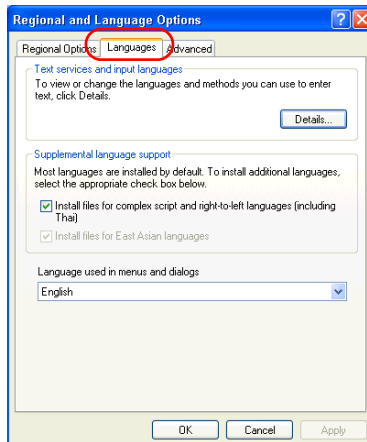

4. From the **Language used in menus and dialogs** list, select the desired language.
5. Tap **Apply** to confirm the changes, and then **OK** to return to the **Control Panel** window.

The new interface language will become available at the next startup.

Setting Up Your Unit

Selecting the Language of Operation

To add new input languages:

1. From the **Main Menu**, tap **Setup**.
2. Double-tap **Regional and Language Options**.

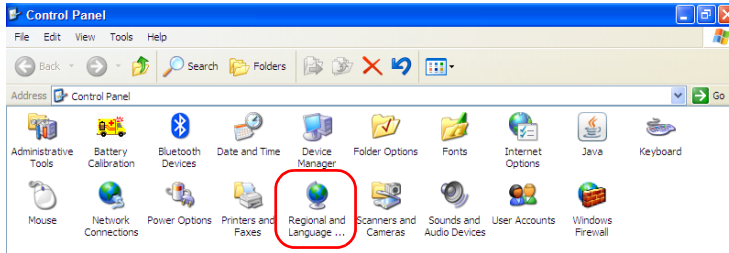

3. Select the **Languages** tab.

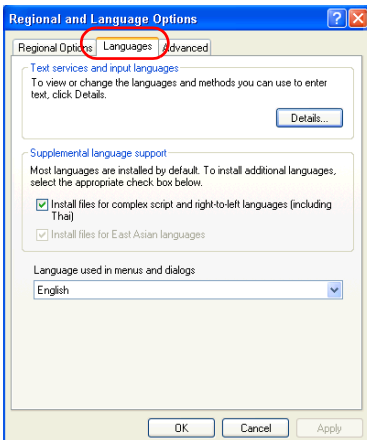

4. Under **Text services and input languages**, tap **Details**.

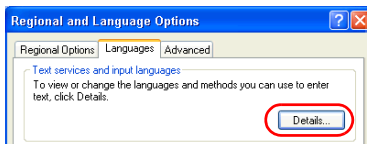

- 5.** Under **Installed services**, tap **Add**.

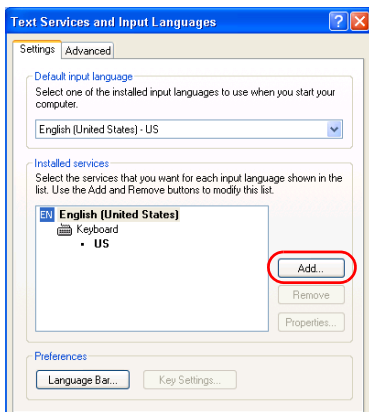

- 6.** From the **Input language** list, select the desired language.

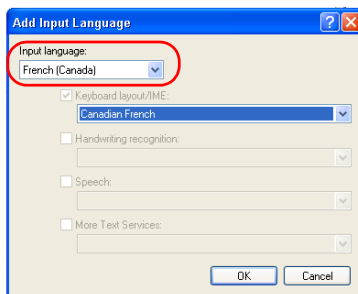



- 7.** If necessary, from the **Keyboard layout/IME** list, select the desired option.
- 8.** Tap **OK** to confirm.
- 9.** Repeat steps 5 to 8 for all the languages that you want to add.
- 10.** Tap **Apply** to confirm the changes, and then **OK** to return to the **Control Panel** window.

The added keyboards are available immediately. You can now switch from one input language to another.

Setting Up Your Unit

Selecting the Language of Operation

To switch from one of the available input languages to another:

1. From the unit's keypad, press the /  button to display the on-screen keyboard.
2. From the on-screen keyboard, tap  to display the list of available input languages.
3. From the list of languages, select the desired one.

You are now ready to start entering text in the selected input language.

Note: *Modifying the input language does not modify the language of the interface.*

To modify the language of the VLC media player:

1. Close the Mini Toolbox window.
2. On the Windows taskbar, tap **Start**, then select **All Programs** > **VideoLAN** > **VLC media player**.
3. From the menu, select **Tools** > **Preferences**.

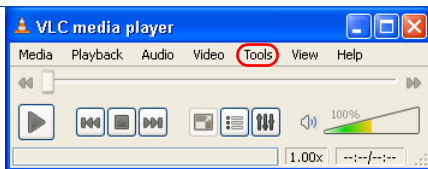

4. Under **Language**, select the desired language from the list.

By default, the language is set to **Auto**, to follow the *Standards and formats* setting of Windows, but you can select any other language.

5. Tap **Save** to confirm and close the application.

Note: *This operation has no impact on the date and time formats in Windows Embedded Standard and in the Mini Toolbox applications.*

Setting Date and Time Formats

The current date and time are displayed at the bottom of the **Main Menu**.

You can modify the format in which the date and time are displayed.

For information on how to adjust the date, the time, and the time zone, see *Adjusting the Date, Time and Time Zone* on page 76.

Note: *Modifying location, date and time settings will affect some of the Windows Embedded Standard settings.*

To set date and time formats:

1. From the **Main Menu**, tap **Setup**.
2. Double-tap **Regional and Language Options**.

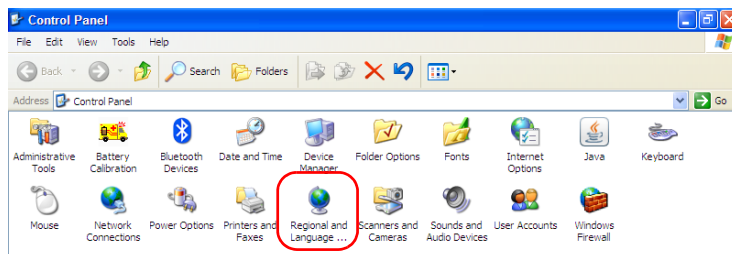

Setting Up Your Unit

Setting Date and Time Formats

3. Select the **Regional Options** tab.

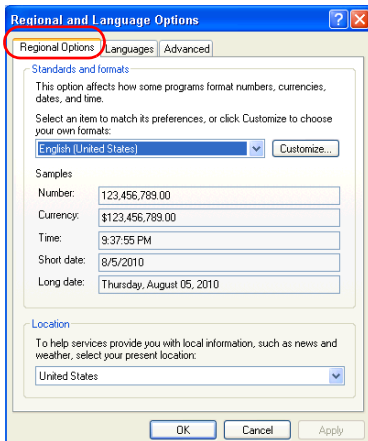

4. Under **Standards and formats**, select the desired language. This will determine the date formats available for the time as well as the short and long dates.

5. If necessary, refine the settings as follows:
 - 5a. Tap **Customize** to display the detailed settings.

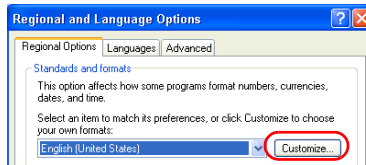

- 5b. Select either the **Time** or **Date** tab, depending on the settings that you want to modify.

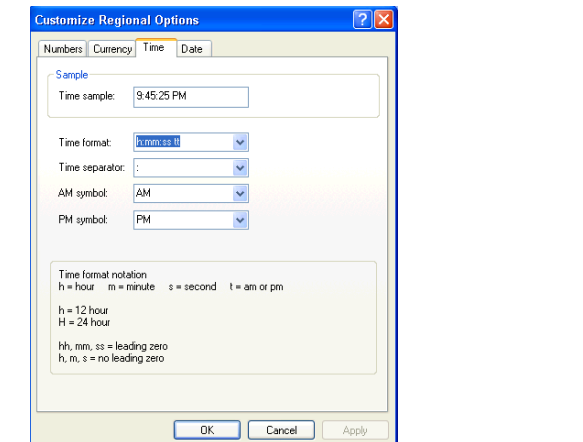

6. Modify the settings.
7. Tap **Apply** to confirm the changes, and then **OK** to return to the **Control Panel** window.

Setting Up Your Unit

Adjusting the Date, Time and Time Zone

Adjusting the Date, Time and Time Zone

Note: *Only administrator-level users can adjust the date, time and time zone.*

The current date and time are displayed at the bottom of the main window. When saving results, the unit also saves the corresponding date and time.

Note: *A dedicated clock battery keeps the date and time accurate.*

For information on how to modify the format in which the date and time are displayed, see *Setting Date and Time Formats* on page 73.

Note: *Modifying date and time settings will affect some of the Windows Embedded Standard settings.*

To adjust the date and time:

- 1.** From the **Main Menu**, tap **Setup**.
- 2.** Double-tap **Date and Time**.

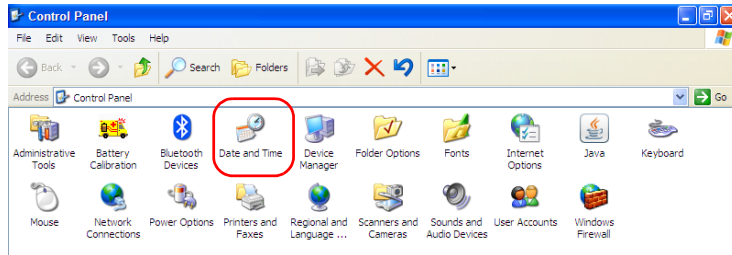

- 3.** Select the **Date & Time** tab.

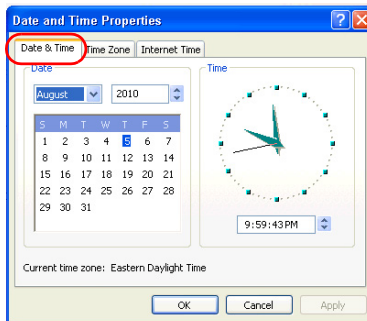

- 4.** Modify the settings according to your needs.
- 5.** Tap **Apply** to confirm the changes, and then **OK** to return to the **Control Panel** window.

Setting Up Your Unit

Adjusting the Date, Time and Time Zone

To change the time zone:

1. From the **Main Menu**, tap **Setup**.
2. Double-tap **Date and Time**.

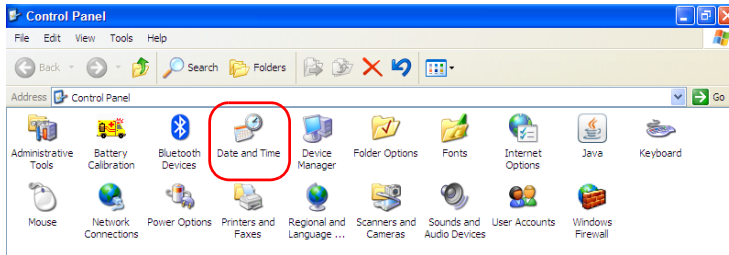

3. Select the **Time Zone** tab.

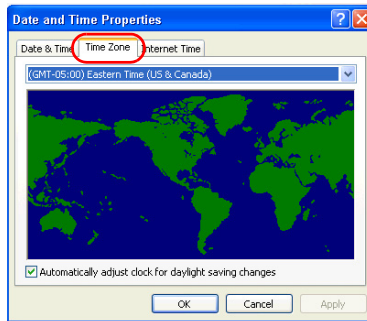

4. Modify the settings according to your needs.
5. Tap **Apply** to confirm the changes, and then **OK** to return to the **Control Panel** window.

Configuring the Power Management Options

To get the optimum performance out of your FTB-1, your unit comes with three predefined sets of parameters (schemes) to manage power.

When you do not use the unit for a while, the display may be turned off to save power. You can also configure the unit to go into standby or hibernation mode after the specified duration has expired (see *Turning Off Your Unit* on page 31).

For all of these actions, you can set idle durations for AC adapter/charger and battery operation. The values that you set are kept in memory even when you turn the unit off.

Note: *When the backlight is turned off, the unit operation is not interrupted. Press any key or touch anywhere on the screen to return to normal operation.*

Setting Up Your Unit

Configuring the Power Management Options

The table below indicates the default values that are included in each of the predefined power schemes.

Power Scheme	Action	When AC is connected	Running on batteries
Standard (selected by default)	Turn off monitor	Never	After 5 minutes
	System standby	Never	After 15 minutes
	System hibernates	Never	After 30 minutes
Always On	Turn off monitor	Never	Never
	System standby	Never	Never
	System hibernates	Never	Never
Max Battery	Turn off monitor	After 15 minutes	After 5 minutes
	System standby	After 30 minutes	After 15 minutes
	System hibernates	After 45 minutes	After 30 minutes

Note: *The Turn off hard disks setting is not taken into account (not applicable).*

You can either modify one of the existing power schemes or create one (based on an existing power scheme).



CAUTION

Your unit has been designed to manage power as well as battery alarms automatically. Never modify the parameters that appear on the Alarms tab. Doing so WILL prevent the unit from working properly.

To select a power scheme:

1. From the **Main Menu**, tap **Setup**.
2. Double-tap **Power Options**.

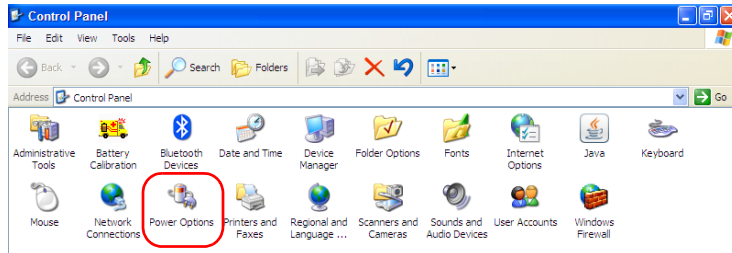

3. From the **Power Schemes** list, select the desired predefined set of parameters.

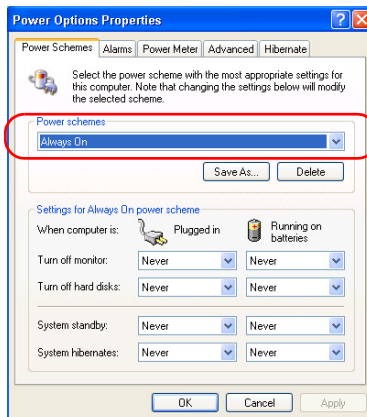

4. Tap **Apply** to confirm the changes, and then **OK** to return to the **Control Panel** window.

Setting Up Your Unit

Configuring the Power Management Options

To modify a power scheme:

1. From the **Main Menu**, tap **Setup**.
2. Double-tap **Power Options**.

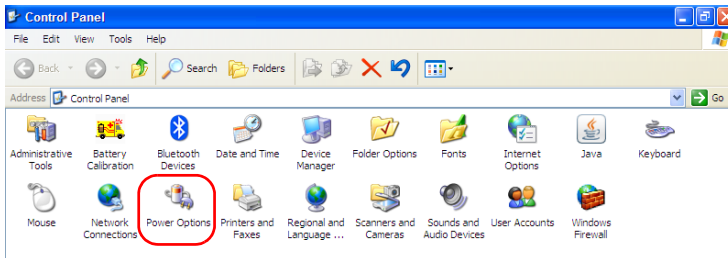

3. From the **Power Schemes** list, select the predefined set of parameters that you want to modify or on which you want to base your new scheme.
4. Modify the parameters to your needs.
5. Tap **Save As**.

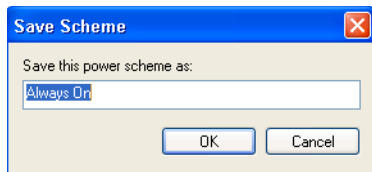

- If you want to modify the existing power scheme, keep the name as is, and then tap **OK**.
- OR
- If you prefer to create a new power scheme, enter a new name, and then tap **OK**.
6. Tap **Apply** to confirm the changes, and then **OK** to return to the **Control Panel** window.

Configuring the Internet Options

You can browse the Web directly from your unit, provided that you have access to an Internet connection and that the Internet options are configured properly.

If you are not sure about how you should configure your Internet access, contact your network administrator.

To configure the Internet options:

- 1.** From the **Main Menu**, tap **Setup**.
- 2.** Double-tap **Internet Options**.

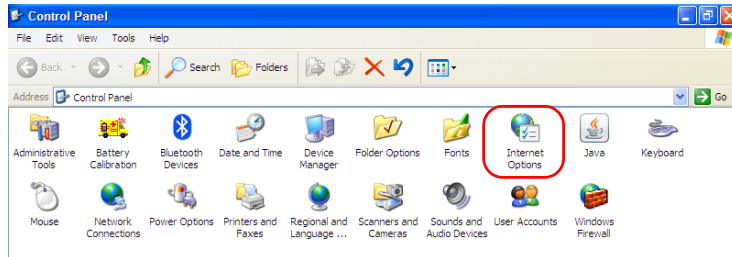

- 3.** Go to the **Connections** tab.
- 4.** Modify the settings using the information provided by your network administrator.
- 5.** Tap **OK** to return to the **Control Panel** window.

Getting Ready to Retrieve Geolocation Information

With your unit and a smart device properly configured, you can retrieve geolocation information (latitude and longitude coordinates) to identify the position of your unit. This geolocation information can then be saved along with test results, or viewed in the GPS Coordinates Viewer (see *Retrieving the GPS Location of Your Unit* on page 108).

Note: *Some applications may not save geolocation information along with test results.*

During the configuration of the smart device, you will create a mobile wireless hotspot onto which your unit will connect to retrieve the geolocation information.

Note: *Normally, you would only need to configure your unit and smart device the first time you want to retrieve geolocation information. Your subsequent work sessions would require a simple connection.*



IMPORTANT

- Your unit must be equipped with the Wi-Fi and Bluetooth option.
- To be able to create a mobile wireless hotspot on your smart device, you may have to subscribe to a data plan. Contact your mobile service provider for more information.

To configure your unit and smart device to share geolocation information:

- 1.** On your unit, if it is not done already, activate the SMARTGPS software option. For more information, see *Activating Software Options* on page 40.
- 2.** On your smart device, create a mobile wireless hotspot that will serve as a Wi-Fi network to which your unit will connect. For more information about the creation of mobile hotspots, refer to the user documentation that came with your smart device.
- 3.** If it is not done already, install EXFO Link:
 - 3a.** Ensure you have access to an Internet connection.
 - 3b.** Ensure that you have a Google account to be able to download EXFO Link.
 - 3c.** Tap the **Google Play Store** icon.
 - 3d.** In the **Google Play Store** (or **Play Store**) application, search for EXFO or EXFO Link.
 - 3e.** Follow the instructions on-screen.
- 4.** Start the EXFO Link application.

Setting Up Your Unit

Getting Ready to Retrieve Geolocation Information

5. If is not done already, enable the geolocation feature:

5a. From the main window, tap .

Note: Depending on the smart device you are using, the application settings could be found in the menu button instead.

5b. Select **Settings**.

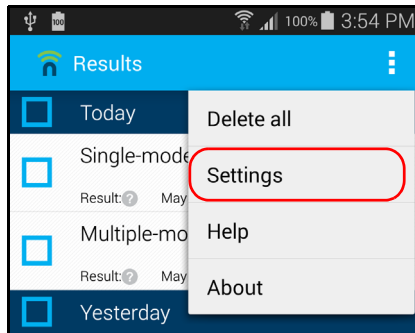

5c. Under **GENERAL SETTINGS**, select the **Geolocation** option.

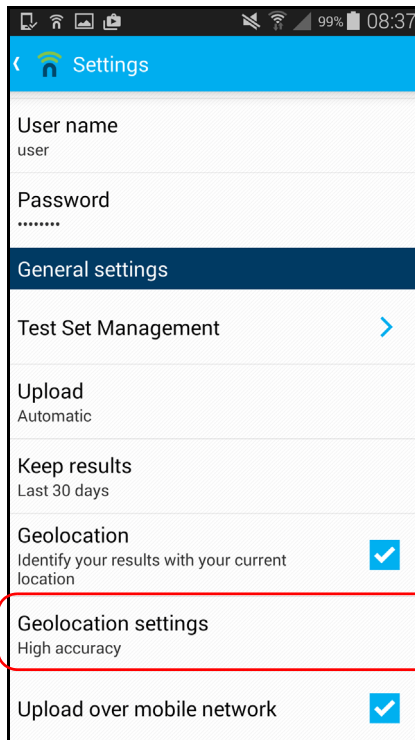

Note: For more information on how to modify other settings related to geolocation, refer to the EXFO Link user documentation.

5d. Tap  to return to the main window.

You are now ready to connect your unit to the mobile hotspot to start receiving geolocation information.

Setting Up Your Unit

Setting Other Parameters

To connect your unit to the mobile hotspot:

1. On your smart device, ensure that EXFO Link is running and that the mobile hotspot that you have created is available.
2. Connect your unit to the mobile hotspot as you would do with any other wireless network. For more information, see *Connecting to a Wireless Network* on page 125.

Your unit is now ready to start receiving geolocation information when available.

Note: *To avoid extra fees, you may want to turn off the mobile hotspot on your smart device when you do not use it.*

Setting Other Parameters

You can also configure other parameters via the **Control Panel** window. Refer to Microsoft Windows Embedded Standard documentation for details.

5 Working with Your Unit

Printing Documents

You can print documents and images directly from your unit by using either the provided PDF creation tool or a network printer (for printing on paper).

You can view the PDF files from your unit, using the provided PDF reader. For more information, see *Viewing PDF Files* on page 90.

To print on a network printer, your unit must be accessible from this network by Wi-Fi or standard Ethernet. You must also define the printer on your unit before attempting to access it (see *Configuring Network Printers* on page 65).

If you cannot connect your unit to a network, you can use a USB memory key to transfer the files that you want to print to a computer connected to the network.

Note: *Some applications may not offer print functions.*

To print documents:

1. Open the document that you want to print.
2. From the application in which you have opened your file, access the print function.

Note: *In most applications, you can access the print function by the **File** menu or by a **Print** button.*

3. Select the desired printer (PDF creation tool by default).
4. If necessary, adjust the printer's parameters to your needs.
5. Tap **Print** to start the printing process, and follow the on-screen instructions.

Viewing PDF Files

You can view PDF files directly from your unit using the provided PDF viewer. For more information on the available features for this reader, refer to the PDF viewer online help.

Note: *You may need a connection to the Internet to access the PDF viewer online help.*

To view PDF files:

- 1.** From **Main Menu**, select **File Manager**.
- 2.** Browse through the folders to find the desired PDF file.
- 3.** Double-tap the file.
- 4.** The file opens automatically in the PDF viewer.

Taking Screen Captures

You can take captures of what is displayed on your screen, directly from your unit. This could be useful for troubleshooting when you need another person to have a look at a specific configuration or problem. You could also use this tool for training purposes.

If you want to capture images of the fibers that you examine with the fiber inspection probe, you can use the capture feature of the probe instead.

For more information on how to modify the default file format and destination folder, see *Setting Storage Parameters for Screen Captures* on page 94.

- Images are saved using the defined file format. By default, images are created in .bmp format, but you can modify this parameter. By default, they are kept in the following folder:

D:\Documents and Settings\User_currently_logged_on\My Documents\Screen Snapshot

where *User_currently_logged_on* corresponds to the user name of the person that is currently logged on the unit.

It is possible to modify the folder in which images are automatically saved.

Working with Your Unit

Taking Screen Captures

- By default, the application generates file names as follows:

IMG_[YEAR]_[MONTH]_[DAY]_[HOUR]_[MINUTE]_[SEQUENTIAL NUMBER].bmp

Example:

For a screen capture taken on August 20, 2010, the file name could be:

IMG_2010_08_20_13_23_01.bmp.

Note: *The HOUR value will appear in a 24-hour format, regardless of your unit's time settings.*

Note: *The SEQUENTIAL NUMBER value is used to differentiate two captures that would have been taken at the same date and time.*

- There are two ways to capture images: a quick mode (the screen capture tool is automatically closed as soon as the capture is made) and a multiple-capture mode (the screen capture button is part of a floating toolbar that remains available until you close it). By default, this toolbar is located in the lower-right corner of the screen. However, you can move it to a location that better suits your needs.





To take only one screen capture:

From the unit's keypad, press the /  button and hold it down for about 3 seconds.

The screen capture is automatically taken as soon as you release the button (a sound and visual effect typical of a camera taking a picture indicate that the capture is complete).

Note: *If a keyboard is connected to your unit, you can also press the PRINT SCREEN key.*

To take several screen captures:

1. From the unit's keypad, press the /  button.
2. Once the on-screen keyboard is displayed, tap the  button.
3. From the floating toolbar, tap the  button.

The screen capture is automatically taken (a sound and visual effect typical of a camera taking a picture indicate that the capture is complete).

Setting Storage Parameters for Screen Captures

You can modify the file format of the screen captures as well as the destination folder, that is the folder to which the captures will be sent.

- By default, images are saved in .bmp format, but you can configure the application to save them in .jpg or .png format.
- By default, images are kept in the following folder:

D:\Documents and Settings\User_currently_logged_on\My Documents\Screen Snapshot

where *User_currently_logged_on* corresponds to the user name of the person that is currently logged on the unit.

You can select any other folder as the destination either locally on your unit, on a USB memory key.

Note: *If the specified folder is no longer available (folder name has been modified, folder has been deleted), the screen captures will be sent to the default folder. Similarly, if you have defined a destination folder on a USB key and this key is not connected to your unit when you take screen captures, the latter will be sent to the default folder.*

To set the default image format:

1. From the Main Menu, tap **System Settings**.
2. If necessary, from **System Settings**, tap **Display & Sound**.

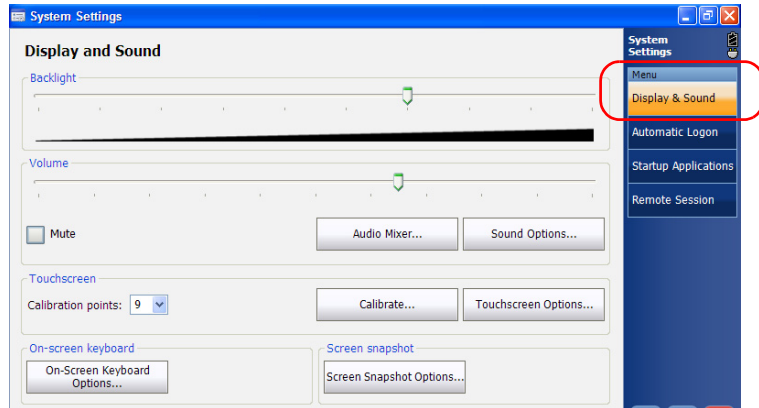

3. Under **Screen snapshot**, tap the **Screen Snapshot Options** button.
4. Under **Image format**, select the option corresponding to the desired format.

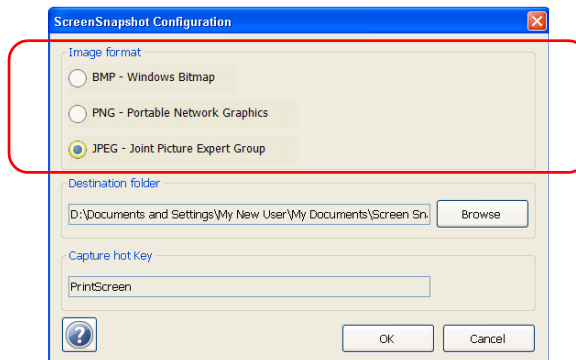

5. Tap **OK** to confirm the changes and close the window.

Working with Your Unit

Setting Storage Parameters for Screen Captures

To modify the destination folder:

1. From the Main Menu, tap **System Settings**.
2. If necessary, from **System Settings**, tap **Display & Sound**.

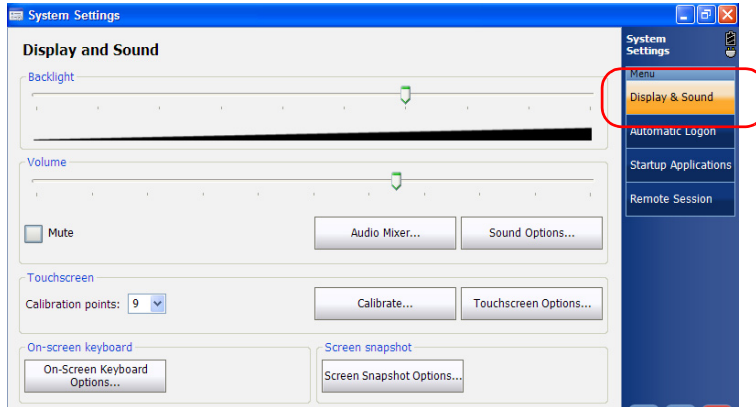

3. Under **Screen snapshot**, tap the **Screen Snapshot Options** button.
4. Under **Destination folder**, tap **Browse**.

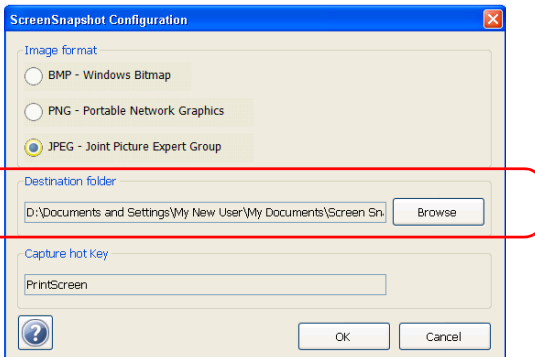

5. From the **Browse for Folder** window, select the folder that you want to use to store the screen captures. If necessary, you can create a folder.



6. When your selection is made, tap **OK**.
7. Tap **OK** to confirm the changes and close the window.

Reading Audio and Video Files

Your unit is equipped with the VLC media player which enables you to read audio files and to view video files (such as .avi and .divx). This could be especially useful if your company wants to use multimedia files for training. The player can read files that are stored on your unit, on a USB memory key, on a network folder, or even on a Web site.



IMPORTANT

The VLC media player does not support the Flash format. If you want to read files in this format, you will need to install the Adobe Flash Player application (see *Installing Adobe Flash Player on Your Unit* on page 100).

For more information on how to configure the language of the media player, see *Selecting the Language of Operation* on page 68.

For more information on how to use the video player, refer to the VideoLAN online help.

To read video or audio files:

- 1.** From Mini Toolbox, select **File Manager**.
- 2.** Locate the video or audio file that you want to read.
- 3.** Double-tap the file.

The media player starts reading automatically if the file format is recognized.

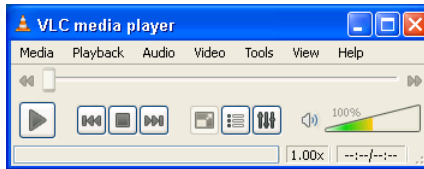

Note: *You can access the online help from the **Help** menu of the VCL Media Player application. You will need a connection to the Internet to view the online help.*

Installing Adobe Flash Player on Your Unit

The Adobe Flash Player application is not installed on your unit by default, but you can install it if you need to read files in Flash format.



IMPORTANT

EXFO does not provide licenses for Adobe Flash Player. Contact Adobe to purchase a license that will entitle you to install Flash Player on your unit.

To download the installation files, you will need a connection to the Internet. You can either download the files directly to your unit or to a computer (and transfer them to your unit later using a USB key).

Note: *Only administrator-level users can install software under Windows Embedded Standard. However, when the installation is complete, all users will be able to read files in Flash format.*



IMPORTANT

Ensure to download the latest installation package for the 32-bit version of Flash Player for Windows (operating system), and Internet Explorer (browser). You should retrieve the EXE installer component.

To install Adobe Flash Player on your unit:

- 1.** If necessary, turn on your unit.
- 2.** From your computer or your unit, open a Web browser and go to http://www.adobe.com/special/products/flashplayer/fp_distribution3.html.
- 3.** Locate the most recent version of Flash Player 32 bits.
- 4.** Under Flash Player 32 bits, locate the entry corresponding to Windows (operating system) and Internet Explorer (browser).
- 5.** Save the corresponding *EXE installer* to a location of your choice (on a USB memory key connected to your computer or on your unit).
- 6.** If you have downloaded the file to a USB key, connect the key to your unit.
- 7.** Double-tap the downloaded file, and follow the on-screen instructions.

Note: *At this point, if you have used a USB memory key to transfer the installation files to your unit, you can remove it.*

All users are now ready to read files in Flash format.

Browsing the Web

You can browse the Web directly from your unit, provided that you have access to an Internet connection.

If you need to modify the Internet options, see *Configuring the Internet Options* on page 83. For more information on how to connect to the Internet using a 3G USB modem key, see *Accessing the Internet with a 3G USB Modem Key* on page 104.

To browse the Web:

1. Open a Web browser as follows:
 - 1a. From Mini Toolbox, select the **Utilities** tab.
 - 1b. Tap the **Internet Explorer** icon to open the browser.

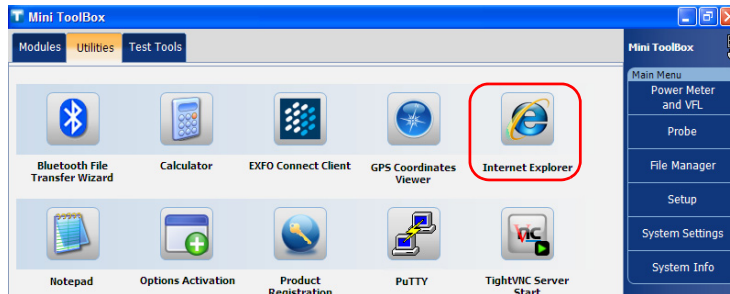

2. Enter the desired Web address in the address bar and tap the  button (located at the right of the address bar) to start browsing.

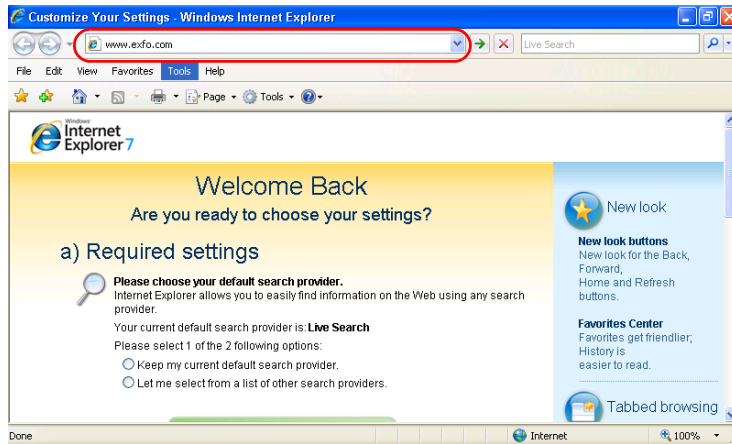

3. Close the window to return to the **Utilities** tab.

Accessing the Internet with a 3G USB Modem Key

Note: *Only administrator-level users can install software under Windows Embedded Standard. However, when the installation is complete, all users will have the possibility to access the Internet using a USB modem key.*

You can connect an optional 3G USB modem key to your unit to have a wireless access to the Internet.

When you receive your modem key, it contains no Subscriber Identity Module (SIM) card. This means that you will need to:

- Purchase a compatible and unlocked SIM card from a provider offering 3G services. If you need more information on the 3G coverage in your area, contact your regional EXFO sales representative.
- Have the card activated (you must subscribe to a package of mobile services).
- Insert the card in the modem key.

The very first time you connect a USB modem key to your unit, the AirCard Watcher application will be installed automatically on your unit. You will use this application to establish a connection with the mobile network whenever you want to work with your USB modem key. You only need to install this application once.



IMPORTANT

- **Only the Sierra Wireless 319U keys provided by EXFO are supported on your unit.**
- **Always turn your unit on *before* connecting the USB modem key to it. Otherwise, the USB modem may not be detected properly.**

To install the AirCard Watcher application on your unit:

- 1.** If necessary, turn on your unit and wait for the startup sequence to complete.
- 2.** If necessary, insert the SIM card into the USB modem key. For more information, refer to the documentation that came with your modem key.
- 3.** Connect the USB modem key to one of the USB ports of your unit.
The installation of the AirCard Watcher application will start automatically.
- 4.** Follow the on-screen instructions.

You will know that the installation is complete when the AirCard Watcher application starts.

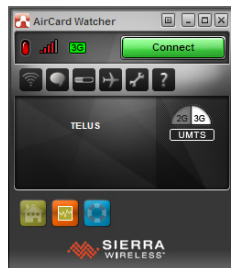

- 5.** Close the AirCard Watcher application.
- 6.** Disconnect the USB modem key from your unit.
- 7.** Reconnect the USB modem key to your unit so that it can be detected properly.

All users are now ready to start working with the USB modem key as explained hereafter.

Working with Your Unit

Accessing the Internet with a 3G USB Modem Key

To work with a 3G USB modem key:

- 1.** If necessary, turn on your unit and wait for the startup sequence to complete.
- 2.** If necessary, insert the SIM card into the USB modem key. For more information, refer to the documentation that came with your modem key.
- 3.** If necessary, connect the USB modem key to one of the USB ports of your unit.
- 4.** From the Windows desktop, double-tap the AirCard Watcher icon to start the application.

5. Once the AirCard Watcher application starts, tap **Connect** to establish a connection with the mobile network.



As soon as the connection is established, you are ready to browse the Web.

Note: *If you want to customize the behavior and appearance of the AirCard Watcher application, refer to the online help provided with the application (available by tapping ? from the toolbar).*

Note: *The application will display a warning message if no SIM card has been inserted in the USB modem key.*

Note: *Depending on the package that you have purchased with your service provider and the type of network, you may have to set specific parameters. If you are not sure on how to proceed or need more information about the configuration, contact your service provider.*

6. When you have finished working, tap **Disconnect** from the AirCard Watcher application, and then remove the USB modem key from your unit.

Retrieving the GPS Location of Your Unit

With your unit, a smart device, and the provided GPS utility, you can retrieve the latitude and longitude coordinates of your unit as well as the date and time of the reading. You will see either the last known coordinates or the current ones, depending on if the geolocation information could be retrieved or not.

In addition to viewing the GPS information on-screen, you can copy it to the Clipboard in two formats: a text string or a URL link. The text string contains the GPS coordinates as well as a date and time stamp. Once the information is in the Clipboard, you can paste it to any document or test report (in editable sections). If your unit is connected to the Internet, you can even directly paste the URL link to a Web browser to locate your unit on a map.

For information on how to configure your unit and smartphone to retrieve geolocation information, see *Getting Ready to Retrieve Geolocation Information* on page 84.

To retrieve the GPS location of your unit:

- 1.** If necessary, turn on your unit and wait for the startup sequence to complete.
- 2.** On your smart device, ensure that EXFO Link is running and that the mobile hotspot that you have created is available.
- 3.** Connect your unit to the mobile hotspot as you would do with any other wireless network. For more information, see *Connecting to a Wireless Network* on page 125.

4. From Mini Toolbox, select the **Utilities** tab, then tap **GPS Coordinates Viewer**.

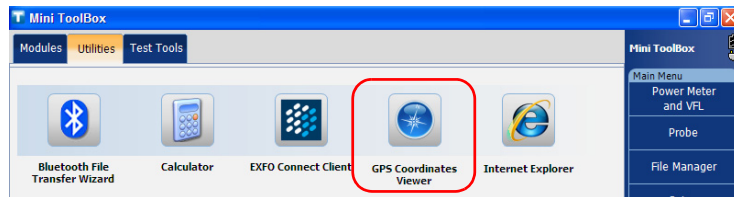

The GPS coordinates are displayed.

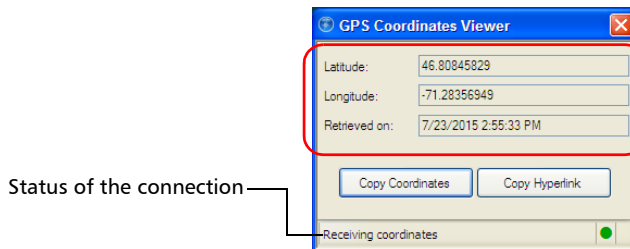

Note: If you see “GPS not detected” at the bottom of the **GPS Coordinates** window, this could mean that either the SMARTGPS option is not activated on your unit, or there is a problem with the link to the mobile hotspot. When geolocation information is available, the utility will display “Receiving coordinates”.

Note: If you have problems receiving coordinates, you may want to try using the unit and smart device outdoors, and as far away as possible from buildings and other solid objects.

- Tap **Copy Coordinates** to send the displayed information to the Clipboard as a text string.
- Tap **Copy Hyperlink** to send the displayed information to the Clipboard as a URL link.

5. When your work is finished, tap  to close the utility.

Using the Calculator

You can use Microsoft Calculator directly from your unit.

To use the Calculator:

1. From Mini Toolbox, select the **Utilities** tab.
2. Tap **Calculator**.

Using the Text Editor

You can use Microsoft Notepad directly from your unit.

To use the text editor:

1. From Mini Toolbox, select the **Utilities** tab.
2. Tap **Notepad**.

Accessing Other Tools

Your unit comes with free tools such as Wireshark to help you troubleshoot networks. For more information, refer to the online help provided with these tools.

You can also purchase advanced software tools if you need more flexibility and possibilities. Online help is available from these applications to guide you.

If you want one or more of these tools to start automatically at unit startup, see *Selecting the Startup Application* on page 63.

To access tools:

1. From Mini Toolbox, select the **Test Tools** tab.
2. Tap the icon corresponding to the tool that you want to use.

6 ***Using the Optional Built-In Power Meter and VFL***

The FTB-1 can be equipped with an optical power meter to measure absolute power (dBm or W) or insertion loss (dB). The power meter can detect modulated signals (1 kHz, 2 kHz, and 270 Hz).

The FTB-1 can also include a visual fault locator (VFL) to inspect or identify fibers.

If you have purchased a module with an inline power meter, you can also take measurements with this power meter instead of using the built-in power meter.

For more information on how to use the power meter or the VFL, refer to the power meter online help.

Note: *The appearance of your application may vary depending on the options that you have purchased and the module you are using. The illustrations presented hereafter show the application as it appears when the unit is equipped with a built-in power meter, a built-in VFL, and a module with an inline power meter.*

Using the Optional Built-In Power Meter and VFL

To access the built-in power meter or the VFL:

1. From Mini Toolbox, tap **Power Meter and VFL**.

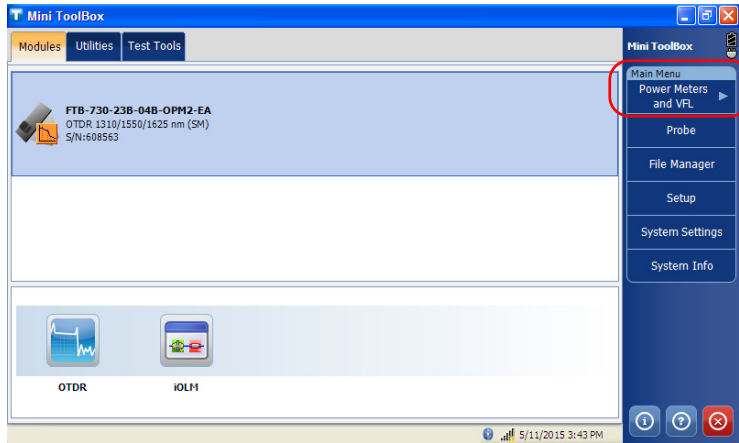

2. If the module that you are using with your platform is equipped with an inline power meter, tap the item corresponding to the power meter that you want to use.



Note: If you want to use the built-in VFL, select either **Power Meter and VFL** or **VFL**, depending on the configuration of your unit.

Note: You can access the online help of the power meter and the VFL by tapping the  button from the power meter application.

7 Inspecting Fibers with a Probe

The fiber inspection probe (FIP) is used to find dirty or damaged connectors by displaying an enlarged view of the connector surface. You can connect a probe to your unit to view fiber ends.



IMPORTANT

Only the probes of the FIP-400B series are supported on your unit.

Fiber inspections are made using the ConnectorMax2 application. For more information, refer to the ConnectorMax2 online help.

To inspect fibers with a probe:

1. Connect the probe to one of the USB ports of your unit (top panel).
2. From Mini ToolBox, tap the **Probe** button to open the application.

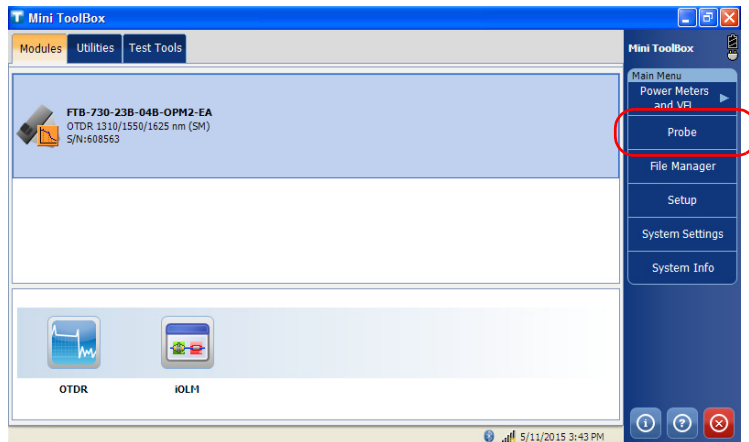

Note: You can access the online help by tapping the  button from the ConnectorMax2 application.

8 ***Managing Data***

You can copy, move, rename, delete files and folders directly on your unit.

You can transfer files from your unit to a USB memory key or a computer.

You can also transfer data from a storage device or a computer to your unit.

Your unit is equipped with the following ports and devices for data transfer:

- Two USB 2.0 ports to connect a memory key or a USB to RS-232 adapter (see *Using the USB to RS-232 Adapter* on page 130.)
- an Ethernet port to connect to a network (for transfer via VNC or Remote Desktop - see *Accessing Your Unit Remotely* on page 145)
- internal Wi-Fi device (optional) to connect to a wireless network
- internal Bluetooth device (optional) to transfer data via Bluetooth.

Managing Data

To view the free disk space on your unit:

1. From **Main Menu**, tap **System Info**.
2. Select **Platform**.

The free disk space is displayed next to the **Available Flash on “D:\ (APP)”** item.

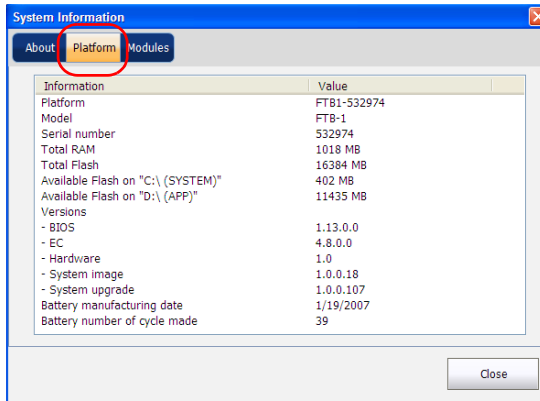

3. When you have finished, tap **OK** to close **System Information**.

To manage files or folders on your unit only:

From **Main Menu**, select **File Manager**.

To transfer files or folders between your unit and a USB memory key:

- 1.** Connect the USB memory key to the USB port.
- 2.** From **Main Menu**, select **File Manager**.

The list of available drives and folders should include the memory key (**Removable Disk**). You can now manage your files and folders as you wish.

Note: *If you do not see the memory key, close File Manager and reopen it. You can also use the **Refresh** option from the **View** menu.*

- 3.** When you have finished, remove the memory drive.

Transferring Data via Bluetooth

If your unit is equipped with the optional Bluetooth device (internal), you can transfer data between your unit and a computer using the Bluetooth technology. By default, both the Bluetooth and Wi-Fi devices are enabled, but not connected to a network.

If you have disabled the devices, you must enable them before trying to transfer data via Bluetooth (see *Enabling or Disabling the Bluetooth and Wi-Fi Devices* on page 135).

The computer that you use must run Windows XP SP3 or later; otherwise, there could be problems during data transfer. The computer must also be equipped with a Bluetooth device and be configured properly.

Note: *If you prefer to use devices such as BlackBerry smartphones instead of a computer for data transfer, you must ensure that they are Bluetooth-compatible and configured properly. Some devices only allow data transfer between devices of the same make. In this case, you will need to use another type of device or a standard computer to transfer data from your FTB-1 unit.*

Your unit must be located within a 9-meter area from your computer (limitation of the Bluetooth technology).

If you need to transfer large files (more than 1 Gb), use a USB key, or connect to a Wi-Fi or an Ethernet network.

The procedure presented hereafter explains how to transfer data from your unit to a computer. Data transfer from the computer to your unit is similar, except that data will be sent using the Bluetooth Transfer Wizard of the computer (*Send a file* option) and received by the unit (*Receive a file* option).

To transfer data via Bluetooth:

- 1.** Configure your unit as follows:
 - 1a.** From the **Main Menu**, tap **Setup**.
 - 1b.** Double-tap **Bluetooth Devices**.

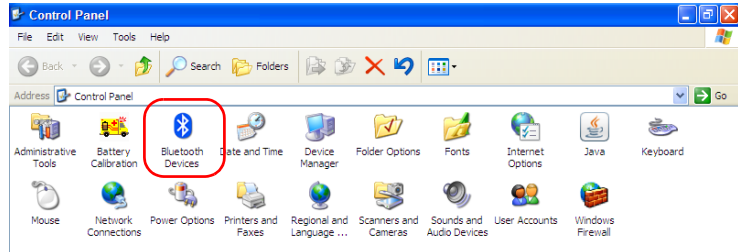

- 1c.** From the **Options** tab, under **Discovery**, select the **Turn discovery on** check box.

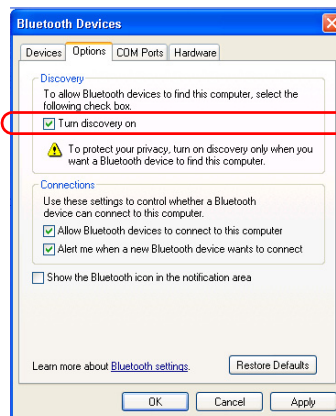

- 1d.** Ensure that the **Allow Bluetooth devices to connect to this computer** check box is selected.
- 1e.** Tap **OK** to confirm.

Managing Data

Transferring Data via Bluetooth

2. Configure the computer as follows:
 - 2a. On the computer, from **Control Panel**, double-click **Bluetooth Devices**.
 - 2b. From the **Options** tab, under **Discovery**, select the **Turn discovery on** check box.
 - 2c. Ensure that the **Allow Bluetooth devices to connect to this computer** check box is selected.
 - 2d. Tap **OK** to confirm.
3. On the computer, click the Bluetooth icon (located on the taskbar) and select **Receive a file**.
4. On your unit, from Mini ToolBox, select the **Utilities** tab.

5. Tap Bluetooth File Transfer Wizard.

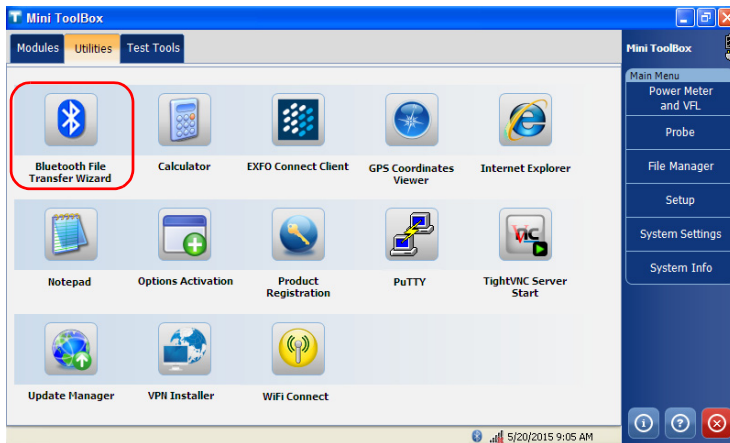

6. From the Welcome window, tap Next.

7. Select Send a file and tap Next.

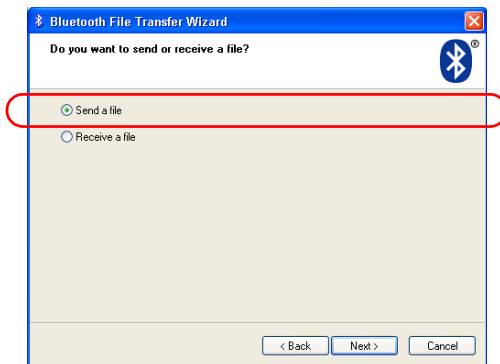

Managing Data

Transferring Data via Bluetooth

8. Select the computer to which you want to transfer data as follows:

8a. Tap **Browse**.

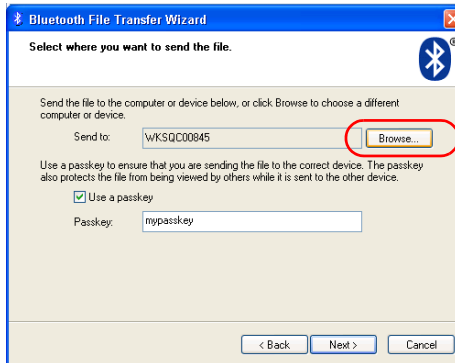

8b. Select the desired computer, and then tap **OK** to confirm.

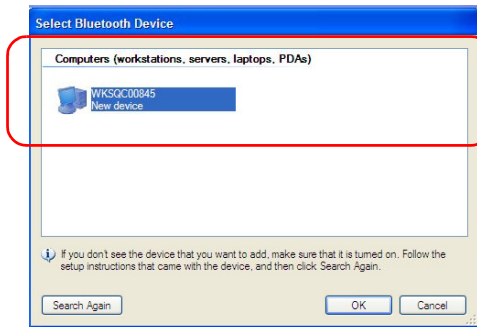

9. If you want to use a passkey, select the corresponding check box and enter the passkey.

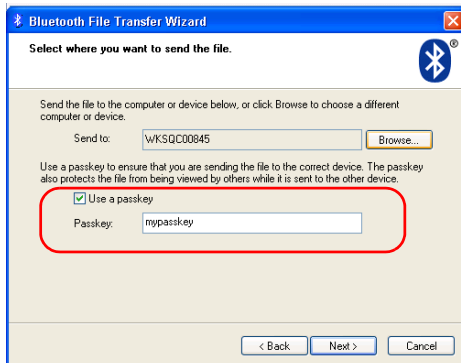

When you have finished, tap **Next**.

10. Tap **Browse** to select the file that you want to send to the computer.

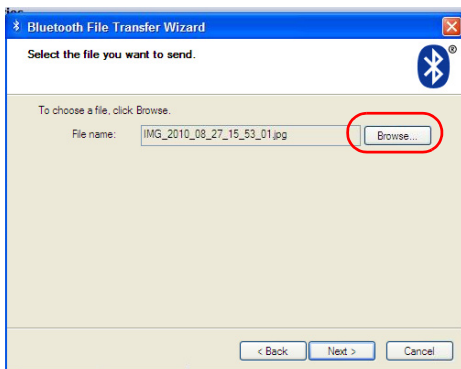

11. Select the file, tap **Open** to confirm, and then **Next**.

Managing Data

Transferring Data via Bluetooth

- 12.** On the computer, when the application prompts you, allow the connection and enter the passkey if necessary.

Note: *Once you have established a secured connection using a passkey, this passkey is kept in memory both on your unit and on the computer until you remove this connection (**Setup** > **Bluetooth Devices** > **Devices**) or change the passkey.*

- 13.** On the computer, click **Finish**.
- 14.** From the Bluetooth File Transfer Wizard on your computer, if necessary, modify the name of the received file and the storage location. Click **Next** to save the file. Click **Finish** to close the wizard.
- 15.** On your unit, tap **Finish** to close the Bluetooth File Transfer Wizard.

Connecting to a Wireless Network

If your unit is equipped with the optional Wi-Fi device (internal), you can connect to a wireless network and benefit from all resources that are available on this network. You can transfer data exactly as you would do from an Ethernet network. By default, both the Bluetooth and Wi-Fi devices are enabled, but not connected to a network.

If you have disabled the devices, you must enable them before trying to connect to a wireless network (see *Enabling or Disabling the Bluetooth and Wi-Fi Devices* on page 135).

To connect to a wireless network:

1. If it is not already done, share all the required folders both on your unit and on your computer. If you are not sure on how to proceed, contact your network administrator.
2. If it is not already done, configure the firewall as follows:
 - 2a. From **Main Menu**, tap **Setup**.
 - 2b. Double-tap **Windows Firewall**.

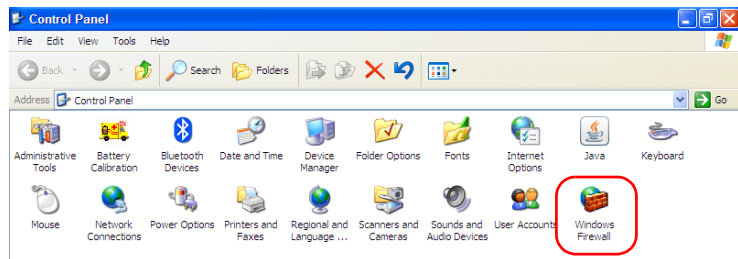

- 2c. Select the **Exceptions** tab.

Managing Data

Connecting to a Wireless Network

- 2d.** Ensure that the **File and Printer Sharing** item is selected.

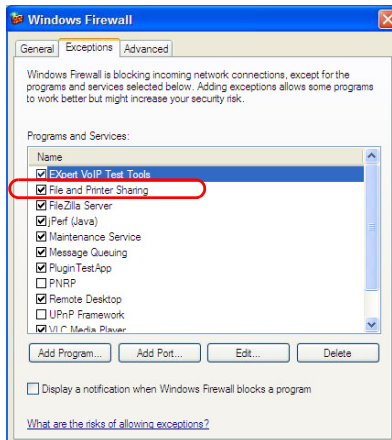

- 2e.** Tap **OK** to confirm.
- 3.** On your unit, from Mini ToolBox, select the **Utilities** tab.
- 4.** Tap **WiFi Connect**.

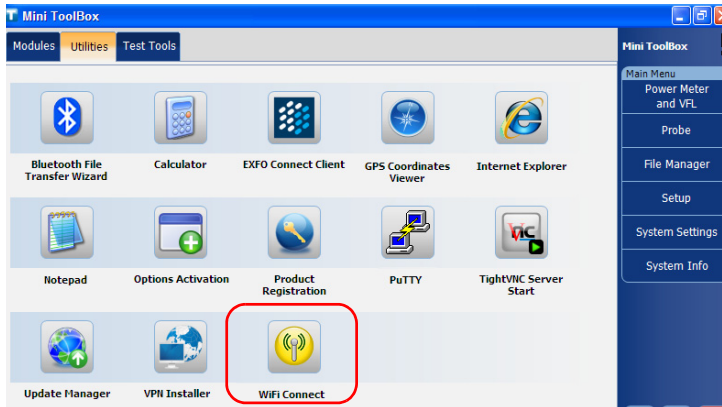

- 5.** Tap **OK** to acknowledge the message on how to display the list of wireless networks.

6. Double-tap **Wireless Network Connection**.

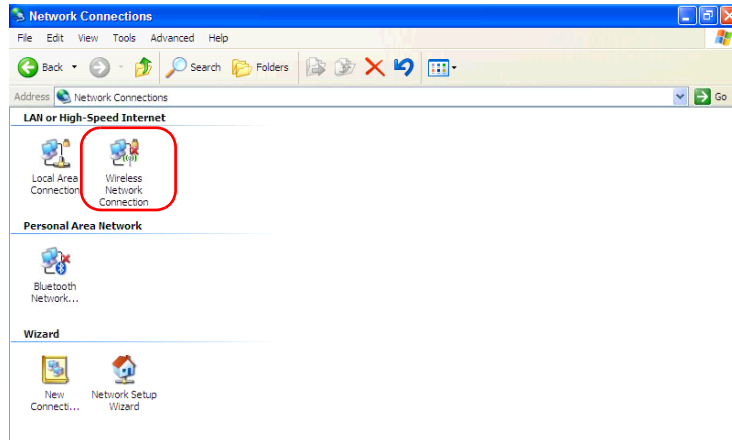

7. If your unit is already connected to a wireless network, tap **View Wireless Networks** to display the list of wireless networks.

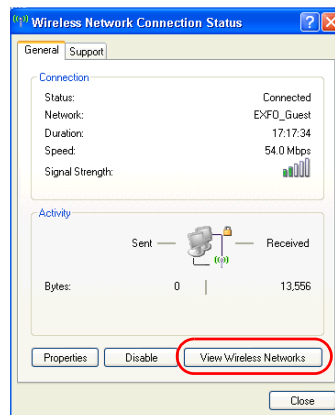

Managing Data

Connecting to a Wireless Network

- From the **Wireless Network Connection** window, select the wireless network to which you want to connect.

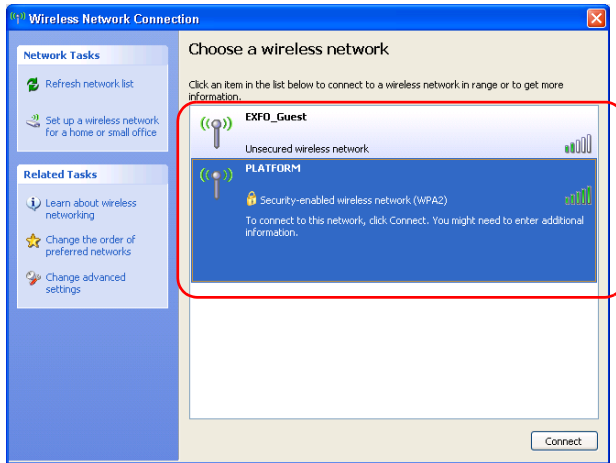

- Tap **Connect**.

- 10.** If the network is protected by a network key (password) enter it in the corresponding boxes and tap **Connect**.

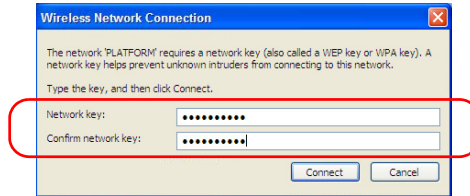

Note: *Since all networks are different, you may also need to configure other parameters before being able to transfer data via Wi-Fi. For information on the configuration specific to your network, contact your network administrator.*

As soon as the connection is established, you can start working with the selected wireless network. When you have finished, from the **Wireless Network Connection** window, tap **Disconnect** to stop communication with the wireless network.

Using the USB to RS-232 Adapter

If you want to transfer data between your unit and a device that is only equipped with RS-232 (serial) ports, you have to use a USB/RS-232 adapter.



IMPORTANT

Only the USB/RS-232 adapters sold by EXFO are supported.

Once the adapter has been detected, the unit assigns it a COM port number (values begin at COM 3). This COM port number is kept in memory even when you turn the unit off. This means that next time you connect the same adapter to any of the USB ports, the unit will recognize the adapter and identify it with the saved COM port number.

The communication between your unit and the device is established using the PuTTY application.

To use the USB/RS-232 adapter:

1. Turn on both the unit and the serial device.
2. Connect as shown. You can connect the USB end of the adapter to any of the USB ports.

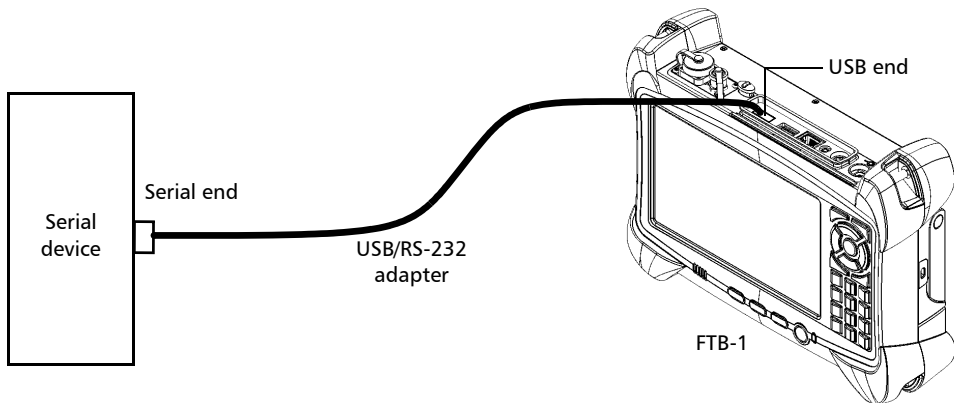

Note: *If the device that you want to use is a computer (not equipped with USB ports) you may want to use a null-modem serial cable as an “extension cable” between the device and the USB/RS-232 adapter.*

The adapter will be detected automatically on your unit.

Managing Data

Using the USB to RS-232 Adapter

3. From your unit, retrieve the COM port of the adapter as follows:
 - 3a. On your unit, from the **Main Menu**, select **Setup**.
 - 3b. Double-tap **Device Manager**.

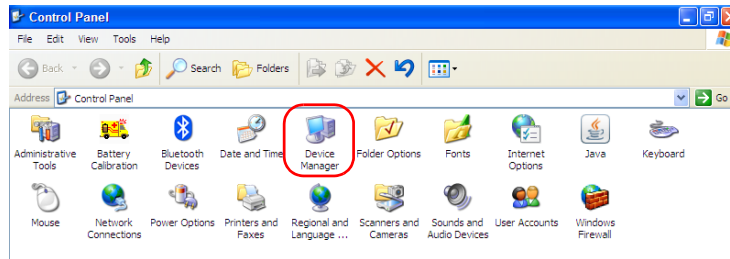

- 3c. Expand the **Ports (COM & LPT)** list to retrieve the COM port number that has been assigned to the adapter and write it down.

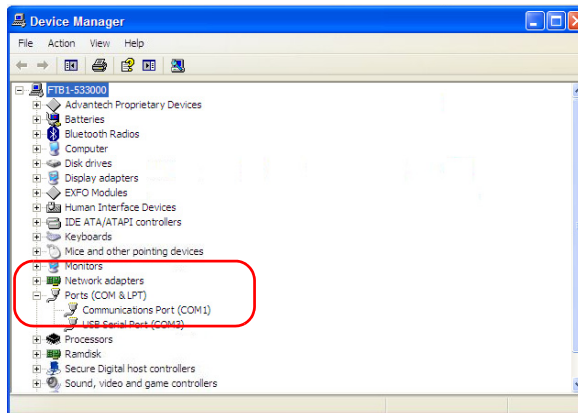

- 3d. Close the *Device Manager*.

4. From your unit, configure the communication parameters as follows:
 - 4a. On your unit, from Mini ToolBox, select the **Utilities** tab, then tap **PuTTY**.
 - 4b. Configure the parameters.

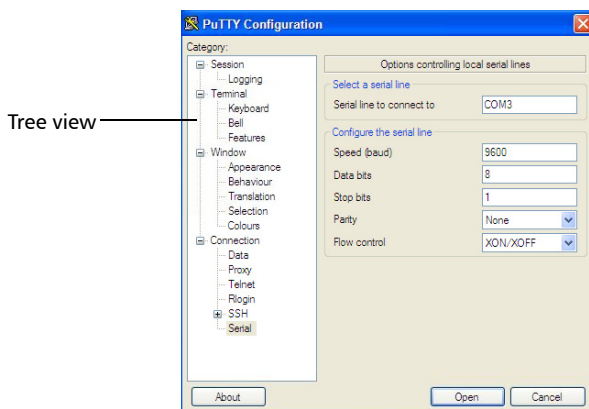

- From the tree view, select **Connection** > **Serial** and set the parameters as needed. Ensure that the COM port that you specify corresponds to the one that you wrote down at step 3c.
 - If you want to view the characters that you type on screen, from the tree view, select **Terminal**. Under **Local echo**, set the value to **Force on**.
 - From the tree view, select **Session**. Select **Serial**. The COM port number and the speed should correspond to those that you have previously entered.
- 4c. Tap **Open**. The unit is now ready to receive or send data.

Managing Data

Using the USB to RS-232 Adapter

5. From the device, set the communications parameters.



IMPORTANT

To be able to establish a communication between the unit and the device, you must set the following parameters to the same values as those defined on your unit:

- Speed
- Data bits
- Stop bit
- Parity
- Flow control

Note: *The COM port number that you set on your device will probably differ from the one that you used on your unit.*

6. From the device, establish communication with the unit using your favorite communication tool (PuTTY, HyperTerminal, etc.).

Enabling or Disabling the Bluetooth and Wi-Fi Devices

By default, both the Wi-Fi and Bluetooth devices are enabled on units that are equipped with the corresponding options.

If you do not intend to transfer files via Bluetooth or to work with a wireless network for a certain period of time, you may wish to disable the devices to extend battery life.

As soon as you disable the Wi-Fi device, the Bluetooth is automatically disabled as well.

You can enable the devices again at any time.

To enable or disable the Bluetooth and Wi-Fi devices:

- 1.** From the **Main Menu**, tap **Setup**.
- 2.** Double-tap **Network Connections**.

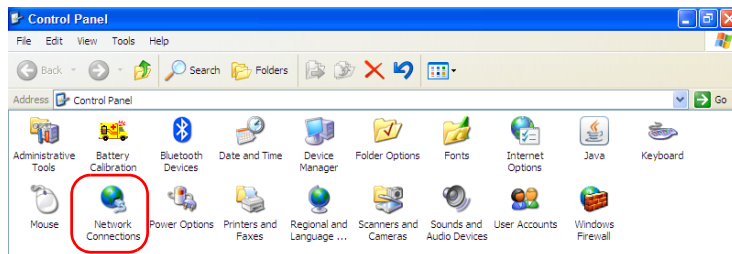

Managing Data

Enabling or Disabling the Bluetooth and Wi-Fi Devices

3. Select **Wireless Network Connection**.

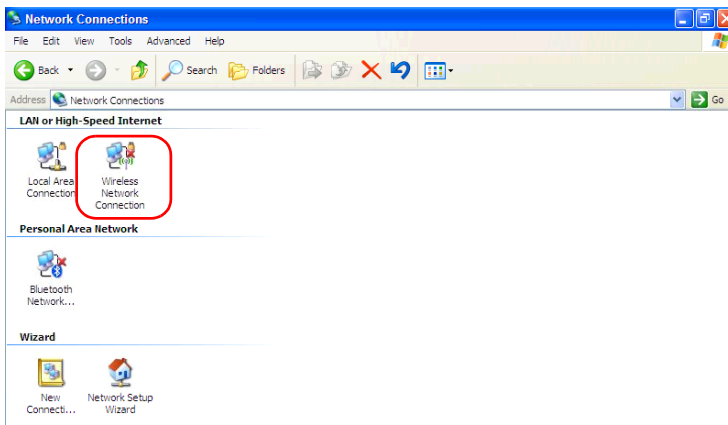

4. From the **File** menu, select **Enable** or **Disable**, according to your needs.

Connecting to a VPN from Your Unit

Note: *Only administrator-level users can install software under Windows Embedded Standard. However, when the installation is complete, all users will have the possibility to connect to a VPN from the unit.*

You can connect to a Virtual Private Network (VPN) from your unit if you install one of the supported VPN clients (applications). Such clients allow you to connect to the VPN of your company from anywhere in the world and have access to network resources as if your unit was connected locally to the network. This could be useful if you need to transfer data to a centralized folder on the company's private network, for example.

To establish the communication between the VPN client and the VPN server, you can use either a Wi-Fi connection (see *Connecting to a Wireless Network* on page 125), a 3G USB modem key (see *Accessing the Internet with a 3G USB Modem Key* on page 104), or a standard Ethernet connection.

Note: *Since all networks are different, the parameters that you need to configure before being able to connect to the VPN may vary. For information on the configuration specific to your network, contact your network administrator.*

If you ever need to change to another VPN client or remove it, see *Solving Common Problems* on page 183.

Managing Data

Connecting to a VPN from Your Unit



IMPORTANT

EXFO does not provide any VPN clients. You must provide the installation files for one of the supported VPN clients yourself. The complete list is available from the VPN Installer application.

EXFO cannot guarantee that any VPN client other than those listed will work properly on your unit.

To retrieve the list of supported VPN clients:

1. On your unit, from Mini ToolBox, select the **Utilities** tab.
2. Tap **VPN Installer**.
3. From the VPN Installer first window, tap **Continue**.

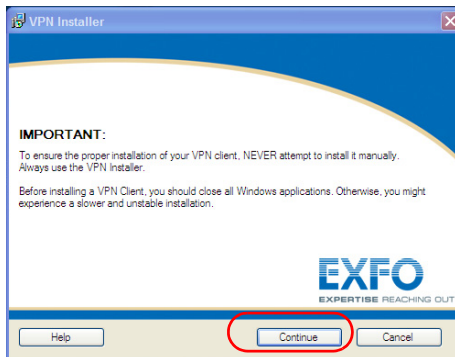

4. All the supported VPN clients appear on the **Supported software and versions** list. You can write down this list and contact your network administrator to get the installation files.

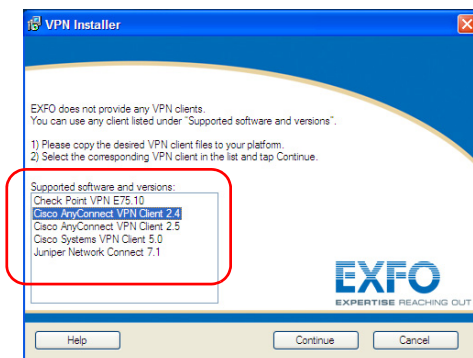

5. Tap **Cancel** to close the VPN Installer.

You are ready to go to the procedure explaining how to install the VPN client on your unit.

Managing Data

Connecting to a VPN from Your Unit



CAUTION

- To ensure the proper installation of your VPN client, **NEVER** attempt to install it manually. Always use the VPN Installer.
- **DO NOT** restart your unit during the installation even if you are prompted to do so. Otherwise, the VPN client will not be installed properly. The EXFO VPN Installer will restart your unit automatically to complete the installation. If you updated the VPN client by mistake, see *Solving Common Problems* on page 183.
- Your unit has been designed to work with specific versions of VPN clients. **NEVER UPDATE** the VPN client manually and ensure that the VPN server will not update the client either. Otherwise, the VPN client may no longer work properly.



IMPORTANT

EXFO does not recommend to install more than one VPN client on a single FTB-1 unit.



IMPORTANT

To avoid communication problems between the VPN client and the VPN server, ensure that the date set on your unit corresponds to the current date.

To install a VPN client on your unit:

1. If the date on your unit does not correspond to the current date, modify it (see *Adjusting the Date, Time and Time Zone* on page 76).
2. Retrieve the installation files on your unit as follows:
 - 2a. On your unit, create a folder on the Windows desktop.
 - 2b. Copy the installation files (from a USB key or a folder network) to the newly created folder.
3. On your unit, from Mini ToolBox, select the **Utilities** tab.
4. Tap **VPN Installer**.

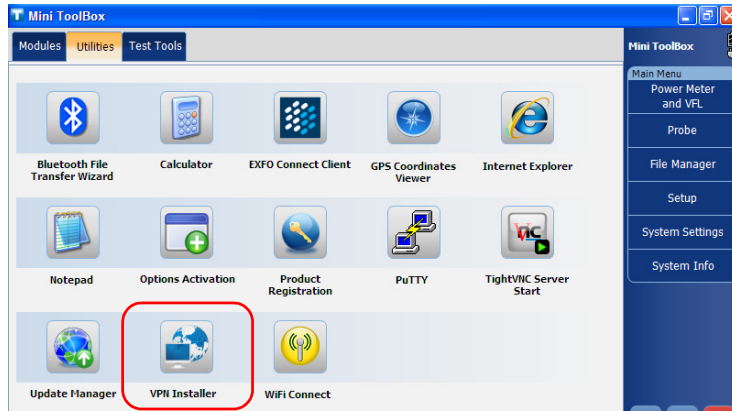

Managing Data

Connecting to a VPN from Your Unit

- From the VPN Installer first window, read the information. When you have finished, tap **Continue**.

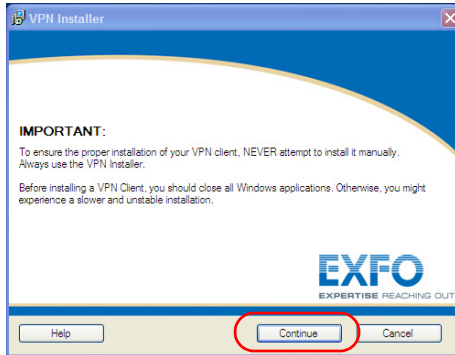

- From the **Supported software and versions** list, select the entry corresponding to the VPN client for which you have retrieved installation files at step 2.

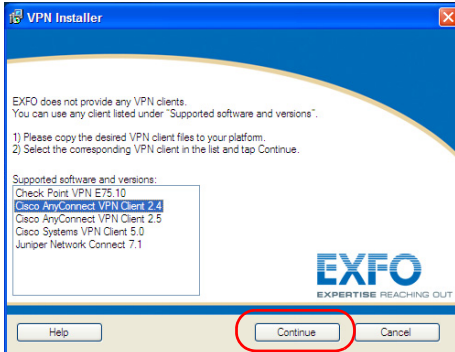

Tap **Continue**.

- From the VPN Installer, select the corresponding setup file using the **Browse** button.



IMPORTANT

To avoid installation problems, ensure that the installation files are available from the Windows desktop of your unit. Never use installation files directly from a USB key.

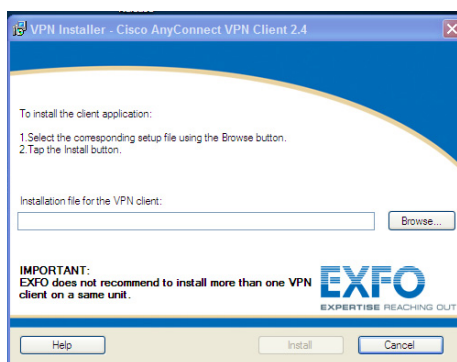

Note: Depending on the VPN client that you have selected previously, you may have two installation files to select (two **Browse** buttons instead of one). For more information, refer to the online help provided with the VPN Installer.

- Tap the **Install** button.
- Follow the on-screen instructions.

Your unit will restart automatically to complete the installation of the VPN client. All users will now be able to connect to a VPN from the unit.

To connect to a VPN from your unit:

Start the VPN client and follow the on-screen instructions.

If you are not sure about the information that you should provide, contact your network administrator.

9 **Accessing Your Unit Remotely**

You can access your unit remotely from a computer using either the Remote Desktop Connection or TightVNC Client applications.

The table below presents the differences between the two applications.

Characteristic	Remote Desktop Connection	TightVNC Client
Type of connection	Direct between the unit and the computer; only one user can be connected to the unit at a time.	Not exclusive; several users can be connected to the unit at the same time (sharing the same session).
Windows user rights	Taken into account.	Not taken into account.
Password-protected	Yes; mandatory. The user name and password are the same as those used to connect to the unit. By default, all the accounts with administrator rights can use Remote Desktop Connection. If you want accounts with limited rights to be able to use Remote Desktop as well, you must specifically grant them access.	Yes; mandatory. The password is defined on the TightVNC Server, the first time you start the server. This password is not related to the one used to connect to the unit. By default, all people that use TightVNC Client will enter the same password (as defined on the server). Each user to whom you provide the password will be able to connect to the unit via TightVNC.

Working with Remote Desktop

By default, all the accounts with administrator rights can use Remote Desktop. If you want accounts with limited rights to be able to use Remote Desktop as well, you must specifically grant them access.

You can also configure the unit to prevent users from accessing it remotely.

Accessing Your Unit with Remote Desktop

To be able to connect to the unit using Remote Desktop, you must:

- Know the IP address of the unit and provide it in the connection settings on the computer.
- Use an account that is secured by a password. Remote Desktop will not allow any connection with empty passwords.
- Enter the appropriate user name when Remote Desktop application prompts you. Usually, this user name must correspond to the user name of the person currently logged on the unit. Otherwise, you will disconnect the person that was already connected.

To access your unit remotely with Remote Desktop:

1. Connect both the computer and your unit to the same network and make sure they can “see” each other as network restrictions might prevent them from communicating.
 - If you want to use an Ethernet network, connect an RJ-45 (network) cable to the unit’s RJ-45 port located on its top panel.
 - If you want to use a wireless network, see *Connecting to a Wireless Network* on page 125.
 - You could also create a Private Area Network with your Bluetooth device (contact your network administrator).
2. Turn on both the computer and the unit.
3. On your unit, in Mini Toolbox, go to **Main Menu**. Select **System Info > Platform**.
4. Write down the IP address, and then close the window.

Note: *It may take a few seconds before you see the IP address on the list.*

5. From the computer, on the taskbar, click **Start**, then select **All Programs > Accessories > Remote Desktop Connection**.

Accessing Your Unit Remotely

Working with Remote Desktop

6. In the **Connecting to Remote Desktop** window, in the **Computer** list, type the IP address of the unit that you wrote down at step 4.

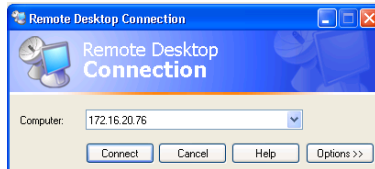

7. Click **Connect**.
8. When the application prompts you, enter your user name and password.



9. Click **OK** to open the session.

Allowing Users with Limited Accounts to Use Remote Desktop

By default, only the accounts with administrator rights can use Remote Desktop. However, you can assign extra user rights to accounts with limited rights so that they can also use Remote Desktop.

To allow a user with limited accounts to use Remote Desktop:

1. On your unit, from the **Main Menu**, select **System Settings**.
2. From **System Settings**, tap **Remote Session**.

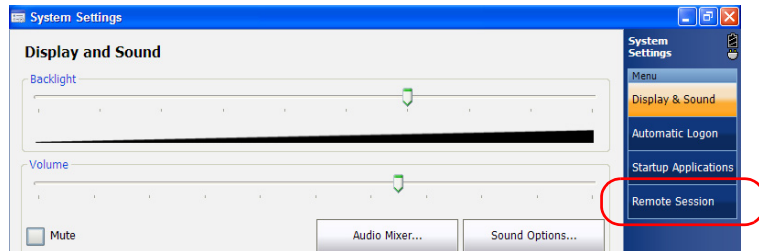

3. Ensure that **Allow remote connections to this unit (from computer using Remote Desktop client application)** is selected.

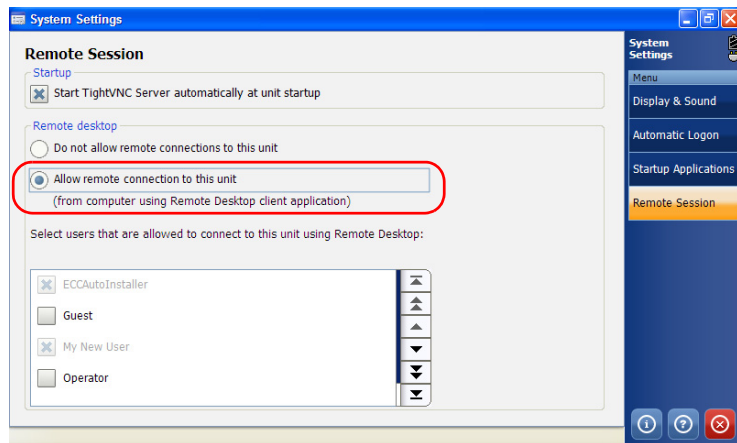

4. From the list of users, select the boxes corresponding to the users to whom you want to grant access.
5. Tap  to return to the Mini Toolbox window.

Preventing Users from Connecting with Remote Desktop

You can also configure the unit to prevent users to access it using Remote Desktop. However, all users having administrator user rights will be able to modify this setting at any time.

To prevent users from connecting to the unit using Remote Desktop:

1. On your unit, from the **Main Menu**, select **System Settings**.
2. From **System Settings**, tap **Remote Session**.

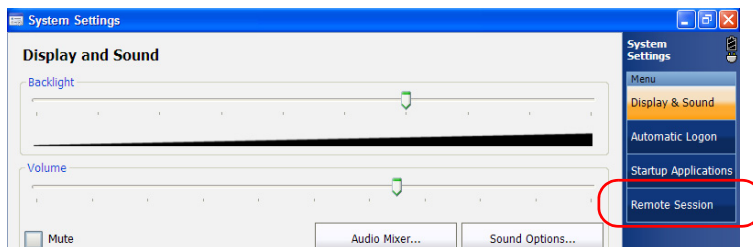

3. Select the **Do not allow remote connections to this unit** option.

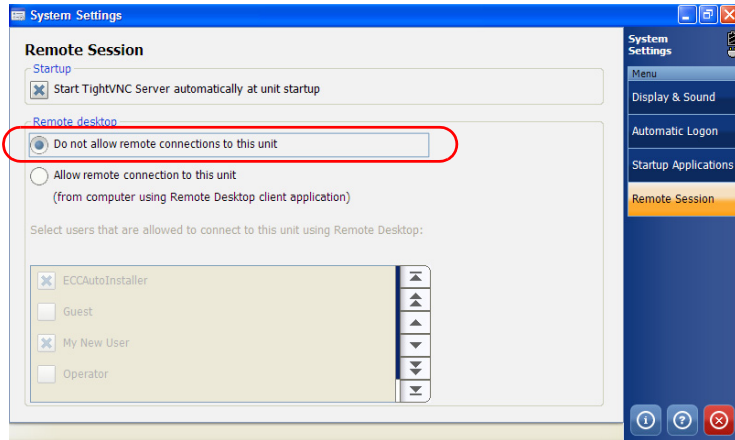

4. Tap  to return to the Mini Toolbox window.

Restarting or Turning Off Your Unit While Working with Remote Desktop

In some cases, you may need to restart or shutdown your unit while you are controlling it remotely.

To restart or turn off your unit with Remote Desktop:

1. Close all applications, including Mini Toolbox.
2. On the taskbar, click **Start**, then select **Run**.
3. If you want to restart your unit, in the **Open** box, enter *Shutdown -r*.

OR

If you want to turn off your unit, in the **Open** box, enter *Shutdown -s*.

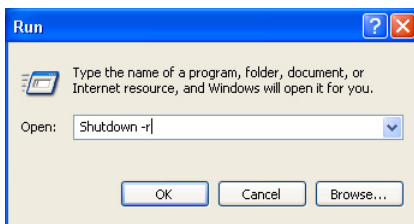

Working With TightVNC

The control of your unit with TightVNC requires the TightVNC Server (already installed on your unit) and the TightVNC Client Viewer (that you must install on your computer).

The first time you start the TightVNC Server on your unit, the application will prompt you to define passwords. Once these passwords are defined, you are now ready to connect to your unit using the TightVNC Client (on your computer).

If you want TightVNC Server to start automatically when you turn on your unit, see *Configuring TightVNC Server to Start Automatically* on page 160.



IMPORTANT

The passwords that you set for the application that is started automatically are independent of the passwords that you set for the application that you start manually (via the Utilities tab). This means that you could need to enter different passwords, depending on which TightVNC application you use to connect to your unit.

If you do not want to manage two different sets of passwords, you can set all passwords to the same value.



CAUTION

Be very careful if you use TightVNC to transfer files between a computer and your unit (TightVNC Server).

- *Transfer from a computer to your unit:* If the transfer is interrupted, all files on your unit having the same name as those on the computer **WILL BE DELETED**. However, the files on the computer will remain available.
- *Transfer from your unit to a computer:* If the transfer is interrupted, all files on the computer having the same name as those on your unit **WILL BE DELETED**. However, the files on your unit will remain available.

To be able to connect to the unit using TightVNC, you must:

- Know the IP address of the unit and provide it in the connection settings on the computer.
- Know the password (same for all users by default).

This section provides you with the basic information to control your unit with TightVNC. For more information, refer to the TightVNC online help.

Configuring the TightVNC Server

The TightVNC Server is already installed on your unit. You must configure passwords before establishing a connection between a computer and your unit.

To configure the TightVNC Server:

1. If you have configured TightVNC Server to start automatically when you turn on your unit, go directly to step 2. Otherwise, from Mini Toolbox, select the **Utilities** tab, then tap **TightVNC Server Start**.

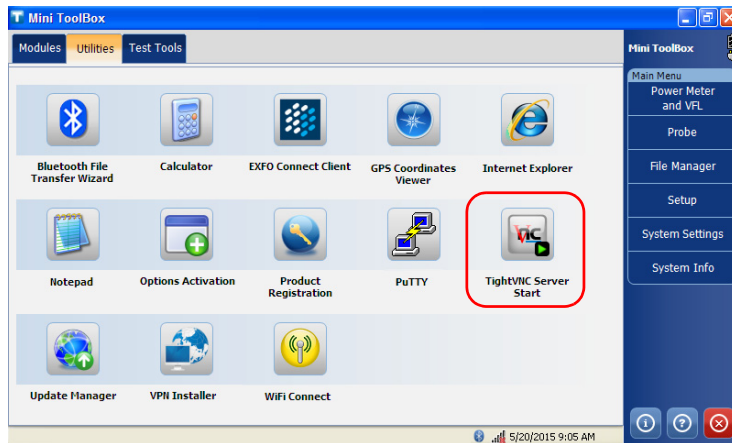

2. Select the **Server** tab.

Accessing Your Unit Remotely

Working With TightVNC

3. In the **Primary password** and **View-only password** boxes, type the desired passwords.

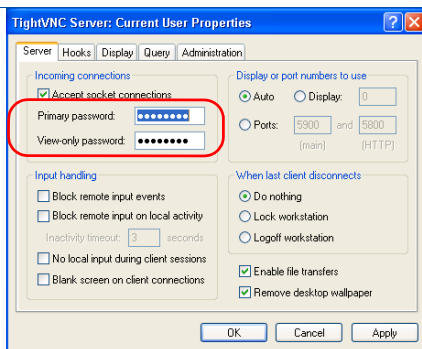

Note: *The two passwords are independent of each other. They do not have to be identical.*

4. Tap **Apply**, and then **OK**.

Installing the TightVNC Viewer on a Client Computer

If the TightVNC Viewer is not already installed on your computer, you can download it from the Web for free.



IMPORTANT

EXFO does not provide licenses for TightVNC Viewer. Always ensure that you are entitled to install it on your computer.

To install the TightVNC Viewer on your computer:

1. Open a Web browser and go to <http://www.tightvnc.com/>.
2. Download the version of the viewer that corresponds to the operating system that your computer is running.
3. Double-click the file that you have just downloaded to start the installation.
4. Follow the on-screen instructions.

Connecting to Your Unit with TightVNC

Once the TightVNC Viewer is installed on your computer, you are ready to access your unit remotely.

To connect to your unit with TightVNC:

1. Connect both the computer and your unit to the same network and make sure they can “see” each other as network restrictions might prevent them from communicating.
 - If you want to use an Ethernet network, connect an RJ-45 (network) cable to the unit’s RJ-45 port located on its top panel.
 - If you want to use a wireless network, see *Connecting to a Wireless Network* on page 125.
 - You can also create a Private Area Network with your Bluetooth device (see *Transferring Data via Bluetooth* on page 118).
2. Turn on both the computer and the unit.
3. On your unit, in Mini Toolbox, go to **Main Menu**. Select **System Info > Platform**.
4. Write down the IP address, and then close the window.

Note: *It may take a few seconds before you see the IP address on the list.*

5. If you have configured TightVNC Server to start automatically when you turn on your unit, go directly to step 6. Otherwise, from Mini Toolbox, select the **Utilities** tab, then tap **TightVNC Server Start**.

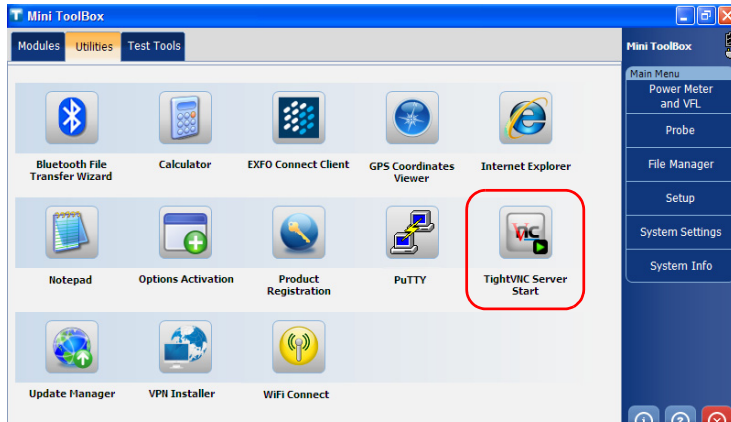

6. From your computer, double-click the TightVNC Viewer shortcut on your desktop.
7. In the **VNC Server** list, type the IP address of your unit that you wrote down at step 4.

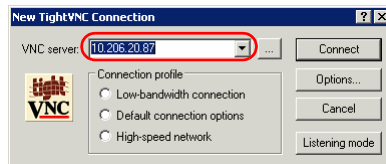

8. Click **Connect**.

Configuring TightVNC Server to Start Automatically

Note: Only administrator-level users can configure the TightVNC Server to start automatically.

By default, the TightVNC Server is not started automatically when you turn on your unit. However, you can modify this setting. This is especially useful if you need to remotely connect to your unit without having the unit close at hand. To benefit from all the advantages of this feature, you may also want to enable the automatic logon (see *Enabling or Disabling the Automatic Logon* on page 60). Otherwise, you will need to manually connect to a user account before the TightVNC Server could be started.



IMPORTANT

The passwords that you set for the application that is started automatically are independent of the passwords that you set for the application that you start manually (via the Utilities tab). This means that you could need to enter different passwords, depending on which TightVNC application you use to connect to your unit.

If you do not want to manage two different sets of passwords, you can set all passwords to the same value.

To configure TightVNC server to start automatically:

1. On your unit, from the **Main Menu**, select **System Settings**.
2. Tap **Remote Session**.

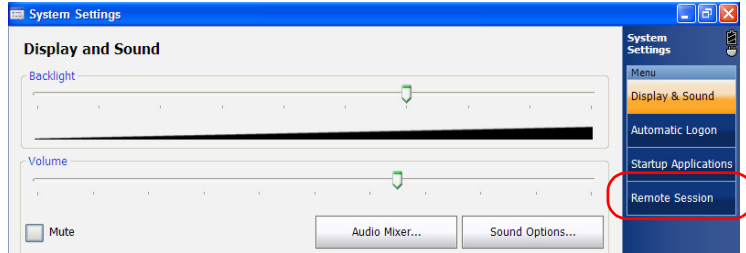

3. Select the **Start TightVNC Server automatically at unit startup** check box.

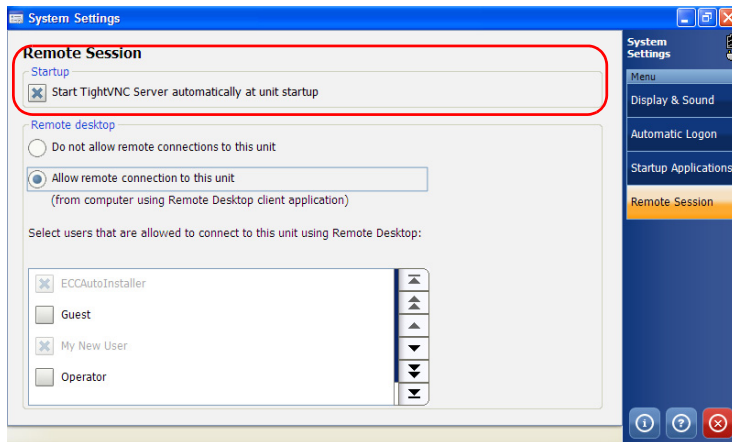

4. When the unit prompts you, tap **Yes** to configure the TightVNC passwords (and other parameters) if necessary.

The new parameters are now taken into account. For more information on how to connect to your unit, see *Connecting to Your Unit with TightVNC* on page 158.

5. Tap  to return to the Mini Toolbox window.

Adding Exceptions to the Firewall

Note: Only administrator-level users can add exceptions to the firewall.

Your unit is protected by the Microsoft firewall to prevent unauthorized access when it is connected to a network or to the Internet. The firewall has been preconfigured so that all the applications that come with your unit work properly. However, you can allow other applications to access the network or the Internet by adding exceptions.

If you are not sure about how to configure the firewall, contact your network administrator.

To add exceptions to the firewall:

1. On your unit, from the **Main Menu**, tap **Setup**.
2. Double-tap **Windows Firewall**.

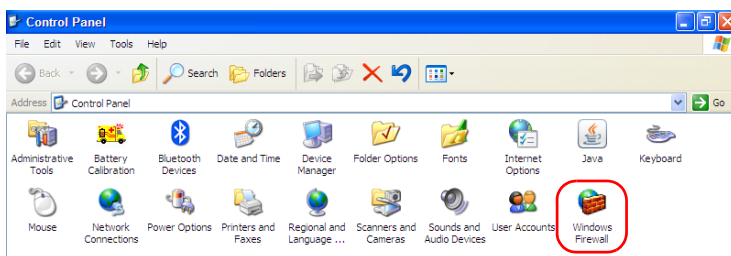

3. Select the **Exceptions** tab.

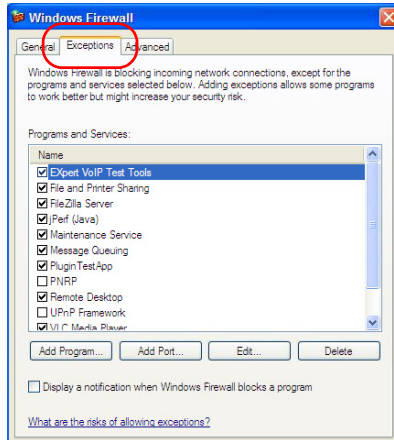

4. Tap **Add Program** to add any application that you need.
5. When you have finished, tap **OK** (located at the bottom of the dialog box) to confirm the changes and return to the **Control Panel** window.

10 Testing Network Connections

Note: This function is available with the optional IPT software package only.

The two most common basic tests widely used in networking are the *ping* test and the *trace route* test. With these tests, you can ensure that IP packets travel as expected from a local host to a remote host and vice versa.



IMPORTANT

To avoid misleading results, always ensure that your unit is only connected to one network at a time (either standard Ethernet or wireless network) before performing ping or trace route tests.

Performing a Ping Test

The ping test is a basic test that measures the average time it takes for a packet to reach the remote host. With this test, you can quickly verify that the remote host functions properly.

The ping test has six common parameters:

- The URL (IP address)
- The number of packets to send
- The packet size
- The maximum time allowed for a packet to reach the remote host
- The maximum number of hops allowed for reaching the remote host (TTL)
- A flag to indicate whether a packet can be fragmented.

When the test is complete, you can export the results. You can later import the generated text file (tab-delimited) directly into Microsoft Excel.

Testing Network Connections

Performing a Ping Test

To perform a ping test:

1. From the main window, tap **Test Tools**.
2. Tap **IP Tools**.

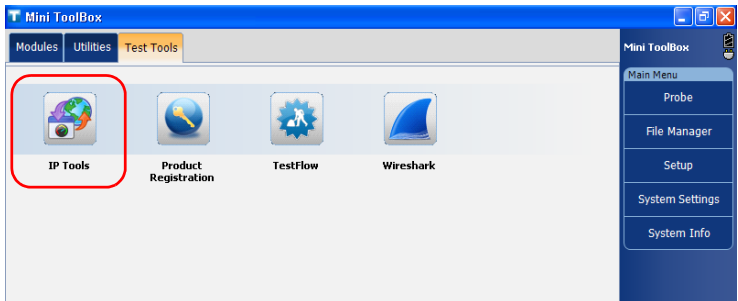

3. From **IP Testing Tools**, select the **Ping** tab.

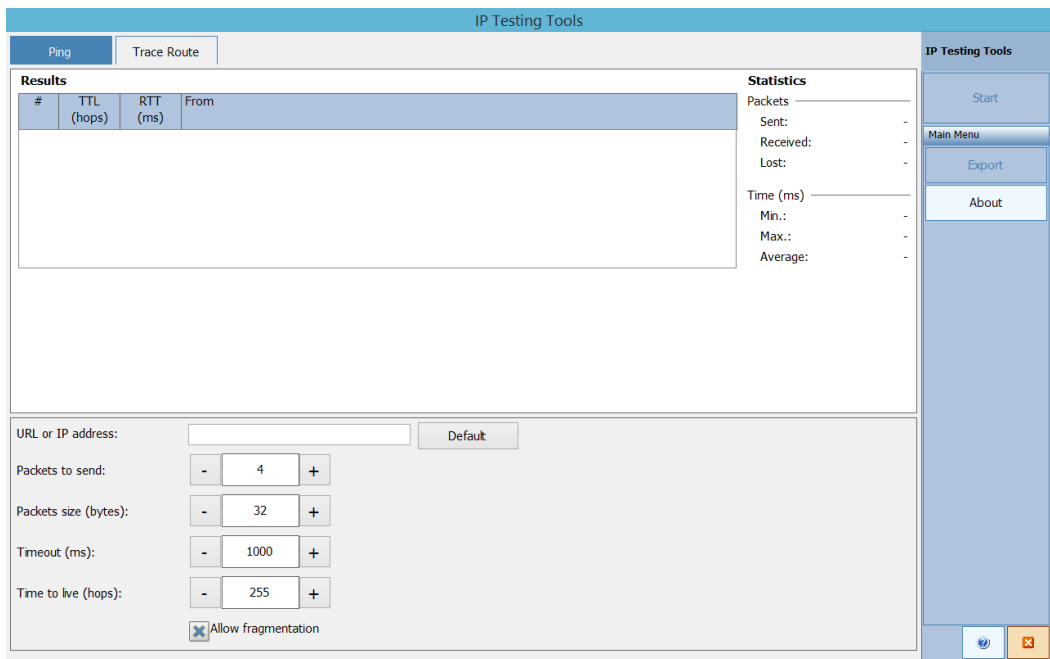

4. Enter a URL or an IP address to reach. You can tap the **Default** button to use the unit's default ping address. The default value cannot be configured.
5. Set the other parameters:
 - Number of packets to send
 - Packet size
 - Timeout limit
 - TTL limit
 - Clear the **Allow fragmentation** check box if you prefer sending complete packets to the host.
6. Tap the **Start** button.

You can stop a ping test at any time by tapping the **Stop** button.

Performing a Trace Route Test

The trace route test is used to evaluate the average number of nodes that are required to reach the final host. It is often used to troubleshoot networks (identify accesses blocked by firewalls or routing problems).

This trace route test utility enables you to:

- Enter a remote host address.
- Set the maximum time allowed for a packet to reach the remote host.
- Set the maximum number of hops allowed for reaching the remote host (TTL).
- Choose whether to resolve DNS for the IP address or not.

When the test is complete, you can export the results. You can later import the generated text file (tab-delimited) directly into Microsoft Excel.

To perform a trace route test:

1. From **IP Testing Tools**, select the **Trace Route** tab.
2. Enter an URL or an IP address to reach. You can tap the **Default** button to use the unit's default trace route address. The default value cannot be configured.

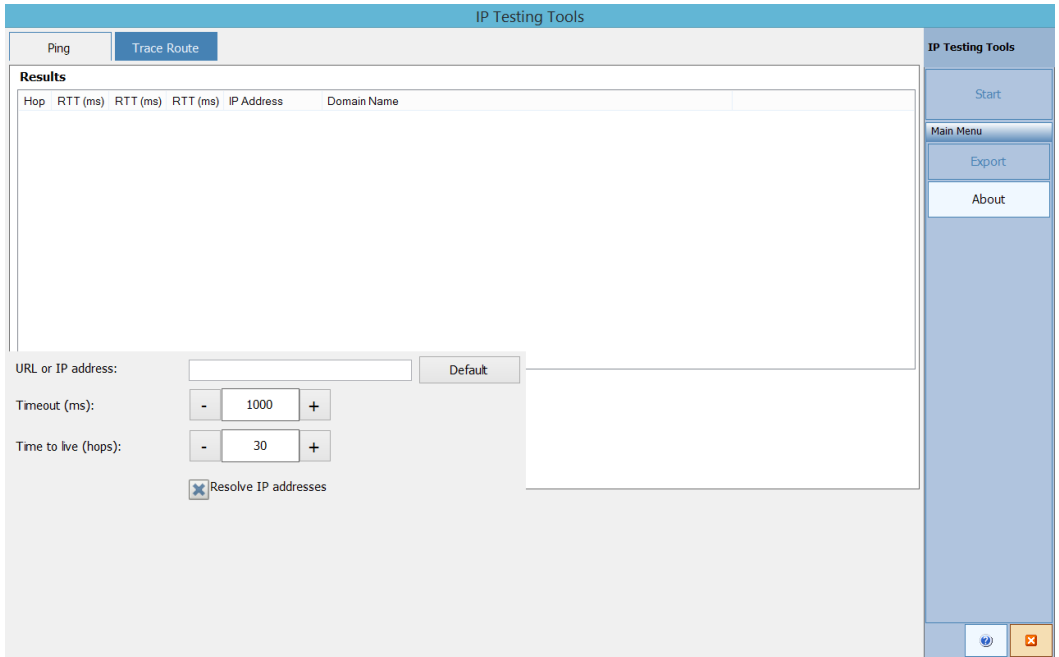

3. Set the other parameters:
 - Timeout limit
 - TTL limit
 - Select or clear the **Resolve IP addresses** check box if you want to get the host name for the corresponding IP address of nodes.
4. Tap the **Start** button.

You can stop a trace route test at any time by tapping the **Stop** button.

Exporting the Results

When a test is complete, you can export the results of the current test page. If you want to keep your results for future use, you must export them because result files cannot be opened directly from your unit.

Results are sent to a text file. Fields are separated by the “TAB” character to simplify the importation into a Microsoft Excel worksheet.

By default, the application suggests a file name:

- For ping tests:

Ping for [URL] on [YEAR]_[MONTH]_[DAY].txt

- For trace route tests:

Trace Route for [URL] on [YEAR]_[MONTH]_[DAY].txt

Where:

- [URL] is the entered URL or IP address,
- [YEAR] is the year of the test,
- [MONTH] is the month of the test,
- [DAY] is the day of the test.

Example:

For a ping test at www.yoursite.org made on July 3rd, 2014, the suggested filename would be:

Ping for www.yoursite.org on 2014_07_03.txt

To export results:

Tap the **Export** button. If necessary, modify the suggested file name.

11 Maintenance

To help ensure long, trouble-free operation:

- Always inspect fiber-optic connectors before using them and clean them if necessary.
- Keep the unit free of dust.
- Clean the unit casing and front panel with a cloth slightly dampened with water.
- Store unit at room temperature in a clean and dry area. Keep the unit out of direct sunlight.
- Avoid high humidity or significant temperature fluctuations.
- Avoid unnecessary shocks and vibrations.
- If any liquids are spilled on or into the unit, turn off the power immediately, disconnect from any external power source, remove the batteries and let the unit dry completely.



WARNING

The use of controls, adjustments and procedures, namely for operation and maintenance, other than those specified herein may result in hazardous radiation exposure or impair the protection provided by this unit.

Cleaning Detector Ports

Regular cleaning of detectors will help maintain measurement accuracy.



IMPORTANT

Always cover detectors with protective caps when unit is not in use.

To clean detector ports:

1. Remove the protective cap and adapter (FOA) from the detector.
2. If the detector is dusty, blow dry with compressed air.
3. Being careful not to touch the soft end of the swab, moisten a cleaning tip with *only one drop* of isopropyl alcohol.



IMPORTANT

Alcohol may leave traces if used abundantly. Do not use bottles that distribute too much alcohol at a time.

4. While applying light pressure (to avoid breaking the detector window), gently rotate the cleaning tip on the detector window.
5. Repeat step 4 with a dry cleaning tip or blow dry with compressed air.
6. Discard the cleaning tips after one use.

Cleaning the Touchscreen of Your FTB-1 Unit

Clean the touchscreen with a soft, non-abrasive cloth, such as one used for cleaning reading glasses, dampened with water.



CAUTION

Using anything else than water can damage the special coating of the touchscreen.

Recharging the Main Battery

The main lithium-ion battery is offered in two sizes:

- A four-cell (small) battery
- An eight-cell (large) battery

The clock battery is recharged automatically along with the main battery.

- In Mini Toolbox, the charge status is shown above **Main Menu**.
- The unit also indicates the charge status with the LED on its front panel (see *LED Indicators Description* on page 5):

Status LED	Battery Charge Status
Green	Fully charged
Green, blinking	Charging
Red	Error or battery is not in the unit



CAUTION

Only charge the battery with the AC adapter/charger (or the car outlet adapter) provided by EXFO with your unit.

Maintenance

Recharging the Main Battery



IMPORTANT

- ▶ Batteries are not charged at the factory. Install the battery compartment on your unit (see *Replacing Batteries* on page 178), and then fully charge the battery before using the unit for the first time. The battery is fully charged after a few hours or when the battery LED indicator stops flashing.
- ▶ The time required to charge batteries depends on various factors such as the type of modules currently in use and the ambient temperature.
- ▶ To ensure that batteries function or charge properly, keep them in temperatures between 10 °C and 40 °C (50 °F and 104 °F). Store below 50 °C (122 °F).
- ▶ Depending on the way the unit is used, after a while, the charge status icon may no longer correspond to the actual power level of the battery (for example, icon indicates that power level is sufficient, but unit turns off because battery is too weak). A complete calibration cycle will be necessary (see *Recalibrating the Battery* on page 175).

To recharge the main battery:

Connect the unit to a power outlet using the AC adapter/charger. The charge cycle will start and end automatically.

Recalibrating the Battery

Depending on the way the unit is used, after a while, the charge status icon may no longer correspond to the actual power level of the battery (for example, the battery level icon indicates that power level is sufficient, but unit turns off because battery is too weak). A complete calibration cycle will be necessary.



IMPORTANT

When the estimate offset value (displayed in the battery calibration application) is of 10 % or more, EXFO recommends that you recalibrate the battery.

You can perform a recalibration with the battery calibration utility:

- The utility will charge the battery until it is full.
- It will then discharge the battery completely.
- You will have to let the battery recharge completely.

The whole calibration process can take several hours. You can stop the process at any time, but the battery will still need calibration and the battery will not necessarily be full (depending on the moment at which you stop the process).

When a calibration step is underway, the LED preceding the step name appears in yellow. When a step is complete, the LED turns to green.

Maintenance

Recalibrating the Battery

To recalibrate the batteries:

1. From the **Main Menu**, select **Setup**, and then double-tap **Battery Calibration**.

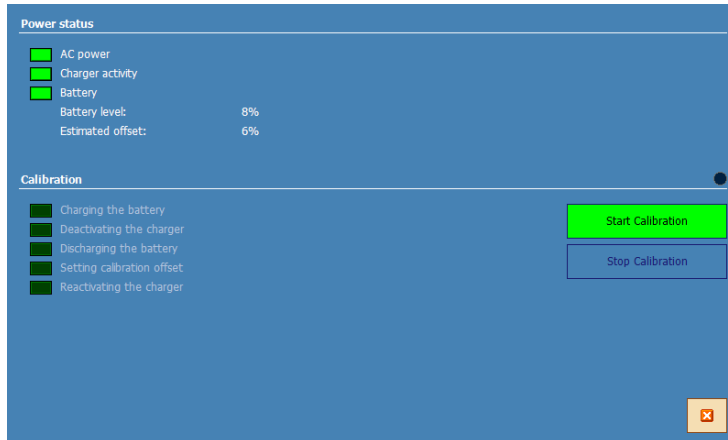

2. Connect the AC adapter/charger to your unit.

3. Tap the **Start Calibration** button (the **Stop Calibration** button will become available).

Once calibration is complete, the **Start Calibration** button becomes available again.

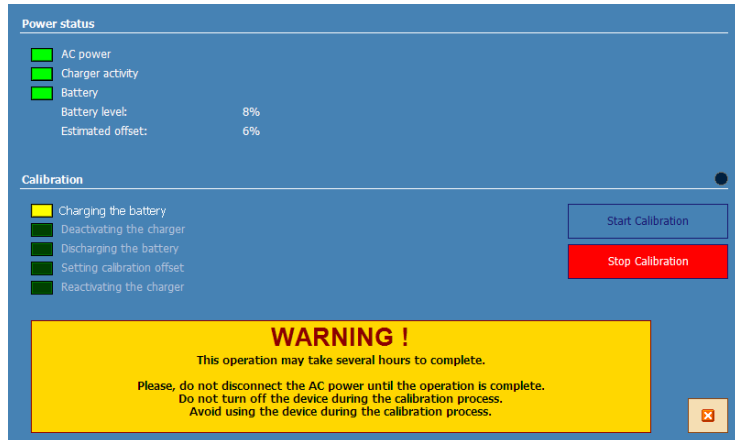

Replacing Batteries

Your unit uses batteries with built-in protection that have been especially designed for EXFO. For this reason, you can only replace the main battery with a battery designed for your FTB-1.

You can purchase new batteries and empty battery compartments (also known as “battery covers”) from EXFO.

The main lithium-ion battery is offered in two sizes:

- A four-cell (small) battery
- An eight-cell (large) battery

Note: *Since the battery must fit in the battery compartment, these compartments are also offered in two sizes.*

Note: *Batteries and battery compartments are sold separately, which means you can purchase extra batteries to use with a battery compartment that you already have. The size of the battery must match the size of the compartment.*



CAUTION

Use Li-Ion batteries of the same type and model only. Use of other batteries may damage your unit and compromise your safety.



WARNING

Do not throw batteries into fire or water and do not short-circuit the battery’s electrical contacts. Do not disassemble.

To remove the main battery:

1. Turn off the unit.
2. Remove the battery compartment (located next to the module) as follows:

- 2a.** Position the unit so that its front panel rests on a flat surface such as a table.
- 2b.** Lift the mobile part of the battery compartment screws and turn the screws counterclockwise until the compartment is loose. Since they are captive screws, you cannot remove them completely.

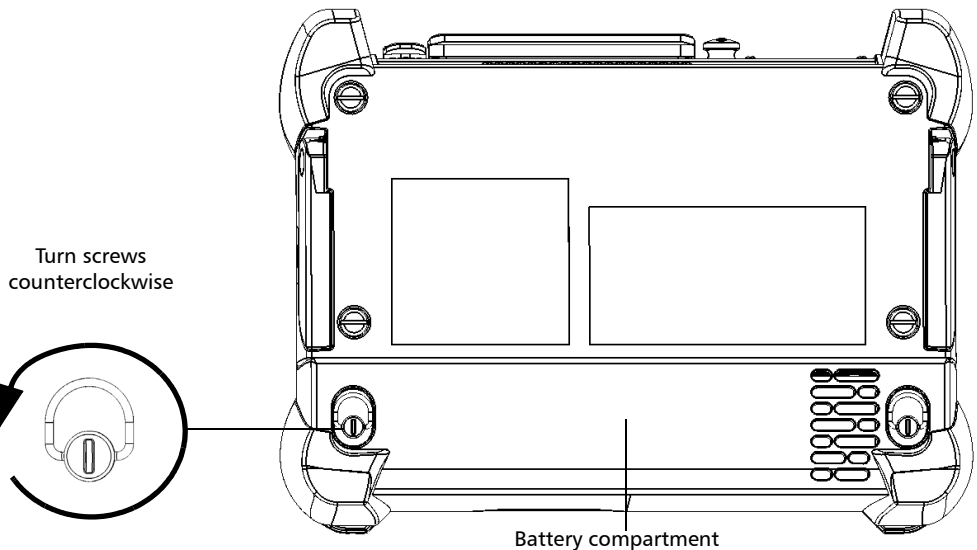

CAUTION

Shocks and drops may have loosened the battery inside its compartment.

To avoid irremediable damage to the battery, always remove the battery compartment carefully, ensuring that the battery does not fall.

- 2c.** Hold the battery compartment by its sides and pull it up carefully.

Maintenance

Replacing Batteries

3. If necessary, release the battery from its compartment as follows:
 - 3a. Position the battery compartment so that the battery is facing you.
 - 3b. Pull on the battery tab to free the battery from its socket.

You are now ready to replace the battery.

To replace (or install) the main battery:

1. If you do not have a replacement battery, contact EXFO to purchase a new one.
2. Position the battery compartment so that you can view its hollow part.



IMPORTANT

Always use a battery whose size corresponds to the size of the battery compartment.

3. Install the battery as follows:
 - 3a. Insert the new battery, respecting the polarity. You can use the image appearing inside the compartment as a guide.

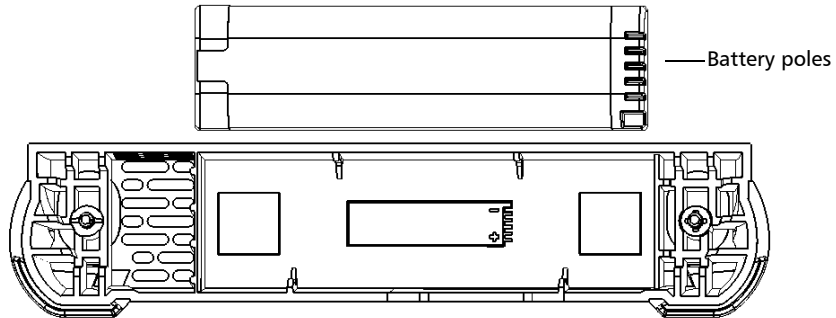

Note: *When the battery is correctly positioned, its poles should be facing upwards and be placed on the same side as shown on the illustration in the battery compartment.*

- 3b. Apply slight pressure to the battery to secure it in place.
4. Position the battery compartment so that you can see the two screws.
5. Place the battery compartment on the platform, making sure that the bumpers and the shorter sides of the compartment are flush with those of the platform. If necessary, slightly move the battery compartment until alignment is correct.
6. Lift the mobile part of the compartment screws and, while applying slight pressure, turn the screws clockwise until they are tightened.

Note: *You cannot replace the clock battery yourself.*

Maintenance

Recycling and Disposal (Applies to European Union Only)

Recycling and Disposal (Applies to European Union Only)

For complete recycling/disposal information as per European Directive WEEE 2012/19/UE, visit the EXFO Web site at www.exfo.com/recycle.

12 Troubleshooting





Solving Common Problems

Problem	Cause	Solution
Unit does not turn on.	Battery is discharged.	<ul style="list-style-type: none">➤ Charge the battery.➤ Replace the battery with a fully charged one.➤ Connect the unit to an external power supply using the AC adapter/charger.
	Unit is not connected to an external power supply.	Connect the unit to an external power supply using the AC adapter/charger.
	External power supply is disconnected.	Make sure the external power supply is connected at both ends.
Unit screen is dark.	Unit's backlight is off.	Press the backlight button.
	Battery is discharged and unit has shut down.	<ul style="list-style-type: none">➤ Charge the battery.➤ Replace the battery with a fully charged one.➤ Connect the unit to an external power supply using the AC adapter/charger.
At logon, no scroll bar is displayed to browse through all user accounts.	---	Select any of the user accounts that you can see on screen, and then press the down arrow (from the unit's keypad) to go to the next account. Use the up/down arrows to browse through the accounts.

Troubleshooting

Solving Common Problems

Problem	Cause	Solution
The System Settings window is not displayed correctly when you control the unit via Remote Desktop.	---	<ul style="list-style-type: none">➤ Ensure that the System Settings window is closed <i>before</i> you connect to the unit with Remote Desktop. OR <ul style="list-style-type: none">➤ If you are already connected to the unit with Remote Desktop, close the System Settings window, and then reopen it.
Some applications are not displayed correctly when you connect to the unit with Remote Desktop.	On your computer, the screen resolution that has been selected at the time of connection is too high.	On your computer, select a lower screen resolution in the Remote Desktop options <i>before</i> connecting to your unit.
External keyboard is not working.	External keyboard has not been detected.	<ul style="list-style-type: none">➤ Disconnect the keyboard, and then connect it again.➤ Turn off the unit, connect the keyboard, and turn on the unit.
Screen characters are dim.	Brightness is not set properly.	Adjust brightness.
Module is not detected.	The module's application has not been installed yet on your unit or the module's application is not up-to-date.	Ensure that the latest version for your module's application is available on your unit (see the <i>Installing or Upgrading the Applications</i> section).

Problem	Cause	Solution
One of the applications is not responding.		Press  and hold it down until the shutdown menu appears, then select Turn off . Turn the unit on again to reset it.
Impossible to calibrate the touchscreen via the calibration application in System Settings .	Screen calibration is very poor.	<ul style="list-style-type: none"> ➤ Press  and hold it down until the shutdown menu appears, then select Turn off. ➤ Turn on the unit. <p>While the system is displaying the boot menu (3 seconds), press the down arrow from the unit's keypad to select the emergency system tools operation mode.</p> <p>OR</p> <p>Press the ARROW DOWN key on the keyboard (if you have connected one).</p> <ul style="list-style-type: none"> ➤ Press  from the unit's keypad or ENTER on your keyboard to confirm your choice. ➤ Press  to start the screen calibration.
Unit's operating time is reduced.	Battery is probably worn out.	Replace the battery.
	Battery was not fully charged.	<ul style="list-style-type: none"> ➤ Charge the battery. ➤ Perform a complete battery calibration cycle^a.
Battery indicator remains low after a full charge.	Battery is not completely charged.	Perform a complete battery calibration cycle ^a .

Troubleshooting

Solving Common Problems

Problem	Cause	Solution
Batteries are not charging.	Ambient temperature is too high or too low.	Ensure that the temperature in the location where you charge the batteries is within the specifications.
	AC adapter/charger is not connected properly.	Ensure that the adapter/charger is connected both to your unit and the power outlet.
Unit switches to standby or hibernation mode unexpectedly.	Power schemes are not defined correctly.	Select one of the predefined power schemes (Always On or Max Battery). For more information, see the <i>Configuring the Power Management Options</i> section.
Unit is not responding.		<p>If you were not trying to install a VPN client and your unit stopped responding, restore your unit.</p> <p>To do so, see the <i>Restoring Your Unit to Normal Operation</i> section.</p> <p>If you were trying to install a VPN client, restart your unit and start a new installation. If the problem persists, restore your unit.</p>

Problem	Cause	Solution
The 3G USB modem key is connected, but you are not able to access the Internet.	➤ There is no SIM card in the USB modem key.	Insert the SIM card into the USB modem key. For complete instructions, refer to the documentation that came with your modem key.
	➤ The USB modem key is not detected properly.	Disconnect the modem key from your unit, and try connecting it again. If the modem key is still not detected, try connecting it to another USB port.
	➤ The SIM card has not been activated or there is a problem with service package that you purchased. ➤ The SIM card is locked. ➤ There is a problem with the mobile network.	Contact your provider of mobile services.

Troubleshooting

Solving Common Problems

Problem	Cause	Solution
Even though my unit is equipped with the Wi-Fi and Bluetooth option, no GPS coordinates are available in my files or in the GPS Coordinates Viewer utility.	<ul style="list-style-type: none">➤ The SMARTGPS option is not activated on the unit.➤ The EXFO Link application is not running on the smart device.➤ No mobile wireless hotspot has been created on the smart device yet.➤ The unit is not connected to the mobile hotspot of the smart device.➤ There is a connection problem with the mobile hotspot.➤ The application generating the files does not offer this feature.	<ul style="list-style-type: none">➤ Activate the option (see <i>Activating Software Options</i> on page 40).➤ Start the EXFO Link application on the smart device. If EXFO Link is not installed on the smart device, see <i>Getting Ready to Retrieve Geolocation Information</i> on page 84.➤ Create a mobile hotspot to which the unit can connect. For more information, refer to the user documentation that came with your smart device.➤ Connect your unit to the mobile hotspot as you would do with any wireless network (see <i>Connecting to a Wireless Network</i> on page 125).➤ Try to use the unit and smart device outdoors and as far away as possible from buildings and other solid objects to see if you can get coordinates.➤ If you can see coordinates in the GPS Coordinates Viewer utility, but not in your files, this probably means that the application generating the files does not offer this feature, or that the corresponding option is not activated or selected.

Problem	Cause	Solution
Impossible to use my FIP-400 probe with my unit.	Fiber probes of the FIP-400 series are no longer supported.	Connect a fiber probe of the FIP-400B series to one of the USB ports of your unit. If you do not have a fiber probe of the FIP-400B series, contact EXFO.
Problems or errors occurred during the installation of the VPN client.	---	Restart your unit and start a new installation. If the problem persists, restore your unit. To do so, see the <i>Restoring Your Unit to Normal Operation</i> section.
You want to change your VPN client for another client. OR You need to remove the VPN client from your unit.	---	Restore your unit. To do so, see the <i>Restoring Your Unit to Normal Operation</i> section.
The VPN client has been updated accidentally.	---	Restore your unit. To do so, see the <i>Restoring Your Unit to Normal Operation</i> section.

- a. A complete battery calibration cycle consists of a full charge, immediately followed by a full discharge, then followed by a full charge.

Restoring Your Unit to Normal Operation

Your FTB-1 is set to start using the standard Windows startup sequence. However, you can also use the emergency system tools feature if you need to:

- check the disk integrity
- back up some files directly onto a USB storage device for recovery purposes
- revert your unit to its initial state (as it was when you purchased it) or restore it with a specific Windows image (WIM) that could have been provided to you by EXFO customer service, for example.



IMPORTANT



The restoration of the system partition cannot be undone or stopped once it is started.

If you have installed other products that are not included in your image file, you will have to reinstall them afterwards.

To avoid losing the data that is stored on the D drive, you may want to back it up before restoring the system partition. Otherwise, all your files will be lost.

Note: *You may find useful to connect a keyboard and a mouse to your unit before using the emergency system tools.*

To navigate in the various windows using the unit's keypad:

- Use up/down and left/right arrows.
- You can also press  to go to the next group of features (equivalent of the TAB key).
- Press  to select an item (equivalent of the ENTER key).

To restore the system partition:

1. Turn on the FTB-1.
2. While the system is displaying the boot menu (3 seconds), press the down arrow from the unit's keypad to select the *Maintenance and recovery* mode.

OR

Press the ARROW DOWN key on the keyboard (if you have connected one).

3. Press  from the unit's keypad or ENTER on your keyboard to confirm your choice.

Note: *The touchscreen becomes effective at this point.*

Troubleshooting

Restoring Your Unit to Normal Operation

4. From the main window, select **Restore system partition from an image**, then tap **Next**.

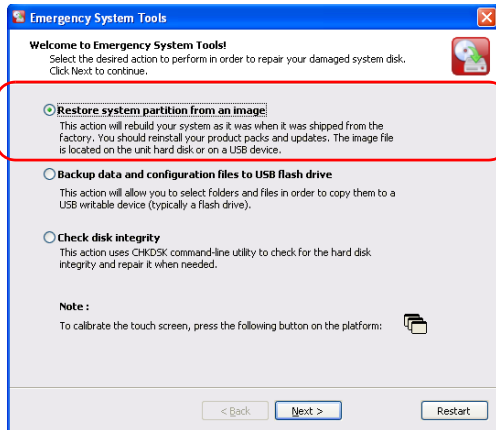

5. If you want to revert your unit to its initial state (most cases), select **Factory recovery image**.

OR

If you prefer to use an image file (provided by customer service, for example), select **.wim** file and use the **Browse** button to locate the file.

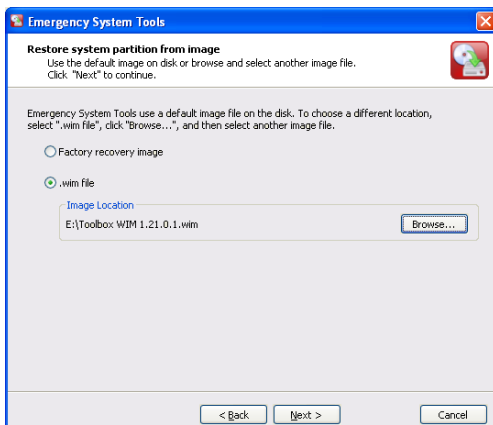

6. Tap **Next** to proceed to the next step.

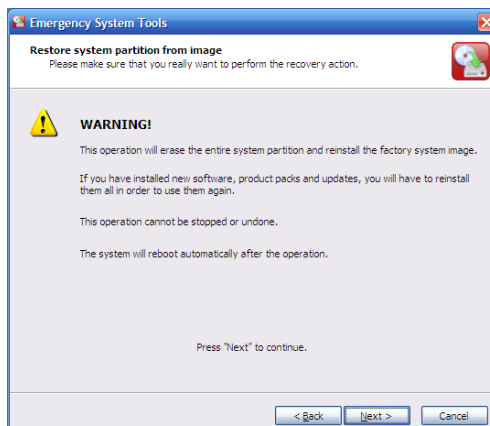

7. Tap **Next** to start the restoration process. The unit will restart upon completion of the process.

Troubleshooting

Restoring Your Unit to Normal Operation

To retrieve data from the D drive:

1. Turn on the FTB-1.
2. While the system is displaying the boot menu (3 seconds), press the down arrow from the unit's keypad to select the *Maintenance and recovery* mode.

OR

Press the ARROW DOWN key on the keyboard (if you have connected one).

3. Press ✓ from the unit's keypad or ENTER on your keyboard to confirm your choice.

Note: *The touchscreen becomes effective at this point.*

4. From the main window, select **Backup data and configuration files to USB flash drive**, then tap **Next**.

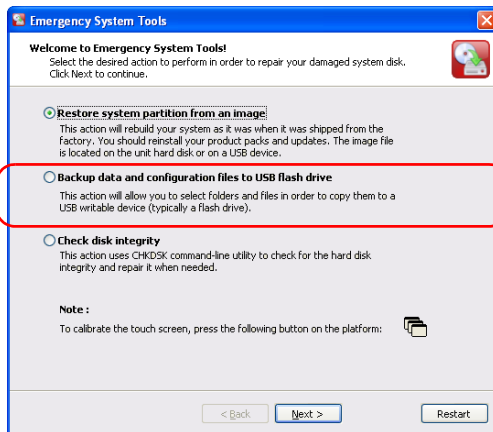

5. Select the files to back up.

A check mark indicates a selection of the entire folder (subfolders and files). A shaded check box indicates that not all of the files of subfolders are selected.

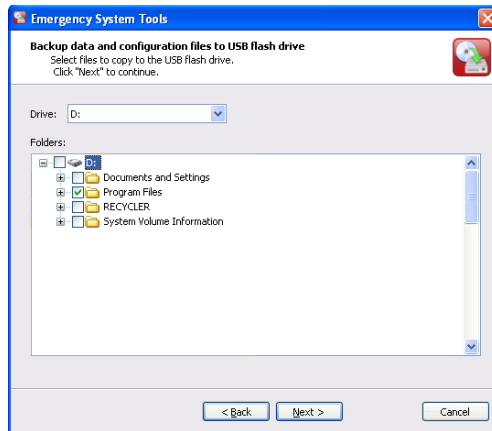

6. If the USB device you want to use is not connected to the unit, connect it now so that the system can find it. Tap **Next**.

Troubleshooting

Restoring Your Unit to Normal Operation

7. Select the USB device onto which you want to save the data from the list of available devices.

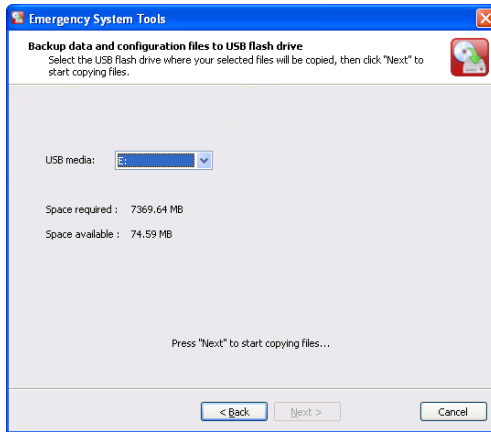

Note: *If you have forgotten to connect the USB device at this point and that it does not show up in the list, tap **Back**, connect the device, then tap **Next** to return to this window.*

8. Tap **Next** to start the file copy process.

A progress bar indicates which files are being copied. If you tap **Cancel** while the transfer is in progress, any file that was copied onto the USB device will still be on the USB device.

9. Once the transfer is complete, tap **Cancel** to return to the main window.

To verify disk integrity:

1. Turn on the FTB-1.
2. While the system is displaying the boot menu (3 seconds), press the down arrow from the unit's keypad to select the *Maintenance and recovery* mode.

OR

Press the ARROW DOWN key on the keyboard (if you have connected one).

3. Press ✓ from the unit's keypad or ENTER on your keyboard to confirm your choice.

Note: *The touchscreen becomes effective at this point.*

4. From the main window, select **Check disk integrity**, then tap **Next**.

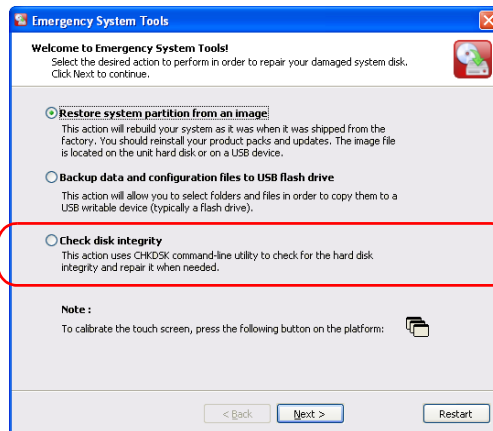

Troubleshooting

Restoring Your Unit to Normal Operation

5. Tap **Next** to start the disk analysis.

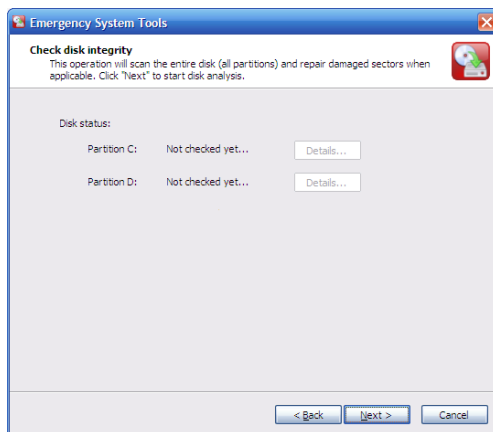

Once the analysis is complete, you can view a report on each drive by tapping **Details**.

6. Tap **OK** once you have finished.
7. To exit the integrity analysis tool, tap **Cancel** to return to the main window.

Contacting the Technical Support Group

To obtain after-sales service or technical support for this product, contact EXFO at one of the following numbers. The Technical Support Group is available to take your calls from Monday to Friday, 8:00 a.m. to 7:00 p.m. (Eastern Time in North America).

Technical Support Group

400 Godin Avenue
Quebec (Quebec) G1M 2K2
CANADA

1 866 683-0155 (USA and Canada)
Tel.: 1 418 683-5498
Fax: 1 418 683-9224
support@exfo.com

For detailed information about technical support, and for a list of other worldwide locations, visit the EXFO Web site at www.exfo.com.

If you have comments or suggestions about this user documentation, you can send them to customer.feedback.manual@exfo.com.

To accelerate the process, please have information such as the name and the serial number (see the product identification label), as well as a description of your problem, close at hand.

Transportation

Maintain a temperature range within specifications when transporting the unit. Transportation damage can occur from improper handling. The following steps are recommended to minimize the possibility of damage:

- Pack the unit in its original packing material when shipping.
- Avoid high humidity or large temperature fluctuations.
- Keep the unit out of direct sunlight.
- Avoid unnecessary shocks and vibrations.

13 Warranty

General Information

EXFO Inc. (EXFO) warrants this equipment against defects in material and workmanship for a period of one year from the date of original shipment. EXFO also warrants that this equipment will meet applicable specifications under normal use.

During the warranty period, EXFO will, at its discretion, repair, replace, or issue credit for any defective product, as well as verify and adjust the product free of charge should the equipment need to be repaired or if the original calibration is erroneous. If the equipment is sent back for verification of calibration during the warranty period and found to meet all published specifications, EXFO will charge standard calibration fees.



IMPORTANT

The warranty can become null and void if:

- unit has been tampered with, repaired, or worked upon by unauthorized individuals or non-EXFO personnel.
- warranty sticker has been removed.
- case screws, other than those specified in this guide, have been removed.
- case has been opened, other than as explained in this guide.
- unit serial number has been altered, erased, or removed.
- unit has been misused, neglected, or damaged by accident.

THIS WARRANTY IS IN LIEU OF ALL OTHER WARRANTIES EXPRESSED, IMPLIED, OR STATUTORY, INCLUDING, BUT NOT LIMITED TO, THE IMPLIED WARRANTIES OF MERCHANTABILITY AND FITNESS FOR A PARTICULAR PURPOSE. IN NO EVENT SHALL EXFO BE LIABLE FOR SPECIAL, INCIDENTAL, OR CONSEQUENTIAL DAMAGES.

Warranty

Liability

Liability

EXFO shall not be liable for damages resulting from the use of the product, nor shall be responsible for any failure in the performance of other items to which the product is connected or the operation of any system of which the product may be a part.

EXFO shall not be liable for damages resulting from improper usage or unauthorized modification of the product, its accompanying accessories and software.

Exclusions

EXFO reserves the right to make changes in the design or construction of any of its products at any time without incurring obligation to make any changes whatsoever on units purchased. Accessories, including but not limited to fuses, pilot lamps, batteries and universal interfaces (EUI) used with EXFO products are not covered by this warranty.

This warranty excludes failure resulting from: improper use or installation, normal wear and tear, accident, abuse, neglect, fire, water, lightning or other acts of nature, causes external to the product or other factors beyond the control of EXFO.



IMPORTANT

In the case of products equipped with optical connectors, EXFO will charge a fee for replacing connectors that were damaged due to misuse or bad cleaning.

Certification

EXFO certifies that this equipment met its published specifications at the time of shipment from the factory.

Service and Repairs

EXFO commits to providing product service and repair for five years following the date of purchase.

To send any equipment for service or repair:

- 1.** Call one of EXFO's authorized service centers (see *EXFO Service Centers Worldwide* on page 204). Support personnel will determine if the equipment requires service, repair, or calibration.
- 2.** If equipment must be returned to EXFO or an authorized service center, support personnel will issue a Return Merchandise Authorization (RMA) number and provide an address for return.
- 3.** If possible, back up your data before sending the unit for repair.
- 4.** Pack the equipment in its original shipping material. Be sure to include a statement or report fully detailing the defect and the conditions under which it was observed.
- 5.** Return the equipment, prepaid, to the address given to you by support personnel. Be sure to write the RMA number on the shipping slip. *EXFO will refuse and return any package that does not bear an RMA number.*

Note: *A test setup fee will apply to any returned unit that, after test, is found to meet the applicable specifications.*

After repair, the equipment will be returned with a repair report. If the equipment is not under warranty, you will be invoiced for the cost appearing on this report. EXFO will pay return-to-customer shipping costs for equipment under warranty. Shipping insurance is at your expense.

Routine recalibration is not included in any of the warranty plans. Since calibrations/verifications are not covered by the basic or extended warranties, you may elect to purchase FlexCare Calibration/Verification Packages for a definite period of time. Contact an authorized service center (see *EXFO Service Centers Worldwide* on page 204).

Warranty

EXFO Service Centers Worldwide

EXFO Service Centers Worldwide

If your product requires servicing, contact your nearest authorized service center.

EXFO Headquarters Service Center

400 Godin Avenue
Quebec (Quebec) G1M 2K2
CANADA

1 866 683-0155 (USA and Canada)
Tel.: 1 418 683-5498
Fax: 1 418 683-9224
support@exfo.com

EXFO Europe Service Center

Winchester House, School Lane
Chandlers Ford, Hampshire S053 4DG
ENGLAND

Tel.: +44 2380 246800
Fax: +44 2380 246801
support.europe@exfo.com

EXFO Telecom Equipment (Shenzhen) Ltd.

3rd Floor, Building C,
FuNing Hi-Tech Industrial Park, No. 71-3,
Xintian Avenue,
Fuyong, Bao'An District,
Shenzhen, China, 518103

Tel: +86 (755) 2955 3100
Fax: +86 (755) 2955 3101
support.asia@exfo.com

To view EXFO's network of partner-operated Certified Service Centers nearest you, please consult EXFO's corporate website for the complete list of service partners:

<http://www.exfo.com/support/services/instrument-services/exfo-service-centers>.

A Technical Specifications



IMPORTANT

The following technical specifications can change without notice. The information presented in this section is provided as a reference only. To obtain this product's most recent technical specifications, visit the EXFO Web site at www.exfo.com.

TECHNICAL SPECIFICATIONS	
Display	Touchscreen, color, 800 x 480 TFT, 178 mm (7 in)
Interfaces	Two USB 2.0 ports RJ-45 LAN 10/100/1000 Mbit/s Fiber inspection probe connector port (video) Built-in Bluetooth and Wi-Fi (hardware option)
Storage	8 GB internal memory (flash) 16 GB internal memory (flash), optional
Batteries	Rechargeable lithium-ion batteries 8 hours of operation as per Telcordia* (Bellcore) TR-NWT-001138
Power supply	AC/DC adapter, input: ~ 100 – 240 V; 50/60 Hz; 1.6 VA max, output: = 24 V; 3.75 A
Computer	Intel ATOM processor Windows Embedded Standard operating system

GENERAL SPECIFICATIONS	
Size (H x W x D)	190 mm x 252 mm x 66 mm (7 1/2 in x 9 15/16 in x 2 5/8 in)
Weight (with battery)	1.5 kg (3.3 lb)
Temperature Operation	Battery operated: 0 °C to 50 °C (32 °F to 122 °F) Charge mode: 5 °C to 40 °C (41 °F to 104 °F)
Storage	unit: -40 °C to 70 °C (-40 °F to 158 °F) ^b
Relative humidity	0 % to 95 % non-condensing

ACCESSORIES			
GP-10-086	Rigid FTB-1 carrying case	GP-2113	GPS USB dongle
GP-10-072	Semi-rigid FTB-1 carrying case	GP-2137	USB-to-RS-232 converter
GP-302	USB mouse	GP-2138	DC car adapter/inverter
GP-1002	Headset	GP-2144	USB 16G micro-drive
GP-1008	VFL adapter (2.5 mm to 1.25 mm)	GP-2155	Carry-on size backpack ^c
GP-2001	USB keyboard	GP-2158	FTB-1 utility glove
GP-2016	10 feet RJ-45 LAN cable	GP-2200	Module receptacle back panel
GP-2112	3G Universal USB dongle		

Technical Specifications

PM-1 BUILT-IN POWER METER SPECIFICATIONS ^d	
Calibrated wavelengths (nm)	850, 1300, 1310, 1490, 1550, 1625, 1650
Optional CWDM calibrated wavelengths (nm)	1270, 1290, 1310, 1330, 1350, 1370, 1390, 1410, 1430, 1450, 1470, 1490, 1510, 1530, 1550, 1570, 1590, 1610, 1383, 1625
Power range (dBm)	10 to -86 (InGaAs) 26 to -64 (GeX)
Uncertainty (%) ^a	±5 % ± 3 pW (InGaAs) ±5 % ± 0.4 nW (GeX)
Display resolution (dB)	
InGaAs	0.01 = max to -76 dBm 0.1 = -76 dBm to -86 dBm 1 = -86 dBm to min
GeX	0.01 = max to -54 dBm 0.1 = -50 dBm to -60 dBm 1 = -60 dBm to min
Automatic offset nulling range ^f	Max power to -63 dBm for InGaAs Max power to -40 dBm for GeX
Tone detection (Hz)	270/1000/2000

VISUAL FAULT LOCATOR (VFL) (OPTIONAL)
Laser, 650 nm ± 10 nm
CW
Typical P _{out} in 62.5/125 μm: 3 dBm (2 mW)

- Notes**
- With optional extended-life battery.
 - 20 °C to 60 °C (-4 °F to 140 °F) with the battery pack, and for the AC adapter.
 - The selected model may change without notice.
 - At 23 °C ±1 °C, 1550 nm and FC connector. With modules in idle mode. Battery operated.
 - Up to 5 dBm.
 - For ±0.05 dB, from 18 °C to 28 °C.

Index

- 3G USB modem, using 104
- A**
- AC requirements 18, 19
- accessing
- Internet with a 3G USB modem 104
 - power meter 111
- adapter 17
- after-sales service 199
- application, starting 45
- applications
- automatic startup 63
 - installing 35
- B**
- battery
- charge status 173
 - clock 76
 - maintenance recommendations 173
 - recharging 174
 - replacing or removing 178
- browsing Web 102
- C**
- calibrating the touchscreen 52
- Canadian Standards Association (CSA) x
- capacitors 16
- capturing images 91
- car outlet, charging battery with 174
- caution
- of personal hazard 11
 - of product hazard 11
- certification information viii
- changing batteries 178
- charger 17
- checking data integrity 197
- cleaning
- detector ports 172
 - front panel 171
 - touchscreen 173
- connecting to a VPN 137
- ConnectorMax 113
- conventions, safety 11
- coordinates, GPS 84, 108
- creating PDF files 89
- CSA x
- current, electrical 18
- customer service 203
- D**
- data
- integrity 197
 - retrieving 194
- description, keypad 6
- detecting module 22
- detector port, cleaning 172
- documents, printing 89
- dongle 3G USB 104
- dual-boot 190
- E**
- emergency system tools 190
- equipment returns 203
- Explorer, Internet 102
- exporting results 170
- external power supply 17
- F**
- fiber inspection probe 113
- file
- format 170
 - name 170
- FIP 113

Index

Flash Player, installing 100
front panel, cleaning 171

G

geolocation information 84
GPS coordinates 84, 108

H

hazard, laser radiation 15
hibernation mode 31

I

identification label 199
image formats 94
indoor use 16
input current 18
inserting a module 21
inspecting fibers 113
installing
 Flash Player 100
 software 35
 VPN clients 137
integrity, data 197
Internet
 connection 104
 Explorer 102

K

keypad description 6

L

label, identification 199
laser safety information 15
localizing your unit 84, 108
longitude and latitude 84, 108

M

maintenance
 battery 173
 detector ports 172
 front panel 171
 general information 171
 touchscreen 173
maximum input current 18
modifying storage parameters 94
module
 detection 22
 insertion 21
 removal 21

N

navigating the Internet 102

O

options
 software 40
 used at startup 63
other tools, accessing 110

P

parameters
 for ping 165
 for trace route 168
PDF files, generating 89
ping, performing a test 165
power
 button 6
 sources 18
 supply 17
power meter, accessing 111
printing documents 89
probe 113
product
 identification label 199
 specifications 205

NOTICE 通告

CHINESE REGULATION ON RESTRICTION OF HAZARDOUS SUBSTANCES 中国关于有害物质限制的规定



NAMES AND CONTENTS OF THE TOXIC OR HAZARDOUS SUBSTANCES OR ELEMENTS
CONTAINED IN THIS EXFO PRODUCT
包含在本 **EXFO** 产品中的有毒有害物质或元素的名称和含量

O	Indicates that this toxic or hazardous substance contained in all of the homogeneous materials for this part is below the limit requirement in SJ/T11363-2006 表示该有毒有害物质在该部件所有均质材料中的含量均在 SJ/T11363-2006 标准规定的限量要求以下。
X	Indicates that this toxic or hazardous substance contained in at least one of the homogeneous materials used for this part is above the limit requirement in SJ/T11363-2006 表示该有毒有害物质至少在该部件的某一均质材料中的含量超出 SJ/T11363-2006 标准规定的限量要求。

Part Name 部件名称	Toxic or hazardous Substances and Elements 有毒有害物质和元素					
	Lead 铅 (Pb)	Mercury 汞 (Hg)	Cadmium 镉 (Cd)	Hexavalent Chromium 六价铬 (Cr VI)	Polybrominated biphenyls 多溴联苯 (PBB)	Polybrominated diphenyl ethers 多溴二苯醚 (PBDE)
Enclosure 外壳	O	O	O	O	O	O
Electronic and electrical sub-assembly 电子和电子组件	X	O	X	O	X	X
Optical sub-assembly ^a 光学组件 ^a	X	O	O	O	O	O
Mechanical sub-assembly ^a 机械组件 ^a	O	O	O	O	O	O

a. If applicable.
如果适用。

MARKING REQUIREMENTS
标注要求

Product 产品	Environmental protection use period (years) 环境保护使用期限 (年)	Logo 标志
This EXFO product 本 EXFO 产品	10	
Battery ^a 电池 ^a	5	

- a. If applicable.
如果适用。

P/N: 1068519

www.EXFO.com · info@exfo.com

CORPORATE HEADQUARTERS	400 Godin Avenue	Quebec (Quebec) G1M 2K2 CANADA Tel.: 1 418 683-0211 · Fax: 1 418 683-2170
EXFO AMERICA	3400 Waterview Parkway Suite 100	Richardson, TX 75080 USA Tel.: 1 972-761-9271 · Fax: 1 972-761-9067
EXFO EUROPE	Winchester House, School Lane	Chandlers Ford, Hampshire S053 4DG ENGLAND Tel.: +44 2380 246 800 · Fax: +44 2380 246 801
EXFO ASIA-PACIFIC	62 Ubi Road 1, #09-01/02 Oxley Bizhub 2	SINGAPORE 408734 Tel.: +65 6333 8241 · Fax: +65 6333 8242
EXFO CHINA	Beijing Global Trade Center, Tower C, Room 1207, 36 North Third Ring Road East, Dongcheng District	Beijing 100013 P. R. CHINA Tel.: +86 (10) 5825 7755 · Fax: +86 (10) 5825 7722
EXFO SERVICE ASSURANCE	270 Billerica Road	Chelmsford MA, 01824 USA Tel.: 1 978 367-5600 · Fax: 1 978 367-5700
EXFO FINLAND	Elektroniikkatie 2	FI-90590 Oulu, FINLAND Tel.: +358 (0) 403 010 300 · Fax: +358 (0) 8 564 5203
TOLL-FREE	(USA and Canada)	1 800 663-3936

© 2015 EXFO Inc. All rights reserved.
Printed in Canada (2015-08)

