

---

# FTB-5500B

PMD Analyzer for FTB-500



---

Copyright © 2003–2009 EXFO Electro-Optical Engineering Inc. All rights reserved. No part of this publication may be reproduced, stored in a retrieval system or transmitted in any form, be it electronically, mechanically, or by any other means such as photocopying, recording or otherwise, without the prior written permission of EXFO Electro-Optical Engineering Inc. (EXFO).

Information provided by EXFO is believed to be accurate and reliable. However, no responsibility is assumed by EXFO for its use nor for any infringements of patents or other rights of third parties that may result from its use. No license is granted by implication or otherwise under any patent rights of EXFO.

EXFO's Commerce And Government Entities (CAGE) code under the North Atlantic Treaty Organization (NATO) is 0L8C3.

The information contained in this publication is subject to change without notice.

### ***Trademarks***

EXFO's trademarks have been identified as such. However, the presence or absence of such identification does not affect the legal status of any trademark.

### ***Units of Measurement***

Units of measurement in this publication conform to SI standards and practices.

### ***Patents***

The Polarization Mode Dispersion Analyzer is the subject of International PCT application, publication number WO 2004/070341; EXFO's Universal Interface is protected by US patent 6,612,750.

Version number 4.0.1

# Contents

Certification Information .....	vi
<b>1 Introducing the FTB-5500B Polarization Mode Dispersion Analyzer .....</b>	<b>1</b>
Main Features .....	1
Typical Applications .....	2
Basic Polarization Mode Dispersion Theory .....	3
Conventions .....	6
<b>2 Safety Information .....</b>	<b>7</b>
<b>3 Getting Started with Your Polarization Mode Dispersion Analyzer .....</b>	<b>9</b>
Inserting and Removing Test Modules .....	9
Starting the Polarization Mode Dispersion Analyzer Application .....	13
Exiting the Application .....	17
<b>4 Setting Up the Polarization Mode Dispersion Analyzer .....</b>	<b>19</b>
Defining the Automatic Fiber Name Format .....	19
Customizing PMD Value and Coefficient Thresholds .....	20
Setting Acquisition Parameters .....	24
Preparing for Multiple Acquisitions on a Fiber .....	28
Averaging Measurements .....	31
<b>5 Operating the Polarization Mode Dispersion Analyzer .....</b>	<b>33</b>
Cleaning and Connecting Optical Fibers .....	33
Installing the EXFO Universal Interface (EUI) .....	34
Setting Up Hardware for Measurements .....	36
Acquiring Traces .....	39
Performing a Null Measurement .....	41
Viewing the Input Power Level .....	42

## Contents

---

<b>6</b>	<b>Managing Results</b>	<b>43</b>
	Customizing Graph View	43
	Viewing Acquisition Results and Information	44
	Removing Unwanted Results	49
	Viewing Statistics	51
	Linking Distinct Fibers to a Single Fiber	54
	Creating New Result Files with Selected Fibers	56
	Documenting Results	58
	Defining a Template for Test Information	62
	Saving Results Files	63
	Exporting Results and Graphs	64
	Customizing Reports	67
	Printing Data	69
	Closing Result Files	72
<b>7</b>	<b>Exporting PMD Files with the File Converter</b>	<b>73</b>
	Starting and Exiting the File Converter	74
	Setting Export Parameters	76
	Exporting PMD Files	78
<b>8</b>	<b>Maintenance</b>	<b>81</b>
	Cleaning Fixed Connectors	82
	Cleaning EUI Connectors	84
	Recalibrating the Unit	86
	Recycling and Disposal (Applies to European Union Only)	87
<b>9</b>	<b>Troubleshooting</b>	<b>89</b>
	Solving Common Problems	89
	Viewing Online Documentation	92
	Contacting the Technical Support Group	93
	Transportation	94
<b>10</b>	<b>Warranty</b>	<b>95</b>
	General Information	95
	Liability	96
	Exclusions	97
	Certification	97
	Service and Repairs	98
	EXFO Service Centers Worldwide	99
<b>A</b>	<b>Technical Specifications</b>	<b>101</b>

<b>B Using Third-Party Broadband Light Sources .....</b>	<b>103</b>
Compliance Criteria .....	103
Uncertainty Formula .....	105
<b>Index .....</b>	<b>107</b>

# Certification Information

## F.C.C. Information

Electronic test equipment is exempt from Part 15 compliance (FCC) in the United States. However, compliance verification tests are systematically performed on most EXFO equipment.

## CE Information

Electronic test equipment is subject to the EMC Directive in the European Union. The EN61326 standard prescribes both emission and immunity requirements for laboratory, measurement, and control equipment. This unit has undergone extensive testing according to the European Union Directive and Standards.

**EXFO** **CE** **DECLARATION OF CONFORMITY**

Application of Council Directive(s):	2006/95/EC - The Low Voltage Directive 2004/108/EC - The EMC Directive And their amendments
Manufacturer's Name:	EXFO Electro-Optical Engineering Inc.
Manufacturer's Address:	400 Godin Avenue Quebec, Quebec Canada, G1M 2K2 (418) 683-0211
Equipment Type/Environment:	Test & Measurement / Industrial
Trade Name/Model No.:	FTB-5500B PMD Analyzer

**Standard(s) to which Conformity is Declared:**

<b>EN 61010-1:2001</b>	<b>Safety Requirements for Electrical Equipment for Measurement, Control, and Laboratory Use, Part 1: General Requirements.</b>
<b>EN 61326-1:2006</b>	<b>Electrical Equipment for Measurement, Control and Laboratory Use - EMC Requirements – Part 1: General requirements</b>
<b>EN 60825-1:1994 +A2:2001 +A1:2002</b>	<b>Safety of laser products – Part 1: Equipment classification, requirements, and user's guide</b>
<b>EN 55022: 1998 +A2: 2003</b>	<b>Information technology equipment - Radio disturbance characteristics - Limits and methods of measurement</b>

*I, the undersigned, hereby declare that the equipment specified above conforms to the above Directive and Standards.*

**Manufacturer**

Signature:

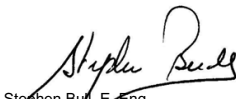

Full Name: Stephen Bull, E. Eng  
Position: Vice-President Research and Development  
Address: 400 Godin Avenue, Quebec (Quebec),  
Canada, G1M 2K2  
Date: January 09, 2009





# **1** ***Introducing the FTB-5500B Polarization Mode Dispersion Analyzer***

## **Main Features**

Polarization mode dispersion (PMD) is the dispersion of light propagating along a fiber or through a device due to the birefringence property of the material. This dispersion causes a delay between two principal states of polarization

The FTB-5500B Polarization Mode Dispersion Analyzer takes full advantage of the IEC- and TIA-approved interferometric method to offer a fast and field-proof unit that can handle almost any situation. This unit, used with the FLS-5800 CD/PMD Analyzer Source, features the best dynamic range on the market to measure links longer than 200 km. The Polarization Mode Dispersion Analyzer covers the O+C+L bandwidth.

The FTB-5500B Polarization Mode Dispersion Analyzer offers a dynamic range higher than 50 dB for long-haul applications; multiple-measurement capability for long-term monitoring; and an estimated second-order PMD for DWDM system fiber certifications.

# Introducing the FTB-5500B Polarization Mode Dispersion Analyzer

## Typical Applications

---

The FTB-5500B Polarization Mode Dispersion Analyzer is a complete PMD analyzer system. It measures PMD using the internationally recognized interferometric method. The Polarization Mode Dispersion Analyzer averages PMD over the complete source wavelength range without any filtering, leaving all the source power for PMD measurement. The full dynamic range remains available to test long fiber spans. It can withstand small vibrations thanks to its fast measurement time and does not require any special environmental setup to perform reliable measurements.

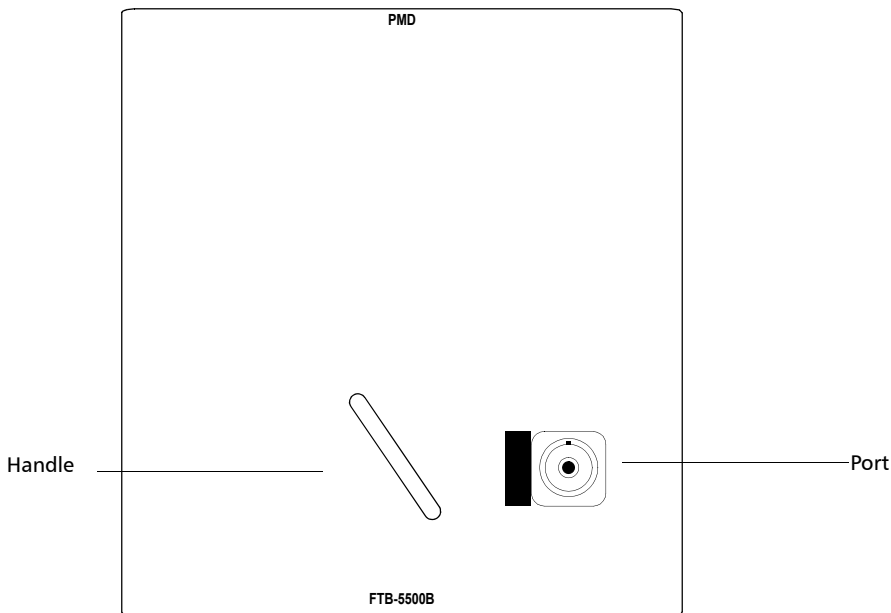

## Typical Applications

The Polarization Mode Dispersion Analyzer can also analyze a signal transmitted through erbium-doped fiber amplifiers (EDFAs) providing a total PMD value for the entire link.

### Basic Polarization Mode Dispersion Theory

The dispersion phenomenon is described as a number of non-intensity-dependant physical occurrences resulting directly in signal loss (pulse spreading or time jitter in a digital system; distortion in an analog system). PMD is an important type of signal dispersion. As unrepeated link distances are increased and transmission rates pushed upwards, PMD can significantly reduce system performance.

To better understand the impact of PMD, consider the example of a pulse passing through a wave plate. Upon entering the wave plate, the pulse is decomposed into polarization components aligned with each of the two birefringent axes of the plate (known as the fast and slow axes). The components propagating independently through the wave plate at different group velocities will recombine at the end of the wave plate as a superposition of two pulses split in time.

The delay between those pulses is designated as the differential group delay (DGD) and is written as  $\delta\tau$ . For a Gaussian, unchirped input pulse of rms width  $\sigma_0$ , the rms width at the output is given by

$$\sigma^2 = \sigma_0^2 + r_0 (1 - r_0) \cdot \delta\tau^2$$

where  $r_0$  is the fraction of the input-pulse energy launched into one of the birefringence axes.

Worst-case spreading occurs when the signal is perfectly split in two ( $r_0 = 1/2$ ), while no spreading occurs if the input state of polarization (SOP) of the launched signal is aligned with one of the birefringence axes.

To generalize this example, consider a long, weakly birefringent telecommunications fiber as a concatenation of many, randomly orientated birefringent wave plates. Each interface between two wave plates redistributes the optical energy along both axes of the subsequent wave plate. This transfer of energy is called mode coupling.

## Introducing the FTB-5500B Polarization Mode Dispersion Analyzer

### *Basic Polarization Mode Dispersion Theory*

---

In a long fiber, numerous mode-coupling events occur along the fiber length, so that light emerging from the output end is the superposition of a number of pulses with different delays. Nonetheless, it turns out that for any given optical frequency,  $\omega$ , one can always find two orthogonal input principal states of polarization (PSPs) such that a light pulse with the same input SOP as the input PSP, undergoes no spreading. For a single wave plate, the PSPs are the two birefringent axes, whereas for a concatenation of wave plates, neither the input nor the output PSPs correspond to the alignment of the birefringent axes anywhere.

Contrary to the case of a wave plate, the DGD and PSPs of a long fiber are dependent on wavelength and fluctuate in time as a result of environmental variations such as temperature, external mechanical constraints, etc. Their behavior is random, both as a function of wavelength at a given time and as a function of time at a given wavelength. Fortunately, this behavior can be characterized statistically. It can be demonstrated that the probability density function of  $\delta\tau$  is Maxwellian and, by definition, PMD is its rms value, that is:

$$\text{PMD} = \sqrt{\langle \text{DGD}^2 \rangle}$$

**Note:** *PMD is sometimes defined as the mean value of the DGD, which for a Maxwellian distribution yields a value 17% lower than the rms definition.*

If the average is calculated over  $\omega$ , PMD is stable in time, provided that the averaging window is sufficiently large ( $\Delta\omega\delta\tau \gg 1$ ).

## Introducing the FTB-5500B Polarization Mode Dispersion Analyzer

*Basic Polarization Mode Dispersion Theory*

---

It is essential to keep in mind that DGD fluctuates in time and can be either smaller or larger than its rms value or PMD. This results in a statistical probability that a pulse (information bit) is broadened, and leads to the eventual impaired ability of the receiver to efficiently decode the information. This adverse PMD effect makes it a critical phenomenon in limiting transmission of high-bit-rate information.

In the case of PMD in a long fiber, there is a specific state called input PSP. In this state, when the input SOP of the signal is aligned with one of its axes, it will propagate through the fiber without any spreading or distortion of the signal. This phenomenon is defined as this specific input SOP such that the output SOP is independent of optical frequency. Again, the worst case occurs when the signal is equally split between both input PSPs.

For long telecom fibers with random coupling of energy between modes (that is  $L \gg h$  where  $h$  is the coupling length), PMD grows as the square root of the distance, whereas PMD of strong HiBi fiber (negligible mode coupling) is directly proportional to the distance. Therefore, the PMD coefficient for negligible mode coupling is expressed as ps/km, while the PMD coefficient for random mode coupling is defined as ps/km<sup>1/2</sup>.

### Conventions

Before using the product described in this manual, you should understand the following conventions:



#### **WARNING**

Indicates a potentially hazardous situation which, if not avoided, could result in *death or serious injury*. Do not proceed unless you understand and meet the required conditions.



#### **CAUTION**

Indicates a potentially hazardous situation which, if not avoided, may result in *minor or moderate injury*. Do not proceed unless you understand and meet the required conditions.



#### **CAUTION**

Indicates a potentially hazardous situation which, if not avoided, may result in *component damage*. Do not proceed unless you understand and meet the required conditions.



#### **IMPORTANT**

Refers to information about this product you should not overlook.

## 2 **Safety Information**



### **WARNING**

Do not install or terminate fibers while a light source is active. Never look directly into a live fiber and ensure that your eyes are protected at all times.



### **WARNING**

Use of controls, adjustments and procedures for operation and maintenance other than those specified herein may result in hazardous radiation exposure or impair the protection provided by this unit.

Your instrument is a Class 1 laser product in compliance with standards IEC60825-1: 2001, 2007 and 21CFR1040.10. Laser radiation may be encountered at the output port.

The following label indicates that a product contains a Class 1 source:



**Note:** *Label shown for information purposes only. It is not affixed to your product.*





# 3 **Getting Started with Your Polarization Mode Dispersion Analyzer**

## **Inserting and Removing Test Modules**



### **CAUTION**

Never insert or remove a module while the FTB-500 is turned on. This will result in immediate and irreparable damage to both the module and unit.



### **WARNING**

When the laser safety LED () is flashing on the FTB-500, at least one of your modules is emitting an optical signal. Please check all modules, as it might not be the one you are currently using.

#### ***To insert a module into the FTB-500:***

1. Exit ToolBox and turn off your unit.
2. Position the FTB-500 so that its right panel is facing you.

## Getting Started with Your Polarization Mode Dispersion Analyzer

### Inserting and Removing Test Modules

---

3. Take the module and place it so that the connector pins are at the back, as explained and shown below.

Identification sticker must be facing up and connector pins at the right of the retaining screw hole.

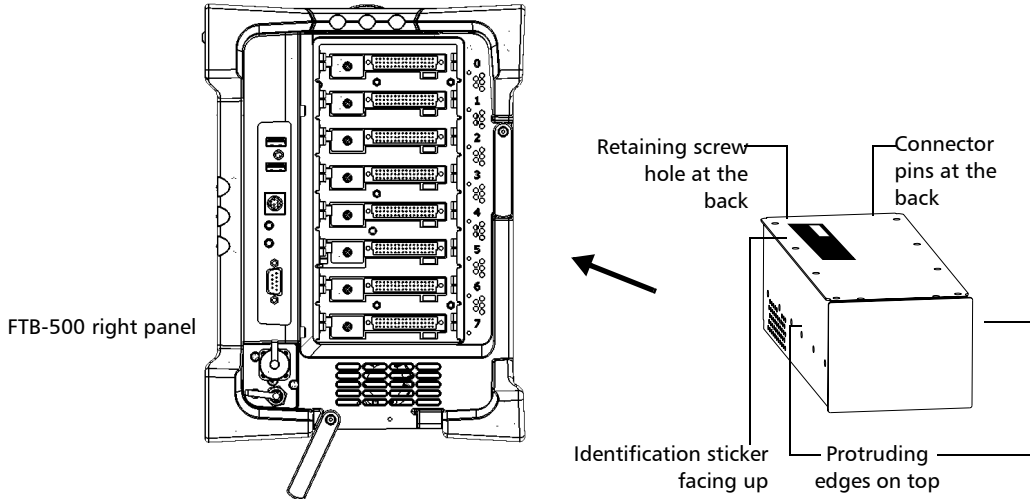

4. Insert the protruding edges of the module into the grooves of the receptacle's module slot.
5. Push the module all the way to the back of the slot, until the retaining screw makes contact with the receptacle casing.
6. Place the FTB-500 so that its left panel is facing you.

## Getting Started with Your Polarization Mode Dispersion Analyzer

### *Inserting and Removing Test Modules*

---

7. While applying slight pressure to the module, turn the retaining screw clockwise until it is tightened.

This will secure the module into its “seated” position.

Turn retaining screw knob  
clockwise

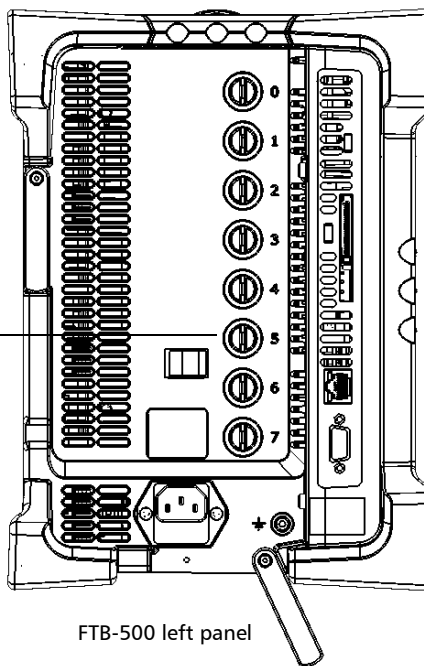
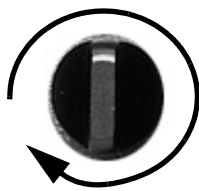

When you turn on the unit, the startup sequence will automatically detect the module.

## Getting Started with Your Polarization Mode Dispersion Analyzer

### Inserting and Removing Test Modules

---

#### **To remove a module from the FTB-500:**

1. Exit ToolBox and turn off your unit.
2. Position the FTB-500 so that the left panel is facing you.
3. Turn the retaining screw counterclockwise until it stops.

The module will be slowly released from the slot.

Turn retaining screw knob(s)  
counterclockwise

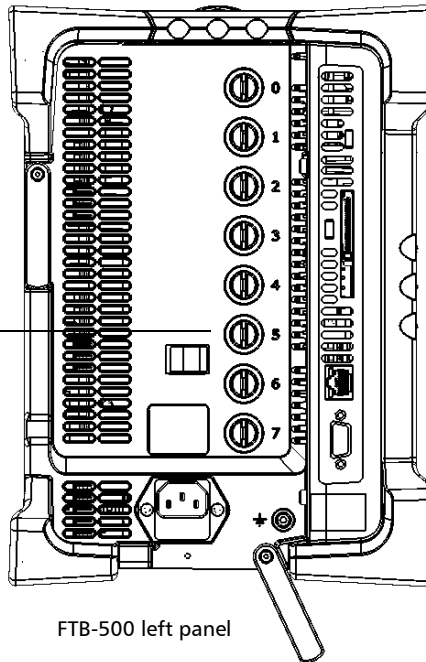
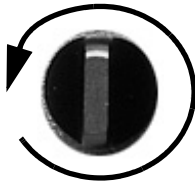

FTB-500 left panel

4. Place the FTB-500 so that the right panel is facing you.

## Getting Started with Your Polarization Mode Dispersion Analyzer

### *Inserting and Removing Test Modules*

---

5. Hold the module by its sides or by the handle (*NOT by the connector*) and pull it out.

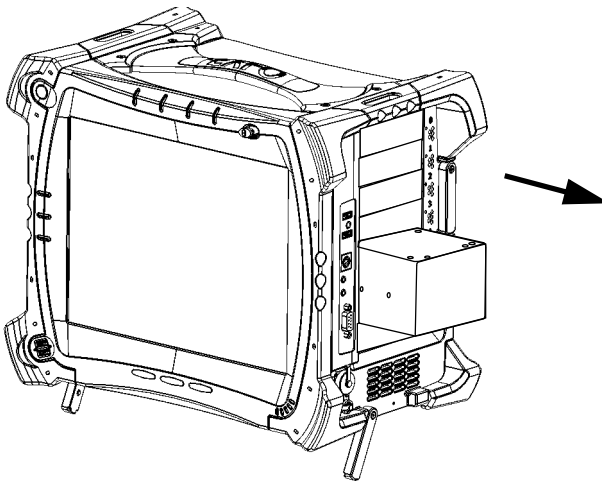

# Getting Started with Your Polarization Mode Dispersion Analyzer

## Starting the Polarization Mode Dispersion Analyzer Application

Your FTB-5500B Polarization Mode Dispersion Analyzer module can be configured and controlled from its dedicated ToolBox application.

**Note:** For details about ToolBox, refer to the FTB-500 user guide.

### To start the application:

1. From the main window, select the module to use.

It will turn blue to indicate that it is highlighted.

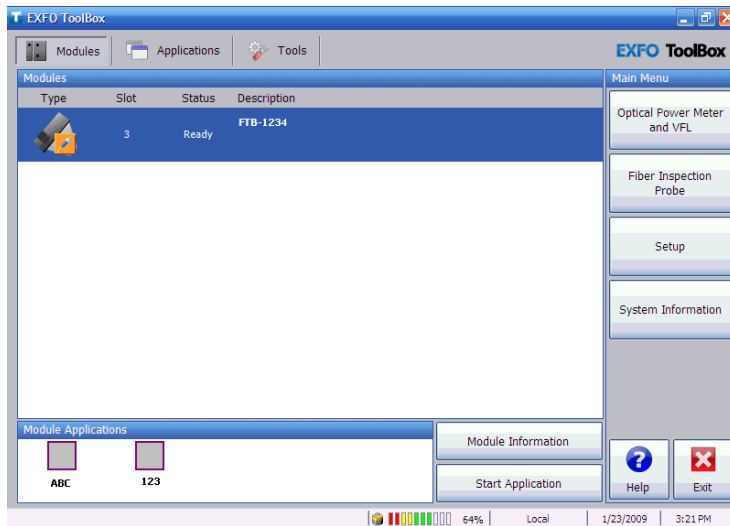

2. Click the corresponding button in the **Module Applications** box.

# Getting Started with Your Polarization Mode Dispersion Analyzer

## Starting the Polarization Mode Dispersion Analyzer Application

The main window (shown below) contains all the commands required to control the Polarization Mode Dispersion Analyzer:

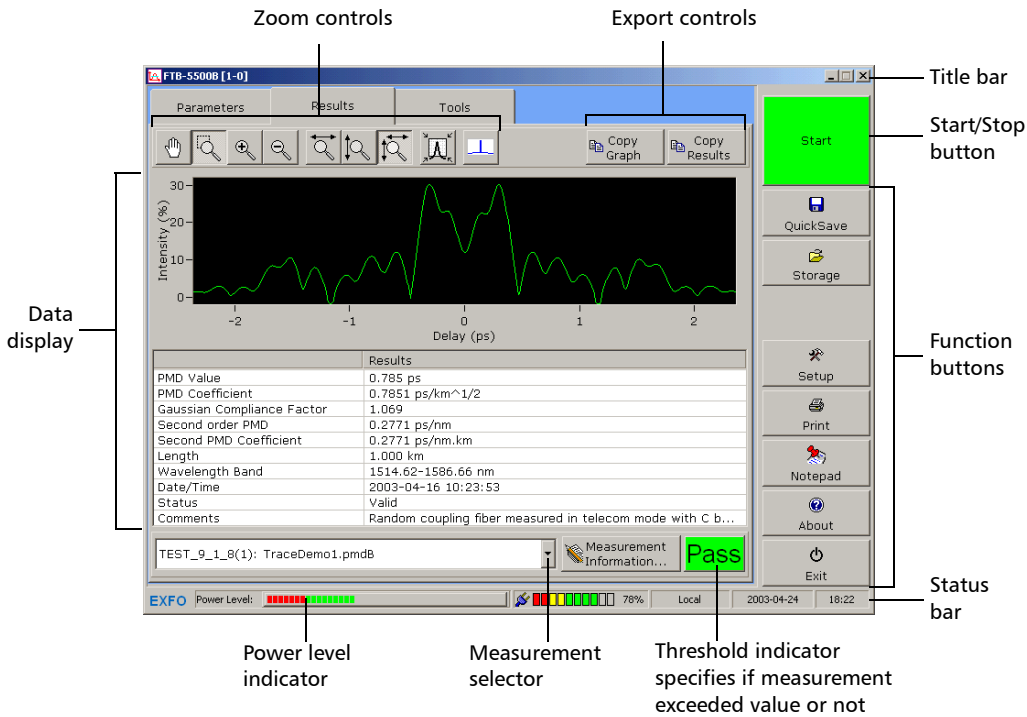

# Getting Started with Your Polarization Mode Dispersion Analyzer

## Starting the Polarization Mode Dispersion Analyzer Application

### Data Display

The data display section shows both a graph and a table of results. The graph presents a signal intensity trace as a function of delay. The table presents information and results related to the measurement specified in the measurement selector.

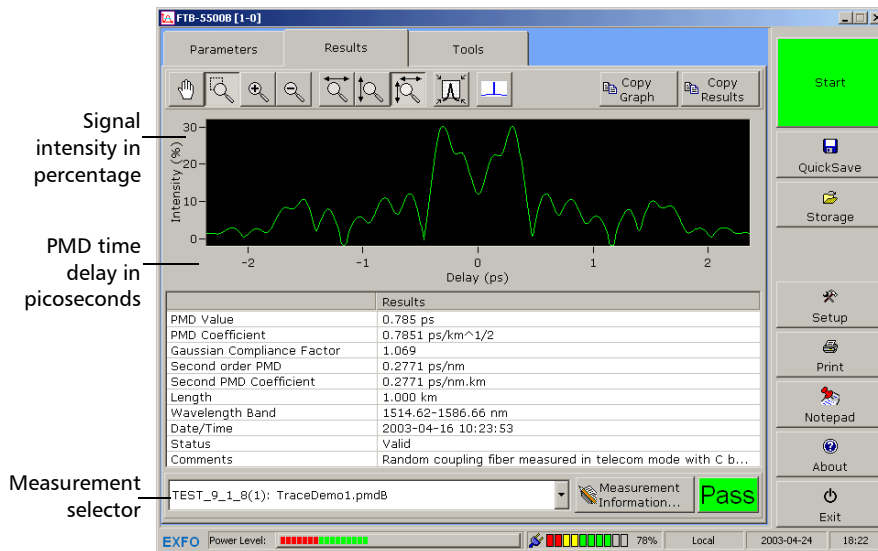



### Status Bar

The status bar, located at the bottom of the main window, identifies the operational status of the FTB-5500B Polarization Mode Dispersion Analyzer.

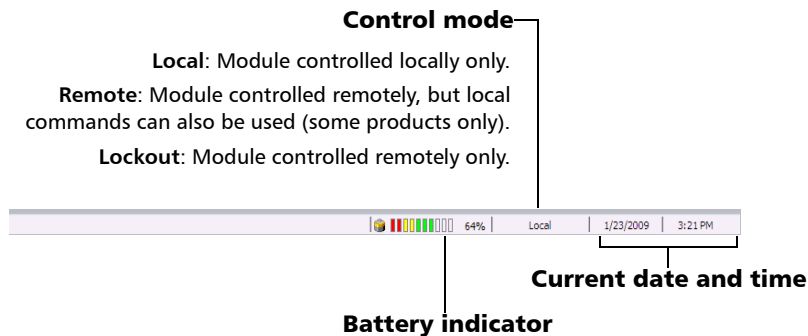

For more information about automating or remotely controlling the FTB-5500B Polarization Mode Dispersion Analyzer, refer to your platform user guide.

### Exiting the Application

Closing any application that is not currently being used helps freeing system memory.

**To close the application from the main window:**

Click  in the top right corner of the main window.

OR

Click the **Exit** button located at the bottom of the function bar.



# 4 Setting Up the Polarization Mode Dispersion Analyzer

The many features of the Polarization Mode Dispersion Analyzer are controlled by the Windows-compatible ToolBox software. Please refer to the *FTB-500* user guide for information regarding the FTB-500.

## Defining the Automatic Fiber Name Format

Each time you make a new acquisition, the fiber name changes automatically according to a pattern you will have previously defined. This name corresponds to the concatenation of a static part (prefix) and a variable part that will be incremented.

**Note:** *The fiber name can be modified later with the measurement information utility. For more information, see Documenting Results on page 58.*

### To define the fiber name format:

1. From the main window, click the **Parameters** tab.
2. From the **Fiber Auto Naming** panel, set the various parameters according to your needs.

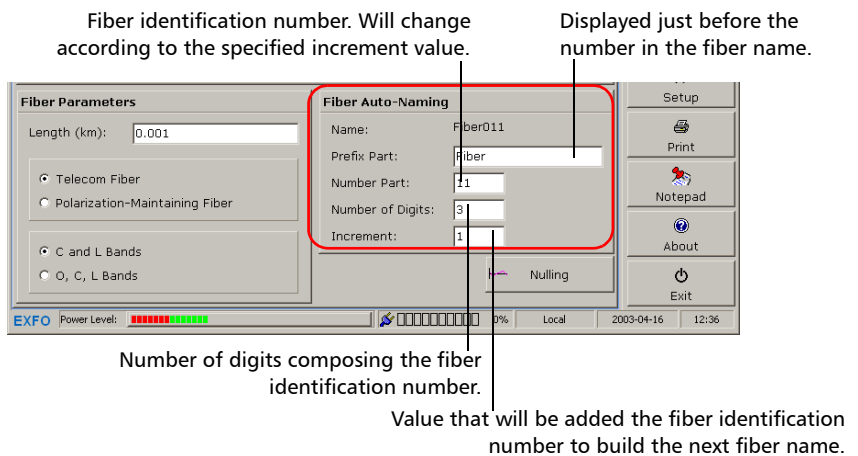

## Setting Up the Polarization Mode Dispersion Analyzer

### Customizing PMD Value and Coefficient Thresholds

# Customizing PMD Value and Coefficient Thresholds

The Polarization Mode Dispersion Analyzer allows you to specify PMD and coefficient values that will be used to determine whether the results are as expected or if they exceed the specified limits.

**Note:** You cannot modify or delete the predefined thresholds provided with your Polarization Mode Dispersion Analyzer.

#### To add a new threshold:

1. From the button bar, click **Setup**.

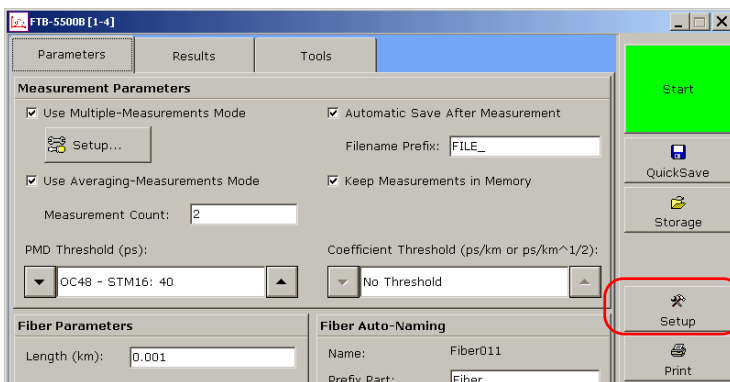

## Setting Up the Polarization Mode Dispersion Analyzer

### Customizing PMD Value and Coefficient Thresholds

- From the **PMD Value** panel, click **Add**.

OR

- From the **PMD Coefficient** panel, click **Add**.

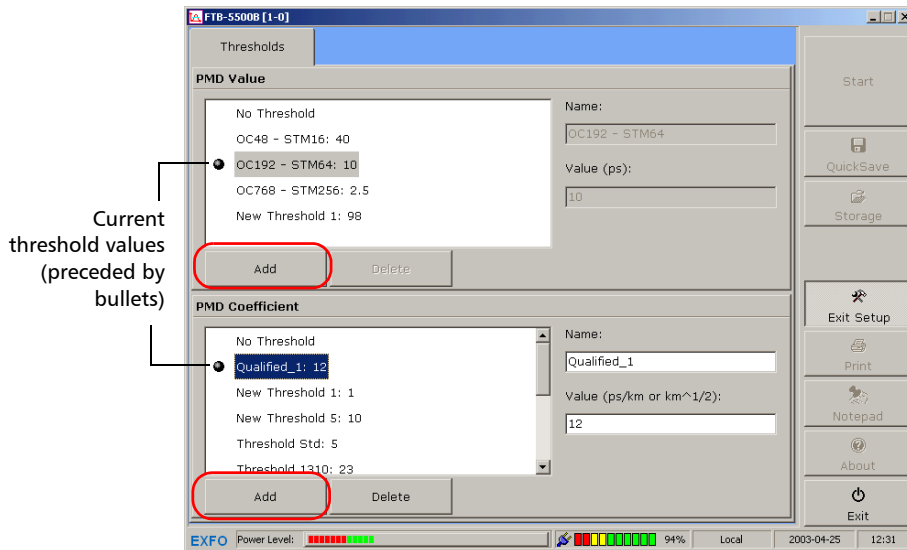

- From the **PMD Value** list, select the threshold that has just been added.

OR

- From the **PMD Coefficient** list, select the threshold that has just been added.

- Fill in the **Name** and **Value** boxes according to your needs.

**Note:** If you want the Polarization Mode Dispersion Analyzer to use this new value next time you will make an acquisition, you will have to set it from the main window **Parameters** tab (see Setting Acquisition Parameters on page 24).

## Setting Up the Polarization Mode Dispersion Analyzer

### *Customizing PMD Value and Coefficient Thresholds*

---

#### **To modify an existing threshold:**

1. From the button bar, click **Setup**.
2. From the **PMD Value** list, select the threshold to be modified.

OR

From the **PMD Coefficient** list, select the threshold to be modified.

3. Modify the contents of the **Name** and **Value** boxes according to your needs.

**Note:** *If you want the Polarization Mode Dispersion Analyzer to use this new value next time you will make an acquisition, you will have to set it from the main window **Parameters** tab (see Setting Acquisition Parameters on page 24).*

## Setting Up the Polarization Mode Dispersion Analyzer

### Customizing PMD Value and Coefficient Thresholds

#### **To delete an existing threshold:**

1. From the button bar, click **Setup**.
2. From the **PMD Value** list, select the threshold to be deleted.

OR

From the **PMD Coefficient** list, select the threshold to be deleted.

3. Click **Delete**.

#### **To return to the main window:**

From the button bar, click **Exit Setup**.

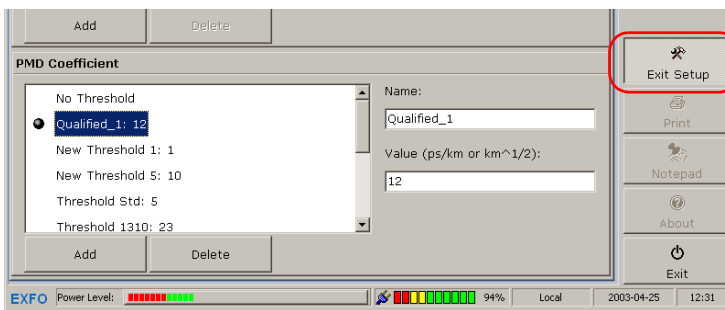

# Setting Up the Polarization Mode Dispersion Analyzer

## Setting Acquisition Parameters

Your FTB-5500B Polarization Mode Dispersion Analyzer allows you to perform both single and multiple acquisitions on fibers. Regardless of the type of acquisition you choose, you must define the parameters that will be taken into account during the measurements. Parameters are kept in memory even after turning off the FTB-500.

These parameters include:

Parameter	Details
Fiber length	Parameter compulsory since it will be used for PMD coefficient calculations. The entered value must be equal to or greater than 0.001 km (1 m).
Fiber type	Must be set to one of the following types: <ul style="list-style-type: none"><li>➤ <b>Telecom</b>; also known as strong coupling. If you are working directly in the field, you will probably use this fiber type.</li><li>➤ <b>Polarization-Maintaining</b>; also known as weak coupling.</li></ul> <p><b>Note:</b> <i>Traces taken with a particular fiber type cannot be reanalyzed with a different fiber type afterwards.</i></p>
Wavelength	Must be set to one of the following values: <ul style="list-style-type: none"><li>➤ <b>C and L Bands</b> covers the 1460 nm to 1675 nm range.</li><li>➤ <b>O, C, L Bands</b> covers the 1260 nm to 1675 nm range.</li></ul> <p><b>Note:</b> <i>Selecting the O, C, L Bands option will make your Polarization Mode Dispersion Analyzer slower in acquiring PMD data.</i></p>
PMD value and coefficient thresholds	Will act as a comparison value to determine whether results are within a specific limit or not.



## Setting Up the Polarization Mode Dispersion Analyzer

*Setting Acquisition Parameters*

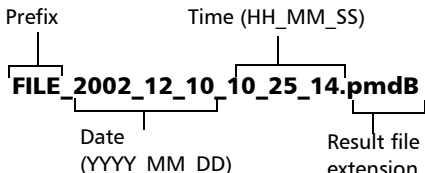
Parameter	Details
Results storage	<p>Offers the following possibilities:</p> <ul style="list-style-type: none"><li>➤ <b>Keep Files in Memory</b> allows you to temporarily store the results in memory for data processing purposes (for example, statistics). However, the more files in memory, the slower the application will be. You may prefer to save results automatically and to process them later.</li><li>➤ <b>Automatic Save After Measurement:</b> When you select this option, the application saves every acquisition automatically. It is particularly useful when taking multiple measurements to avoid saturating memory. It is also possible to save traces manually (see <i>Saving Results Files</i> on page 63).</li><li>➤ You may want to define your own prefix, which will be used as the static part of the automatic file name when a new file is generated.</li></ul> <p>The file will automatically be named in the following format:</p>  <p>The default prefix is <i>FILE</i>.</p>

# Setting Up the Polarization Mode Dispersion Analyzer

## Setting Acquisition Parameters

### To set the acquisition parameters:

1. From the main window, click the **Parameters** tab.
2. From the **Fiber Parameters** panel, set the fiber length, the fiber type and the wavelength.



## IMPORTANT

Ensure that the selected wavelength (bandwidth) is compatible with the wavelength that will be used for your light source.

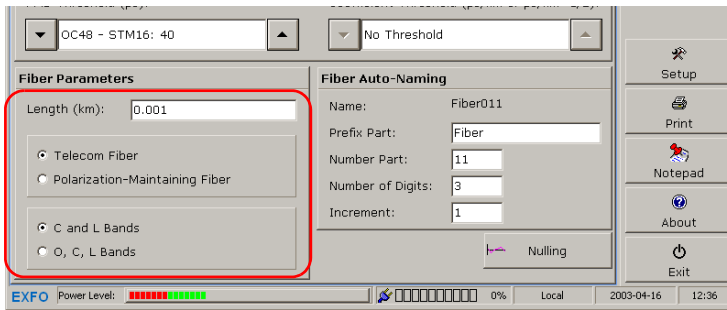

## Setting Up the Polarization Mode Dispersion Analyzer

### Setting Acquisition Parameters

- From the **Measurement Parameters** panel, select the **PMD Threshold** and/or **Coefficient Threshold** list to set the PMD and/or coefficient values.

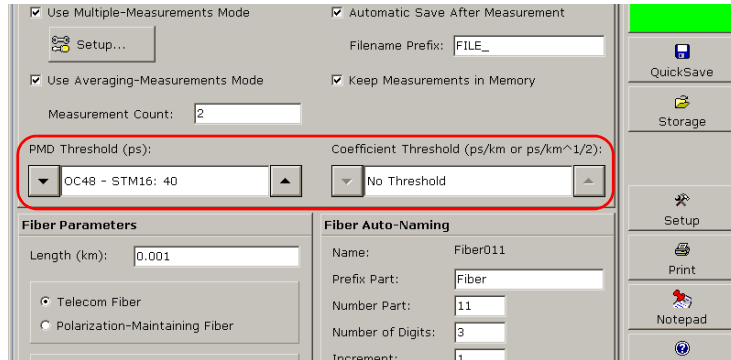

**Note:** If you want to modify the contents of **PMD Threshold** or **Coefficient Threshold** boxes, see Customizing PMD Value and Coefficient Thresholds on page 20.

- Set the data storage parameters.

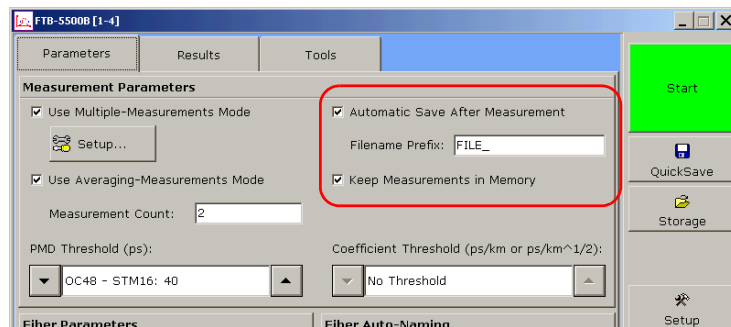

The parameters that you have just set will be used when you make a new acquisition.

# Setting Up the Polarization Mode Dispersion Analyzer

Preparing for Multiple Acquisitions on a Fiber

## Preparing for Multiple Acquisitions on a Fiber

The multiple-measurement mode allows you to make multiple acquisitions on the same fiber by defining the number of measurements and the delay between them. The left part of the status bar indicates the time left until the next measurement.

Results obtained for a specific fiber can be stored in the same file or in distinct files. It is also possible to append new results to an existing file.

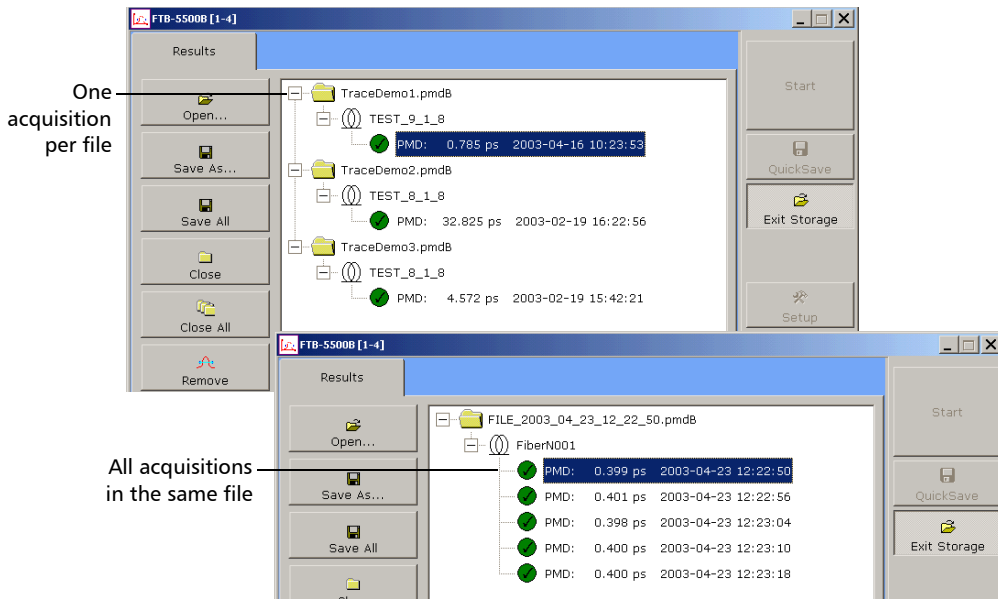

Before being able to use this mode, you must define the general acquisition parameters as well as the parameters that will be specific to multiple acquisitions only.



### IMPORTANT

Do not change the test fiber between two acquisitions of a multiple measurement mode test since parameters set for a specific fiber may not apply to all fibers.

## Setting Up the Polarization Mode Dispersion Analyzer

*Preparing for Multiple Acquisitions on a Fiber*

### To prepare for multiple acquisitions on a fiber:

1. From the main window, click the **Parameters** tab.
2. Set the general acquisition parameters as explained in *Setting Acquisition Parameters* on page 24.
3. From the **Measurement Parameters** panel, select **Use Multiple-Measurements Mode**.

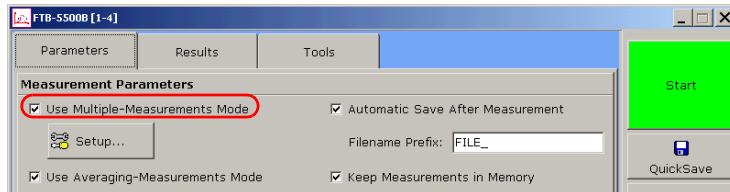

4. From the **Measurement Parameters** panel, click **Setup** to set the parameters.

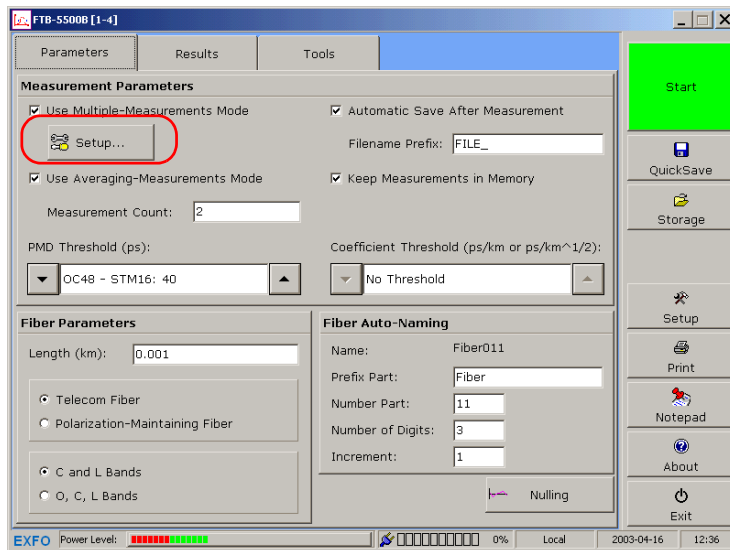

## Setting Up the Polarization Mode Dispersion Analyzer

### *Preparing for Multiple Acquisitions on a Fiber*

---

- In the **Measurement Count** box, specify the number of measurements the Polarization Mode Dispersion Analyzer will take on the same fiber.

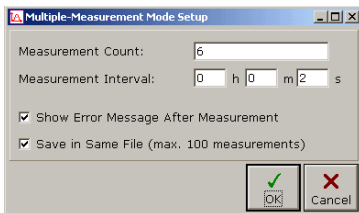

- In the **Measurement Interval** boxes (**h**, **m**, **s**), specify the delay between each measurement.
- If you want the application to prompt you when an error occurs, from the displayed dialog box, select the **Show Error Message After Measurement** check box. However, be aware that, with this option, the application interrupts the current test until someone acknowledges the message.
- If you want all results pertaining to a specific fiber to be saved to the same file, select the **Save in Same File** check box.

Do the same if you want the new results to be appended to an existing file and ensure that the desired file is open before starting the test. For more information on opening result files, see *Viewing Acquisition Results and Information* on page 44.

5. When you are done, click **OK** to confirm the new settings or **Cancel** to discard changes.

The parameters that you have just set will be used when you make a new acquisition.

### Averaging Measurements

When you need extreme precision, you can add one polarization scrambler at the source output port and one at the receiver input port and use the averaging-measurements mode.

This testing mode will average the interferometric envelopes at several states of polarization, which allows very precise measurements. If you intend to use this mode, you must provide a number of measurements (scans) corresponding to the number of polarization states to test.

#### To average measurements:

1. From the main window, click the **Parameters** tab, select the **Use Averaging-Measurements Mode** check box.

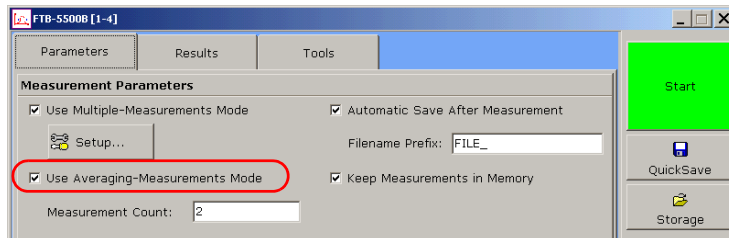

2. In the **Measurement Count** box, enter the number of measurements that will be performed during the averaging process.





# 5 **Operating the Polarization Mode Dispersion Analyzer**

## **Cleaning and Connecting Optical Fibers**



### **IMPORTANT**

To ensure maximum power and to avoid erroneous readings:

- Always inspect fiber ends and make sure that they are clean as explained below before inserting them into the port. EXFO is not responsible for damage or errors caused by bad fiber cleaning or handling.
- Ensure that your patchcord has appropriate connectors. Joining mismatched connectors will damage the ferrules.

#### ***To connect the fiber-optic cable to the port:***

- 1.** Inspect the fiber using a fiber inspection microscope. If the fiber is clean, proceed to connecting it to the port. If the fiber is dirty, clean it as explained below.
- 2.** Clean the fiber ends as follows:
  - 2a.** Gently wipe the fiber end with a lint-free swab dipped in isopropyl alcohol.
  - 2b.** Use compressed air to dry completely.
  - 2c.** Visually inspect the fiber end to ensure its cleanliness.

## Operating the Polarization Mode Dispersion Analyzer

### *Cleaning and Connecting Optical Fibers*

---

- 3.** Carefully align the connector and port to prevent the fiber end from touching the outside of the port or rubbing against other surfaces.

If your connector features a key, ensure that it is fully fitted into the port's corresponding notch.

- 4.** Push the connector in so that the fiber-optic cable is firmly in place, thus ensuring adequate contact.

If your connector features a screwsleeve, tighten the connector enough to firmly maintain the fiber in place. Do not overtighten, as this will damage the fiber and the port.

**Note:** *If your fiber-optic cable is not properly aligned and/or connected, you will notice heavy loss and reflection.*

### Installing the EXFO Universal Interface (EUI)

The EUI fixed baseplate is available for connectors with angled (APC) or non-angled (UPC) polishing. A green border around the baseplate indicates that it is for APC-type connectors.

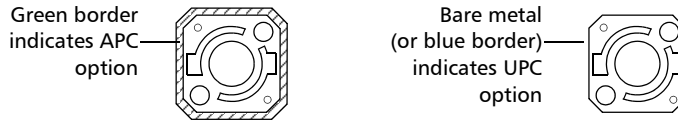

#### To install an EUI connector adapter onto the EUI baseplate:

1. Hold the EUI connector adapter so the dust cap opens downwards.

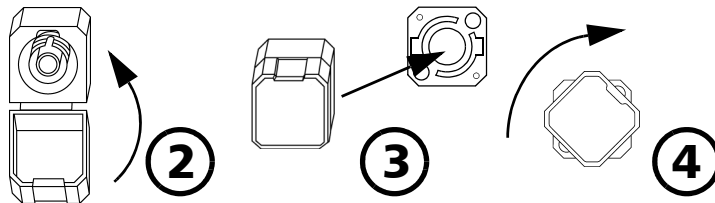

2. Close the dust cap in order to hold the connector adapter more firmly.
3. Insert the connector adapter into the baseplate.
4. While pushing firmly, turn the connector adapter clockwise on the baseplate to lock it in place.

# Operating the Polarization Mode Dispersion Analyzer

Setting Up Hardware for Measurements

## Setting Up Hardware for Measurements

To measure PMD with the FTB-5500B Polarization Mode Dispersion Analyzer, EXFO recommends that you use the FLS-110P Light Source or the FLS-5800 CD/PMD Analyzer Source, which will provide you a larger dynamic range. If you intend to use a third-party light source, see *Using Third-Party Broadband Light Sources* on page 103.

Before making acquisitions, you must prepare your hardware properly.

### To set up hardware for measurements with the FLS-5800 CD/PMD Analyzer Source:

1. Clean and verify the quality of the connectors being used.
2. Connect the device under test (DUT) as shown below.

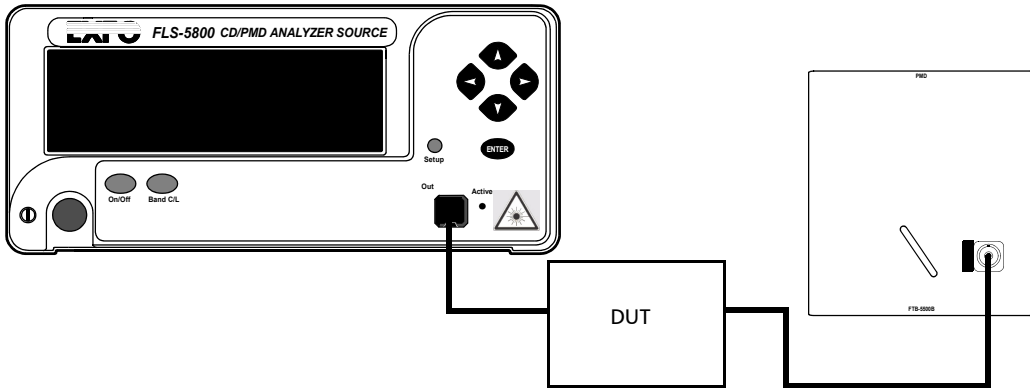

3. Turn on the FLS-5800 CD/PMD Analyzer.
4. Select the C bandwidth.
5. Turn the source on.

**Note:** For more information on the FLS-5800, please refer to the FLS-5800 CD/PMD Analyzer Source user guide included with your product.

## Operating the Polarization Mode Dispersion Analyzer

### Setting Up Hardware for Measurements

---

#### **To set up hardware for measurements using the FLS-110P Light Source:**

1. Clean and verify the quality of the connectors being used.
2. Connect the device under test (DUT) as shown below.

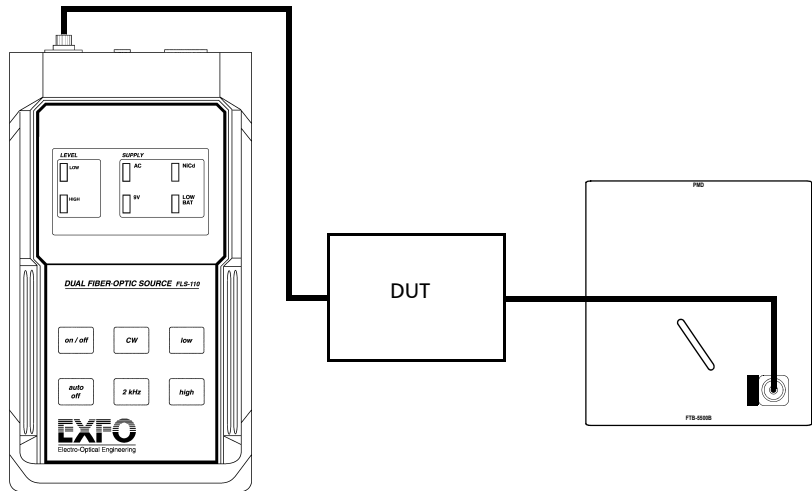

3. Turn on the FLS-110P unit.
4. Press CW to ensure that it is emitting in CW mode.

## Operating the Polarization Mode Dispersion Analyzer

### *Setting Up Hardware for Measurements*

---

5. If applicable, select the C bandwidth.
6. If the FLS-110 Light Source supply indicator flashes, press auto off to deactivate the Auto Off mode. If this mode remains enabled, the light source could stop emitting during the test.
7. Turn the source on.
8. Press high to select the highest output power. The HIGH LED lights up.

**Note:** *The low output power can be used but the accuracy of the PMD will be affected.*

**Note:** *For more information on the FLS-110P, please refer to the FLS-110 Light Source user guide included with your unit.*

### Acquiring Traces

The Polarization Mode Dispersion Analyzer allows you to acquire single or multiple traces on a specific fiber. The results are displayed after each acquisition, which means that, in the multiple measurement mode, if you enter five as the number of acquisitions to be performed, the graph and grid content will be updated five times with new results.

Many devices designed to measure PMD are based on the interferometric method. This method supposes that the obtained curves correspond to Gaussian interferograms. The patented design of the Polarization Mode Dispersion Analyzer proposes a new approach.

To help you making links between the two methods, the application provides you with a Gaussian compliance factor. This factor, multiplied by the obtained PMD value, will give you the value you would obtain with a Gaussian-based approach.

#### **To start an acquisition:**

1. Set acquisition parameters as described in *Setting Acquisition Parameters* on page 24.
2. Verify that the fiber (DUT) is properly connected, that the setup is appropriate, and that the source is activated.
3. From the button bar, click **Start** to start a measurement sequence.

# Operating the Polarization Mode Dispersion Analyzer

## Acquiring Traces

When the measurement is complete, the new PMD results are displayed both in the graph and in the grid.

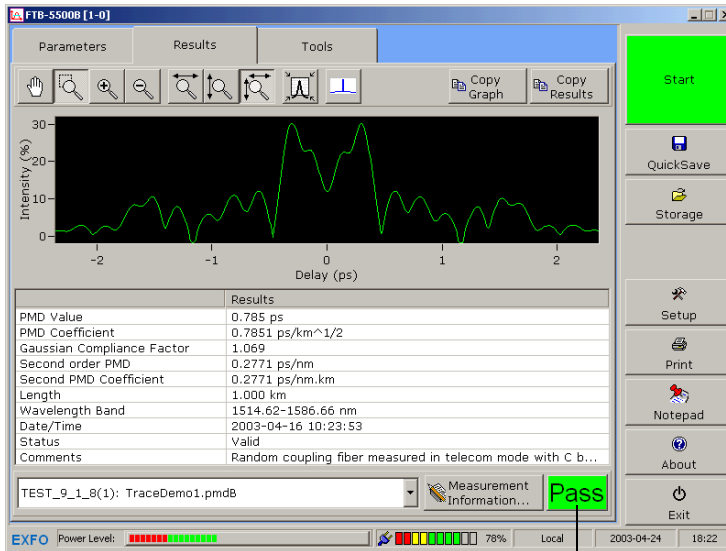

Threshold indicator specifies if measurement exceeded value or not



### Performing a Null Measurement

This feature allows you to perform an offset nulling of your FTB-5500B Polarization Mode Dispersion Analyzer. During this operation, no light should reach the detector port of the Polarization Mode Dispersion Analyzer.

The very first time you insert an FTB-5500B Polarization Mode Dispersion Analyzer into the FTB-500, the application will prompt you for a nulling.

EXFO recommends that you perform a null measurement just before verifying the input power level to ensure the accuracy of the displayed level.

#### To perform a null measurement:

1. From the main window, click the **Parameters** tab. Click **Nulling** and follow the on-screen instructions.

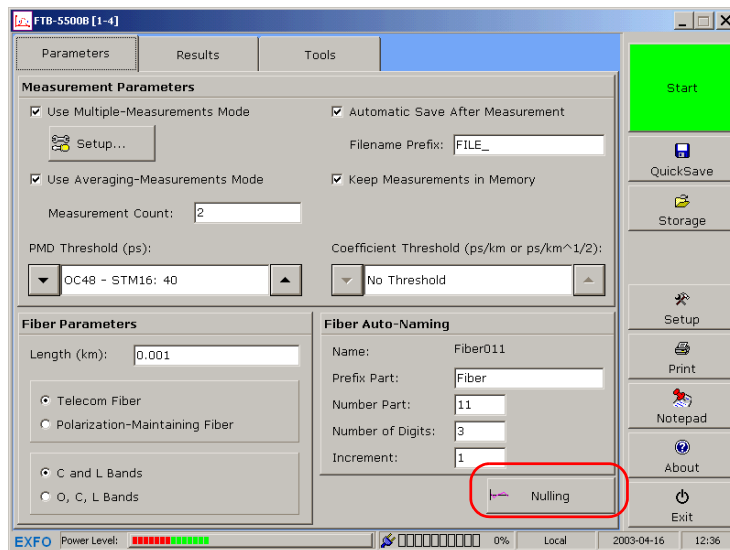

2. When nulling is complete, click **Close**.

### Viewing the Input Power Level

The power level indicator is a visual aid to estimate the incoming signal intensity as detected at the input port. The indicator remains visible at all times at the bottom of the screen, except during acquisitions.

To ensure more accurate readings of the power level, EXFO recommends that you perform a nulling first (see *Performing a Null Measurement* on page 41). The input power level should be in the green area.

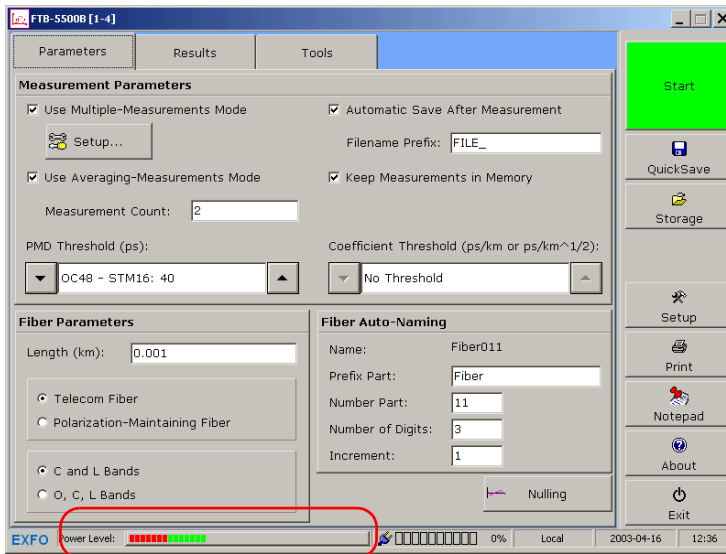

# 6 **Managing Results**

Your FTB-5500B Polarization Mode Dispersion Analyzer allows you to work with two types of results:

- Newly acquired results
- Results loaded from existing files

It also offers customizing, saving, export and printing features based on these results.

## **Customizing Graph View**

With the provided tools, you can zoom in on specific areas of the graph (displayed in the main window **Results** tab) to have a better view. By default, the application zooms in on the most significant area of the graph. You can also choose to display the graph with a black or a white background. Using a white background can be particularly useful before exporting or printing the graph.

## Managing Results

### Viewing Acquisition Results and Information

---

#### **To view specific portions of the graph:**

- Select the desired type of zoom that will be applied when you will press on the FTB-500 screen (or click on the graph with your mouse).
- Select the desired mode (pan, zoom type, etc.).

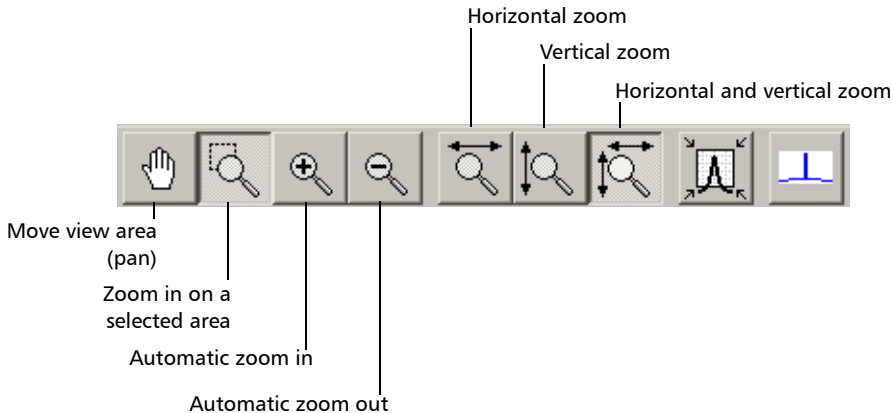

#### **To toggle between the available graph backgrounds:**

Click the  button to select the desired background.

#### **To return to the original graph view:**

Click the  button to revert to most significant graph area.

## Viewing Acquisition Results and Information

The application allows you to view current results and information directly or reload data from existing files.

The application provides:

- a window presenting details for the measurement that you specify
- a window giving you an overview of all of the available measurements

### Reloading Existing Files

You can reload existing files without losing the current results and information.

#### To reload an existing file:

1. From the button bar, click **Storage** and click **Open**.

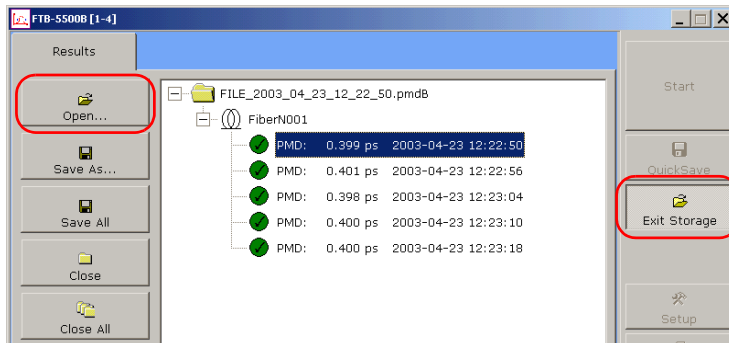

A standard **Open** dialog box is displayed, allowing you to select the desired file.

**Note:** You can speed up file selection by selecting several files at the same time.

2. When you are done, from the displayed dialog box, click **Open** to load the files.
3. From the button bar, click **Exit Storage**.

**Note:** If you omit to select a result from the list, the main window **Results** tab will remain empty until you select one (see Viewing Results on page 46).

# Managing Results

## Viewing Acquisition Results and Information

### Viewing Results

The application presents a graph and a results grid containing details on the specified measurement. It also offers a general view of both current results and reloaded files. In the general view window, you can find a legend of the symbols used to identify the measurement status.

Many devices designed to measure PMD are based on the interferometric method. This method supposes that the obtained curves correspond to Gaussian interferograms. The patented design of the Polarization Mode Dispersion Analyzer proposes a new approach.

To help you making links between the two methods, the application provides you with a Gaussian compliance factor. This factor, multiplied by the obtained PMD value, will give you the value you would obtain with a Gaussian-based approach.

#### To view a specific result and the related information:

1. From the main window **Results** tab, use the arrow next to the measurement selector to specify which measurement to display.

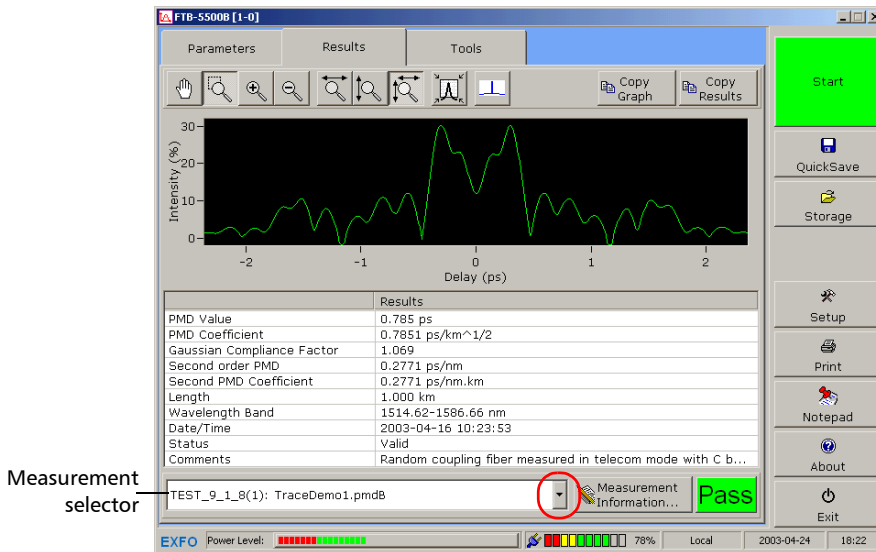

2. From the provided dialog box, select the desired measurement. Click **Select** to confirm your choice or **Cancel** to discard the changes.

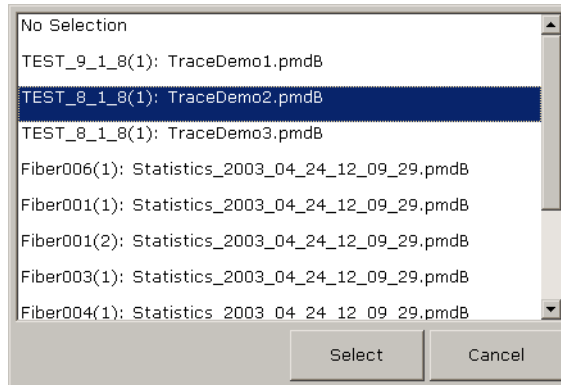

The graph and the grid are automatically updated accordingly.

Since the application displays only one result at a time, if you want distinct fibers to be considered as sections of a single fiber, use the linking feature (see *Linking Distinct Fibers to a Single Fiber* on page 54).

## Managing Results

### Viewing Acquisition Results and Information

#### **To display an overall view of the results:**

From the button bar, click **Storage**. All the current results and open files are listed.

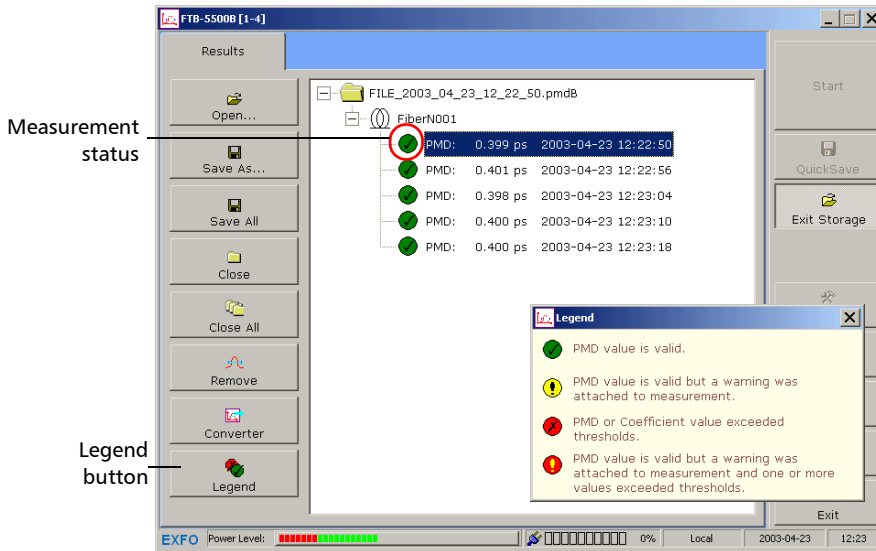

Click **Legend** to display the list of the symbols used.

If you want to modify the information of a specific measurement, see *Documenting Results* on page 58.



## Removing Unwanted Results

When a problem occurs, such as a fiber break, you may want to remove the corresponding erroneous measurement. This could be useful to avoid distorting results and statistics.

**Note:** *You can only remove measurements (not fibers).*



### **IMPORTANT**

If you remove all measurements from a specific file (represented by a ) , this file will be deleted automatically from the hard disk of your FTB-500.

## Managing Results

### Removing Unwanted Results

#### To remove unwanted results:

1. From the button bar, click **Storage**.
2. From the provided list, select the measurement to be removed and click **Remove**.

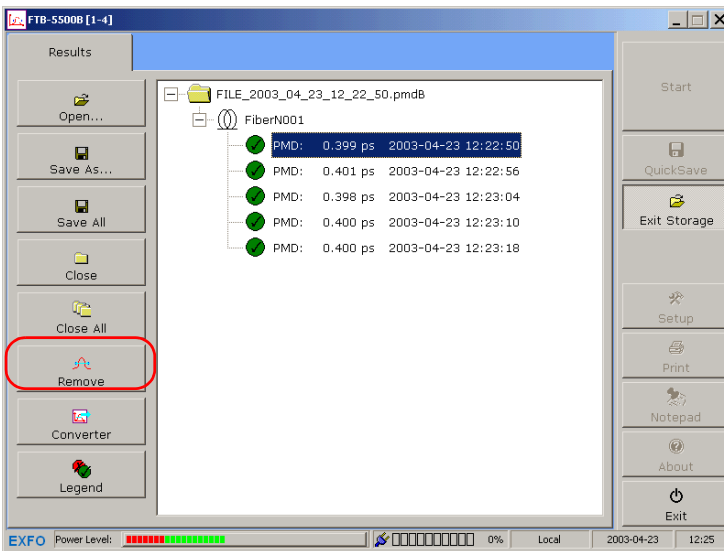

3. A confirmation message will be displayed. Click **Yes** to confirm.
4. Repeat steps 1 to 3 for each measurement you want to remove.

The removal will only be effective if you save the changes (see *Saving Results Files* on page 63). If you want to discard the changes, simply answer “No” when the application will prompt you to save the file.

## **Viewing Statistics**

The FTB-5500B Polarization Mode Dispersion Analyzer offers two types of statistics:

- Single fiber: based on measurements from a specific fiber
- Multiple fiber: based on measurements from one or many fibers

The provided values include mean, standard deviation, minimum and maximum results for PMD value, as well as coefficient.

# Managing Results

## Viewing Statistics

### To view statistics for a single fiber:

1. From the button bar, click **Storage**. Ensure that the results you intend to use are displayed on the list. When you are done, click **Exit Storage**.
2. From the main window, click the Tools tab. Click Single-Fiber Statistics. Statistics for the first fiber on the list appears in the grid.

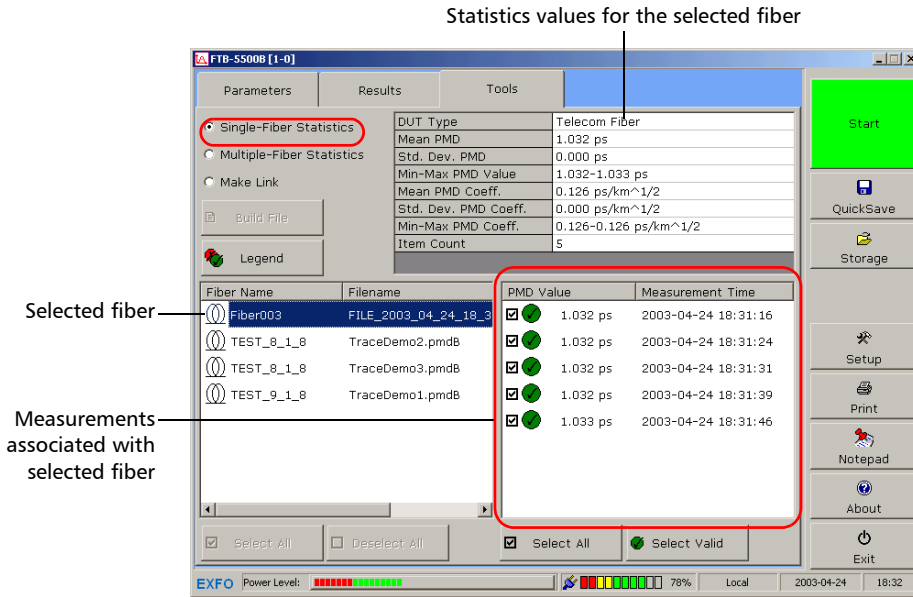

You can specify which measurements must be taken into account for statistics by selecting or clearing the corresponding boxes. The **Select All** button allows you to quickly select all the boxes. The **Select Valid** button selects all the measurements that do not exceed the specified thresholds.

### To view statistics for multiple fibers:

1. From the button bar, click **Storage**. Ensure that the results you intend to use are displayed on the list. When you are done, click **Exit Storage**.
2. Click the **Tools** tab. Select **Multiple-Fiber Statistics**. Statistics based on all the fibers on the list appears in the grid.

Statistics values based on all selected fibers

The screenshot shows the 'Tools' tab with 'Multiple-Fiber Statistics' selected. The interface includes a 'Parameters' tab, a 'Results' tab, and a 'Tools' tab. The 'Tools' tab contains options for 'Single-Fiber Statistics', 'Multiple-Fiber Statistics' (highlighted with a red circle), and 'Make Link'. Below these are buttons for 'Build File' and 'Legend'. A table displays the following statistics:

DUT Type	Telecom Fiber
Mean PMD	11.548 ps
Std. Dev. PMD	18.428 ps
Min-Max PMD Value	0.785-32.825 ps
Mean PMD Coeff.	11.246 ps/km <sup>1/2</sup>
Std. Dev. PMD Coeff.	18.692 ps/km <sup>1/2</sup>
Min-Max PMD Coeff.	0.126-32.825 ps/km <sup>1/2</sup>
Item Count	3

Below the statistics table is a list of fibers with checkboxes for selection:

Fiber Name	Filename	PMD Value	Measurement Time
<input checked="" type="checkbox"/> Fiber003	FILE_2003_04_24_18_3	<input checked="" type="checkbox"/> 1.032 ps	2003-04-24 18:31:16
<input checked="" type="checkbox"/> TEST_8_1_8	TraceDemo2.pmdB	<input checked="" type="checkbox"/> 1.032 ps	2003-04-24 18:31:24
<input checked="" type="checkbox"/> TEST_8_1_8	TraceDemo3.pmdB	<input checked="" type="checkbox"/> 1.032 ps	2003-04-24 18:31:31
<input checked="" type="checkbox"/> TEST_9_1_8	TraceDemo1.pmdB	<input checked="" type="checkbox"/> 1.032 ps	2003-04-24 18:31:39
<input type="checkbox"/> Fiber003		<input type="checkbox"/> 1.033 ps	2003-04-24 18:31:46

At the bottom of the window, there are buttons for 'Select All', 'Deselect All', 'Select All', and 'Select Valid'. A 'Start' button is visible on the right side of the interface.

You can specify which fibers must be taken into account by selecting or clearing the corresponding boxes from the selected fibers list. The **Select All** and **Deselect All** buttons allow you to quickly perform selections.

For each fiber, you can also specify which measurements must be included in statistics. You simply have to click on the desired fiber to display the related measurements and to select or clear the corresponding measurement boxes.

The **Select All** button allows you to quickly select all the boxes.

The **Select Valid** button selects all the measurements that do not exceed the specified thresholds.

## Linking Distinct Fibers to a Single Fiber

The FTB-5500B Polarization Mode Dispersion Analyzer allows you to link distinct fibers so that you can view PMD value and coefficient exactly as if they were sections of a single fiber. This is useful in cases where a long fiber cannot be tested directly from one end to the other.

The application gives information about length, PMD value and coefficient as well as the number of sections in the new fiber. The PMD value for the entire link corresponds to the following equation:

$$\sqrt{\Sigma(\text{PMD}^2)}$$

### ***To view results for the new fiber:***

1. From the button bar, click **Storage**. Ensure that the results you intend to use are displayed on the list. When you are done, click **Exit Storage**.

- From the main window, click the **Tools** tab. Select **Make Link**. Information based on all the fibers on the list appears in the grid.

Results and information based on all selected fibers

The screenshot shows the FTB-55008 software interface. The 'Tools' tab is active, and the 'Make Link' option is selected. The 'Results' section displays summary statistics for all selected fibers:

Length	70 km
Estimated PMD Value	33.168 ps
PMD Coefficient	3.964 ps/km <sup>1/2</sup>
Number of Segments	4

Below this, a table lists the selected fibers and their associated measurements:

Fiber Name	Filename	PMD Value	Measurement Time
<input checked="" type="checkbox"/> Fiber003	FILE_2003_04_24_18_3	<input checked="" type="checkbox"/> 1.032 ps	2003-04-24 18:31:16
<input checked="" type="checkbox"/> TEST_8_1_8	TraceDemo2.pmdB	<input checked="" type="checkbox"/> 1.032 ps	2003-04-24 18:31:24
<input checked="" type="checkbox"/> TEST_8_1_8	TraceDemo3.pmdB	<input checked="" type="checkbox"/> 1.032 ps	2003-04-24 18:31:31
<input checked="" type="checkbox"/> TEST_9_1_8	TraceDemo1.pmdB	<input checked="" type="checkbox"/> 1.032 ps	2003-04-24 18:31:39
		<input type="checkbox"/> 1.033 ps	2003-04-24 18:31:46

Callouts in the image indicate that the first four rows of the table are 'Selected fibers' and the PMD Value and Measurement Time columns are 'Measurements associated with highlighted fiber'. The 'Make Link' button is also circled in red.

You can specify which fibers must be taken into account by selecting or clearing the corresponding boxes from the selected fibers list. The **Select All** and **Deselect All** buttons allow you to quickly perform selections.

For each fiber, you can also specify which measurements must be included in the statistics. Simply select the desired fiber to display the related measurements and select or clear the corresponding measurement boxes.

The **Select All** button allows you to quickly select all the boxes. The **Select Valid** button selects all the measurements that do not exceed the specified thresholds.

# Managing Results

## Creating New Result Files with Selected Fibers

It is possible to merge data taken from distinct files into a single file by selecting the desired fibers. Creating this new file does not affect the original files, unless you explicitly ask to overwrite one of the files.

### To create a new result file:

1. From the button bar, click **Storage**. Ensure that the results you intend to use are displayed on the list. When you are done, click **Exit Storage**.
2. From the main window, click the **Tools** tab. Ensure that **Multiple-Fiber Statistics** or **Make Link** is selected.

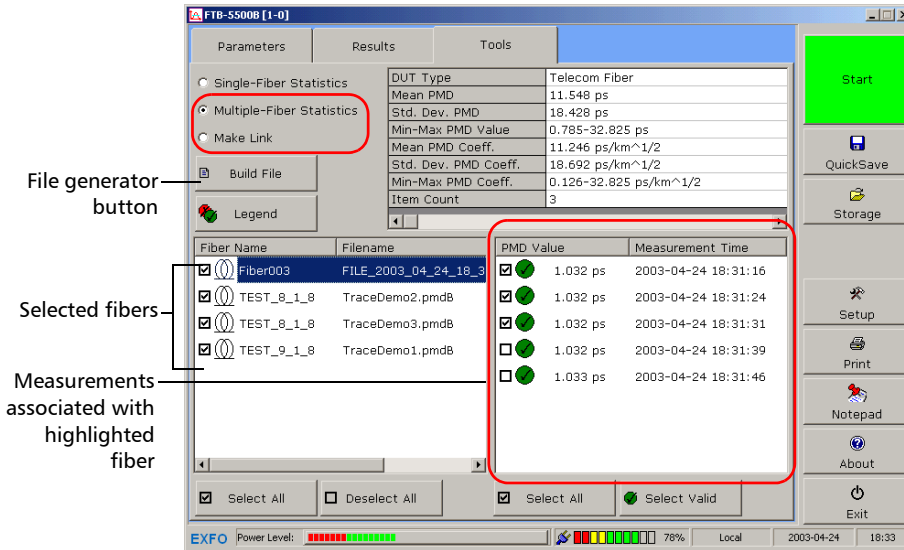

You can specify which fibers must be taken into account by selecting or clearing the corresponding boxes from the selected fibers list. The **Select All** and **Deselect All** buttons allow you to quickly perform selections.



For each fiber, you can also specify which measurements must be included in statistics. Simply select the desired fiber to display the related measurements and select or clear the corresponding measurement boxes.

The **Select All** button allows you to quickly select all the boxes.

The **Select Valid** button selects all the measurements that do not exceed the specified thresholds.

- 3.** From the **Tools** tab, click **Build File**.
- 4.** When prompted, name the file to your convenience and save it.

## Documenting Results

For easier management, you may want to add comments and information about the tests that are performed. It is possible to include general and specific information.

General information concerns jobs, receiver and source. Specific information is related to files, fibers and measurements. This information could be included later in reports or in exported ASCII files.

To speed up general information entry, you can also define a template that will be used for all new tests (see *Defining a Template for Test Information* on page 62).

### ***To add general information:***

1. From the button bar, click **Storage**. Ensure that the results you intend to use are displayed on the list. When you are done, select **Exit Storage**.
2. From the main window, click the **Results** tab.

- 3. To specify which test must be documented, select any measurement related to this test using the measurement selector.

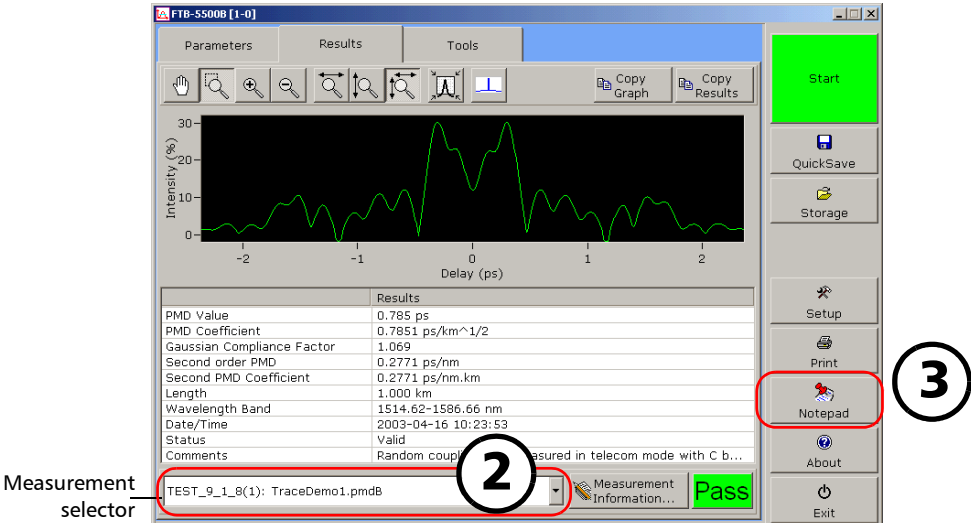

- 4. Click Notepad to access the documentation window.

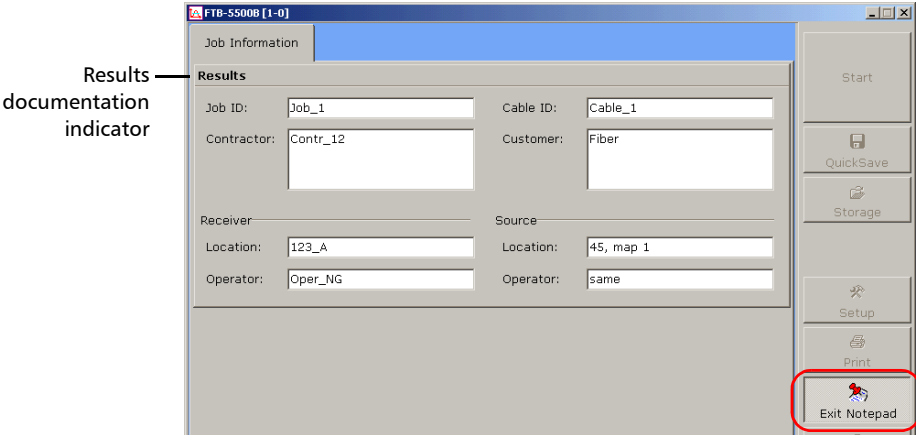

- 5. Fill in the boxes according to your needs. When you are done, click Exit Notepad.

# Managing Results

## Documenting Results

### To add specific information:

1. From the button bar, click **Storage**. Ensure that the results you intend to use are displayed on the list. When you are done, click **Exit Storage**.
2. Select the item you wish to document with the measurement selector and click the **Measurement Information** button to access the documentation window.

The screenshot shows the FTB-5500B software interface. The main window displays a graph of Intensity (%) versus Delay (ps) with a green trace. Below the graph is a table of results:

Results	
PMD Value	0.785 ps
PMD Coefficient	0.7851 ps/km <sup>1/2</sup>
Gaussian Compliance Factor	1.069
Second order PMD	0.2771 ps/nm
Second PMD Coefficient	0.2771 ps/nm.km
Length	1.000 km
Wavelength Band	1514.62-1586.66 nm
Date/Time	2003-04-16 10:23:53
Status	Valid
Comments	Random coupling fiber measured in telecom mode with C b...

At the bottom of the interface, there is a 'Measurement selector' dropdown menu showing 'TEST\_9\_1\_8(1): TraceDemo1.pmdB'. To the right of the dropdown is a 'Measurement Information...' button, which is circled in red. Further right is a green 'Pass' indicator. On the far right, there is a vertical toolbar with buttons for Start, QuickSave, Storage, Setup, Print, Notepad, About, and Exit.

3. Fill in the boxes according to your needs.

Information associated with selected item



## IMPORTANT

Except for comments, all the information that you set for a measurement will be automatically applied to other measurements associated with the same fiber.

The modifications will only be effective if you save them (see *Saving Results Files* on page 63). If you want to discard the changes, simply answer “No” when the application will prompt you to save the file.

## Managing Results

### Defining a Template for Test Information

## Defining a Template for Test Information

It is possible to define a template that will be used to fill the general information boxes of all new tests. This way, you can simply make a few changes instead of having to fill in each box manually.

### **To define a template for test information:**

1. From the main window, click the **Parameters** tab.
2. Click **Notepad** to access the documentation window.

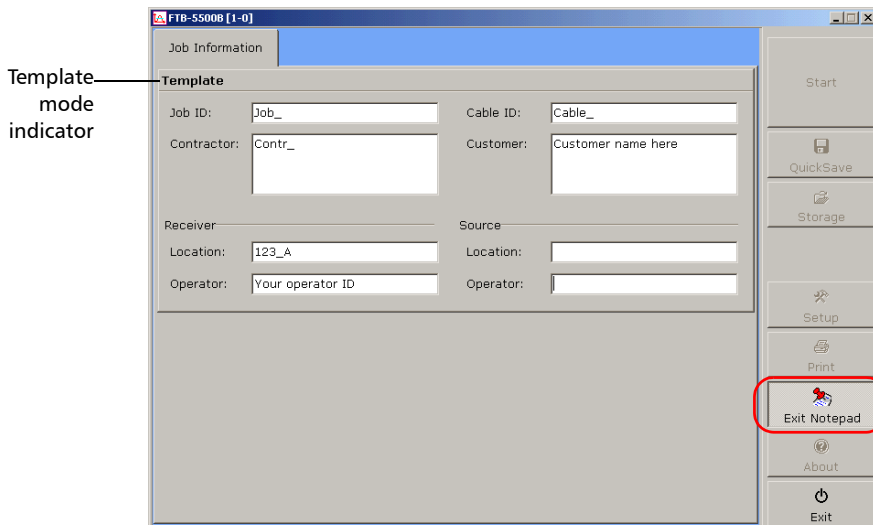

3. Fill in the boxes to build your template to your needs. When you are done, click **Exit Notepad**.

The information you have just entered will be automatically transferred into the corresponding boxes of all the new tests you will perform.

### Saving Results Files

Results files can be saved automatically after each measurement (see *Setting Acquisition Parameters* on page 24) or manually when the need arises (current file or all open files).

**Note:** *Full customization of file names is only possible when saving files manually, one file at a time.*

**Note:** *If former results have not been saved yet, the application prompts you to save them before starting a new test.*

#### To save files:

From the button bar, click **Quick Save** to save all open files at the same time (no file name will be requested).

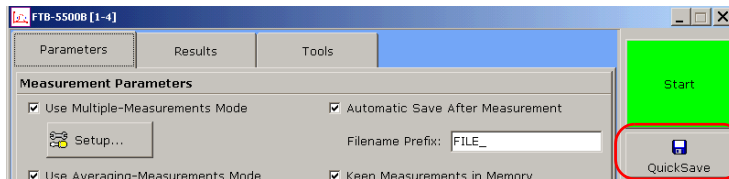

OR

From the button bar, click **Storage**, and click:

- **Save As** to save only the current file (you will be prompted to provide a file name).
- **Save All** to save all open files at the same time (no file name will be requested).

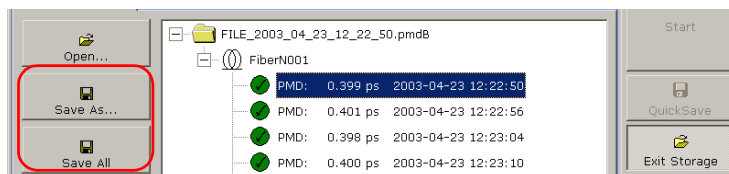

## Managing Results

### *Exporting Results and Graphs*

---

## Exporting Results and Graphs

The FTB-5500B Polarization Mode Dispersion Analyzer offers you the possibility of quickly building your own reports by copying results and graphs to the clipboard. Afterwards, the content of the clipboard can be pasted onto a word-processor document of your choice. Graphs are exported exactly as you see them on the screen (zoom factor and display are kept) except for background.

If you prefer to work with raw data to build your own tables and graphs see *Exporting PMD Files with the File Converter* on page 73.



### **IMPORTANT**

Since information is stored to clipboard, you cannot export both results and graph simultaneously. You must copy them one at a time.



### To export results to clipboard:

1. From the main window **Results** tab, use the measurement selector to specify which measurement must be displayed.

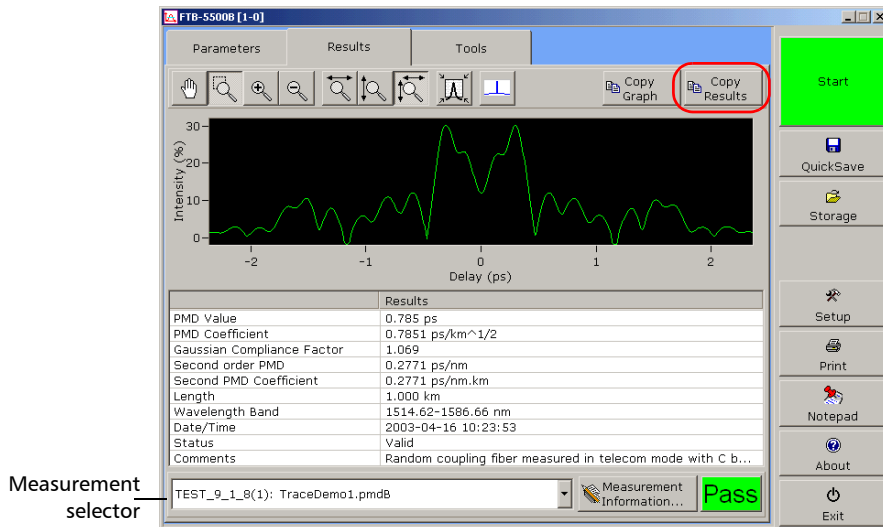

2. Click **Copy Results**.
3. Paste the content of the clipboard onto a word processor document, for example.

# Managing Results

## Exporting Results and Graphs

### To export graphs to clipboard:

1. From the main window **Results** tab, use the measurement selector to specify which measurement must be displayed.

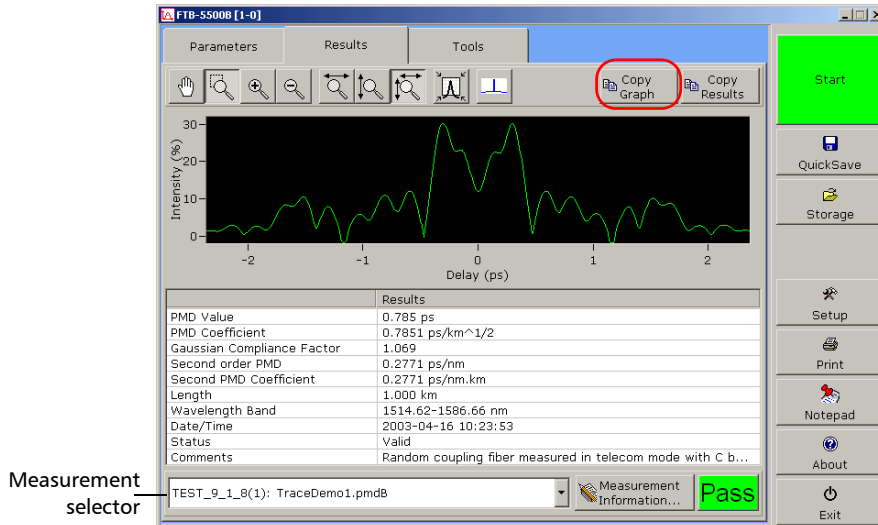

2. Adjust graph display to your needs. For more information, see *Customizing Graph View* on page 43.
3. Click **Copy Graph**.
4. Paste the content of the clipboard onto a word processor document, for example.

## Customizing Reports

The FTB-5500B Polarization Mode Dispersion Analyzer provides many report types that are used for printing. For each type of report, you can specify which information must be included in your document.

### To set up report parameters:

1. From the button bar, click **Print**.

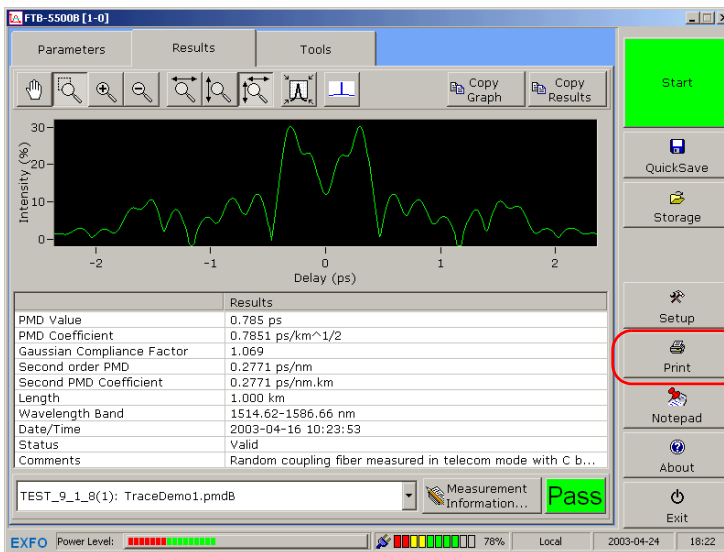

# Managing Results

## Customizing Reports

2. From the **Setup** tab, customize the report to suit your needs.



- You can customize the title by entering it in the **Report Title** box.
  - You can also add a logo by using the **Browse** button.
  - Select the boxes corresponding to the information you want to see in your report and clear those you do not want to see.
3. When you are done, from the button bar, click **Exit Print**. The report parameters are automatically saved for future use.

## Printing Data

The FTB-5500B Polarization Mode Dispersion Analyzer allows you to preview and to print reports containing the test results or statistics from Microsoft Internet Explorer. For information on how to modify report templates, see *Customizing Reports* on page 67.

### To preview or print a report:

1. From the button bar, click **Print**.

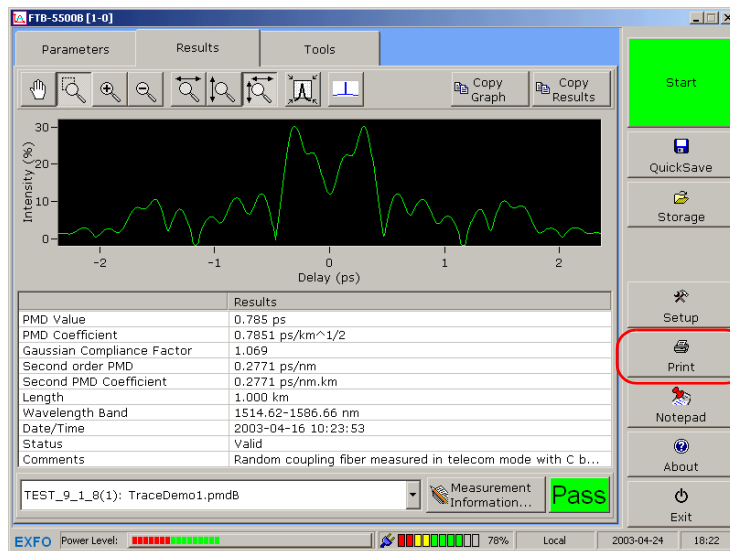

# Managing Results

## Printing Data

2. From the **Print** tab, select the desired report type.

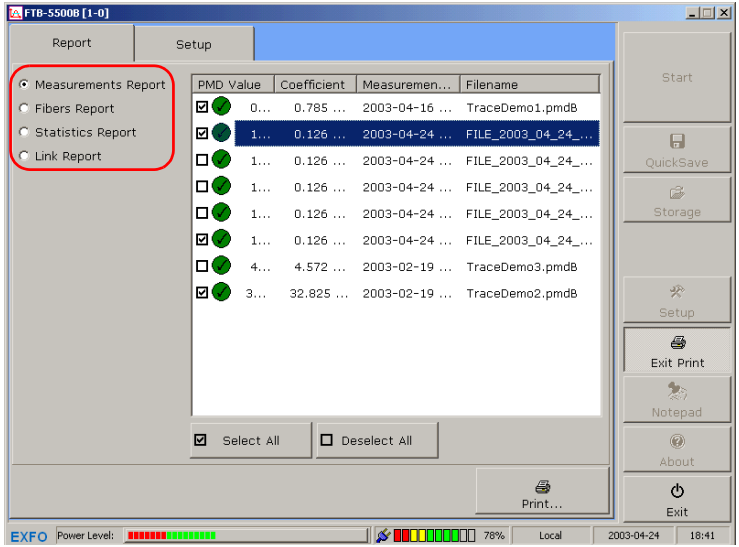

**Note:** If you do not customize the graph appearance, it will be presented with the default settings (no zoom factor).

**Note:** Graphs only appear in reports if you select the **Measurements Report** option.

Select which items must be included. The table below gives you more information on possible selections.

If you have selected...	Specify...
Measurements	Which measurements must be included in the report by selecting the corresponding boxes.  You can also click <b>Select All</b> or <b>Deselect All</b> to quickly select or clear all boxes at the same time.

If you have selected...	Specify...
Fibers	Which fibers must be included in the report by selecting the corresponding boxes. You can also click <b>Select All</b> or <b>Deselect All</b> to quickly select or clear all boxes at the same time.
Statistics	No fiber or measurement selection can be made from the current window. You can select the fibers you want to include, but not the individual measurements.
Link	No fiber or measurement selection can be made from the current window. You can select the fibers you want to include, but not the individual measurements.

3. When you are done, click **Print** to open the preview. If you want to send the document to a printer, use the Print function of Microsoft Internet Explorer.
4. From the button bar, click **Exit Print** to return to the main window.

## Closing Result Files

For easier result management, you may want to close the result files manually.

**Note:** *You do not need to close files manually before exiting the Polarization Mode Dispersion Analyzer application. You will be prompted if some result files have not been saved.*

### To close files:

1. From the button bar, click **Storage**, and click:
  - **Close** to close only the current file.
  - **Close All** to close all open files at the same time.

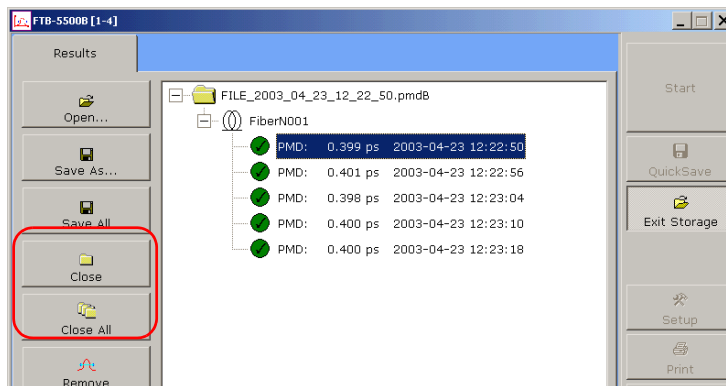

2. When you are done, from the button bar, click **Exit Storage** to return to the main window.



# **7** *Exporting PMD Files with the File Converter*

The File Converter tool has been designed to export PMD files to specific formats:

- From PMD-5500 files to PMD-5500B files (allows to load files created with former PMD Analyzer)
- From PMD-5500 files to ASCII files
- From PMD-5500B files to ASCII files

You can also fully customize the contents of the generated files by exporting only the information you need.

## Exporting PMD Files with the File Converter

### Starting and Exiting the File Converter

## Starting and Exiting the File Converter

### To start the converter:

- From ToolBox, click the **Applications** tab. Click **PMD File ImportExport**.

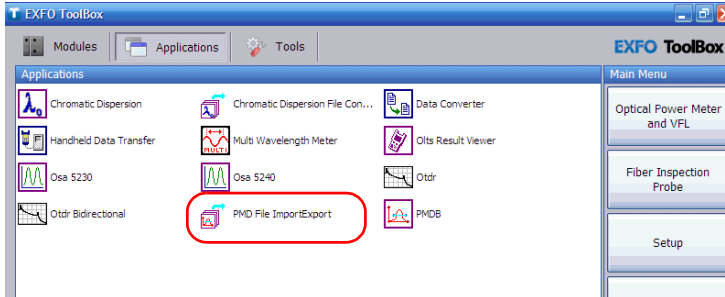

OR

- From the FTB-5500B Polarization Mode Dispersion Analyzer application, click the **Storage** button. Click **Converter**.

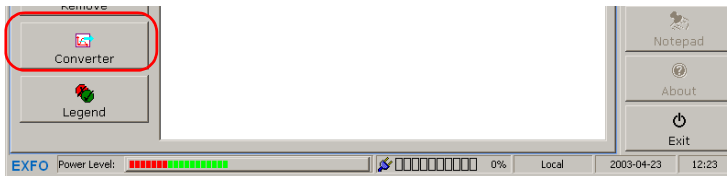

## Exporting PMD Files with the File Converter

### *Starting and Exiting the File Converter*

The File Converter main window is displayed.

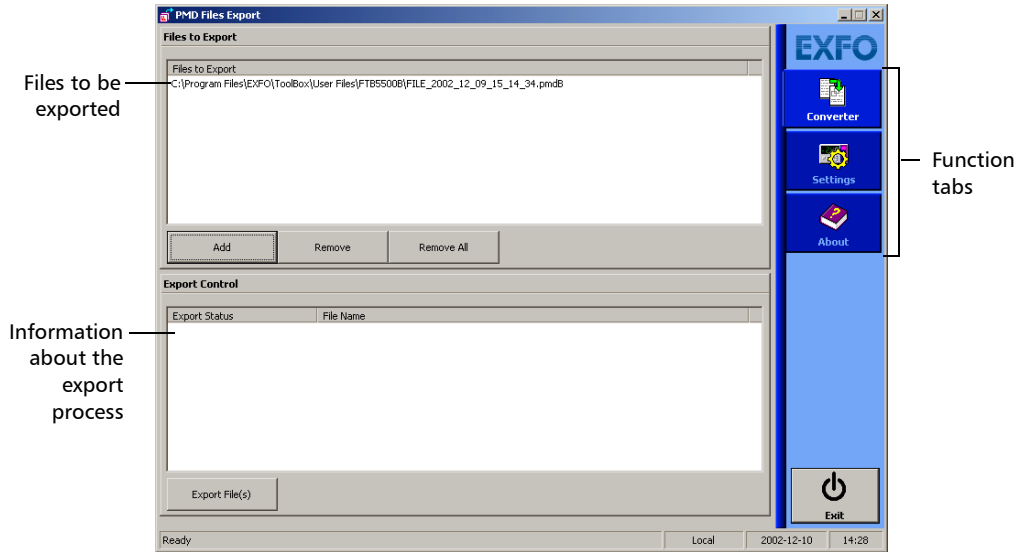

### **To exit the converter:**

- Click **X** (in the top right corner of the main window).
- Click the **Exit** button located at the bottom of the function bar.

## Setting Export Parameters

Before exporting data from one format to another, you must define:

- Which information must be exported: You can export general test information (fiber ID, thresholds, PMD value, etc.) as well as points from the acquired traces. This is particularly useful if you intend to build your own graphs using Microsoft Excel, for instance.
- The conversion type (from PMD-5500 to PMD-5500B, from PMD-5500 to ASCII or from PMD-5500B to ASCII).
- Where to export files.

The parameters you set will remain unchanged until you choose to modify them. They will still be available after the computer has shut down.

### **To set export parameters:**

1. Open the File Converter tool (see *Starting and Exiting the File Converter* on page 74).
2. Select the desired conversion type.

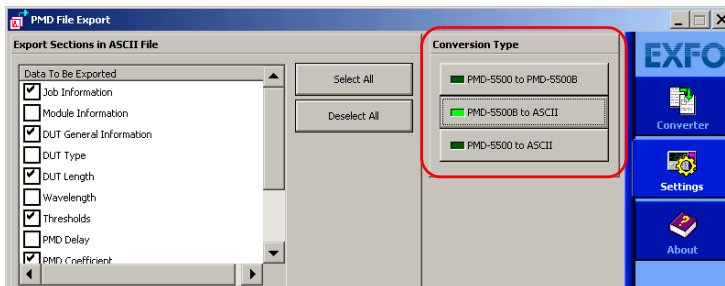

3. If you selected a conversion to the ASCII format, from the **Settings** function tab, select all the boxes corresponding to the information you want to export.

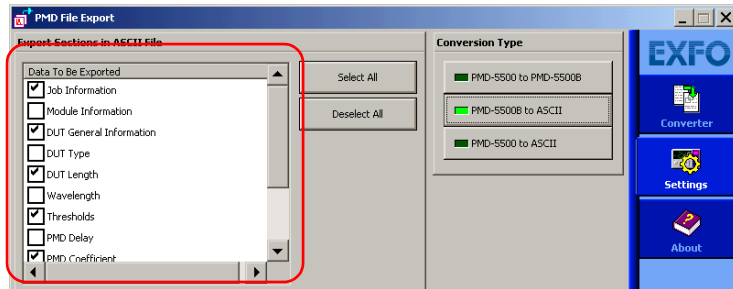

**Note:** If you select *Interferometric Envelope*, all points acquired during the test will be exported.

4. From the **Export Folder** panel, click the **Browse** button to specify in which folder the exported files will be stored.



### Exporting PMD Files

Once the export parameters are set, you are now ready to start exporting PMD files. Files that cannot be exported (for example, corrupt files) will be skipped and their export status will change to “Failed”.



#### IMPORTANT

To avoid errors during file export, ensure that all the files you intend to use are closed. A file that is selected in the Results tab of the Polarization Mode Dispersion Analyzer main window is considered open.

#### **To export PMD files:**

1. If necessary, close the files that you want to export (see *Closing Result Files* on page 72).
2. If necessary, start the converter (see *Starting and Exiting the File Converter* on page 74).
3. If necessary, set up the export parameters (see *Setting Export Parameters* on page 76).
4. Click the **Converter** function tab of the File Converter.

**5.** Select the files.

**5a.** From the **Files to Export** panel, click **Add**.

A standard **Open** dialog box is displayed, allowing you to choose the desired file(s).

**Note:** You can speed up file selection by selecting several files at the same time.

**5b.** When you are done, click **Open** to transfer the files to the list.

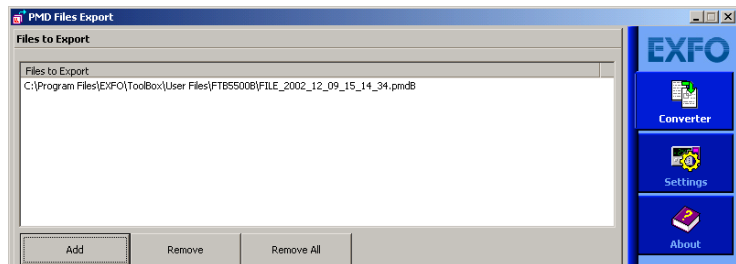

You can remove a specific file by selecting it and clicking **Remove**. If you want to quickly empty the list, click **Remove All**.

**6.** From the **Export Control** panel, click the **Export File(s)** button to start the export process.

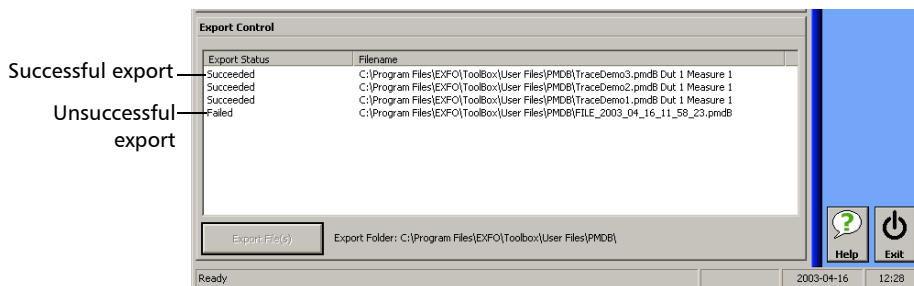





## 8 **Maintenance**

To help ensure long, trouble-free operation:

- Always inspect fiber-optic connectors before using them and clean them if necessary.
- Keep the unit free of dust.
- Clean the unit casing and front panel with a cloth slightly dampened with water.
- Store unit at room temperature in a clean and dry area. Keep the unit out of direct sunlight.
- Avoid high humidity or significant temperature fluctuations.
- Avoid unnecessary shocks and vibrations.
- If any liquids are spilled on or into the unit, turn off the power immediately and let the unit dry completely.



### **WARNING**

Use of controls, adjustments, and procedures for operation and maintenance other than those specified herein may result in hazardous radiation exposure.

## Cleaning Fixed Connectors

Regular cleaning of connectors will help maintain optimum performance. *Do not try to disassemble the unit. Doing so would break the connector.*

**To clean fixed connectors:**

1. Fold a lint-free wiping cloth in four to form a square.
2. Moisten the center of the lint-free wiping cloth with *only one drop* of isopropyl alcohol.



### IMPORTANT

Alcohol may leave traces if used abundantly. Avoid contact between the tip of the bottle and the wiping cloth, and do not use bottles that distribute too much alcohol at a time.

3. Gently wipe the connector threads three times with the folded and moistened section of the wiping cloth.



### IMPORTANT

Isopropyl alcohol takes approximately ten seconds to evaporate. Since isopropyl alcohol is not absolutely pure, evaporation will leave microscopic residue. Make sure you dry the surfaces before evaporation occurs.

4. With a dry lint-free wiping cloth, gently wipe the same surfaces three times with a rotating movement.
5. Throw out the wiping cloths after one use.

6. Moisten a cleaning tip (2.5 mm tip) with *only one drop* of isopropyl alcohol.



## IMPORTANT

Alcohol may leave traces if used abundantly. Avoid contact between the tip of the bottle and the cleaning tip, and do not use bottles that distribute too much alcohol at a time.

7. Slowly insert the cleaning tip into the connector until it reaches the ferrule inside (a slow clockwise rotating movement may help).

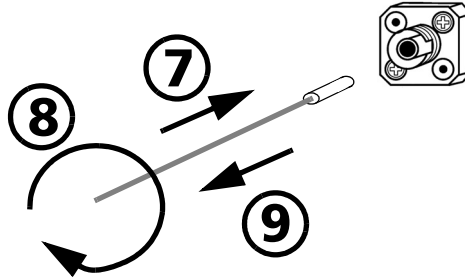

8. Gently turn the cleaning tip one full turn.
9. Continue to turn as you withdraw the cleaning tip.
10. Repeat steps 7 to 9, but this time with a dry cleaning tip (2.5 mm tip provided by EXFO).

**Note:** *Make sure you don't touch the soft end of the cleaning tip and verify the cleanliness of the cotton tip.*

11. Throw out the cleaning tips after one use.

## Cleaning EUI Connectors

Regular cleaning of EUI connectors will help maintain optimum performance. There is no need to disassemble the unit.



### **IMPORTANT**

If any damage occurs to internal connectors, the module casing will have to be opened and a new calibration will be required.

**To clean EUI connectors:**

1. Remove the EUI from the instrument to expose the connector baseplate and ferrule.

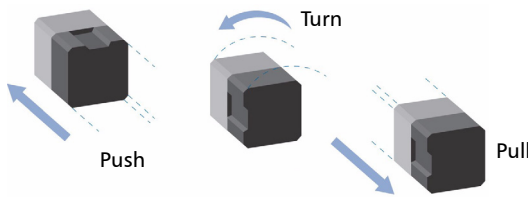

2. Moisten a 2.5 mm cleaning tip with *one drop* of isopropyl alcohol (alcohol may leave traces if used abundantly).
3. Slowly insert the cleaning tip into the EUI adapter until it comes out on the other side (a slow clockwise rotating movement may help).

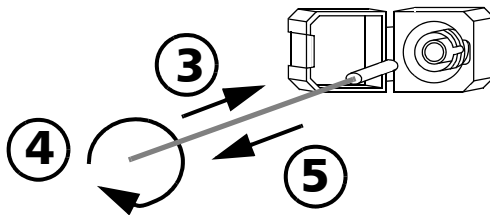

4. Gently turn the cleaning tip one full turn, then continue to turn as you withdraw it.

5. Repeat steps 3 to 4 with a dry cleaning tip.

**Note:** *Make sure you don't touch the soft end of the cleaning tip.*

6. Clean the ferrule in the connector port as follows:

**6a.** Deposit *one drop* of isopropyl alcohol on a lint-free wiping cloth.



## IMPORTANT

Isopropyl alcohol may leave residues if used abundantly or left to evaporate (about 10 seconds).

**Avoid contact between the tip of the bottle and the wiping cloth, and dry the surface quickly.**

- 6b.** Gently wipe the connector and ferrule.
- 6c.** With a dry lint-free wiping cloth, gently wipe the same surfaces to ensure that the connector and ferrule are perfectly dry.
- 6d.** Verify connector surface with a portable fiber-optic microscope (for example, EXFO's FOMS) or fiber inspection probe (for example, EXFO's FIP).



## WARNING

**Verifying the surface of the connector WHILE THE UNIT IS ACTIVE WILL result in permanent eye damage.**

7. Put the EUI back onto the instrument (push and turn clockwise).
8. Throw out cleaning tips and wiping cloths after one use.

## Recalibrating the Unit

Manufacturing and service center calibrations are based on the ISO/IEC 17025 Standard, which states that calibration documents must not contain a recommended calibration interval, unless this has been previously agreed upon with the customer.

Validity of specifications depends on operating conditions. For example, the calibration validity period can be longer or shorter depending on the intensity of use, environmental conditions and unit maintenance. You should determine the adequate calibration interval for your unit according to your accuracy requirements.

Under normal use, EXFO recommends calibrating your unit every year.

## **Recycling and Disposal (Applies to European Union Only)**



Recycle or dispose of your product (including electric and electronic accessories) properly, in accordance with local regulations. Do not dispose of it in ordinary garbage receptacles.

This equipment was sold after August 13, 2005 (as identified by the black rectangle).

- Unless otherwise noted in a separate agreement between EXFO and a customer, distributor, or commercial partner, EXFO will cover costs related to the collection, treatment, recovery, and disposal of end-of-lifecycle waste generated by electronic equipment introduced after August 13, 2005 to an European Union member state with legislation regarding Directive 2002/96/EC.
- Except for reasons of safety or environmental benefit, equipment manufactured by EXFO, under its brand name, is generally designed to facilitate dismantling and reclamation.

For complete recycling/disposal procedures and contact information, visit the EXFO Web site at [www.exfo.com/recycle](http://www.exfo.com/recycle).





# 9 Troubleshooting

## Solving Common Problems

Before calling EXFO's technical support, you may want to consider the following solutions to problems that could occur.

Message	Possible cause	Solution
Detected signal is out of user selected band.	No signal detected in the selected band. However, another signal has been detected outside the specified band. The application will try to take a measurement using the specified band.	<ul style="list-style-type: none"> <li>➤ Ensure the source is on.</li> <li>➤ Ensure the source wavelength matches the selected band for the Polarization Mode Dispersion Analyzer.</li> </ul>
Strong signal detected out of the selected band. Measurement may be erroneous.	Signal detected in the selected band. However, another strong signal has been detected elsewhere on the whole measurement band. Measurement accuracy can be affected.	Turn off the sources emitting at wavelengths that do not match the selected band for the Polarization Mode Dispersion Analyzer.
Narrowband optical source detected. Measurement may be erroneous.	The source being used has a very narrow bandwidth that prevents an accurate PMD measurement.	<ul style="list-style-type: none"> <li>➤ Use a LED or SLED source.</li> <li>➤ Ensure no narrow source is used for the selected band.</li> </ul>
The frequency range of signal is out of measuring range. The acquisition operation was canceled.	The frequency range of signal is out of measuring range (160 THz to 250 THz).	<ul style="list-style-type: none"> <li>➤ Use a source with a wavelength matching the Polarization Mode Dispersion Analyzer bands.</li> <li>➤ Ensure that the source power is sufficient.</li> </ul>

## Troubleshooting

### *Solving Common Problems*

---

<b>Message</b>	<b>Possible cause</b>	<b>Solution</b>
Low signal-to-noise ratio.	Power too-low in the selected band.	<ul style="list-style-type: none"><li>➤ Use a source with a higher output power.</li><li>➤ Clean connectors carefully.</li><li>➤ Ensure connections are made properly.</li><li>➤ Ensure the source wavelength matches the selected band for the Polarization Mode Dispersion Analyzer.</li></ul>
Possible coupling mode selection error.	The selected coupling mode (Telecom or Polarization-Maintaining) does not match the coupling mode the Polarization Mode Dispersion Analyzer detects. Calculation will be performed using the selected coupling mode.	Ensure that the selected coupling mode is appropriate.
The signal is too low to compute a PMD value. The acquisition operation was canceled.	<ul style="list-style-type: none"><li>➤ Power too-low in the selected band.</li><li>➤ The source being used is modulated.</li></ul>	<ul style="list-style-type: none"><li>➤ Ensure the input power is sufficient.</li><li>➤ Use a LED or SLED source.</li></ul>
The signal is saturated. Unable to compute PMD value. The acquisition operation was canceled.	Power is too high.	Reduce the source output power.

<b>Message</b>	<b>Possible cause</b>	<b>Solution</b>
Specifications not guaranteed, retesting recommended.	<p>The PMD value might not be within the unit's specification:</p> <ul style="list-style-type: none"><li>➤ Your PMD Analyzer measures low PMD values from a weak coupling device (for example, PMF) and analyzer input polarization state is not appropriate.</li><li>➤ External parasitic signal during measurement (for example, live fiber).</li></ul>	<ul style="list-style-type: none"><li>➤ Move fiber or device slightly to change polarization state and retest.</li><li>➤ Remove parasitic signal and retest.</li></ul>

# Viewing Online Documentation

An online version of the FTB-5500B Polarization Mode Dispersion Analyzer user guide is available at all times from the application.

**To access the online user guide:**

Click **Help** in the function bar.

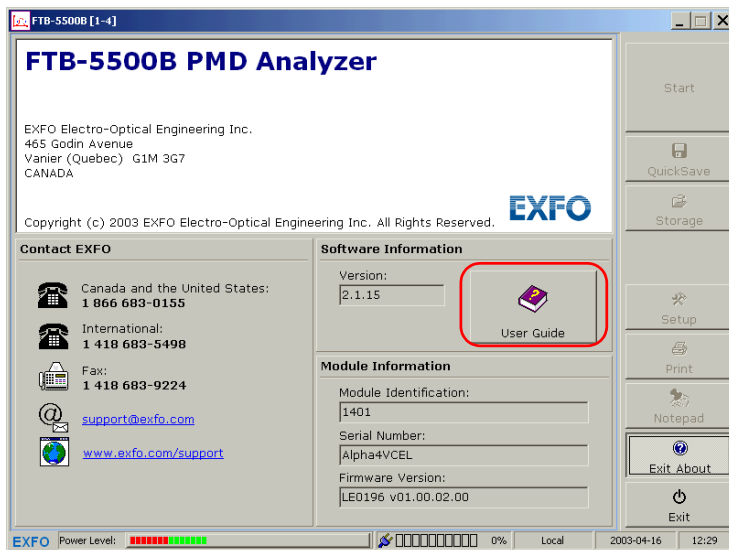

## Contacting the Technical Support Group

To obtain after-sales service or technical support for this product, contact EXFO at one of the following numbers. The Technical Support Group is available to take your calls from Monday to Friday, 8:00 a.m. to 7:00 p.m. (Eastern Time in North America).

For detailed information about technical support, visit the EXFO Web site at [www.exfo.com](http://www.exfo.com).

To accelerate the process, please have information such as the name and the serial number (see the product identification label—an example is shown below), as well as a description of your problem, close at hand.

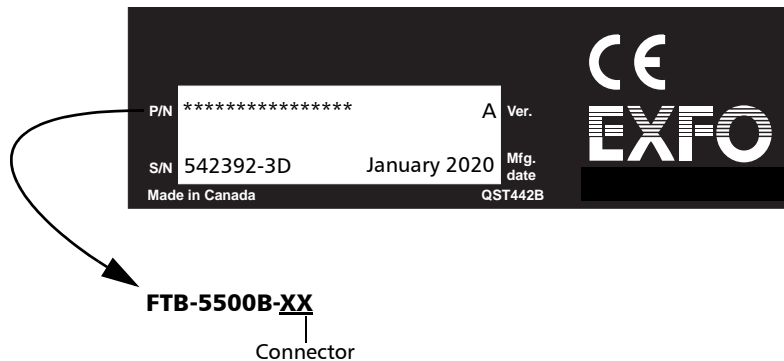

## Troubleshooting

### Transportation

You may also be requested to provide software and module version numbers. This information, as well as technical support contact information, can be found by clicking **About** in the function bar

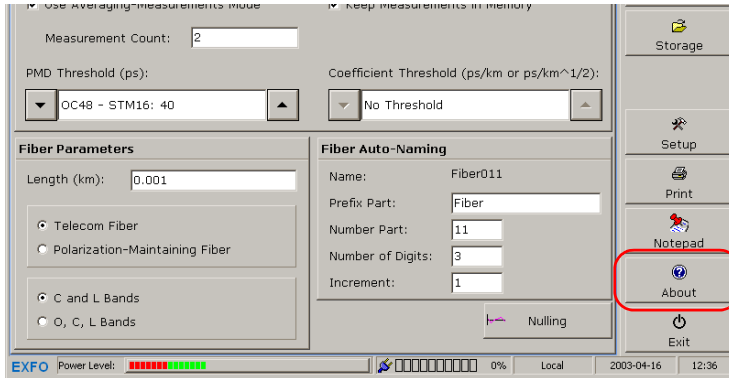

## Transportation

Maintain a temperature range within specifications when transporting the unit. Transportation damage can occur from improper handling. The following steps are recommended to minimize the possibility of damage:

- Pack the unit in its original packing material when shipping.
- Avoid high humidity or large temperature fluctuations.
- Keep the unit out of direct sunlight.
- Avoid unnecessary shocks and vibrations.

# 10 Warranty

## General Information

EXFO Electro-Optical Engineering Inc. (EXFO) warrants this equipment against defects in material and workmanship for a period of one year from the date of original shipment. EXFO also warrants that this equipment will meet applicable specifications under normal use.

During the warranty period, EXFO will, at its discretion, repair, replace, or issue credit for any defective product, as well as verify and adjust the product free of charge should the equipment need to be repaired or if the original calibration is erroneous. If the equipment is sent back for verification of calibration during the warranty period and found to meet all published specifications, EXFO will charge standard calibration fees.



### IMPORTANT

The warranty can become null and void if:

- unit has been tampered with, repaired, or worked upon by unauthorized individuals or non-EXFO personnel.
- warranty sticker has been removed.
- case screws, other than those specified in this guide, have been removed.
- case has been opened, other than as explained in this guide.
- unit serial number has been altered, erased, or removed.
- unit has been misused, neglected, or damaged by accident.

THIS WARRANTY IS IN LIEU OF ALL OTHER WARRANTIES EXPRESSED, IMPLIED, OR STATUTORY, INCLUDING, BUT NOT LIMITED TO, THE IMPLIED WARRANTIES OF MERCHANTABILITY AND FITNESS FOR A PARTICULAR PURPOSE. IN NO EVENT SHALL EXFO BE LIABLE FOR SPECIAL, INCIDENTAL, OR CONSEQUENTIAL DAMAGES.

## **Warranty**

### *Liability*

---

## **Liability**

EXFO shall not be liable for damages resulting from the use of the product, nor shall be responsible for any failure in the performance of other items to which the product is connected or the operation of any system of which the product may be a part.

EXFO shall not be liable for damages resulting from improper usage or unauthorized modification of the product, its accompanying accessories and software.



## Exclusions

EXFO reserves the right to make changes in the design or construction of any of its products at any time without incurring obligation to make any changes whatsoever on units purchased. Accessories, including but not limited to fuses, pilot lamps, batteries and universal interfaces (EUI) used with EXFO products are not covered by this warranty.

This warranty excludes failure resulting from: improper use or installation, normal wear and tear, accident, abuse, neglect, fire, water, lightning or other acts of nature, causes external to the product or other factors beyond the control of EXFO.



### **IMPORTANT**

EXFO will charge a fee for replacing optical connectors that were damaged due to misuse or bad cleaning.

## Certification

EXFO certifies that this equipment met its published specifications at the time of shipment from the factory.

## Service and Repairs

EXFO commits to providing product service and repair for five years following the date of purchase.

**To send any equipment for service or repair:**

1. Call one of EXFO's authorized service centers (see *EXFO Service Centers Worldwide* on page 99). Support personnel will determine if the equipment requires service, repair, or calibration.
2. If equipment must be returned to EXFO or an authorized service center, support personnel will issue a Return Merchandise Authorization (RMA) number and provide an address for return.
3. If possible, back up your data before sending the unit for repair.
4. Pack the equipment in its original shipping material. Be sure to include a statement or report fully detailing the defect and the conditions under which it was observed.
5. Return the equipment, prepaid, to the address given to you by support personnel. Be sure to write the RMA number on the shipping slip. *EXFO will refuse and return any package that does not bear number.*

**Note:** *A test setup fee will apply to any returned unit that, after test, is found to meet the applicable specifications.*

After repair, the equipment will be returned with a repair report. If the equipment is not under warranty, you will be invoiced for the cost appearing on this report. EXFO will pay return-to-customer shipping costs for equipment under warranty. Shipping insurance is at your expense.

Routine recalibration is not included in any of the warranty plans. Since calibrations/verifications are not covered by the basic or extended warranties, you may elect to purchase FlexCare Calibration/Verification Packages for a definite period of time. Contact an authorized service center (see *EXFO Service Centers Worldwide* on page 99).

## **EXFO Service Centers Worldwide**

If your product requires servicing, contact your nearest authorized service center.

### **EXFO Headquarters Service Center**

400 Godin Avenue  
Quebec (Quebec) G1M 2K2  
CANADA

1 866 683-0155 (USA and Canada)

Tel.: 1 418 683-5498

Fax: 1 418 683-9224

[quebec.service@exfo.com](mailto:quebec.service@exfo.com)

### **EXFO Europe Service Center**

Omega Enterprise Park, Electron Way  
Chandlers Ford, Hampshire S053 4SE  
ENGLAND

Tel.: +44 2380 246810

Fax: +44 2380 246801

[europe.service@exfo.com](mailto:europe.service@exfo.com)

### **EXFO China Service Center/ Beijing OSIC**

Beijing New Century Hotel  
Office Tower, Room 1754-1755  
No. 6 Southern Capital Gym Road  
Beijing 100044  
P. R. CHINA

Tel.: +86 (10) 6849 2738

Fax: +86 (10) 6849 2662

[beijing.service@exfo.com](mailto:beijing.service@exfo.com)



# A *Technical Specifications*



## IMPORTANT

The following technical specifications can change without notice. The information presented in this section is provided as a reference only. To obtain this product's most recent technical specifications, visit the EXFO Web site at [www.exfo.com](http://www.exfo.com).

### SPECIFICATIONS

Wavelength range (nm)	1260 to 1675 (O to U band)
Measurement range (ps)	0 to 115
Sensitivity <sup>a</sup> (dBm)	-45
Measuring time (s)	4.5 (for any PMD value)
Absolute uncertainty (strong mode coupling) <sup>b</sup> (ps)	± (0.020 + 2 % of PMD)
Allows measurement through EDFA	Yes (above 120 EDFAs)

#### Notes

- a. Typical, for C band. May be increased with averaging. With the FLS-5800, the typical dynamic range is 47 dB.  
b. For C band, assuming averaging over all states of polarization.

### GENERAL SPECIFICATIONS

Temperature		
operating	0 °C to 40 °C	(32 °F to 104 °F)
storage	-40 °C to 70 °C	(-40 °F to 158 °F)
Relative humidity	0 % to 93 % non-condensing	
Size (H x W x D) (module only)	9.6 cm x 7.6 cm x 26.0 cm	(3 3/4 in x 3 in x 10 1/4 in)
Weight (module only)	1.5 kg (3.4 lb)	



# **B** *Using Third-Party Broadband Light Sources*

You can use broadband light sources from a third-party supplier in combination with the FTB-5500B Polarization Mode Dispersion Analyzer. However, the broadband source must respect a few simple, basic criteria in order not to impair the normal operation of the analyzer or degrade some of its specifications.

## **Compliance Criteria**

### ➤ Criterion 1: Source Modulation

Ideally, the light emitted from the broadband source and launched into the device under test must be free of any periodic power-modulation or phase-modulation. Nevertheless, a periodic modulation will not impair the normal operation of the analyzer whenever the following condition is respected:

$$f_m \geq 500 \text{ kHz} \quad \text{Equation 1}$$

where  $f_m$  is the fundamental frequency of the periodic modulation. In other words: the fundamental frequency of the periodic modulation must be *higher than* 500 kHz. Even more generally speaking, the smallest frequency in the spectrum of the modulation waveform must be higher than 500 kHz.

### ➤ Criterion 2: Source Spectrum

The adequacy of the broadband source spectrum can be judged easily through a precise quantitative criterion. The basic characteristic of the broadband source spectrum that is relevant is the rms width of its corresponding auto-correlation. The auto-correlation corresponds to the Fourier transform of the spectrum. It is a function of delay  $\tau$ . You can have a good estimate of the auto-correlation by saving the displayed interferogram when the broadband source is connected directly to the interferometer input with a patchcord.

## Using Third-Party Broadband Light Sources

### Compliance Criteria

---

The rms width of the auto-correlation determines the basic uncertainty of the interferometric method (Equation 4 on page 105). The smaller the rms width of the auto-correlation, the smaller the basic uncertainty. If the uncertainty is critically required to be equal to or smaller than the specified uncertainty using dedicated EXFO sources, the rms width of the auto-correlation,  $\sigma_0$ , must be smaller than  $\sim 0.1$  ps .

$$\sigma_0 \leq 0.1 \text{ ps} \qquad \text{Equation 2}$$

In the *particular case* of a Gaussian-shaped spectrum with no ripple, Equation 2 corresponds to

$$\text{FWHM} \geq 3.75 \text{ THz} \qquad \text{Equation 3}$$

(30.0 nm @ 1550 nm, 21.5 nm @ 1310 nm)

If criterion 2 is not met, the instrument will still operate normally, but the uncertainty specification will change according to the uncertainty formula given on the next page (Equation 4 on page 105).

It is useless to ask for a general specification regarding ripples or FWHM: it is impossible to precisely quantify the condition via these parameters. The auto-correlation interferogram is the relevant function to examine, through its rms width.



## Uncertainty Formula

The following formula can be used to determine the mean uncertainty as a function of the auto-correlation rms width,  $\sigma_0$ , the measured PMD value, and the number of measurements performed with distinct I/O-SOPs (using scramblers at the input *and* output of the DUT),

► all cases:

Equation 4

$$\frac{\sigma_{\text{PMD}}}{\text{PMD}} = \frac{1}{N} \cdot \frac{\left(1 - \frac{8}{3\pi}\right)}{\sqrt{1 + \frac{1}{4} \cdot \left(\frac{\text{PMD}}{\sigma_0}\right)^2}}$$

► large PMD:

$$\frac{\sigma_{\text{PMD}}}{\text{PMD}} \sim 0.55 \sqrt{\frac{1}{N} \cdot \frac{\sigma_0}{\text{PMD}}}$$

when  $\frac{\text{PMD}}{\sigma_0} \gg 1$

**Note:** *The uncertainty on the mean-PMD is decreased considerably when performing a sufficient number  $N$  of measurements with distinct I/O-SOPs. For randomly distributed I/O-SOPs, the uncertainty is decreased by a factor of  $1/\sqrt{N}$  according to Equation 3 on page 104. However, using an appropriate, deterministic set of I/O-SOPs covering the Poincaré sphere with a regularly spaced grid, the improvement factor tends toward  $1/N$  instead, which is much more efficient.*

## Using Third-Party Broadband Light Sources

### Uncertainty Formula

---

**Note:** *Continuous random I/O-SOP scrambling can also be performed without any synchronization with the instrument scans. Automatic, polarization scramblers/controllers running continuously with time are inserted at the input and output of the DUT (only one of these is not enough). The bandwidth of the SOP scramblers must be at least a few Hz to ensure very effective scrambling, and limited to a few kHz in order not to impair the normal operation of the analyzer.*

**Note:** *The rms width of the auto-correlation interferogram,  $E(\tau)$  is defined as follows:*

$$\sigma_0 \equiv \frac{\int \tau^2 \cdot E(\tau) \cdot d\tau}{\int E(\tau) \cdot d\tau}$$

**Equation 5**

# Index

<b>A</b>	
About button .....	93
accessing File Converter .....	74
acquiring	
multiple traces .....	28
parameter setup .....	24
traces .....	39
adding information .....	58
after-sales service .....	93
application	
exiting .....	17
exiting, File Converter .....	74
starting, File Converter .....	74
starting, single-module .....	13
ASCII files, generating .....	73
automatic names for fibers .....	19
available bands .....	24
averaging measurements .....	31
<b>B</b>	
bad results, removing .....	49
bands, available .....	24
basic PMD theory .....	3
Busy, module status .....	17
<b>C</b>	
calculating statistics .....	51
calibration	
certificate .....	86
interval .....	86
caution	
of personal hazard .....	6
of product hazard .....	6
certification information .....	vi
cleaning	
EUI connectors .....	84
fiber ends .....	33
fixed connectors .....	82
front panel .....	81
closing files .....	72
coefficient threshold .....	20
comments, adding .....	58
common problems, solving .....	89
connecting hardware .....	36
connectors, cleaning .....	82, 84
conventions, safety .....	6
converting files .....	73
coupling	
strong .....	24
weak .....	24
creating new files .....	56
criteria for source compliance .....	103
customer service .....	98
customizing	
graph .....	43
reports .....	67
<b>D</b>	
data	
consulting .....	44
display .....	16
keeping .....	63
saving .....	25
defining	
acquisition parameters .....	24
fiber name .....	19
template for comments .....	62
thresholds .....	20
description of PMD .....	1
detecting module .....	11
detector null measurement .....	41
display	
data .....	16
trace .....	16

# Index

---

- documenting
  - defining a template ..... 62
  - results ..... 58
- DUT, naming ..... 19

## E

- EDFAs, using ..... 2
- equipment returns ..... 98
- EUI
  - connector adapter ..... 34
  - dust cap ..... 34
- EUI connectors, cleaning ..... 84
- exiting application ..... 17, 74
- exporting
  - graph ..... 64
  - results ..... 64
- exporting PMD files ..... 73

## F

- fiber ends, cleaning ..... 33
- fiber name format, defining ..... 19
- fiber type ..... 24
- fibers
  - grouping ..... 54, 56
  - linking ..... 54
- File Converter, accessing/quitting ..... 74
- files
  - closing ..... 72
  - exporting ..... 73
  - format ..... 73
  - reloading ..... 44
  - saving ..... 25
- format of files ..... 73
- formula for uncertainty ..... 105
- front panel, cleaning ..... 81

## G

- general information ..... 44
- graph
  - copying ..... 64
  - customizing ..... 43
  - exporting ..... 64
- grouping fibers in a file ..... 56

## H

- hardware, connecting ..... 36
- help. see online user guide
- high-precision results ..... 31

## I

- identification label ..... 93
- identification, slot ..... 17
- inserting a module ..... 9
- Instrument function tab ..... 15, 16
- intensity of the signal ..... 42
- interferometric envelops, averaging ..... 31

## K

- keeping
  - data ..... 63
  - results ..... 25

## L

- label, identification ..... 93
- linking fibers ..... 54

## M

- maintenance
  - EUI connectors ..... 84
  - fixed connectors ..... 82
  - front panel ..... 81
  - general information ..... 81
- measurement
  - preparation ..... 36
  - with multiple SOP ..... 31

merging many fibers to one .....	54	product	
module		identification label .....	93
detection .....	11	specifications .....	101
insertion .....	9		
removal .....	9	<b>R</b>	
status .....	17	random coupling fiber .....	24
module position .....	17	Ready, module status .....	17
mounting EUI connector adapter .....	34	recalibration .....	86
multiple measurements .....	28	reloading files .....	44
		removing a module .....	9
		removing bad results .....	49
		report	
<b>N</b>		printing .....	69
naming fibers .....	19	selecting content .....	67
negligible coupling fiber .....	24	results	
nulling .....	41	commenting .....	58
		consulting .....	44
		copying .....	64
		high-precision .....	31
		saving .....	63
		storage .....	25
		return merchandise authorization (RMA) ....	98
		<b>S</b>	
		safety	
<b>O</b>		caution .....	6
online user guide .....	92	conventions .....	6
		warning .....	6
		saving	
		files .....	25
		results .....	63
		selecting	
		band .....	24
		graph areas .....	43
		service and repairs .....	98
		service centers .....	99
		shipping to EXFO .....	98
		signal intensity .....	42
		slot number .....	17
		software. see application	
		solving problems .....	89
<b>P</b>			
parameters, defining .....	24		
PDF. see online user guide			
performing a test .....	39		
PMD			
data display .....	16		
description .....	1		
result graph .....	39		
results .....	39		
theory .....	3		
threshold .....	20		
trace display .....	16		
polarization maintaining fiber .....	24		
polarization mode dispersion. see PMD			
position, module .....	17		
power level indicator, description .....	42		
preparing for measurement .....	36		
previously acquired results .....	44		
printing			
customization .....	67		
report .....	69		
problems solving .....	89		

# Index

---

SOP, measuring multiple ..... 31  
source  
    criteria for compliance ..... 103  
    setting up ..... 36  
specific information ..... 44  
specifications, product ..... 101  
starting  
    acquisition ..... 39  
    software ..... 74  
starting application ..... 74  
statistics, viewing ..... 51  
status bar ..... 17  
storage requirements ..... 81  
storing results ..... 25, 63  
strong coupling fiber ..... 24  
symbols, safety ..... 6

## T

technical specifications ..... 101  
technical support ..... 93  
telecom fiber ..... 24  
temperature for storage ..... 81  
template, defining for comments ..... 62  
test, performing ..... 39  
testing with EDFAs ..... 2  
theory, polarization mode dispersion ..... 3  
third-party sources, using ..... 103  
title bar ..... 17  
traces  
    acquiring many ..... 28  
    acquisition ..... 39  
    display ..... 16  
transferring results to external application .. 64  
transportation requirements ..... 81, 94  
type of fiber ..... 24

## U

uncertainty formula ..... 105  
unit recalibration ..... 86  
user guide. see online user guide  
using results in word processor ..... 64

## V

viewing  
    results ..... 44  
    statistics ..... 51

## W

warranty  
    certification ..... 97  
    exclusions ..... 97  
    general ..... 95  
    liability ..... 96  
    null and void ..... 95  
wavelength, selecting ..... 24  
weak coupling fiber ..... 24

## Z

zooming in/out ..... 43

## NOTICE

### 通告

#### CHINESE REGULATION ON RESTRICTION OF HAZARDOUS SUBSTANCES

#### 中国关于有害物质限制的规定

#### NAMES AND CONTENTS OF THE TOXIC OR HAZARDOUS SUBSTANCES OR ELEMENTS CONTAINED IN THIS EXFO PRODUCT



#### 包含在本 EXFO 产品中的有毒有害物质或元素的名称和含量

O	Indicates that this toxic or hazardous substance contained in all of the homogeneous materials for this part is below the limit requirement in SJ/T11363-2006 表示该有毒有害物质在该部件所有均质材料中的含量均在 SJ/T11363-2006 标准规定的限量要求以下。
X	Indicates that this toxic or hazardous substance contained in at least one of the homogeneous materials used for this part is above the limit requirement in SJ/T11363-2006 表示该有毒有害物质至少在该部件的某一均质材料中的含量超出 SJ/T11363-2006 标准规定的限量要求。

Part Name 部件名称	Toxic or hazardous Substances and Elements 有毒有害物质和元素					
	Lead 铅 (Pb)	Mercury 汞 (Hg)	Cadmium 镉 (Cd)	Hexavalent Chromium 六价铬 (Cr VI)	Polybrominated biphenyls 多溴联苯 (PBB)	Polybrominated diphenyl ethers 多溴二苯醚 (PBDE)
Enclosure 外壳	O	O	O	O	O	O
Electronic and electrical sub-assembly 电子和电子组件	X	O	X	O	X	X
Optical sub-assembly <sup>a</sup> 光学组件 <sup>a</sup>	X	O	O	O	O	O
Mechanical sub-assembly <sup>a</sup> 机械组件 <sup>a</sup>	O	O	O	O	O	O

- a. If applicable.  
聞種矽杉羽塞粒粒。

MARKING REQUIREMENTS  
标注要求

Product 产品	Environmental protection use period (years) 环境保护使用期限 ( 年 )	Logo 标志
This Exfo product 本 EXFO 产品	10	
Battery <sup>a</sup> 电池 <sup>a</sup>	5	

- a. If applicable.  
閩種殆衫翎塞粒。



P/N: 1055209

[www.EXFO.com](http://www.EXFO.com) · [info@exfo.com](mailto:info@exfo.com)

<b>CORPORATE HEADQUARTERS</b>	400 Godin Avenue	Quebec (Quebec) G1M 2K2 CANADA Tel.: 1 418 683-0211 · Fax: 1 418 683-2170
<b>EXFO AMERICA</b>	3701 Plano Parkway, Suite 160	Plano TX, 75075 USA Tel.: 1 972 907-1505 · Fax: 1 972 836-0164
<b>EXFO EUROPE</b>	Omega Enterprise Park, Electron Way	Chandlers Ford, Hampshire S053 4SE ENGLAND Tel.: +44 2380 246810 · Fax: +44 2380 246801
<b>EXFO ASIA-PACIFIC</b>	151 Chin Swee Road #03-29, Manhattan House	SINGAPORE 169876 Tel.: +65 6333 8241 · Fax: +65 6333 8242
<b>EXFO CHINA</b>	No. 88 Fuhua First Road, Central Tower, Room 801, Futian District	Shenzhen 518048 P. R. CHINA Tel.: +86 (755) 8203 2300 · Fax: +86 (755) 8203 2306
	Beijing New Century Hotel Office Tower, Room 1754-1755, No. 6 Southern Capital Gym Road	Beijing 100044 P. R. CHINA Tel.: +86 (10) 6849 2738 · Fax: +86 (10) 6849 2662
<b>EXFO SERVICE ASSURANCE</b>	285 Mill Road	Chelmsford MA, 01824 USA Tel.: 1 978 367-5600 · Fax: 1 978 367-5700
<b>TOLL-FREE</b>	(USA and Canada)	1 800 663-3936

© 2009 EXFO Electro-Optical Engineering Inc. All rights reserved.  
Printed in Canada (2009-04)

