

# MAX-700



---

Copyright © 2012 EXFO Inc. All rights reserved. No part of this publication may be reproduced, stored in a retrieval system or transmitted in any form, be it electronically, mechanically, or by any other means such as photocopying, recording or otherwise, without the prior written permission of EXFO Inc. (EXFO).

Information provided by EXFO is believed to be accurate and reliable. However, no responsibility is assumed by EXFO for its use nor for any infringements of patents or other rights of third parties that may result from its use. No license is granted by implication or otherwise under any patent rights of EXFO.

EXFO's Commerce And Government Entities (CAGE) code under the North Atlantic Treaty Organization (NATO) is 0L8C3.

The information contained in this publication is subject to change without notice.

### ***Trademarks***

EXFO's trademarks have been identified as such. However, the presence or absence of such identification does not affect the legal status of any trademark.

### ***Units of Measurement***

Units of measurement in this publication conform to SI standards and practices.

### ***Patents***

EXFO's Universal Interface is protected by US patent 6,612,750.

Version number: 19.0.3

---

## End-User License Agreement

You have acquired a device ("DEVICE") that includes software licensed by EXFO Inc. (EXFO) from an affiliate of Microsoft Corporation ("MS"). Those installed software products of MS origin, as well as associated media, printed materials, and "online" or electronic documentation ("SOFTWARE") are protected by international intellectual property laws and treaties. Manufacturer, MS and its suppliers (including Microsoft Corporation) own the title, copyright, and other intellectual property rights in the SOFTWARE. The SOFTWARE is licensed, not sold. All rights reserved.

This EULA is valid and grants the end-user rights ONLY if the SOFTWARE is genuine and a genuine Certificate of Authenticity for the SOFTWARE is included. For more information on identifying whether your software is genuine, please see <http://www.microsoft.com/piracy/howtotell>.

IF YOU DO NOT AGREE TO THIS END USER LICENSE AGREEMENT ("EULA"), DO NOT USE THE DEVICE OR COPY THE SOFTWARE. INSTEAD, PROMPTLY CONTACT EXFO FOR INSTRUCTIONS ON RETURN OF THE UNUSED DEVICE(S) FOR A REFUND. **ANY USE OF THE SOFTWARE, INCLUDING BUT NOT LIMITED TO USE ON THE DEVICE, WILL CONSTITUTE YOUR AGREEMENT TO THIS EULA (OR RATIFICATION OF ANY PREVIOUS CONSENT).**

**GRANT OF SOFTWARE LICENSE.** This EULA grants you the following license:

- You may use the SOFTWARE only on the DEVICE.
- **Restricted Functionality.** You are licensed to use the SOFTWARE to provide only the limited functionality (specific tasks or processes) for which the DEVICE has been designed and marketed by EXFO. This license specifically prohibits any other use of the software programs or functions, or inclusion of additional software programs or functions that do not directly support the limited functionality on the DEVICE. Notwithstanding the foregoing, you may install or enable on a DEVICE, systems utilities, resource management or similar software solely for the purpose of administration, performance enhancement and/or preventive maintenance of the DEVICE.
- If you use the DEVICE to access or utilize the services or functionality of Microsoft Windows Server products (such as Microsoft Windows Server 2003), or use the DEVICE to permit workstation or computing devices to access or utilize the services or functionality of Microsoft Windows Server products, you may be required to obtain a Client Access License for the DEVICE and/or each such workstation or computing device. Please refer to the end user license agreement for your Microsoft Windows Server product for additional information.
- **NOT FAULT TOLERANT.** THE SOFTWARE IS NOT FAULT TOLERANT. EXFO HAS INDEPENDENTLY DETERMINED HOW TO USE THE SOFTWARE IN THE DEVICE, AND MS HAS RELIED UPON EXFO TO CONDUCT SUFFICIENT TESTING TO DETERMINE THAT THE SOFTWARE IS SUITABLE FOR SUCH USE.
- **NO WARRANTIES FOR THE SOFTWARE.** THE SOFTWARE is provided "AS IS" and with all faults. THE ENTIRE RISK AS TO SATISFACTORY QUALITY, PERFORMANCE, ACCURACY, AND EFFORT (INCLUDING LACK OF NEGLIGENCE) IS WITH YOU. ALSO, THERE IS NO WARRANTY AGAINST INTERFERENCE WITH YOUR ENJOYMENT OF THE SOFTWARE OR AGAINST INFRINGEMENT. **IF YOU HAVE RECEIVED ANY WARRANTIES REGARDING THE DEVICE OR THE SOFTWARE, THOSE WARRANTIES DO NOT ORIGINATE FROM, AND ARE NOT BINDING ON, MS.**
- **No Liability for Certain Damages.** EXCEPT AS PROHIBITED BY LAW, MS SHALL HAVE NO LIABILITY FOR ANY INDIRECT, SPECIAL, CONSEQUENTIAL OR INCIDENTAL DAMAGES ARISING FROM OR IN CONNECTION WITH THE USE OR PERFORMANCE OF THE SOFTWARE. THIS LIMITATION SHALL APPLY EVEN IF ANY REMEDY FAILS OF ITS ESSENTIAL PURPOSE. IN NO EVENT SHALL MS BE LIABLE FOR ANY AMOUNT IN EXCESS OF U.S. TWO HUNDRED FIFTY DOLLARS (U.S.\$250.00).
- **Restricted Uses.** The SOFTWARE is not designed or intended for use or resale in hazardous environments requiring fail-safe performance, such as in the operation of nuclear facilities, aircraft navigation or communication systems, air traffic control, or other devices or systems in which a malfunction of the SOFTWARE would result in foreseeable risk of injury or death to the operator of the device or system, or to others.
- **Limitations on Reverse Engineering, Decompilation, and Disassembly.** You may not reverse engineer, decompile, or disassemble the SOFTWARE, except and only to the extent that such activity is expressly permitted by applicable law notwithstanding this limitation.
- **SOFTWARE as a Component of the DEVICE - Transfer.** This license may not be shared, transferred to or used concurrently on different computers. The SOFTWARE is licensed with the DEVICE as a single integrated product and may only be used with the DEVICE. If the SOFTWARE is not accompanied by a DEVICE, you may not use the SOFTWARE. You may permanently transfer all of your rights under this EULA only as part of a permanent sale or transfer of the DEVICE, provided you retain no copies of the SOFTWARE. If the SOFTWARE is an upgrade, any transfer must also include all prior versions of the SOFTWARE. This transfer must also include the Certificate of Authenticity label. The transfer may not be an indirect transfer, such as a consignment. Prior to the transfer, the end user receiving the SOFTWARE must agree to all the EULA terms.
- **Consent to Use of Data.** You agree that MS, Microsoft Corporation and their affiliates may collect and use technical information gathered in any manner as part of product support services related to the SOFTWARE. MS, Microsoft Corporation and their affiliates may use this information solely to improve their products or to provide customized services or technologies to you. MS, Microsoft Corporation and their affiliates may disclose this information to others, but not in a form that personally identifies you.

- 
- **Internet Gaming/Update Features.** If the SOFTWARE provides, and you choose to utilize, the Internet gaming or update features within the SOFTWARE, it is necessary to use certain computer system, hardware, and software information to implement the features. By using these features, you explicitly authorize MS, Microsoft Corporation and/or their designated agent to use this information solely to improve their products or to provide customized services or technologies to you. MS or Microsoft Corporation may disclose this information to others, but not in a form that personally identifies you.
  - **Internet-Based Services Components.** The SOFTWARE may contain components that enable and facilitate the use of certain Internet-based services. You acknowledge and agree that MS, Microsoft Corporation or their affiliates may automatically check the version of the SOFTWARE and/or its components that you are utilizing and may provide upgrades or supplements to the SOFTWARE that may be automatically downloaded to your DEVICE. Microsoft Corporation or their affiliates do not use these features to collect any information that will be used to identify you or contact you. For more information about these features, please see the privacy statement at <http://go.microsoft.com/fwlink/?LinkId=25243>.
  - **Links to Third Party Sites.** You may link to third party sites through the use of the SOFTWARE. The third party sites are not under the control of MS or Microsoft Corporation, and MS or Microsoft are not responsible for the contents of any third party sites, any links contained in third party sites, or any changes or updates to third party sites. MS or Microsoft Corporation is not responsible for webcasting or any other form of transmission received from any third party sites. MS or Microsoft Corporation are providing these links to third party sites to you only as a convenience, and the inclusion of any link does not imply an endorsement by MS or Microsoft Corporation of the third party site.
  - **Notice Regarding Security.** To help protect against breaches of security and malicious software, periodically back up your data and system information, use security features such as firewalls, and install and use security updates.
  - **No Rental/Commercial Hosting.** You may not rent, lease, lend or provide commercial hosting services with the SOFTWARE to others.
  - **Separation of Components.** The SOFTWARE is licensed as a single product. Its component parts may not be separated for use on more than one computer.
  - **Additional Software/Services.** This EULA applies to updates, supplements, add-on components, product support services, or Internet-based services components ("Supplemental Components"), of the SOFTWARE that you may obtain from EXFO, MS, Microsoft Corporation or their subsidiaries after the date you obtain your initial copy of the SOFTWARE, unless you accept updated terms or another agreement governs. If other terms are not provided along with such Supplemental Components and the Supplemental Components are provided to you by MS, Microsoft Corporation or their subsidiaries then you will be licensed by such entity under the same terms and conditions of this EULA, except that (i) MS, Microsoft Corporation or their subsidiaries providing the Supplemental Components will be the licensor with respect to such Supplemental Components in lieu of the "COMPANY" for the purposes of the EULA, and (ii) TO THE MAXIMUM EXTENT PERMITTED BY APPLICABLE LAW, THE SUPPLEMENTAL COMPONENTS AND ANY (IF ANY) SUPPORT SERVICES RELATED TO THE SUPPLEMENTAL COMPONENTS ARE PROVIDED AS IS AND WITH ALL FAULTS. ALL OTHER DISCLAIMERS, LIMITATION OF DAMAGES, AND SPECIAL PROVISIONS PROVIDED BELOW AND/OR OTHERWISE WITH THE SOFTWARE SHALL APPLY TO SUCH SUPPLEMENTAL COMPONENTS. MS, Microsoft Corporation or their subsidiaries reserve the right to discontinue any Internet-based services provided to you or made available to you through the use of the SOFTWARE.
  - **Recovery Media.** If SOFTWARE is provided by EXFO on separate media and labeled "Recovery Media" you may use the Recovery Media solely to restore or reinstall the SOFTWARE originally installed on the DEVICE.
  - **Backup Copy.** You may make one (1) backup copy of the SOFTWARE. You may use this backup copy solely for your archival purposes and to reinstall the SOFTWARE on the DEVICE. Except as expressly provided in this EULA or by local law, you may not otherwise make copies of the SOFTWARE, including the printed materials accompanying the SOFTWARE. You may not loan, rent, lend or otherwise transfer the backup copy to another user.
  - **End User Proof of License.** If you acquired the SOFTWARE on a DEVICE, or on a compact disc or other media, a genuine Microsoft "Proof of License"/Certificate of Authenticity label with a genuine copy of the SOFTWARE identifies a licensed copy of the SOFTWARE. To be valid, the label must be affixed to the DEVICE, or appear on [COMPANY'S] software packaging. If you receive the label separately other than from EXFO, it is invalid. You should keep the label on the DEVICE or packaging to prove that you are licensed to use the SOFTWARE.
  - **Product Support.** Product support for the SOFTWARE is not provided by MS, Microsoft Corporation, or their affiliates or subsidiaries. For product support, please refer to EXFO support number provided in the documentation for the DEVICE. Should you have any questions concerning this EULA, or if you desire to contact EXFO for any other reason, please refer to the address provided in the documentation for the DEVICE.
  - **Termination.** Without prejudice to any other rights, EXFO may terminate this EULA if you fail to comply with the terms and conditions of this EULA. In such event, you must destroy all copies of the SOFTWARE and all of its component parts.
  - **EXPORT RESTRICTIONS.** You acknowledge that SOFTWARE is subject to U.S. and European Union export jurisdiction. You agree to comply with all applicable international and national laws that apply to the SOFTWARE, including the U.S. Export Administration Regulations, as well as end-user, end-use and destination restrictions issued by U.S. and other governments. For additional information see <http://www.microsoft.com/exporting/>.

# Contents

Certification Information .....	xi
<b>1 Introducing the MAX-700 .....</b>	<b>1</b>
Main Features .....	1
LED Indicators Description .....	6
Function Buttons Description .....	7
Trace Acquisition Modes .....	7
Optional Software Package .....	8
Data Post-Processing .....	8
OTDR Basic Principles .....	9
Power Sources .....	11
Conventions .....	12
<b>2 Safety Information .....</b>	<b>13</b>
Laser Safety Information .....	14
Electrical Safety Information .....	15
<b>3 Getting Started with Your MAX-700 .....</b>	<b>17</b>
Using the Supports .....	17
Securing Your Unit Using a Kensington Lock .....	18
Installing a Keyboard, Mouse or Other USB Devices .....	19
Using the On-Screen (Virtual) Keyboard .....	22
Right-Clicking with the Touchscreen .....	23
Turning On or Off the Unit .....	24
Installing or Upgrading the Applications .....	28
Activating Software Options .....	33
Starting Instrument Applications .....	38
Timer .....	39
<b>4 Preparing Your MAX-700 for a Test .....</b>	<b>41</b>
Installing the EXFO Universal Interface (EUI) .....	41
Cleaning and Connecting Optical Fibers .....	42
Naming Trace Files Automatically .....	44
Enabling or Disabling the First Connector Check .....	48
Setting Macrobend Parameters .....	49
<b>5 Testing Fibers in Auto Mode .....</b>	<b>51</b>

# Contents

---

- 6 Testing Fibers in Advanced Mode ..... 55**
  - Setting the Autorange Acquisition Time ..... 60
  - Setting the IOR, RBS Coefficient, and Helix Factor ..... 61
  - Setting Distance Range, Pulse Width, and Acquisition Time ..... 63
  - Enabling the High-Resolution Feature ..... 66
  - Enabling or Disabling Analysis After Acquisition ..... 68
  - Setting Pass/Fail Thresholds ..... 70
  - Setting a Default Span Start and Span End ..... 75
  
- 7 Testing Fibers in Fault Finder Mode ..... 77**
  - Acquiring Traces in Fault Finder Mode ..... 77
  - Naming Fault Finder Files Automatically ..... 80
  - Selecting the Default File Format for the Fault Finder Traces ..... 82
  - Enabling or Disabling the Confirmation of Fault Finder File Name ..... 84
  - Enabling or Disabling the Storage Feature ..... 86
  - Enabling or Disabling the First Connector Check for Fault Finder ..... 87
  - Enabling or Disabling the Touchscreen Keyboard ..... 89
  - Setting Trace Display Parameters ..... 90
  - Selecting the Distance Units ..... 92
  
- 8 Customizing the OTDR Application ..... 95**
  - Selecting the Default File Format ..... 95
  - Enabling or Disabling File Name Confirmation ..... 97
  - Selecting the Distance Units ..... 99
  - Customizing the Acquisition Distance Range Values ..... 101
  - Customizing the Acquisition Time Values ..... 103
  - Enabling or Disabling the Touchscreen Keyboard ..... 105
  - Displaying or Hiding the Optional Features ..... 106

---

<b>9 Analyzing Traces and Events .....</b>	<b>107</b>
Graph View .....	108
Linear View .....	110
Summary Table .....	112
Events Tab .....	114
Measure Tab .....	118
Trace Info. Tab .....	118
Displaying the Graph in Full Screen .....	119
Selecting the Default View .....	121
Automatically Displaying the Event Table after Acquisitions .....	123
Automatically Zooming in on the Fiber Span .....	124
Using Zoom Controls .....	125
Setting Trace Display Parameters .....	128
Customizing the Event Table .....	130
Displaying or Hiding a Trace .....	132
Clearing Traces from the Display .....	134
Viewing and Modifying Current Trace Settings .....	135
Modifying Events .....	140
Inserting Events .....	144
Deleting Events .....	146
Managing Comments .....	148
Changing the Attenuation of Fiber Sections .....	150
Setting the Analysis Detection Thresholds .....	152
Analyzing or Reanalyzing a Trace .....	155
Analyzing the Fiber on a Specific Fiber Span .....	157
Enabling or Disabling the Detection of Reflective Ends of Fiber .....	158
Swapping Traces .....	161
Opening Trace Files .....	162
<b>10 Analyzing the Results Manually .....</b>	<b>167</b>
Selecting the Attenuation and Loss Values that Will Be Displayed .....	167
Using Markers .....	169
Getting Event Distances and Relative Powers .....	170
Getting Event Loss (Four-Point and Least-Square Approximation) .....	171
Getting Attenuation (Two-Point and Least-Square Approximation) .....	176
Getting Reflectance .....	178
Getting Optical Return Loss (ORL) .....	179
<b>11 Managing Trace Files from the OTDR Test Application .....</b>	<b>181</b>
Saving a Trace in a Different Format .....	181
OTDR Trace File Compatibility .....	182
Copying, Moving, Renaming, or Deleting Trace Files .....	184

# Contents

---

<b>12 Creating and Generating Reports</b>	<b>185</b>
Adding Information to the Test Results	185
Generating a Report	187
<b>13 Using the OTDR as a Light Source</b>	<b>193</b>
<b>14 Setting Up Your Unit</b>	<b>197</b>
Adjusting Brightness	197
Adjusting Microphone and Headphones Volume	198
Recalibrating the Touchscreen	202
Enabling or Disabling the Touchscreen Right-Click Feature	205
Customizing the On-Screen Keyboard	208
Selecting the Startup Application	210
Configuring Network Printers	212
Selecting the Language of Operation	215
Setting Date and Time Formats	221
Adjusting the Date, Time and Time Zone	224
Configuring the Power Management Options	227
Configuring the Internet Options	231
Setting Other Parameters	231
<b>15 Working with Your Unit</b>	<b>233</b>
Printing Documents	233
Viewing PDF Files	236
Taking Screen Captures	237
Setting Storage Parameters for Screen Captures	240
Reading Audio and Video Files	244
Installing Adobe Flash Player on Your Unit	246
Browsing the Web	248
Accessing Other Tools	249
<b>16 Using the Optional Built-In Power Meter and VFL</b>	<b>251</b>
<b>17 Inspecting Fibers with a Probe</b>	<b>253</b>
<b>18 Managing Data</b>	<b>255</b>
Transferring Data via Bluetooth	258
Connecting to a Wireless Network	266
Using the USB to RS-232 Adapter	271
Enabling or Disabling the Bluetooth and Wi-Fi Devices	276
Transferring Files with the USB Data Mover Application	278
Using Your Unit as an FTP Server	284



<b>19 Accessing Your Unit Remotely .....</b>	<b>287</b>
Working With TightVNC .....	288
Configuring TightVNC Server to Start Automatically .....	294
Adding Exceptions to the Firewall .....	296
<b>20 Maintenance .....</b>	<b>299</b>
Cleaning EUI Connectors .....	300
Cleaning Detector Ports .....	302
Cleaning the Touchscreen of Your MAX-700 Unit .....	303
Recharging the Main Battery .....	303
Replacing Batteries .....	305
Verifying Your MAX-700 .....	309
Recalibrating the Unit .....	317
Recycling and Disposal (Applies to European Union Only) .....	317
<b>21 Troubleshooting .....</b>	<b>319</b>
Solving Common Problems .....	319
Restoring Your Unit to Normal Operation .....	324
Contacting the Technical Support Group .....	333
Transportation .....	334
<b>22 Warranty .....</b>	<b>335</b>
General Information .....	335
Liability .....	336
Exclusions .....	336
Certification .....	336
Service and Repairs .....	337
EXFO Service Centers Worldwide .....	338
<b>A Technical Specifications .....</b>	<b>339</b>

## Contents

---

<b>B Description of Event Types .....</b>	<b>341</b>
Span Start .....	342
Span End .....	342
Short Fibers .....	342
Continuous Fiber .....	343
End of Analysis .....	344
Non-Reflective Event .....	345
Reflective Event .....	346
Positive Event .....	347
Launch Level .....	348
Fiber Section .....	349
Merged Event .....	350
Echo .....	356
Reflective Event (Possible Echo) .....	357
<b>Index .....</b>	<b>359</b>

## Certification Information

### **North America Regulatory Statement on Product Safety**

This unit was certified by an agency approved in both Canada and the United States of America. It has been evaluated according to applicable North American approved standards for product safety for use in Canada and the United States.

Electronic test and measurement equipment is exempt from FCC part 15, subpart B compliance in the United States of America and from ICES-003 compliance in Canada. However, EXFO Inc. makes reasonable efforts to ensure compliance to the applicable standards.

The limits set by these standards are designed to provide reasonable protection against harmful interference when the equipment is operated in a commercial environment. This equipment generates, uses, and can radiate radio frequency energy and, if not installed and used in accordance with the user guide, may cause harmful interference to radio communications. Operation of this equipment in a residential area is likely to cause harmful interference in which case the user will be required to correct the interference at his own expense.

Modifications not expressly approved by the manufacturer could void the user's authority to operate the equipment.

# European Community Declaration of Conformity



## DECLARATION OF CONFORMITY

Application of Council Directive(s): 2006/95/EC – The Low Voltage Directive  
2004/108/EC – The EMC Directive  
93/68/EEC – CE Marking  
And their amendments

Manufacturer's Name and Address: **EXFO Inc.**  
400 Godin Avenue  
Quebec City, Quebec  
G1M 2K2 CANADA  
Tel.: +1 418 683-0211

**EXFO Europe**  
Omega Enterprise Park, Electron Way  
Chandlers Ford, Hampshire  
SO53 4SE ENGLAND  
Tel.: +44 2380 246810

Equipment Type/Environment: Test & Measurement / Industrial  
Trade Name/Model No.: (Dedicated LAN/WAN/ACCESS/PON OTDRs) / MAX-700 SERIES

Standard(s) to which Conformity is declared:

- |                                    |   |
|------------------------------------|---|
| <b>EN 61010-1:2001 Edition 2.0</b> | <b>Safety requirements for electrical equipment for measurement, control, and laboratory use – Part 1: General requirements</b> |
| <b>EN 61326-1:2006</b>             | <b>Electrical equipment for measurement, control and laboratory use – EMC requirements – Part 1: General requirements</b>       |
| <b>EN 60825-1:2007 Edition 2.0</b> | <b>Safety of laser products – Part 1: Equipment classification and requirements</b>   |

I, the undersigned, hereby declare that the equipment specified above conforms to the above Directive and Standards.

Manufacturer:

*Stephen Bull, E. Eng*  
Vice-President Research and Development

400 Godin Avenue,  
Quebec City, Quebec  
G1M 2K2 CANADA  
April 03, 2012



# 1 Introducing the MAX-700

The MAX-700 allows you to characterize a fiber-optic span, usually optical fiber sections joined by splices and connectors. The optical time domain reflectometer (OTDR) provides an inside view of the fiber, and can calculate fiber length, attenuation, breaks, total return loss, and splice, connector and total losses.

**Note:** *In this documentation, the words “tap” and “double-tap” (related to the use of a touchscreen) replace the words “click” and “double-click”.*

## Main Features

Your MAX-700 includes the following:

- Multitasking possibilities
- Seven-inch color touchscreen (LCD and touchscreen optimized for outdoor use available as an option)
- Two USB 2.0 ports (host)
- Ethernet port (10/100/1000 Base-T)
- Optional internal Wi-Fi and Bluetooth devices
- Windows Embedded Standard operating system
- Fiber inspection probe port
- Optional built-in power meter and VFL
- Remote access to your unit (via TightVNC)
- Direct Web access from your unit
- Possibility to take screen captures
- PDF file generator and viewer available from your unit
- Easy transfer of files and folders to a USB storage device
- Easy updates for applications via Update Manager
- Impressive dynamic range with short dead zones

# Introducing the MAX-700

## Main Features

---

- Possible to perform quick acquisitions with low noise levels to enable accurate low-loss splice location.
- Possible to acquire OTDR traces made of up to 256 000 points that provide a sampling resolution as fine as 4 cm.
- Possible to use the OTDR port as a light source.

### Front

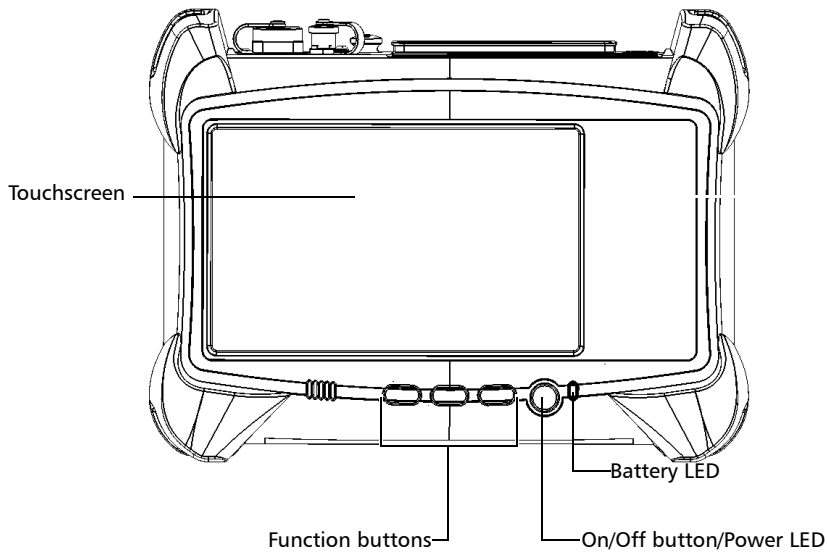

**Back**

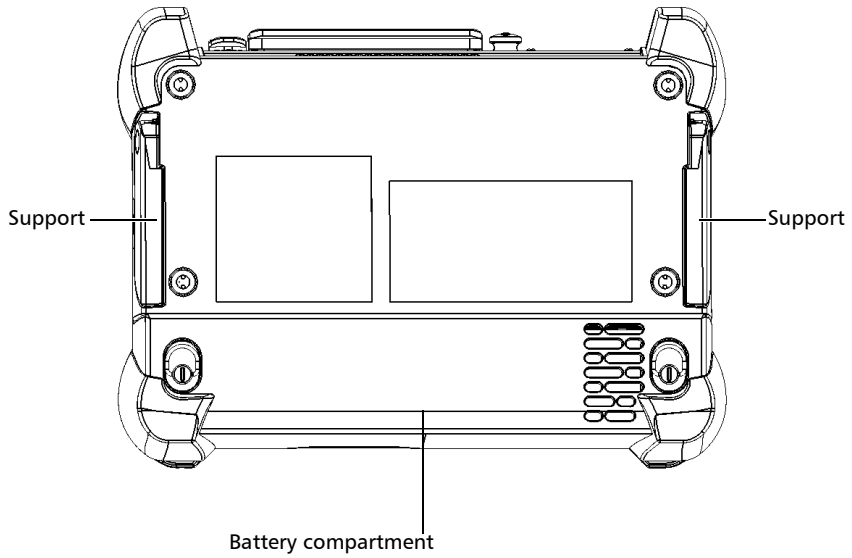

# Introducing the MAX-700

## Main Features

---

### Top

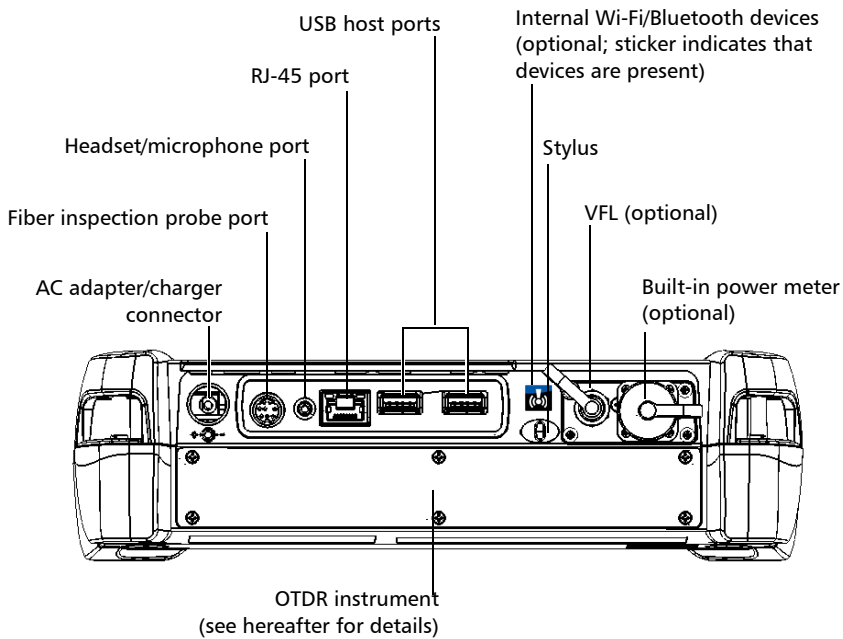



**OTDR Instrument**

**MAX-710**

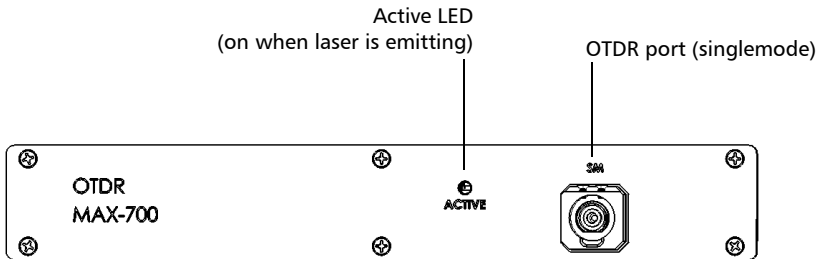

**MAX-730**

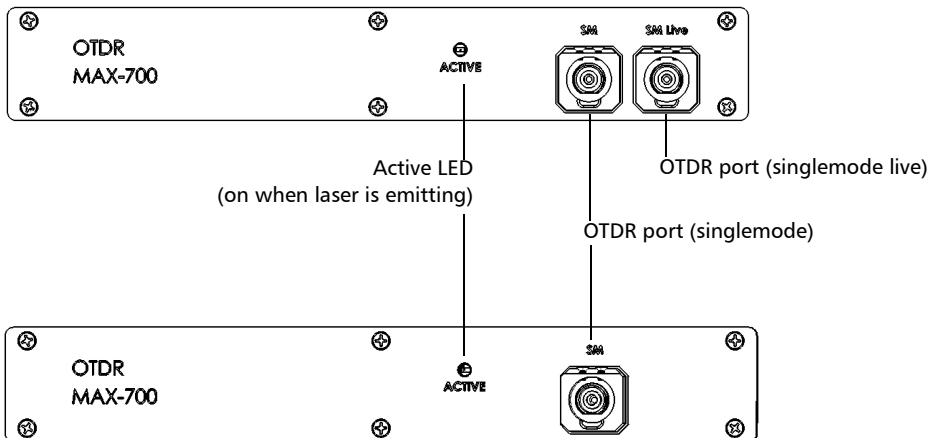



## Introducing the MAX-700

### LED Indicators Description

---

## LED Indicators Description





There are two LED indicators located on the front panel of your unit, providing you with information about the power and battery statuses.

LED	Status	Meaning
	Green	Unit is on.
	Green, blinking	Unit is in Standby mode.
	Off	Unit is off or in Hibernation mode.
	Green	Battery is fully charged.
	Green, blinking	Battery is charging.
	Yellow, blinking	Unit is not powered by AC and battery is low.
	Red	No battery in the unit or battery error.
	Off	Unit is off or unit is not powered by AC and battery level is above the “low-battery threshold”.

## Function Buttons Description

Your unit is equipped with function buttons which give you access to various tools at all times.

The table below shows an overview of their purpose.

Button	Meaning
	Adjusts screen brightness (5 levels).
	<ul style="list-style-type: none"> <li>➤ Displays the on-screen keyboard</li> <li>➤ Takes a screen capture (button held down for a few seconds)</li> </ul>
	Enables you to switch from one task to another.
	<p>Turns your unit on and off.</p> <p>For more information on the various ways to turn off your unit, see <i>Turning On or Off the Unit</i> on page 24.</p>

## Trace Acquisition Modes

The OTDR application provides the following trace acquisition modes:

- *Auto*: Automatically calculates fiber length, sets acquisition parameters, acquires traces, and displays event tables and acquired traces.
- *Advanced*: Offers all the tools needed to perform integral OTDR tests and measurements and gives you control over all test parameters.
- *Fault Finder*: Rapidly locates fiber ends and displays the length of the fiber under test. This allows you to perform quick tests without having to set all the acquisition parameters.

### **Optional Software Package**

An optional software package is offered with the application.

With the optional Auto Diagnostic (AD) software package you can:

- Have access to the “linear view”, which displays the events sequentially, from left to right.
- Find macrobends and view the related information.
- View the summary table, which gives, for each wavelength, the global status of the results, the span loss and span ORL values.
- Test in Fault Finder mode, to rapidly locate fiber ends.

### **Data Post-Processing**

To view and analyze traces without the MAX-700 use a computer onto which FastReporter is already installed.

## **OTDR Basic Principles**

An OTDR sends short pulses of light into a fiber. Light scattering occurs in the fiber due to discontinuities such as connectors, splices, bends, and faults. An OTDR then detects and analyzes the backscattered signals. The signal strength is measured for specific intervals of time and is used to characterize events.

The OTDR calculates distances as follows:

$$\text{Distance} = \frac{c}{n} \times \frac{t}{2}$$

where

- c = speed of light in a vacuum ( $2.998 \times 10^8$  m/s)
- t = time delay from the launch of the pulse to the reception of the pulse
- n = index of refraction of the fiber under test (as specified by the manufacturer)

# Introducing the MAX-700

## OTDR Basic Principles

An OTDR uses the effects of Rayleigh scattering and Fresnel reflection to measure the fiber's condition, but the Fresnel reflection is tens of thousands of times greater in power level than the backscatter.

- Rayleigh scattering occurs when a pulse travels down the fiber and small variations in the material, such as variations and discontinuities in the index of refraction, cause light to be scattered in all directions. However, the phenomenon of small amounts of light being reflected directly back toward the transmitter is called backscattering.
- Fresnel reflections occur when the light traveling down the fiber encounters abrupt changes in material density that may occur at connections or breaks where an air gap exists. A very large quantity of light is reflected, as compared with the Rayleigh scattering. The strength of the reflection depends on the degree of change in the index of refraction.

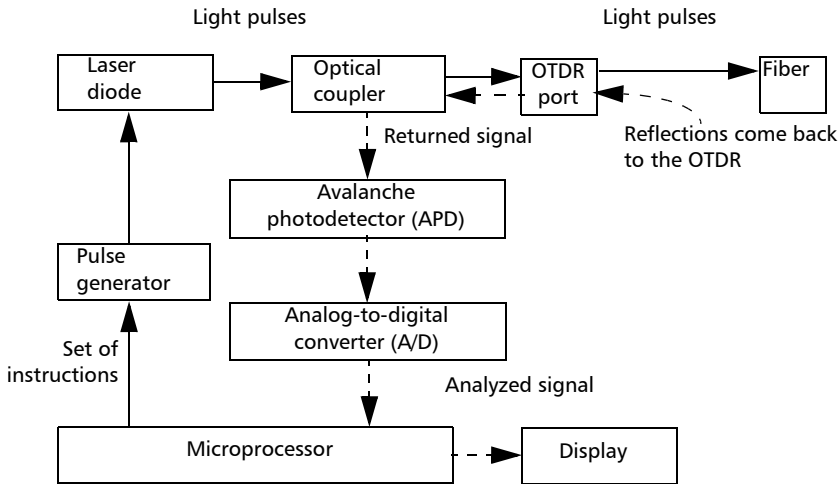

When the full trace is displayed, each point represents an average of many sampling points. You will have to zoom to see each point.

## Power Sources

Your unit operates with the following power sources:

- AC adapter/charger (connected to standard power outlet—indoor use only). Compatible car outlet adapter available upon request.
- One lithium-ion rechargeable battery (automatically takes over if you disconnect the AC adapter/charger).

**Note:** *When it is connected with the AC adapter/charger, the unit will function even if the battery is not present.*

- Possible to switch from AC adapter/charger to battery power or vice versa without affecting operation.
- The battery recharges automatically when the AC adapter/charger is connected.
- Rechargeable battery (for clock). This battery can keep the date and time for weeks even if AC power and the lithium-ion battery (main battery) are not connected.

### Conventions

Before using the product described in this guide, you should understand the following conventions:



#### **WARNING**

Indicates a potentially hazardous situation which, if not avoided, could result in *death or serious injury*. Do not proceed unless you understand and meet the required conditions.



#### **CAUTION**

Indicates a potentially hazardous situation which, if not avoided, may result in *minor or moderate injury*. Do not proceed unless you understand and meet the required conditions.



#### **CAUTION**

Indicates a potentially hazardous situation which, if not avoided, may result in *component damage*. Do not proceed unless you understand and meet the required conditions.



#### **IMPORTANT**

Refers to information about this product you should not overlook.



## 2 **Safety Information**



### **WARNING**

Do not install or terminate fibers while a light source is active. Never look directly into a live fiber and ensure that your eyes are protected at all times.



### **WARNING**

The use of controls, adjustments and procedures other than those specified herein may result in exposure to hazardous situations or impair the protection provided by this unit.



### **IMPORTANT**

When you see the following symbol on your unit , make sure that you refer to the instructions provided in your user documentation. Ensure that you understand and meet the required conditions before using your product.

# Safety Information

## Laser Safety Information

### Laser Safety Information

#### Units with Built-In VFL

Your instrument is a Class 3R laser product in compliance with standards IEC 60825-1 and 21 CFR 1040.10. It is potentially harmful in direct intrabeam viewing.

The following label(s) indicate that the product contains a Class 3R source:

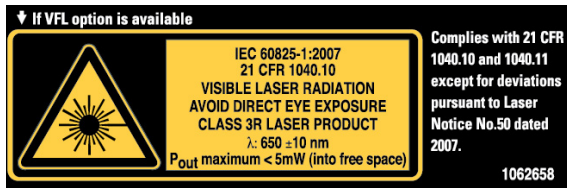

Affixed to bottom panel of unit

#### Units without VFL

Your instrument is a Class 1M laser product in compliance with standards IEC 60825-1 and 21 CFR 1040.10. Invisible laser radiation may be encountered at the output port.

The product is safe under reasonably foreseeable conditions of operation but it may be hazardous if you use optics within a diverging or collimated beam. *Do not view directly with optical instruments.*

The following label(s) indicate that the product contains a Class 1M source:



Affixed to side panel of unit

## Electrical Safety Information

If you need to ensure that the unit is completely turned off, disconnect the power cable and remove the batteries.



### **WARNING**

- Use the external power supply indoors only. Position the unit so that the air can circulate freely around it.
- Operation of any electrical instrument around flammable gases or fumes constitutes a major safety hazard.
- To avoid electrical shock, do not operate the unit if any part of the outer surface (covers, panels, etc.) is damaged.
- Only authorized personnel should carry out adjustments, maintenance or repair of opened units under voltage. A person qualified in first aid must also be present. Do not replace any components while power cable and battery are connected.
- Capacitors inside the unit may be charged even if the unit has been disconnected from its electrical supply.
- Use only the AC adapter/charger provided by EXFO with your unit.

## Safety Information

### Electrical Safety Information

---

Equipment Ratings	
Temperature	
➤ Operation	➤ 0 °C to 50 °C (32 °F to 122 °F)
➤ Storage	➤ -40 °C to 70 °C (-40 °F to 158 °F)
Relative humidity <sup>a</sup>	
➤ unit	➤ ≤ 95 % non-condensing
➤ AC adapter	➤ 0 % to 80 % non-condensing
Maximum operation altitude	5000 m (16405 ft)
Pollution degree	2 (when plugged to AC mains) <sup>b</sup> 3 (when operated from batteries) <sup>c</sup>
Overvoltage category	II
Input power <sup>d</sup>	
➤ unit	➤ --- 24 V; 3.75 A
➤ AC adapter	➤ ~ 100 - 240 V; 50/60 Hz; 1.6 A

- Measured in 0 °C to 31 °C (32 °F to 87.8 °F) range, decreasing linearly to 50 % at 40 °C (104 °F).
- For indoor use only.
- Equipment is normally protected against exposure to direct sunlight, precipitations and full wind pressure.
- Not exceeding ± 10 % of the nominal voltage.

# 3 Getting Started with Your MAX-700

## Using the Supports

Your unit has been designed to stand either vertically (with the screen facing you), or at an angle, using the two supports.

**Note:** *The supports ensure optimum stability to the unit during your tests.*

**To change the orientation of the unit using the supports:**

Pull out the two supports.

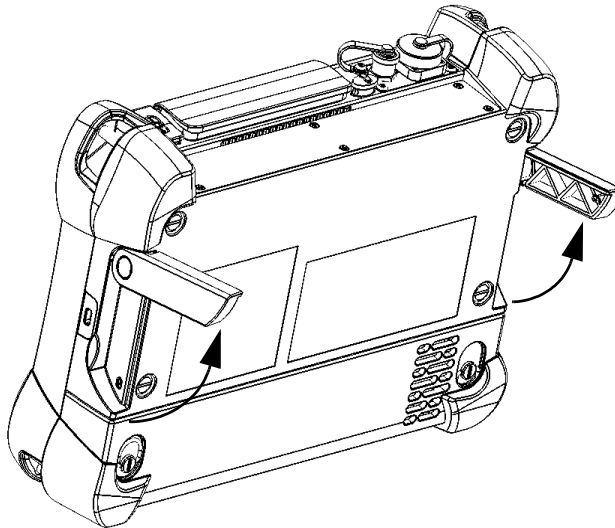

## Getting Started with Your MAX-700

### *Securing Your Unit Using a Kensington Lock*

---

## Securing Your Unit Using a Kensington Lock

Your unit is equipped with a security slot to which you can connect an optional Kensington lock (security cable). You can secure your unit with this lock to help prevent theft.

### ***To secure your unit:***

Connect your lock to the security slot located on the side of your unit.

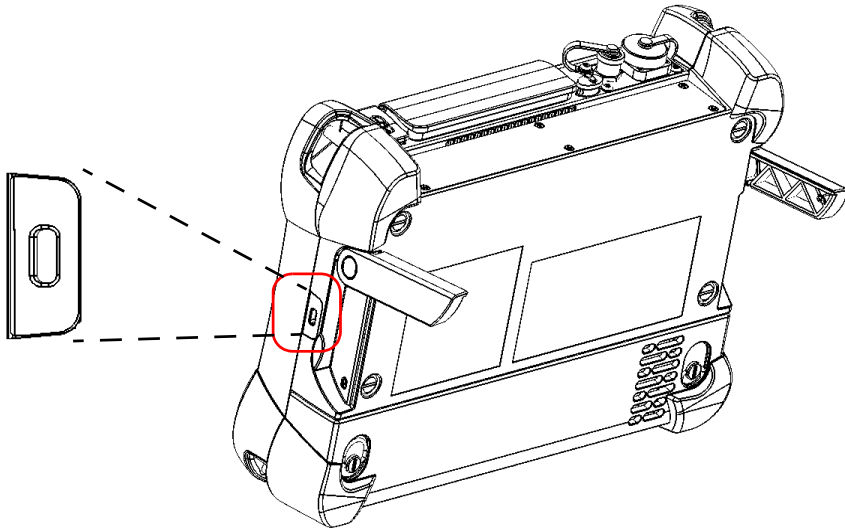

## Installing a Keyboard, Mouse or Other USB Devices

Your unit supports many USB devices. The table below lists the supported USB devices.

Device	Details
Memory key	For data transfer between your unit and a computer when you do not have access to a network. If you need information on how to transfer data using a memory key, see <i>Managing Data</i> on page 255.
Keyboard	When you are required to enter alphanumeric data, an on-screen (virtual) keyboard is displayed. However, if you prefer, you can use a hardware keyboard.  <b>Note:</b> <i>Even if a keyboard is connected, the on-screen keyboard will still be displayed when you work in the MAX-700 software.</i>
Mouse	If you prefer to use a mouse instead of the touchscreen, you can install one.

## Getting Started with Your MAX-700

*Installing a Keyboard, Mouse or Other USB Devices*

---

Device	Details
Composite device	You can use composite devices, that is devices that input information to your unit using more than one mean (for example, combinations of keyboard and mouse).
Hub	This device will be particularly useful to you if you need extra USB ports.
USB to RS-232 adapter (purchased from EXFO)	To be able to transfer data between your unit and a device only equipped with RS-232 (serial) ports. For more information, see <i>Using the USB to RS-232 Adapter</i> on page 271.

You can connect several devices at the same time.



### IMPORTANT

Your unit does not support USB printers. If you want to print documents, you must use PDFCreator or a network printer (see *Printing Documents* on page 233), or transfer your files to a computer (see *Managing Data* on page 255) that has access to a network printer.



## Getting Started with Your MAX-700

### *Installing a Keyboard, Mouse or Other USB Devices*

---

#### **To install a USB device on your unit:**

Connect the USB device to any of the USB ports (located on top of the unit).

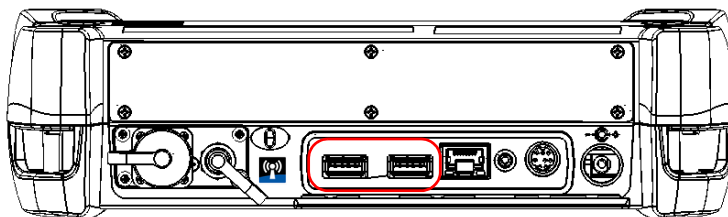

**Note:** *It is not necessary to turn off the unit before connecting the USB device. The software will automatically detect its presence.*

Your device is automatically recognized and immediately usable.

# Using the On-Screen (Virtual) Keyboard

Your unit is equipped with an on-screen keyboard that supports multilingual features. This keyboard functions according to the keyboard settings of Windows.

***To use the on-screen keyboard:***

- 1.** From the unit's front panel, press the  button.
- 2.** Select the location where you want to enter text.
- 3.** Enter the data as required.
- 4.** Exit the location when you have finished entering data.

## **Right-Clicking with the Touchscreen**

If you are used to work with a mouse, you may find it useful to be able to perform a right-click on your touchscreen.

***To right-click with the touchscreen:***

From the location where you want to right-click, using the stylus or any blunt pointing device, press the screen for a few seconds until the shortcut menu appears.

If you want to hide the shortcut menu without performing any action, simply tap anywhere outside the menu.

## Turning On or Off the Unit

There are several ways to turn off the unit, including the following:

- *Standby*: keeps the unit's status information in memory (RAM). The next time you turn your unit on, you will quickly return to your work environment (running applications will still be running). This mode will take more battery power while the unit is off.
- *Shutdown*: completely cuts power to the test modules and platform; the unit will perform a complete restart routine the next time you use it. You should perform a shutdown if you do not intend to use your unit for a week or more.

After a shutdown, the unit will start in the MAX-700 software or in the application you defined as the startup application.

**Note:** *As it is the case for many computers, pressing and holding down the power button for more than 10 seconds will perform a power down reset on the unit.*

By default, your unit will display the standard shutdown window from which you can select the desired shutdown mode. However, you can configure your unit to perform a different action when the power button is pressed.

You can also configure your unit to automatically restart when AC power comes back after the unit has turned off (emergency shutdown or standby modes) when battery level is too low.

### **To turn on the unit:**

Press the On/Off button.

### **To turn off the unit:**

1. Press the On/Off button.

OR

On the Windows taskbar, tap **Start**.

This will display the standard shutdown window, from which you have a choice of actions or shutdown modes.

2. Select **Shutdown**.

### **To define the behavior of the power button:**

1. From the **Main Menu**, tap **Setup**. Double-tap **Power Options**.

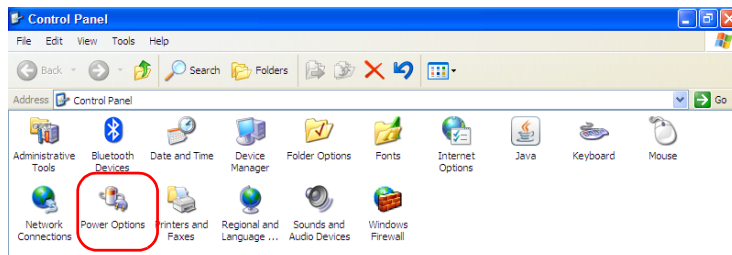

2. Select the **Advanced** tab.

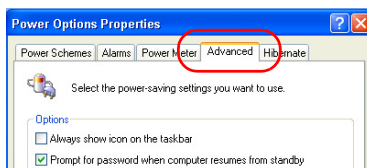

## Getting Started with Your MAX-700

### Turning On or Off the Unit

---

3. From the **When I press the power button on my computer** list, select the desired behavior (**Ask me what to do** option is selected by default).

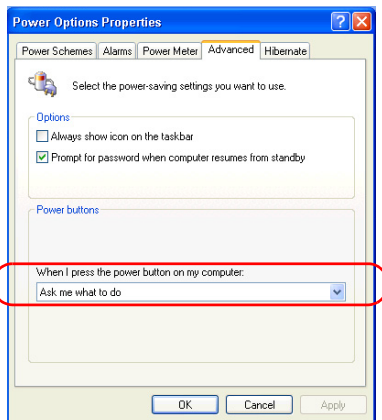

4. Tap **Apply** to confirm the changes, and then **OK** to return to **Control Panel**.

**To configure your unit to automatically restart after AC power comes back:**

1. From the **Main Menu**, tap **System Settings**.
2. From the **System Settings** window, tap **Startup Applications**.

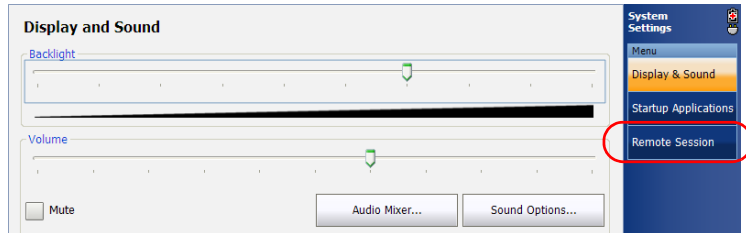

3. Select the **Power on the unit when AC outlet is connected or after power outage** box to enable the corresponding option.

OR

Clear the box if you prefer that your unit does not restart automatically after AC power comes back.

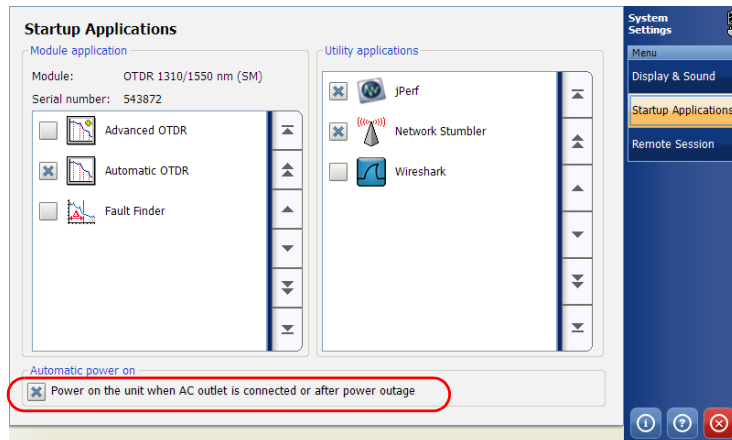

4. Tap  to confirm the changes and return to the main window.

## Installing or Upgrading the Applications

All the necessary applications have been preinstalled and configured at the factory. However, you may have to upgrade some applications when new versions become available or to reinstall them.

From the DVD that came with your unit, you can create an installation USB key in case you ever need to reinstall the MAX-700 software (the software that comes with your unit) and the instrument applications as well as Update Manager. All the necessary files will be copied to the USB key.

When updates are available for an application, you will need to download them from Internet, either directly on your unit or on a computer. In the latter case, you will need to transfer the update files to your unit (see *Managing Data* on page 255). The update files must be copied to the location that has been specified for the deployment packages in Update Manager.



### **IMPORTANT**

If you ever need to reinstall Update Manager on your unit, ensure that:

- The installation files for Update Manager remain on your unit. Otherwise, it will not be possible to install new versions of this application later.
- You choose the folder containing the Update Manager installation files carefully. If you move or rename this folder, you will have to manually browse for the modified folder when you want to install new versions of this application.



For the creation of an installation USB key, you will need:

- the installation DVD
- a computer equipped with a USB port; Windows must be installed on the computer
- a USB memory key

For the upgrades, you will need:

- a MAX-700 unit
- a computer equipped with a USB port; Windows must be installed on the computer
- a USB memory key

**Note:** *For the upgrades, the computer and USB key are only necessary if you do not wish to download the files directly on your unit.*

**Note:** *For more information on the installation, refer to the Update Manager online help.*

## Getting Started with Your MAX-700

### *Installing or Upgrading the Applications*

---

#### **To update or reinstall Update Manager:**

- 1.** If necessary, retrieve the desired installation files from the Internet.  
If you do not intend to download files directly on your unit, connect a USB memory key to one of the USB ports of the computer and copy the installation files to this USB key.
- 2.** If it is not already done, turn on your unit.
- 3.** Exit the MAX-700 software and the OTDR application.
- 4.** If you want to install Update Manager using the USB key, disconnect it from the computer and connect it to one of the USB ports of your unit.
- 5.** On your unit, create a folder on the Windows desktop.
- 6.** Copy the installation files (from the USB key) to the newly created folder.
- 7.** From the newly created folder, tap the *Setup.exe* file to start the installation.
- 8.** Follow the on-screen instructions.
- 9.** When the installation is complete, simply disconnect the USB memory key.

### **To install or upgrade the applications:**

- 1.** If necessary, retrieve the desired installation files from the Internet.  

If you do not intend to download files directly on your unit, connect a USB memory key to one of the USB ports of the computer and copy the installation files to this USB key.
- 2.** If it is not already done, turn on your unit. If necessary, exit the OTDR application.
- 3.** If you want to install or update applications using the USB key, disconnect it from the computer and connect it to one of the USB ports of your unit.
- 4.** Copy the installation files (from the USB key) to the folder containing the update and installation packages on your unit. By default, Update Manager will search for files at the root of the USB key. For more information, refer to the Update Manager online help.
- 5.** From the MAX-700 software, on your unit, select the **Utilities** tab.
- 6.** Tap **Update Manager** to start the corresponding application. For more information on how to install or upgrade applications, refer to the Update Manager online help.
- 7.** When installation is complete, simply disconnect the USB memory key.

## Getting Started with Your MAX-700

*Installing or Upgrading the Applications*

---

### **To create an installation USB key:**

- 1.** Turn on the computer and insert the installation DVD in the CD/DVD drive.
- 2.** Connect a USB memory key to one of the USB ports of the computer.
- 3.** From the **Welcome** window on the installation DVD, click **Installation Files and Tools**.
- 4.** Select the **MAX-700 Installation Files** check box and click **Next**.
- 5.** Follow the on-screen instructions. All the necessary components will be copied to your USB key.
- 6.** When the operation is complete, click **Close**, and then **Exit** to close the installation DVD window.
- 7.** Disconnect the USB memory key from the computer.

Your new installation USB key is now ready.

## **Activating Software Options**

The software options purchased at the same time as your unit have been activated for you already. However, if you purchase options afterwards, you will have to activate them yourself.

Before being able to activate options, you need to contact EXFO with the following information:

- Purchase order number of the newly purchased options
- Instrument or unit (platform) serial number (depending on whether the software options were purchased for the OTDR or the unit itself)
- Customer's name
- Customer's company name
- Customer's phone number
- Customer's e-mail address
- Instrument or unit on which the option will be installed

You will receive a single key (.key) file with which you will be able to unlock all the new options that you have purchased.

## Getting Started with Your MAX-700

### Activating Software Options

---

#### **To activate the options for your unit:**

1. Connect a USB memory key to one of the USB ports of your computer.
2. Copy the key file to the USB memory key.
3. Disconnect the USB key from the computer and connect it to your unit.
4. From the MAX-700, select the **Utilities** tab, then tap **Options Activation**.

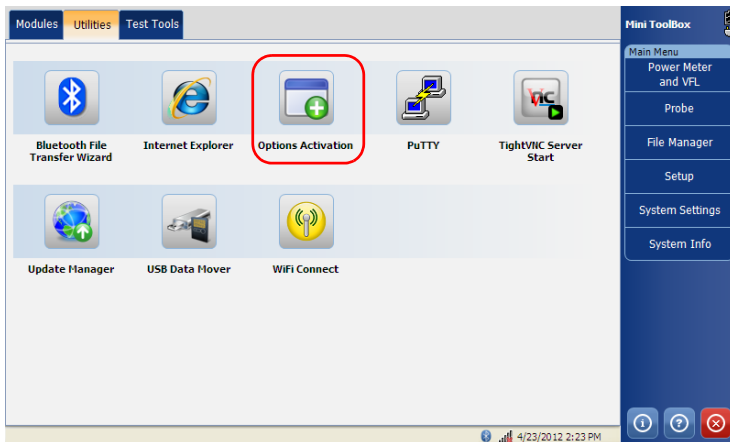

5. In the **Platform Options** tab, use the **Browse** button to locate the key file that you want to use.

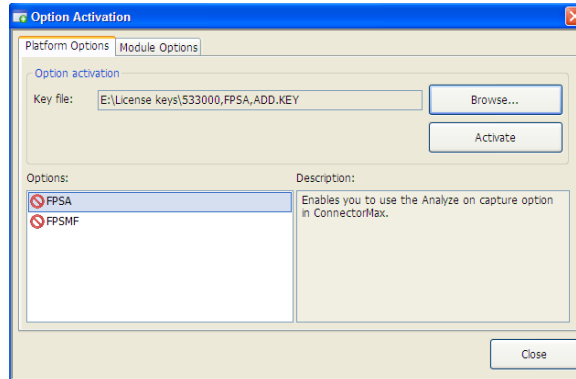

6. Press **Activate**.

The option indicator will turn into a green check mark to confirm that the option is now active.

7. Press **OK** to close the **Option Activation** window.

**Note:** *At this point, if you have used a USB key to copy your key file, you can remove it as it is not required to use your new options.*

## Getting Started with Your MAX-700

### Activating Software Options

---

#### **To activate software options for your module:**

1. Connect a USB memory key to one of the USB ports of your computer.
2. Copy the key file to the USB memory key.
3. Disconnect the USB key from the computer and connect it to your unit.
4. From the MAX-700, select the **Utilities** tab, then tap **Options Activation**.

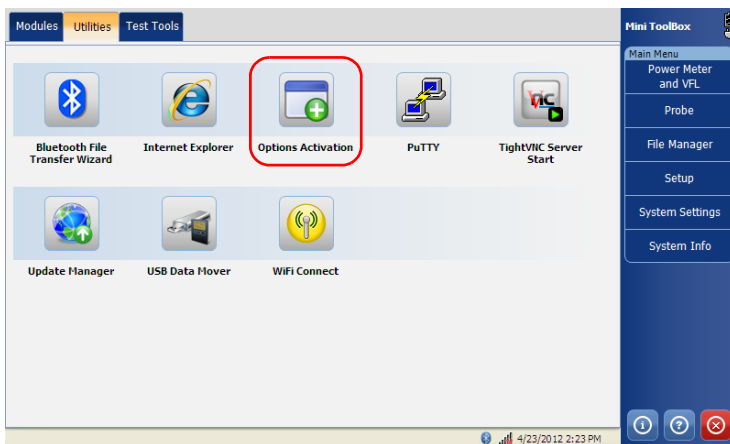



5. In the **Module Options** tab, use the **Browse** button to locate the key file that you want to use.

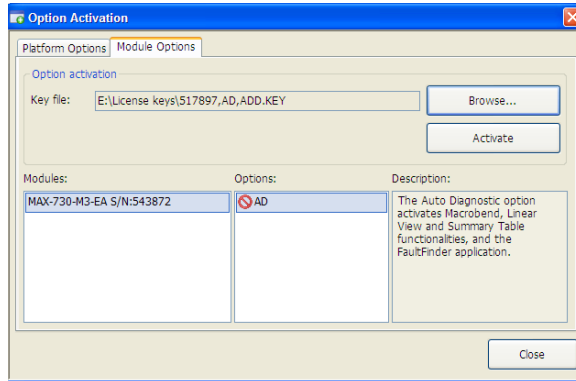

6. Press **Activate**.

The option indicator will turn into a green check mark to confirm that the option is now active.

**Note:** You can see the supported options for the module in the **Options** list.

7. Press **OK** to close the **Option Activation** window.

**Note:** At this point, if you have used a USB key to copy your key file, you can remove it as it is not required to use your new options.

### Starting Instrument Applications

Your OTDR can be configured and controlled from its dedicated application in the MAX-700 software.

**To start an application:**

At the bottom of the main window, press the button corresponding to the desired application.

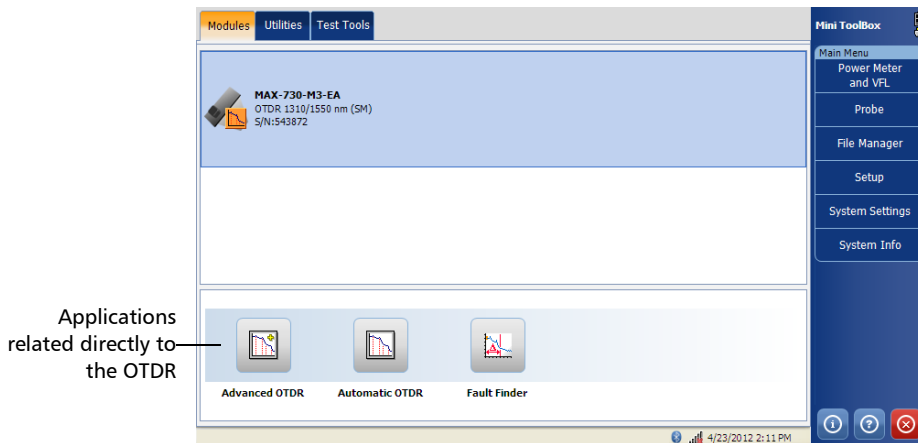

**To start the Power Meter or Probe application:**

From **Main Menu**, press **Power Meter** or **Probe**.

The main window (shown below) contains all the commands required to control the OTDR instrument:

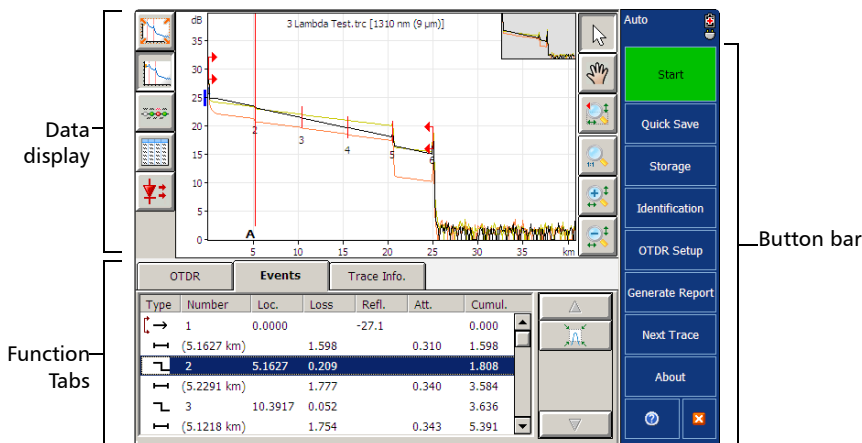

**Note:** Due to screen resolution, the appearance of your OTDR application may vary slightly from the illustrations presented in this user guide.

## Timer

Once the acquisition has begun, a timer is displayed on the right-hand side of the screen, indicating the remaining time until the next acquisition.



# 4 **Preparing Your MAX-700 for a Test**

## **Installing the EXFO Universal Interface (EUI)**

The EUI fixed baseplate is available for connectors with angled (APC) or non-angled (UPC) polishing. A green border around the baseplate indicates that it is for APC-type connectors.

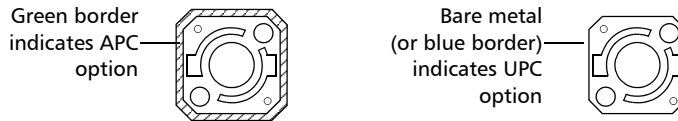

### **To install an EUI connector adapter onto the EUI baseplate:**

1. Hold the EUI connector adapter so the dust cap opens downwards.

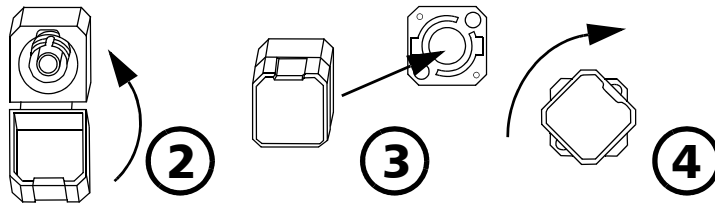

2. Close the dust cap in order to hold the connector adapter more firmly.
3. Insert the connector adapter into the baseplate.
4. While pushing firmly, turn the connector adapter clockwise on the baseplate to lock it in place.

# Cleaning and Connecting Optical Fibers



## IMPORTANT

To ensure maximum power and to avoid erroneous readings:

- Always inspect fiber ends and make sure that they are clean as explained below before inserting them into the port. EXFO is not responsible for damage or errors caused by bad fiber cleaning or handling.
- Ensure that your patchcord has appropriate connectors. Joining mismatched connectors will damage the ferrules.

### ***To connect the fiber-optic cable to the port:***

- 1.** Inspect the fiber using a fiber inspection microscope. If the fiber is clean, proceed to connecting it to the port. If the fiber is dirty, clean it as explained below.
- 2.** Clean the fiber ends as follows:
  - 2a.** Gently wipe the fiber end with a lint-free swab dipped in isopropyl alcohol.
  - 2b.** Use compressed air to dry completely.
  - 2c.** Visually inspect the fiber end to ensure its cleanliness.

3. Carefully align the connector and port to prevent the fiber end from touching the outside of the port or rubbing against other surfaces.

If your connector features a key, ensure that it is fully fitted into the port's corresponding notch.

4. Push the connector in so that the fiber-optic cable is firmly in place, thus ensuring adequate contact.

If your connector features a screwsleeve, tighten the connector enough to firmly maintain the fiber in place. Do not overtighten, as this will damage the fiber and the port.

**Note:** *If your fiber-optic cable is not properly aligned and/or connected, you will notice heavy loss and reflection.*

EXFO uses good quality connectors in compliance with EIA-455-21A standards.

To keep connectors clean and in good condition, EXFO strongly recommends inspecting them with a fiber inspection probe before connecting them. Failure to do so will result in permanent damage to the connectors and degradation in measurements.

## Naming Trace Files Automatically

Each time you start an acquisition, the application suggests a file name based on autonaming settings. This file name appears on the upper part of the graph and the linear view.

The file name is made of a static part (alphanumeric) and a variable part (numeric) that will be incremented or decremented, according to your selection, as follows:

If you choose incrementation...	If you choose decrementation...
Variable part increases until it reaches the <i>highest possible value</i> with the selected number of digits (for example, 99 for 2 digits), then restarts at 0.	Variable part decreases until it reaches 0, then restarts at the <i>highest possible value</i> with the selected number of digits (for example, 99 for 2 digits).

After saving a result, the unit prepares the next file name by incrementing (or decrementing) the suffix.

**Note:** *If you choose not to save a particular trace file, the suggested file name will remain available for the next trace you acquire.*

If you deactivate the automatic file naming function, the application will prompt you to specify a file name. The default file name is *Unnamed.trc*.

By default, traces are saved in native (.trc) format, but you can configure your unit to save them in Bellcore (.sor) format (see *Selecting the Default File Format* on page 95).

**Note:** *If you select the Bellcore (.sor) format, the unit will create one file per wavelength (for example, TRACE001\_1310.sor and TRACE001\_1550.sor, if you included both 1310 nm and 1550 nm in your test). The native format contains all wavelengths in a single file.*



**To configure the automatic file naming:**

- 1.** From the button bar, press **OTDR Setup**.
- 2.** Select the **Acquisition** tab.
- 3.** Press **Default Trace Information**.

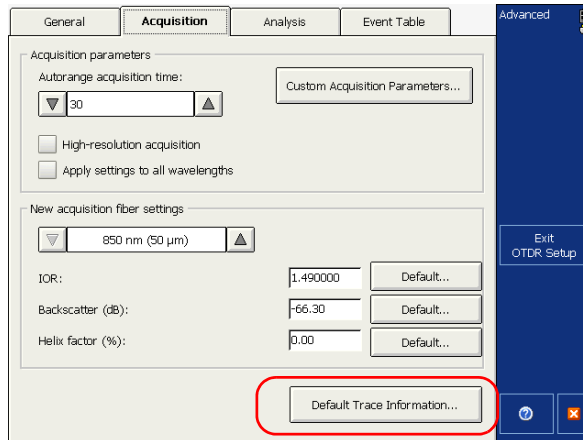

## Preparing Your MAX-700 for a Test

### Naming Trace Files Automatically

4. Fill out the required information in the corresponding boxes and select the direction for your trace files.

The 'Default Trace Information' dialog box is shown. It has a title bar 'Default Trace Information'. The 'Fiber' section includes: Fiber ID: Fiber001 (with a '...' button), Cable ID: Cable1, Location A: Quebec, Location B: Montreal, and Direction:  A->B  B->A. The 'Job' section includes: Job ID: [empty], Operator A: [empty], Operator B: [empty], Company: [empty], and Customer: [empty]. There is a 'Comments' text area. At the bottom are buttons: Clear All, File Autonoming..., OK, and Cancel.

5. Press the  button appearing next to the **Fiber ID** box to change the contents of the fiber identification.
6. Change the criteria as needed, then press **OK** to confirm your new settings and return to the **Default Trace Information** window.

The 'Fiber Setup' dialog box is shown. It has a title bar 'Fiber Setup'. It contains: Prefix: fiber, Suffix: 002, Number of digits: 3 (dropdown), and 'Next value' section with  Increment and  Decrement. There are OK and Cancel buttons. Callouts: 'Value at which the autonumbering sequence starts' points to the Suffix field; 'Number of digits composing the variable part' points to the Number of digits field; 'The variable part will increase or decrease depending on your choice' points to the radio buttons.

7. Press **File Autonaming** to set up the trace file name options.

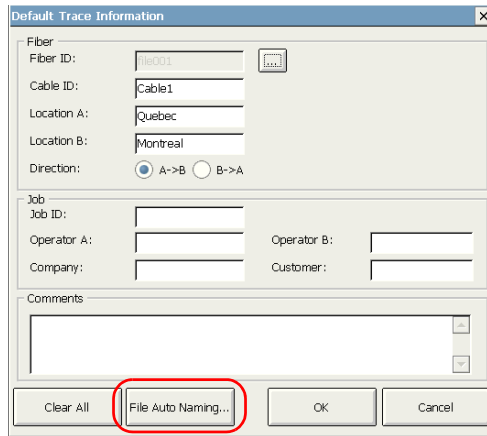

8. In the **File Name** window, select the desired components to include in the file name. You can change the order of apparition with the up and down arrow buttons.

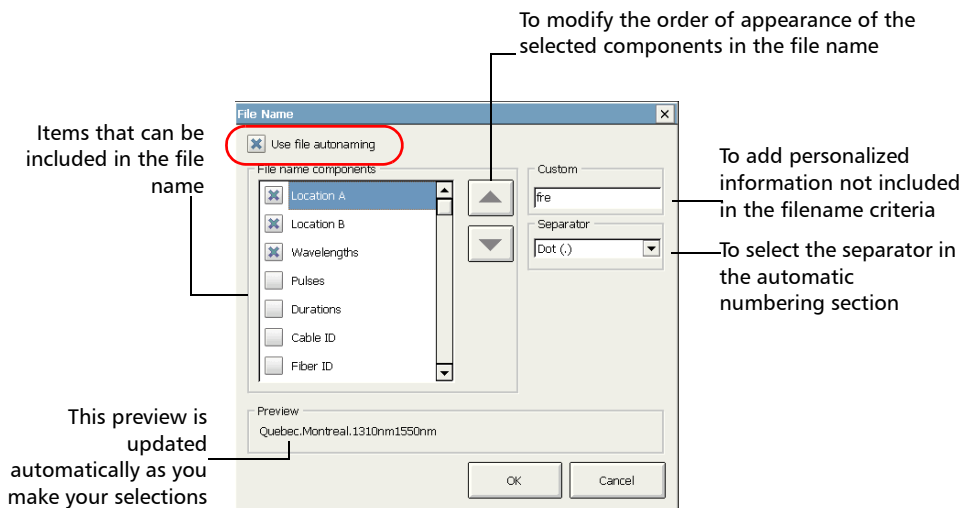

9. Press **OK** to confirm your new settings.

## Preparing Your MAX-700 for a Test

### Enabling or Disabling the First Connector Check

# Enabling or Disabling the First Connector Check

**Note:** This function is available in all OTDR modes. However, the first connector check parameter used in Fault Finder mode is independent from the one used in the other OTDR modes (Auto and Advanced).

The first connector check feature is used to verify that the fibers are properly connected to the OTDR. It verifies the injection level and displays a message when an unusually high loss occurs at the first connection, which could indicate that no fiber is connected to the OTDR port. By default, this feature is not enabled.

**Note:** The first connector check is only performed when you test at singlemode wavelengths.

### To enable or disable the first connector check:

1. From the **Main Menu**, press **OTDR Setup** then press the **General** tab.
2. To enable the first connector check, select the **First connector check** box.

OR

To disable it, clear the box.

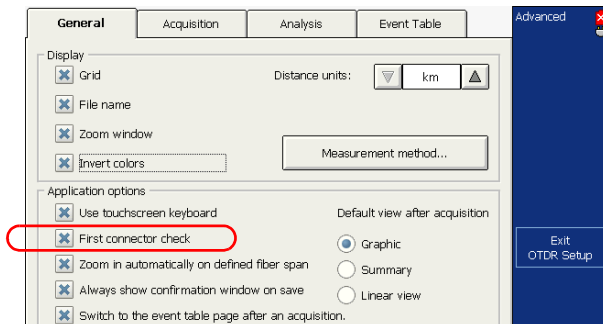

## Setting Macrobend Parameters

**Note:** *This function is available with the Auto Diagnostic (AD) optional software package only.*

**Note:** *This function is available both in Advanced and Auto modes.*

Your unit can locate macrobends by comparing the loss values measured at a certain location, for a certain wavelength (for example, 1310 nm) with the loss values measured at the corresponding location, but for a greater wavelength (for example, 1550 nm).

The unit will identify a macrobend when comparing two loss values if:

- Of the two loss values, the greater loss occurred at the greater wavelength.
- AND
- The difference between the two loss values exceeds the defined delta loss value. The default delta loss value is 0.5 dB (which is suitable for most fibers), but you can modify it.

You can also disable macrobend detection.

**Note:** *Macrobend detection is only possible with singlemode wavelengths. Filtered wavelengths or wavelengths of dedicated OTDR ports are not available for macrobend detection.*

For information on how the information about macrobends is available after an acquisition, see *Linear View* on page 110 and *Summary Table* on page 112.

## Preparing Your MAX-700 for a Test

### Setting Macrobend Parameters

---

#### **To set macrobend parameters:**

1. From the **Main Menu**, press **OTDR Setup** then select the **General** tab.
2. To enable the macrobend detection, select the **Show macrobend** check box.

OR

To disable it, clear the check box.

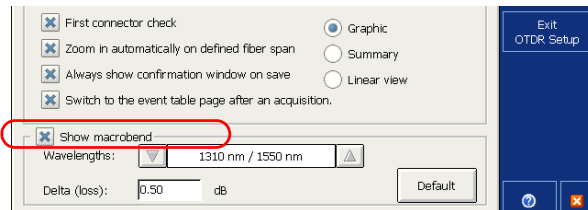

3. If necessary, set the delta value as follows:
  - 3a. From the **Wavelengths** list, select the pair of wavelengths for which you want to define the delta value.

Only the combinations of wavelengths your module can support will be available.

For more significant results, EXFO recommends to always select the combination of wavelengths including the smallest possible wavelength and the greatest wavelength (for example, if your module supports 1310 nm, 1550 nm, and 1625 nm, you would select the 1310 nm/1625 nm combination).

- 3b. In the **Delta (loss)** box, enter the desired value.
- 3c. Repeat steps 3a and 3b for all combinations of wavelengths.

#### **To revert to default settings:**

1. Press **Default**.
2. When the application prompts you, answer **Yes** if you want to apply the settings to all combinations of wavelengths.

## 5 *Testing Fibers in Auto Mode*

Auto mode automatically evaluates fiber length, sets acquisition parameters, acquires traces, and displays event tables and acquired traces.

In Auto mode, you can set the following parameters directly:

- Test wavelengths (all selected by default)
- Fiber type (singlemode, singlemode live, or multimode) for models supporting these fiber types
- Autorange acquisition time
- IOR (group index), RBS coefficient and helix factor

For all other parameters, the application uses those defined in Advanced mode, except that analysis is always performed after acquisitions.

If you ever need to modify other parameters, go to Advanced mode (see *Testing Fibers in Advanced Mode* on page 55 and *Preparing Your MAX-700 for a Test* on page 41).

In Auto mode, the application will automatically evaluate the best settings according to the fiber link currently connected to the unit (in less than 5 seconds). If you interrupt it, no data will be displayed.

Fiber characteristics are evaluated only once per session. Other fibers you connect to, within the same cable, will be tested with the same settings. When you start testing another link, you can reset these parameters.

Once this evaluation is complete, the application starts acquiring the trace. The trace display is continually updated.

**Note:** *You can interrupt the acquisition at any time. The application will display the information acquired to that point.*

## Testing Fibers in Auto Mode

Once the acquisition is complete or interrupted, the analysis starts for acquisitions of 5 seconds or more.

After analysis, the trace is displayed and events appear in the events table.

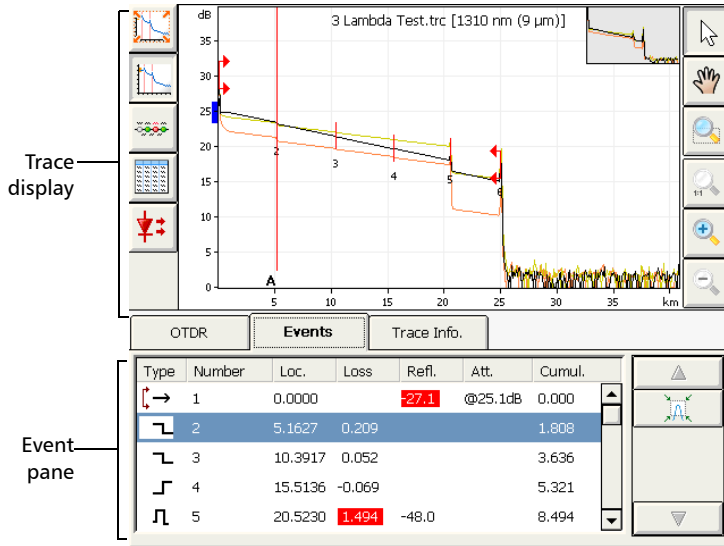

The application will also display status messages if you have selected to display pass/fail messages (see *Setting Pass/Fail Thresholds* on page 70).

You can save the trace after analysis. If former results have not been saved yet, the application prompts you to save them before starting a new acquisition.



### To acquire traces in Auto mode:

1. Clean the connectors properly.
2. Connect a fiber to the OTDR port.

If your unit is equipped with two OTDR ports, ensure that you connect the fiber to the appropriate port (singlemode, singlemode live, or multimode), depending on the wavelength you intend to use.



## CAUTION

Never connect a live fiber to the OTDR port without a proper setup. Any incoming optical power ranging from  $-65$  dBm to  $-40$  dBm will affect the OTDR acquisition. The way the acquisition will be affected depends on the selected pulse width. Any incoming signal greater than 10 dBm could damage your MAX-700 permanently. For live-fiber testing, refer to the SM Live port specifications for the characteristics of the built-in filter.

3. Set the autorange acquisition time (see *Setting the Autorange Acquisition Time* on page 60).
4. Go to the **OTDR** tab.
5. If your OTDR supports singlemode, singlemode live, or multimode wavelengths, under **Wavelengths**, from the list, select the desired fiber type (for live-fiber testing, select SM Live; for C fiber, select  $50\ \mu\text{m}$  and for D fiber, select  $62.5\ \mu\text{m}$ ).

OTDR	Events	Trace Info.
Wavelengths		
EM		
<input type="checkbox"/> 1310 nm		
<input type="checkbox"/> 1550 nm		
Settings		
Distance:	Pulse:	Acquisition time:
1,2500 km	1310 nm: 30ns 1550 nm: 30ns	30 s
<input type="button" value="Reset"/>		
Status		
Selected acquisition type: Singlemode (9 $\mu\text{m}$ )		

## Testing Fibers in Auto Mode

---

6. Select the boxes corresponding to the desired test wavelengths. You must select at least one wavelength.
7. If you want to clear the settings the OTDR has determined to start with a new set of OTDR settings, press **Reset**.
8. Press **Start**.

If the first connector check feature is enabled, a message will appear if there is a problem with the injection level (see *Enabling or Disabling the First Connector Check* on page 48).

9. Once the analysis is complete, save the trace by pressing **Quick Save** in the button bar.

The application will use a file name based on the autonaming parameters you defined (see *Naming Trace Files Automatically* on page 44). This file name appears at the top of the graph and at the top of the linear view table.

**Note:** *The application will only display the **Save File** dialog box if you have activated the feature to always be prompted when you save a file. From this dialog box, you can change the location, the file name and the file format.*

- 9a. If necessary, change the folder to which the file will be saved by pressing the **Location** button.
- 9b. If necessary, specify a file name.



### IMPORTANT

If you specify the name of an existing trace, the original file will be overwritten and only the new file will be available.

10. Press **OK** to confirm.

# 6 **Testing Fibers in Advanced Mode**

Advanced mode offers all the tools you need to perform complete OTDR tests and measurements manually and gives you control over all test parameters.

**Note:** *Most parameters can only be set if you select Advanced mode first. Once you have finished selecting your settings, you can simply return to the test mode you prefer.*

By default, in Advanced mode, all available test wavelengths are selected.

In this mode, you can either set the acquisition parameters yourself or let the application determine the most appropriate values.

In the latter case, the application will automatically evaluate the best settings according to the fiber link currently connected to the unit:

- The pulse width will be determined using a factory-defined signal-to-noise ratio (SNR) requirement specified where the End-of-Fiber (EoF) event has been detected.

The EoF event detection algorithm uses the end-of-fiber threshold defined in the **tab** of the application setup. If you are not sure about which value to choose, revert to the factory default value for this parameter.

- The range will then be set automatically. This optimum value may differ from the values currently associated with the **Distance** dial of the main window. In this case, the application will “add” the required value and mark it with a \* symbol.
- The application uses the acquisition time defined in the **Acquisition** tab of the OTDR setup (for more information, see *Setting the Autorange Acquisition Time* on page 60). The default value is 15 seconds. Longer acquisitions give better OTDR results.

## Testing Fibers in Advanced Mode

Although the application sets the acquisition parameters, you can modify these values as needed, even while the acquisition is in progress. The OTDR simply restarts the averaging each time a modification is made.

**Note:** You can interrupt the acquisition at any time. The application will display the information acquired to that point.

Once the acquisition is complete or interrupted, the analysis starts for acquisitions of 5 seconds or more.

After analysis, the trace is displayed. Events appear both in the events table and in the linear view (if you purchased the optional software package).

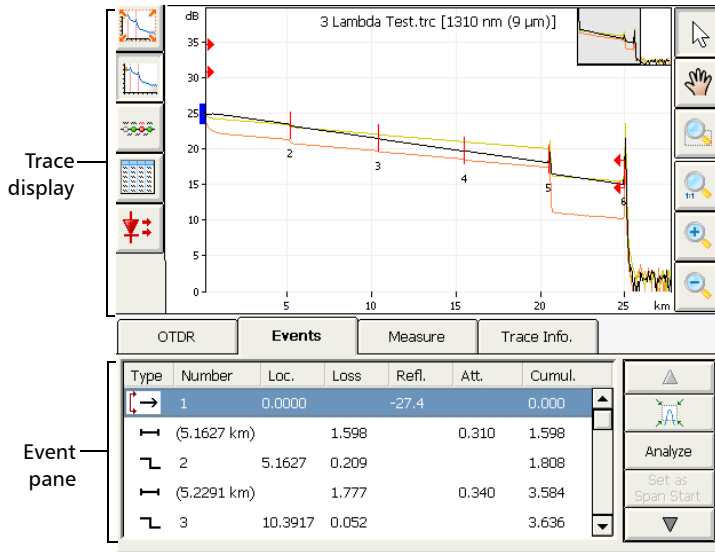

The application will also display pass/fail messages if you have selected this feature. For more information, see *Setting Pass/Fail Thresholds* on page 70.

You can save the trace after analysis. If former results have not been saved yet, the application prompts you to save them before starting a new acquisition.

### **To acquire traces:**

1. Clean the connectors properly (see *Cleaning and Connecting Optical Fibers* on page 42).
2. Connect a fiber to the OTDR port.

If your unit is equipped with two OTDR ports, ensure that you connect the fiber to the appropriate port (singlemode, singlemode live, or multimode), depending on the wavelength you intend to use.



### **CAUTION**

Never connect a live fiber to the OTDR port without a proper setup. Any incoming optical power ranging from  $-65$  dBm to  $-40$  dBm will affect the OTDR acquisition. The way the acquisition will be affected depends on the selected pulse width.

Any incoming signal greater than 10 dBm could damage your MAX-700 permanently. For live-fiber testing, refer to the SM Live port specifications for the characteristics of the built-in filter.

3. If you want the application to provide automatic acquisition values, set the autorange acquisition time (see *Setting the Autorange Acquisition Time* on page 60).
4. If you want to set your own IOR (group index), RBS coefficient or helix factor, see *Setting the IOR, RBS Coefficient, and Helix Factor* on page 61.
5. Go to the **OTDR** tab.
6. If you want to test in high resolution, simply select the feature (see *Enabling the High-Resolution Feature* on page 66).

## Testing Fibers in Advanced Mode

---

7. If your OTDR supports singlemode, singlemode live, or multimode wavelengths, under **Wavelengths**, from the list, select the desired fiber type (for live-fiber testing, select SM Live; for C fiber, select 50  $\mu\text{m}$  and for D fiber, select 62.5  $\mu\text{m}$ ).

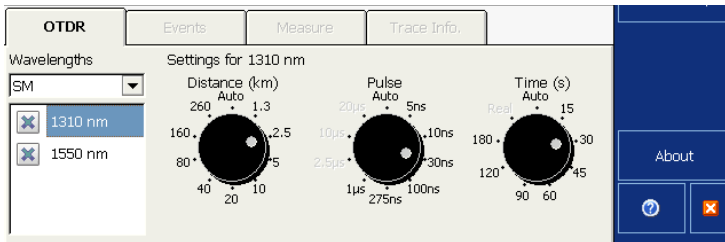

8. Select the boxes corresponding to the desired test wavelengths. You must select at least one wavelength.
9. Select the desired distance, pulse, and time values. For more information, see *Setting Distance Range, Pulse Width, and Acquisition Time* on page 63.
10. Press **Start**. If the first connector check feature is enabled, a message will appear if there is a problem with the injection level (see *Enabling or Disabling the First Connector Check* on page 48).

You can modify the acquisition parameters as needed, while the acquisition is in progress. The OTDR simply restarts the averaging each time a modification is made.

- 11.** Once the analysis is complete, save the trace by pressing **Quick Save** in the button bar.

The application will use a file name based on the autonaming parameters you defined (see *Naming Trace Files Automatically* on page 44). This file name appears at the top of the graph and at the top of the linear view table.

**Note:** *The application will only display the **Save File** dialog box if you have activated the feature to always be prompted when you save a file. From this dialog box, you can change the location, the file name and the file format.*

**11a.** If necessary, change the folder to which the file will be saved by pressing the **Location** button.

**11b.** If necessary, specify a file name.



### IMPORTANT

If you enter the name of an existing trace, the original file will be replaced with the new file.

- 12.** Press **OK** to confirm.

## Testing Fibers in Advanced Mode

### Setting the Autorange Acquisition Time

---

## Setting the Autorange Acquisition Time

**Note:** This function is available both in Advanced and Auto modes.

When performing automatic acquisitions in Advanced mode (see *Testing Fibers in Advanced Mode* on page 55) or before activating Auto mode (see *Testing Fibers in Auto Mode* on page 51), you can set an autorange acquisition time for the OTDR to average acquisitions over a set time period.

The application uses this value to determine the best settings for the test.

### To set the autorange acquisition time:

1. From the button bar, press **OTDR Setup** then go to the **Acquisition** tab.
2. Go to the **Autorange acquisition time** box and press the up or down arrow to select your preference. The default value is 30 seconds.
3. Press **Exit OTDR Setup** to return to the OTDR application.

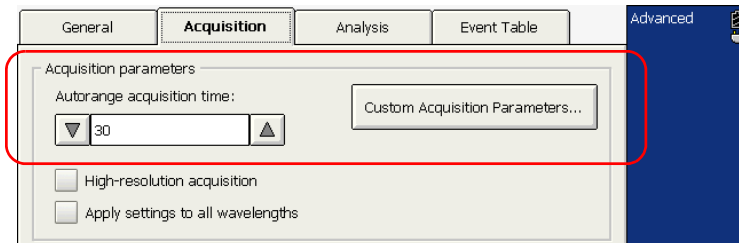



# Setting the IOR, RBS Coefficient, and Helix Factor

**Note:** *This function is available both in Advanced and Auto modes.*

You should set the IOR (group index), RBS coefficient and helix factor before performing tests in order to apply them to all newly acquired traces. However, if you are in Advanced mode, you can also set them at a later time in the **Trace Info.** tab to reanalyze a specific trace.

- The index of refraction (IOR) value (also known as group index) is used to convert time-of-flight to distance. Having the proper IOR is crucial for all OTDR measurements associated with distance (event position, attenuation, section length, total length, etc.). IOR is provided by the cable or fiber manufacturer.

The test application determines a default value for each wavelength. You can set the IOR value for each available wavelength. You should verify this information before each test.

- The Rayleigh backscatter (RBS) coefficient represents the amount of backscatter in a particular fiber. The RBS coefficient is used in the calculation of event loss and reflectance, and it can usually be obtained from the cable manufacturer.

The test application determines a default value for each wavelength. You can set the RBS coefficient for each available wavelength.

- The helix factor takes into consideration the difference between the length of the cable and the length of the fiber inside the cable. Fibers within a cable are spiraling around the cable core. The helix factor describes the pitch of that spiral.

By setting the helix factor, the length of the OTDR distance axis is always equivalent to the physical length of the cable (not the fiber).

## Testing Fibers in Advanced Mode

Setting the IOR, RBS Coefficient, and Helix Factor

**To set the IOR, RBS, and helix factor parameters:**

1. From the button bar, press **OTDR Setup**.
2. From the **OTDR Setup** window, go to the **Acquisition** tab.
3. Use the up or down arrow located on the side of the wavelength box to select the desired wavelength.

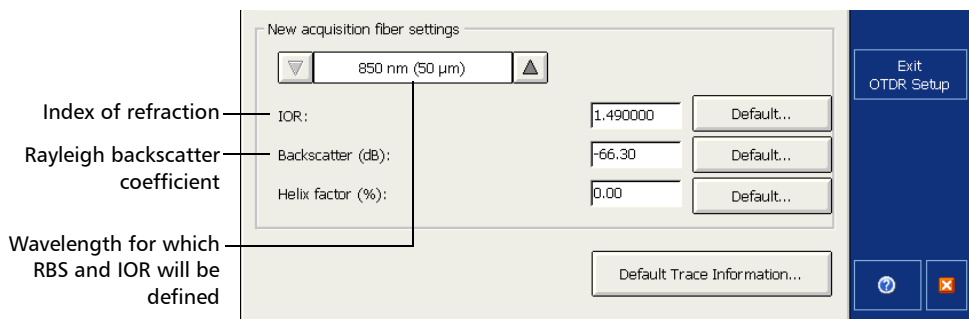

### IMPORTANT

Change the default RBS coefficient *only* if you have values provided by the fiber manufacturer. If you set this parameter incorrectly, your reflectance measurements will be inaccurate.

4. Select the default settings by pressing **Default**. When the application prompts you, answer **Yes** only if you want to apply the new settings to all wavelengths.

OR

Enter your own values in the boxes, for each available wavelength.

**Note:** You cannot define a different helix factor for each wavelength. This value takes into account the difference between the length of the cable and the length of the fiber inside the cable; it does not vary with wavelengths.

5. Press **Exit OTDR Setup**.

# Setting Distance Range, Pulse Width, and Acquisition Time

The distance range, pulse width and acquisition time are set with the controls in the Advanced main window.

- **Distance:** corresponds to the distance range of the fiber span to be tested according to the selected measurement units (see *Selecting the Distance Units* on page 99).

Changing the distance range alters the available settings of the pulse width and leaves only the settings available for the specified range. You can select either Auto or one of the predefined values.

You can customize the available distance range values (see *Customizing the Acquisition Distance Range Values* on page 101). If you select Auto, the application will evaluate the fiber length and set the acquisition parameters accordingly.

- **Pulse:** corresponds to the pulse width for the test. A longer pulse allows you to probe further along the fiber, but results in less resolution. A shorter pulse width provides higher resolution, but less distance range. The available distance ranges and pulse widths depend on your OTDR model.

**Note:** *Not all pulse widths are compatible with all distance ranges.*

You can select either Auto or one of the predefined values. If you select Auto, the application will evaluate the fiber type and length and set the acquisition parameters accordingly.

## Testing Fibers in Advanced Mode

### *Setting Distance Range, Pulse Width, and Acquisition Time*

---

- ▶ **Time:** corresponds to the acquisition duration (period during which results will be averaged). Generally, longer acquisition times generate cleaner traces (this is especially true with long-distance traces) because as the acquisition time increases, more of the noise is averaged out. This averaging increases the signal-to-noise ratio (SNR) and the OTDR's ability to detect small events.

The time settings will also determine how the timer (displayed in the toolbar) counts time during testing (see *Timer* on page 39).

If the predefined values do not suit your needs, you can customize one or all of them. For more information, see *Customizing the Acquisition Time Values* on page 103.

In addition to the displayed values, the following time modes are available:

- ▶ **Real:** used to immediately view changes in the fiber under test. In this mode, the SNR of the trace is lower and the trace is refreshed instead of averaged until you press **Stop**.

You can alternate between real mode and averaging time interval mode while an acquisition is in progress.

**Note:** *The **Real** item will be available if only one wavelength is selected.*

- ▶ **Auto:** the application will use the autorange acquisition time that you have previously defined (see *Setting the Autorange Acquisition Time* on page 60). It will also evaluate the fiber type and length and set the acquisition parameters accordingly.

You can use the same distance range, pulse width and acquisition time parameters for testing at all wavelengths on a multiwavelength OTDR.



## IMPORTANT

To test using the high-resolution feature, the acquisition time must be of at least 15 seconds.

## Testing Fibers in Advanced Mode

### Setting Distance Range, Pulse Width, and Acquisition Time

#### To set the parameters:

From the **OTDR** tab:

- Press the dial corresponding to the parameter you wish to set (the selection marker will move clockwise).

OR

- Press directly the value to select it. The selection marker will go to that value immediately.

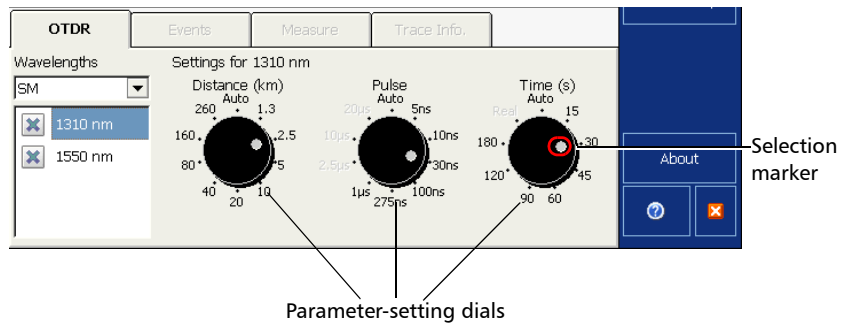

If you want the application to provide automatic acquisition values, move at least one dial to the **Auto** position. The other dials are automatically set accordingly.

**Note:** *If your OTDR supports singlemode, singlemode live, or multimode wavelengths, settings would be applied to either singlemode, singlemode live, or multimode wavelengths, depending on the selected fiber type (same settings for 50 µm and 62.5 µm).*

## Testing Fibers in Advanced Mode

### Enabling the High-Resolution Feature

---

**To use the same pulse and acquisition time for all wavelengths:**

1. From the button bar, press **OTDR Setup**, then go to the **Acquisition** tab.
2. Select the **Apply settings to all wavelengths** box.



The modifications you make to pulse, time, and range settings will now be applied to all wavelengths.

## Enabling the High-Resolution Feature

You can select the high-resolution feature to obtain more data points per acquisition. This way, the data points will be closer to each other, which will result in a greater distance resolution for the trace.

**Note:** *When you test with the high-resolution feature, you should use a longer averaging time to maintain a signal-to-noise ratio (SNR) that will be equivalent to the one you would have got with the standard resolution.*

**Note:** *You can use high resolution with any test mode (except when you monitor fiber in real time), but you must be in Advanced mode to select it.*



### IMPORTANT

To test using the high-resolution feature, the acquisition time must be of at least 15 seconds.

**To enable the high-resolution feature:**

1. From the button bar, press **OTDR Setup**.
2. Go to the **Acquisition** tab.
3. Select the **High-resolution acquisition** box.

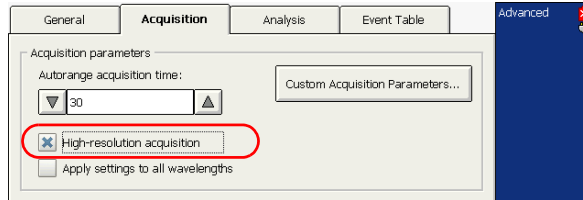

**Note:** *If your OTDR supports singlemode, singlemode live, or multimode wavelengths, the high-resolution feature will be activated either for the singlemode, singlemode live, or multimode wavelengths, depending on the selected fiber type.*

4. Press **Exit OTDR Setup** to return to the main window.

## Enabling or Disabling Analysis After Acquisition

The OTDR trace acquisition procedure will be completed by the analysis. You can either choose to automatically analyze each trace immediately after the acquisition, or perform the analysis whenever it suits you best.

When the analysis process is disabled, the Event table of a newly acquired trace will be empty.

You can also set a default fiber span, which will be applied during the analysis of all traces to display test results. For details, see *Setting a Default Span Start and Span End* on page 75.

**Note:** *In Auto mode, the application always performs an analysis after the acquisition.*



## Testing Fibers in Advanced Mode

### Enabling or Disabling Analysis After Acquisition

---

#### **To enable or disable the analysis after trace acquisition:**

1. From the button bar, press **OTDR Setup**.
2. Go to the **Analysis** tab.
3. If you want the OTDR to automatically analyze an acquired trace, select the **Automatically analyze data after acquisition** box.

If you clear the check box, the trace will be acquired without being analyzed.

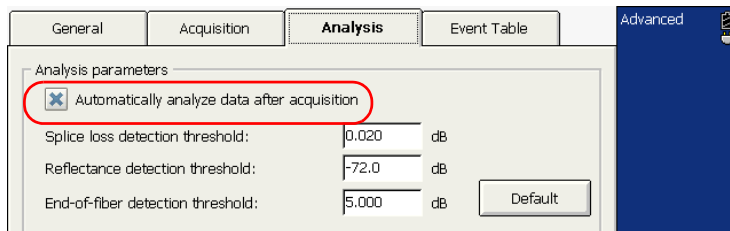

**Note:** *By default, traces are automatically analyzed as they are acquired.*

4. Press **Exit OTDR Setup** to return to the main window.

## Setting Pass/Fail Thresholds

You can activate and set Pass/Fail threshold parameters for your tests.

You can set thresholds for splice loss, connector loss, reflectance, fiber section attenuation, span loss, span length, and span ORL. You can apply the same pass/fail thresholds to all test wavelengths or apply them separately to each one.

You can set different pass/fail thresholds for each available test wavelength. These pass/fail thresholds will be applied to the analysis results of all newly acquired traces with the corresponding wavelength.

By default, the application provides threshold values for the following wavelengths: 1310 nm, 1383 nm, 1390 nm, 1410 nm, 1490 nm, 1550 nm, 1625 nm, and 1650 nm. However, if you work with files containing other wavelengths, the application will automatically add these custom wavelengths to the list of available wavelengths. You will then be able to define thresholds for these new wavelengths. You can revert all thresholds to their default values, except if they are associated with custom wavelengths.

The loss, reflectance and attenuation thresholds that you set are applied to all events where such values can be measured. Setting these thresholds allows you either to ignore events with known lower values, or to ensure that all events are detected—even the ones for which very small values are measured.

The following table provides the default, minimum and maximum thresholds.

<b>Test</b>	<b>Default</b>	<b>Minimum</b>	<b>Maximum</b>
Splice loss (dB)	1.000	0.015	5.000
Connector loss (dB)	1.000	0.015	5.000
Fiber section attenuation (dB/km)	0.400	0.000	5.000

Once the thresholds are set, the application will be able to perform Pass/Fail tests to determine the status of the various events (pass or fail).

The Pass/Fail test is performed on two occasions:

- when analyzing or reanalyzing a trace
- when you open a trace file

Values that are greater than the predefined thresholds are displayed in white on a red background in the events table.

The Pass/Fail threshold LED, located on the front of the unit, will also indicate the status (green for pass, red for fail).

You can also set the application to display pass/fail messages when the Pass/Fail test is performed.

## Testing Fibers in Advanced Mode

### Setting Pass/Fail Thresholds

#### To set pass/fail thresholds:

1. From the button bar, select **OTDR Setup**, then select the **Event Table** tab.
2. From the **Wavelength** list, select the wavelength for which you want to set thresholds.

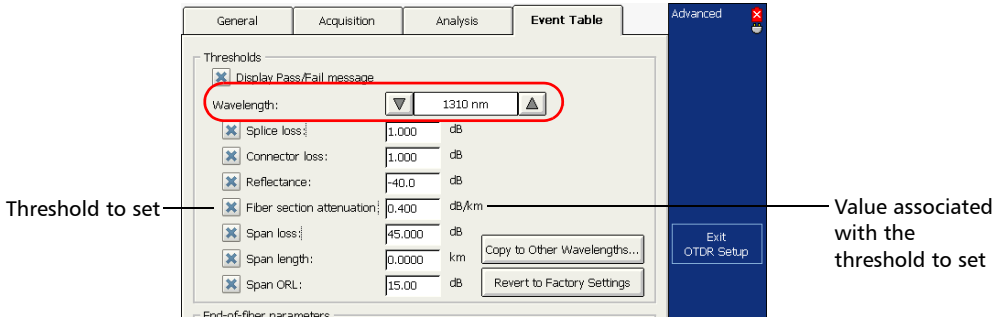

3. Select the boxes corresponding to the thresholds that you want to use, and enter the desired values in the appropriate fields.

**Note:** If you no longer want the application to take into account a particular threshold, simply clear the corresponding box.

4. If you want the application to display messages when events fail the test, select **Display Pass/Fail message**.

5. If you want to apply the thresholds you have just defined to one or several other wavelengths, proceed as follows:
  - 5a. Press the **Copy to Other Wavelengths** button.
  - 5b. Select the boxes corresponding to the wavelengths for which you want to use the same thresholds.

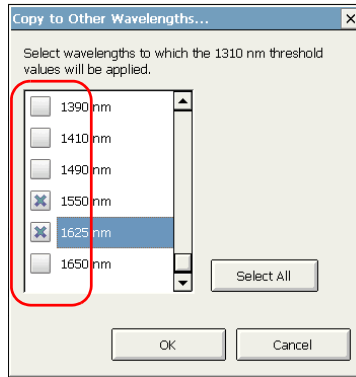

**Note:** You can use the **Select All** button to quickly select all boxes at the same time.

- 5c. Press **OK** to confirm your selection.
6. Press **Exit OTDR Setup** to return to the main window.

## Testing Fibers in Advanced Mode

### *Setting Pass/Fail Thresholds*

---

#### **To revert to default threshold values and to delete custom wavelengths:**

- 1.** From the button bar, select **OTDR Setup**, then select the **Event Table** tab.
- 2.** Press the **Revert to Factory Settings** button.
- 3.** When the application prompts you, confirm the modification with **Yes**.

All threshold values of all wavelengths are returned to their default values, except for thresholds that are associated with custom wavelengths.



### **IMPORTANT**

When you revert thresholds to their default values, custom wavelengths will be deleted from the list of available wavelengths, except if a file using at least one of these wavelengths is still open.

## Setting a Default Span Start and Span End

By default, the span start and span end of a fiber are assigned, respectively, to the first event (the launch level event) and the last event (often a non-reflective or reflective end event) of a trace.

You can change the default fiber span that will be applied during the initial trace analysis.

You can set the span start and span end on a particular event or at a certain distance value from the beginning or end of the trace. You can even define a fiber span for short fibers by placing the span start and the span end on the same event.

- By default, the number of available events is set to 10 and, therefore, does not necessarily reflect the actual number of events displayed.
- When you set a distance value for the span start or end, the application searches for a nearby event. If it finds one, the span start or end is assigned to that event, rather than at the exact distance you have set.

Changes to the span start and span end will modify the contents of the events table. The span start becomes event 1 and its distance reference becomes 0. Events excluded from the fiber span are grayed out in the events table, and do not appear in the trace display. The cumulative loss is calculated within the defined fiber span only.

**Note:** *You can also change the fiber span of a single trace after the analysis and reanalyze the trace (see Analyzing or Reanalyzing a Trace on page 155). However, if you want to keep working with the original parameters, you must reenter them.*

## Testing Fibers in Advanced Mode

### Setting a Default Span Start and Span End

---

#### **To change the default span start and span end for traces:**

1. From the button bar, press **OTDR Setup**.
2. From the **OTDR Setup** window, go to the **Analysis** tab.
3. If you want to set the span start and end with a distance value, under **Span start** and **Span end**, select **Set by distance**.  
Go to the **Position** box and enter the desired value, using the distance units displayed to the right of the box.

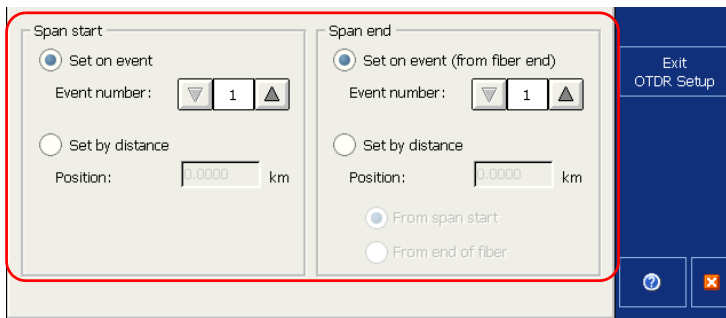

Under **Span end**, indicate whether the span end position is from the fiber span start or from the end of the fiber.

OR

If you want to set the span start and end on a particular event, under **Span start** and **Span end**, select **Set on event**.

From the **Event number** list, use the up or down arrow to select the number of the event that you want to designate as span start or span end.

The span event parameters are applied to all newly acquired traces.



# 7 **Testing Fibers in Fault Finder Mode**

The application offers you a special testing feature to rapidly locate fiber ends. It also displays the length of the fiber under test.

This could be useful if you want to perform a quick test without having to set all the acquisition parameters.

## **Acquiring Traces in Fault Finder Mode**

The unit will determine the more appropriate wavelength (singlemode or multimode, depending on your test configuration). It will use the default IOR (group index), RBS coefficient, and helix factor. The duration of acquisition is 45 seconds.

### **To acquire traces in Fault finder mode:**

1. Clean the connectors properly (see *Cleaning and Connecting Optical Fibers* on page 42).
2. Connect a fiber to the OTDR port.

If your unit is equipped with two OTDR ports, ensure that you connect the fiber to the appropriate port (singlemode, singlemode live, or multimode), depending on the wavelength you intend to use.



## **CAUTION**

Never connect a live fiber to the OTDR port without a proper setup. Any incoming optical power ranging from  $-65$  dBm to  $-40$  dBm will affect the OTDR acquisition. The way the acquisition will be affected depends on the selected pulse width.

Any incoming signal greater than 10 dBm could damage your MAX-700 permanently. For live-fiber testing, refer to the SM Live port specifications for the characteristics of the built-in filter.

## Testing Fibers in Fault Finder Mode

### Acquiring Traces in Fault Finder Mode

---

3. From the **Port** list, specify to which port you connected your fiber.

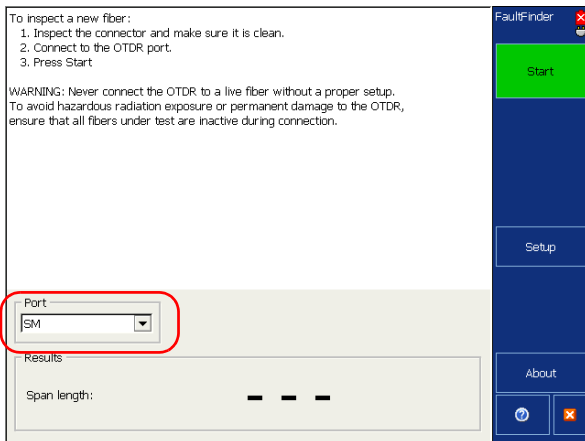

4. Press **Start**. If the first connector check feature is enabled, a message will appear if there is a problem with the injection level (see *Enabling or Disabling the First Connector Check for Fault Finder* on page 87).

5. Once the analysis is complete, save the trace by pressing **Quick Save** in the button bar.

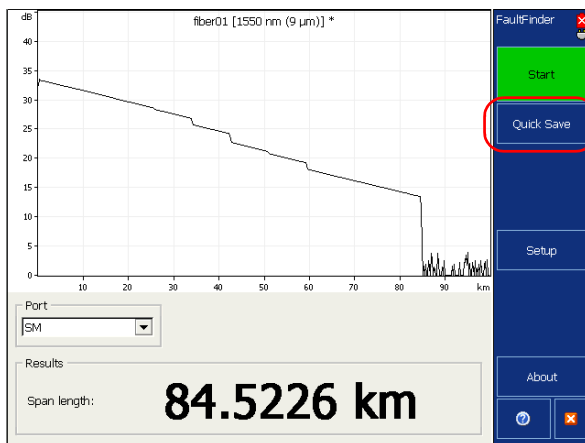

The application will use a file name based on the autonaming parameters you defined (see *Naming Fault Finder Files Automatically* on page 80). This file name appears at the top of the graph.

**Note:** The application will only display the **Save File** dialog box if you have activated the feature to always be prompted when you save a file and if you did not disable the storage features. From the **Save File** dialog box, you can change the location, the file name and the file format.

- 5a. If necessary, change the folder to which the file will be saved by pressing the **Location** button.
- 5b. If necessary, specify a file name.



## IMPORTANT

If you specify the name of an existing trace, the original file will be overwritten and only the new file will be available.

- 5c. Press **OK** to confirm.

## Testing Fibers in Fault Finder Mode

### *Naming Fault Finder Files Automatically*

---

## Naming Fault Finder Files Automatically

Each time you start an acquisition, the Fault Finder application suggests a file name based on autonaming settings. This file name appears on the upper part of the graph.

**Note:** *The autonaming settings used in Fault Finder mode are independent from those used in Auto or Advanced modes. File names are built following the same principle, but there is one set of settings for Fault Finder and one set of settings for the other OTDR modes.*

The file name is made of a static part (alphanumeric) and a variable part (numeric) that will be incremented or decremented, according to your selection, as follows:

If you choose incrementation...	If you choose decrementation...
Variable part increases until it reaches the <i>highest possible value</i> with the selected number of digits (for example, 99 for 2 digits), then restarts at 0.	Variable part decreases until it reaches 0, then restarts at the <i>highest possible value</i> with the selected number of digits (for example, 99 for 2 digits).

After saving a result, the unit prepares the next file name by incrementing (or decrementing) the suffix.

**Note:** *If you choose not to save a particular trace file, the suggested file name will remain available for the next trace you will acquire.*

By default, traces are saved in native (.trc) format, but you can configure your unit to save them in Bellcore (.sor) format (see *Selecting the Default File Format for the Fault Finder Traces* on page 82).

#### To configure the automatic file naming:

1. From the button bar, press **Setup**.
2. From the **Setup** window, select the **General** tab then press the **File Autonaming** button.

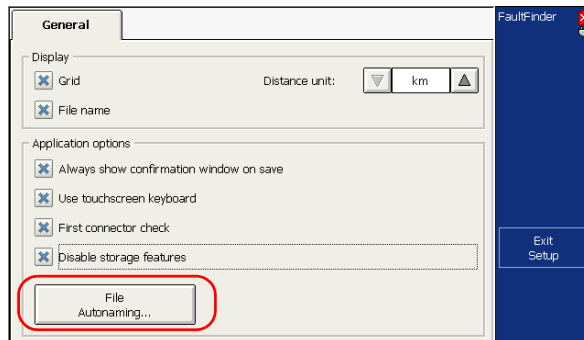

3. From the **Autonaming Setup** dialog box, set the parameters.

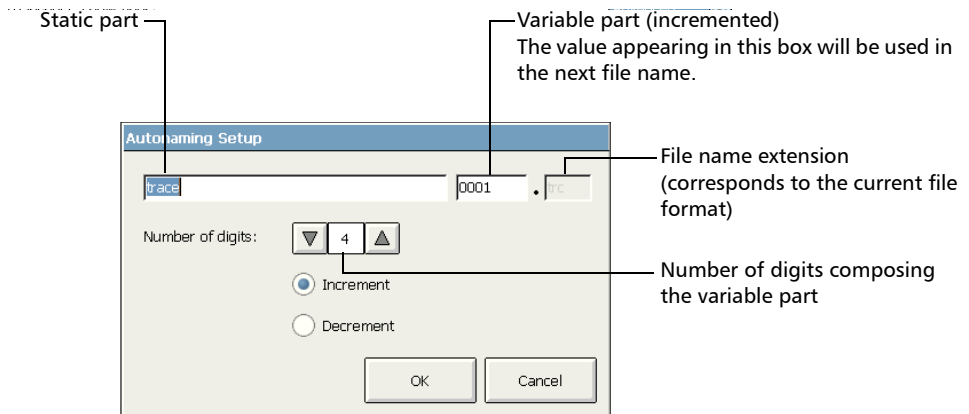

If you want the variable part to increase each time a file is saved, select **Increment**. If you want it to decrease, select **Decrement**.

4. Press **OK** to confirm your new settings.

## Selecting the Default File Format for the Fault Finder Traces

You can define the default file format the Fault Finder application will use when you save your traces.

**Note:** *The default file format used in Fault Finder mode are independent from the file format used in Auto or Advanced modes. There is one default file format for Fault Finder and one default file format for the other OTDR modes.*

By default, traces are saved in native (.trc) format, but you can configure your unit to save them in Bellcore (.sor) format.

You can only modify the file format from the **Save File** dialog box, which means you need to save at least one trace in the desired format before it becomes the new default file format.

**Note:** *The application will only display this dialog box if you have activated the feature to always be prompted when you save a file (see Enabling or Disabling the Confirmation of Fault Finder File Name on page 84) and if you did not disable the storage features.*

#### To select the default file format:

1. From the button bar, press **Quick Save**.
2. From the **Save File** dialog box, select the desired format.

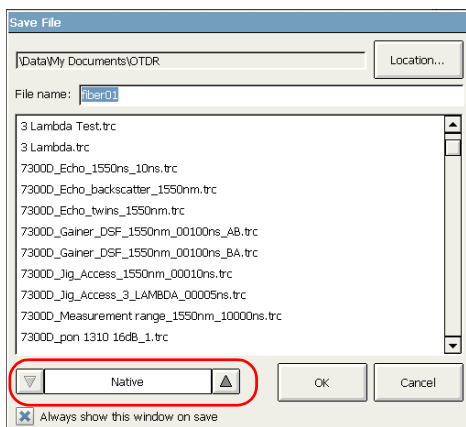

3. Press **OK** to save your file in the new format. The next files will be saved in the new format.

## Testing Fibers in Fault Finder Mode

*Enabling or Disabling the Confirmation of Fault Finder File Name*

---

# Enabling or Disabling the Confirmation of Fault Finder File Name

By default, each time you save a file, the application prompts you to confirm the file name.

**Note:** *The file name confirmation parameter used in Fault Finder mode is independent from the one used in the other OTDR modes (Auto and Advanced).*

The application will use a file name based on autonaming settings (see *Naming Fault Finder Files Automatically* on page 80).

If you prefer to hide the **Quick Save** button, see *Enabling or Disabling the Storage Feature* on page 86.



## Testing Fibers in Fault Finder Mode

### Enabling or Disabling the Confirmation of Fault Finder File Name

---

#### **To enable or disable file name confirmation:**

1. From the button bar, press **Setup**, then go to the **General** tab.
2. If you want to confirm file name each time you press **Quick Save**, select the **Always show confirmation window on save** check box.

OR

If you never want to be prompted, clear the check box.

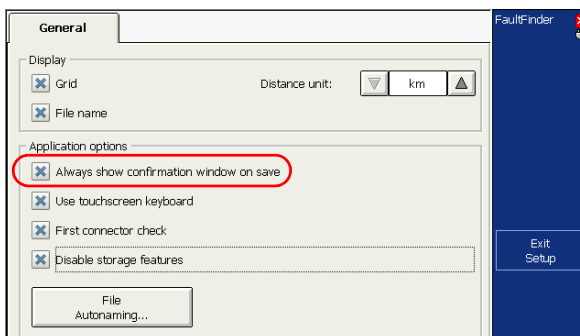

**Note:** You can also disable the confirmation of the file name by clearing the **Always show this window on save** check box directly from the **Save File** dialog box.

3. Press **Exit Setup** to return to the main window. The changes are applied automatically.

## Testing Fibers in Fault Finder Mode

### Enabling or Disabling the Storage Feature

---

## Enabling or Disabling the Storage Feature

By default, the **Quick Save** button is displayed in the button bar. However, if you only want to perform quick tests without having to save the results, you may prefer to hide the **Quick Save** button.

### **To enable or disable the storage feature:**

1. From the button bar, press **Setup**, then go to the **General** tab.
2. If you want to hide the **Quick Save** button, select the **Disable storage features** check box.

OR

If you want to display the button, clear the check box.

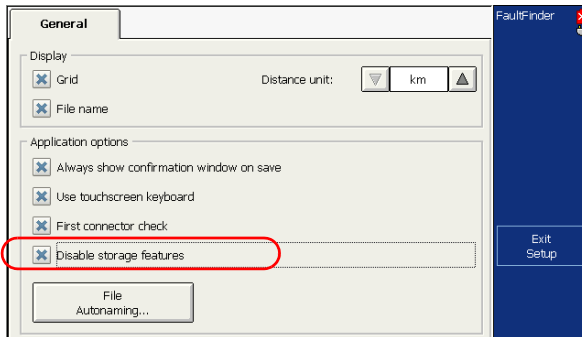

3. Press **Exit Setup** to return to the main window. The changes are applied automatically.

# Enabling or Disabling the First Connector Check for Fault Finder

The first connector check feature is used to verify that the fibers are properly connected to the OTDR. It verifies the injection level and displays a message when a unusually high loss occurs at the first connection, which could indicate that no fiber is connected to the OTDR port. By default, this feature is not enabled.

**Note:** *The first connector check is only performed when you test at singlemode wavelengths.*

**Note:** *The first connector check parameter used in Fault Finder mode is independent from the one used in the other OTDR modes (Auto and Advanced).*

## Testing Fibers in Fault Finder Mode

*Enabling or Disabling the First Connector Check for Fault Finder*

---

### **To enable or disable the first connector check:**

1. From the button bar, press **Setup** then select the **General** tab.
2. To enable the first connector check, select the **First connector check** check box.

OR

To disable it, clear the check box.

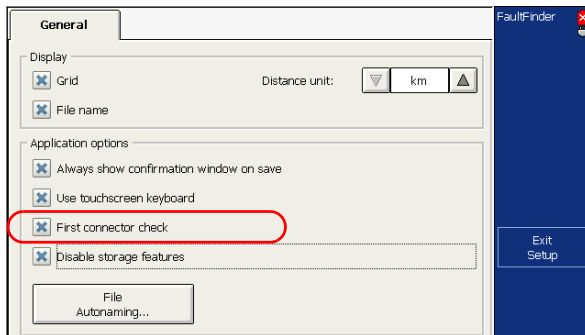

3. Press **Exit Setup** to return to the main window. The changes are applied automatically.

## Enabling or Disabling the Touchscreen Keyboard

With the touchscreen keyboard, you can enter data without having to use an external keyboard. By default, this feature is enabled.

When you select a text or number box, the touchscreen keyboard or keypad appears automatically. However, you can disable it if you prefer using an external keyboard.

**Note:** *Hiding or displaying the touchscreen keyboard in Fault Finder mode has no effect on the way the touchscreen keyboard will be used in the other OTDR modes (Auto and Advanced).*

### **To enable or disable the touchscreen keyboard:**

1. From the button bar, press **Setup**, then select the **General** tab.

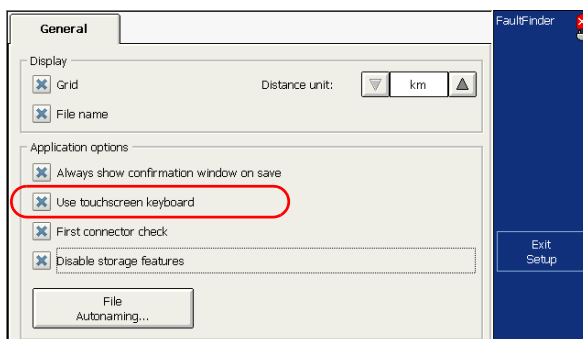

2. If you want to display the touchscreen keyboard, select the **Use touchscreen keyboard** check box.

OR

If you prefer to hide the keyboard, clear the check box.

3. Press **Exit Setup** to return to the main window. The changes are applied automatically.

## Testing Fibers in Fault Finder Mode

### Setting Trace Display Parameters

## Setting Trace Display Parameters

You can change several trace display parameters:

- the grid: You can display or hide the grid appearing on the graph's background. By default, the grid is displayed.
- the file name in the trace display: The file name appears at the top of the trace display. By default, the file name is displayed.

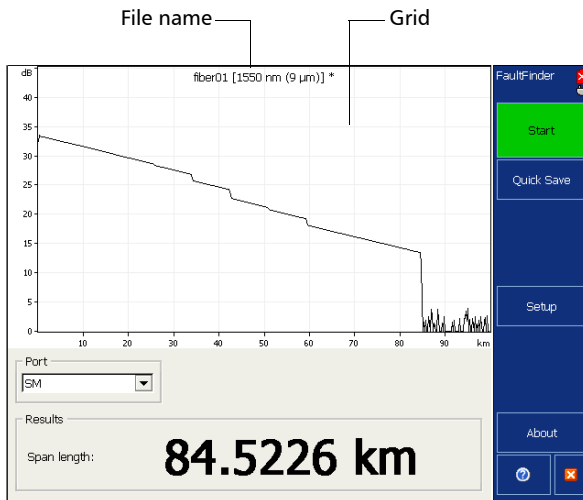

**Note:** The trace display settings used in Fault Finder mode are independent from the ones used in the other OTDR modes (Auto and Advanced).

#### **To set the trace display parameters:**

1. From the button bar, press the **Setup** button, then select the **General** tab.
2. Select the check boxes corresponding to the item you want to display on the graph.

OR

To hide them, clear the check boxes.

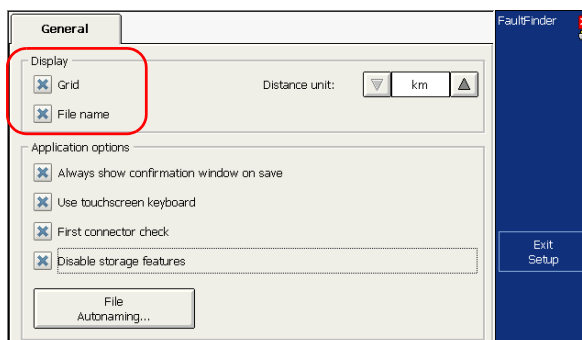

3. Press **Exit Setup** to return to the main window. The changes are applied automatically.

## Testing Fibers in Fault Finder Mode

### Selecting the Distance Units

---

## Selecting the Distance Units

You can select the distance units that will be used in the application.

The default distance units are the kilometers.

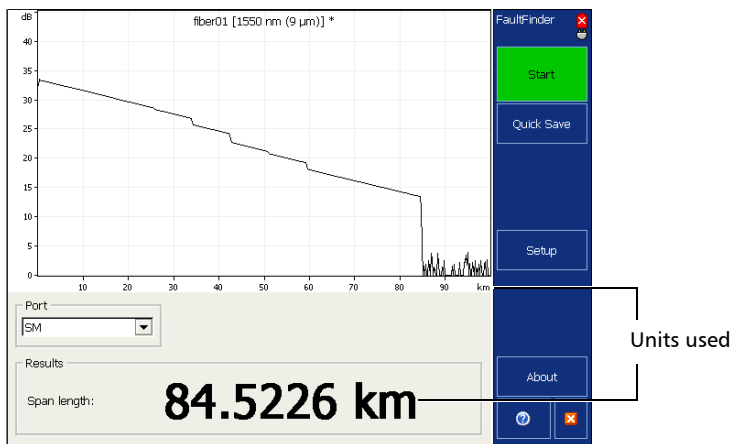

**Note:** *The distance units used in Fault Finder mode are independent from the ones used in the other OTDR modes (Auto and Advanced).*



**To select the distance units for your display:**

1. From the button bar, select **Setup**.
2. From the **Setup** window, select the **General** tab.
3. From the **Distance units** list, select the item corresponding to the desired units.

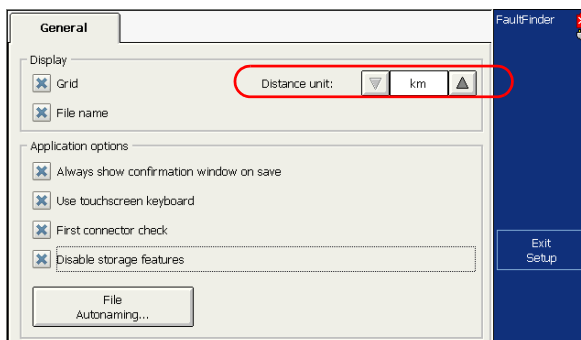

4. Press **Exit Setup**.

You return to the main window and the newly selected measurement unit appears everywhere these units are used.



# 8 Customizing the OTDR Application

You can customize the appearance and behavior of your OTDR application.

## Selecting the Default File Format

You can define the default file format the application will use when you save your traces.

By default, traces are saved in native (.trc) format, but you can configure your unit to save them in Bellcore (.sor) format.

If you select the Bellcore (.sor) format, the unit will create one file per wavelength (for example, TRACE001\_1310.sor and TRACE001\_1550.sor, if you included both 1310 nm and 1550 nm in your test). The native format contains all wavelengths in a single file.

You can only modify the file format from the **Save File** dialog box, which means you need to save at least one trace in the desired format before it becomes the new default file format.

**Note:** *The application will only display this dialog box if you have activated the feature to always be prompted when you save a file (see Enabling or Disabling File Name Confirmation on page 97).*

## Customizing the OTDR Application

### Selecting the Default File Format

---

#### To select the default file format:

1. From the **Main Menu** window, press **Quick Save**.
2. From the **Save File** dialog box, select the desired format.

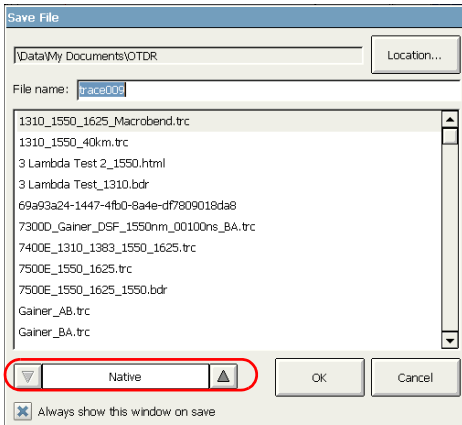

3. Press **OK** to save your file in the new format.

The next files will be saved in the new format.

## Enabling or Disabling File Name Confirmation

By default, each time you save a file, the application prompts you to confirm the file name.

The application will use a file name based on autonaming settings (see *Naming Trace Files Automatically* on page 44).

**Note:** *The file name confirmation parameter used in the Auto and Advanced modes is independent from the one used in the Fault Finder mode.*

## Customizing the OTDR Application

### Enabling or Disabling File Name Confirmation

#### **To enable or disable file name confirmation:**

1. From the **Main Menu** window, press **OTDR Setup**, then select the **General** tab.
2. If you want to confirm file name each time you press **Quick Save**, select the **Always show confirmation window on save** check box.

OR

If you never want to be prompted, clear the check box.

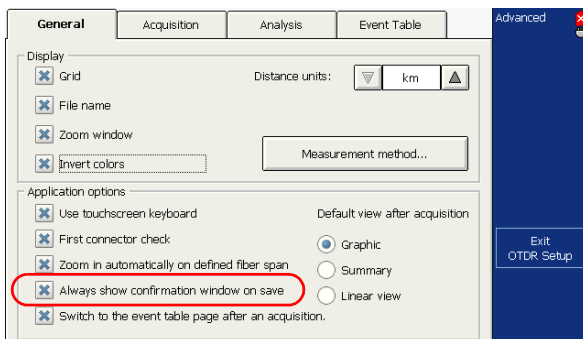

**Note:** You can also disable the confirmation of the file name by clearing the **Always show this window on save** check box from the **Save File** dialog box.

3. Press **Exit OTDR Setup** to return to the main window.

The changes are applied automatically.

### Selecting the Distance Units

You can select the measurement units that will be used throughout the application, except for certain values such as the pulse and the wavelength. Pulse values are expressed in seconds and wavelength in meters (nanometers).

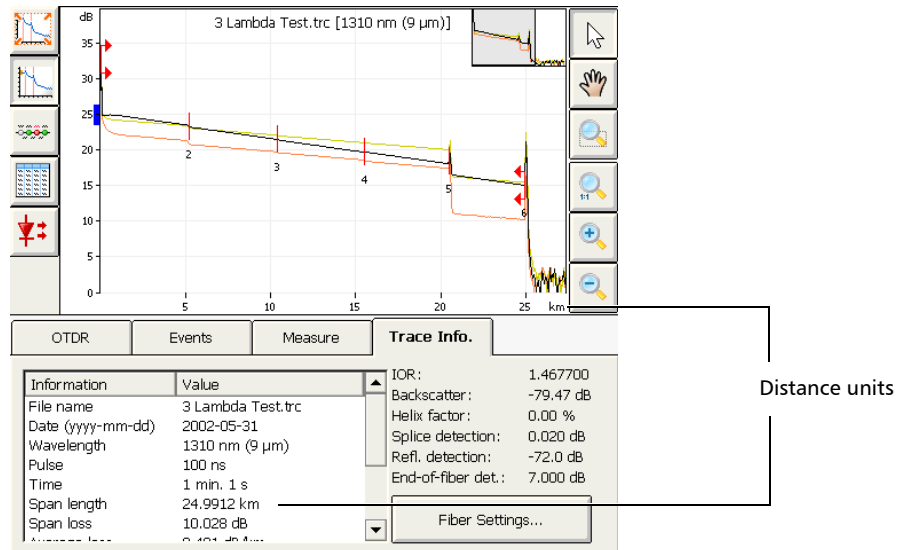

The default distance units are the kilometers.

**Note:** If you select **Kilometers (km)** or **Kilofeet (kft)**, **m** and **ft** may appear instead to display more precise measurements.

**Note:** The distance units used in Auto and Advanced modes are independent from the ones used in the Fault Finder mode.

**Note:** The attenuation of fiber sections is always presented in dBs per kilometer even if the distance units you selected are not the kilometers. This follows the standards of the fiber-optic industry that provides the attenuation values in dBs per kilometer.

## Customizing the OTDR Application

### Selecting the Distance Units

**To select the distance units for your display:**

1. From the button bar, press **OTDR Setup**.
2. From the **OTDR Setup** window, select the **General** tab.
3. From the **Distance units** list, select the item corresponding to the desired distance units.

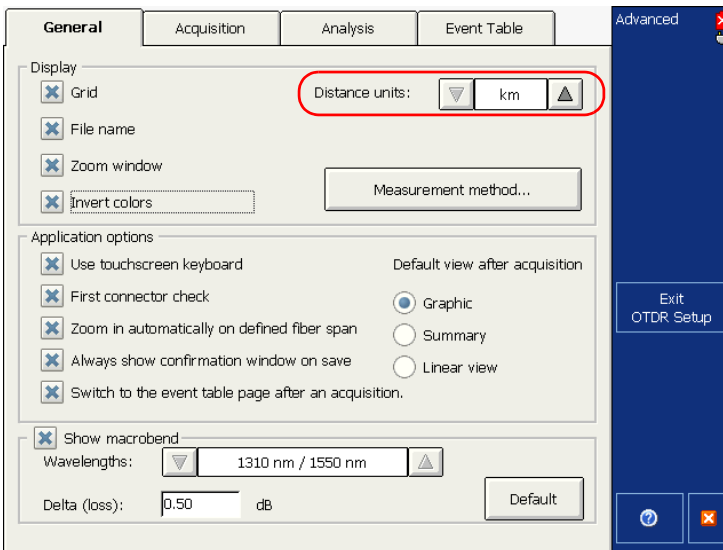

4. Press **Exit OTDR Setup**.

You return to the main window and the newly selected distance unit appears everywhere units are used.



## Customizing the Acquisition Distance Range Values

**Note:** *This function is available in Advanced mode only.*

You can customize the values associated with the **Distance** dial. Once the customization is complete, you are ready to set the distance range value for your test. For more information, see *Setting Distance Range, Pulse Width, and Acquisition Time* on page 63.

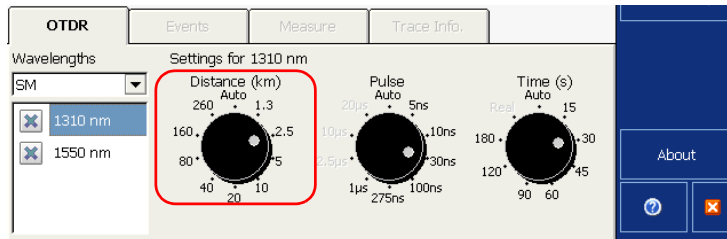

**Note:** *The Auto value cannot be modified.*

## Customizing the OTDR Application

### Customizing the Acquisition Distance Range Values

#### To customize the distance range values:

1. From the button bar, select **OTDR Setup**, then the **Acquisition** tab.
2. Press the **Custom Acquisition Parameters** button.

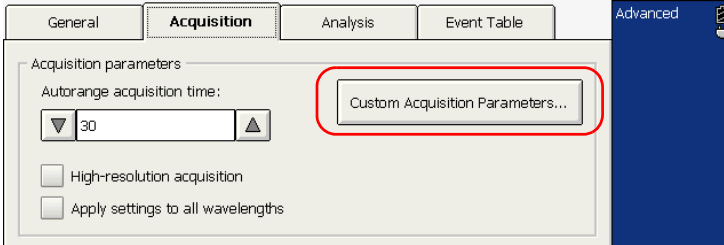

3. If your OTDR supports singlemode or filtered wavelengths, specify the desired fiber type.

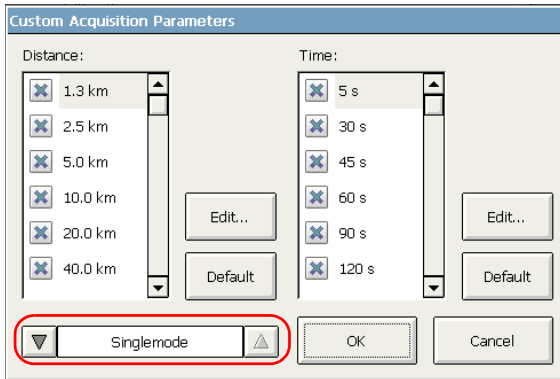

4. From the **Distance** list, select the value you want to modify (the value will become highlighted), then press the **Edit** button.

**Note:** You can revert to factory values by pressing the **Default** button.

5. In the displayed dialog box, enter the new value and confirm with **OK**.

# Customizing the Acquisition Time Values

**Note:** This function is available in Advanced mode only.

You can customize the values associated with the **Time** dial. The acquisition time values represent the time during which the OTDR will average acquisitions.

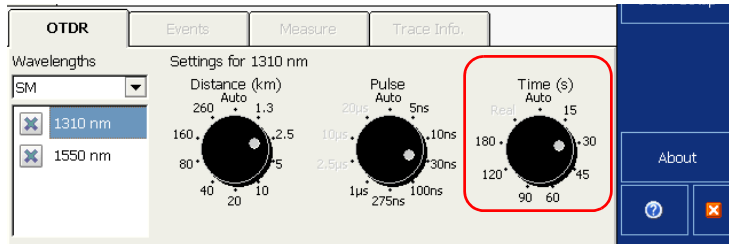

**Note:** The *Auto* and *Real* values cannot be modified.

You can customize the acquisition time to improve the signal-to-noise ratio (SNR) of the trace and enhance the detection of low-level events. The SNR improves by a factor of two (or 3 dB) each time the acquisition time is increased by a factor of four.

## Customizing the OTDR Application

### Customizing the Acquisition Time Values

#### To customize the acquisition time values:

1. From the button bar, select **OTDR Setup**, then the **Acquisition** tab.
2. Press the **Custom Acquisition Parameters** button.

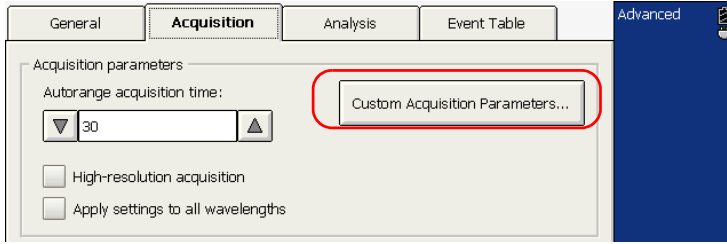

3. From the **Time** list, select the value you want to modify (the value will become highlighted), then press the **Edit** button.

**Note:** You can revert to factory values by pressing the **Default** button.

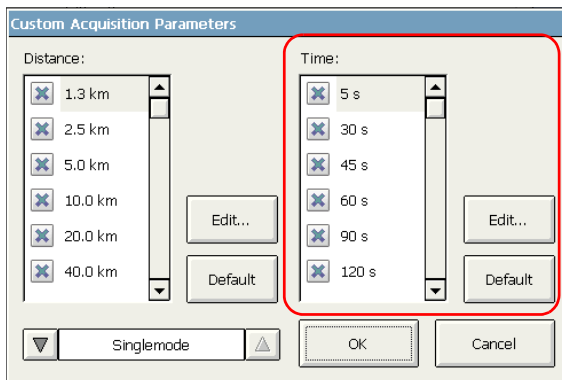

4. In the displayed dialog box, enter the new value and confirm with **OK**.

## Enabling or Disabling the Touchscreen Keyboard

With the touchscreen keyboard, you can enter data without having to use an external keyboard. By default, this feature is enabled.

When you select a text or number box, the touchscreen keyboard or keypad appears automatically. However, you can disable it if you prefer using an external keyboard.

**Note:** *Hiding or displaying the touchscreen keyboard in Auto and Advanced modes has no effect on the way the touchscreen keyboard will be used in the Fault Finder mode.*

### **To enable or disable the touchscreen keyboard:**

1. From the **Main Menu**, select **OTDR Setup**, then select the **General** tab.
2. If you want to display the touchscreen keyboard, select the **Use touchscreen keyboard** box.

OR

If you prefer to hide the keyboard, clear the check box.

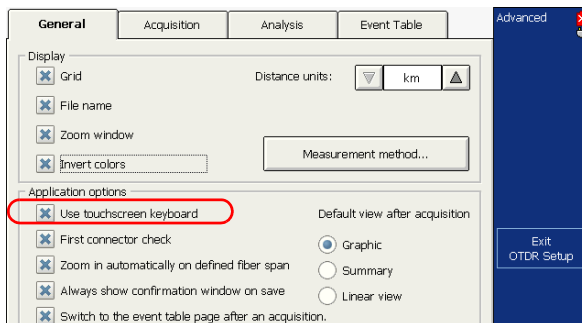

3. Press **Exit OTDR Setup** to return to the **Main Menu** window. The changes are applied automatically.

### Displaying or Hiding the Optional Features

If you have *not* purchased the optional software package, since you cannot use the optional features, you may prefer to hide them (macro bend detection, linear view).

**Note:** *You cannot hide the optional features if you purchased the software package.*

#### To display or hide the optional features:

1. From the button bar, press **OTDR Setup**.
2. In the **General** tab, under **Display**, clear the **Show all optional software features** check box to hide the options

OR

Select the check box to display them.

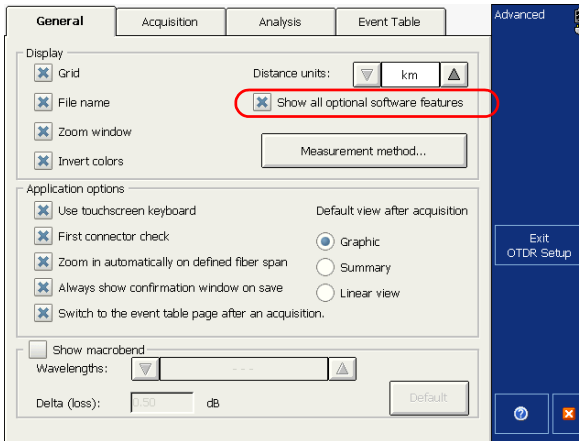

3. From the button bar, press **Exit OTDR Setup** to return to the main window.

The changes are applied automatically.

## 9 **Analyzing Traces and Events**

Once the acquired trace is analyzed, it appears in the trace display and the events are displayed in the events table at the bottom of the screen. The trace display and events table are explained in the following sections. You can also reanalyze existing traces. For information on the various file formats you can open with the application, see *Opening Trace Files* on page 162.

There are many ways to view the results:

- Graph view
- Linear view (optional)
- Summary table

From the trace display and linear views, you can also access the following tabs to have more information:

- Events
- Trace info

In addition, you can generate trace reports directly from your unit. For more information, see *Generating a Report* on page 187.

# Analyzing Traces and Events

## Graph View

### Graph View

The events, that are detailed in the events table (see *Events Tab* on page 114), are marked by numbers along the displayed trace.

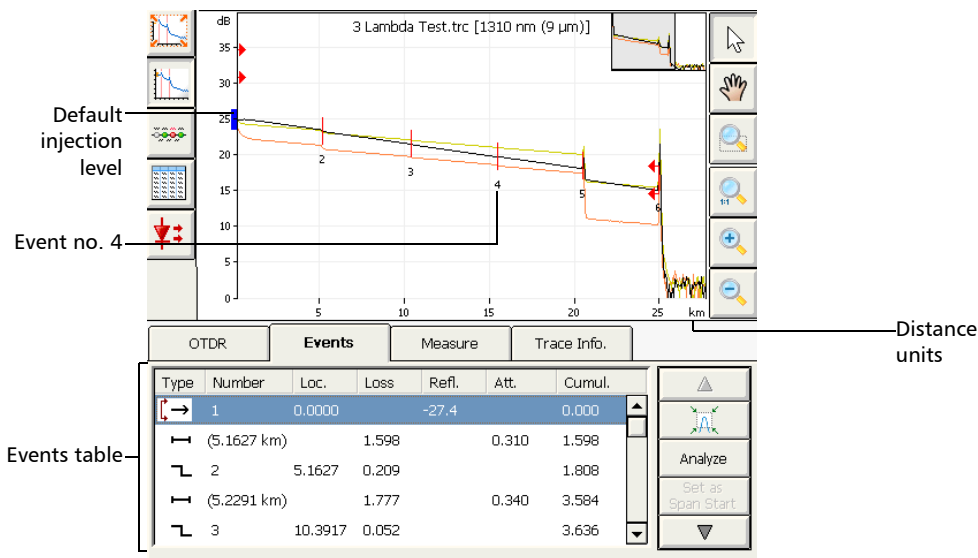

Some items in the trace display are always visible, while others will appear only if you choose to display them. The contents of the graph area changes according to the selected tab.

The blue rectangle on the Y axis (relative powers) indicates the proper injection level range for the defined test pulse.



You can change trace display parameters (such as the grid and zoom window display). For more information, see *Setting Trace Display Parameters* on page 128.

You can view all of the traces, in turn, in both the **Trace Info** pane and the trace display with the navigation buttons. For more information, see *Displaying or Hiding a Trace* on page 132.

Each wavelength is displayed in a different color. The colors are assigned dynamically. Wavelengths of the reference traces are also displayed using the colors corresponding to those of the main trace, but with a darker shade.

# Analyzing Traces and Events

## Linear View

### Linear View

**Note:** This function is available with the optional Auto Diagnostic (AD) software package only.

In the linear view, the events are displayed sequentially, from left to right.

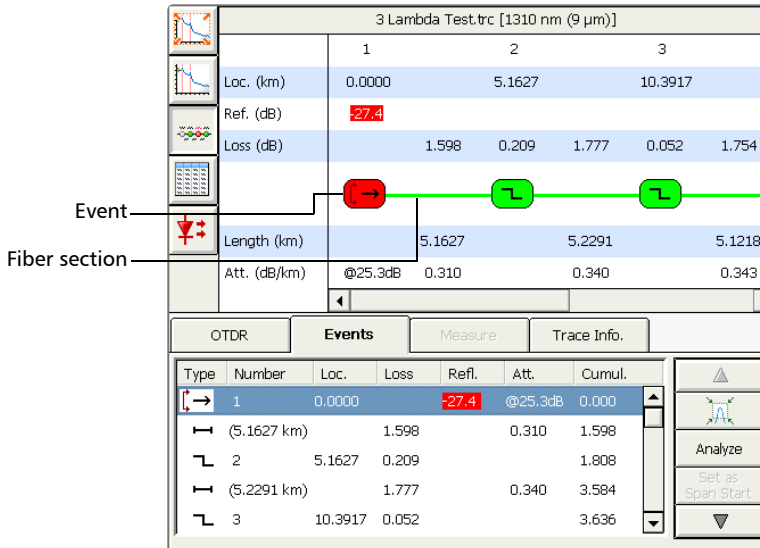

- Each bubble represents an event. Each horizontal line that “links” two bubbles represents a fiber section. Bubbles and lines will be displayed in colors (green for pass, red for fail, grey or black for events and fiber sections appearing outside the current fiber span). Otherwise, all events will be displayed in grey and fiber sections in black.
- When you select an event or a fiber section in the events table, the linear view automatically scrolls to display the element.
- You can also select a bubble or an horizontal line and the corresponding item will be selected in the events table.

- You can view, in turn, the reference trace and the main trace using the **Next Trace** button.
- If you press a bubble or an horizontal line and hold for a few seconds, the application will display a tooltip identifying the item (for example, Reflective fault). The tooltip displays any comment that you have inserted manually. If the bubble corresponds to a merged event, you will also see details about the “sub-events”, including the event types.
- The **Measure** tab is not available when the linear view is displayed.
- If the **Zoom in automatically on defined fiber span** item is selected (**OTDR Setup > General** tab), the first element that will be visible in the linear view is the span start. However, it is possible to manually scroll to view events that would be located before the span start.
- The linear view cannot be displayed when the events table is empty. Traces must have been analyzed before you can see them in the linear view.
- If you configured the application to show the macrobends (**OTDR Setup > General** tab), when you display the trace corresponding to the greatest wavelength of the selected wavelength combination, you can view a line containing information about macrobends. For example, if the wavelength combination is 1310 nm/1550 nm, macrobend information will appear for the 1550 nm trace.

When macrobends are detected, icons will be displayed to identify them. Colors of the bubbles correspond to the status of the events (green for pass, red for fail) and do not change if macrobends are detected.

### **To display the linear view:**

From the main window, press the  button.

**Note:** *To display the linear view as the default view after the acquisitions are all performed (at all the selected wavelengths) and the analysis of the last wavelength is complete, see [Selecting the Default View](#) on page 121.*

## Summary Table

**Note:** This function is available both in Advanced and Auto modes.

The summary table gives, for each wavelength, the global status of the results (pass: no results exceed the thresholds or fail: at least one result exceeds the thresholds), the span loss and span ORL values. The span length (distance between span start and span end) is also displayed, except if a continuous fiber is detected for all wavelengths. In this case, “Continuous fiber” will be displayed instead.

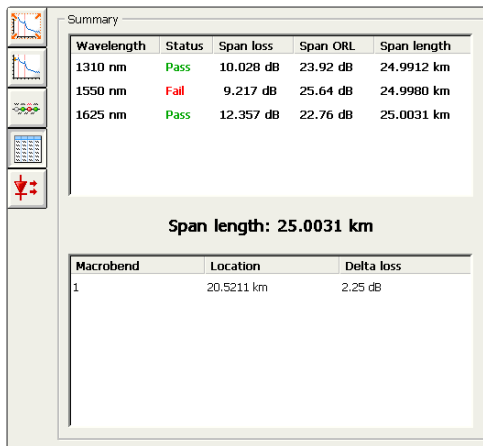

- When you select an element in the summary table (element is highlighted), if you double-tap, the application automatically switches to the graph view. The graph is displayed with “full trace” zoom, except if the status of the selected wavelength is “fail”. In this case, the application zooms in on the first event or fiber section for which the status is “fail”. In the graph view, the events tab is automatically selected, allowing you to switch to another event manually.
- The summary table shows only the information of the main trace, not the information of the reference trace.

- Since the summary table shows the information for all the wavelengths of the main trace only, the **Next Trace** button is not available.
- The summary table cannot be displayed when the events table is empty or if the trace contains only a span start. Traces must have been analyzed before you can see them in the summary table.
- If you close a trace file when the summary table is displayed, the application will switch to the graph view until you open a new trace file that can be displayed.
- If you purchased the macrobend finder option (available in the Auto Diagnostic software option) and configured the application to show the macrobends (**OTDR Setup > General** tab), the information will appear at the bottom of the summary table.
- If no macrobends were detected, the application displays “No macrobend has been detected” instead of the information on the macrobends.
- If the traces that have been analyzed do not match the pair of wavelengths selected in the OTDR setup for the detection of macrobends (for example, you perform an acquisition at 1310 nm and 1625 nm, and the wavelengths selected for the detection of macrobends are 1310 nm/1550 nm), the application displays “Macrobend parameter is not valid”.
- When you select an element in the macrobend table (element is highlighted), if you double-tap, the application automatically switches to the graph view. The application zooms in on the first event that caused the selected macrobend. In the graph view, the events tab is automatically selected, allowing you to switch to another event manually.

## Analyzing Traces and Events

### Events Tab

---

#### **To display the summary table:**

From the main window, press the  button.

**Note:** *To display the summary table as the default view after the acquisitions are all performed (at all the selected wavelengths) and the analysis of the last wavelength is complete, see [Selecting the Default View](#) on page 121.*

## Events Tab

This tab is available when the graph view and the linear view (optional) are displayed. You can view information about all detected events on a trace and fiber sections by scrolling through the events table. In graph view, when you select an event in the events table, marker **A** appears on the trace over the selected event. When the selected event is a fiber section, this fiber section is delimited by two markers (**A** and **B**). For more information on markers, see *Using Markers* on page 169.

These markers pinpoint an event or a fiber section, depending on what is selected in the events table. You can move markers directly by selecting an element in the events table or on the graph.

The events table lists all the events detected on the fiber. An event can be defined as the point at which change in the transmission properties of light can be measured. Events can consist of losses due to transmission, splices, connectors or breaks. If the event is not within the established thresholds, its status will be set to “fail”.

Events							Measure	Trace Info.	Generate Report
Type	Number	Loc.	Loss	Refl.	Att.	Cumul.			
→	1	0.0000		-36.9		0.000			
		(25.3002 km)	8.395		0.332	8.395			
↳	2	25.3002	0.218		0.332	8.613			
		(8.4896 km)	2.814			11.427			
↳	3	33.7997	0.138			11.565			
		(8.5125 km)	2.858		0.336	14.423			

Launch Level  
Comments  
 Enter your comment here  
Edit Comments...

Tooltip identifying the selected item

A red triangle appears next to the event number to indicate that a comment has been inserted manually for a specific event.

If you press and hold the row corresponding to a specific event or fiber section for a few seconds, the application will display a tooltip identifying the item (for example, Non-reflective fault). In the case of a merged event, you will also see details about the “sub-events”.

The tooltip displays any comment that you have inserted manually.

If an asterisk appears next to the event symbol, the tooltip will also show “(\*:Modified)” to indicate that this event has been modified manually.

If the asterisk appears next to the event number, “(\*:Added)” will appear to indicate that this event has been inserted manually.

## Analyzing Traces and Events

### Events Tab

---

For each item listed in the events table, information is displayed:

- **Type:** Various symbols are used to describe different event types. For a more detailed description of symbols, see *Description of Event Types* on page 341.
- **Number:** Event number (a sequential number assigned by the OTDR test application) or, in parentheses, the length of a fiber section (the distance between two events).
- **Loc.:** Location; that is, distance between the OTDR and the measured event or between the event and the beginning of the fiber span.
- **Loss:** Loss in dB for each event or fiber section (calculated by the application).
- **Refl.:** Reflectance measured at each reflective event along the fiber.
- **Att.:** Attenuation (loss/distance) measured for each fiber section.

**Note:** *The attenuation value is always presented in dB per kilometers even if the distance units you selected are not the kilometers. This follows the standards of the fiber-optic industry that provides the attenuation values in dB per kilometers.*

- **Cumul.:** Cumulative loss from the trace span start to span end; the running total is provided at the end of each event and fiber section.

Cumulative loss is calculated for the events displayed in the events table, excluding those that are hidden. For a more accurate link loss value, refer to the loss measurement displayed in the **Trace Info.** tab.

If you want to modify events or fiber sections, see *Modifying Events* on page 140, *Inserting Events* on page 144, and *Changing the Attenuation of Fiber Sections* on page 150.



**To quickly locate an event in the events table:**

1. Ensure that the  button is selected in the zoom button bar.
2. Select the event on the trace.

The list scrolls automatically to the event you selected.

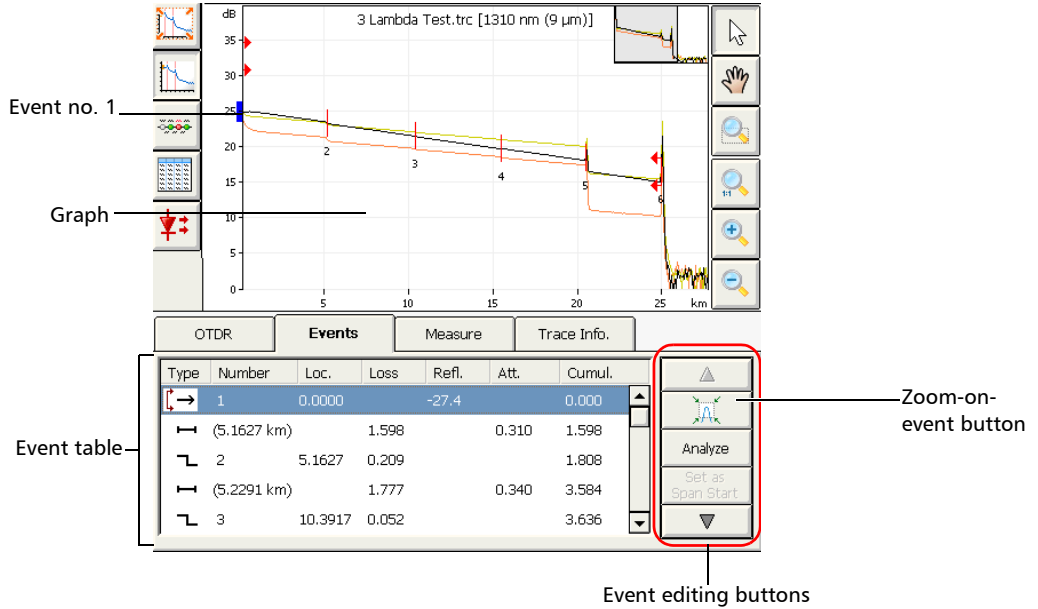

The screenshot shows the OTDR software interface. At the top, a graph displays a trace with several events marked by vertical lines and labeled 1 through 6. The y-axis is labeled 'dB' and ranges from 0 to 35. The x-axis is labeled 'km' and ranges from 0 to 25. A zoomed-in view of the trace is shown in the top right corner. Below the graph is a tabbed interface with 'Events' selected. The 'Events' table is shown below, with the following data:

Type	Number	Loc.	Loss	Refl.	Att.	Cumul.
↔	1	0.0000		-27.4		0.000
↔	2	(5.1627 km)	1.598		0.310	1.598
↔	3	(5.2291 km)	1.777		0.340	3.584
↔	4	10.3917	0.052			3.636

Labels in the image point to various UI elements: 'Event no. 1' points to the first event on the trace; 'Graph' points to the main trace area; 'Event table' points to the table below; 'Zoom-on-event button' points to a button with a magnifying glass icon in the right-hand toolbar; and 'Event editing buttons' points to a set of buttons (Analyze, Set as Span Start) in the bottom right corner of the events table area.

## Measure Tab

The application shows two, three or four markers: **a**, **A**, **B**, and **b**, depending on the button you pressed under **Results**.

These markers can be repositioned along the trace to calculate loss, attenuation, reflectance, and optical return loss (ORL).

You can reposition all markers by using the controls in the **Markers** section. You can drag them directly from the trace display. Selecting marker **A** or **B** will move the **a-A** or **B-b** pair.

For more information on how to perform manual measurements, see *Analyzing the Results Manually* on page 167.

## Trace Info. Tab

The information about all the trace files (including the reference) can be displayed.

You can view all of the traces, in turn, in both the **Trace Info** pane and the trace display with the navigation buttons. For more information, see *Displaying or Hiding a Trace* on page 132.

## Displaying the Graph in Full Screen

You can display the graph in full screen at any time, even when an acquisition is underway. The graph will keep the same display options as in normal view (grid, file name, zoom window, inverted colors).

You can start acquisitions directly without having to go back to normal view first. You can switch from one wavelength to another.

The information that is displayed at the bottom of the graph depends on the tab that was selected when you switched to full-screen mode. The table below gives an overview of the information that is available in each case.

Tab that was selected	Displayed information in full-screen mode
OTDR	Acquisition parameters (wavelengths appearing on the list correspond to those that are selected in the tab).
Events	A table of events that can be viewed one event at a time.
Measure	Marker information and either the four-point event loss, attenuation, reflectance, or ORL measurement, depending on the type of measurement that is selected in the tab.
Trace Info.	No further information is displayed. Only the graph is available.

As soon as a trace is displayed (new acquisition or existing file), zoom controls are available (see *Using Zoom Controls* on page 125).

**Note:** *If you want to use the zoom-on-event feature, you must select the*



*button from the **Events** tab before switching to full-screen mode.*

## Analyzing Traces and Events

### Displaying the Graph in Full Screen

If you want to view a table of events once the acquisitions are complete, you must select the **Events** tab or activate the option to display the event table (from **OTDR Setup**) before switching to full-screen mode.

Once all acquisitions are complete, the application will automatically switch to the defined default view (see *Selecting the Default View* on page 121). If you prefer that the graph remains in full screen after the acquisitions are complete, ensure that the default view is set to **Graph in OTDR Setup**.

#### To display the graph in full screen:

From the main window, press the  button.

The graph is now displayed in full-screen mode.

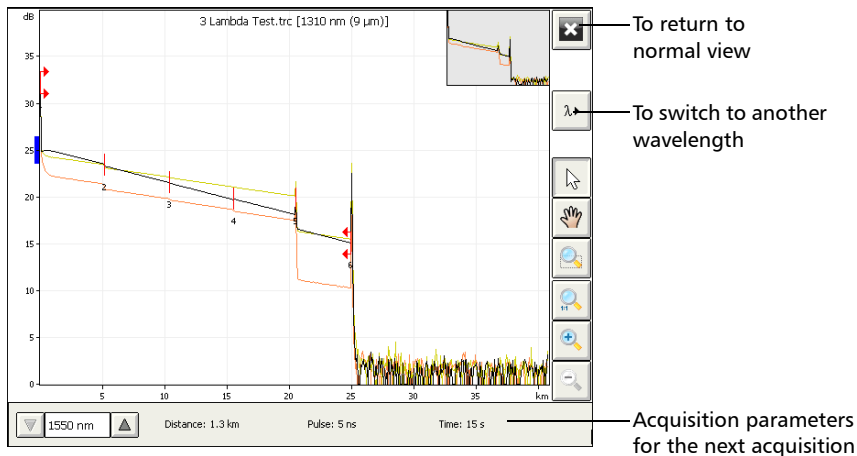

## Selecting the Default View

You can select which view will be displayed by default once all the acquisitions are performed (at all the selected wavelengths) and the analysis of the last wavelength is complete.

The table below indicates in which OTDR modes (Auto and Advanced) a particular view can be displayed.

View	OTDR modes for which view is available	Remarks
Graph	<ul style="list-style-type: none"> <li>➤ Auto</li> <li>➤ Advanced</li> </ul>	<p>Default view.</p> <p>For more information, see <i>Graph View</i> on page 108</p>
Linear	<ul style="list-style-type: none"> <li>➤ Auto</li> <li>➤ Advanced</li> </ul>	<p>Available with the optional Auto Diagnostic (AD) software package only.</p> <p>In this view, events are displayed sequentially, from left to right.</p> <p>Macrobends are identified with symbols on the trace corresponding to the greatest wavelength of the pair of wavelengths.</p> <p>For more information, see <i>Linear View</i> on page 110.</p>

## Analyzing Traces and Events

### Selecting the Default View

---

View	OTDR modes for which view is available	Remarks
Summary table	<ul style="list-style-type: none"><li>➤ Auto</li><li>➤ Advanced</li></ul>	<p>This table gives, for each wavelength, the pass/fail status of the results, the span loss and span ORL values. Span length is also displayed.</p> <p>If you purchased the Auto Diagnostic (AD) software option, information on macrobends will be displayed.</p> <p>For more information, see <i>Summary Table</i> on page 112.</p>

**Note:** In *Fault Finder mode*, only the graph is available.

#### **To select the default view:**

- 1.** From the button bar, select **OTDR Setup**, then the **General** tab.
- 2.** Under **Default view after acquisition**, select the desired view.
- 3.** Press **Exit OTDR Setup** to return to main window.

The application will automatically switch to the selected view when you perform the next acquisitions.

# Automatically Displaying the Event Table after Acquisitions

You may want the application to automatically switch to the event table once all acquisitions are complete. This could be particularly useful when you work in full-screen mode (see *Displaying the Graph in Full Screen* on page 119) if you want to view the event table without having to go back in normal view mode.

### **To display the event table after acquisitions:**

1. From the button bar, select **OTDR Setup**, then the **General** tab.
2. Under **Application options**, select **Switch to the event table page after an acquisition**.

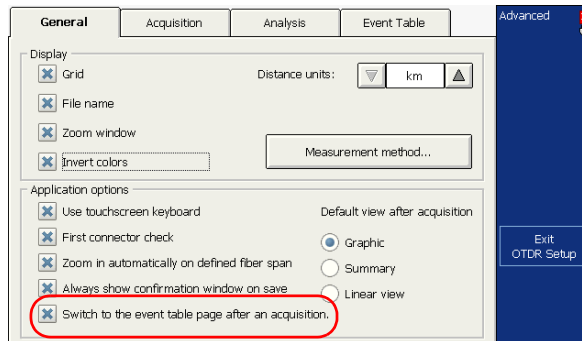

3. Press **Exit OTDR Setup** to return to main window.

The application will automatically display the events table at the end of the next acquisitions.

# Automatically Zooming in on the Fiber Span

**Note:** *This function is available in Advanced mode only.*

You can set the trace display to show only the span start to the span end of the trace in full-trace view. By default, this feature is not selected.

**To automatically zoom in on the fiber span:**

1. From the button bar, select **OTDR Setup**.
2. From the **OTDR Setup** window, select the **General** tab.
3. Under **Application options**, select **Zoom in automatically on defined fiber span** to automatically zoom on the fiber span in the trace display when a trace is opened or selected, or after trace analysis.

OR

Clear the box to leave the zoom level as is.

**Note:** *Zoom in automatically on defined fiber span is active only when in full-trace view, not when you have zoomed in on a trace.*

Even if the application automatically zooms in on the fiber span, you can adjust the zoom manually. You can even zoom in on events located outside the fiber span. For more information on how to use the zoom controls see *Using Zoom Controls* on page 125.



### Using Zoom Controls

Use the zoom controls to change the scale of the trace display.

You can zoom in on or out of the graph using the corresponding buttons or let the application automatically adjust the zoom on the currently selected event from the events table (only available when the events window is displayed).

You can quickly zoom in on or out of the selected event.

You can also return to the original graph value.

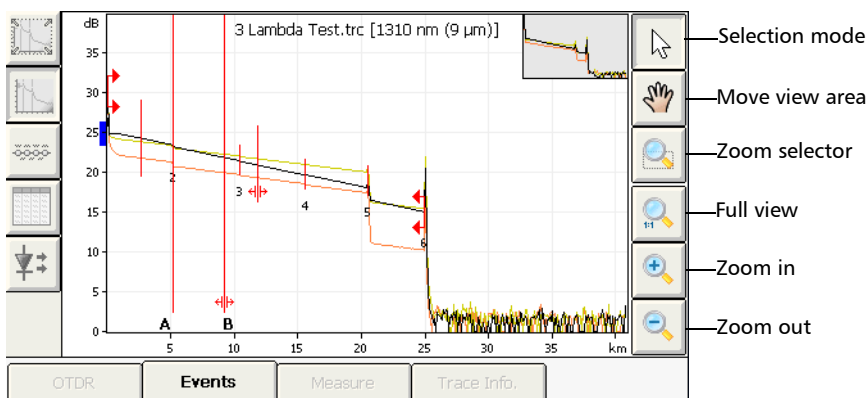

**Note:** You cannot move the markers with the  button.

## Analyzing Traces and Events

### Using Zoom Controls

---

- When you manually zoom in or out on a trace, the application will apply the new zoom factor and marker positions to the other traces (wavelengths) of a same file and on the reference file, if applicable. Both the zoom factor and marker positions will be saved along with the trace (same settings for all wavelengths).
- When you zoom in or out on the selected event, the application keeps the zoom on this event until you select another event or change zoom or marker positions (via the **Measure** tab). You can select a different event for each wavelength (for example, event 2 at 1310 nm and event 5 at 1550 nm). The selected events will be saved along with the trace.

If you want the application to automatically zoom on the defined fiber span, see *Automatically Zooming in on the Fiber Span* on page 124.



#### **To view specific portions of the graph:**

- You can define which portion of the graph will be visible by selecting the  button and dragging the graph with the stylus or your finger.

This could be useful, for example, if you want to zoom in on events located outside the defined fiber span.

- The  button is the zoom selector. It allows you to select whether the zooming will be performed according to the horizontal axis, the vertical axis, or both.

Press and hold this button to select the zooming direction in the menu. Then, define the zoom area with the stylus or your finger (a rectangle with dotted lines will appear to help you define the area). Once you release the stylus, the application automatically zooms in on the graph according to the zooming type you have selected. All of the other zoom buttons (except for the zoom on selected event button) will reflect your selection and behave accordingly.

- You can zoom in or out on the graph by first using, respectively, the  or the  button, and then by pressing the location where you want to zoom on the graph with the stylus or your finger. The application automatically adjusts the zoom by a factor 2 around the point that was pressed.

**To revert to the complete graph view:**

Press the  button.

**Note:** *If the Zoom in automatically on defined fiber span feature is selected in the OTDR setup, the application will zoom in between span start and span end.*

**To automatically zoom in on the selected event:**

1. Go to the **Events** tab.
2. From the events table, select the desired event.
3. Press the  button to zoom in. Press the button again to zoom out.

## Analyzing Traces and Events

### Setting Trace Display Parameters

Once you have started the desired trace acquisition mode (Automatic or Advanced), you can change several trace display parameters:

- the grid: You can display or hide the grid appearing on the graph's background. By default, the grid is displayed.
- the graph background: You can display the graph with a black (invert color feature) or a white background. By default, the background is white.

**Note:** *The application always generates graphs with a white background in the reports.*

- the zoom window: The zoom window shows you which portion of the graph is being magnified. By default, the zoom window is displayed.
- the file name in the trace display: The file name appears at the top of the trace display. By default, the file name is displayed.

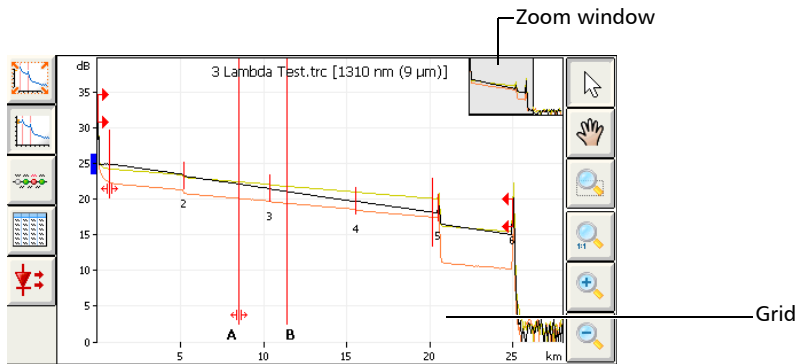

**Note:** *The trace display settings used in Auto and Advanced modes are independent from the ones used in the Fault Finder mode.*

#### To set the trace display parameters:

1. From the button bar, press the **OTDR Setup** button, then select the **General** tab.
2. Select the boxes corresponding to the item you want to display on the graph.

OR

To hide them, clear the boxes.

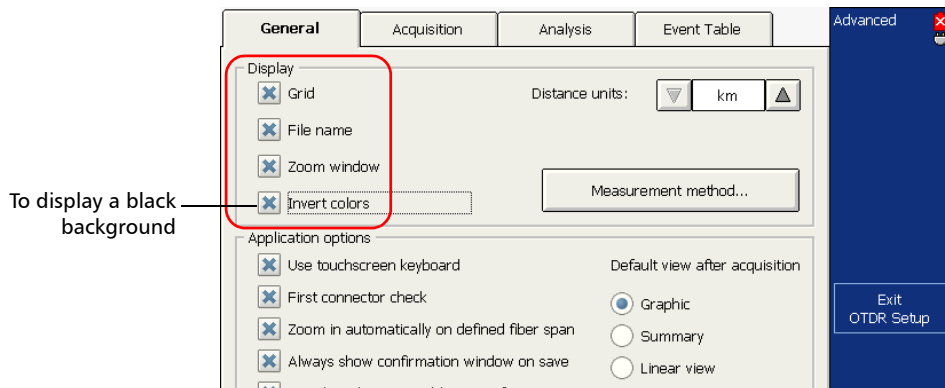

3. Press **Exit OTDR Setup** to return to the main window.

The changes are applied automatically.

# Customizing the Event Table

**Note:** This function is available both in Advanced and Auto modes.

You can include or exclude items from the events table to better suit your needs.

**Note:** Hiding the fiber sections will not delete these items.

- **Fiber sections:** You can display or hide fiber sections in the events table and in the linear view, depending on the types of values you want to display.
- **Launch level:** In the events table, the Launch Level event is represented by the → icon. In the **Att.** column, the injection level value for that event is identified by the @ symbol. You can hide the injection level value and symbol from the **Att.** column, but not the → icon.
- **Including span start and span end:** When applicable, the application will include the losses caused by the span start and span end events to the span ORL and span loss values.

OTDR		Events		Measure		Trace Info.	
Type	Number	Loc.	Loss	Refl.	Att.	Cumul.	
→	1	0.0000		-27.4		0.000	
┌	(5.1627 km)		1.598		0.310	1.598	
└	2	5.1627	0.209			1.808	
┌	(5.2291 km)		1.777		0.340	3.584	
└	3	10.3917	0.052			3.636	

If you activated the pass/fail test (see *Setting Pass/Fail Thresholds* on page 70), span-start and span-end events will be taken into account when determining the status (pass/fail) of splice and connector loss and reflectance.

### To customize the events table appearance:

1. From the **OTDR Setup** window, select the **Event Table** tab.
2. Select the boxes corresponding to the item you want to display or include in the table.

OR

To hide them, clear the boxes.

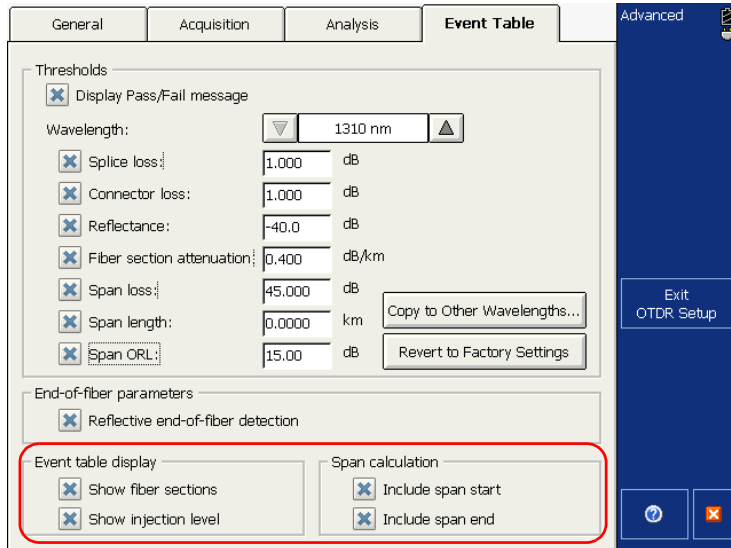

3. Press **Exit OTDR Setup**.

## Displaying or Hiding a Trace

There are two ways of displaying or hiding traces in the OTDR test application.

- You can view, in turn, all the trace files you have opened, including main and reference traces, as well as multiwavelength traces.
- You can select the fibers and the wavelengths (for multiwavelength files) that will be available when using the navigation button. You can also specify which trace will be displayed (current trace). By default, the application takes the last item from the list of trace files you have just opened.

### ***To display or hide traces in turn:***

Press the **Next Trace** button to switch from one fiber to another or from one wavelength to another (for multiwavelength files).



#### To specify which traces to display or hide:

1. From the button bar, press **Storage**.

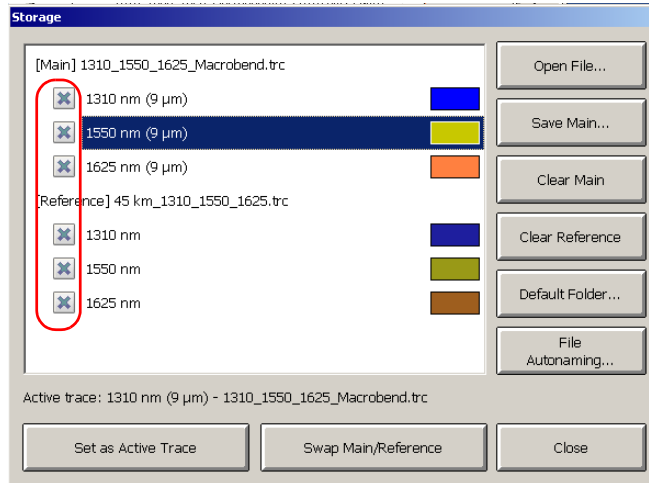

2. Select the boxes corresponding to the traces to display.

OR

Clear the boxes to hide them.

**Note:** A hidden trace cannot be displayed with the navigation button. In multiwavelength trace files, you can show or hide traces independently.

3. From the list of traces, select the row corresponding to the trace you want to set as the current trace (the row will become highlighted) and press the **Set as Active Trace** button.

The trace will turn black in the display to indicate that it was selected.

# Clearing Traces from the Display

**Note:** This function is available in Advanced mode only.

**Note:** Clearing traces from the display does not delete them from the disk.

If a trace you acquired (main or reference) does not meet your requirements, you can clear that trace and start over.

### To clear traces from the display:

1. From the button bar, press **Storage**.
2. From the **Storage** dialog box, press **Clear Main** or **Clear Reference**.

If you had already acquired or modified (but not stored) some traces, a warning message appears for each trace (even if the trace is hidden) asking you if you want to save it or not. Press **Yes** to save the trace.

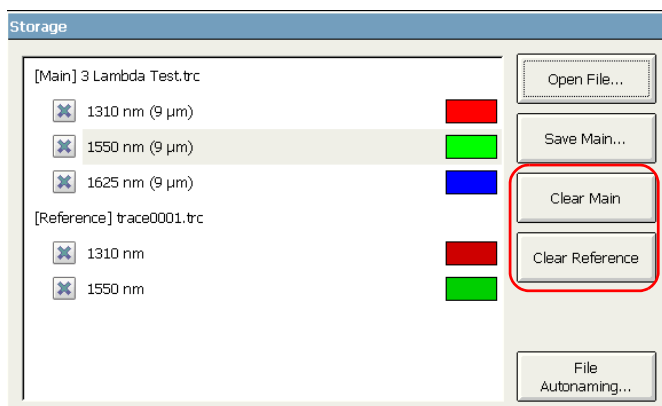

3. Press **Close** to return to the main window. You can now acquire a new trace. For more information, see *Testing Fibers in Advanced Mode* on page 55.

## Viewing and Modifying Current Trace Settings

You can view the trace parameters and modify them at your convenience.

**Note:** *Parameter modification is only possible in Advanced mode.*

You can modify the index of refraction (IOR) also known as group index, Rayleigh backscatter (RBS) coefficient and helix factor for the displayed trace.

Modifications you make are only applied to the current trace (that is, to a particular wavelength), not to all traces.

The application will only prompt you to reanalyze the trace if you modify the RBS coefficient (no analysis necessary when you modify the IOR or helix factor).

## Analyzing Traces and Events

### Viewing and Modifying Current Trace Settings

#### To view trace settings:

Go to the **Trace Info.** tab.

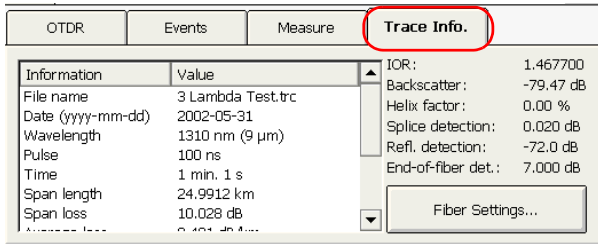

**Note:** Even if more than one trace is available, the **Trace Info.** tab only shows one at a time. To display the traces in turn, press **Next Trace** in the toolbar. The active trace appears in black in the trace display.

These parameters are displayed:

- **Wavelength:** Test wavelength and type of fiber used.
- **Pulse:** Pulse width used to perform the acquisition.
- **Time:** Duration (either in minutes or seconds) of the acquisition.
- **Span length:** Measured length of the total fiber span between span start and span end.
- **Span loss:** Total measured loss of the fiber calculated either between the span start and the span end, or on the total fiber span, depending on the option you have selected in the **Setup** window.
- **Average loss:** Average loss of the total fiber span, indicated as a function of distance.
- **Average splice loss:** Average of all non-reflective events between span start and span end.
- **Max. splice loss:** Maximum loss of all non-reflective events between span start and span end.

- **Span ORL:** ORL calculated either between the span start and the span end, or on the total fiber span, depending on the option you have selected in the **Setup** window.
- **High resolution:** High-resolution feature was selected to perform the acquisition. For more information, see *Enabling the High-Resolution Feature* on page 66.
- **Helix factor:** Helix for the displayed trace. If you modify this parameter, the trace distance measurements will be adjusted.
- **IOR:** Refraction index of the displayed trace, also known as group index. If you modify this parameter, the distance measurements for the trace will be adjusted. You can enter an IOR value directly or let the application calculate it with the distance between span start and span end you provide. The IOR value is displayed with six digits after the decimal point.
- **Backscatter:** Rayleigh backscatter coefficient setting of the displayed trace. If you modify this parameter, the reflectance and ORL measurements for the trace will be adjusted.
- **Splice detection:** Current setting for detecting small non-reflective events during trace analysis.
- **Refl. detection:** Current setting for detecting small reflective events during trace analysis.
- **End-of-fiber det.:** Current setting for detecting important event loss that could compromise signal transmission during trace analysis.

## Analyzing Traces and Events

### Viewing and Modifying Current Trace Settings

**To modify the IOR, RBS coefficient, and helix factor parameters:**

1. From the main window, go to the **Trace Info.** tab.

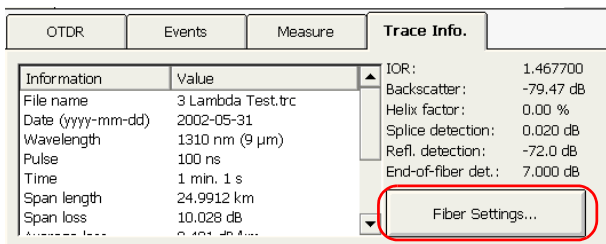

2. Press the **Fiber Settings** button.
3. Enter the desired values for the current trace in the appropriate boxes.

OR

If you want to revert a particular item to its default value, press the **Default** button appearing next to this item.

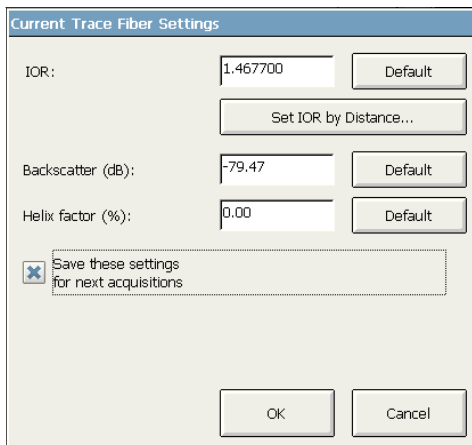

**Note:** Except for the fiber type, modifications you make will only be applied to the current trace (that is, to a particular wavelength), not to all traces.

If you already know the IOR value, you can enter it in the corresponding box. However, if you prefer to let the application calculate the IOR value as a function of the distance between span start and span end, press **Set IOR by Distance**, then enter the distance value.

4. If you want to save the modified IOR, RBS, and helix Factor values for the next acquisitions performed at the current wavelength, select the **Save these settings for next acquisitions** check box.
5. Press **OK** to apply the changes.

You return to the main window.

## Modifying Events

**Note:** *This function is available in Advanced mode only.*

You can change the loss and reflectance of almost any existing event except:

- continuous fiber
- end of analysis
- launch level
- merged events
- span start
- span end

In the case of a reflective event, you can also specify whether the event corresponds to an echo, a possible echo, or no echo.



### IMPORTANT

If you reanalyze a trace, all of the modified events will be lost and the events table will be re-created.

**Note:** *If you want to modify the attenuation value of a fiber section, see [Changing the Attenuation of Fiber Sections](#) on page 150.*



### To modify an event:

1. Select the event you want to modify.
2. Press the **Change Event** button.

Markers **a**, **A**, **B**, and **b** appear on the graph. With these markers, you can define a new location for the selected event.

You can reposition all markers directly by dragging them, or by pressing where you want to relocate them on the graph. Selecting marker **A** or **B** will move the **a-A** or **B-b** pair.

**Note:** *The current marker locations are set, during the analysis, to calculate and display the original event loss and reflectance.*

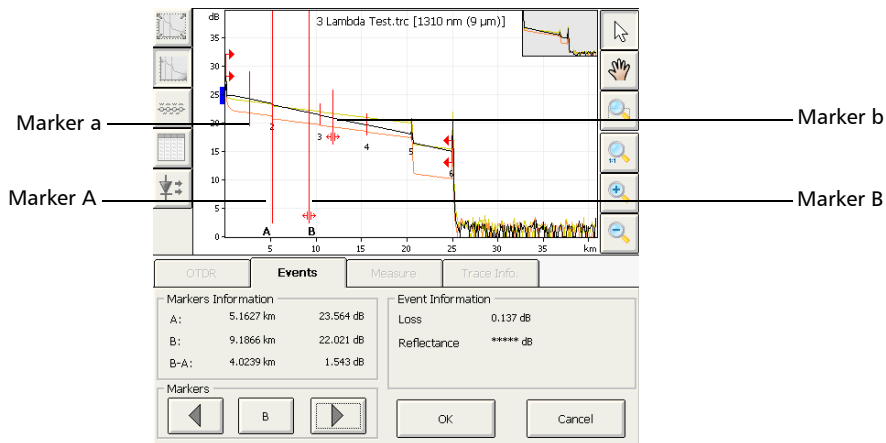

## Analyzing Traces and Events

### Modifying Events

3. Position marker **A** on the event, and submarker **a** (to the left of marker **A**) as far as possible from marker **A**, without including the preceding event.

The area between markers **A** and **a** must not include any significant variation. For more information on positioning markers, see *Using Markers* on page 169.

4. Position marker **B** after the end of the event, where the trace returns to a regular loss inside the fiber, and submarker **b** (to the right of marker **B**), as far as possible from marker **B**, without including the following event.

The area between markers **B** and **b** must not include any significant variation. For more information on positioning markers, see *Using Markers* on page 169.

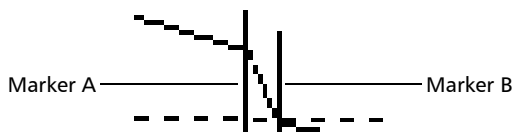

Event loss and reflectance are displayed, respectively, in the **Loss** and **Reflectance** boxes.

OTDR	Events	Measure	Trace Info.
Markers Information		Event Information	
A:	20.5026 km 19.335 dB	Loss	1.498 dB
B:	20.9060 km 16.538 dB	Reflectance	-48.00 dB
B-A:	403.414 m 2.796 dB	Echo status :	<input type="text" value="..."/>
Markers		OK Cancel	

Loss and reflectance values

5. If you selected a reflective event, you can modify the echo status using the up/down arrows of the Echo status list.

**Note:** Select “- - -” if you want to indicate that the event is not an echo.

6. Press **OK** to accept the modifications you have made or **Cancel** to return to the events table without saving the changes.

The modified events are identified with “\*” (appearing beside the event symbol) in the events table as shown below.

OTDR		Events		Measure		Trace Info.	
Type	Number	Loc.	Loss	Refl.	Att.	Cumul.	
→	1	0.0000		-27.4		0.000	▲
↔	(5.1627 km)		1.598		0.310	1.598	▲
↔*	2	5.1627	0.138			1.737	▲
↔	(5.2291 km)		1.748		0.334	3.485	▲
↔	3	10.3917	0.056			3.540	▼

## Analyzing Traces and Events

### Inserting Events

## Inserting Events

You can insert events in the event table manually.

This could be useful, for example, if you know that there is a splice at a given location, but the analysis does not detect it because it is hidden in the noise or because the splice loss is lower than the minimum detection threshold (see *Setting Pass/Fail Thresholds* on page 70).

You can add this event to the events table manually. This will add a number on the trace at the location of the insertion, but it will *not* modify the trace.



## IMPORTANT

Inserted events are removed when you reanalyze a trace.

### To insert an event:

1. From the **Events** tab, press **Add New Event**.

OTDR		Events		Measure		Trace Info.	
Type	Number	Loc.	Loss	Refl.	Att.	Cumul.	
→	1	0.0000		-27.4		0.000	
↔	(5.1627 km)		1.598		0.310	1.598	
↘	2	5.1627	0.209			1.808	
↔	(5.2291 km)		1.777		0.340	3.584	
↘	3	10.3917	0.052			3.636	

2. Select the location where you want to insert an event.

OTDR		Events		Measure		Trace Info.	
Markers Information				Event			
A:	5.1780 km		23.383 dB	▼	<input checked="" type="checkbox"/> Positive		▲
B:	11.1986 km		21.275 dB	Location	Loss	Reflectance	
B-A:	6.0206 km		2.107 dB	5.1780 km	0.254	---	
Markers							
◀		All		▶			
				OK		Cancel	

Four markers are available to measure the inserted event, but only marker **A** identifies where the event will be inserted. Use the marker arrows to move marker **A** on the trace display.

3. Once you have determined the location, under **Event**, use the up/down arrows next to the box to select the desired event type.

Markers Information	
A:	5.1780 km 23.383 dB
B:	11.1986 km 21.275 dB
B-A:	6.0206 km 2.107 dB

Event		
▼	Positive	▲
Location	Loss	Reflectance
5.1780 km	0.254	---

Markers: ◀ All ▶

Event: OK Cancel

4. Press **OK** to insert the event or **Cancel** to return to the events table without making any changes.

Inserted events are marked with asterisks (appearing beside the event number).

## Deleting Events

**Note:** *This function is available in Advanced mode only.*

Almost any event can be deleted from the events table, except:

- end of analysis
- fiber section
- launch level
- end of fiber
- span start
- span end

**Note:** *The “End-of-fiber” event indicates the span end that was set for the first analysis of the trace, not the span end assigned to another event or distance from the span end in the **Analysis** tab.*



### IMPORTANT

The only way to “recover” deleted items is to reanalyze the trace, as you would for a new trace. For more information, see *Analyzing or Reanalyzing a Trace* on page 155.

**To delete an event:**

1. Select the event you want to delete.

OTDR		Events		Measure		Trace Info.	
Type	Number	Loc.	Loss	Refl.	Att.	Cumul.	
→	1	0.0000		-27.4		0.000	▲ Add New Event... Change Event... Delete ▼
↔	(5.1627 km)		1.598		0.310	1.598	
↖	2	5.1627	0.209			1.808	
↔	(5.2291 km)		1.777		0.340	3.584	
↖	3	10.3917	0.052			3.636	

2. Press **Delete**.
3. When the application prompts you, press **Yes** to confirm the deletion, or **No** to keep the event.

# Managing Comments

**Note:** This function is available in Advanced mode only.

You can insert comments manually on a specific event and you can also delete them. A red triangle on the event indicates that a comment has been added. This way, you can locate rapidly the events you have customized.

### To insert a comment:

1. Select the event on which you want to insert a comment.
2. From the **Events** tab, press **Edit Comments**.

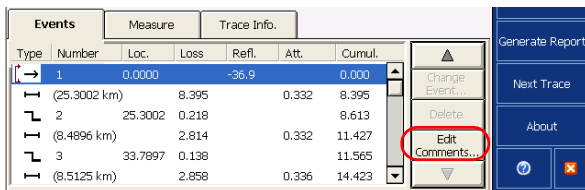

3. From the **Edit Comments** dialog box, enter a comment.

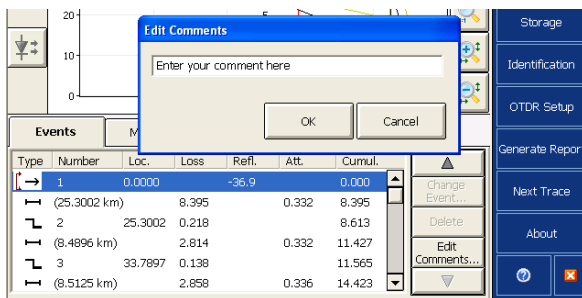

4. Press **OK**.

A red triangle appears next to the event number to indicate that a comment has been inserted manually. The customized event can be seen in the tooltip.



***To delete a comment:***

- 1.** Select the event on which you want to delete a comment.
- 2.** From the **Events** tab, press **Edit Comments**.
- 3.** From the **Edit Comments** dialog box, delete the text.
- 4.** Press **OK**.

# Changing the Attenuation of Fiber Sections

**Note:** This function is available in Advanced mode only.

You can change the attenuation value of fiber sections.



## IMPORTANT

If you reanalyze a trace, all of the modifications made to the fiber sections will be lost and the events table will be re-created.

**Note:** If you want to modify events, see *Modifying Events* on page 140.

**To modify the attenuation of a fiber section:**

1. From the event table, select the fiber section.
2. Press the **Change Event** button.

The **A** and **B** markers appear in the trace display.

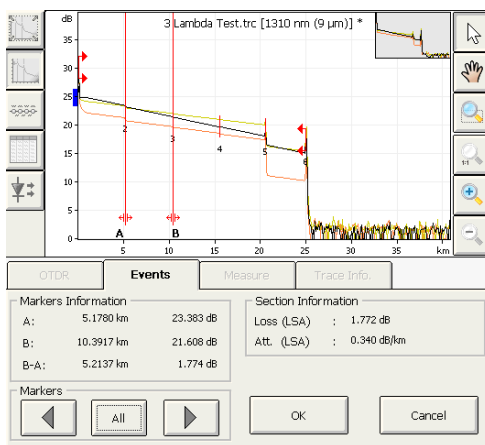

3. Position markers as desired to modify the attenuation value. For more information on positioning markers, see *Using Markers* on page 169.

**Note:** *The markers serve only to set the new attenuation value. Their actual locations will not be modified.*

Fiber section loss and attenuation are displayed respectively in the **Loss (LSA)** and **Att. (LSA)** boxes.

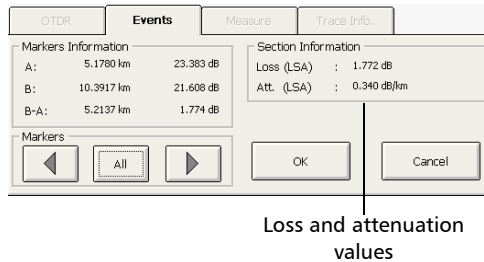

4. Press **OK** to accept the modifications you have made or **Cancel** to return to the events table without saving the changes.

The modified fiber sections are identified with “\*” in the events table as shown below.

OTDR		Events	Measure	Trace Info.			
Type	Number	Loc.	Loss	Refl.	Att.	Cumul.	
→	1	0.0000		-27.4		0.000	▲
↔	(5.1627 km)		1.598		0.310	1.598	▲
↔	2	5.1627	0.209			1.808	▲
↔	(5.2291 km)		1.817		0.348	3.625	▲
↔	3	10.3917	0.052			3.677	▼

## Setting the Analysis Detection Thresholds

**Note:** *This function is available in Advanced mode only.*

To optimize event detection, you can set the following analysis detection thresholds:

- *Splice loss threshold:* To display or hide small non-reflective events.
- *Reflectance threshold:* To hide false reflective events generated by noise, transform non-harmful reflective events into loss events, or detect reflective events that could be harmful to network and other fiber-optic equipment.
- *End-of-fiber threshold:* To stop the analysis as soon as an important event loss occurs; for example, an event that could compromise signal transmission toward the end of a network.



### IMPORTANT

The end-of-fiber (EoF) threshold that you define will be used in Advanced mode if you let the application evaluate the acquisition settings.

If you set this threshold, an EoF event will be inserted at the first event for which the loss crosses the threshold. The application will then use this EoF event to determine the acquisition settings.

The following examples show how different splice-loss threshold levels can affect the number of displayed events, especially small non-reflective events such as those caused by two splices. Three traces are shown, corresponding to three threshold level settings.

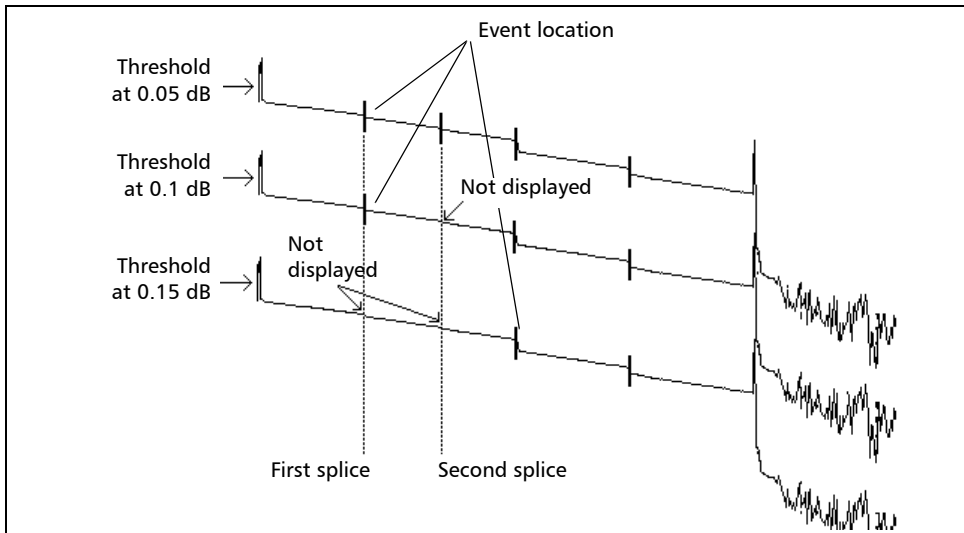

➤ *Threshold at 0.05 dB*

With the threshold set to 0.05 dB, two events are displayed at distances corresponding to the location of the first and second splices.

➤ *Threshold at 0.1 dB*

Only the first splice is displayed, as the threshold is set to 0.1 dB and the second splice loss is lower than 0.1 dB.

➤ *Threshold at 0.15 dB*

The first two splices are not displayed, as the threshold is set to 0.15 dB and the first and second splice losses are lower than 0.15 dB.

## Analyzing Traces and Events

### Setting the Analysis Detection Thresholds

#### To set the analysis detection thresholds:

1. From the button bar, press **OTDR Setup**.
2. From the **OTDR Setup** dialog box, select the **Analysis** tab.
3. Under **Analysis parameters**, set the parameters.

General Acquisition **Analysis** Event Table Advanced

Analysis parameters

Automatically analyze data after acquisition

Splice loss detection threshold: 0.020 dB

Reflectance detection threshold: -72.0 dB

End-of-fiber detection threshold: 5.000 dB Default

Span start

Set on event  
Event number: 1

Set by distance

Span end

Set on event (from fiber end)  
Event number: 1

Set by distance

Exit OTDR Setup

- Enter the desired values in the appropriate boxes.

OR

- Select the default settings by pressing **Default**.

4. Press **Exit OTDR Setup**.

The analysis detection thresholds you have just set are applied to all newly acquired traces.

**Note:** *Analysis thresholds are only saved in the trace during analysis. For traces acquired, but not yet analyzed, you can change the analysis detection thresholds in the OTDR test application before performing the analysis.*

# Analyzing or Reanalyzing a Trace

**Note:** *This function is available in Advanced mode only.*

You can analyze a displayed trace at any time. Analyzing or reanalyzing a trace will:

- produce an events table for a trace, if there was none (for example, the *Automatically Analyze Data after Acquisition* feature was not selected; see *Enabling or Disabling Analysis After Acquisition* on page 68).
- reanalyze a trace acquired with a previous version of the software.
- re-create the events table if it was modified.
- perform a Pass/Fail test, if enabled (for more information, see *Setting Pass/Fail Thresholds* on page 70).

If you prefer to focus your analysis on a specific fiber span, see *Analyzing the Fiber on a Specific Fiber Span* on page 157.

## Analyzing Traces and Events

### Analyzing or Reanalyzing a Trace

---

#### **To analyze or reanalyze a trace:**

1. From the main window, go to the **Events** tab.
2. Press the **Analyze** button.
3. From the **Reanalyze Trace** dialog box, select an item for setting the span start and end markers on the trace. On the first analysis, this dialog box is not displayed and the default span start and end are applied (See *Setting a Default Span Start and Span End* on page 75).

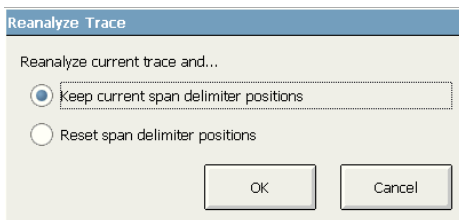

- **Keep current span delimiter positions** applies the current fiber span upon trace reanalysis.
  - **Reset span delimiters positions** applies the fiber span defined in the **OTDR Setup** upon trace reanalysis.
4. Press **OK** to confirm.



# Analyzing the Fiber on a Specific Fiber Span

**Note:** *This function is available in Advanced mode only.*

If you want to focus your fiber analysis on a specific fiber span, you can define events (new or existing) as a span start and/or span end. You can even define a fiber span for short fibers by placing the span start and the span end on the same event.

**Note:** *You can set a default span start and end, which will be applied during the first analysis or reanalysis performed upon trace acquisition.*

### **To set a fiber span:**

- 1.** From the main window, go to the **Events** tab.
- 2.** Define the span event location by moving marker **A** along the trace.
- 3.** Press **Set as Span Start** or **Set as Span End** to set the span start or span end marker on the appropriate event in the trace display.

Changes to the span start and span end will modify the contents of the events table. The span start becomes event 1 and its distance reference becomes 0. Events excluded from the fiber span are grayed out in the events table, and do not appear in the trace display. The cumulative loss is calculated within the defined fiber span only.

# Enabling or Disabling the Detection of Reflective Ends of Fiber

By default, the application stops the analysis as soon as there is too much noise on a trace to ensure accurate measurements. However, you can configure the application to search the “noisy” portion of the trace to detect strong reflective events (such as those caused by UPC connectors) and set the span end at this point.

**Note:** *The detection of reflective ends of fiber is only performed when you test at singlemode wavelengths.*

Once you have selected the option, the detection will be performed automatically on the next acquisitions.







If a trace was acquired without selecting the option first, you will have to reanalyze the trace manually (for more information on trace reanalysis, see *Analyzing or Reanalyzing a Trace* on page 155). When you reanalyze a trace, to benefit from the option, you should select *Reset span delimiter positions*.

The application will take into account the option only if there is a significant reflective event located after the end of analysis.

## Analyzing Traces and Events

### *Enabling or Disabling the Detection of Reflective Ends of Fiber*

The table below shows the differences you will notice in the event table depending on if you enable the detection of reflective ends of fiber or not.

Option not selected (conventional analysis)			Option selected	
Case	Event on which span end is set	Loss or reflectance value	Event on which span end is set	Loss or reflectance value
Span end located on a physical event that crosses the end-of-fiber (EoF) threshold	Non-reflective fault  or reflective fault 	Value as calculated by the conventional analysis	Same as the conventional analysis	Same as the conventional analysis
Span end located on a physical event whose loss is below the EoF threshold	Non-reflective fault  or reflective fault 	Value as calculated by the conventional analysis	If applicable, reflective fault  (located in the “noisy” area) <sup>a</sup>	If applicable, reflectance value as calculated by the conventional analysis. <sup>b</sup>
Span end not located on any physical event	End of analysis 	N/A	If applicable, reflective fault  (located in the “noisy” area) <sup>c,d</sup>	If applicable, reflectance value as calculated by the conventional analysis. <sup>b</sup>

- The cumulative loss value will remain the same for all elements appearing after the event on which the span end was set according to the conventional analysis. The span loss value (**Trace Info.** tab) will correspond to the loss calculated between span start and the event on which the span end was set according to the conventional analysis.
- Value is underestimated because the event is located in the “noisy” area.
- The end-of-analysis event is replaced by a non-reflective event  with a loss value of 0 dB.
- The cumulative loss value will remain the same for all elements appearing after the inserted event. The span loss value (**Trace Info.** tab) will correspond to the loss calculated between span start and the inserted event.

## Analyzing Traces and Events

Enabling or Disabling the Detection of Reflective Ends of Fiber



### IMPORTANT

The analysis will stop as soon as the loss of an event crosses the end-of-fiber (EoF) threshold. The application will mark the event as an end-of-fiber event.

In this case, even if you selected the option, the application *will not* search the “noisy” portion of the trace for reflective ends of fiber. If you want to do so, you will have to increase the EoF threshold (see *Setting the Analysis Detection Thresholds* on page 152).

#### **To enable or disable the detection of reflective ends of fiber:**

1. From the button bar, press **OTDR Setup**.
2. From the **OTDR Setup** dialog box, go to the **Event Table** tab.
3. If you want to enable the option, under **End-of-Fiber parameters**, select the **Reflective end-of-fiber detection** box.

OR

If you prefer to disable the option, clear the box.

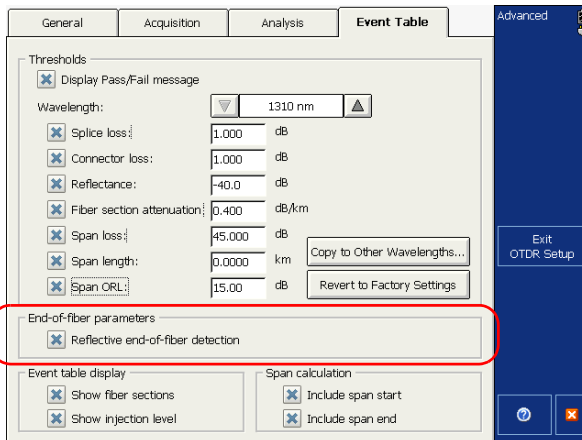

4. Press **Exit OTDR Setup**.

## Swapping Traces

**Note:** This function is available in Advanced mode only.

Since the events table and the trace information are based on the main trace, you may want to interchange main and reference traces.

When you swap traces, the application will provide a new set of events corresponding to the new main trace.

### To swap traces:

1. From the button bar, press **Storage**.
2. From the **Storage** dialog box, select **Swap Main/Reference**.

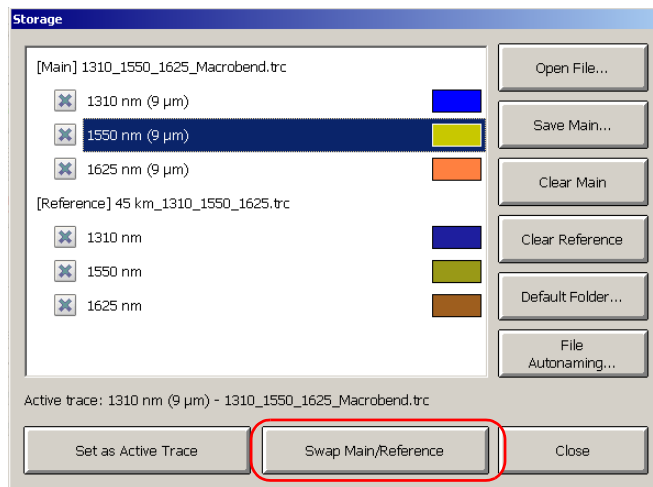

**Note:** You can change a main trace into a reference trace, and vice versa, even if only one trace is in the application's memory.

## Opening Trace Files

In Advanced mode, you can open a trace file as the main trace or the reference trace.

You can open both the main and reference trace files at the same time. You can open two multiple wavelength trace files simultaneously, each containing several traces.

In Automatic mode, you can open a trace file *for viewing only*. Consequently, you cannot select a trace as main or reference trace.

When you open trace files, the application always displays the first wavelength of the file.

The table below presents the possible behavior of the zoom and markers when you open traces (main or reference). If you open old OTDR traces, see the corresponding row for more information.

File Type	Zoom	Marker
Trace that has been saved with an automatic zoom on the selected event (button was pressed)	<p>Application automatically zooms in on the event that was selected on the first trace (wavelength) of the file.</p> <p>If you switch to the next trace, the application will automatically zoom in on the event that was selected for the second trace.</p>	Markers that are displayed correspond to those of the selected event.
Trace that has been saved with a manual zoom.	<p>Application zooms in on the first trace (wavelength) of the file, according to the zoom area and zoom factor that were saved with the file. Application does not zoom in on the selected events.</p> <p>The same zoom will be applied to all traces.</p>	Markers are displayed in the same state they were when you saved the file. Markers will remain at the same location even if you switch to another trace.
Old trace file	<p>Traces are displayed in full view mode.</p> <p>The first event of the trace is selected.</p>	Application defines default positions for markers.

## Analyzing Traces and Events

### *Opening Trace Files*

---

If you want to keep the current zoom and markers, you must save your file before opening another one.

As soon as a reference trace is open, the application will apply the zoom and marker settings of the reference file to all traces (main and reference).

For detailed information on compatibility between EXFO's file formats and software versions, see *OTDR Trace File Compatibility* on page 182.

For information on how to navigate between traces, see *Displaying or Hiding a Trace* on page 132.



#### To open a trace file:

1. From the button bar, press **Storage**, then **Open File**.

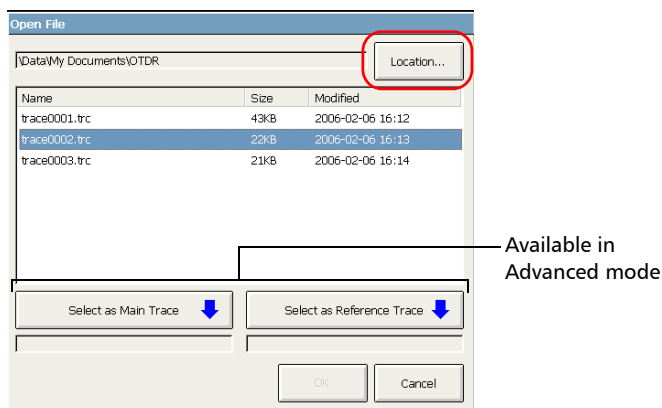

2. If necessary, change the location to retrieve the file that was stored.
3. Scroll through the list of files and select a trace file to open.
4. If you are in Advanced mode, press the **Select as Main Trace** or **Select as Reference Trace** button to indicate whether the selected trace will be used as the main or the reference trace.

You can select another file from the list and set the trace as the main or reference trace, according to your needs.

5. Press **OK**.

You return to the **Storage** dialog box.

If you had already acquired (but not stored) a trace, the application prompts you to save the current trace (even if the trace is hidden). Press **Yes** to store the trace. You can now open another trace file.

6. If necessary, specify which traces should be displayed. For more information, see *Displaying or Hiding a Trace* on page 132.
7. Press **Close**.



# 10 Analyzing the Results Manually

Once a trace has been acquired or opened, you can use markers and zoom in on or out of any event or trace segment to measure splice loss, fiber section attenuation, reflectance, and optical return loss.

## Selecting the Attenuation and Loss Values that Will Be Displayed

By default, in the **Measure** tab, the application only displays the values obtained by using the same measurement methods as the analysis, that is the four-point event loss and the A-B LSA attenuation.

**Note:** *This function is not available in Auto mode because you do not have access to the **Measure** tab in this mode.*

You can display the values corresponding to the following measurement methods:

- For loss:
  - Four-point event loss
  - A-B LSA (Least-Square Approximation) loss
- For attenuation:
  - Two-point section attenuation
  - A-B LSA (Least-Square Approximation) attenuation

**Note:** *You must select at least one measurement method for loss value and one measurement method for attenuation value.*

## Analyzing the Results Manually

*Selecting the Attenuation and Loss Values that Will Be Displayed*

---

**To select the attenuation and loss values that will be displayed:**

1. From the button bar, press **OTDR Setup** then go to the **General** tab.
2. Press the **Measurement Method** button.
3. Select which values you want to see in the **Measure** tab.

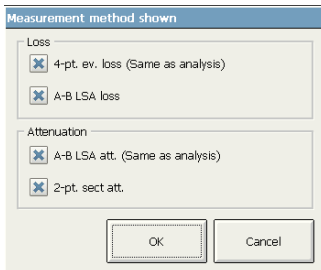

4. Press **OK** to confirm your selection.
5. Press **Exit OTDR Setup** to return to the OTDR application.

## Using Markers

You can use markers to view the position and relative power of an event.

Markers are available from the **Events** tab (when you modify or add an event) or the **Measure** tab in the main window.

### To move a marker:

1. Ensure that the  button is selected in the zoom button bar.
2. From the **Measure** tab, press the markers button until it displays the desired marker.

In addition to the **a**, **A**, **B**, and **b** markers, you can also select the **All** item.

3. Once the appropriate marker is selected, use the right and left arrow buttons to move the marker along the trace.

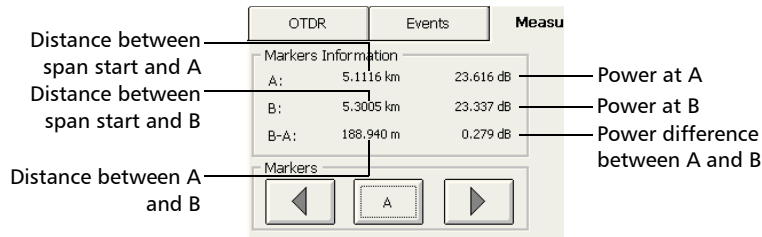

The screenshot shows the 'Measu' tab with a 'Markers Information' table and a 'Markers' control panel. The table lists data for markers A, B, and B-A. The control panel includes left and right arrow buttons and a button labeled 'A'.

Markers Information		
A:	5.1116 km	23.616 dB
B:	5.3005 km	23.337 dB
B-A:	188.940 m	0.279 dB

Markers

Distance between span start and A

Distance between span start and B

Distance between A and B

Power at A

Power at B

Power difference between A and B

**Note:** You can also select the marker directly on the trace display and drag it to the desired position.

If a marker is moved closed to another one, both will move together. This ensures a minimum distance is maintained between markers.

A marker may disappear from the trace after you zoom in (see *Using Zoom Controls* on page 125). You can recall it by selecting a missing marker with the **Markers** button or by using one of the arrows to bring the selected marker back into the displayed area.

## Analyzing the Results Manually

### Getting Event Distances and Relative Powers

## Getting Event Distances and Relative Powers

The OTDR test application automatically calculates the position of an event and displays this distance in the events table.

You can retrieve the position of an event as well as the distance between events manually. You can also display various relative power readings.

Distances and relative powers correspond to the X-axis and Y-axis, respectively.

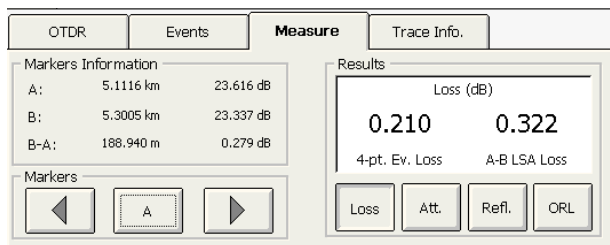

**To get the distance to an event and the associated relative power level:**

1. From the main window, select the **Measure** tab.
2. Move marker **A** to the beginning of the event. For more information about markers, see *Using Markers* on page 169.

## Getting Event Loss (Four-Point and Least-Square Approximation)

Event loss (expressed in dB) is calculated by measuring the signal level reduction in Rayleigh backscatter (RBS) caused by this event. Event loss can result from both reflective and non-reflective events.

Two loss calculations are provided simultaneously: the four-point event loss and the A-B LSA loss. Both calculations use the least-square approximation (LSA) method to determine the event loss. *However, the four-point event loss is the preferred method and the one that corresponds to the loss displayed in the events table.*

## Analyzing the Results Manually

### Getting Event Loss (Four-Point and Least-Square Approximation)

- *Four-point event loss*: the LSA method is used to fit a straight line to the backscatter data within the two regions defined by markers a, A and b, B, that is over the regions to the left and to the right of the event bordered by markers A and B, respectively.

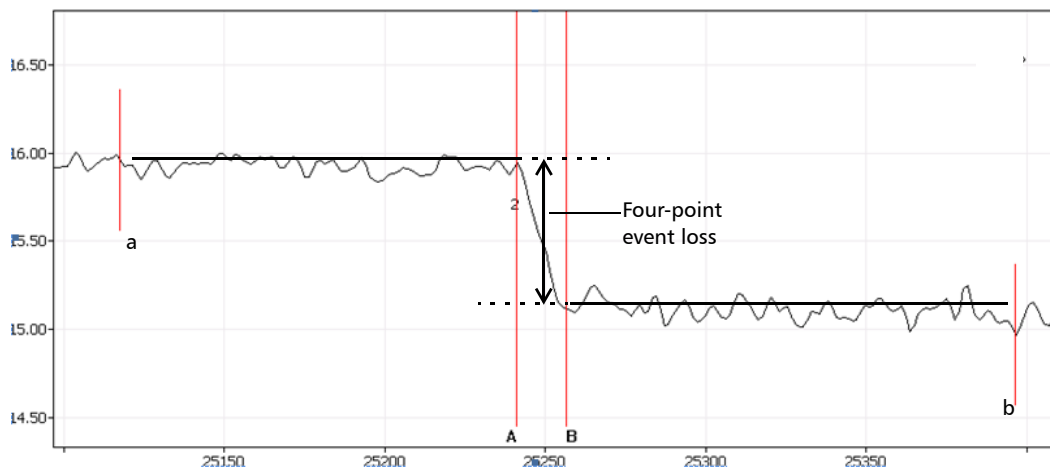

The two fitted lines are then extrapolated toward the center of the event and the loss event is directly read from the drop in power between the two lines.



## Analyzing the Results Manually

### Getting Event Loss (Four-Point and Least-Square Approximation)

- *A-B LSA loss*: the loss of the event bordered by the markers A and B is obtained by fitting a straight line to the backscatter data between these two markers.

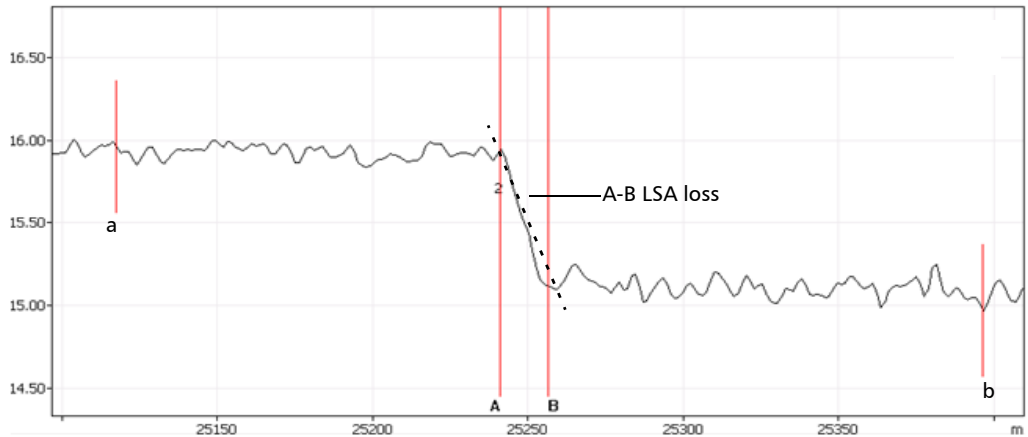

The event is then obtained by the reduction in power (dB) over the distance between the two markers, as calculated from the slope of the fitted line.

Although this method works fairly well for splice loss, it is clearly not appropriate for reflective events (definitely not a “straight-line” event). A-B LSA loss is mainly used to rapidly compute loss over a given length of a fiber section.

**Note:** *A-B LSA event loss measurements should be used on fiber sections only. Measuring events will not yield meaningful results.*

## Analyzing the Results Manually

*Getting Event Loss (Four-Point and Least-Square Approximation)*

---

### **To get event loss:**

- 1.** From the main window, select the **Measure** tab.
- 2.** In the **Results** section, press **Loss**. Markers **a**, **A**, **B** and **b** appear on the graph.
- 3.** Zoom in and position marker **A** at the *end* of the linear area *preceding* the event to be measured. For more information, see *Using Zoom Controls* on page 125 and *Using Markers* on page 169.
- 4.** Position submarker **a** at the *beginning* of the linear area *preceding* the event to be measured (must not include any significant events).

## Analyzing the Results Manually

### Getting Event Loss (Four-Point and Least-Square Approximation)

5. Position marker **B** at the *beginning* of the linear area *following* the event to be measured.
6. Position submarker **b** at the *end* of the linear area *following* the event to be measured (must not include any significant events).

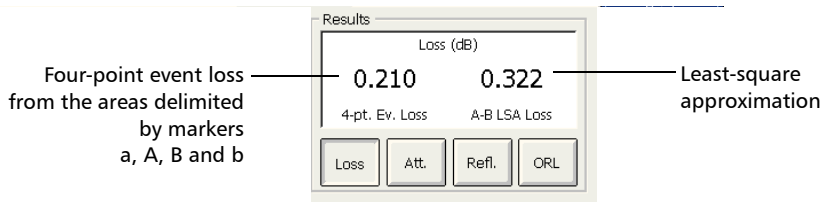
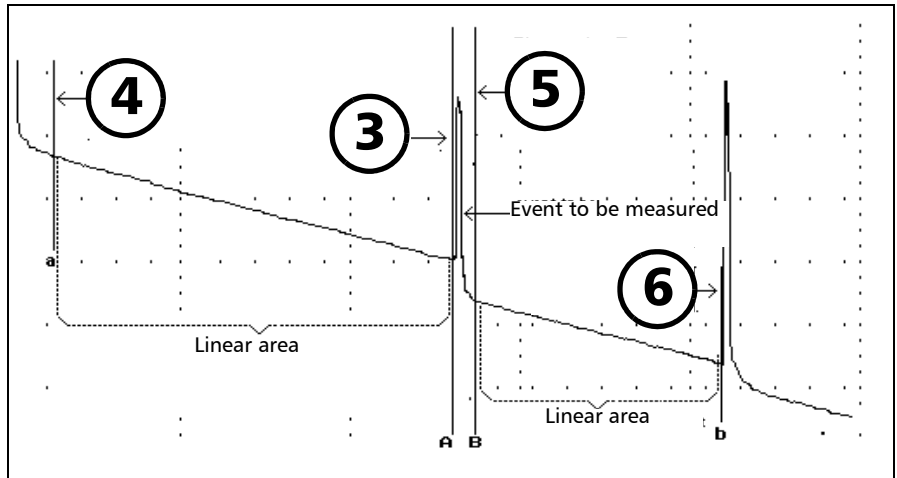

**Note:** The loss values that are displayed depend on which calculation methods are selected (see *Selecting the Attenuation and Loss Values that Will Be Displayed* on page 167).

# Getting Attenuation (Two-Point and Least-Square Approximation)

A two-point attenuation measurement gives the reduction in Rayleigh backscatter level as a function of distance (always expressed in dB/km to follow the standards of the fiber-optic industry) between two selected points. Only those two points are used to perform the calculation and there is no averaging.

The least-square approximation (LSA) method measures the attenuation (loss over distance) between two points by fitting a straight line in the backscatter data between markers **A** and **B**. The LSA attenuation corresponds to the difference in power ( $\Delta$  dB) over the distance between two points.

The LSA method, when compared to the two-point method, gives an average measurement and is more reliable when there is a high level of noise. However, it should not be used if an event such as an echo appears between the two markers.

## Analyzing the Results Manually

### Getting Attenuation (Two-Point and Least-Square Approximation)

---

#### To get attenuation:

1. From the main window, select the **Measure** tab.
2. In the **Results** section, press the **Att.** button. Markers **A** and **B** appear on the graph.
3. Place markers **A** and **B** at any two points on the trace. For more information, see *Using Markers* on page 169.
4. Zoom in on the trace and fine-tune the marker positioning if necessary. For more information, see *Using Zoom Controls* on page 125.

**Note:** *There should not be any events between markers A and B when performing the two-point attenuation measurement.*

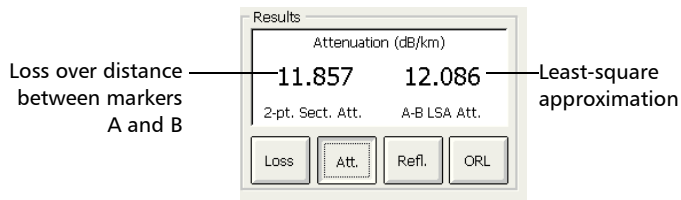

**Note:** *The attenuation values that are displayed depend on which measurement methods are selected (see *Selecting the Attenuation and Loss Values that Will Be Displayed* on page 167).*

### Getting Reflectance

Reflectance is the ratio of reflected light to input light.

**Note:** *If you are testing in Real time, the reflectance value you will get is not necessarily accurate.*

**To get reflectance:**

1. From the main window, select the **Measure** tab.
2. In the **Results** section, press the **Refl.** button. Markers **a**, **A** and **B** appear on the graph.
3. Zoom in and position marker **A** on the linear area *preceding* the event to be measured. For more information, see *Using Zoom Controls* on page 125 and *Using Markers* on page 169.
4. Position submarker **a** at the beginning of the linear area *preceding* the event to be measured.
5. Position marker **B** at the *peak* of the reflective event to be measured.

**Note:** *Using this procedure, you can measure the reflectance of all the events in a merged reflective fault event.*

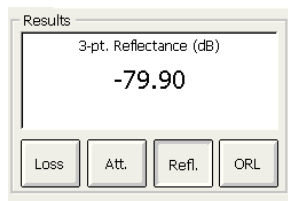

**Note:** *For non-reflective events, \*\*\*\*\* will be displayed.*

## Getting Optical Return Loss (ORL)

**Note:** You must use a singlemode OTDR for ORL calculations.

The ORL calculation will provide the following information:

- the ORL between markers **A** and **B**
- the total ORL is calculated either between the span start and the span end, or on the total fiber span, depending on the option you have selected in the **Setup** window.

Optical return loss (ORL) refers to the total effect of multiple reflections and scattering events within a fiber-optic system.

**Note:** If you are testing in Real time, the reflectance value you will get is not necessarily accurate.

### To get the ORL value:

1. From the main window, select the **Measure** tab.
2. In the **Results** section, press **ORL**. Markers A and B appear on the graph.

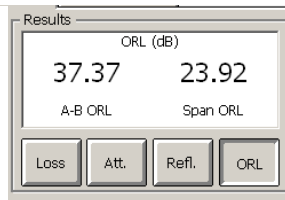

3. Position markers A and B to delimit the area for which you want to know the ORL value.





# 11 **Managing Trace Files from the OTDR Test Application**

Once you have acquired traces, or when you want to work with them after an acquisition, you will need to save, open, rename, and delete trace files.

You can save and open trace files from the OTDR test application. To rename, copy, move, and delete trace files, you must use the **File Manager** utility.

## **Saving a Trace in a Different Format**

With the OTDR application, you can save traces in native (.trc) and Bellcore (.sor) formats. By default, the application saves the traces in native (.trc) format. For information on how to define the default file format, see *Selecting the Default File Format* on page 95).

### ***To save an OTDR trace file in another format:***

Use a computer onto which EXFO FastReporter is already installed.

## Managing Trace Files from the OTDR Test Application

### OTDR Trace File Compatibility

The table presented hereafter shows the compatibility between the format of a specific trace and the software that you may use to open that trace.

Symbols used in the table	Meaning
X	Fully compatible
Conv	Conversion or reanalysis necessary
---	Not compatible

Software used to open the file...								
		ToolBox 5.5	ToolBox 6.5 or earlier	ToolBox 6.7 to 6.20	ToolBox 6.21 or later	FTB-100 2.5 or earlier	FTB-100 2.6 or 2.7	FTB-100 2.8 or later/ FTB-150 FTB-200 FTB-200 v2 FTB-1 AXS-100 MAX-700
File generated with...	ToolBox 5.5	X	X	X	X	Conv <sup>a</sup>	Conv <sup>a</sup>	Conv <sup>a</sup>
	ToolBox 6.5 or earlier	Conv <sup>b</sup>	X	X	X	Conv <sup>a</sup>	Conv <sup>a</sup>	Conv <sup>a</sup>
	ToolBox 6.7 to 6.20	Conv <sup>c</sup>	Conv <sup>c</sup>	X	X	Conv <sup>a,d</sup>	Conv <sup>a</sup>	Conv <sup>a</sup>
	ToolBox 6.21 or later	Conv <sup>c</sup>	Conv <sup>c</sup>	Conv <sup>f,e</sup>	X	Conv <sup>a,d</sup>	Conv <sup>a</sup>	X
	FTB-100 2.2 or earlier	X	X	X	X	X	X	X
	FTB-100 2.5	---	X	X	X	X	X	X

## Managing Trace Files from the OTDR Test Application

### OTDR Trace File Compatibility

Software used to open the file...								
		ToolBox 5.5	ToolBox 6.5 or earlier	ToolBox 6.7 to 6.20	ToolBox 6.21 or later	FTB-100 2.5 or earlier	FTB-100 2.6 or 2.7	FTB-100 2.8 or later/ FTB-150 FTB-200 FTB-200 v2 FTB-1 AXS-100 MAX-700
<b>File generated with...</b>	FTB-100 2.6 or 2.7	---	---	X	X	X	X	X
	FTB-100 2.8 or later/ FTB-150 FTB-200 FTB-200 v2 FTB-1 AXS-100 MAX-700	---	---	Conv <sup>e,f</sup>	X	Conv <sup>a,d, f</sup>	Conv <sup>a,d,f</sup>	X

- a. Should be saved in or converted to FTB-100 (.ftb100) format.
- b. Should be reanalyzed to view the events table.
- c. Data should be saved in FTB-300 (.ftb300) format and reanalyzed to view the events table.
- d. Triple-wavelength trace files are not compatible.
- e. Should be converted to ToolBox 6.7-6.20 format.
- f. Should be converted with ToolBox 6.21 or later.

## Managing Trace Files from the OTDR Test Application

*Copying, Moving, Renaming, or Deleting Trace Files*

---

### Copying, Moving, Renaming, or Deleting Trace Files

If you want to copy, move, rename or delete trace files, you will have to process the files manually via **File Manager** available from MAX-700 software. For more information, refer to your unit help.

# 12 **Creating and Generating Reports**

For future reference, you can add notes on the location of the tested fiber, type of job performed and general comments related to a trace in trace reports.

## **Adding Information to the Test Results**

After acquiring a trace, you might want to include or update information about the tested fiber and job or add comments. The information you enter is saved only for the currently open trace file.

After entering the required data, you may save the contents as a template. The next time you access the report to add information to a newly acquired trace, the template is automatically recalled, eliminating repetitive documentation operations.

Some of the information is common to all wavelengths (location A and B, cable ID and fiber ID). Some other is specific to the current wavelength (job ID, operators A and B, company, customer and comments). If you clear information from the **Identification** window, both the common and the specific information will be deleted. The information specific to other wavelengths will not be deleted (you must delete it manually).

## Creating and Generating Reports

### Adding Information to the Test Results

#### **To add information to the test results:**

1. From the button bar, once a trace has been acquired or reopened, press **Identification**.
2. Enter the desired information.

**Note:** The information in the **Date**, **Time**, **Unit** and **Serial no.** boxes is provided by the application and cannot be edited. .

3. Press **Exit Identification** to return to the trace display.

The information entered is saved with the trace and can be viewed or changed at any time using the same process.

#### **To clear all the information from the Identification window:**

Press the **Clear All** button.

**Note:** The information appearing in the **Date**, **Time**, **Unit**, and **Serial no.** boxes cannot be deleted.

## Generating a Report

You can generate trace reports directly from your unit in HTML format. By default, only the information related to the active trace is generated in a report, but you can also generate all the traces the current file contains (available in Advanced and Auto modes only).

If you want to customize your reports, you can also select the option to generate them in XML format. The XML file does not contain the graphs, but contains all of the other information with the appropriate indicator so that the report generator displays it or not.

The following table shows the various items that can appear on a report, depending on the test mode (Auto or Advanced) that is selected.

Item appearing on the report	Auto mode	Advanced mode
Summary table: a single table containing the pass/fail status, the span loss, the span length, and span ORL for all the wavelengths. By default, this item is selected.	X	X

# Creating and Generating Reports

## Generating a Report

Item appearing on the report	Auto mode	Advanced mode
<p>Macrobend table: a single table containing the location and the delta loss of all the detected macrobends. This table is followed by another table which contains the macrobend thresholds.</p> <p><b>Note:</b> <i>This table is global to the fiber and will be generated if the application has detected macrobends (at any wavelength). For example, even if you choose to only include the current trace (for which no macrobends have been detected at this particular wavelength), the table could be generated if macrobends have been detected at other wavelengths.</i></p> <p>By default, this item is selected if you purchased the Auto Diagnostic (AD) software option. Otherwise, the item will be unavailable or hidden if you configured the application as such (see <i>Displaying or Hiding the Optional Features</i> on page 106).</p>	X	X
<p>Cable information: a single table containing information such as the fiber ID, cable ID, location A and B.</p> <p>By default, this item is selected.</p>	X	X
<p>Job information: test date and time (including the time zone), job ID and customer, operator A and Operator B, filename, and company.</p> <p>By default, this item is selected.</p>	X	X



Item appearing on the report	Auto mode	Advanced mode
<p>Test and Cable Setup for main and reference traces: file name, OTDR model, software version, wavelength, distance, IOR, RBS, acquisition time, pulse width, file type, serial number, splice loss detection, reflectance detection, end-of-fiber detection, and helix factor.</p> <p>By default, this item is selected.</p>	X	X
<p>Comments</p> <p>By default, this item is selected.</p>	X	X
<p>Link measurement: Span loss, Span length, Average loss, Average splice loss, and Span ORL.</p> <p>By default, this item is selected.</p>	X	X
<p>Markers: marker information: a, A, b, B, and A to B distances, as well as A to B attenuation, loss, and ORL.</p> <p>By default, this item is selected.</p>		X
<p>Event table: If you selected the <i>Mark faults in event table</i> feature from the OTDR setup, the failed results will appear in red and bold on a white background. Otherwise, they will not be “highlighted”.</p> <p>By default, this item is selected.</p>	X	X
<p>Pass/Fail thresholds: loss, reflectance, fiber section attenuation thresholds as they are defined in OTDR setup, under <b>Event table</b>.</p> <p style="text-align: center;"><b>Note:</b> <i>Selecting this item will not highlight the failed results in the report. You must configure the application to display fail or warning results from the OTDR setup and include the Event table item in your report.</i></p>	X	X

## Creating and Generating Reports

### Generating a Report

---

Item appearing on the report	Auto mode	Advanced mode
<p>Graph: You can select the Zoom item if you want the traces to be generated with the zoom factor you selected:</p> <ul style="list-style-type: none"><li>▶ Manual zoom: Graphs will be generated exactly as they appear on screen. The same zoom factor will be applied to all traces (wavelengths) of a particular file.</li><li>▶ Zoom on selected event: Graphs will be generated with zoom on the area corresponding to the selected event (one event per trace, that is, one per wavelength).</li></ul> <p>By default, this item is selected.</p>	X	X

Once you generate a report, the application will keep in memory the items you have included in your reports for future use.

#### **To generate reports:**

1. From the button bar, press **Generate Report**.
2. From the **Report** dialog box, select the report characteristics, including whether you want to include the graphs or not.

Select the **Include all traces** item to generate a report for all traces (wavelengths) from the current file (available in Auto and Advanced modes only).

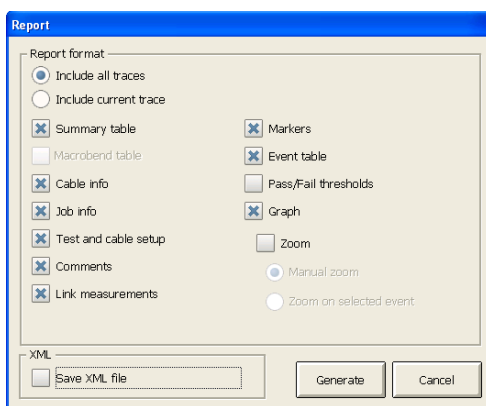

3. If you want to customize your report later, select the **Save XML file check box**.
4. Press **Generate** to start the process.

## Creating and Generating Reports

### *Generating a Report*

---

5. From the **Save As** dialog box, select a folder or create one to save your file.
6. If desired, modify the file name.



### **IMPORTANT**

If you specify the name of an existing trace, the original file will be overwritten and only the new file will be available.

7. Press **Save** to confirm.

You will automatically return to the main window.

## 13 **Using the OTDR as a Light Source**

If you want to perform measurements with a power meter and your OTDR as a source, the OTDR port can transmit a special tone. This port can be used only to transmit—not detect that tone.



### **CAUTION**

Never connect a live fiber to the OTDR port without a proper setup. Any incoming optical power ranging from  $-65$  dBm to  $-40$  dBm will affect the OTDR acquisition. The way the acquisition will be affected depends on the selected pulse width.

Any incoming signal greater than 10 dBm could damage your MAX-700 permanently. For live-fiber testing, refer to the SM Live port specifications for the characteristics of the built-in filter.

## Using the OTDR as a Light Source

### To use your MAX-700 as a source:

1. Clean the connectors properly (see *Cleaning and Connecting Optical Fibers* on page 42).
2. Connect one end of the fiber under test to the OTDR port.

If your unit is equipped with two OTDR ports, ensure that you connect the fiber to the appropriate port (singlemode, singlemode live, or multimode), depending on the wavelength you intend to use.

3. From the main window, press the  button.
4. Select the wavelength you want to use.

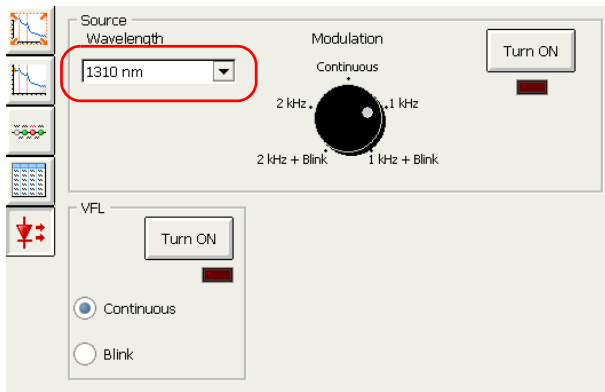

**Note:** If only one wavelength is available, it is selected by default.

**5.** Select the desired modulation.

Under **Modulation**,

- For loss measurement, with a power meter at the other end, select **Continuous**.



### IMPORTANT

Measurements using the **Continuous** setting must always be taken using a GeX detector.

An OTDR source is very powerful and it will certainly saturate Ge and InGaAs detectors, which usually saturate at 6 dBm, while GeX detectors saturates at 26 dBm.

- For fiber identification, select **1 kHz** or **2 kHz**. This will allow the person at the other end of the link to identify the fiber under test, which could be particularly useful when working with cables containing many fibers.

For easier fiber identification, the application also offers a flashing pattern. If you select this pattern, the modulated signal (1 KHz or 2 KHz) will be sent for 1 second, then will be off for the next second, then be sent again for 1 second, and so on. If you want the OTDR to emit light in a flashing pattern, select **1 kHz+Blink** or **2 kHz+Blink**.

**6.** Under **Source**, press **Turn ON**. You can stop light emission at any time by pressing **Turn OFF**.

Using an EXFO power meter with tone-detection features, such as the FOT-930 or FPM-300, an operator at the other end will be able to quickly locate the correct fiber or perform loss measurements. Refer to the power meter user guide for details.





# 14 Setting Up Your Unit

## Adjusting Brightness

To fit your work environment, you may adjust the LCD brightness. Values are kept in memory even when you turn the unit off.

**Note:** These settings do not apply to a fiber inspection probe display.

### To adjust the display brightness:

Press the  key repeatedly to switch between brightness levels.

OR

1. From the **Main Menu**, tap **System Settings**.
2. If necessary, from **System Settings**, tap **Display & Sound**.

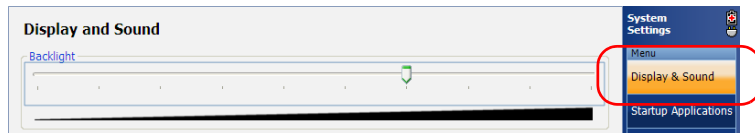

3. Move the slider until the screen appearance is to your liking.

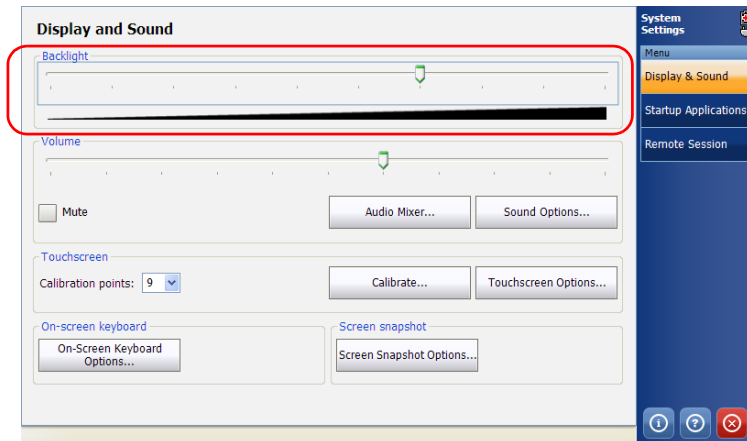

4. Tap  to return to the MAX-700 software window.

## Setting Up Your Unit

### Adjusting Microphone and Headphones Volume

---

# Adjusting Microphone and Headphones Volume

To fit your work environment, you may adjust the volume of your headset's microphone and headphones. Values are kept in memory even when you turn the unit off.

#### **To adjust the microphone volume:**

1. From the **Main Menu**, tap **System Settings**.
2. If necessary, from **System Settings**, tap **Display & Sound**.

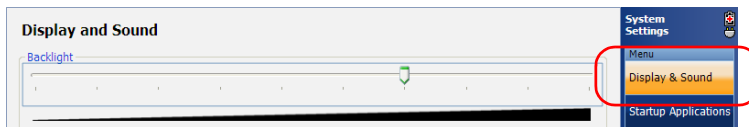

3. Under **Volume**, tap the **Sound Options** button.

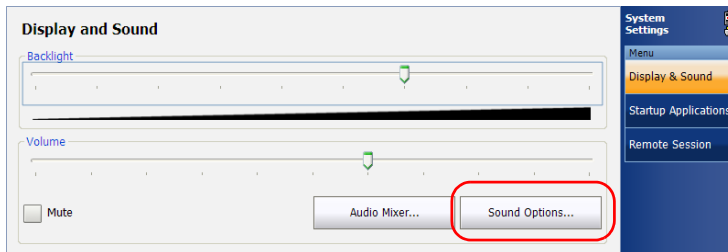

4. Select the **Voice** tab.

5. Under **Voice recording**, tap **Volume**.

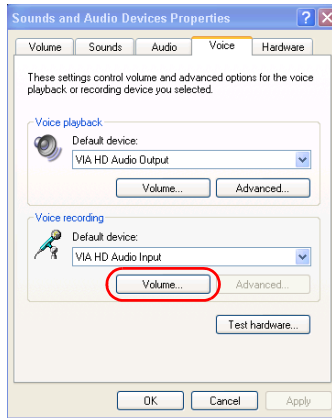

6. Ensure that the microphone boost option is selected:
  - 6a. From the **Options** menu, select **Advanced Controls**.

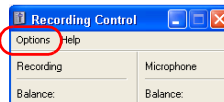

- 6b. Tap the **Advanced** button.

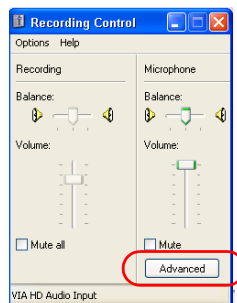

## Setting Up Your Unit

### Adjusting Microphone and Headphones Volume

---

- Under **Other Controls**, select the **1 Microphone Boost** check box.

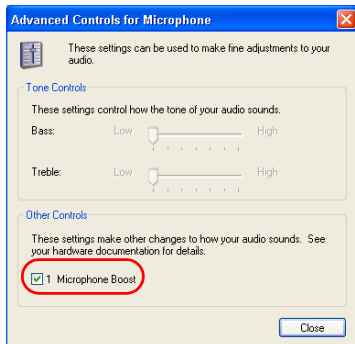

- Tap **Close**.

**Note:** Normally, you only have to select this option the first time that you adjust the microphone volume. Once it is done, you can control the volume with the slider as explained at the next step.

- Under **Microphone**, use the slider to adjust the sound of your microphone. Close the window when your settings are complete.

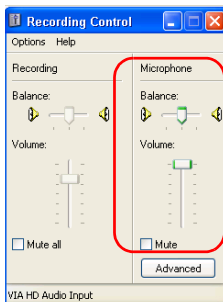

- Tap **OK** to return to the **Display & Sound** window.
- Tap  to return to the MAX-700 software window.

#### To adjust the headphones volume:

1. From the **Main Menu**, tap **System Settings**.
2. If necessary, from **System Settings**, tap **Display & Sound**.

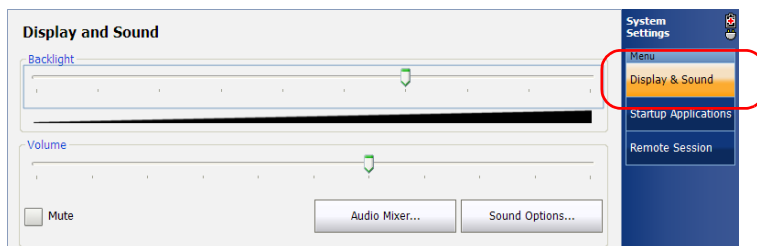

3. Under **Volume**, use the slider to adjust the sound of your speaker.

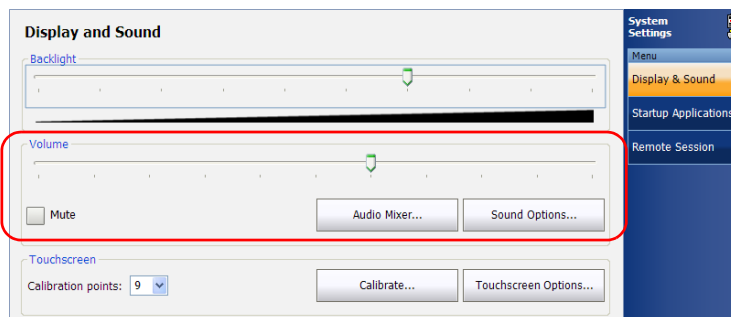

**Note:** You can also select the **Mute** check box if you want to quickly turn off the sound.

**Note:** You can tap the **Audio Mixer** button if you want to refine the volume according to the source of the sound (**Master Volume** and **Wave** controls).

4. Tap  to return to the MAX-700 software window.

## Recalibrating the Touchscreen

If you notice the touchscreen does not behave in the way it used to (for example, it is now difficult to select items) it probably needs a recalibration.

The default calibration method is performed using nine points, but you can also perform a 4-point, or even a 25-point calibration (linearization) if you need more accuracy.

You can stop the calibration process at any time, but the touchscreen will still need calibration. The parameters are taken into account only when the process is complete.

### ***To recalibrate the touchscreen:***

1. From the **Main Menu**, tap **System Settings**.
2. If necessary, from **System Settings**, tap **Display & Sound**.

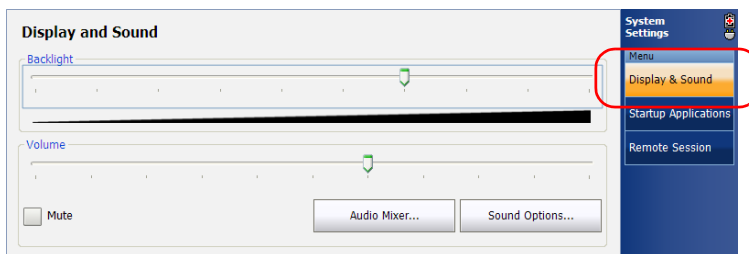

- From the **Calibration points** list, select the desired number of points for the calibration.

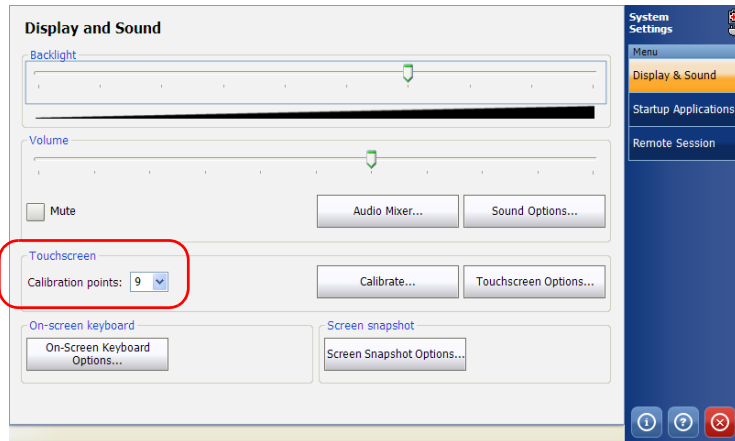

- Tap **Calibrate**.

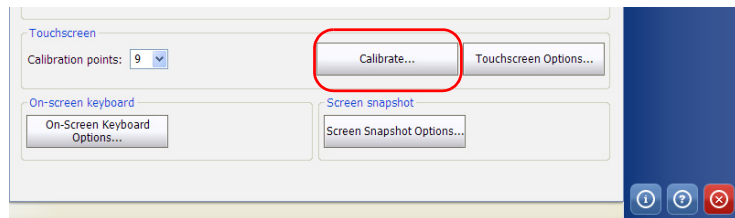

## Setting Up Your Unit

### Recalibrating the Touchscreen

---

- Using the stylus (or any blunt pointing device), simply press the center of the different targets that appear on the screen. Keep pressing until the application displays **OK** to indicate that the new parameters have been taken into account.

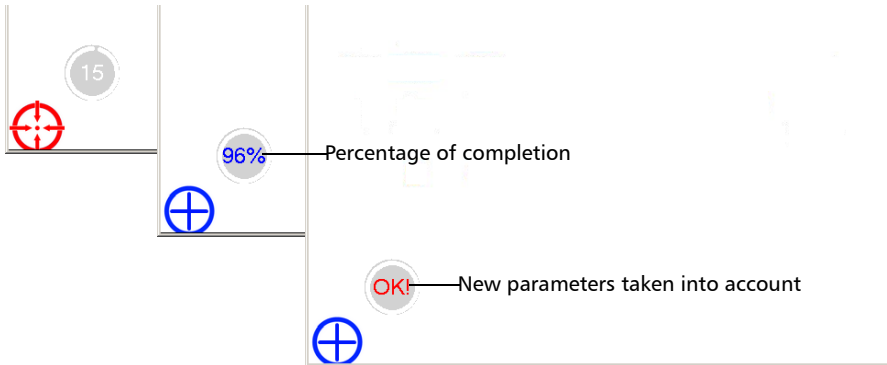

**Note:** *If you want to stop the calibration process, stop pressing the screen. The application will close automatically after a few seconds and you will return to the **Display & Sound** window.*

When the calibration is complete, you will return to the **Display & Sound** window automatically.

- Tap  to return to the MAX-700 software window.



## Enabling or Disabling the Touchscreen Right-Click Feature

By default, you can right-click with your touchscreen (see *Right-Clicking with the Touchscreen* on page 23). However, you can disable this feature if you prefer.

**To enable or disable the right-click of the touchscreen:**

1. From the **Main Menu**, tap **System Settings**.
2. If necessary, from System Settings, tap **Display & Sound**.

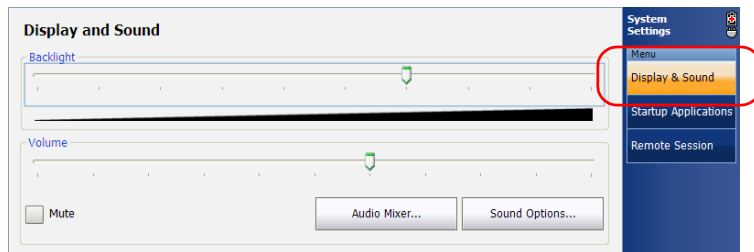

3. Under **Touchscreen**, tap the **Touchscreen Options** button.

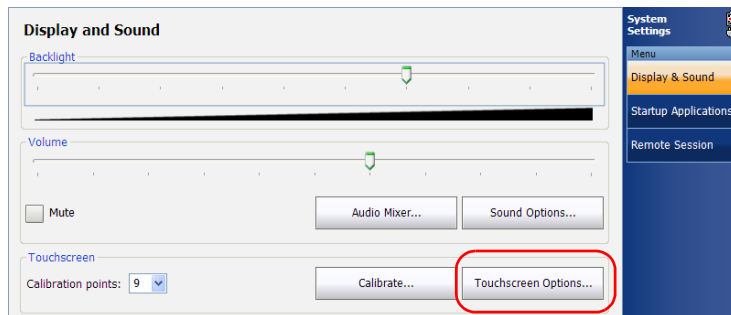

## Setting Up Your Unit

### Enabling or Disabling the Touchscreen Right-Click Feature

4. Select the **Setting** tab.

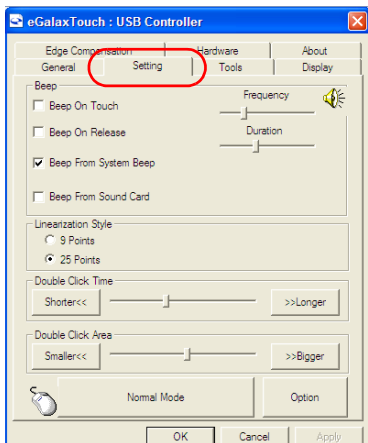

5. Tap the **Option** button.

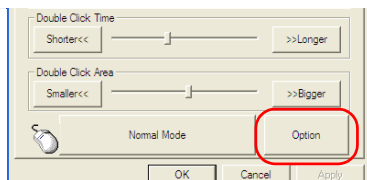

6. From the **Option** tab, select the **Enable Auto Right Click** check box to enable the option.

OR

Clear the check box if you prefer to disable the right-click.

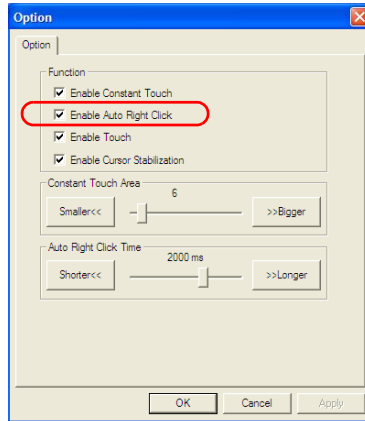

7. Tap **OK** to confirm the changes.
8. Tap **OK** once again to close the touchscreen parameters window.
9. Tap  to return to the MAX-700 software window.

## Setting Up Your Unit

### Customizing the On-Screen Keyboard

# Customizing the On-Screen Keyboard

You can customize the appearance and behavior of the on-screen keyboard. For more information on the various parameters that you can set, refer to the on-screen keyboard online help.

For information on how switch from one of the available languages to another, see *Selecting the Language of Operation* on page 215.

**To customize the appearance and behavior of the on-screen keyboard:**

1. From the **Main Menu**, tap **System Settings**.
2. If necessary, from **System Settings**, tap **Display & Sound**.

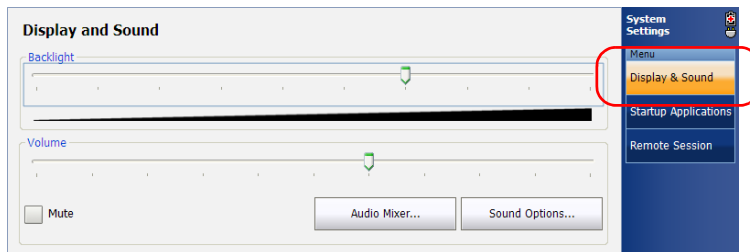

3. Under **On-screen keyboard**, tap the **On-Screen Keyboard Options** button.

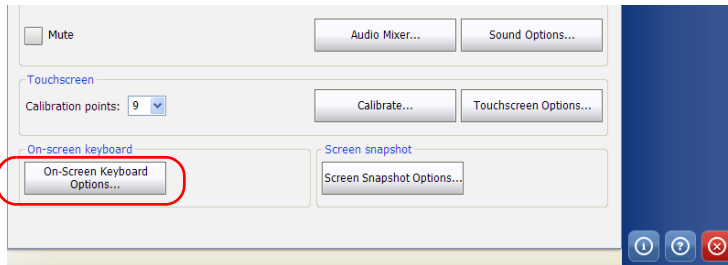

4. Configure the keyboard according to your needs.

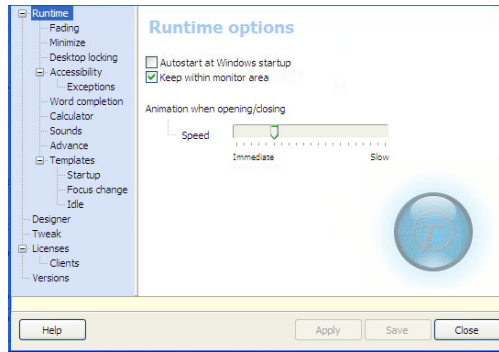

**Note:** You can access the online help related to the keyboard options by tapping the **Help** button.

5. When you have finished, tap **Close**.
6. Tap  to return to the MAX-700 software window.

## Setting Up Your Unit

### Selecting the Startup Application

---

## Selecting the Startup Application

The first time you start your unit, the MAX-700 software is displayed. However, you can configure your unit to automatically start in any of the available applications.

The selected application or applications will start automatically the next time you turn on your unit after a shutdown (not in standby mode). For more information, see *Turning On or Off the Unit* on page 24.

If you want to configure your unit to start the TightVNC server automatically at startup (for remote control), see *Working With TightVNC* on page 288.

### **To select a startup application:**

1. From the **Main Menu**, tap **System Settings**.
2. From **System Settings**, tap **Startup Applications**.

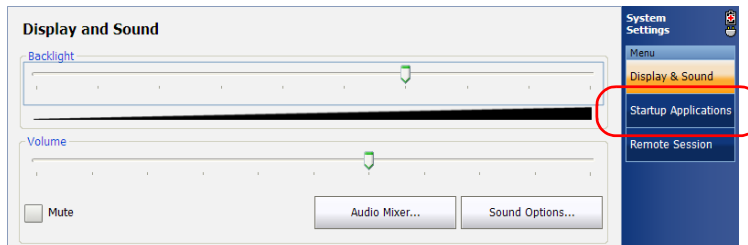

- 3.** Under **Module application** or **Utility applications**, select the application you want to start automatically when you turn on your unit.

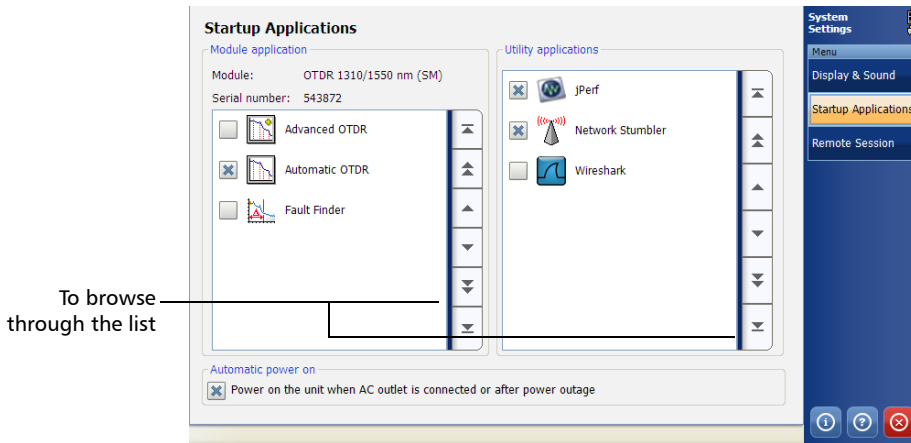

**Note:** You can select several utility applications, but only one module application at a time.

**Note:** If necessary, you can use the scrolling arrows located at the right of the **Module application** and **Utility applications** lists to browse through the available items.

Your changes are automatically saved.

- 4.** Tap  to return to the MAX-700 software window.

# Configuring Network Printers

To print documents and images on a network printer, you must configure the printer first. You must know the IP address of the network printer that you want to configure (see with your network administrator).



## IMPORTANT

- ▶ Your unit does not support USB printers.
- ▶ Your unit only supports network printers compatible with PCL 6 (which is a "Printer Control Language"). If you are not sure whether a specific printer is compatible or not, see with your network administrator.

For more information on printing, see *Printing Documents* on page 233.

### **To configure the printer:**

1. On your unit, from the **Main Menu**, tap **Setup**.
2. Double-tap **Printers and Faxes**.

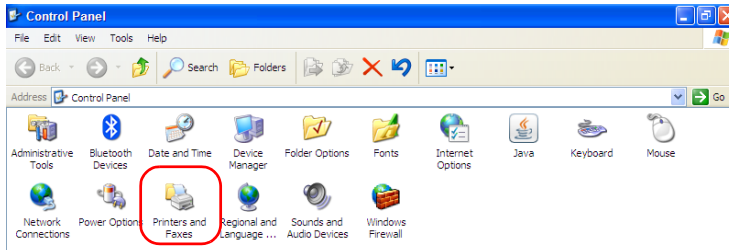



3. Select the **HP Universal Printing PCL 6** item.

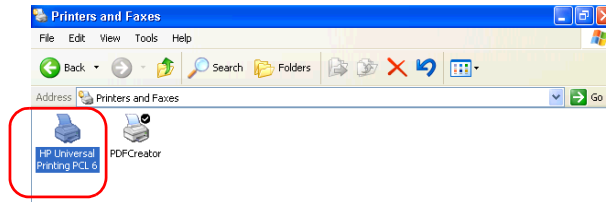

4. From the menu, select **File > Printing Preferences**.
5. Under **Find a Printer**, select **Enter a Printer Address**.

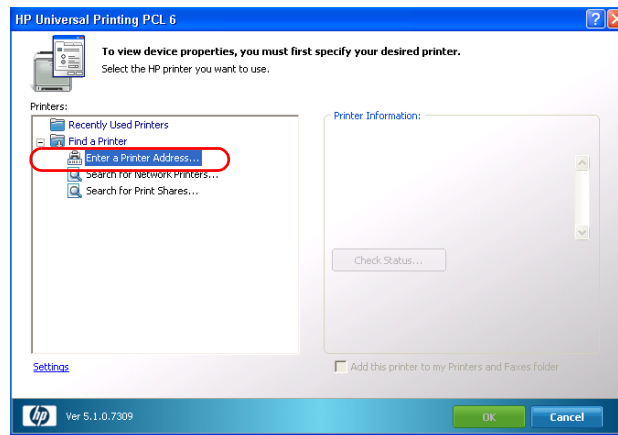

6. Enter the IP address of the printer that you want to configure, and then tap **OK**.

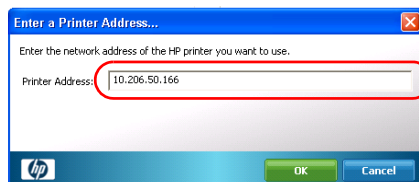

## Setting Up Your Unit

### Configuring Network Printers

7. Select the **Add this printer to my Printers and Faxes** folder check box.

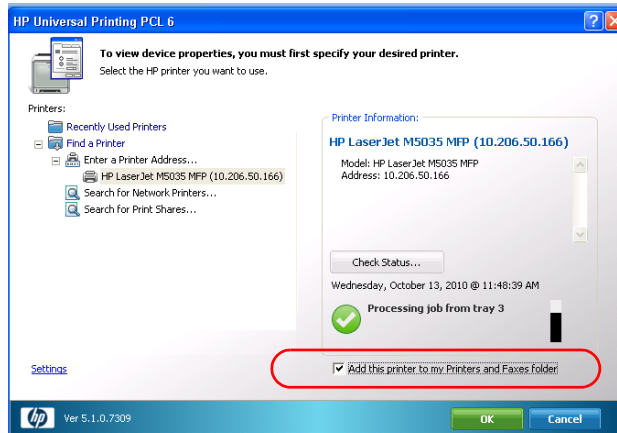

8. Tap **OK** to confirm. The operation can take several minutes to complete.
9. When the application prompts you, click **OK** to acknowledge the message.
10. If desired, modify the printer preferences to your liking. You can save the whole set of preferences for future use with the **Save As** button.
11. Close the **Printing Preferences** window, and then close the **Printers and Faxes** window to return to the MAX-700 software window.

The printer is now ready to use.

## Selecting the Language of Operation

You may display the user interface in one of the available languages (default is English).

When you change the interface language, the corresponding keyboard is not automatically added to the list of available keyboards. You must add the desired keyboard separately if you want to enter text in a specific language (both on-screen or “real” keyboards). Once the keyboards are added, you can switch easily from one input language to another.

Values are kept in memory even when you turn the unit off.



### **IMPORTANT**

The language setting of the VLC media player is independent of the language setting of the MAX-700 software. You must configure both separately.

## Setting Up Your Unit

### Selecting the Language of Operation

---

**To select a new interface language:**

1. From the **Main Menu**, tap **Setup**
2. Double-tap **Regional and Language Options**.

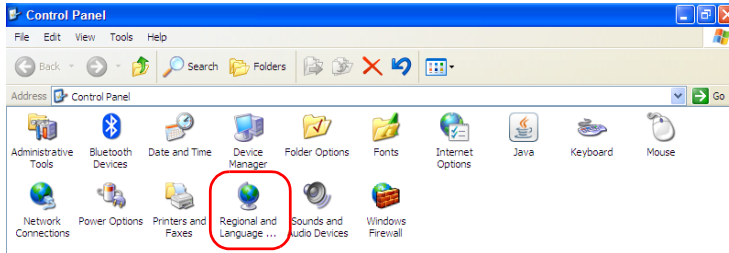

3. Select the **Languages** tab.

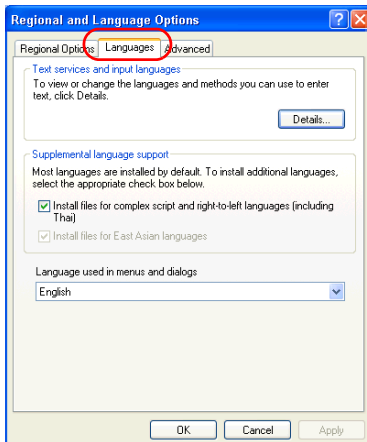

4. From the **Language used in menus and dialogs** list, select the desired language.
5. Tap **Apply** to confirm the changes, and then **OK** to return to the **Control Panel** window.

The new interface language will become available at the next startup.

**To add new input languages:**

1. From the **Main Menu**, tap **Setup**.
2. Double-tap **Regional and Language Options**.

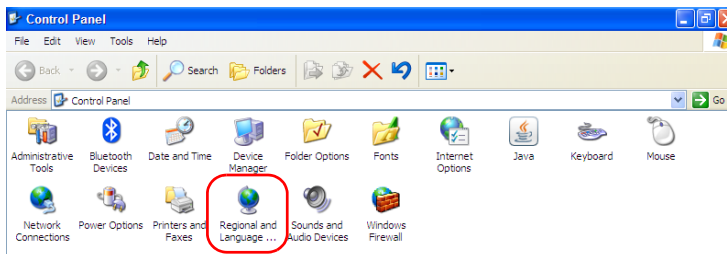

3. Select the **Languages** tab.

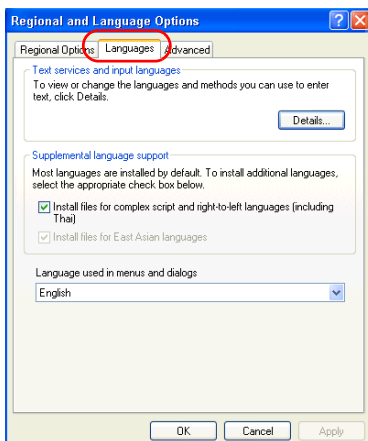

## Setting Up Your Unit

### Selecting the Language of Operation

---

4. Under **Text services and input languages**, tap **Details**.

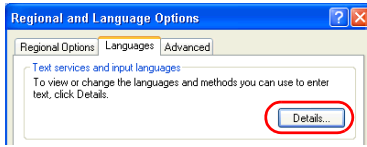

5. Under **Installed services**, tap **Add**.

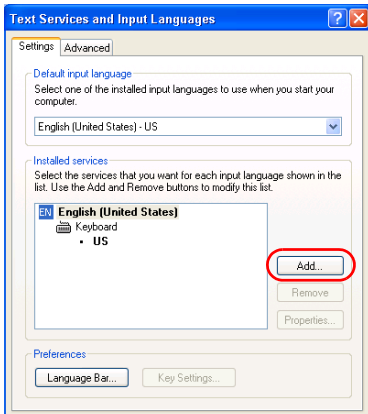

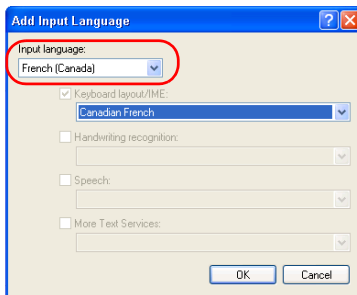

6. From the **Input language** list, select the desired language.



7. If necessary, from the **Keyboard layout/IME** list, select the desired option.
8. Tap **OK** to confirm.
9. Repeat steps 5 to 8 for all the languages that you want to add.
10. Tap **Apply** to confirm the changes, and then **OK** to return to the **Control Panel** window.

The added keyboards are available immediately. You can now switch from one input language to another.

**To switch from one of the available input languages to another:**

1. From the unit's keypad, press the  /  button to display the on-screen keyboard.
2. From the on-screen keyboard, tap  to display the list of available input languages.
3. From the list of languages, select the desired one.

You are now ready to start entering text in the selected input language.

**Note:** *Modifying the input language does not modify the language of the interface.*

## Setting Up Your Unit

### *Selecting the Language of Operation*

---

#### **To modify the language of the VLC media player:**

1. Close the MAX-700 software window.
2. On the Windows taskbar, tap **Start**, then select **All Programs > VideoLAN > VLC media player**.
3. From the menu, select **Tools > Preferences**.

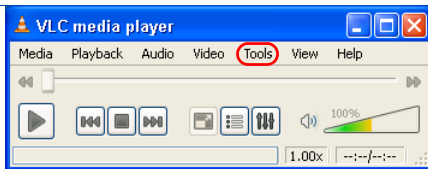

4. Under **Language**, select the desired language from the list.  
By default, the language is set to **Auto**, to follow the *Standards and formats* setting of Windows, but you can select any other language.
5. Tap **Save** to confirm and close the application.

**Note:** *This operation has no impact on the date and time formats in Windows Embedded Standard and in the MAX-700 applications.*



## **Setting Date and Time Formats**

The current date and time are displayed at the bottom of the **Main Menu**.

You can modify the format in which the date and time are displayed.

For information on how to adjust the date, the time, and the time zone, see *Adjusting the Date, Time and Time Zone* on page 224.

**Note:** *Modifying location, date and time settings will affect some of the Windows Embedded Standard settings.*

## Setting Up Your Unit

### Setting Date and Time Formats

---

#### **To set date and time formats:**

1. From the **Main Menu**, tap **Setup**.
2. Double-tap **Regional and Language Options**.

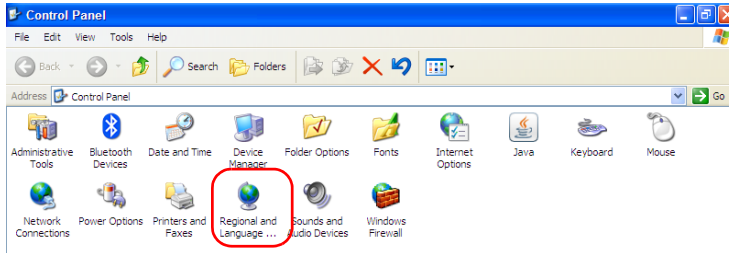

3. Select the **Regional Options** tab.

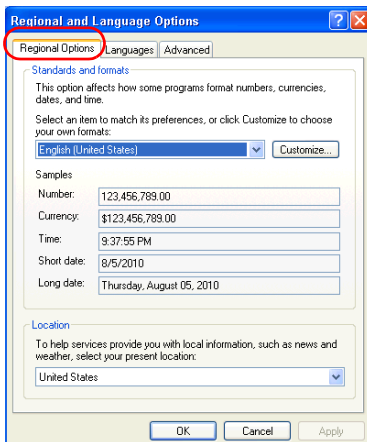

4. Under **Standards and formats**, select the desired language. This will determine the date formats available for the time as well as the short and long dates.

5. If necessary, refine the settings as follows:
  - 5a. Tap **Customize** to display the detailed settings.

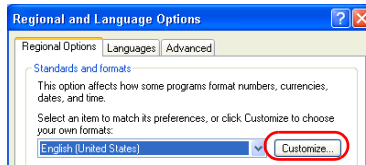

- 5b. Select either the **Time** or **Date** tab, depending on the settings that you want to modify.

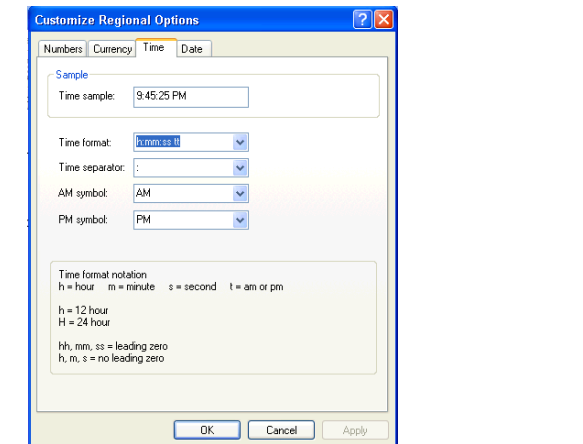

6. Modify the settings.
7. Tap **Apply** to confirm the changes, and then **OK** to return to the **Control Panel** window.

## Setting Up Your Unit

### *Adjusting the Date, Time and Time Zone*

---

## Adjusting the Date, Time and Time Zone

The current date and time are displayed at the bottom of the main window. When saving results, the unit also saves the corresponding date and time.

**Note:** *A dedicated clock battery keeps the date and time accurate.*

For information on how to modify the format in which the date and time are displayed, see *Setting Date and Time Formats* on page 221.

**Note:** *Modifying date and time settings will affect some of the Windows Embedded Standard settings.*

#### To adjust the date and time:

1. From the **Main Menu**, tap **Setup**.
2. Double-tap **Date and Time**.

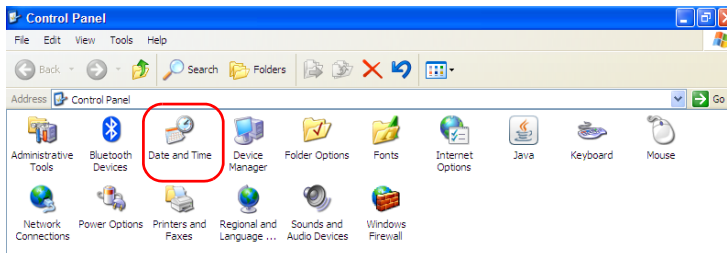

3. Select the **Date & Time** tab.

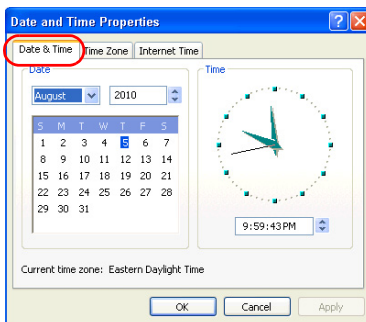

4. Modify the settings according to your needs.
5. Tap **Apply** to confirm the changes, and then **OK** to return to the **Control Panel** window.

## Setting Up Your Unit

### Adjusting the Date, Time and Time Zone

---

#### **To change the time zone:**

1. From the **Main Menu**, tap **Setup**.
2. Double-tap **Date and Time**.

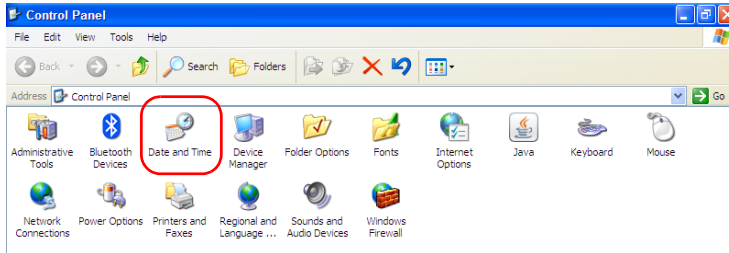

3. Select the **Time Zone** tab.

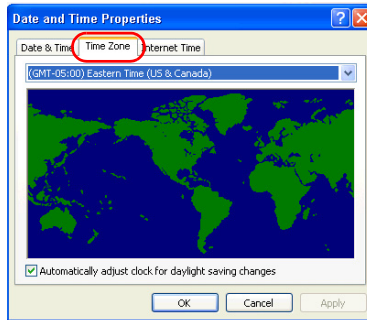

4. Modify the settings according to your needs.
5. Tap **Apply** to confirm the changes, and then **OK** to return to the **Control Panel** window.

## **Configuring the Power Management Options**

To get the optimum performance out of your MAX-700, your unit comes with predefined sets of parameters (schemes) to manage power.

When you do not use the unit for a while, the display may be turned off to save power. You can also configure the unit to go into standby mode after the specified duration has expired (see *Turning On or Off the Unit* on page 24).

For all of these actions, you can set idle durations for AC adapter/charger and battery operation. The values that you set are kept in memory even when you turn the unit off.

**Note:** *When the backlight is turned off, the unit operation is not interrupted. Press any key or touch anywhere on the screen to return to normal operation.*

## Setting Up Your Unit

### Configuring the Power Management Options

---

The table below indicates the default values that are included in each of the predefined power schemes.

Power Scheme	Action	When AC is connected	Running on batteries
Standard (selected by default)	Turn off monitor	Never	After 5 minutes
	System standby	Never	After 15 minutes
Always On	Turn off monitor	Never	Never
	System standby	Never	Never
Max Battery	Turn off monitor	After 15 minutes	After 5 minutes
	System standby	After 30 minutes	After 15 minutes

**Note:** *The Turn off hard disks setting is not taken into account (not applicable).*

You can either modify one of the existing power schemes or create one (based on an existing power scheme).



### CAUTION

Your unit has been designed to manage power as well as battery alarms automatically. Never modify the parameters that appear on the Alarms tab. Doing so WILL prevent the unit from working properly.



#### To select a power scheme:

1. From the **Main Menu**, tap **Setup**.
2. Double-tap **Power Options**.

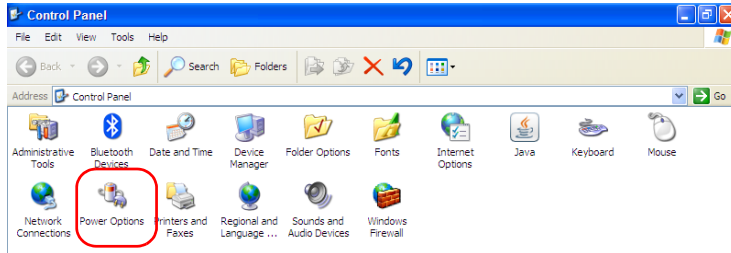

3. From the **Power Schemes** list, select the desired predefined set of parameters.

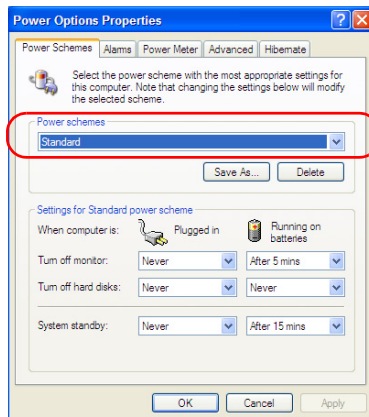

4. Tap **Apply** to confirm the changes, and then **OK** to return to the **Control Panel** window.

## Setting Up Your Unit

### Configuring the Power Management Options

#### To modify a power scheme:

1. From the **Main Menu**, tap **Setup**.
2. Double-tap **Power Options**.

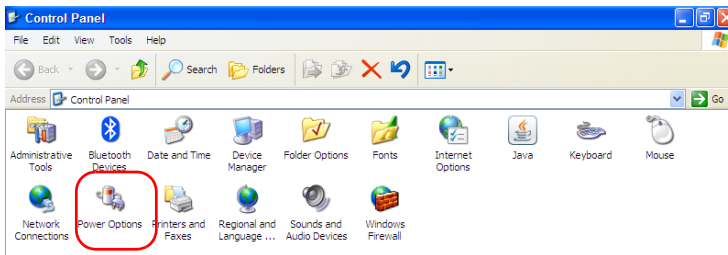

3. From the **Power Schemes** list, select the predefined set of parameters that you want to modify or on which you want to base your new scheme.
4. Modify the parameters to your needs.
5. Tap **Save As**.

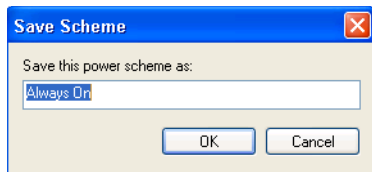

- If you want to modify the existing power scheme, keep the name as is, and then tap **OK**.
- OR
- If you prefer to create a new power scheme, enter a new name, and then tap **OK**.
6. Tap **Apply** to confirm the changes, and then **OK** to return to the **Control Panel** window.

## Configuring the Internet Options

You can browse the Web directly from your unit, provided that you have access to an Internet connection and that the Internet options are configured properly.

If you are not sure about how you should configure your Internet access, see with your network administrator.

### **To configure the Internet options:**

1. From the **Main Menu**, tap **Setup**.
2. Double-tap **Internet Options**.

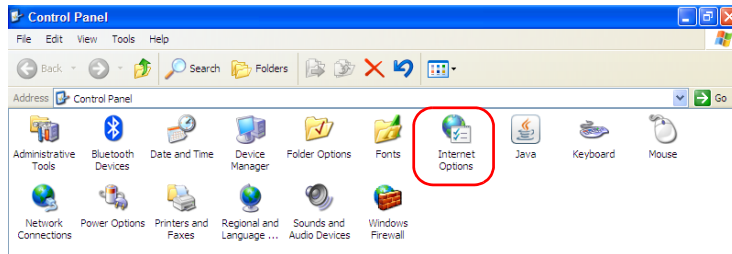

3. Go to the **Connections** tab.
4. Modify the settings using the information provided by your network administrator.
5. Tap **OK** to return to the **Control Panel** window.

## Setting Other Parameters

You can also configure other parameters via the **Control Panel** window. Refer to Microsoft Windows Embedded Standard documentation for details.



# 15 *Working with Your Unit*

## Printing Documents

You can print documents and images directly from your unit by using either the PDFCreator (for PDF files) or a network printer (for printing on paper).

You can view the PDF files from your unit, using the SumatraPDF reader. For more information, see *Viewing PDF Files* on page 236.

To print on a network printer, your unit must be accessible from this network by Wi-Fi or standard Ethernet. You must also define the printer on your unit before attempting to access it (see *Configuring Network Printers* on page 212).

If you cannot connect your unit to a network, you can use a USB memory key to transfer the files that you want to print to a computer connected to the network.

If you need more flexibility and a greater choice of report types, you can also transfer result files to a computer onto which applications such as EXFO FastReporter are installed.

**Note:** *Some applications may not offer print functions.*

## Working with Your Unit

### Printing Documents

---

#### To print documents:

1. Open a Web browser as follows:
  - 1a. From the MAX-700 software, select the **Utilities** tab.
  - 1b. Tap the **Internet Explorer** icon to open the browser.

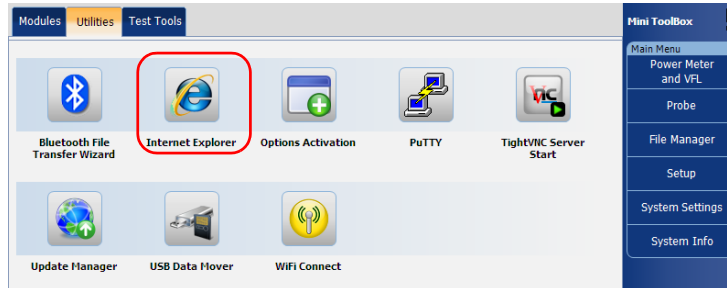

2. Select the document that you want to print as follows:
  - 2a. From the menu, select **File > Open**.
  - 2b. Tap **Browse** to locate the file that you want to open.

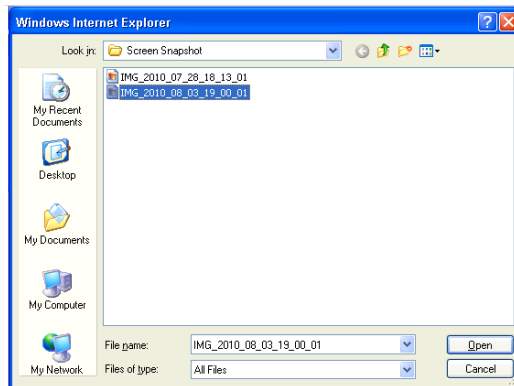



- 2c. Tap **Open** to load the file in Internet Explorer.
  - 2d. Tap **OK** to confirm.
3. From the menu, select **File > Print**.

4. From the **General** tab, select the desired printer (PDFCreator by default).
5. If necessary, tap **Preferences** to adjust the parameters to your needs.

**Note:** *If you selected a network printer, you can save the whole set of preferences for future use with the **Save As** button.*

6. Tap **Print** to start the printing process.
7. If you selected PDFCreator, proceed as follows:
  - 7a. Enter the desired information. If you want to view the PDF file immediately after its creation, select the **After saving open the document with the default program** check box.

To view the PDF file immediately after its creation

- 7b. Tap **Save**.
- 7c. Specify a location and a file name and tap **Save**.  
If you have selected the option to view the PDF file after its creation, the SumatraPDF reader will display the new file.
- 7d. If necessary, tap  to close the SumatraPDF window.
8. Tap  to close Internet Explorer and return to the **Utilities** tab.

## Working with Your Unit

### Viewing PDF Files

---

## Viewing PDF Files

You can view PDF files directly from your unit using the SumatraPDF reader. For more information on the available features for this reader, refer to the SumatraPDF online help.

### **To view PDF files:**

1. From **Main Menu**, select **File Manager**.
2. Browse through the folders to find the desired PDF file.
3. Double-tap the file.
4. The file opens automatically in the SumatraPDF application.

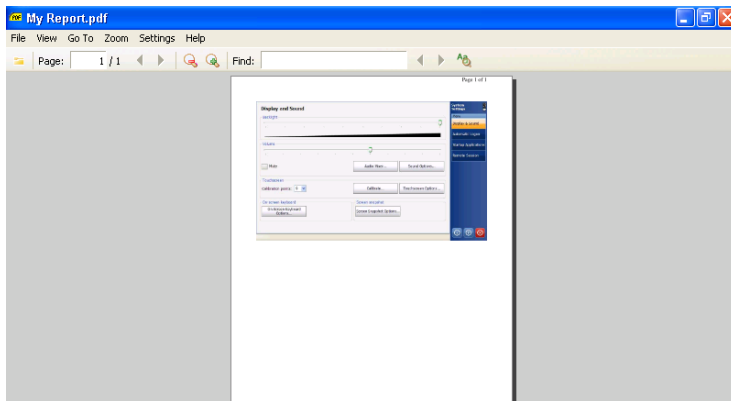

**Note:** You can access the online help directly from the **Help** menu of the SumatraPDF application. You will need a connection to the Internet to view the online help.



## Taking Screen Captures

You can take captures of what is displayed on your screen, directly from your unit. This could be useful for troubleshooting when you need another person to have a look at a specific configuration or problem. You could also use this tool for training purposes.

If you want to capture images of the fibers that you examine with the fiber inspection probe, you can use the capture feature of the probe instead.

For more information on how to modify the default file format and destination folder, see *Setting Storage Parameters for Screen Captures* on page 240.

- Images are saved using the defined file format. By default, images are created in .bmp format, but you can modify this parameter. By default, they are kept in the following folder:

*D:\Documents and Settings\Supervisor\My Documents\Screen Snapshot*

It is possible to modify the folder in which images are automatically saved.

## Working with Your Unit

### Taking Screen Captures

---

- By default, the application generates file names as follows:

IMG\_[YEAR]\_[MONTH]\_[DAY]\_[HOUR]\_[MINUTE]\_[SEQUENTIAL NUMBER].bmp

Example:

For a screen capture taken on August 20, 2010, the file name could be:



IMG\_2010\_08\_20\_13\_23\_01.bmp.

**Note:** *The HOUR value will appear in a 24-hour format, regardless of your unit's time settings.*

**Note:** *The SEQUENTIAL NUMBER value is used to differentiate two captures that would have been taken at the same date and time.*

- There are two ways to capture images: a quick mode (the screen capture tool is automatically closed as soon as the capture is made) and a multiple-capture mode (the screen capture button is part of a floating toolbar that remains available until you close it). By default, this toolbar is located in the lower-right corner of the screen. However, you can move it to a location that better suits your needs.





#### **To take only one screen capture:**

From the unit's keypad, press the /  button and hold it down for about 3 seconds.

The screen capture is automatically taken as soon as you release the button (a sound and visual effect typical of a camera taking a picture indicate that the capture is complete).

**Note:** *If a keyboard is connected to your unit, you can also press the PRINT SCREEN key.*

#### **To take several screen captures:**

1. From the unit's keypad, press the /  button.
2. Once the on-screen keyboard is displayed, tap the  button.
3. From the floating toolbar, tap the  button.

The screen capture is automatically taken (a sound and visual effect typical of a camera taking a picture indicate that the capture is complete).

## Setting Storage Parameters for Screen Captures

You can modify the file format of the screen captures as well as the destination folder, that is the folder to which the captures will be sent.

- By default, images are saved in .bmp format, but you can configure the application to save them in .jpg or .png format.
- By default, images are kept in the following folder:

*D:\Documents and Settings\Supervisor\My Documents\Screen Snapshot*

You can select any other folder as the destination either locally on your unit, on a USB memory key.

**Note:** *If the specified folder is no longer available (folder name has been modified, folder has been deleted), the screen captures will be sent to the default folder. Similarly, if you have defined a destination folder on a USB key and this key is not connected to your unit when you take screen captures, the latter will be sent to the default folder.*

#### To set the default image format:

1. From the Main Menu, tap **System Settings**.
2. If necessary, from **System Settings**, tap **Display & Sound**.

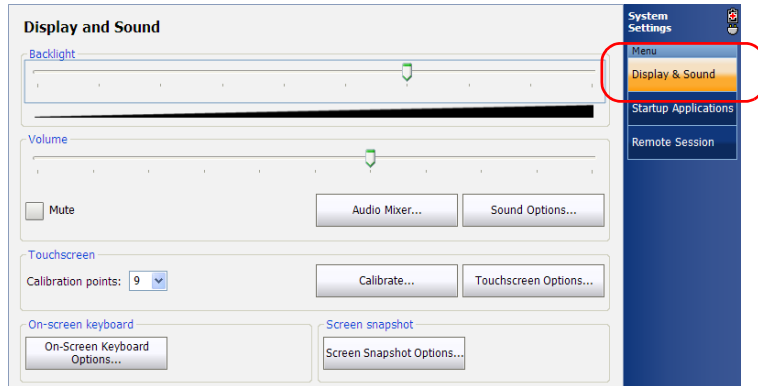

3. Under **Screen snapshot**, tap the **Screen Snapshot Options** button.
4. Under **Image format**, select the option corresponding to the desired format.

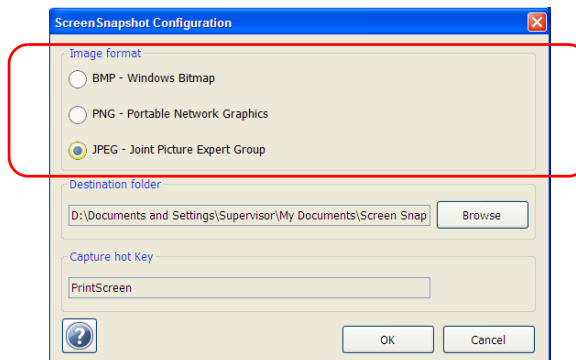

5. Tap **OK** to confirm the changes and close the window.

## Working with Your Unit

### Setting Storage Parameters for Screen Captures

#### To modify the destination folder:

1. From the Main Menu, tap **System Settings**.
2. If necessary, from **System Settings**, tap **Display & Sound**.

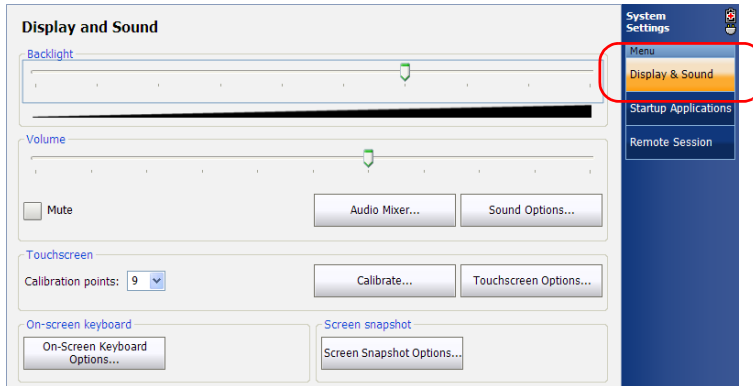

3. Under **Screen snapshot**, tap the **Screen Snapshot Options** button.
4. Under **Destination folder**, tap **Browse**.

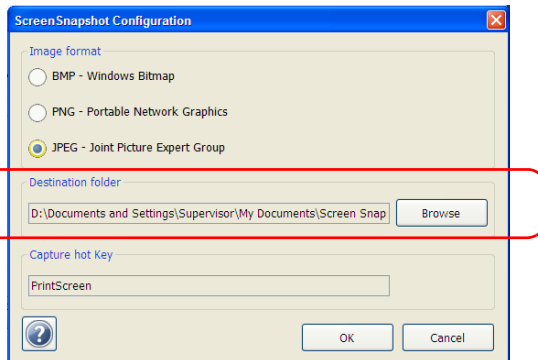

5. From the **Browse for Folder** window, select the folder that you want to use to store the screen captures. If necessary, you can create a folder.



6. When your selection is made, tap **OK**.
7. Tap **OK** to confirm the changes and close the window.

## Reading Audio and Video Files

Your unit is equipped with the VLC media player which enables you to read audio files and to view video files (such as .avi and .divx). This could be especially useful if your company wants to use multimedia files for training. The player can read files that are stored on your unit, on a USB memory key, on a network folder, or even on a Web site.



### **IMPORTANT**

The VLC media player does not support the Flash format. If you want to read files in this format, you will need to install the Adobe Flash Player application (see *Installing Adobe Flash Player on Your Unit* on page 246).

For more information on how to configure the language of the media player, see *Selecting the Language of Operation* on page 215.

For more information on how to use the video player, refer to the VideoLAN online help.



**To read video or audio files:**

- 1.** From the MAX-700 software, select **File Manager**.
- 2.** Locate the video or audio file that you want to read.
- 3.** Double-tap the file.

The media player starts reading automatically if the file format is recognized.

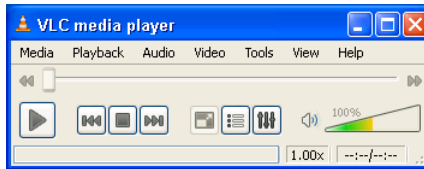

**Note:** *You can access the online help from the **Help** menu of the VCL Media Player application. You will need a connection to the Internet to view the online help.*

## Installing Adobe Flash Player on Your Unit

The Adobe Flash Player application is not installed on your unit by default, but you can install it if you need to read files in Flash format.



### **IMPORTANT**

**EXFO does not provide licenses for Adobe Flash Player. Contact Adobe to purchase a license that will entitle you to install Flash Player on your unit.**

To download the installation files, you will need a connection to the Internet. You can either download the files directly to your unit or to a computer (and transfer them to your unit later using a USB key).



## **IMPORTANT**

Ensure to download the latest installation package for the 32-bit version of Flash Player for Windows (operating system), and Internet Explorer (browser). You should retrieve the EXE installer component.

***To install Adobe Flash Player on your unit:***

- 1.** If necessary, turn on your unit.
- 2.** From your computer or your unit, open a Web browser and go to [http://www.adobe.com/special/products/flashplayer/fp\\_distribution3.html](http://www.adobe.com/special/products/flashplayer/fp_distribution3.html).
- 3.** Locate the most recent version of Flash Player 32 bits.
- 4.** Under Flash Player 32 bits, locate the entry corresponding to Windows (operating system) and Internet Explorer (browser).
- 5.** Save the corresponding *EXE installer* to a location of your choice (on a USB memory key connected to your computer or on your unit).
- 6.** If you have downloaded the file to a USB key, connect the key to your unit.
- 7.** Double-tap the downloaded file, and follow the on-screen instructions.

**Note:** *At this point, if you have used a USB memory key to transfer the installation files to your unit, you can remove it.*

You are now ready to read files in Flash format.

## Browsing the Web

You can browse the Web directly from your unit, provided that you have access to an Internet connection.

If you need to modify the Internet options, see *Configuring the Internet Options* on page 231.

### **To browse the Web:**

1. Open a Web browser as follows:
  - 1a. From the MAX-700 software, select the **Utilities** tab.
  - 1b. Tap the **Internet Explorer** icon to open the browser.

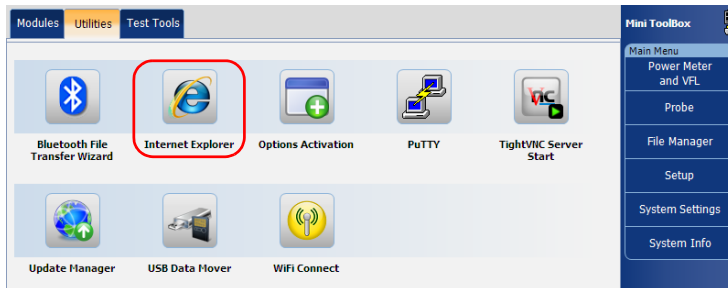

2. Enter the desired Web address in the address bar and tap the  button (located at the right of the address bar) to start browsing.

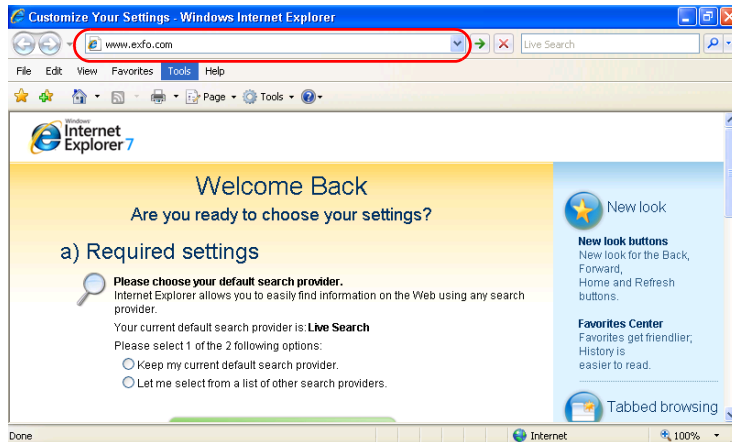

3. Close the window to return to the **Utilities** tab.

## Accessing Other Tools

Your unit comes with free tools such as Wireshark to help you troubleshoot networks. For more information, refer to the online help provided with these tools.

If you want one or more of these tools to start automatically at unit startup, see *Selecting the Startup Application* on page 210.

### **To access tools:**

1. From the MAX-700 software, select the **Test Tools** tab.
2. Tap the icon corresponding to the tool that you want to use.



# 16 Using the Optional Built-In Power Meter and VFL

The MAX-700 can be equipped with an optical power meter to measure absolute power (dBm or W) or insertion loss (dB). The power meter can detect modulated signals (1 kHz, 2 kHz, and 270 Hz).

The MAX-700 can also include a visual fault locator (VFL) to inspect or identify fibers.

For more information on how to use the power meter or the VFL, refer to the power meter online help.

**Note:** *The appearance of your application may vary depending on the options that you have purchased. The illustrations presented hereafter show the application as it appears when the unit is equipped with a built-in power meter and a VFL.*

## **To access the built-in power meter or the VFL:**

From the MAX-700 software, tap **Power Meter and VFL**.

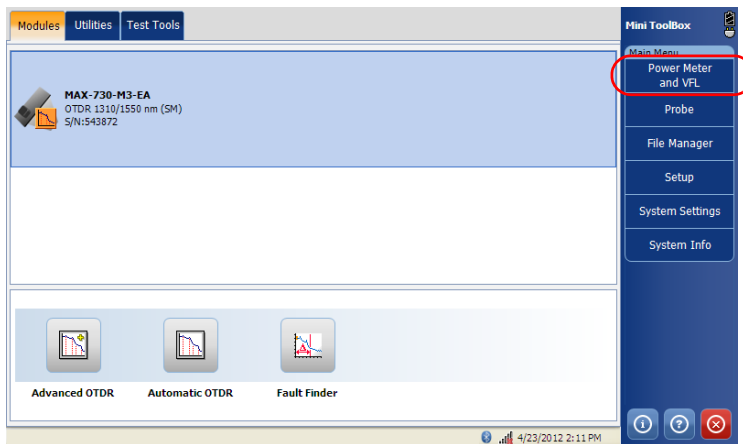

**Note:** *You can access the online help of the power meter and the VFL by tapping the  button from the power meter application.*





# 17 Inspecting Fibers with a Probe

The fiber inspection probe (FIP) is used to find dirty or damaged connectors by displaying an enlarged view of the connector surface. You can connect an FIP to your unit to view fiber ends.

Fiber inspections are made using the ConnectorMax application. Most of the features included in the ConnectorMax application are free. However, if you want to use specific test configurations and analyze the fibers automatically upon capturing a picture, you must purchase the corresponding option.

For more information, refer to the ConnectorMax online help.

## **To inspect fibers with a probe:**

1. Connect the probe to the probe port on the top panel of your unit, using an adapter if necessary. *You cannot connect the probe directly to the USB port.*
2. From the **Main Menu**, tap **Probe** to start the ConnectorMax application.

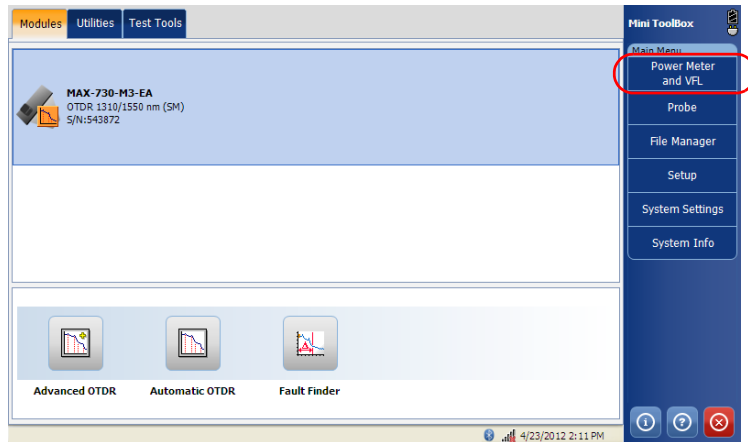

**Note:** You can access the online help by tapping the  button from the ConnectorMax application.



## 18 ***Managing Data***

You can copy, move, rename, delete files and folders directly on your unit.

You can transfer files from your unit to a USB memory key or a computer.

You can also transfer data from a storage device or a computer to your unit.

Your unit is equipped with the following ports and devices for data transfer:

- Two USB 2.0 ports to connect a memory key or a USB to RS-232 adapter (see *Using the USB to RS-232 Adapter* on page 271.)
- an Ethernet port to connect to a network (for transfer via VNC - see *Accessing Your Unit Remotely* on page 287)
- internal Wi-Fi device (optional) to connect to a wireless network
- internal Bluetooth device (optional) to transfer data via Bluetooth.

**To view the free disk space on your unit:**

1. From **Main Menu**, tap **System Info**.
2. Select **Platform**.

The free disk space is displayed next to the **Available Flash on “D:\ (APP)”** item.

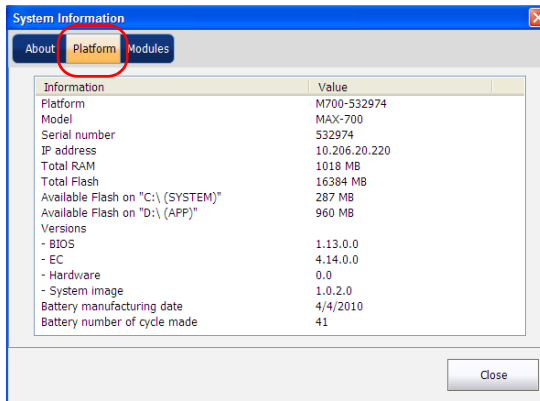

3. When you have finished, tap **OK** to close **System Information**.

**To manage files or folders on your unit only:**

From **Main Menu**, select **File Manager**.

**To transfer files or folders between your unit and a USB memory key:**

1. Connect the USB memory key to the USB port.
2. From **Main Menu**, select **File Manager**.

The list of available drives and folders should include the memory key (**Removable Disk**). You can now manage your files and folders as you wish.

**Note:** *If you do not see the memory key, close File Manager and reopen it. You can also use the **Refresh** option from the **View** menu.*

3. When you have finished, remove the memory drive.

**Note:** *You can also use the USB Data Mover application to easily transfer files and folders to a USB key (see Transferring Files with the USB Data Mover Application on page 278).*

## Transferring Data via Bluetooth

If your unit is equipped with the optional Bluetooth device (internal), you can transfer data between your unit and a computer using the Bluetooth technology. By default, both the Bluetooth and Wi-Fi devices are enabled, but not connected to a network.

If you have disabled the devices, you must enable them before trying to transfer data via Bluetooth (see *Enabling or Disabling the Bluetooth and Wi-Fi Devices* on page 276).

The computer that you use must run Windows XP SP3 or later; otherwise, there could be problems during data transfer. The computer must also be equipped with a Bluetooth device and be configured properly.

**Note:** *If you prefer to use devices such as BlackBerry smartphones instead of a computer for data transfer, you must ensure that they are Bluetooth-compatible and configured properly. Some devices only allow data transfer between devices of the same make. In this case, you will need to use another type of device or a standard computer to transfer data from your MAX-700 unit.*

Your unit must be located within a 9-meter area from your computer (limitation of the Bluetooth technology).

If you need to transfer large files (more than 1 Gb), use a USB key, or connect to a Wi-Fi or an Ethernet network.



## IMPORTANT

Depending on the operating system that your computer is running, it is possible that only data transfer secured with a passkey be allowed.

Since your unit cannot receive data secured with passkeys, in such a case, data transfer would only be possible *from your unit to the computer*.

The procedure presented hereafter explains how to transfer data from your unit to a computer. Data transfer from the computer to your unit is similar, except that data will be sent using the Bluetooth Transfer Wizard of the computer (*Send a file* option) and received by the unit (*Receive a file* option).

## Managing Data

### Transferring Data via Bluetooth

#### To transfer data via Bluetooth:

1. Configure your unit as follows:
  - 1a. From the **Main Menu**, tap **Setup**.
  - 1b. Double-tap **Bluetooth Devices**.

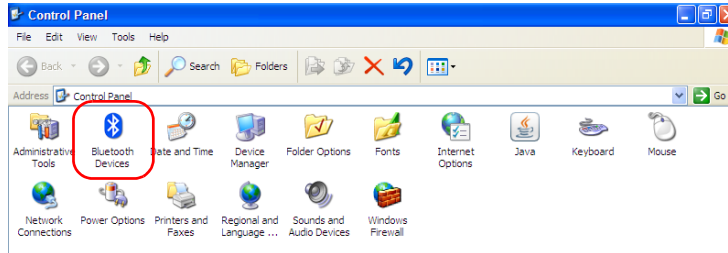

- 1c. From the **Options** tab, under **Discovery**, select the **Turn discovery on** check box.

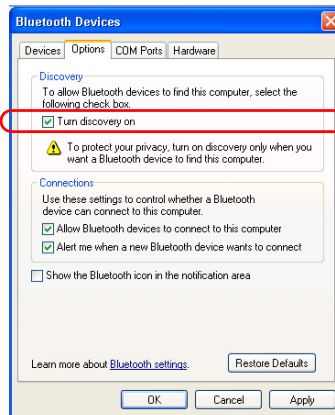

- 1d. Ensure that the **Allow Bluetooth devices to connect to this computer** check box is selected.
  - 1e. Tap **OK** to confirm.



2. Configure the computer as follows:
  - 2a. On the computer, from **Control Panel**, double-click **Bluetooth Devices**.
  - 2b. From the **Options** tab, under **Discovery**, select the **Turn discovery on** check box.
  - 2c. Ensure that the **Allow Bluetooth devices to connect to this computer** check box is selected.
  - 2d. Tap **OK** to confirm.
3. On the computer, click the Bluetooth icon (located on the taskbar) and select **Receive a file**.
4. On your unit, from the MAX-700 software, select the **Utilities** tab.

## Managing Data

### Transferring Data via Bluetooth

---

#### 5. Tap **Bluetooth File Transfer Wizard**.

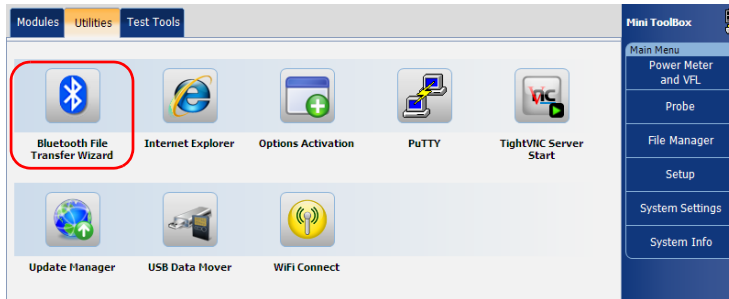

#### 6. From the **Welcome** window, tap **Next**.

#### 7. Select **Send a file** and tap **Next**.

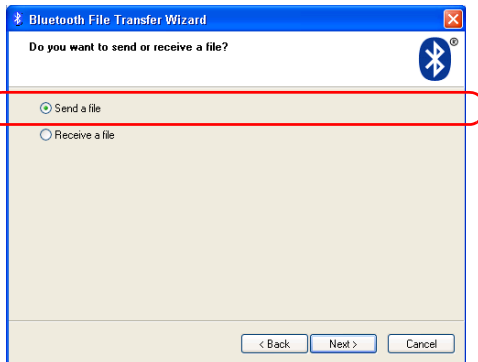

8. Select the computer to which you want to transfer data as follows:

8a. Tap **Browse**.

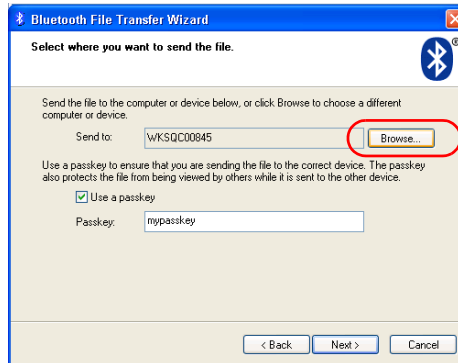

8b. Select the desired computer, and then tap **OK** to confirm.

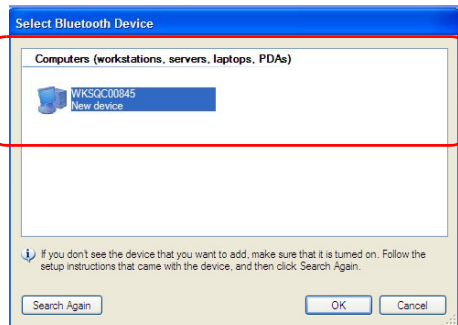

## Managing Data

### Transferring Data via Bluetooth

---

9. If you want to use a passkey, select the corresponding check box and enter the passkey.

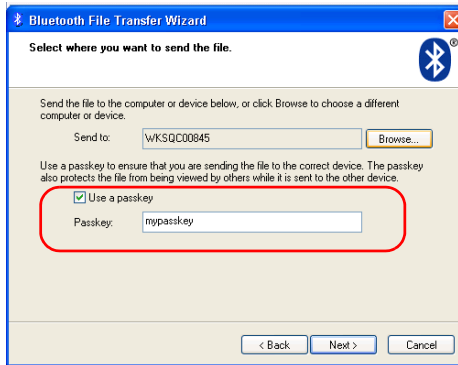

When you have finished, tap **Next**.

10. Tap **Browse** to select the file that you want to send to the computer.

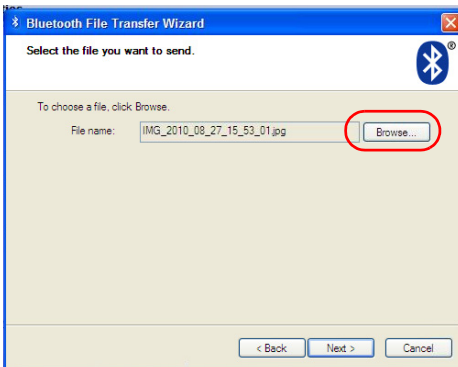

11. Select the file, tap **Open** to confirm, and then **Next**.

- 12.** On the computer, when the application prompts you, allow the connection and enter the passkey if necessary.

**Note:** *Once you have established a secured connection using a passkey, this passkey is kept in memory both on your unit and on the computer until you remove this connection (**Setup** > **Bluetooth Devices** > **Devices**) or change the passkey.*

- 13.** On the computer, click **Finish**.
- 14.** From the Bluetooth File Transfer Wizard on your computer, if necessary, modify the name of the received file and the storage location. Click **Next** to save the file. Click **Finish** to close the wizard.
- 15.** On your unit, tap **Finish** to close the Bluetooth File Transfer Wizard.

## Connecting to a Wireless Network

If your unit is equipped with the optional Wi-Fi device (internal), you can connect to a wireless network and benefit from all resources that are available on this network. You can transfer data exactly as you would do from an Ethernet network. By default, both the Bluetooth and Wi-Fi devices are enabled, but not connected to a network.

If you have disabled the devices, you must enable them before trying to connect to a wireless network (see *Enabling or Disabling the Bluetooth and Wi-Fi Devices* on page 276).

### **To connect to a wireless network:**

- 1.** If it is not already done, share all the required folders both on your unit and on your computer. If you are not sure on how to proceed, see with your network administrator.
- 2.** If it is not already done, configure the firewall as follows:
  - 2a.** From **Main Menu**, tap **Setup**.
  - 2b.** Double-tap **Windows Firewall**.

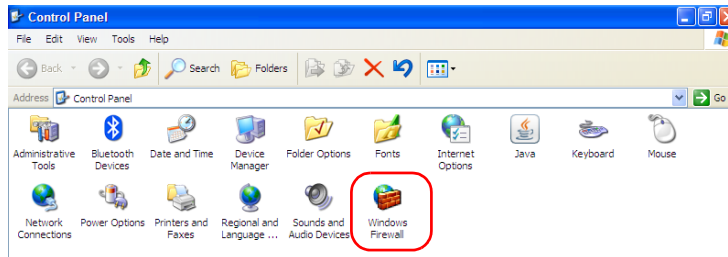

- 2c.** Select the **Exceptions** tab.

- 2d. Ensure that the **File and Printer Sharing** item is selected.

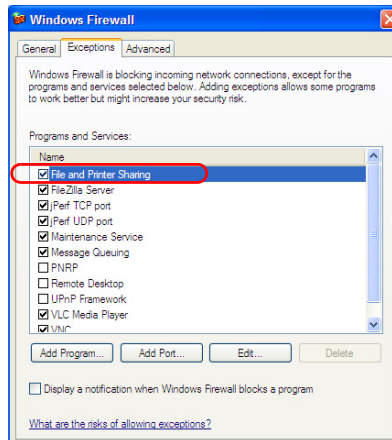

- 2e. Tap **OK** to confirm.

3. On your unit, from the MAX-700 software, select the **Utilities** tab.

4. Tap **WiFi Connect**.

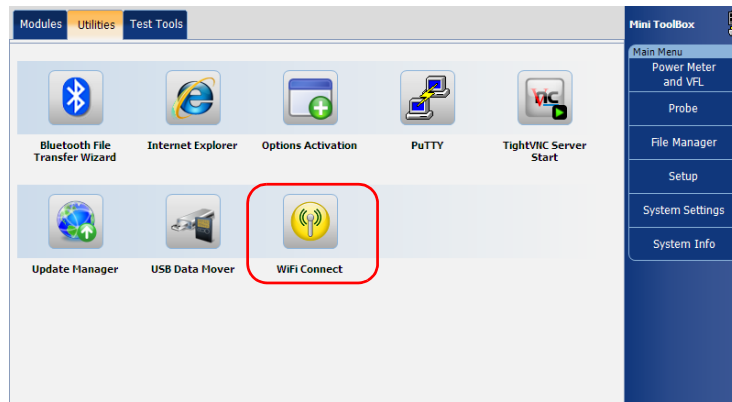

5. Tap **OK** to acknowledge the message on how to display the list of wireless networks.

# Managing Data

## Connecting to a Wireless Network

### 6. Double-tap **Wireless Network Connection**.

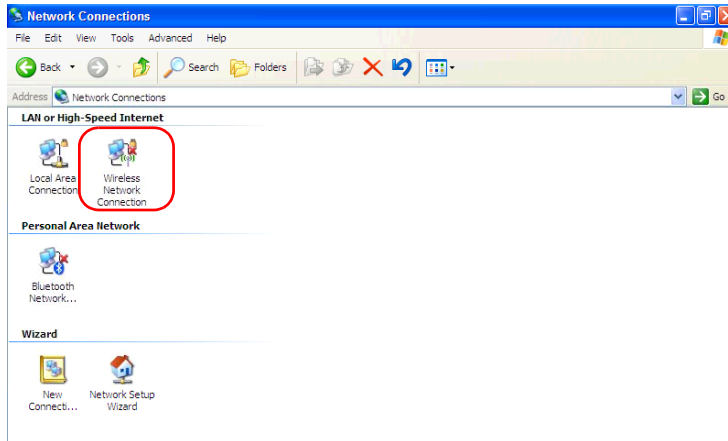

### 7. If your unit is already connected to a wireless network, tap **View Wireless Networks** to display the list of wireless networks.

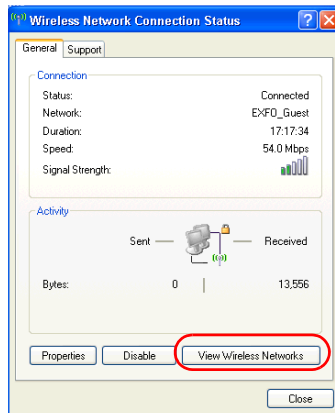



- From the **Wireless Network Connection** window, select the wireless network to which you want to connect.

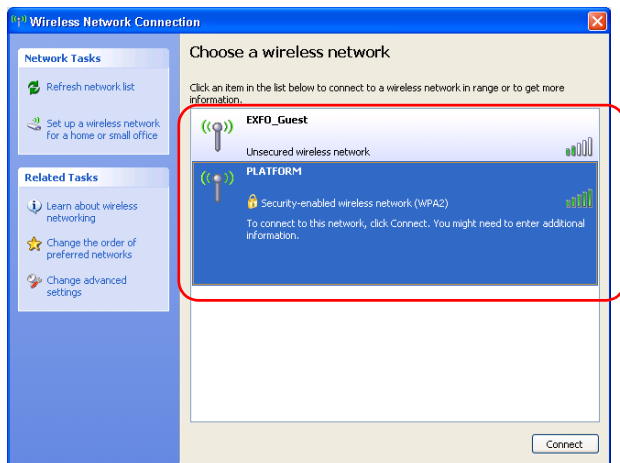

- Tap **Connect**.

## Managing Data

### Connecting to a Wireless Network

---

10. If the network is protected by a network key (password) enter it in the corresponding boxes and tap **Connect**.

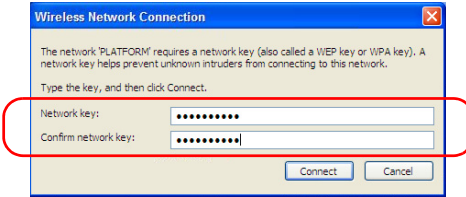

**Note:** *Since all networks are different, you may also need to configure other parameters before being able to transfer data via Wi-Fi. For information on the configuration specific to your network, see with your network administrator.*

As soon as the connection is established, you can start working with the selected wireless network. When you have finished, from the **Wireless Network Connection** window, tap **Disconnect** to stop communication with the wireless network.

## Using the USB to RS-232 Adapter

If you want to transfer data between your unit and a device that is only equipped with RS-232 (serial) ports, you have to use a USB/RS-232 adapter.



### **IMPORTANT**

**Only the USB/RS-232 adapters sold by EXFO are supported.**

Once the adapter has been detected, the unit assigns it a COM port number (values begin at COM 3). This COM port number is kept in memory even when you turn the unit off. This means that next time you connect the same adapter to any of the USB ports, the unit will recognize the adapter and identify it with the saved COM port number.

The communication between your unit and the device is established using the PuTTY application.

## Managing Data

### Using the USB to RS-232 Adapter

---

#### **To use the USB/RS-232 adapter:**

1. Turn on both the unit and the serial device.
2. Connect as shown. You can connect the USB end of the adapter to any of the USB ports.

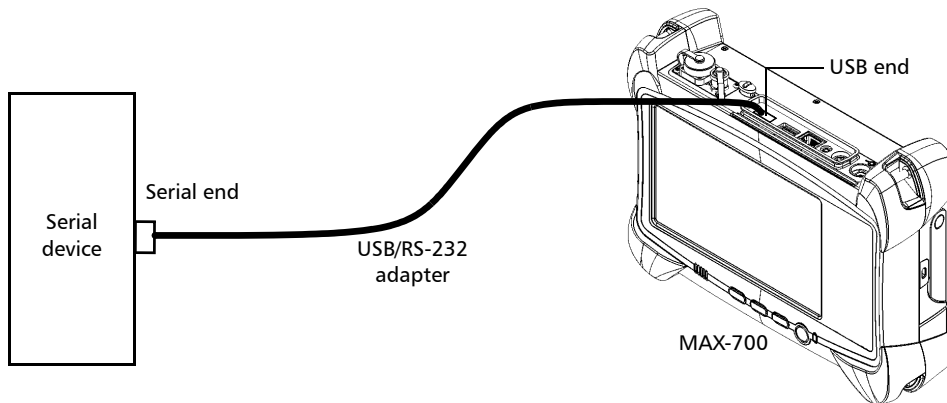

**Note:** *If the device that you want to use is a computer (not equipped with USB ports) you may want to use a null-modem serial cable as an “extension cable” between the device and the USB/RS-232 adapter.*

The adapter will be detected automatically on your unit.

**3.** From your unit, retrieve the COM port of the adapter as follows:

**3a.** On your unit, from the **Main Menu**, select **Setup**.

**3b.** Double-tap **Device Manager**.

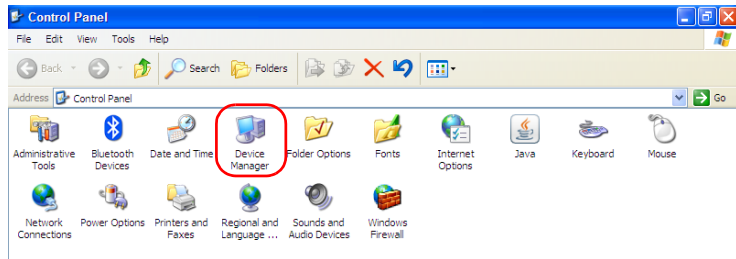

**3c.** Expand the **Ports (COM & LPT)** list to retrieve the COM port number that has been assigned to the adapter and write it down.

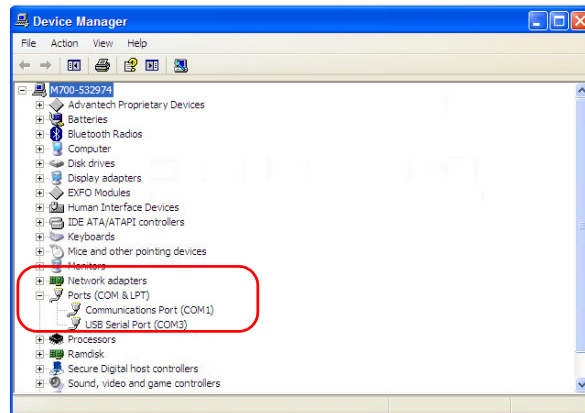

**3d.** Close the *Device Manager*.

# Managing Data

## Using the USB to RS-232 Adapter

- 4. From your unit, configure the communication parameters as follows:
  - 4a. From the MAX-700 software, select the **Utilities** tab, then tap **PuTTY**.
  - 4b. Configure the parameters.

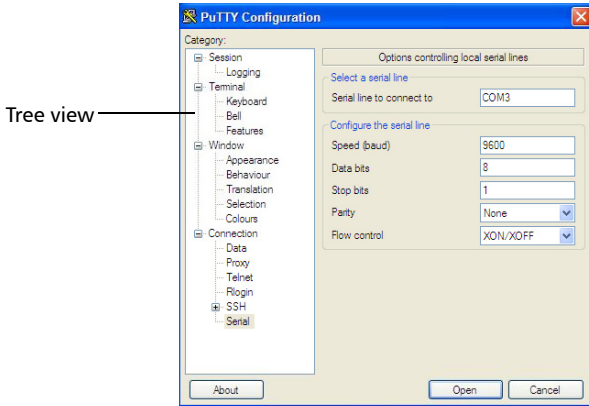

- From the tree view, select **Connection** > **Serial** and set the parameters as needed. Ensure that the COM port that you specify corresponds to the one that you wrote down at step 3c.
  - If you want to view the characters that you type on screen, from the tree view, select **Terminal**. Under **Local echo**, set the value to **Force on**.
  - From the tree view, select **Session**. Select **Serial**. The COM port number and the speed should correspond to those that you have previously entered.
- 4c. Tap **Open**. The unit is now ready to receive or send data.

5. From the device, set the communications parameters.



### IMPORTANT

To be able to establish a communication between the unit and the device, you must set the following parameters to the same values as those defined on your unit:

- Speed
- Data bits
- Stop bit
- Parity
- Flow control

**Note:** *The COM port number that you set on your device will probably differ from the one that you used on your unit.*

6. From the device, establish communication with the unit using your favorite communication tool (PuTTY, HyperTerminal, etc.).

## Managing Data

### *Enabling or Disabling the Bluetooth and Wi-Fi Devices*

# Enabling or Disabling the Bluetooth and Wi-Fi Devices

By default, both the Wi-Fi and Bluetooth devices are enabled on units that are equipped with the corresponding options.

If you do not intend to transfer files via Bluetooth or to work with a wireless network for a certain period of time, you may wish to disable the devices to extend battery life.

As soon as you disable the Wi-Fi device, the Bluetooth is automatically disabled as well.

You can enable the devices again at any time.

#### ***To enable or disable the Bluetooth and Wi-Fi devices:***

1. From the **Main Menu**, tap **Setup**.
2. Double-tap **Network Connections**.

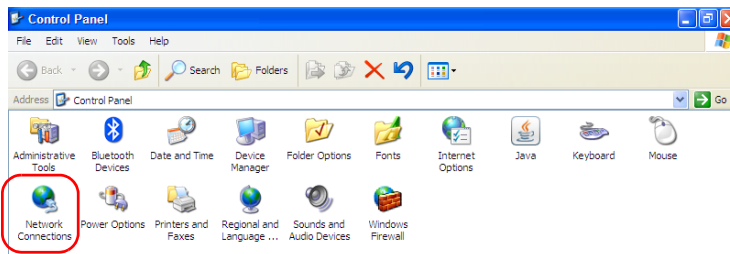



#### 3. Select **Wireless Network Connection**.

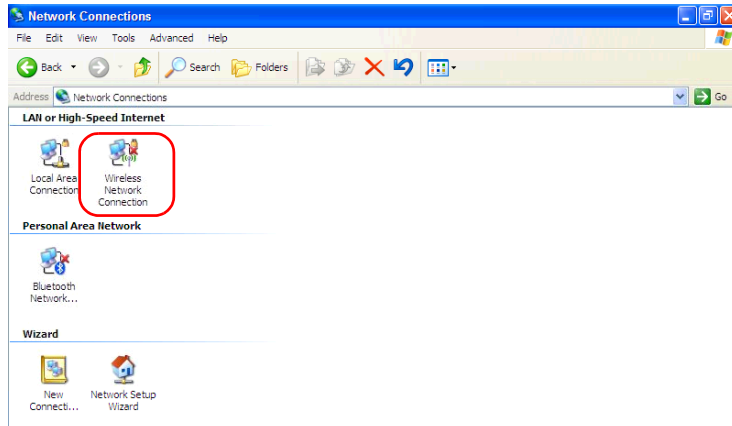

#### 4. From the **File** menu, select **Enable** or **Disable**, according to your needs.

# Transferring Files with the USB Data Mover Application

With the USB Data Mover application, you can copy folders and files from your unit to a USB storage device quickly.

You can retrieve files from the predefined source folders or specify your own folders.

The predefined folders are:

- My Documents, which path is *D:\Documents and Settings\Supervisor\My Documents*
- Shared Documents, which path is *D:\Documents and Settings\All Users\Shared Documents*.

**Note:** *You cannot remove the predefined folders from the list of source folders, but you can remove the ones that you have added.*

By default, the application retrieves the files from all the folders appearing on the list of source folders. However, you can specify which folders you want to take into account.

Each time you copy data, the application creates a folder on the storage device. This folder will contain the copied files and subfolders (original folder structure as well as folder and file names are kept).

The application generates folder names as follows:

[YEAR]-[MONTH]-[DAY]\_[HOUR]-[MINUTE]-[SECOND]

Example:

For a copy operation requested on September 20, 2010, the folder name could be:

2010-09-20-13\_23-01-45.

**Note:** *The HOUR value will appear in a 24-hour format, regardless of your unit's time settings.*

#### **To transfer files with the USB Data Mover:**

1. Connect a USB storage device to one of the USB ports.
2. From the MAX-700 software, select the **Utilities** tab.
3. Tap **USB Data Mover**.

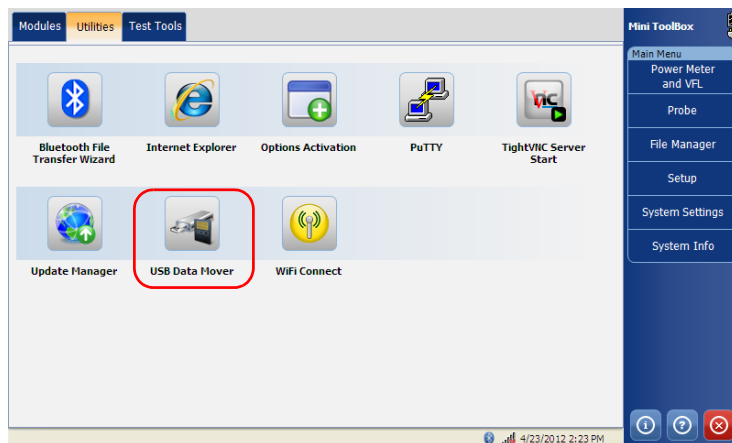

## Managing Data

### Transferring Files with the USB Data Mover Application

4. Select or clear the check boxes to adjust the folder selection to your needs.



5. If necessary, under **Destination media**, select the desired USB storage device.
6. Tap **Copy**. The files will remain on your unit after the transfer.
7. When you have finished, tap  to exit the USB Data Transfer application.

#### **To manage the list of source folders:**

1. From the MAX-700 software, select the **Utilities** tab.
2. Tap **USB Data Mover**.

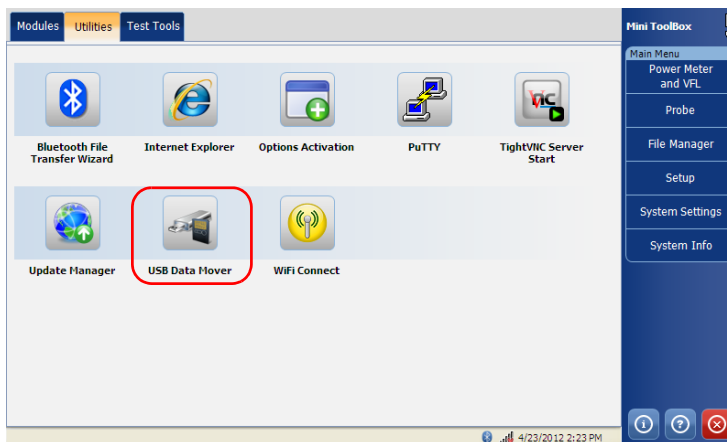

3. Tap **User Preferences**.

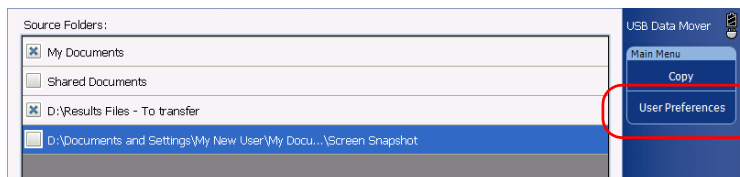

## Managing Data

### *Transferring Files with the USB Data Mover Application*

4. If you want to add your own folders to the list of source folders, proceed as follows:

- 4a. Tap Add a Folder.**

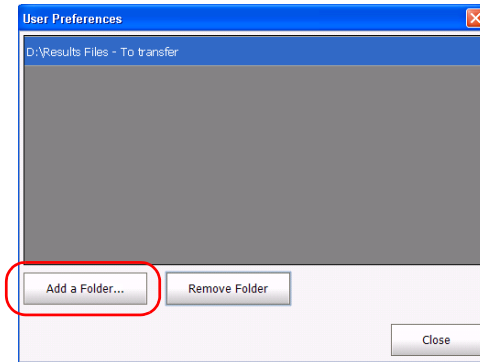

- 4b. Select the desired folder, and then tap OK.**

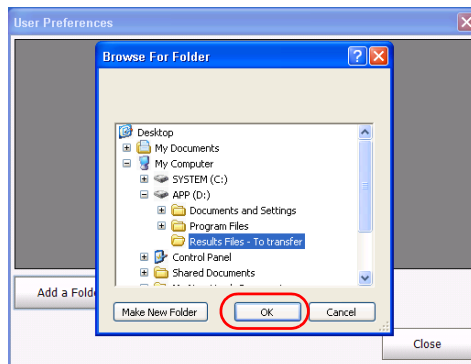

5. If you want to remove folders from the list of source folders, proceed as follows:

- 5a. Select the folder that you want to remove.

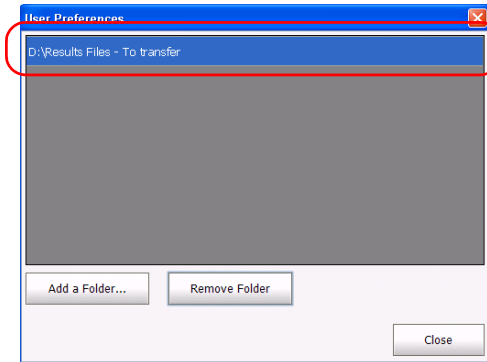

- 5b. Tap **Remove Folder**.

**Note:** *The application will not prompt you to confirm the removal of the folder from the list.*

6. When you have finished, tap **Close**. Your changes are reflected automatically. All the newly added folders are selected by default.
7. Tap  to exit the USB Data Transfer application.

### Using Your Unit as an FTP Server

The use of your unit as an FTP server requires the installation of an FTP server (FileZilla Server) on your unit and the installation of the corresponding FTP client (FileZilla Client) on your computer.

Both applications are provided on the DVD that came with your unit. If you need information on these applications or on how to transfer files via an FTP server, refer to online help provided with these applications. You will need a connection to the Internet to view the online help.

**Note:** *You will need a computer (equipped with a USB port) and a USB key to install the FTP server application on your unit.*

#### **To install the FTP server application on your unit:**

1. If necessary, turn on both your computer and your unit.
2. Insert the installation DVD into the CD/DVD drive of your computer.
3. Connect a USB memory key to one of the USB ports of the computer.
4. From the DVD **Main Menu**, click **Installation Files and Tools**.
5. Select the **FTP Server** check box and click **Next**.
6. Follow the on-screen instructions. All the necessary components will be copied to your USB key.
7. When the operation is complete, click **Close**, and then **Exit** to close the installation DVD window.
8. Disconnect the USB memory key from the computer and connect it to one of the USB ports of your unit.



- 9.** On your unit, create a folder on the Windows desktop.
- 10.** Copy the installation files (from the USB key) to the newly created folder.
- 11.** From the newly created folder, tap the *.exe* file to start the installation.
- 12.** Follow the on-screen instructions.
- 13.** When the installation is complete, simply disconnect the USB memory key.

You are now ready to use your unit as an FTP server.

***To install the FTP client application on your computer:***

- 1.** If necessary, turn on your computer.
- 2.** Insert the installation DVD into the CD/DVD drive of your computer.
- 3.** From the DVD **Main Menu**, click **Desktop Utilities**.
- 4.** Click **FileZilla Client** to start the installation.
- 5.** Follow the on-screen instructions.

You are now ready to use the FTP client application from your computer.



# 19 **Accessing Your Unit Remotely**

You can access your unit remotely from a computer using the TightVNC Client application.

The table below presents the characteristics of this application.

<b>Characteristic</b>	<b>TightVNC Client</b>
Type of connection	Not exclusive; several users can be connected to the unit at the same time (sharing the same session).
Windows user rights	Not taken into account.
Password-protected	Yes; mandatory. The password is defined on the TightVNC Server, the first time you start the server. This password is not related to the one used to connect to the unit. By default, all people that use TightVNC Client will enter the same password (as defined on the server).  Each user to whom you provide the password will be able to connect to the unit via TightVNC.

## Working With TightVNC

The control of your unit with TightVNC requires the TightVNC Server (already installed on your unit) and the TightVNC Client Viewer (that you must install on your computer).

The first time you start the TightVNC Server on your unit, the application will prompt you to define passwords. Once these passwords are defined, you are now ready to connect to your unit using the TightVNC Client (on your computer).

If you want TightVNC Server to start automatically when you turn on your unit, see *Configuring TightVNC Server to Start Automatically* on page 294.



### **IMPORTANT**

The passwords that you set for the application that is started automatically are independent of the passwords that you set for the application that you start manually (via the Utilities tab). This means that you could need to enter different passwords, depending on which TightVNC application you use to connect to your unit.

If you do not want to manage two different sets of passwords, you can set all passwords to the same value.



### CAUTION

Be very careful if you use TightVNC to transfer files between a computer and your unit (TightVNC Server).

- *Transfer from a computer to your unit:* If the transfer is interrupted, all files on your unit having the same name as those on the computer **WILL BE DELETED**. However, the files on the computer will remain available.
- *Transfer from your unit to a computer:* If the transfer is interrupted, all files on the computer having the same name as those on your unit **WILL BE DELETED**. However, the files on your unit will remain available.

To be able to connect to the unit using TightVNC, you must:

- Know the IP address of the unit and provide it in the connection settings on the computer.
- Know the password (same for all users by default).

This section provides you with the basic information to control your unit with TightVNC. For more information, refer to the TightVNC online help.

## Accessing Your Unit Remotely

Working With TightVNC

### Configuring the TightVNC Server

The TightVNC Server is already installed on your unit. You must configure passwords before establishing a connection between a computer and your unit.

#### To configure the TightVNC Server:

1. If you have configured TightVNC Server to start automatically when you turn on your unit, go directly to step 2. Otherwise, from the MAX-700 software, select the **Utilities** tab, then tap **TightVNC Server Start**.

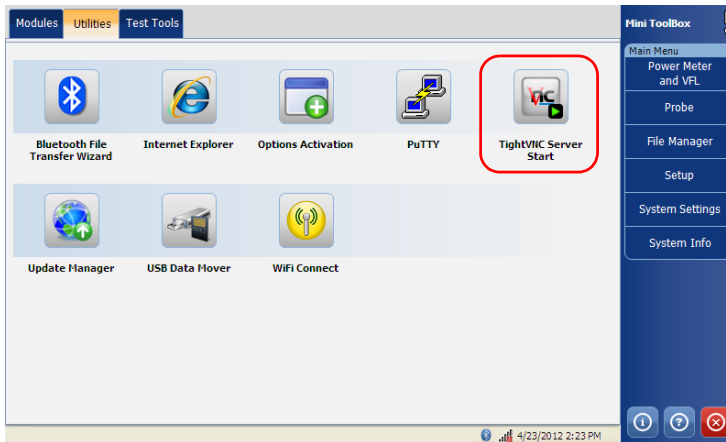

2. Select the **Server** tab.

3. In the **Primary password** and **View-only password** boxes, type the desired passwords.

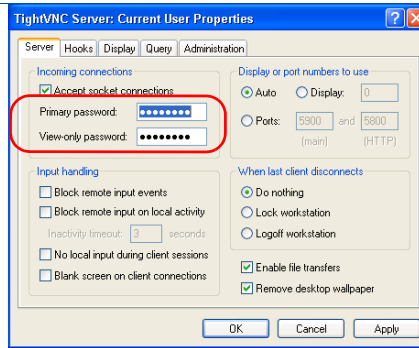

**Note:** *The two passwords are independent of each other. They do not have to be identical.*

4. Tap **Apply**, and then **OK**.

### Installing the TightVNC Viewer on a Client Computer

If the TightVNC Viewer is not already installed on your computer, you can install it with the DVD that came with your MAX-700.

***To install the TightVNC Viewer on your computer:***

1. Insert the installation DVD into the CD/DVD drive of your computer.
2. From the DVD **Main Menu**, click **Desktop Utilities**.
3. Click **VNC Client** to start the installation.
4. Follow the on-screen instructions.

### Connecting to Your Unit with TightVNC

Once the TightVNC Viewer is installed on your computer, you are ready to access your unit remotely.

***To connect to your unit with TightVNC:***

1. Connect both the computer and your unit to the same network and make sure they can “see” each other as network restrictions might prevent them from communicating.
  - If you want to use an Ethernet network, connect an RJ-45 (network) cable to the unit’s RJ-45 port located on its top panel.
  - If you want to use a wireless network, see *Connecting to a Wireless Network* on page 266.
  - You can also create a Private Area Network with your Bluetooth device (see *Transferring Data via Bluetooth* on page 258).
2. Turn on both the computer and the unit.
3. On your unit, in the MAX-700 software, go to **Main Menu**. Select **System Info > Platform**.



4. Write down the IP address, and then close the window.

**Note:** It may take a few seconds before you see the IP address on the list.

5. If you have configured TightVNC Server to start automatically when you turn on your unit, go directly to step 6. Otherwise, from the MAX-700 software, select the **Utilities** tab, then tap **TightVNC Server Start**.

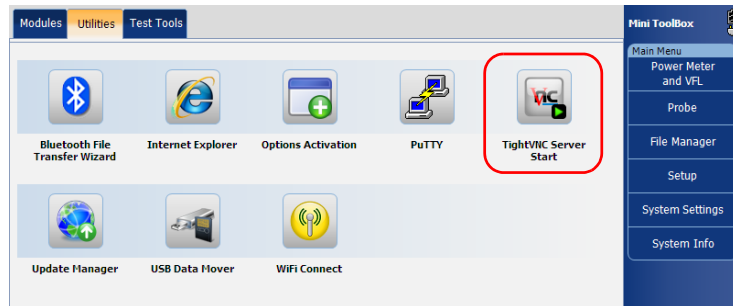

6. From your computer, double-click the TightVNC Viewer shortcut on your desktop.
7. In the **VNC Server** list, type the IP address of your unit that you wrote down at step 4.

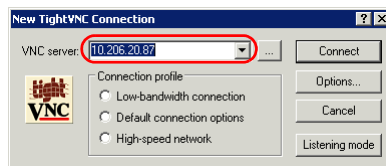

8. Click **Connect**.

## Configuring TightVNC Server to Start Automatically

By default, the TightVNC Server is not started automatically when you turn on your unit. However, you can modify this setting. This is especially useful if you need to remotely connect to your unit without having the unit close at hand.



### **IMPORTANT**

The passwords that you set for the application that is started automatically are independent of the passwords that you set for the application that you start manually (via the Utilities tab). This means that you could need to enter different passwords, depending on which TightVNC application you use to connect to your unit.

If you do not want to manage two different sets of passwords, you can set all passwords to the same value.

#### To configure TightVNC server to start automatically:

1. On your unit, from the **Main Menu**, select **System Settings**.
2. Tap **Remote Session**.

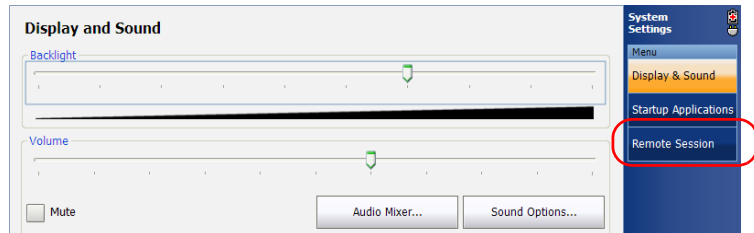

3. Select the **Start TightVNC Server automatically at unit startup** check box.

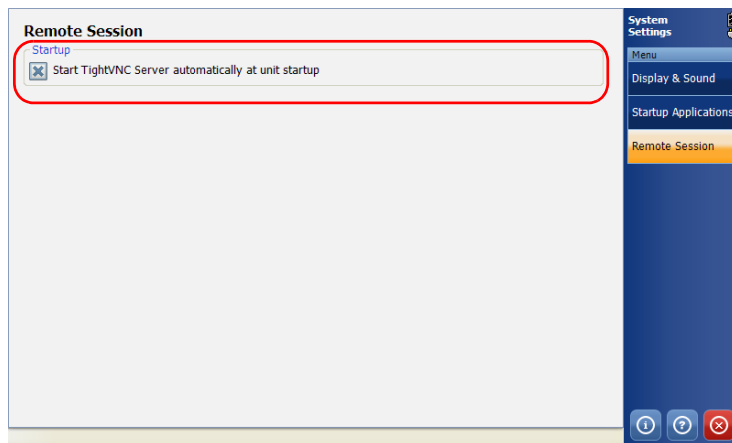

4. When the unit prompts you, tap **Yes** to configure the TightVNC passwords (and other parameters) if necessary. Tap **OK** to confirm.

The new parameters are now taken into account. For more information on how to connect to your unit, see *Connecting to Your Unit with TightVNC* on page 292.

5. Tap  to return to the MAX-700 software window.

## Accessing Your Unit Remotely

### *Adding Exceptions to the Firewall*

---

## Adding Exceptions to the Firewall

Your unit is protected by the Microsoft firewall to prevent unauthorized access when it is connected to a network or to the Internet. The firewall has been preconfigured so that all the applications that come with your unit work properly. However, you can allow other applications to access the network or the Internet by adding exceptions.

If you are not sure about how to configure the firewall, see with your network administrator.

### ***To add exceptions to the firewall:***

- 1.** On your unit, from the **Main Menu**, tap **Setup**.
- 2.** Double-tap **Windows Firewall**.

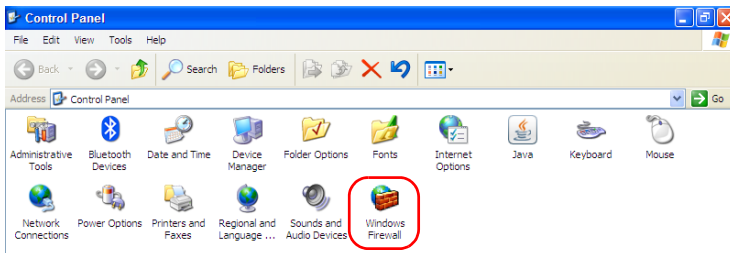

3. Select the **Exceptions** tab.

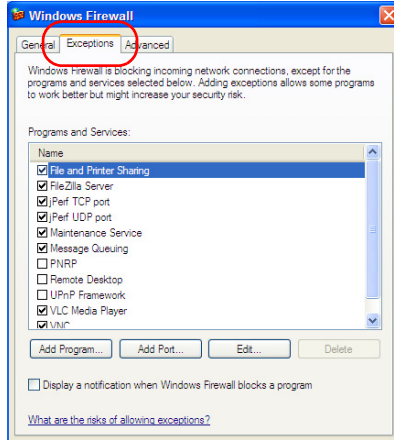

4. Tap **Add Program** to add any application that you need.
5. When you have finished, tap **OK** (located at the bottom of the dialog box) to confirm the changes and return to the **Control Panel** window.



## 20 **Maintenance**

To help ensure long, trouble-free operation:

- Always inspect fiber-optic connectors before using them and clean them if necessary.
- Keep the unit free of dust.
- Clean the unit casing and front panel with a cloth slightly dampened with water.
- Store unit at room temperature in a clean and dry area. Keep the unit out of direct sunlight.
- Avoid high humidity or significant temperature fluctuations.
- Avoid unnecessary shocks and vibrations.
- If any liquids are spilled on or into the unit, turn off the power immediately, disconnect from any external power source, remove the batteries and let the unit dry completely.



### **WARNING**

The use of controls, adjustments and procedures other than those specified herein may result in exposure to hazardous situations or impair the protection provided by this unit.

## Cleaning EUI Connectors

Regular cleaning of EUI connectors will help maintain optimum performance. There is no need to disassemble the unit.



### **IMPORTANT**

If any damage occurs to internal connectors, the module casing will have to be opened and a new calibration will be required.

#### **To clean EUI connectors:**

1. Remove the EUI from the instrument to expose the connector baseplate and ferrule.

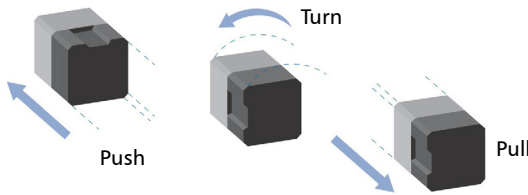

2. Moisten a 2.5 mm cleaning tip with *one drop* of isopropyl alcohol (alcohol may leave traces if used abundantly).
3. Slowly insert the cleaning tip into the EUI adapter until it comes out on the other side (a slow clockwise rotating movement may help).

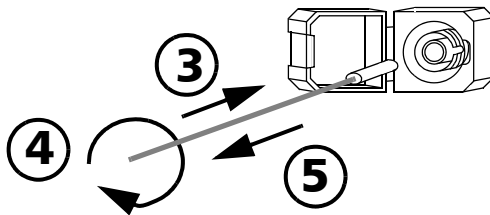

4. Gently turn the cleaning tip one full turn, then continue to turn as you withdraw it.



5. Repeat steps 3 to 4 with a dry cleaning tip.

**Note:** *Make sure you don't touch the soft end of the cleaning tip.*

6. Clean the ferrule in the connector port as follows:

**6a.** Deposit *one drop* of isopropyl alcohol on a lint-free wiping cloth.



## **IMPORTANT**

Isopropyl alcohol may leave residues if used abundantly or left to evaporate (about 10 seconds).

**Avoid contact between the tip of the bottle and the wiping cloth, and dry the surface quickly.**

- 6b.** Gently wipe the connector and ferrule.
- 6c.** With a dry lint-free wiping cloth, gently wipe the same surfaces to ensure that the connector and ferrule are perfectly dry.
- 6d.** Verify connector surface with a portable fiber-optic microscope (for example, EXFO's FOMS) or fiber inspection probe (for example, EXFO's FIP).



## **WARNING**

**Verifying the surface of the connector WHILE THE UNIT IS ACTIVE WILL result in permanent eye damage.**

7. Put the EUI back onto the instrument (push and turn clockwise).
8. Throw out cleaning tips and wiping cloths after one use.

## Cleaning Detector Ports

Regular cleaning of detectors will help maintain measurement accuracy.



### IMPORTANT

Always cover detectors with protective caps when unit is not in use.

#### ***To clean detector ports:***

1. Remove the protective cap and adapter (FOA) from the detector.
2. If the detector is dusty, blow dry with compressed air.
3. Being careful not to touch the soft end of the swab, moisten a cleaning tip with *only one drop* of isopropyl alcohol.



### IMPORTANT

Alcohol may leave traces if used abundantly. Do not use bottles that distribute too much alcohol at a time.

4. While applying light pressure (to avoid breaking the detector window), gently rotate the cleaning tip on the detector window.
5. Repeat step 4 with a dry cleaning tip or blow dry with compressed air.
6. Discard the cleaning tips after one use.

## Cleaning the Touchscreen of Your MAX-700 Unit

Clean the touchscreen with a soft, non-abrasive cloth, such as one used for cleaning reading glasses, dampened with water.



### CAUTION

Using anything else than water can damage the special coating of the touchscreen.

## Recharging the Main Battery

The main battery in your unit is a lithium-ion battery (four-cell format).

The clock battery is recharged automatically along with the main battery.

- In the MAX-700 software, the charge status is shown above **Main Menu**.
- The unit also indicates the charge status with the LED on its front panel (see *LED Indicators Description* on page 6):

Status LED	Battery Charge Status
Green	Fully charged
Green, blinking	Charging
Red	Error or battery is not in the unit

## Maintenance

### Recharging the Main Battery

---



## IMPORTANT

- ▶ Batteries are not charged at the factory. Install the battery compartment on your unit (see *Replacing Batteries* on page 305), and then fully charge the battery before using the unit for the first time. The battery is fully charged after a few hours or when the battery LED indicator stops flashing.
- ▶ The time required to charge batteries depends on various factors such as the ambient temperature.
- ▶ To ensure that batteries function or charge properly, keep them in temperatures between 10 °C and 40 °C (50 °F and 104 °F). Store below 50 °C (122 °F).
- ▶ Charge only with specified charger.

#### ***To recharge the main battery:***

Connect the unit to a power outlet using the AC adapter/charger. The charge cycle will start and end automatically.

## Replacing Batteries

Your unit uses a four-cell battery that has been especially designed for EXFO. For this reason, you can only replace the main battery with a battery designed for your MAX-700.

You can purchase new batteries and empty battery compartments (also known as “battery covers”) from EXFO.

**Note:** *Batteries and battery compartments are sold separately, which means you can purchase extra batteries to use with a battery compartment that you already have.*



### **CAUTION**

Use Li-Ion batteries of the same type and model only. Use of other batteries may damage your unit and compromise your safety.



### **WARNING**

Do not throw batteries into fire or water and do not short-circuit the battery’s electrical contacts. Do not disassemble.

#### **To remove the main battery:**

1. Turn off the unit.
2. Remove the battery compartment (located at the back of the unit) as follows:
  - 2a. Position the unit so that its front panel rests on a flat surface such as a table.

## Maintenance

### Replacing Batteries

- 2b.** Lift the mobile part of the battery compartment screws and turn the screws counterclockwise until the compartment is loose. Since they are captive screws, you cannot remove them completely.

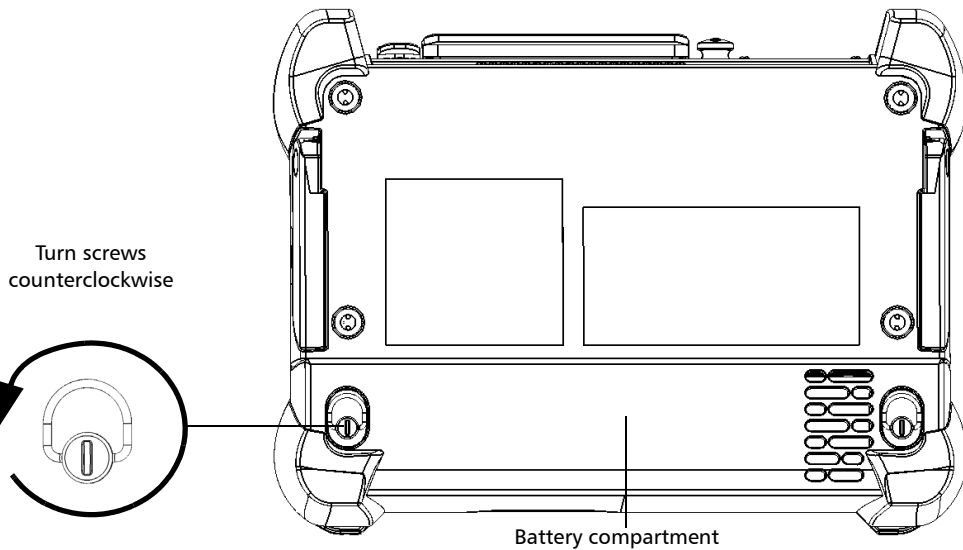

## CAUTION

Shocks and drops may have loosened the battery inside its compartment.

To avoid irremediable damage to the battery, always remove the battery compartment carefully, ensuring that the battery does not fall.

- 2c.** Hold the battery compartment by its sides and pull it up carefully.

- 3.** If necessary, release the battery from its compartment as follows:
  - 3a.** Position the battery compartment so that the battery is facing you.
  - 3b.** Pull on the battery tab to free the battery from its socket.

You are now ready to replace the battery.

***To replace (or install) the main battery:***

- 1.** If you do not have a replacement battery, contact EXFO to purchase a new one.
- 2.** Position the battery compartment so that you can view its hollow part.



**IMPORTANT**

Always use a battery whose size corresponds to the size of the battery compartment.

## Maintenance

### Replacing Batteries

---

3. Install the battery as follows:
  - 3a. Insert the new battery, respecting the polarity. You can use the image appearing inside the compartment as a guide.

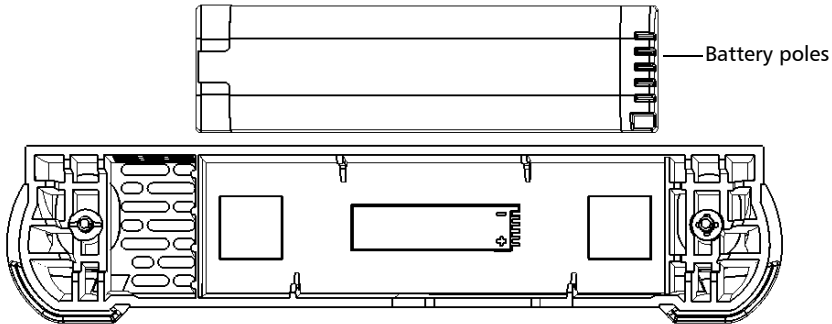

**Note:** When the battery is correctly positioned, its poles should be facing upwards and be placed on the same side as shown on the illustration in the battery compartment.

- 3b. Apply slight pressure to the battery to secure it in place.
4. Position the battery compartment so that you can see the two screws.
5. Place the battery compartment on the unit, making sure that the bumpers and the shorter sides of the compartment are flush with those of the unit. If necessary, slightly move the battery compartment until alignment is correct.
6. Lift the mobile part of the compartment screws and, while applying slight pressure, turn the screws clockwise until they are tightened.

**Note:** You cannot replace the clock battery yourself.



## Verifying Your MAX-700

You can perform several tests to ensure your MAX-700 operates within specifications.

Deviation is measured to determine if the OTDR needs recalibration.

Setting your OTDR to zero can only be done at EXFO. However, you can test your OTDR to verify the accuracy of its measurement origin.

### **To measure the deviation:**

1. Connect at least 2 km of fiber to the OTDR output port.
2. Set the distance range at 2.5 km and acquisition time at 180 seconds.
3. Measure the deviation between a 10 ns pulse and a 30 ns pulse for each laser.

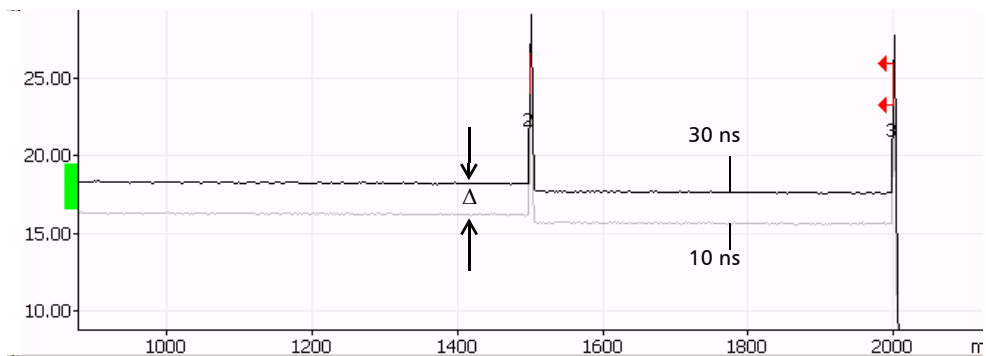

The deviation ( $\Delta$ ) should be between 2.0 dB and 3.0 dB. The deviation must be measured in the linear backscatter region. Do not measure the deviation near distinct reflections.

Performance will be affected if the observed deviation is beyond these limits. The OTDR will eventually require a factory calibration.

**Note:** *This does not affect the precision of distance or loss measurements.*

## Maintenance

### Verifying Your MAX-700

---

#### **To evaluate the launch level:**

1. Connect at least 2 km of fiber to the OTDR port.
  - Ensure that the OTDR port and connectors are properly cleaned and that the fiber settings are accurate (IOR, Helix factor and RBS).
  - Do not use a test jumper between the OTDR and the fiber under test to limit the number of connectors.
2. Set the distance range to the fiber length used for the evaluation, the pulse width to the shortest value available, and the acquisition time to 15 seconds.
3. Evaluate the launch level at 0 km by extrapolating the linear region of the curve.

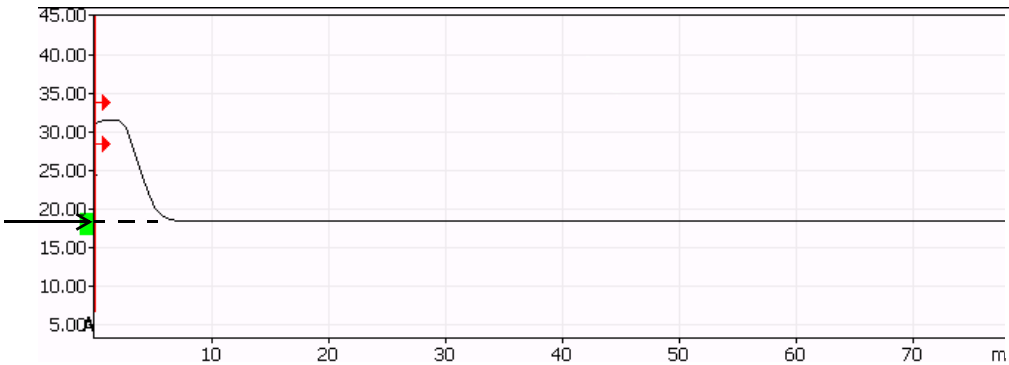

The launch level should be located within the launch window (light green rectangle) appearing on the left side of the Y-axis on the graph. If the launch level is below this window, clean the output connector again, retest the fiber and change the output connector if necessary. If the situation persists, you will observe a degradation in dynamic range. Return the OTDR to EXFO.

**Note:** *This does not affect the precision of distance or loss measurements.*

**To verify the OTDR's zero:**

1. Connect a patchcord, approximately 10 m long, to the OTDR port. The exact length of the jumper must have been measured mechanically. Ideally, you should use an unjacketed patchcord.
  - Ensure that the OTDR port and connectors are correctly cleaned.
  - Ensure that the fiber settings are accurate (IOR, Helix factor and RBS).
2. Set the distance range to less than 2 km, the pulse width to 10 ns and the acquisition time to 30 s.
3. Take a distance measurement, positioning marker A as shown below.

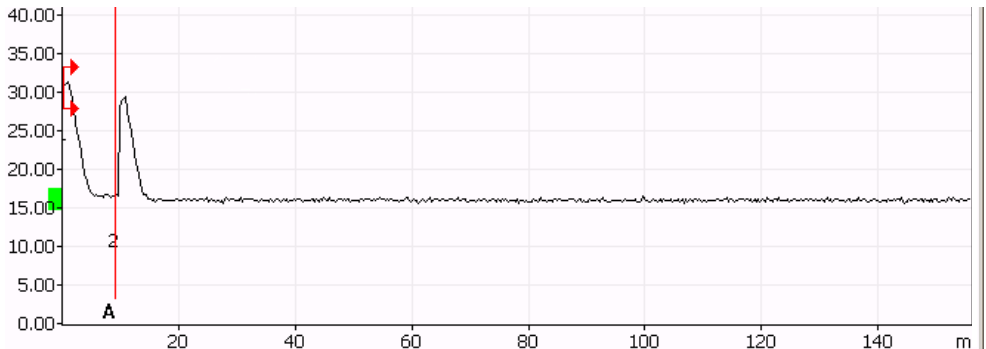

**Note:** You can also press the **Analyze** button from the **Event** pane. The analysis should return the right position directly.

The position of the marker should be equal to the length of the jumper ( $\pm 2$  m). For example, 8 to 12 m if the jumper is 10 m long.

If the distance error is beyond this limit, return the OTDR to EXFO.

## Maintenance

### Verifying Your MAX-700

#### To measure the event and attenuation dead zones:

1. Connect 2 km of fiber directly to the OTDR port. Use the shortest pulse width and distance range possible.
  - Ensure that the OTDR port and connectors are correctly cleaned.
  - Ensure that the fiber settings are accurate (IOR, Helix factor, and RBS).
2. Measure the length (E) of the first reflection at 1.5 dB from the maximum, as shown below. This is the event dead zone.
3. Measure the distance (A) between the beginning of the reflection and the point where the trace returns to the backscattering level with a 0.5 dB uncertainty, as shown below. Use A and B markers in the **Measure** pane. This is the attenuation dead zone.

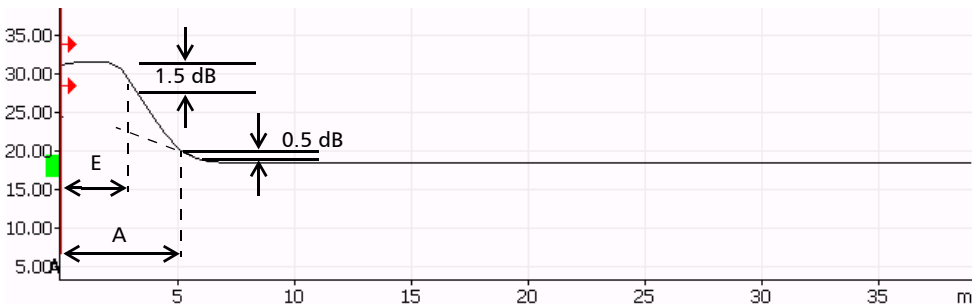

If the results exceed the “maximum permitted specification” (refer to the calibration certificate that came with your product), performance will be affected. A damaged output connector may be the cause.

The reflectance of the output connector should be below  $-35$  dB to attain an adequate dead zone. If reflectance is greater than  $-35$  dB (for example,  $-20$ ), the incorrect dead zone will be the result of a bad connection. If this is the case, carefully clean the connector. If the problem persists, change the output connector. If the problem remains even after changing the output connector, return the OTDR to EXFO.

**Note:** This does not affect the precision of the distance or loss measurements.

**To measure the dynamic range:**

1. Connect the OTDR as indicated below. Other configurations are possible, such as the one explained in the section on how to determine measurement range, if you use the shortest fiber length from that setup. In all cases, the fiber should have several sections longer than 2 km, with no loss greater than 8 dB and with an average attenuation not exceeding 1 dB/km.

Ensure the OTDR port and connectors are correctly cleaned, and that the fiber settings are accurate (IOR, Helix factor, and RBS).

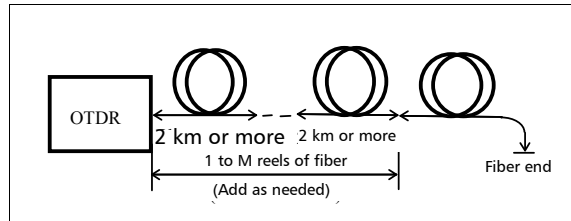

## Maintenance

### Verifying Your MAX-700

- Set the distance range to 160 km (singlemode fiber), the pulse width to the longest value available and the acquisition time to 180 seconds.

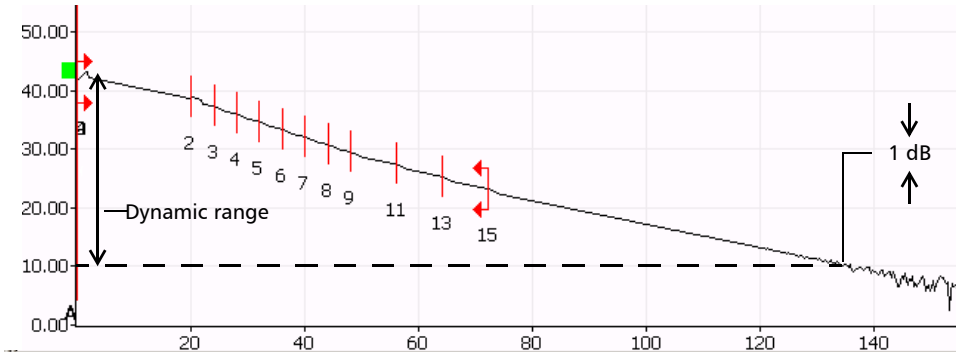

Dynamic range is the difference between the launch level and the position on the curve where the peak-to-peak noise level is 1 dB, plus a correction factor relative to the noise amplitude (which is 5.2 dB).

If the result falls below the “minimum permitted specification” (refer to the calibration certificate that came with your product), you will observe a degradation of performance. It could be caused by a damaged output connector. If this is the case, clean the connector. If the problem persists, change the output connector. If the problem remains even after changing the output connector, return the OTDR to EXFO.

**Note:** *This does not affect the precision of the distance or loss measurements.*

**To determine the measurement range (singlemode models only):**

1. Connect the OTDR as indicated below. Other configurations are possible, but the fiber should have several sections longer than 2 km, with no loss greater than 8 dB and with the average attenuation not exceeding 1 dB/km. A variable attenuator will be used to adjust the loss in the span.

One or several non-reflective events with a nominal loss of 0.5 dB should be present. Join a series of fiber reels between the OTDR and the variable attenuator for a length of approximately 20 km. Join another series of reels to complete the fiber length needed for the test.

- Ensure that the OTDR port and connectors are correctly cleaned.
- Make sure the fiber settings are accurate (IOR, Helix factor, and RBS).

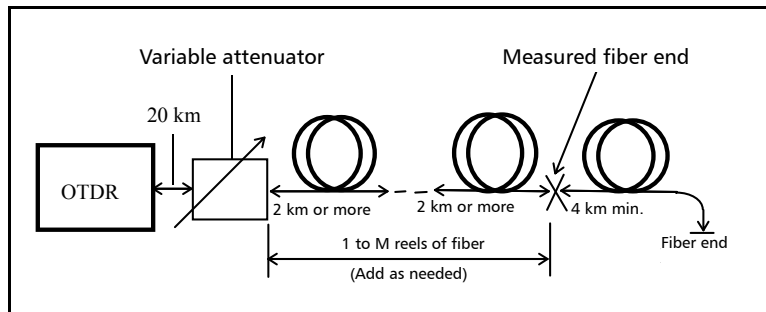

## Maintenance

### Verifying Your MAX-700

2. Set the distance range to 80 km (singlemode fiber), the pulse width to the longest value available and the acquisition time to 180 seconds.

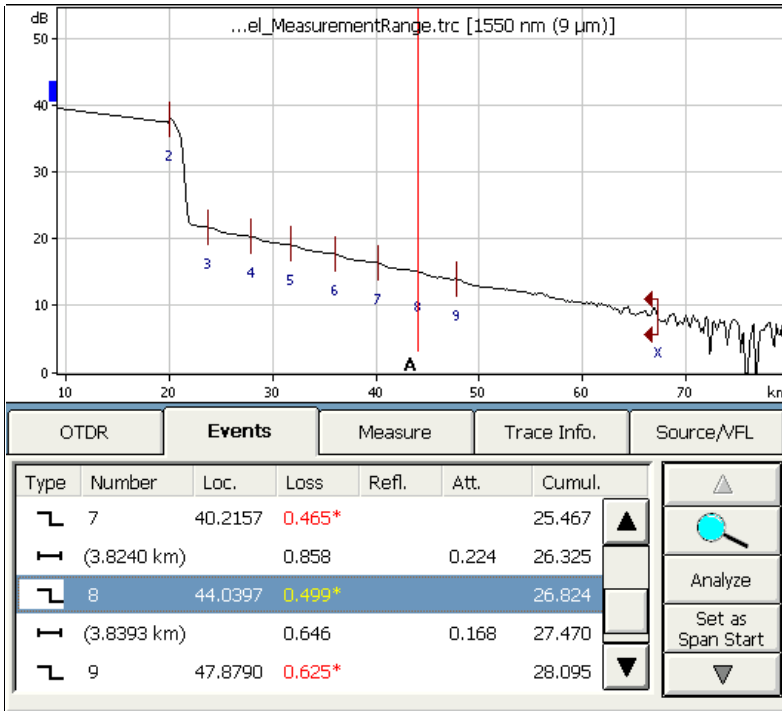

The measurement range using the non-reflective event method represents the amount of attenuation (dB) between the launch level and a 0.5 dB splice (which can be detected and measured to an accuracy of  $\pm 0.1$  dB). You can measure it by simply making an acquisition on a fiber with a known attenuation and a known 0.5 dB splice. Attenuation between the splice and the launch level is added until the analysis can no longer measure the splice to within  $\pm 0.1$  dB.



## **Recalibrating the Unit**

Manufacturing and service center calibrations are based on the ISO/IEC 17025 Standard, which states that calibration documents must not contain a recommended calibration interval, unless this has been previously agreed upon with the customer.

Validity of specifications depends on operating conditions. For example, the calibration validity period can be longer or shorter depending on the intensity of use, environmental conditions and unit maintenance. You should determine the adequate calibration interval for your unit according to your accuracy requirements.

Under normal use, EXFO recommends calibrating your unit every year.

## **Recycling and Disposal (Applies to European Union Only)**

For complete recycling/disposal information as per European Directive WEEE 2002/96/EC, visit the EXFO Web site at [www.exfo.com/recycle](http://www.exfo.com/recycle).



# 21 *Troubleshooting*



## Solving Common Problems

### Unit-Related Problems

Problem	Cause	Solution
Unit does not turn on.	Battery is discharged.	<ul style="list-style-type: none"><li>➤ Charge the battery.</li><li>➤ Replace the battery with a fully charged one.</li><li>➤ Connect the unit to an external power supply using the AC adapter/charger.</li></ul>
	Unit is not connected to an external power supply.	Connect the unit to an external power supply using the AC adapter/charger.
	External power supply is disconnected.	Make sure the external power supply is connected at both ends.
Unit screen is dark.	Unit's backlight is off.	Press the backlight button.
	Battery is discharged and unit has shut down.	<ul style="list-style-type: none"><li>➤ Charge the battery.</li><li>➤ Replace the battery with a fully charged one.</li><li>➤ Connect the unit to an external power supply using the AC adapter/charger.</li></ul>
External keyboard is not working.	External keyboard has not been detected.	<ul style="list-style-type: none"><li>➤ Disconnect the keyboard, and then connect it again.</li><li>➤ Turn off the unit, connect the keyboard, and turn on the unit.</li></ul>
Screen characters are dim.	Brightness is not set properly.	Adjust brightness.

## Troubleshooting

### Solving Common Problems

Problem	Cause	Solution
One of the applications is not responding.		Press  and hold it down until the shutdown menu appears, then select <b>Turn off</b> . Turn the unit on again to reset it.
Impossible to calibrate the touchscreen via the calibration application in <b>System Settings</b> .	Screen calibration is very poor.	<ul style="list-style-type: none"> <li>➤ Press  and hold it down until the shutdown menu appears, then select <b>Turn off</b>.</li> <li>➤ Turn on the unit.</li> <li>➤ Connect an external keyboard to your unit.</li> <li>➤ While the system is displaying the boot menu (3 seconds), press the ARROW DOWN key on the keyboard to select the emergency system tools operation mode.</li> <li>➤ Press ENTER on your keyboard to confirm your choice.</li> <li>➤ Press  to start the screen calibration.</li> </ul>
Unit's operating time is reduced.	Battery was not fully charged.	Charge the battery.
	Battery is probably worn out.	Replace the battery.
Batteries are not charging.	Ambient temperature is too high or too low.	Ensure that the temperature in the location where you charge the batteries is within the specifications.
	AC adapter/charger is not connected properly.	Ensure that the adapter/charger is connected both to your unit and the power outlet.

Problem	Cause	Solution
Unit switches to standby mode unexpectedly.	Power schemes are not defined correctly.	Select one of the predefined power schemes. For more information, see the <i>Configuring the Power Management Options</i> section.
Unit is not responding.		Restore your unit.

## OTDR-Related Problems

Problem	Cause	Solution
The application displays a message indicating that a “Non-resolved fiber end” event has been found.	The fiber under test is too long.	Ensure that the fiber under test is shorter than the maximum length the OTDR can measure.
In multimode fiber testing, launch level remains out of the launch window (light green rectangle) even after cleaning and verifying connection.	Wrong fiber type selected.	<ul style="list-style-type: none"> <li>➤ If you are testing C fiber, from the <b>Auto</b> or <b>Advanced</b> main window, select <b>MM 50 <math>\mu\text{m}</math></b>.</li> <li>➤ If you are testing D fiber, from the <b>Auto</b> or <b>Advanced</b> main window, select <b>MM 62.5 <math>\mu\text{m}</math></b>.</li> </ul>

## Troubleshooting

### *Solving Common Problems*

---

Problem	Cause	Solution
<p>The application displays a message indicating that a “live fiber error” occurred and the fiber <i>was not</i> connected to the SM Live port.</p>	<p>Light has been detected on the OTDR port during the acquisition or while you were monitoring a fiber in real-time mode.</p>	<p>Disconnect the fiber from the OTDR port. Press OK to close the message. Start another acquisition without any fiber connected to the OTDR. The message about live fiber error should not appear and the OTDR trace should look “normal”.</p> <p>If you still see the message about live fiber error even if no fiber is connected to the OTDR, contact EXFO.</p> <p>Never connect a live fiber to the OTDR port without a proper setup. Any incoming optical power ranging from -65 dBm to -40 dBm will affect the OTDR acquisition. The way the acquisition will be affected depends on the selected pulse width. Any incoming signal greater than -20 dBm could damage your MAX-700 permanently. For live-fiber testing, refer to the SM Live port specifications for the characteristics of the built-in filter.</p>

Problem	Cause	Solution
<p>The application displays a message indicating that a “live fiber error” occurred and the fiber <i>was</i> connected to the SM Live port.</p>	<p>The level of integrated power in the filter bandwidth of the SM Live port is too high. A transmission wavelength from the network could be too close to the SM Live wavelength.</p>	<p>Disconnect the fiber from the OTDR port. Press OK to close the message. Start another acquisition without any fiber connected to the OTDR. The message about live fiber error should not appear and the OTDR trace should look “normal”.</p> <p>If you still see the message about live fiber error even if no fiber is connected to the OTDR, contact EXFO.</p> <p>Singlemode live-fiber testing requires that the integrated power in the test channel (corresponding to the filter bandwidth of the SM Live port) be as low as possible. Any incoming optical power ranging from –65 dBm to – 40 dBm will affect the OTDR acquisition. The way the acquisition will be affected depends on the selected pulse width. Higher power levels will prevent acquisition from running. Verify network compatibility with the SM Live wavelength. Ensure that the network is not transmitting wavelengths greater than 1600 nm.</p>

## Restoring Your Unit to Normal Operation

Your MAX-700 is set to start using the standard Windows startup sequence. However, you can also use the emergency system tools feature if you need to:

- check the disk integrity
- back up some files directly onto a USB storage device for recovery purposes
- revert your unit to its initial state (as it was when you purchased it) or restore it with a specific Windows image (WIM) that could have been provided to you by EXFO customer service, for example.



### IMPORTANT

The restoration of the system partition cannot be undone or stopped once it is started.

If you have installed other products that are not included in your image file, you will have to reinstall them afterwards.

To avoid losing the data that is stored on the D drive, you may want to back it up before restoring the system partition. Otherwise, all your files will be lost.



### IMPORTANT

Connect a keyboard to your unit before using the emergency system tools. Otherwise, you will not be able to enter the *Maintenance and recovery* mode. The touchscreen becomes available once you have entered the tool.

You may find useful to connect a mouse to your unit as well.



**To navigate in the various windows using a keyboard (connected to your unit):**

- Use up/down and left/right arrow keys.
- You can also use the TAB key to go to the next group of features.
- Press the ENTER key to select an item.

**To restore the system partition:**

1. Turn on the MAX-700.
2. While the system is displaying the boot menu (3 seconds), press the ARROW DOWN key on your keyboard to select the *Maintenance and recovery* mode.
3. Press ENTER to confirm your choice.

**Note:** *The touchscreen becomes effective at this point.*

## Troubleshooting

### Restoring Your Unit to Normal Operation

4. From the main window, select **Restore system partition from an image**, then tap **Next**.

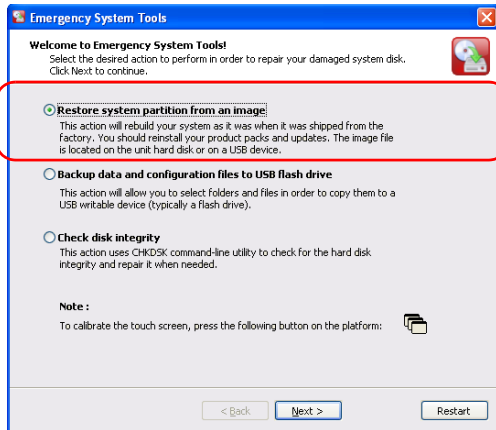

5. If you want to revert your unit to its initial state (most cases), select **Factory recovery image**.

OR

If you prefer to use an image file (provided by customer service, for example), select **.wim file** and use the **Browse** button to locate the file.

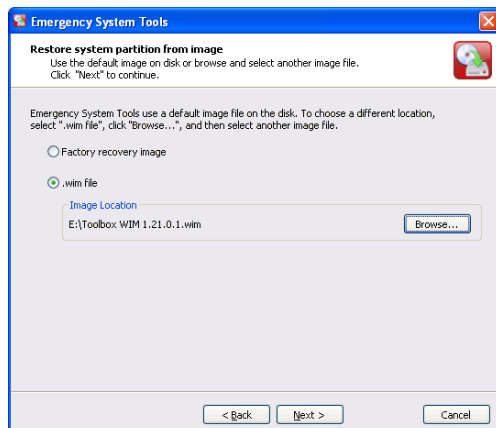

6. Tap **Next** to proceed to the next step.

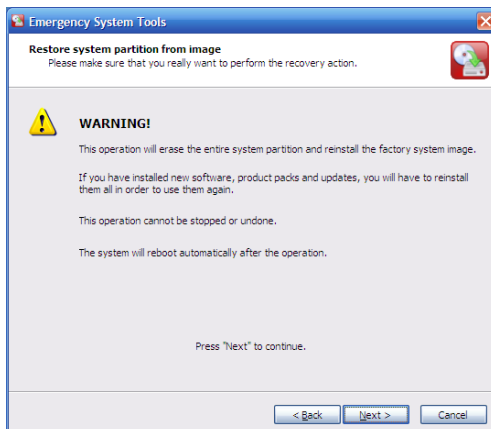

7. Tap **Next** to start the restoration process. The unit will restart upon completion of the process.

## Troubleshooting

### Restoring Your Unit to Normal Operation

---

#### **To retrieve data from the D drive:**

1. Turn on the MAX-700.
2. While the system is displaying the boot menu (3 seconds), press the ARROW DOWN key on your keyboard to select the *Maintenance and recovery* mode.
3. Press ENTER to confirm your choice.

**Note:** *The touchscreen becomes effective at this point.*

4. From the main window, select **Backup data and configuration files to USB flash drive**, then tap **Next**.

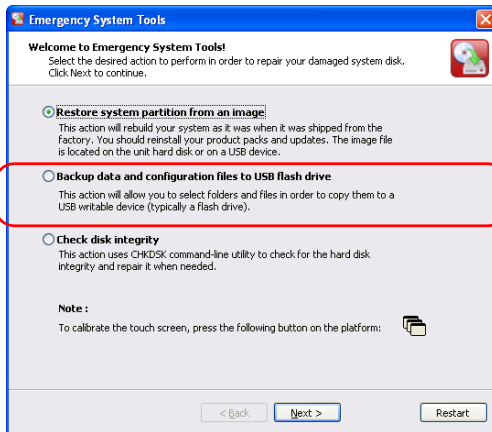

**5.** Select the files to back up.

A check mark indicates a selection of the entire folder (subfolders and files). A shaded check box indicates that not all of the files of subfolders are selected.

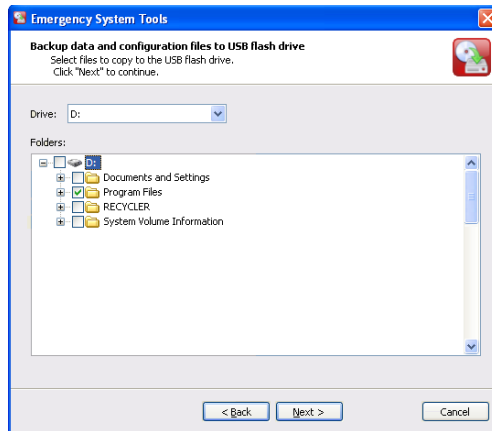

**6.** If the USB device you want to use is not connected to the unit, connect it now so that the system can find it. Tap **Next**.

## Troubleshooting

### Restoring Your Unit to Normal Operation

---

7. Select the USB device onto which you want to save the data from the list of available devices.

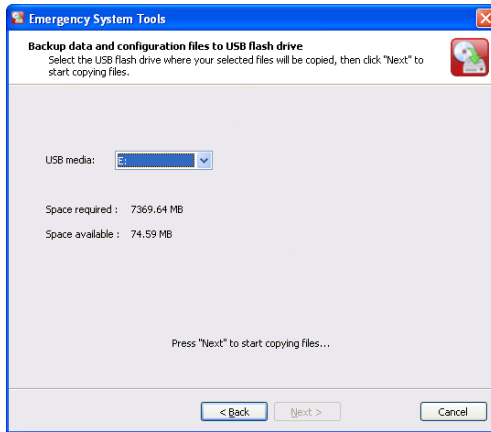

**Note:** *If you have forgotten to connect the USB device at this point and that it does not show up in the list, tap **Back**, connect the device, then tap **Next** to return to this window.*

8. Tap **Next** to start the file copy process.

A progress bar indicates which files are being copied. If you tap **Cancel** while the transfer is in progress, any file that was copied onto the USB device will still be on the USB device.

9. Once the transfer is complete, tap **Cancel** to return to the main window.

#### **To verify disk integrity:**

1. Turn on the MAX-700.
2. While the system is displaying the boot menu (3 seconds), press the ARROW DOWN key on your keyboard to select the *Maintenance and recovery* mode.
3. Press ENTER to confirm your choice.

**Note:** *The touchscreen becomes effective at this point.*

4. From the main window, select **Check disk integrity**, then tap **Next**.

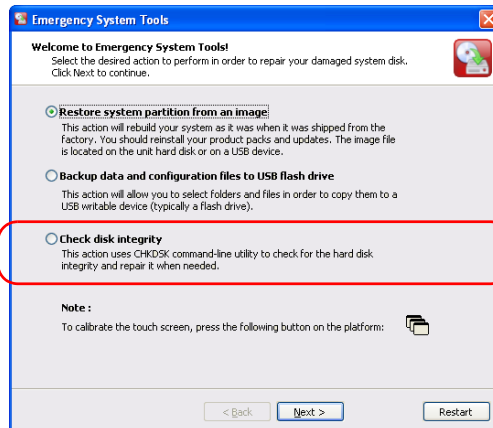

## Troubleshooting

### *Restoring Your Unit to Normal Operation*

---

5. Tap **Next** to start the disk analysis.

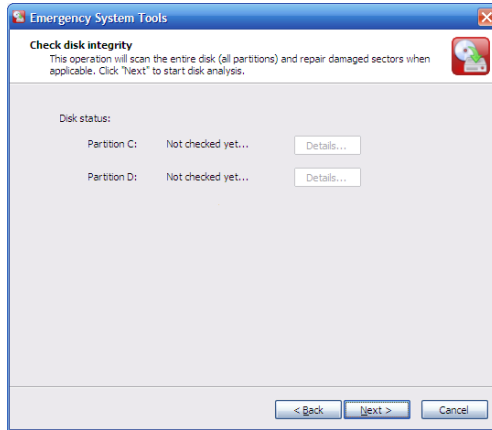

Once the analysis is complete, you can view a report on each drive by tapping **Details**.

6. Tap **OK** once you have finished.
7. To exit the integrity analysis tool, tap **Cancel** to return to the main window.



## **Contacting the Technical Support Group**

To obtain after-sales service or technical support for this product, contact EXFO at one of the following numbers. The Technical Support Group is available to take your calls from Monday to Friday, 8:00 a.m. to 7:00 p.m. (Eastern Time in North America).

For detailed information about technical support, visit the EXFO Web site at [www.exfo.com](http://www.exfo.com).

### **Technical Support Group**

400 Godin Avenue  
Quebec (Quebec) G1M 2K2  
CANADA

1 866 683-0155 (USA and Canada)  
Tel.: 1 418 683-5498  
Fax: 1 418 683-9224  
[support@exfo.com](mailto:support@exfo.com)

To accelerate the process, please have information such as the name and the serial number (see the product identification label), as well as a description of your problem, close at hand.

## Transportation

Maintain a temperature range within specifications when transporting the unit. Transportation damage can occur from improper handling. The following steps are recommended to minimize the possibility of damage:

- Pack the unit in its original packing material when shipping.
- Avoid high humidity or large temperature fluctuations.
- Keep the unit out of direct sunlight.
- Avoid unnecessary shocks and vibrations.

# 22 **Warranty**

## **General Information**

EXFO Inc. (EXFO) warrants this equipment against defects in material and workmanship for a period of one year from the date of original shipment. EXFO also warrants that this equipment will meet applicable specifications under normal use.

During the warranty period, EXFO will, at its discretion, repair, replace, or issue credit for any defective product, as well as verify and adjust the product free of charge should the equipment need to be repaired or if the original calibration is erroneous. If the equipment is sent back for verification of calibration during the warranty period and found to meet all published specifications, EXFO will charge standard calibration fees.



### **IMPORTANT**

The warranty can become null and void if:

- **unit has been tampered with, repaired, or worked upon by unauthorized individuals or non-EXFO personnel.**
- **warranty sticker has been removed.**
- **case screws, other than those specified in this guide, have been removed.**
- **case has been opened, other than as explained in this guide.**
- **unit serial number has been altered, erased, or removed.**
- **unit has been misused, neglected, or damaged by accident.**

THIS WARRANTY IS IN LIEU OF ALL OTHER WARRANTIES EXPRESSED, IMPLIED, OR STATUTORY, INCLUDING, BUT NOT LIMITED TO, THE IMPLIED WARRANTIES OF MERCHANTABILITY AND FITNESS FOR A PARTICULAR PURPOSE. IN NO EVENT SHALL EXFO BE LIABLE FOR SPECIAL, INCIDENTAL, OR CONSEQUENTIAL DAMAGES.

## Warranty

### Liability

---

## Liability

EXFO shall not be liable for damages resulting from the use of the product, nor shall be responsible for any failure in the performance of other items to which the product is connected or the operation of any system of which the product may be a part.

EXFO shall not be liable for damages resulting from improper usage or unauthorized modification of the product, its accompanying accessories and software.

## Exclusions

EXFO reserves the right to make changes in the design or construction of any of its products at any time without incurring obligation to make any changes whatsoever on units purchased. Accessories, including but not limited to fuses, pilot lamps, batteries and universal interfaces (EUI) used with EXFO products are not covered by this warranty.

This warranty excludes failure resulting from: improper use or installation, normal wear and tear, accident, abuse, neglect, fire, water, lightning or other acts of nature, causes external to the product or other factors beyond the control of EXFO.



## IMPORTANT

EXFO will charge a fee for replacing optical connectors that were damaged due to misuse or bad cleaning.

## Certification

EXFO certifies that this equipment met its published specifications at the time of shipment from the factory.

## Service and Repairs

EXFO commits to providing product service and repair for five years following the date of purchase.

***To send any equipment for service or repair:***

- 1.** Call one of EXFO's authorized service centers (see *EXFO Service Centers Worldwide* on page 338). Support personnel will determine if the equipment requires service, repair, or calibration.
- 2.** If equipment must be returned to EXFO or an authorized service center, support personnel will issue a Return Merchandise Authorization (RMA) number and provide an address for return.
- 3.** If possible, back up your data before sending the unit for repair.
- 4.** Pack the equipment in its original shipping material. Be sure to include a statement or report fully detailing the defect and the conditions under which it was observed.
- 5.** Return the equipment, prepaid, to the address given to you by support personnel. Be sure to write the RMA number on the shipping slip. *EXFO will refuse and return any package that does not bear an RMA number.*

**Note:** *A test setup fee will apply to any returned unit that, after test, is found to meet the applicable specifications.*

After repair, the equipment will be returned with a repair report. If the equipment is not under warranty, you will be invoiced for the cost appearing on this report. EXFO will pay return-to-customer shipping costs for equipment under warranty. Shipping insurance is at your expense.

Routine recalibration is not included in any of the warranty plans. Since calibrations/verifications are not covered by the basic or extended warranties, you may elect to purchase FlexCare Calibration/Verification Packages for a definite period of time. Contact an authorized service center (see *EXFO Service Centers Worldwide* on page 338).

## **Warranty**

*EXFO Service Centers Worldwide*

---

### **EXFO Service Centers Worldwide**

If your product requires servicing, contact your nearest authorized service center.

#### **EXFO Headquarters Service Center**

400 Godin Avenue  
Quebec (Quebec) G1M 2K2  
CANADA

1 866 683-0155 (USA and Canada)  
Tel.: 1 418 683-5498  
Fax: 1 418 683-9224  
support@exfo.com

#### **EXFO Europe Service Center**

Omega Enterprise Park, Electron Way  
Chandlers Ford, Hampshire S053 4SE  
ENGLAND

Tel.: +44 2380 246810  
Fax: +44 2380 246801  
support.europe@exfo.com

#### **EXFO Telecom Equipment (Shenzhen) Ltd.**

3rd Floor, Building 10,  
Yu Sheng Industrial Park (Gu Shu  
Crossing), No. 467,  
National Highway 107,  
Xixiang, Bao An District,  
Shenzhen, China, 518126

Tel: +86 (755) 2955 3100  
Fax: +86 (755) 2955 3101  
support.asia@exfo.com

# A Technical Specifications



## IMPORTANT

The following technical specifications can change without notice. The information presented in this section is provided as a reference only. To obtain this product's most recent technical specifications, visit the EXFO Web site at [www.exfo.com](http://www.exfo.com).

### SPECIFICATIONS<sup>a</sup>

TECHNICAL SPECIFICATIONS	MAXTESTER 710	MAXTESTER 730
Display	Touchscreen, color, 800 x 480 TFT, 178 mm (7 in)	Touchscreen, color, 800 x 480 TFT, 178 mm (7 in)
Interfaces	Two USB 2.0 ports RJ-45 LAN 10/100/1000 Mbit/s Fiber inspection probe connector port (video) Built-in Bluetooth and Wi-Fi (hardware option)	Two USB 2.0 ports RJ-45 LAN 10/100/1000 Mbit/s Fiber inspection probe connector port (video) Built-in Bluetooth and Wi-Fi (hardware option)
Storage	4 GB internal memory (flash)	4 GB internal memory (flash)
Batteries	Rechargeable lithium-ion batteries 7 hours of operation as per Telcordia (Bellcore) TR-NWT-001138	Rechargeable lithium-ion batteries 7 hours of operation as per Telcordia (Bellcore) TR-NWT-001138
Power supply	AC/DC adapter, input 100-240 VAC, 50-60 Hz, 1.6 A max, output 24 VDC, 3.75 A	AC/DC adapter, input 100-240 VAC, 50-60 Hz, 1.6 A max, output 24 VDC, 3.75 A
Computer	Intel ATOM processor Windows Embedded Standard operating system	Intel ATOM processor Windows Embedded Standard operating system
Wavelength (nm) <sup>b</sup>	1310 ± 20/1550 ± 20	1310 ± 20/1550 ± 20/1625 ± 10
Dynamic range (dB) <sup>c</sup>	29/28	37/35/35
Event dead zone (m) <sup>d</sup>	2.5	0.8
Attenuation dead zone (m)	10	4/4.5/4.5
Distance range (km)	Singlemode: 1.25, 2.5, 5, 10, 20, 40, 80, 160	Singlemode: 1.25, 2.5, 5, 10, 20, 40, 80, 160, 260
Pulse width (ns)	Singlemode: 5, 10, 30, 50, 100, 275, 500, 1000, 2500, 10 000, 20 000	Singlemode: 5, 10, 30, 50, 100, 275, 500, 1000, 2500, 10 000, 20 000
Linearity (dB/dB)	±0.03	±0.03
Loss threshold (dB)	0.01	0.01
Loss resolution (dB)	0.001	0.001
Sampling resolution (m)	Singlemode: 0.08 to 5	Singlemode: 0.04 to 5
Sampling points	Up to 64 000	Up to 128 000
Distance uncertainty (m) <sup>e</sup>	±(0.75 + 0.005 % x distance + sampling resolution)	±(0.75 + 0.0025 % x distance + sampling resolution)
Measurement time	User-defined (60 min. maximum)	User-defined (60 min. maximum)
Typical real-time refresh (Hz)	3	3
Stable source output power (dBm) <sup>f</sup>	-11	-2.5

#### Notes

- All specifications valid at 23 °C ± 2 °C with an FC/APC connector, unless otherwise specified.
- Typical.
- Typical dynamic range with longest pulse and three-minute averaging at SNR = 1.
- Typical dead zone for reflectance below -45 dB, using a 5 ns pulse.
- Does not include uncertainty due to fiber index.
- Typical output power is given at 1550 nm.

# Technical Specifications

## GENERAL SPECIFICATIONS

Size (H x W x D)	190 mm x 252 mm x 66 mm (7 1/2 in x 9 15/16 in x 2 5/8 in)	
Weight (with battery)	2.2 kg (4.7 lb)	
Temperature	Operating	0 °C to 50 °C (32 °F to 122 °F)
	Storage	-40 °C to 70 °C (-40 °F to 158 °F) <sup>a</sup>
Relative humidity	0 % to 95 % non-condensing	

## ACCESSORIES

FP4S	400x fiber inspection probe	GP-2016	10 foot RJ-45 LAN cable
FP4D	200x/400x fiber inspection probe	GP-2028	Computer security cable kit
GP-10-086	Rigid carrying case	GP-2137	USB-to-RS-232 converter
GP-10-072	Semi-rigid carrying case	GP-2138	DC car adapter/inverter
GP-302	USB mouse	GP-2144	USB 16G micro-drive
GP-1002	Headset	GP-2155	Carry-on size backpack <sup>b</sup>
GP-1008	VFL adapter (2.5 mm to 1.25 mm)	GP-2158	Utility glove
GP-2001	USB keyboard		

## PM-1 BUILT-IN POWER METER SPECIFICATIONS<sup>c</sup>

Calibrated wavelengths (nm)	850, 1300, 1310, 1490, 1550, 1625, 1650
Power range (dBm)	26 to -64 (GeX)
Uncertainty (%) <sup>d</sup>	±5 % ± 0.4 nW (GeX)
Display resolution (dB)	
GeX	0.01 = max to -54 dBm 0.1 = -50 dBm to -60 dBm 1 = -60 dBm to min
Automatic offset nulling range <sup>a</sup>	Max power to -40 dBm for GeX
Tone detection (Hz)	270/1000/2000

## LASER SAFETY



21 CFR 1040.10 AND IEC 60825-1:2007  
CLASS 1M WITHOUT VFL OPTION  
CLASS 3R WITH VFL OPTION

## VISUAL FAULT LOCATOR (VFL) (OPTIONAL)

Laser, 650 nm ±10 nm
CW
Typical P <sub>out</sub> in 62.5/125 µm: 3 dBm (2 mW)

### Notes

- 20 °C to 60 °C (-4 °F to 140 °F) with the battery pack.
- The selected model may change without notice.
- At 23 °C ± 1 °C, 1550 nm and FC connector. With modules in idle mode. Battery operated.
- Up to 5 dBm.
- For ±0.05 dB, from 18 °C to 28 °C.



## **B** *Description of Event Types*

This section describes all types of events that may appear in the events table generated by the application. Here is a guide to the descriptions:

- Each type of event has its own symbol.
- Each type of event is represented by a graph of a fiber trace, which illustrates the power reflected back toward the source as a function of distance.
- An arrow points to the location of the event type in the trace.
- Most graphs show one complete trace; that is, an entire acquisition range.
- Some graphs show only a portion of the entire range to view events of interest more closely.

## Description of Event Types

### *Span Start*

---

## Span Start

The Span Start of a trace is the event that marks the beginning of the fiber span. By default, the Span Start is placed on the first event of a tested fiber (typically the first connector of the OTDR itself).

You can make another event the start of the span you want to focus your analysis on. This will set the beginning of the events table at a specific event along the trace.

## Span End

The Span End of a trace is the event that marks the end of the fiber span. By default, the Span End is placed on the last event of a tested fiber, and is called the end-of-fiber event.

You can also make another event the end of the span you want to focus your analysis on. This will set the end of the events table at a specific event along the trace.

## Short Fibers

You can test short fibers with the application. You can even define a fiber span for short fibers by placing the span start and the span end on the same event.

## Continuous Fiber ----

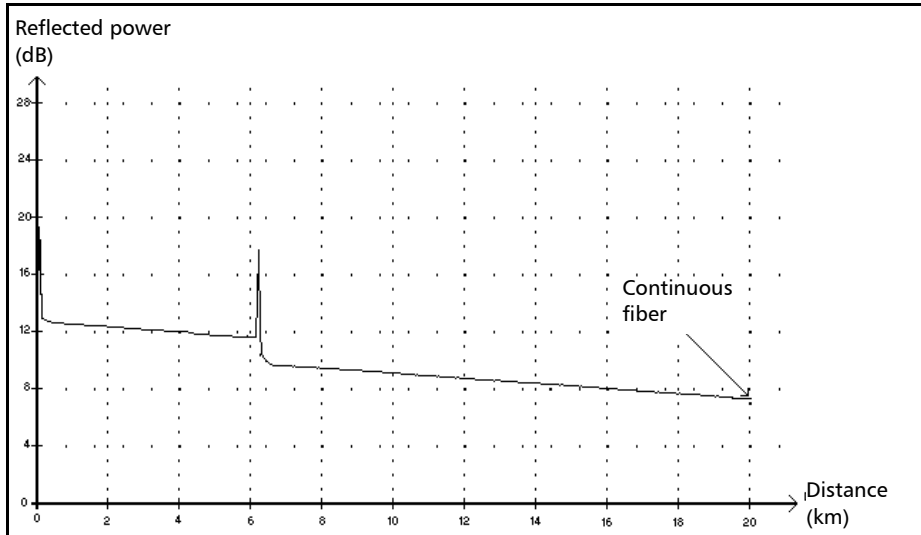

This event indicates that the selected acquisition range was shorter than the fiber length.

- The fiber end was not detected because the analysis process ended before reaching the end of the fiber.
- The acquisition distance range should therefore be increased to a value greater than the fiber length.
- There is no loss or reflectance specified for continuous fiber events.

## Description of Event Types

### End of Analysis

---

## End of Analysis →

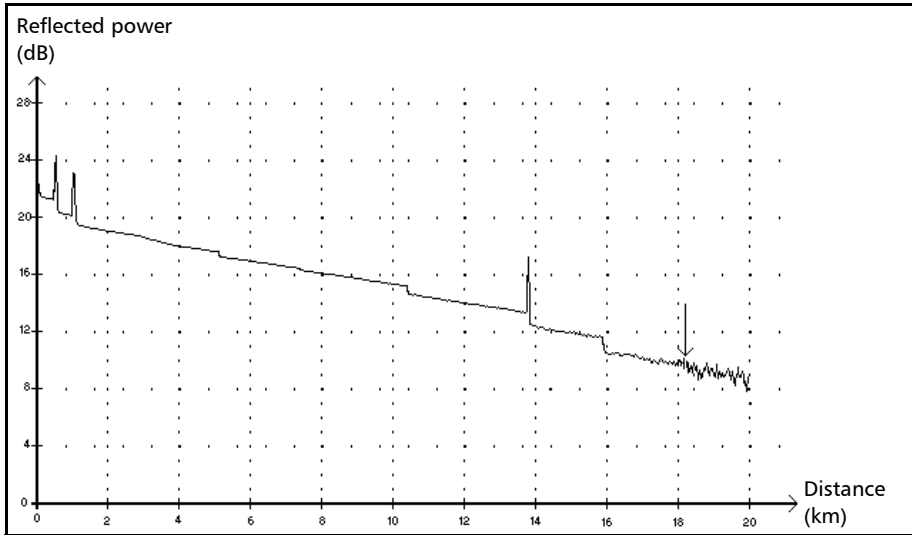

This event indicates that the pulse width used did not provide enough dynamic range to get to the end of the fiber.

- The analysis ended before reaching the end of the fiber because the signal-to-noise ratio was too low.
- The pulse width should therefore be increased so the signal reaches the end of the fiber with a sufficient signal-to-noise ratio.
- There is no loss or reflectance specified for end-of-analysis events.

## Non-Reflective Event

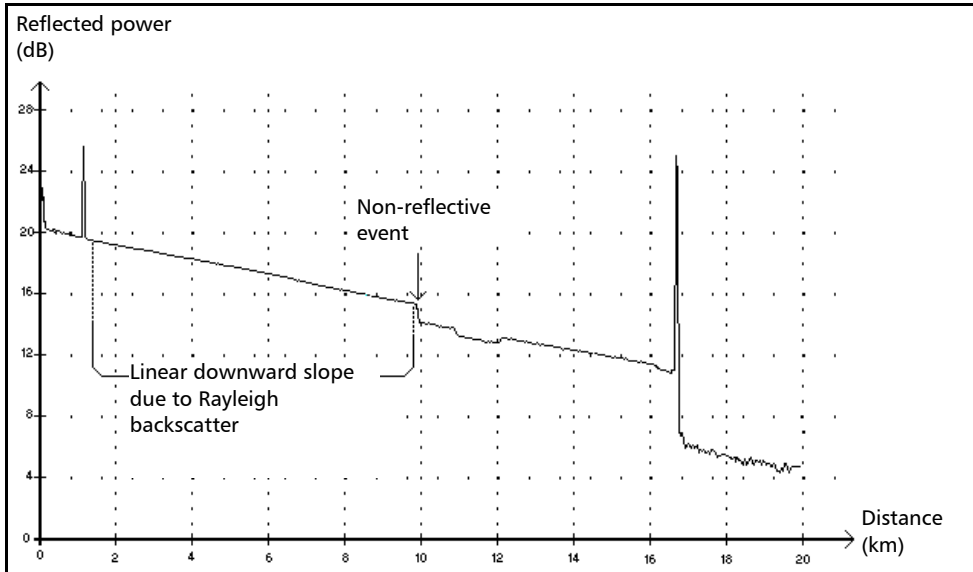

This event is characterized by a sudden decrease in the Rayleigh backscatter signal level. It appears as a discontinuity in the downward slope of the trace signal.

- This event is often caused by splices, macrobends, or microbends in the fiber.
- A loss value is specified for non-reflective events. There is no reflectance specified for this type of event.
- If you set thresholds, the application indicates a non-reflective fault in the events table, whenever a value exceeds the loss threshold (see *Setting Pass/Fail Thresholds* on page 70).

## Description of Event Types

### Reflective Event

## Reflective Event ▮

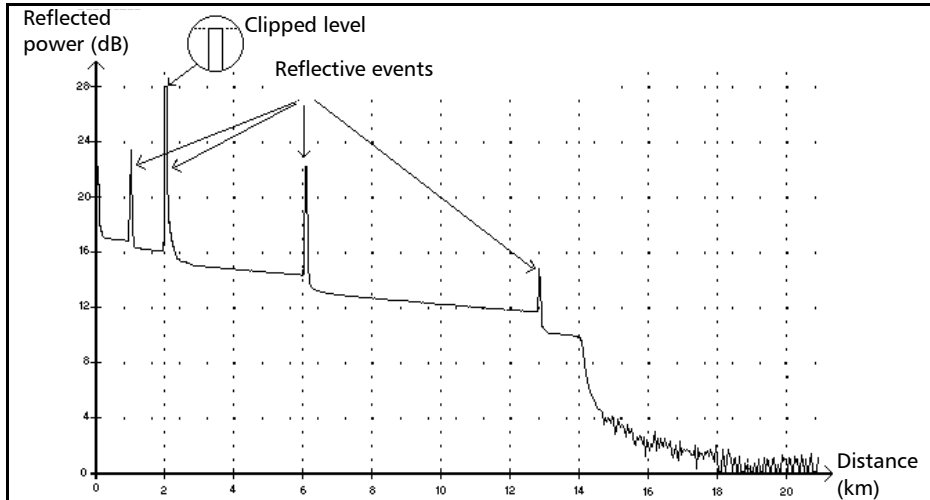

Reflective events appear as spikes in the fiber trace. They are caused by an abrupt discontinuity in the index of refraction.

- Reflective events cause a significant portion of the energy initially launched into the fiber to be reflected back toward the source.
- Reflective events may indicate the presence of connectors, mechanical splices, or even poor-quality fusion splices or cracks.
- Normally, loss and reflectance values are specified for reflective events.
- When the reflective spike reaches the maximum level, its top may be clipped due to the saturation of the detector. As a result, the dead zone (minimum distance for making a detection or attenuation measurement between this event and a second nearby) may be increased.
- If you set thresholds, the application indicates a reflective fault in the events table, whenever a value exceeds reflectance or connector loss thresholds (see *Setting Pass/Fail Thresholds* on page 70).

### Positive Event

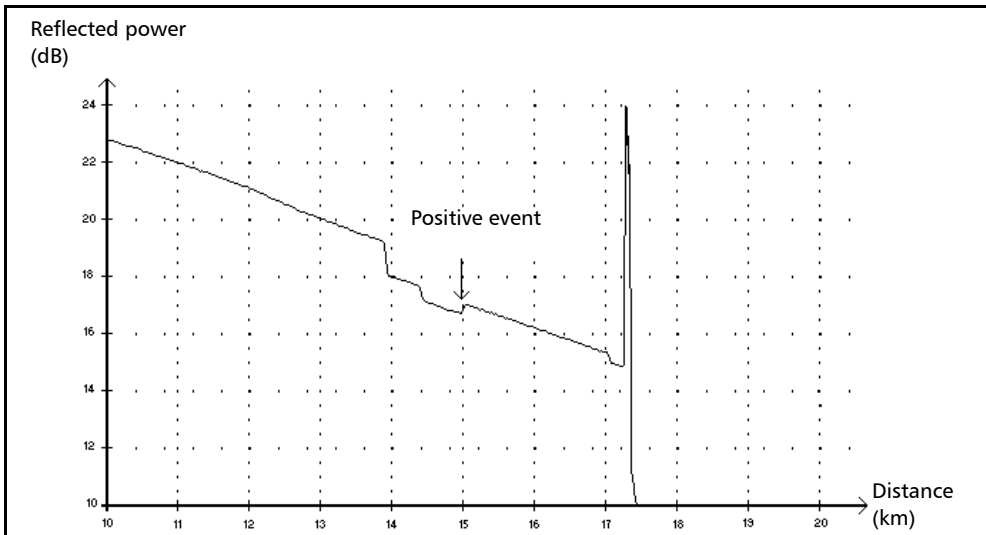

This event indicates a splice with an apparent gain, due to the junction of two fiber sections having different fiber backscatter characteristics (backscatter and backscatter capture coefficients).

A loss value is specified for positive events. The loss specified does not indicate the true loss of the event.

## Description of Event Types

### Launch Level

---

## Launch Level →

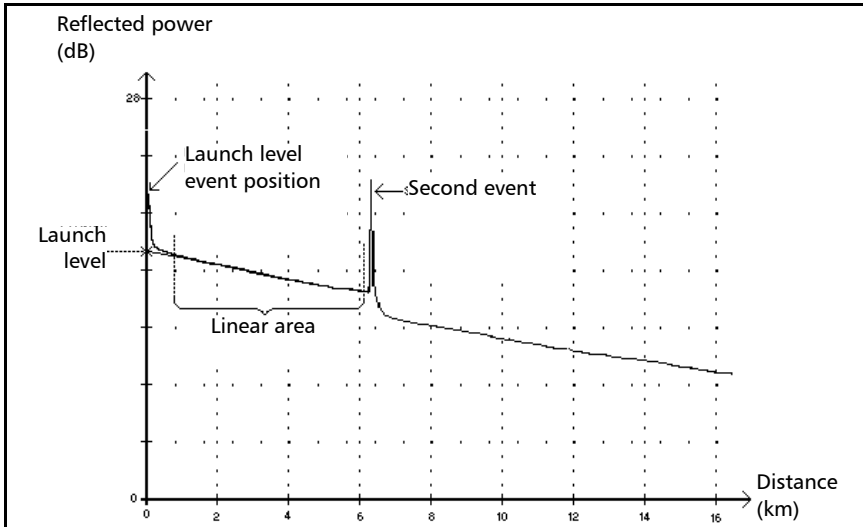

This event indicates the level of the signal launched into the fiber.

- The figure above shows how the launch level is measured.

A straight line is plotted using least-square approximation to fit all trace points in the linear area between the first and second detected events.

The straight line is projected toward the Y-axis (dB) until it crosses the axis.

The crossing point indicates the launch level.

- <<<< in the events table indicates that the launch level is too low.



## Fiber Section

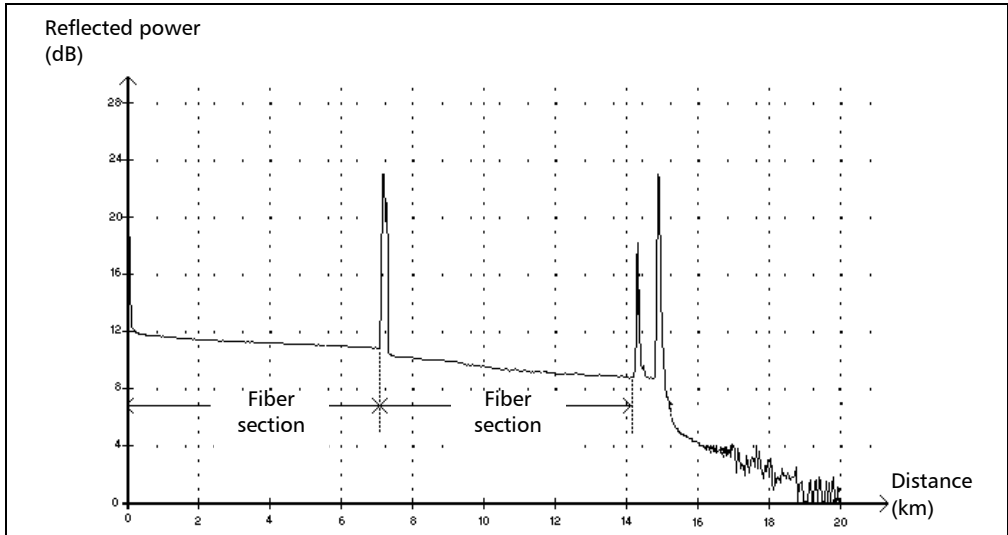

This symbol denotes a fiber section with no event.

- The sum of all fiber sections contained in an entire fiber trace equals the total fiber length. Detected events are distinct even if they cover more than one point on the trace.
- A loss value is specified for fiber section events. No reflectance is specified for this type of event.
- The attenuation (dB/distance in kilometers) is obtained by dividing the loss by the fiber section length.

## Description of Event Types

### Merged Event

## Merged Event $\Sigma$

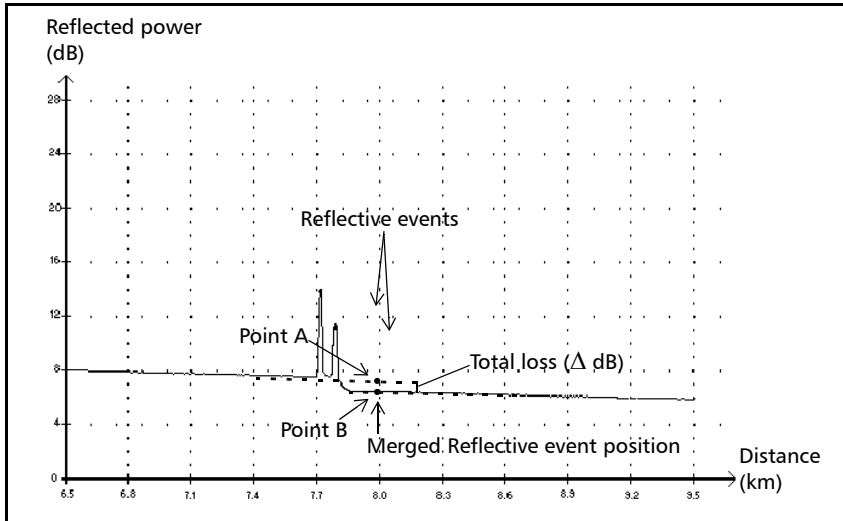

This symbol denotes an event combined with one or more other events. It also indicates the total loss produced by the merged events following it in the events table.

- A Merged Event is composed of subevents. Only the Merged Event is displayed in the events table, not the subevents composing it.
- *Reflective* events may indicate the presence of connectors, mechanical splices, or poor-quality fusion splices or cracks.
- *Non-reflective* events may indicate the presence of splices, splitters or bendings.
- A reflectance value is specified for all merged events and indicates the maximum reflectance for the merged event. A reflectance value is also displayed for each reflective subevent composing the Merged Event.

- The total loss ( $\Delta$  dB) produced by the events is measured by plotting two straight lines.
  - The first line is plotted by fitting, through least-square approximation, trace points in the linear area preceding the first event.
  - The second line is plotted by fitting, through least-square approximation, trace points in the linear area following the second event. If there were more than two merged events, this line would be plotted in the linear area following the last merged event. This line is then projected toward the first merged event.
  - The total loss ( $\Delta$  dB) equals the power difference between the point where the first event begins (point A) and the point on the projected straight line located just below the first event (point B).
  - No loss value can be specified for the subevents.

## Description of Event Types

### *Merged Event*

---

## Pass/Fail Tests

As an example about pass/fail tests, let us consider the situation below:

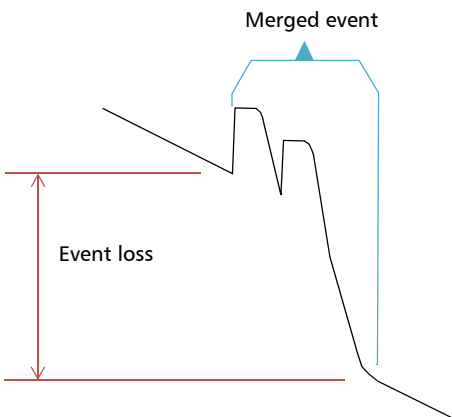

### **Merged sub-events:**

2 reflective losses  
1 non-reflective loss

### **Thresholds:**

Reflective loss: 0.5 dB  
Non-reflective Loss: 0.2 dB

For a merged event, it is possible to determine the global event loss, but not the contribution of each sub-event. This is why the pass/fail test may sometimes lead to “false positive” or “false negative” results.

When evaluating event status against thresholds, we are faced with two possible conditions:

- All event types are tested (reflective, non-reflective)
- Only some event types are selected (for example, you could decide not to test reflective loss)

The third case would be to test none of the event types, which means the same as not wanting to know the status of the events.

## All Event Types Are Tested

In the first case, where all event types are tested, the pass/fail conditions are as follows:

- If the event loss is less than or equal to the smallest threshold value, then the event status is *Pass*.
- If the event loss is greater than the sum of the number of sub-events of a type, multiplied by the threshold value for this event type, then the event status is *Fail*.
- If the event loss is “in between”, since it is not possible to know exactly the weight of a sub-event in the merged event, the global event is considered to have a status of *Pass*.

Pass/Fail Analysis

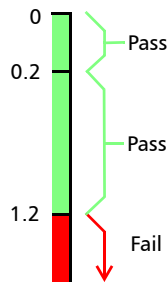

Fail Level

$$\begin{aligned}
 &= \sum(N_{\text{sub}} \times Th_{\text{sub}}) \\
 &= (2 \times 0.5) + (1 \times 0.2) \\
 &= 1.2
 \end{aligned}$$

If the merged event loss is smaller than or equal to 1.2, then the status is *Pass*. Otherwise, it is *Fail*.

## Description of Event Types

### Merged Event

---

### Not All Event Types Are Tested

In this situation, the only thing that we can clearly know is when the loss has a *Pass* status. If the global event loss is less than or equal to the smallest threshold value (a value that is tested, of course), we are sure that the merged event status is *Pass*. Otherwise, we cannot know, so the status of the event is *Unknown*.

In our example, if we suppose that you chose not to test non-reflective losses, then the analysis would be done as shown below:

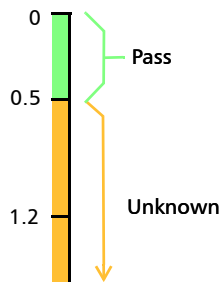

### Effect of Event Status in the Global Trace Status

- A trace status is, by default, set to *Unknown*.
- If a trace is set to *Fail* once, it remains with that status (it cannot be set back to *Pass* or *Unknown*).
- Whenever an event status is *Fail*, so is the trace status.
- If an event status is *Pass*, the trace status can change from *Unknown* to *Pass*.
- If an event status is *Unknown*, the trace status remains the same. In other words, the event, in this case, has no influence on the trace status.

To avoid *Unknown* statuses, do not unselect loss thresholds individually.

## Description of Event Types

### Echo

## Echo $\Pi_{nr}$

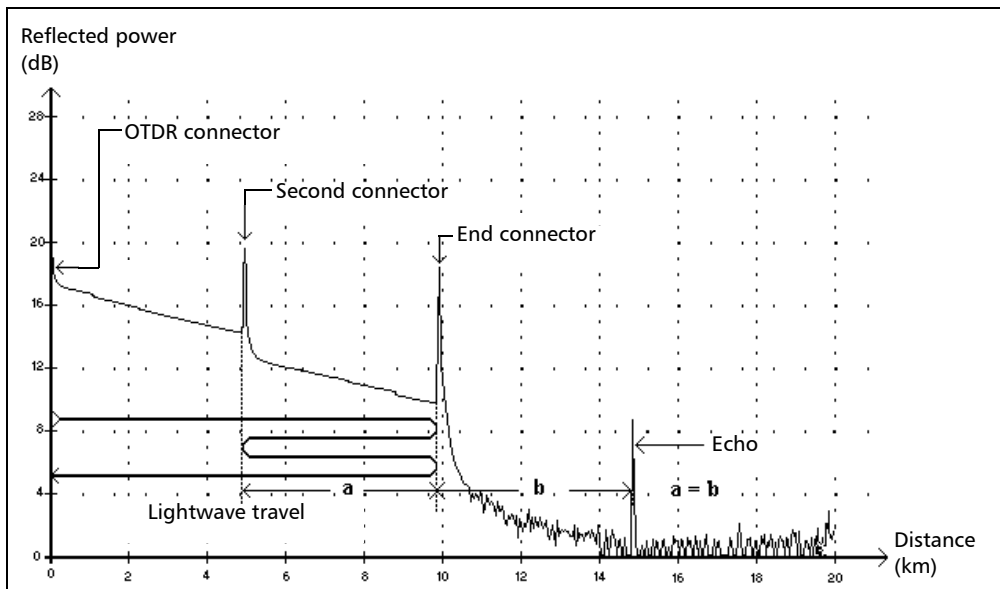

This symbol indicates that a reflective event has been detected after the end of the fiber.

- In the example above, the launched pulse travels up to the end connector and is reflected back toward the OTDR. Then, it reaches the second connector and is reflected again toward the end connector. It is then reflected back to the OTDR.
- The application interprets this new reflection as an echo because of its characteristics (reflectance and particular position with respect to other reflections).
- The distance between the second connector reflection and the end connector reflection is equal to the distance between the end connector reflection and the echo.
- There is no loss specified for echo events.



## Reflective Event (Possible Echo)

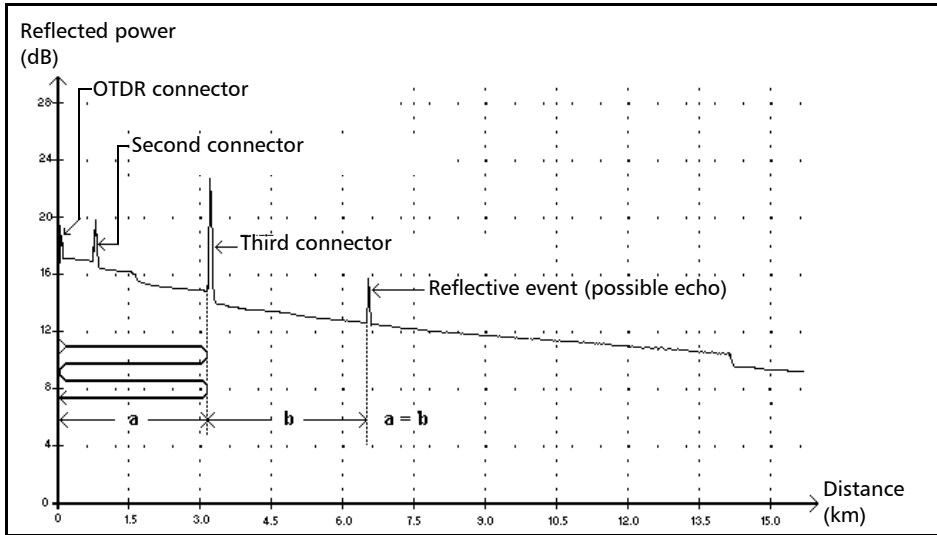

This symbol indicates a reflective event that can be a real reflection or an echo produced by another stronger reflection located closer to the source.

- In the example above, the launched pulse hits the third connector, is reflected back to the OTDR and reflected again into the fiber. It then reaches the third connector a second time and is reflected once more to the OTDR.

The application would therefore detect a reflective event located at twice the distance of the third connector. Since this event is almost null (no loss), and since its distance is a multiple of the third connector distance, The application would interpret it as a possible echo.

- A reflectance value is specified for reflective events (possible echo).



# Index

- \*\*\*\* indication ..... 178
- A**
- AC requirements ..... 16
- accessing power meter..... 251
- accuracy, trace ..... 66
- acquiring traces
- Advanced mode..... 55, 103
  - Auto mode ..... 53
  - Fault finder mode..... 77
- acquisition
- automatic, in Advanced mode..... 55
  - Advanced mode..... 55
  - Auto mode ..... 51
  - changing resolution..... 63
  - custom time values..... 103
  - date..... 186
  - duration..... 136
  - interrupting ..... 51, 56
  - pulse width used ..... 136
  - setting analysis detection thresholds... 152
  - time, autorange..... 60
  - wavelength used ..... 136
- adapter ..... 15
- Advanced mode
- acquiring traces ..... 55
  - acquisition-specific fiber parameters ... 135
  - setting the autorange acquisition time.. 60
  - testing ..... 55
- after-sales service ..... 333
- analysis
- after acquisition..... 68, 155
  - fiber span ..... 157
  - thresholds, detection..... 137, 152
  - thresholds, pass/fail ..... 70
  - traces..... 158
- analyzing a trace. see analysis, after acquisition
- application, starting ..... 38
- Att. column in events table..... 116
- attenuation
- fiber section ..... 70
  - fiber-section threshold..... 70
  - LSA measurement method..... 176
  - measurement..... 176
  - reflectance ..... 178
  - two-point measurement method..... 176
- Auto mode
- acquiring traces ..... 53
  - selecting test wavelength ..... 51, 55
  - setting fiber parameters..... 54
  - testing ..... 51
- automatic acquisition time. see autorange acquisition time
- automatic zoom reset..... 124
- autonaming, OTDR ..... 44, 80
- autorange acquisition time..... 60
- average loss in Trace Info. tab ..... 136
- average splice loss in Trace Info. tab ..... 136
- B**
- basic OTDR theory ..... 9
- battery
- charge status ..... 303
  - clock ..... 224
  - maintenance recommendations..... 303
  - recharging ..... 304
  - replacing or removing..... 305
- browsing Web ..... 248
- buttons, trace editing in events table ..... 117
- buttons, zoom. see controls, zoom

# Index

---

## C

calibrating the touchscreen .....	202
calibration	
certificate .....	317
interval .....	317
capacitors .....	15
capturing images .....	237
car outlet, charging battery with .....	304
caution	
of personal hazard .....	12
of product hazard .....	12
certification information .....	xi
changing batteries .....	305
charger .....	15
checking data integrity .....	331
cleaning	
detector ports .....	302
EUI connectors .....	300
fiber ends .....	42
front panel .....	299
touchscreen .....	303
clearing traces from the display (OTDR) .....	134
color of traces in display .....	109
comments	
deleting .....	148
editing .....	148
connector loss, threshold .....	70
connector, threshold loss .....	70
connectors, cleaning .....	300
controls, zoom .....	125
conventions, safety .....	12
creating PDF files .....	233
Cumul. column in events table .....	116
cumulative loss .....	116
current, electrical .....	16
customer service .....	337

## D

data	
integrity .....	331
points .....	66
retrieving .....	328
date of trace acquisition .....	186
decrementation, file name .....	44, 80
default trace name .....	44, 80
defining personal folders .....	278
definition of the OTDR .....	1
deleting events .....	146
delimiting fiber span .....	130
description	
event types .....	341
keypad .....	7
detection, reflective events .....	158
detector port, cleaning .....	302
dial	
Distance .....	63
moving .....	65
Pulse .....	63
Time .....	63
disappearing marker .....	169
displaying	
fiber sections .....	130
fiber span .....	124
injection level in events table .....	130
pass/fail messages .....	72
traces .....	132
distance	
between events .....	170
equation .....	9
range .....	63
documents, printing .....	233
dual-boot .....	324

- E**
- emergency system tools ..... 324
  - end-of-fiber
    - detection threshold ..... 137, 152
    - event ..... 342
  - equation of distance ..... 9
  - equipment returns ..... 337
  - EUI
    - baseplate ..... 41
    - connector adapter ..... 41
    - dust cap ..... 41
  - EUI connectors, cleaning ..... 300
  - event
    - deleting ..... 146
    - description of types ..... 341
    - difference with fault ..... 9
    - distance measurement ..... 170
    - effect of setting as span start/end . 75, 157
    - insertion ..... 144
    - location ..... 116, 117
    - loss. *see* event loss
    - name, displaying ..... 115
    - non-reflective, averaged loss ..... 136
    - number ..... 116
    - reflectance ..... 116
    - threshold, pass/fail ..... 70
    - unchangeable ..... 140
    - undeletable ..... 146
  - event loss
    - average, in Trace Info. tab ..... 136
    - in events table ..... 116
    - measurement ..... 171
    - total, in Trace Info. tab ..... 136
  - event types
    - description ..... 341
    - continuous fiber ..... 343
    - echo ..... 356
    - end of analysis ..... 344
    - end-of-fiber ..... 342
    - fiber section ..... 349
    - launch level ..... 348
  - merged event ..... 350
  - non-reflective event ..... 345
  - positive event ..... 347
  - reflective event ..... 346
  - reflective event (possible echo) ..... 357
  - short fiber ..... 342
  - span end ..... 342
  - span start ..... 342
  - events
    - comments ..... 148
    - view ..... 110
  - events table
    - locating event ..... 117
    - trace editing buttons ..... 117
  - EXFO universal interface. *see* EUI
  - Explorer, Internet ..... 248
  - external power supply ..... 15
- F**
- Fault finder
    - acquiring traces ..... 77
    - testing ..... 77
  - fiber
    - attenuation ..... 116
    - attenuation threshold for section ..... 70
    - identifying by name ..... 44, 80, 185
    - identifying visually ..... 193
    - section attenuation ..... 70
    - sections display ..... 130
    - span length ..... 136
    - type in Trace Info. tab ..... 136
    - see also* fiber span ..... 75
  - fiber ends, cleaning ..... 42
  - fiber parameters
    - setting ..... 135
    - setting default values ..... 61
  - fiber span
    - analysis ..... 157
    - average loss in Trace Info. tab ..... 136
    - average splice loss in Trace Info. tab .... 136
    - delimitation ..... 130

# Index

---

length in Trace Info. tab ..... 75, 136  
  setting ..... 75  
  span loss in Trace Info. tab ..... 136  
  zooming (automatic) ..... 124  
file name, in trace display ..... 90, 128  
first connector check ..... 48, 87  
Flash Player, installing ..... 246  
folders, removing ..... 278  
forced selection of test wavelength ..... 54, 58  
four-point measurement method vs. LSA.. 171  
Fresnel reflection ..... 10  
front panel, cleaning ..... 299

## G

General tab ..... 90, 128  
grid display ..... 90, 128

## H

hazard, laser radiation ..... 14  
helix factor  
  admissible values ..... 61  
  in Trace Info. tab ..... 137  
  modification ..... 135  
  setting ..... 61  
hiding traces ..... 132  
high-resolution feature ..... 66

## I

identification label ..... 333  
image formats ..... 240  
incrementation, file name ..... 44, 80  
injection level  
  in events table ..... 130  
  too low ..... 48, 87  
input current ..... 16  
inserting comments ..... 148  
installing, Flash Player ..... 246  
integrity, data ..... 331  
Internet, Explorer ..... 248

## IOR

in Trace Info. tab ..... 137  
modification ..... 135  
obtaining ..... 61  
setting ..... 61

## K

keypad description ..... 7

## L

label, identification ..... 333  
laser safety information ..... 14  
laser, using OTDR as source ..... 193  
launch level ..... 310  
least-square approximation. see LSA  
level of injection, warning ..... 48, 87  
linear view ..... 110  
Loc. in events table ..... 116  
locating events ..... 117  
loss  
  average for fiber span ..... 136  
  average splice ..... 136  
  connector ..... 70  
  connector, threshold ..... 70  
  cumulative for fiber span ..... 136  
  in events table ..... 116  
  measurement ..... 171  
  measurement, positioning markers ..... 175  
  modification ..... 140  
  non-reflective events average ..... 136  
  span threshold ..... 70  
  splice ..... 70  
  splice, threshold ..... 70  
LSA measurement method  
  definition ..... 176  
  vs. four-point ..... 171  
  vs. two-point ..... 176

- 
- M**
- macrobends, viewing ..... 113
  - maintenance
    - battery ..... 303
    - detector ports ..... 302
    - EUI connectors ..... 300
    - front panel ..... 299
    - general information ..... 299
    - touchscreen ..... 303
  - marker
    - disappearing on zoom ..... 169
    - location calculation ..... 141
    - too close to one another ..... 169
  - maximum input current ..... 16
  - measurement
    - attenuation (two-point and LSA) ..... 176
    - event distance ..... 170
    - event loss ..... 171
    - event RBS level ..... 170
    - ORL ..... 179
    - units ..... 92, 99
  - modifying storage parameters ..... 240
  - mounting EUI connector adapter ..... 41
  - multiwavelength trace
    - color in display ..... 109
    - file displaying ..... 132
- N**
- naming trace automatically ..... 44, 80
  - native trace format ..... 182
  - navigating the Internet ..... 248
  - noise area, searching ..... 158
  - non-reflective event, averaged loss ..... 136
  - number
    - in events table ..... 116
    - of the event ..... 116
- O**
- opening trace file ..... 162
  - optical return loss. *see* ORL
  - options
    - software ..... 33
    - used at startup ..... 210
  - ORL
    - module required for calculations ..... 179
    - threshold ..... 70
  - OTDR
    - basic theory ..... 9
    - definition ..... 1
    - file compatibility between versions ..... 182
    - internal components ..... 10
    - using as laser source ..... 193
  - OTDR software, launch level ..... 310
- P**
- parameters
    - Advanced mode ..... 60
    - helix factor ..... 61
    - IOR ..... 61
    - Rayleigh backscatter coefficient ..... 61
    - trace display ..... 90, 128
  - pass/fail test
    - disabling ..... 71
    - enabling ..... 71
    - when to perform ..... 71
  - pass/fail, message display ..... 72
  - PDF files, generating ..... 233
  - photodetector ..... 9
  - power button ..... 7
  - power meter, accessing ..... 251
  - power source, AC ..... 16
  - power supply ..... 15
  - precision, trace ..... 66
  - predefined folders ..... 278
  - printing documents ..... 233

# Index

---

- product
  - identification label..... 333
  - specifications..... 339
- protective cap ..... 302
- pulse
  - dial ..... 63
  - in Trace Info. tab ..... 136
  - setting width ..... 63
- purchased options..... 33

**R**

- radiation hazard, laser..... 14
- RBS (Rayleigh backscatter)
  - description..... 10
  - in Trace Info. tab ..... 137
  - level measurement event..... 170
  - modification ..... 135
  - obtaining..... 61
  - setting ..... 61
- reading Flash files ..... 246
- re-analyzing a trace..... 155
- recalibration..... 317
- Refl. column in events table ..... 116
- reflectance
  - attenuation..... 178
  - detection threshold ..... 137, 152
  - modification ..... 140
  - of event ..... 116
  - of non-reflective events ..... 178
  - source of inaccurate measurements ..... 62
  - threshold ..... 70
- reflective ends of fiber..... 158
- reflective events, detecting..... 158
- repairing unit ..... 15
- replacing or removing battery..... 305
- report
  - generating ..... 187
  - of trace..... 185

- resetting fiber parameters, Auto mode ..... 54
- restoring system partition ..... 325
- retrieving data ..... 328
- return merchandise authorization (RMA) .. 337

## S

- safety
  - caution ..... 12
  - conventions ..... 12
  - information..... 14
  - warning ..... 12
- same pulse and time for all wavelengths..... 64
- saving
  - format, native ..... 182
  - formats, others ..... 181
- screenshots, taking..... 237
- selecting
  - Automatic OTDR test wavelength .... 51, 55
  - test wavelength, automatically ..... 54, 58
  - wavelength in Auto mode ..... 51, 55
- service and repairs..... 337
- service centers ..... 338
- setting
  - fiber span..... 75
  - pass/fail thresholds ..... 70
- shipping to EXFO..... 337
- signal-to-noise ratio ..... 64
- software
  - options ..... 33
  - options at startup ..... 210
- software. *see* application
- source *see also* laser
- source, function overview..... 193
- span
  - length threshold ..... 70
  - loss threshold..... 70
  - position, updating ..... 157
- span end
  - description..... 342
  - effect of setting on events table .... 75, 157



- span start
    - description..... 342
    - effect of setting on events table .... 75, 157
  - specifications, product ..... 339
  - splice loss
    - average, in Trace Info. tab ..... 136
    - detection threshold ..... 137, 152
    - threshold ..... 70
  - startup option ..... 210
  - stopping trace acquisition ..... 51, 56
  - storage requirements ..... 299
  - storage, path ..... 240
  - storing
    - changing default trace name ..... 44, 80
    - trace autonaming ..... 44, 80
  - summary table ..... 112, 113
  - surfing the Internet ..... 248
  - swapping traces ..... 161
  - symbols, safety ..... 12
  - system
    - emergency tools ..... 324
    - partition, restoring ..... 325
- T**
- technical specifications..... 339
  - technical support ..... 333
  - temperature for storage..... 299
  - test wavelength, forced selection..... 54, 58
  - testing
    - Advanced mode..... 55
    - Auto mode ..... 51
    - Fault finder ..... 77
  - theory, OTDR..... 9
  - thresholds
    - analysis detection ..... 152
    - connector loss ..... 70
    - end-of-fiber detection ..... 152
    - fiber section attenuation ..... 70
    - fiber-section attenuation ..... 70
    - ORL..... 70
    - pass, fail, warning ..... 72
    - reflectance ..... 70
    - reflectance detection ..... 137, 152
    - setting pass/fail ..... 70–71
    - span length..... 70
    - span loss ..... 70
    - splice loss..... 70
    - splice loss detection ..... 137, 152
    - trace analysis ..... 70
  - time
    - custom values ..... 103
    - Trace Info. tab..... 136
  - Time dial
    - custom-time mode..... 103
    - setting ..... 63
  - timer..... 39
  - tools system, emergency ..... 324
  - total loss in Trace Info. tab ..... 136
  - touchscreen
    - activating keyboard ..... 89, 105
    - calibrating..... 202
    - cleaning ..... 303
  - trace
    - accuracy..... 66
    - acquisition in Advanced mode ..... 55
    - acquisition in Auto mode..... 53
    - acquisition in Fault finder mode ..... 77
    - analysis ..... 155
    - analysis detection thresholds ..... 152
    - autonaming ..... 44, 80
    - changing default name..... 44, 80
    - color in trace display ..... 109
    - compatibility between ToolBox versions..... 182
    - editing buttons ..... 117
    - export formats ..... 181
    - formats ..... 181
    - formats, native..... 182
    - opening file..... 162
    - pass/fail analysis threshold..... 70
    - purpose of swapping ..... 161
    - re-analyzing ..... 155
    - stopping the acquisition ..... 51, 56

# Index

---

- storage, in different formats..... 181
- swapping..... 161
- trace display
  - behavior on zoom ..... 125
  - clearing traces ..... 134
  - displaying file name..... 90, 128
  - parameters ..... 90, 128
- Trace Info. tab
  - average loss ..... 136
  - average splice loss ..... 136
  - backscatter ..... 137
  - displaying traces..... 132
  - end-of-fiber threshold ..... 137
  - fiber type used..... 136
  - helix factor..... 137
  - hiding traces..... 132
  - IOR ..... 137
  - pulse..... 136
  - reflectance threshold ..... 137
  - span length ..... 136
  - splice loss threshold..... 137
  - time..... 136
  - total loss..... 136
  - wavelength..... 136
- trace report
  - creating ..... 185
  - generating ..... 187
- transportation requirements ..... 299, 334
- two-point
  - attenuation..... 176
  - measurement method vs. LSA ..... 176
  - measurement method, definition ..... 176
- type
  - in events table ..... 116
  - of event ..... 116

## U

- unchangeable events..... 140
- undeletable events ..... 146
- unit
  - repairing ..... 15
  - restoring ..... 325
- unit recalibration ..... 317
- UPC connectors, detecting ..... 158
- updating span position ..... 157

## V

- view
  - linear..... 110
  - summary..... 112, 113

## W

- warning thresholds..... 72
- warranty
  - certification..... 336
  - exclusions ..... 336
  - general..... 335
  - liability..... 336
  - null and void..... 335
- wavelength
  - indication in Trace Info. tab ..... 136
  - selecting, in Auto mode ..... 51, 55
- Web browser ..... 248

## Z

- zoom
  - controls..... 125
  - resetting automatically ..... 124
  - window display..... 128

## NOTICE 通告

### CHINESE REGULATION ON RESTRICTION OF HAZARDOUS SUBSTANCES 中国关于有害物质限制的规定

NAMES AND CONTENTS OF THE TOXIC OR HAZARDOUS SUBSTANCES OR ELEMENTS  
CONTAINED IN THIS EXFO PRODUCT  
包含在本 **EXFO** 产品中的有毒有害物质或元素的名称和含量



O	Indicates that this toxic or hazardous substance contained in all of the homogeneous materials for this part is below the limit requirement in SJ/T11363-2006 表示该有毒有害物质在该部件所有均质材料中的含量均在 SJ/T11363-2006 标准规定的限量要求以下。
X	Indicates that this toxic or hazardous substance contained in at least one of the homogeneous materials used for this part is above the limit requirement in SJ/T11363-2006 表示该有毒有害物质至少在该部件的某一均质材料中的含量超出 SJ/T11363-2006 标准规定的限量要求。

Part Name 部件名称	Toxic or hazardous Substances and Elements 有毒有害物质和元素					
	Lead 铅 (Pb)	Mercury 汞 (Hg)	Cadmium 镉 (Cd)	Hexavalent Chromium 六价铬 (Cr VI)	Polybrominated biphenyls 多溴联苯 (PBB)	Polybrominated diphenyl ethers 多溴二苯醚 (PBDE)
Enclosure 外壳	O	O	O	O	O	O
Electronic and electrical sub-assembly 电子和电子组件	X	O	X	O	X	X
Optical sub-assembly <sup>a</sup> 光学组件 <sup>a</sup>	X	O	O	O	O	O
Mechanical sub-assembly <sup>a</sup> 机械组件 <sup>a</sup>	O	O	O	O	O	O

a. If applicable.  
如果适用。

MARKING REQUIREMENTS

标注要求

Product 产品	Environmental protection use period (years) 环境保护使用期限 (年)	Logo 标志
This Exfo product 本 EXFO 产品	10	
Battery <sup>a</sup> 电池 <sup>a</sup>	5	

a. If applicable.  
如果适用。

P/N: 1062544

[www.EXFO.com](http://www.EXFO.com) · [info@exfo.com](mailto:info@exfo.com)

<b>CORPORATE HEADQUARTERS</b>	400 Godin Avenue	Quebec (Quebec) G1M 2K2 CANADA Tel.: 1 418 683-0211 · Fax: 1 418 683-2170
<b>EXFO AMERICA</b>	3400 Waterview Parkway Suite 100	Richardson, TX 75080 USA Tel.: 1 972-761-927 · Fax: 1 972-761-9067
<b>EXFO EUROPE</b>	Omega Enterprise Park, Electron Way	Chandlers Ford, Hampshire S053 4SE ENGLAND Tel.: +44 2380 246810 · Fax: +44 2380 246801
<b>EXFO ASIA-PACIFIC</b>	100 Beach Road, #22-01/03 Shaw Tower	SINGAPORE 189702 Tel.: +65 6333 8241 · Fax: +65 6333 8242
<b>EXFO CHINA</b>	Beijing Global Trade Center, Tower C, Room 1207, 36 North Third Ring Road East, Dongcheng District	Beijing 100013 P. R. CHINA Tel.: +86 (10) 5825 7755 · Fax: +86 (10) 5825 7722
<b>EXFO SERVICE ASSURANCE</b>	270 Billerica Road	Chelmsford MA, 01824 USA Tel.: 1 978 367-5600 · Fax: 1 978 367-5700
<b>EXFO NETHAWK</b>	Elektroniikkatie 2	FI-90590 Oulu, FINLAND Tel.: +358 (0) 403 010 300 · Fax: +358 (0) 8 564 5203
<b>TOLL-FREE</b>	(USA and Canada)	1 800 663-3936

© 2012 EXFO Inc. All rights reserved.  
Printed in Canada (2012-05)



**EXFO**  
EXPERTISE REACHING OUT