

PPM-350C

PON Power Meter



Copyright © 2009–2012 EXFO Inc. All rights reserved. No part of this publication may be reproduced, stored in a retrieval system or transmitted in any form, be it electronically, mechanically, or by any other means such as photocopying, recording or otherwise, without the prior written permission of EXFO Inc. (EXFO).

Information provided by EXFO is believed to be accurate and reliable. However, no responsibility is assumed by EXFO for its use nor for any infringements of patents or other rights of third parties that may result from its use. No license is granted by implication or otherwise under any patent rights of EXFO.

EXFO's Commerce And Government Entities (CAGE) code under the North Atlantic Treaty Organization (NATO) is 0L8C3.

The information contained in this publication is subject to change without notice.

Trademarks

EXFO's trademarks have been identified as such. However, the presence or absence of such identification does not affect the legal status of any trademark.

Units of Measurement

Units of measurement in this publication conform to SI standards and practices.

Patents

EXFO's Universal Interface is protected by US patent 6,612,750.

The PPM-350C is protected by US patent no. 7,187,861, German Utility Patent no. 20 2004 021 208.0, and subject of several pending national entries in other countries under the Patent Cooperation Treaty.

Version number: 4.0.0

Contents

Certification Information	v
European Community	
Declaration of Conformity	vi
1 Introducing the PPM-350C PON Power Meter	1
Main Features	1
Available Models	3
Power Sources	3
Typical Applications	4
Conventions	5
2 Safety Information	6
Laser Safety Information (Models with VFL)	6
Electrical Safety Information	6
Ultra-High-Power™ Safety Information	7
3 Getting Started with Your PON Power Meter	8
Turning the Unit On and Off	8
Activating Automatic Shutdown (Auto-Off)	10
Installing the EXFO Universal Interface (EUI)	10
Cleaning and Connecting Optical Fibers	11
Nulling Electrical Offsets	12
4 Configuring Thresholds, Correction Factors, Wavelength List, and Storage Details	13
5 Working in FTTx Mode	14
Selecting a Threshold Set	14
Testing in Pass/Fail Mode or in Normal Mode	16
6 Working in OPM Mode	18
7 Managing Test Results	19
Storing Data	19
Recalling Data	21
Deleting Data	22
Transferring Data to a Computer	22
8 Identifying Fiber Faults Visually	23
9 Maintenance	24
Cleaning EUI Connectors	25
Replacing Disposable Alkaline Batteries	27
Recalibrating the Unit	27
Verifying the Integrity of User Information in Memory	28
Verifying the LEDs and LCD	29
Recycling and Disposal (Applies to European Union Only)	29
10 Troubleshooting	30
Solving Common Problems	30
Error Codes and Descriptions	31
Contacting the Technical Support Group	33
Transportation	34

11 Warranty	35
General Information	35
Liability	35
Exclusions	36
Certification	36
Service and Repairs	37
EXFO Service Centers Worldwide	38
A Technical Specifications	39

Certification Information

North America Regulatory Statement

This unit was certified by an agency approved in both Canada and the United States of America. It has been evaluated according to applicable North American approved standards for product safety for use in Canada and the United States.

Electronic test and measurement equipment is exempt from FCC part 15, subpart B compliance in the United States of America and from ICES-003 compliance in Canada. However, EXFO Inc. makes reasonable efforts to ensure compliance to the applicable standards.

The limits set by these standards are designed to provide reasonable protection against harmful interference when the equipment is operated in a commercial environment. This equipment generates, uses, and can radiate radio frequency energy and, if not installed and used in accordance with the user guide, may cause harmful interference to radio communications. Operation of this equipment in a residential area is likely to cause harmful interference in which case the user will be required to correct the interference at his own expense.

Modifications not expressly approved by the manufacturer could void the user's authority to operate the equipment.

European Community Declaration of Conformity

DECLARATION OF CONFORMITY

Application of Council Directive(s): 2006/95/EC – The Low Voltage Directive
2004/108/EC – The EMC Directive
93/68/EEC – CE Marking
And their amendments

Manufacturer's Name and Address: **EXFO Inc.**
400 Godin Avenue
Quebec City, Quebec
G1M 2K2 CANADA
Tel.: +1 418 683-0211

EXFO Europe
Omega Enterprise Park, Electron Way
Chandlers Ford, Hampshire
SO53 4SE ENGLAND
Tel.: +44 2380 246810

Equipment Type/Environment: Test & Measurement / Industrial
Trade Name/Model No.: PON Power Meter / PPM-350B & PPM-350C

Standard(s) to which Conformity is declared:

EN 61010-1:2001 Edition 2.0	Safety requirements for electrical equipment for measurement, control, and laboratory use – Part 1: General requirements
EN 61326-1:2006	Electrical equipment for measurement, control and laboratory use – EMC requirements – Part 1: General requirements
EN 60825-1:2007 Edition 2.0	Safety of laser products – Part 1: Equipment classification and requirements

I, the undersigned, hereby declare that the equipment specified above conforms to the above Directive and Standards.

Manufacturer:



Stephen Bull, E. Eng
Vice-President Research and Development

400 Godin Avenue,
Quebec City, Quebec
G1M 2K2 CANADA
January 09, 2009

1 **Introducing the PPM-350C PON Power Meter**

The PPM-350C PON Power Meter was designed for two main purposes:

- Suit FTTP testing needs and to be easy to use for people who are not necessarily familiar with fiber optics in FTTx.
- Be used as a standard optical power meter (OPM operation mode).

Main Features

FTTx Operation Mode

- Supports:
 - Port 1: 1310 nm (ONT)
 - Port 2: 1490 nm (OLT)/1550 nm (video)
- Pass-through device (spy mode): does not block communication between ONT and OLT.
- Allows triple-play testing (voice, video and data).
- Measures each signal independently: Optical Network Terminal (ONT) - 1310 nm; central office (CO) - 1490 nm and 1550 nm.
- Measures optical power of any type of signal:
 - Continuous (for example, TV signal at 1550 nm)
 - Framed (for example, ATM, Ethernet at 1490 nm or 1310 nm)
 - All baud rates (for example, 155 Mbps, 1 Gbps; synchronous or asynchronous)
- Measures all signals simultaneously.
- Features visual Pass/Fail indicators (one indicator per wavelength; all signal statuses are displayed simultaneously).
- Displays all power levels simultaneously.
- Contains up to 10 different threshold sets (you can configure thresholds on a computer and transfer them to your PPM-350C with a USB cable).

Optical Power Meter (OPM) Operation Mode

- ▶ 3 calibrated wavelengths and up to 40 predefined wavelengths (from 1260 nm to 1650 nm), each with their own correction factor.
- ▶ Possible to take reference values for each of the available wavelengths.
- ▶ Selectable unit (dB or dBm).

Other Useful Features

- ▶ Automatically shuts down after 10 minutes of idle time (auto-off).
- ▶ You can manage data directly on the unit (storing, recalling, deleting).
- ▶ The Handheld Data Transfer (provided on your CD) enables you to create new threshold sets and correction factors, define your list of favorite wavelengths, as well as set storage and job options for better data management, or modify values retrieved from your unit.
- ▶ You can transfer the data (measurements) directly from your unit to a computer using the USB port. This will allow you to view them with FastReporter, the EXFO's post-processing software.

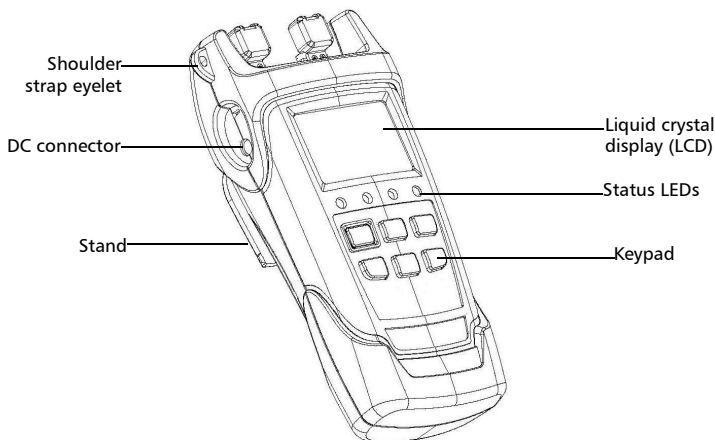

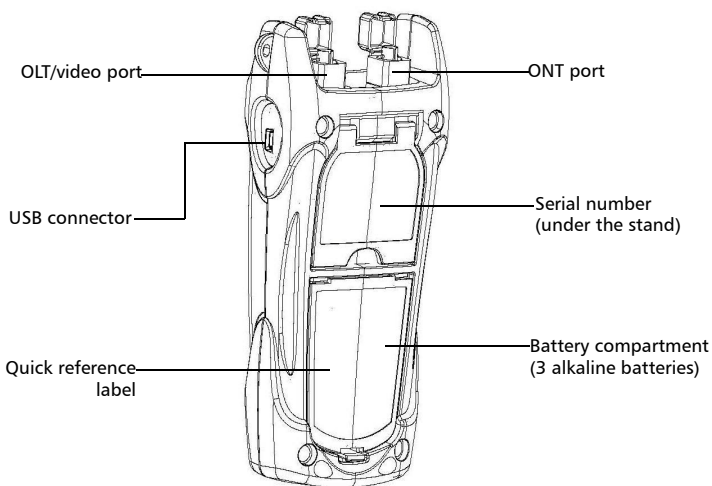

Available Models



The PON Power Meter is offered in two wavelength/ ports configurations:

- ▶ 1310 nm (FTTx) / 1490 nm (FTTx/OPM)
- ▶ 1310 nm (FTTx) and 1490 nm/1550 nm (FTTx/OPM)

An optional VFL is also available.

Power Sources

The PON Power Meter operates with the following power sources:

- ▶ AC adapter (connected to standard power outlet—indoor use only) 
- ▶ AA alkaline batteries (automatically take over if you unplug the AC adapter) 
The icon also indicates the battery charge.



IMPORTANT

If the battery level becomes too low, the unit turns itself off.

Typical Applications

You can use your PON Power Meter in two modes:

- ▶ **FTTx mode:** You can use your PPM-350C PON Power Meter during service activation (at ONT) or to troubleshoot passive optical networks (at ONT, drop terminal, fiber distribution hub or CO). This mode allows you to measure two or three wavelengths simultaneously, depending on the configuration of the unit.

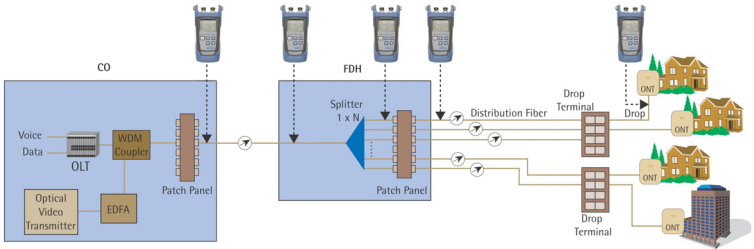

- ▶ **OPM mode:** You can use your PPM-350C PON Power Meter to measure the output power (in dBm) or loss (in dB) using one of the unit's 40 CWDM wavelengths available. This mode allows you to measure networks or devices carrying only one wavelength.

Conventions

Before using the product described in this guide, you should understand the following conventions:



WARNING

Indicates a potentially hazardous situation which, if not avoided, could result in *death or serious injury*. Do not proceed unless you understand and meet the required conditions.



CAUTION

Indicates a potentially hazardous situation which, if not avoided, may result in *minor or moderate injury*. Do not proceed unless you understand and meet the required conditions.



CAUTION

Indicates a potentially hazardous situation which, if not avoided, may result in *component damage*. Do not proceed unless you understand and meet the required conditions.



IMPORTANT

Refers to information about this product you should not overlook.

2 Safety Information



WARNING

The use of controls, adjustments and procedures other than those specified herein may result in exposure to hazardous situations or impair the protection provided by this unit.



WARNING

Do not install or terminate fibers while a laser source is active. Never look directly into a live fiber and ensure that your eyes are protected at all times.



IMPORTANT

When you see the following symbol on your unit , make sure that you refer to the instructions provided in your user documentation. Ensure that you understand and meet the required conditions before using your product.

Laser Safety Information (Models with VFL)

Your instrument is a Class 3R laser product in compliance with standards IEC 60825-1 and 21 CFR 1040.10. It is potentially harmful in direct intrabeam viewing.

The following label(s) indicate that the product contains a Class 3R source:

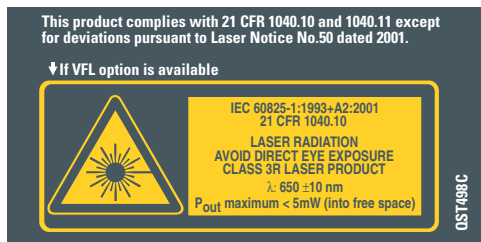

The label is affixed at the back of your unit if the VFL option is present.

Electrical Safety Information



WARNING

Use the AC adapter provided with this product *indoors only*.

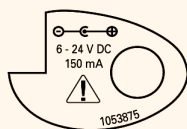

Ultra-High-Power™ Safety Information



WARNING

When using high-power live fiber, use protective eyewear and clothes to avoid contact with light or heat emanating from the detector port. Refer to safety measures valid in your country for more information.

To avoid personal injury or damage to your unit, connect high-power live fiber to the detector port only.



CAUTION

Do not use plastic FOAs when manipulating high-power live fiber. This will cause the plastic FOAs to melt.



WARNING

If a laser with a power of more than 25 dBm is connected to one of the ports of the PPM-350C, light may come out from the other port, even if the protective cap is on. Do not consider that the protective cap is sufficient protection in such high-power laser cases.

Equipment Ratings

Temperature	
➤ Operation	-10 °C to 50 °C (14 °F to 122 °F)
➤ Storage	-40 °C to 70 °C (-40 °F to 158 °F)
Relative humidity	0 % to 95 % non-condensing
Maximum operation altitude	2000 m (6562 ft)
Pollution degree	2 (unit used inside; connected to AC mains or powered by batteries) ^a 3 (unit used outside; powered by batteries) ^b
Overvoltage category	II
Power supply rating	 6 - 24 V; 150 mA

a. Use the external power supply indoors only.

b. Equipment should be normally protected against exposure to direct sunlight, precipitations and full wind pressure.

3 Getting Started with Your PON Power Meter

Turning the Unit On and Off

When you turn the PON Power Meter off, it saves the current settings, which include:

- ▶ for the FTTx operation: the mode (Pass/Fail or Normal) and threshold set.
- ▶ for the OPM operation: the unit, reference values, and wavelength.



IMPORTANT

If you remove batteries (and the AC adapter is unplugged), the unit will turn off *without saving the above values*.

If batteries are low (and the AC adapter is unplugged), the unit will save the above values and turn off.

Note: *Offset nulling values are always returned to factory settings.*

To turn the unit on:

Press . The unit displays **EXFO** for a few seconds and vertical bars move at the top of the display, indicating the initialization is in progress. You may use your unit immediately under normal conditions. The unit uses the settings as they were saved last time you turned it off.

To turn the unit off:

Hold down  a few seconds. The unit saves the current settings automatically.

Display

Indicates the presence of "keep-alive" signal (which prevents communication loss during periods of idleness) or any other data packet

Signal (wavelength);
FTTx operation only

Information fields
that will be stored

Batteries in use
(with level;
blinking when
weak)

AC adapter plugged in

Correction factor not
equal to 0 dB

Auto-off activated

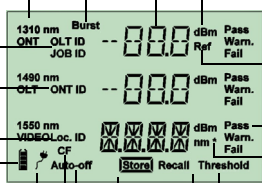

Power level

Units

Reference values displayed;
OPM operation only

Status; FTTx operation only

Selected wavelength
corresponds to a calibration
wavelength;
OPM operation only

Threshold selection mode activated;
FTTx operation only

Storage mode either to save results
or recall settings.

Keypad

PRESS: Activates/deactivates Pass/Fail mode
(not possible during nulling, threshold verification,
LEDs/LCD verification)

HOLD: Selects the FTTx or OPM measurement

PRESS: For FTTx
operation, accesses
threshold selection mode;
for OPM operation,
selects the next
wavelength in the list.

HOLD: For FTTx operation,
displays the current
threshold values.

PRESS: Turns unit on
Controls auto-off
Exits special modes
HOLD: Turns unit off



(available only for OPM)

PRESS: Switches between dBm
and dB units

HOLD: Takes the input power as
reference power

PRESS: In selection
mode, goes to the next
value; for OPM
operation, goes to the
next wavelength in the
list

HOLD: If VFL option is
present, changes the
VFL state between OFF,
ON CW and ON 1 Hz

PRESS: Accesses the storage
mode; in selection mode, selects
the value.

HOLD: Accesses the data recall
mode; in Recall mode, accesses
the delete item function

Activating Automatic Shutdown (Auto-Off)

When auto-off is activated, the unit will turn itself off after 10 minutes of idle time.

Auto-off is activated by default when you turn unit on.

To deactivate/reactivate auto-off:

Press .

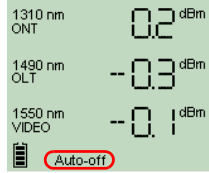

Installing the EXFO Universal Interface (EUI)

The EUI fixed baseplate is available for connectors with angled (APC) or non-angled (UPC) polishing. A green border around the baseplate indicates that it is for APC-type connectors.

Green border
indicates APC
option

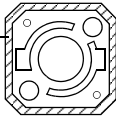

Bare metal
(or blue border)
indicates UPC option

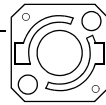

To install an EUI connector adapter onto the EUI baseplate:

1. Hold the EUI connector adapter so the dust cap opens downwards.

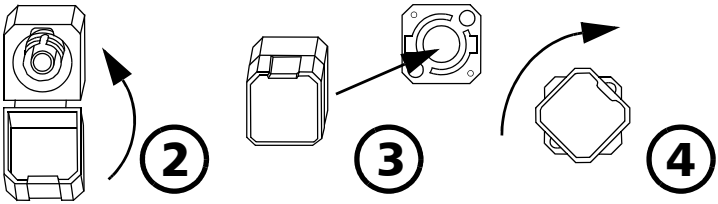

2. Close the dust cap in order to hold the connector adapter more firmly.
3. Insert the connector adapter into the baseplate.
4. While pushing firmly, turn the connector adapter clockwise on the baseplate to lock it in place.

Cleaning and Connecting Optical Fibers



IMPORTANT

To ensure maximum power and to avoid erroneous readings:

- Always clean fiber ends as explained below before inserting them into the port. EXFO is not responsible for damage or errors caused by bad fiber cleaning or handling.
- Ensure that your patchcord has appropriate connectors. Joining mismatched connectors will damage the ferrules.

To connect the fiber-optic cable to the port:

1. Inspect the fiber using a fiber inspection microscope. If the fiber is clean, proceed to connecting it to the port. If the fiber is dirty, clean it as explained below.
2. Clean the fiber ends as follows:
 - 2a. Gently wipe the fiber end with a lint-free swab dipped in isopropyl alcohol.
 - 2b. Use compressed air to dry completely.
 - 2c. Visually inspect the fiber end to ensure its cleanliness.
3. Carefully align the connector and port to prevent the fiber end from touching the outside of the port or rubbing against other surfaces.

If your connector features a key, ensure that it is fully fitted into the port's corresponding notch.

4. Push the connector in so that the fiber-optic cable is firmly in place, thus ensuring adequate contact.

If your connector features a screwsleeve, tighten the connector enough to firmly maintain the fiber in place. Do not overtighten, as this will damage the fiber and the port.

Note: *If your fiber-optic cable is not properly aligned and/or connected, you will notice heavy loss and reflection.*

EXFO uses good quality connectors in compliance with EIA-455-21A standards.

To keep connectors clean and in good condition, EXFO strongly recommends inspecting them with a fiber inspection probe before connecting them. Failure to do so will result in permanent damage to the connectors and degradation in measurements.

Nulling Electrical Offsets

Temperature and humidity variations affect the performance of electronic circuits and optical detectors. Nulling the electrical offsets eliminates these effects. *Your unit has been designed not to require offset nulling under normal operation*, but you should perform it whenever environmental conditions change significantly or when measuring very low power values.



IMPORTANT

If light reaches the detector when nulling offsets, LIGH appears on the display and the nulling is not performed. You will need to press a key to return to the previous display.

Note: *Factory-defined values will be reinstated when you turn the unit off.*

To perform an offset nulling:

Hold down **Threshold/λ** and **Select** a few seconds.

The unit displays **NULL** and vertical bars move at the top of the display, indicating the nulling is in progress.

Note: *Keypad is disabled during the operation.*

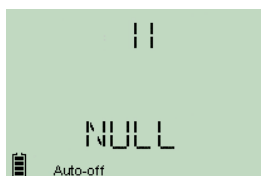

The unit will then return to your previous mode (Pass/Fail or Normal).

4 Configuring Thresholds, Correction Factors, Wavelength List, and Storage Details

Your PPM-350C PON Power Meter has been configured by EXFO with predefined information:

- ▶ Threshold sets that you use in FTTx mode. Up to 10 sets are available.
A threshold set consists of the number of wavelengths (2 or 3) depending on your unit. For each wavelength, you can select the pass, warning and fail criteria.
- ▶ Correction factors for the FTTx mode and OPM mode. These are set to 0 dB since they were properly calibrated at EXFO.
Correction factors are *added* to the measured values. For this reason, once the correction factors are applied, your PON Power Meter may display “HI” or “LO”, indicating the power levels are no longer within the unit’s power limits.
If you need to define correction factors of more than 1 dB or less than -1 dB to compensate for inaccuracies, it may be a good idea to send your PON Power Meter for recalibration (see *Recalibrating the Unit* on page 27). This will ensure the results remain accurate.
- ▶ A wavelength list consisting of 1310 nm, 1490 nm and 1550 nm for OPM operations. This list may contain up to 40 wavelengths (from 1260 nm to 1650 nm)
- ▶ Predefined storage information used in FTTx and OPM operations such as OLT names, ONT names and LOC ID names.

You may customize these parameters using the Handheld Data Transfer (HHDT) software provided on your CD.

The Handheld Data Transfer enables you to create new threshold sets and correction factors, define your list of favorite wavelengths, as well as set storage and job options for better data management, or modify values retrieved from your PON Power Meter. You can configure your PPM-350C with up to 32 OLTs, 255 ONTs, 16 LOCs and 32 JOBs. For more information, refer to the Handheld Data Transfer online help.



IMPORTANT

Thresholds, correction factors, wavelength list, as well as storage and job options will be transferred to your unit. Previous values will be lost.

5 Working in FTTx Mode

You can use this mode during service activation (at ONT) or to troubleshoot passive optical networks (at ONT, drop terminal, fiber distribution hub or CO). You can measure two or three wavelengths simultaneously, depending on the configuration of the unit.

Selecting a Threshold Set

You can select which threshold set will be used to determine the Pass/Warning/Fail status. Your unit contains up to 10 threshold sets, but only one set can be selected at a time.

Depending on the model of the unit, a threshold set comprises two or three wavelengths (1310 and 1490 nm; 1310, 1490, and 1550 nm), each of them having specific threshold values for pass, warning and fail.

Note: *Thresholds are used in Pass/Fail mode only.*

You can view thresholds directly on your unit. To modify threshold values, you must use the Handheld Data Transfer (refer to the Handheld Data Transfer online help).

To select a threshold set:

1. Press **Threshold/λ**. The unit enters the threshold selection mode and displays the current threshold set. If the threshold name has more than 4 characters, it will scroll automatically.
2. Press **Threshold/λ** or **Next** to switch between available threshold sets.

Current threshold set indicators

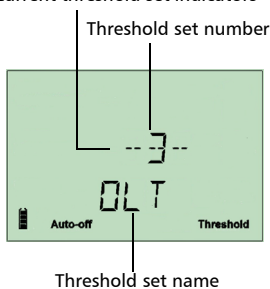

3. If desired, display the Pass/Warning/Fail values of the threshold set as follows:

- 3a. Hold down **Threshold/λ** for a few seconds. The unit displays threshold values of the first wavelength that has not been deactivated.
- 3b. Press **Threshold/λ** or **Next** to switch to the next wavelength.

Signal (wavelength)

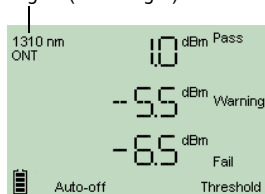

Note: *If a wavelength has been deactivated via the Handheld Data Transfer (refer to the Handheld Data Transfer online help), the unit displays no threshold values.*

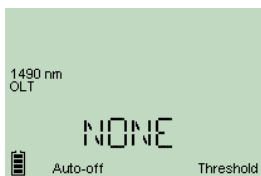

- 3c. Press **Power** to return to threshold selection mode.
4. Press **Select** to make the displayed threshold set the current one. The unit returns to Pass/Fail mode.
 5. Press **Power** to exit without selecting a new threshold set. The unit returns to your previous mode.

Testing in Pass/Fail Mode or in Normal Mode

- Pass/Fail mode: status is indicated directly (screen and LEDs). Status is determined according to the current threshold set (see *Selecting a Threshold Set* on page 14).
- Normal mode: only the power levels are shown and LEDs are off.

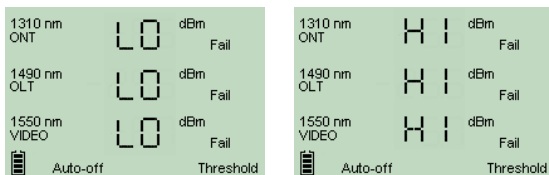
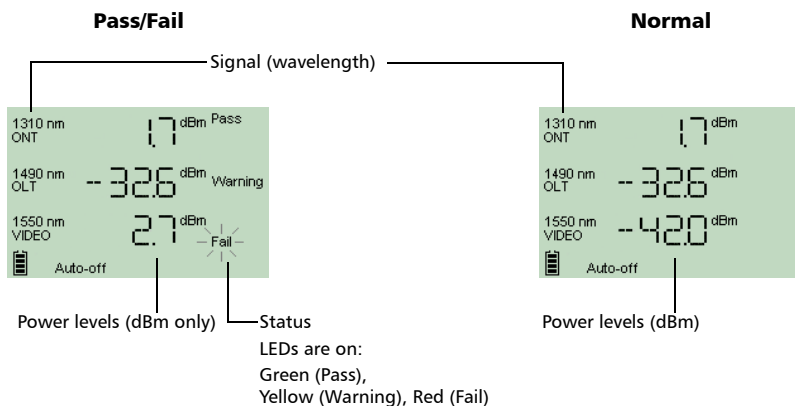

When power is outside unit's power limits
(see *Technical Specifications* on page 39)

Note: If the result is greater than the Pass threshold, the word **Fail** and the LED will flash. If the result is lower than the Fail threshold, the unit will only display **Fail** and the LED will not flash.

At startup, the unit is in the same mode that was used during last test session.

To test in Pass/Fail or Normal mode:

1. Inspect your fibers and clean them properly if needed (see *Cleaning and Connecting Optical Fibers* on page 11 for details).
2. Connect as shown:

Test at the premises

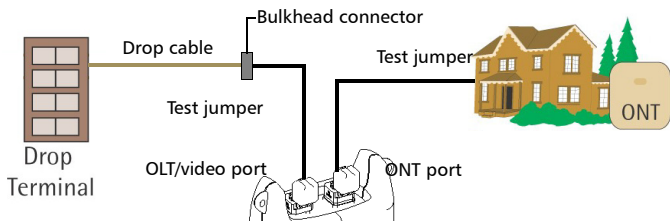

Test at the drop terminal

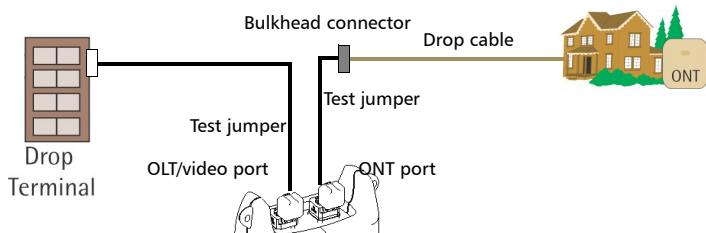

Test at the fiber distribution hub (FDH)

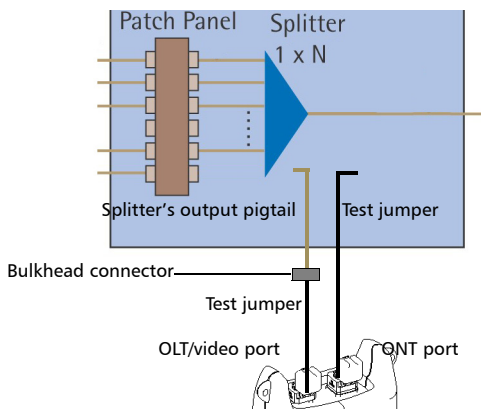

3. Turn unit on.
4. If you want to test in Pass/Fail mode:
 - Ensure that LEDs are on. If not, press **P/F mode**.
 - Ensure that the desired threshold set is selected (see *Selecting a Threshold Set* on page 14).

Results are now available.

6 Working in OPM Mode

Your unit can also be used as a standard optical power meter (in the OPM mode). This is particularly useful if you want to measure networks or devices carrying only one wavelength.

- ▶ You can measure the output power (in dBm) or loss (in dB) using one of the unit's 40 CWDM wavelengths available.

You can select the wavelength that you want to use for your measurements. To customize the list of available wavelengths, you must use HHDT (refer to the online help of the HHDT application for more information).

- ▶ You can set a specific reference value for each wavelength of the list. This reference value will remain in memory until you store a new one for the same wavelength.

When you use reference, your unit displays the loss created by the fiber under test only, since it subtracts a reference value from the measured power.

To perform loss measurements:

1. Clean your fibers properly as explained in *Cleaning and Connecting Optical Fibers* on page 11.
2. Connect the fiber to the OLT/video port.
3. Turn unit on.
4. Select the OPM mode, by pressing and holding down **P/F mode** a few seconds.
5. Select the test wavelength by pressing **Threshold/λ** or **Next** until the desired wavelength is displayed.
6. Press **dBm/dB** to select dB, so that the loss is expressed in dB.
7. Hold down **dBm/dB** for a few seconds to take the reference.

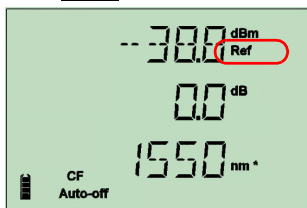

The reference indicator is displayed, showing that the new reference value is now stored in memory.

Loss measurement is displayed just under the reference value.

8. If desired, you can store the loss measurement in your unit (see *Storing Data* on page 19).

7 Managing Test Results

You can save up to 1000 results (FTTx or OPM) in your unit. You can recall this data later according to the storage configuration you have set. It is also possible to delete data directly from your unit.

If you prefer, you can also transfer your data from your unit to a computer using a USB cable.

Storing Data

Using the Handheld Data Transfer (HHDt) application, you can set storage configurations and then upload them to your unit using a USB cable. Refer to the Handheld Data Transfer documentation for more information on uploading configurations.

You can have configurations using the following modes selected by HHDt:

- ▶ OLT and ONT IDs, with different locations.
- ▶ Job, where the OLT and ONT are grouped with different locations.

To store data in OLT mode:

1. Press **Store/Select** to access the data storage menu. The data you have selected is temporarily stored to allow you to enter further information.
2. Press **Next** to access the available OLT values. The OLT name is displayed next to the **Loc.** indicator.
3. Press **Store/Select** to select the OLT and switch to the ONT selection.

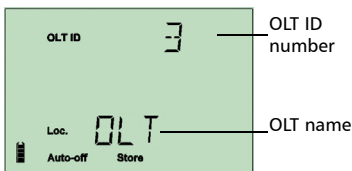

4. Press **Next** to access the available ONT.
5. Press **Store/Select** to select the ONT and switch to the Loc ID selection.
6. Press **Next** to access the available Loc. IDs.
7. Press **Store/Select** to select the location or **Power** to exit the storage mode.



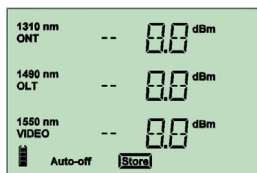

The data is stored. The **Store** indicator is highlighted to show that the operation is complete.

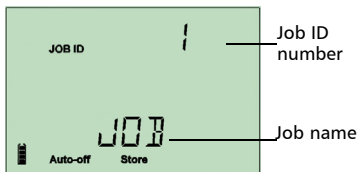

To store data in Job mode:

1. Press **Store/Select** to access the data storage menu. The data you have selected is temporarily stored to allow you to enter further information.
2. Press **Next** to access the available Job ID values.
3. Press **Store/Select** to select the job and access the available Loc. IDs.



4. Press **Store/Select** to select the location or  to exit the storage mode.



The data is stored. The **Store** indicator is highlighted to show that the operation is complete.

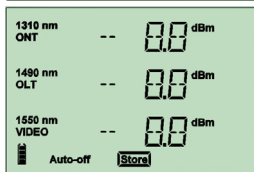

Recalling Data

According to the storage configuration you have set using the Handheld Data Transfer application, you can recall data you have previously stored.

You can recall files according to the following modes, depending on how your unit was set:

- ▶ OLT and ONT IDs, with different locations.
- ▶ Job, where the OLT and ONT are grouped in different locations.

To recall data in OLT mode:

1. Press and hold down **Store/Select** for a few seconds to access the data recall menu.

2. Press **Next** to access the available OLT values. The OLT name is displayed next to the **Loc.** indicator.

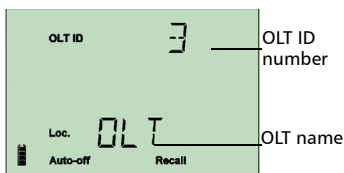

3. Press **Store/Select** to select the OLT and switch to the ONT selection.

4. Press **Next** to access the available ONT.

5. Press **Store/Select** to select the ONT or  to exit the recall mode.

The data is recalled. Press **Next** to go through the data with the same OLT and ONT values.



To recall data in Job mode:

1. Press and hold down **Store/Select** for a few seconds to access the data recall menu.

2. Press **Next** to access the available Job ID values.

3. Press **Store/Select** to select the job or  to exit the recall mode.

The data is recalled. Press **Next** to go through the data with the same Job ID values.



Deleting Data

You can delete unwanted data directly from the unit when viewing your stored data.

To delete data:

1. Press and hold down **Store/Select** for a few seconds to access the data recall menu.
2. Select the data you want to delete.
3. Press and hold down **Store/Select** for a few seconds once again.
4. The del CONF (delete confirm) message appears.
5. Press **Store/Select** to confirm your choice, or  to cancel.



Transferring Data to a Computer

Using an appropriate USB cable and the Handheld Data Transfer software, you can transfer saved data from your unit to a computer. This way, you can free memory space, perform better analyses on your data and create reports.

To transfer data to a computer:

1. Using a USB cable, connect your unit to an available USB port of the computer.
2. Turn on both the computer and your handheld unit. Connect your unit to a power outlet to ensure that your unit will remain on during the transfer.
3. On the computer, start the Handheld Data Transfer application and start the operation.

The unit displays “REM” and temporarily deactivates the keyboard and auto-off.

Note: For details about setting up the software and transferring data, refer to the Handheld Data Transfer online help.



IMPORTANT

Transferred data is not automatically deleted from your unit.

8 Identifying Fiber Faults Visually

Note: This feature is available only if your unit is equipped with a VFL port.

The visual fault locator (VFL) helps you identify bends, faulty connectors, splices and other causes of signal loss.

From its dedicated port, the VFL emits a red signal which becomes visible at the location of a fault on the fiber. This signal can be continuous (the default) or blinking (1 Hz).



WARNING

When the VFL is active, the VFL port emits visible laser radiation. Avoid exposure and do not stare directly into the beam. Ensure that any unused port is properly protected with a cap.

When the VFL is on, the rightmost status LED will also be on.

To activate the VFL and inspect a fiber:

1. Connect the fiber under test to the VFL port (see *Cleaning and Connecting Optical Fibers* on page 11).
2. Press and hold down **Next** for a few seconds to switch between **ON CW** (continuous signal) and **ON 1HZ** (blinking signal).
3. Without looking directly into the beam, examine the fiber. If light is coming out of the rubber jacket or on the side of the ferrule, the fiber is defective.
4. Deactivate the VFL by pressing and holding down **Next** for a few seconds to switch between the signals (**ON CW** and **ON 1HZ**), until you reach **OFF**.

9 Maintenance

To help ensure long, trouble-free operation:

- Always inspect fiber-optic connectors before using them and clean them if necessary.
- Keep the unit free of dust.
- Clean the unit casing and front panel with a cloth slightly dampened with water.
- Store unit at room temperature in a clean and dry area. Keep the unit out of direct sunlight.
- Avoid high humidity or significant temperature fluctuations.
- Avoid unnecessary shocks and vibrations.
- If any liquids are spilled on or into the unit, turn off the power immediately, disconnect from any external power source, remove the batteries and let the unit dry completely.



WARNING

The use of controls, adjustments and procedures other than those specified herein may result in exposure to hazardous situations or impair the protection provided by this unit.

Cleaning EUI Connectors

Regular cleaning of EUI connectors will help maintain optimum performance. There is no need to disassemble the unit.



IMPORTANT

If any damage occurs to internal connectors, the module casing will have to be opened and a new calibration will be required.

To clean EUI connectors:

1. Remove the EUI from the instrument to expose the connector baseplate and ferrule.

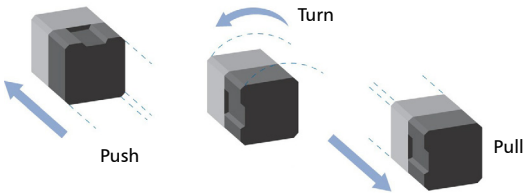

2. Moisten a 2.5 mm cleaning tip with *one drop* of isopropyl alcohol (alcohol may leave traces if used abundantly).
3. Slowly insert the cleaning tip into the EUI adapter until it comes out on the other side (a slow clockwise rotating movement may help).

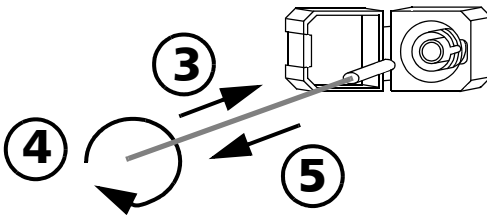

4. Gently turn the cleaning tip one full turn, then continue to turn as you withdraw it.

5. Repeat steps 3 to 4 with a dry cleaning tip.

Note: *Make sure you don't touch the soft end of the cleaning tip.*

6. Clean the ferrule in the connector port as follows:

- 6a. Deposit *one drop* of isopropyl alcohol on a lint-free wiping cloth.



IMPORTANT

Since isopropyl alcohol is not absolutely pure, it may leave residues if used abundantly or left to evaporate (about 10 seconds).

Avoid contact between the tip of the bottle and the wiping cloth, dry the surface quickly, and use a bottle that distributes only a drop of alcohol at a time.

- 6b. Gently wipe the connector and ferrule.
 - 6c. With a dry lint-free wiping cloth, gently wipe the same surfaces to ensure that the connector and ferrule are perfectly dry.
 - 6d. Verify connector surface with a portable fiber-optic microscope (for example, EXFO's FOMS) or fiber inspection probe (for example, EXFO's FIP).



WARNING

Verifying the surface of the connector **WHILE THE UNIT IS ACTIVE** **WILL** result in permanent eye damage.

7. Put the EUI back onto the instrument (push and turn clockwise).
8. Throw out cleaning tips and wiping cloths after one use.

Replacing Disposable Alkaline Batteries

Your unit requires three AA alkaline batteries.

Note: *The provided AC adapter is not a charger.*

To replace disposable alkaline batteries:

1. Turn off the unit (if the AC adapter is plugged in, you may replace batteries while unit is on).
2. Open the battery compartment door located at the back of the unit.
3. Replace batteries, respecting the polarity as shown.
4. Close the battery compartment door.

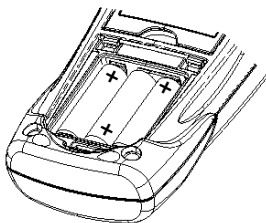

WARNING

Do not throw batteries into fire or water and do not short-circuit the batteries' electrical contacts.



WARNING

Using the wrong type of battery can lead to product damage, overheating, or even explosion.



CAUTION

EXFO guarantees the specifications and viability of the products **ONLY** if they are used with chargers provided by EXFO.

Recalibrating the Unit

Manufacturing and service center calibrations are based on the ISO/IEC 17025 Standard, which states that calibration documents must not contain a recommended calibration interval, unless this has been previously agreed upon with the customer.

Validity of specifications depends on operating conditions. For example, the calibration validity period can be longer or shorter depending on the intensity of use, environmental conditions and unit maintenance. You should determine the adequate calibration interval for your unit according to your accuracy requirements.

Under normal use, EXFO recommends calibrating your unit every three years.

Note: *The FlexCare warranty program includes Calibration/Verification packages (see Service and Repairs on page 37).*

To view the last calibration date:

1. Press and hold down **Threshold/ λ** and press **Power** at the same time. The unit displays the main embedded software version.
2. Press **Next** to display the calibration date of the unit.
3. Press **Power** to return to your previous mode.

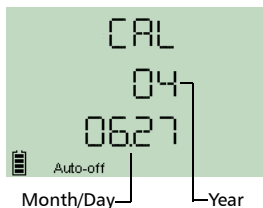

Verifying the Integrity of User Information in Memory

You can verify the integrity of the memory to ensure that your unit will function normally for threshold sets, correction factors, wavelength lists and storage information.

If a problem is detected, error code 9, 10, or 12 will be displayed. If you turn the unit off without correcting the problem, the error code will be displayed once the unit is turned on again. For more information, see *Error Codes and Descriptions* on page 31.

To verify memory integrity:

Hold down **P/F mode** and **Threshold/ λ** a few seconds. The unit displays **CHKS** and vertical bars move at the top of the display, indicating the verification is in progress.

Note: *Keypad is disabled during this operation.*



The unit will then return to your previous mode.



Verifying the LEDs and LCD

You can verify that the LEDs function normally and that the screen can display all the elements properly. The unit must be in Pass/Fail or Normal mode to perform the verification.

To verify the LEDs and LCD:

1. Hold down  and  a few seconds. The unit displays **TEST** and vertical bars move at the top of the display, indicating the verification is in progress.

The three LEDs will light up briefly in the following order: green, yellow, red. Once LEDs are turned off, all the screen segments will be displayed at the same time, allowing you to verify them.



Note: Keypad is disabled during the operation.

2. Press any key to return to your previous mode.

Recycling and Disposal (Applies to European Union Only)

For complete recycling/disposal information as per European Directive WEEE 2002/96/EC, visit the EXFO Web site at www.exfo.com/recycle.

10 Troubleshooting

Solving Common Problems

Problem	Possible Cause	Solution
<p>One of the LEDs remains off. OR One of the LEDs remains green or red even if the status is Warning.</p>	<p>LED is burnt. Verify LEDs (see <i>Verifying the LEDs and LCD</i> on page 29).</p>	<p>Contact EXFO.</p>
<p>Pressing the P/F mode button does not activate Pass/Fail mode.</p>	<ul style="list-style-type: none"> ➤ Unit is currently nulling offsets, verifying thresholds or verifying LEDs and LCD. ➤ The current threshold set contains an unusable (corrupted) value. ➤ No threshold sets have been defined. 	<ul style="list-style-type: none"> ➤ Let the unit complete the operation. If the unit was verifying LEDs and LCD, press any key to return to your previous mode (Pass/Fail or Normal). ➤ See <i>Error Codes and Descriptions</i> on page 31. ➤ See <i>Error Codes and Descriptions</i> on page 31.

Problem	Possible Cause	Solution
The threshold set name is not displayed correctly.	Name contains characters that your unit cannot display. Unsupported characters are replaced with dashes, spaces or "+".	Rename the threshold set using only supported characters: <ul style="list-style-type: none"> ➤ 0 through 9 ➤ A through Z (both lowercase and uppercase) ➤ - (dash) + / . < = > ? [\] _ (underscore) and space For more information on renaming threshold sets, see <i>Configuring Thresholds, Correction Factors, Wavelength List, and Storage Details</i> on page 13.
In Pass/Fail mode, impossible to see all wavelengths and some of the LEDs are off.	At least one signal is deactivated (see <i>Selecting a Threshold Set</i> on page 14).	Reactivate the signal (see <i>Configuring Thresholds, Correction Factors, Wavelength List, and Storage Details</i> on page 13).

Error Codes and Descriptions

- ER: error code displayed until you press a key.
- WR: warning code displayed for 3 seconds, then unit returns to normal.

Error Code	Description	Solution
EMPT	Storage memory is empty, there is nothing to recall.	Store at least one measurement before going in recall mode.
FULL	Storage memory is full.	Free some storage space by deleting measurements.
LIGH	Light detected while nulling offsets. Nulling is not performed.	Correctly place protective cap on ports, then retry. If the problem persists, contact EXFO.
ER 9	Configuration for storage information is not usable (corruption problem).	Download new storage information (see <i>Configuring Thresholds, Correction Factors, Wavelength List, and Storage Details</i> on page 13).

Error Code	Description	Solution
ER 10	Configuration for wavelength list and correction factors is not usable (corruption problem).	Download new wavelength list and correction factors (see <i>Configuring Thresholds, Correction Factors, Wavelength List, and Storage Details</i> on page 13).
ER 12/16	<p>Threshold values are not usable (corruption problem).</p> <p>Would occur:</p> <ul style="list-style-type: none"> ▶ during unit initialization ▶ after threshold verification (see <i>Verifying the Integrity of User Information in Memory</i> on page 28) ▶ after threshold set selection 	Download new threshold sets to your unit. For more information, see <i>Configuring Thresholds, Correction Factors, Wavelength List, and Storage Details</i> on page 13.
ER 13	EEPROM corrupted (would occur during unit initialization).	Unit must be recalibrated. Contact EXFO.
ER 17	<p>No signal is activated for the selected threshold.</p> <p>The error is displayed again if you try to activate the threshold. You must enter the threshold selection mode to select another threshold.</p> <p>This error can be displayed at startup if no threshold signal is selected when shutting down the unit.</p> <p>The threshold signal activation is done through the threshold download application.</p>	Enter the threshold selection mode Activate another threshold.
WR 23	No threshold sets have been defined. Pass/Fail mode cannot be activated.	Download new threshold sets to your unit. For more information, see <i>Configuring Thresholds, Correction Factors, Wavelength List, and Storage Details</i> on page 13.
WR 24	Date and time of the real-time clock are not valid.	<p>Use HHDT to transfer date and time of the real-time clock by configuring the PPM-350C.</p> <p>If the problem persists, you may have to change the real-time clock battery. Contact EXFO for details.</p>

Contacting the Technical Support Group

To obtain after-sales service or technical support for this product, contact EXFO at one of the following numbers. The Technical Support Group is available to take your calls from Monday to Friday, 8:00 a.m. to 7:00 p.m. (Eastern Time in North America).

For detailed information about technical support, visit the EXFO Web site at www.exfo.com.

Technical Support Group



400 Godin Avenue
Quebec (Quebec) G1M 2K2
CANADA

1 866 683-0155 (USA and Canada)
Tel.: 1 418 683-5498
Fax: 1 418 683-9224
support@exfo.com

To accelerate the process, please have information such as the name and the serial number (see the product identification label), as well as a description of your problem, close at hand.

You may also be requested to provide the embedded software's version numbers.

To display the embedded software version:

1. Hold down  and press  at the same time. The unit displays the main software version.
2. Press  to return to your previous mode.



Transportation

Maintain a temperature range within specifications when transporting the unit. Transportation damage can occur from improper handling. The following steps are recommended to minimize the possibility of damage:

- Pack the unit in its original packing material when shipping.
- Avoid high humidity or large temperature fluctuations.
- Keep the unit out of direct sunlight.
- Avoid unnecessary shocks and vibrations.

11 Warranty

General Information

EXFO Inc. (EXFO) warrants this equipment against defects in material and workmanship for a period of three years from the date of original shipment. EXFO also warrants that this equipment will meet applicable specifications under normal use.

During the warranty period, EXFO will, at its discretion, repair, replace, or issue credit for any defective product should the equipment need to be repaired. If the equipment is sent back for verification of calibration during the warranty period and found to meet all published specifications, EXFO will charge standard calibration fees.



IMPORTANT

The warranty can become null and void if:

- unit has been tampered with, repaired, or worked upon by unauthorized individuals or non-EXFO personnel.
- warranty sticker has been removed.
- case screws, other than those specified in this guide, have been removed.
- case has been opened, other than as explained in this guide.
- unit serial number has been altered, erased, or removed.
- unit has been misused, neglected, or damaged by accident.

THIS WARRANTY IS IN LIEU OF ALL OTHER WARRANTIES EXPRESSED, IMPLIED, OR STATUTORY, INCLUDING, BUT NOT LIMITED TO, THE IMPLIED WARRANTIES OF MERCHANTABILITY AND FITNESS FOR A PARTICULAR PURPOSE. IN NO EVENT SHALL EXFO BE LIABLE FOR SPECIAL, INCIDENTAL, OR CONSEQUENTIAL DAMAGES.

Liability

EXFO shall not be liable for damages resulting from the use of the product, nor shall be responsible for any failure in the performance of other items to which the product is connected or the operation of any system of which the product may be a part.

EXFO shall not be liable for damages resulting from improper usage or unauthorized modification of the product, its accompanying accessories and software.

Exclusions

EXFO reserves the right to make changes in the design or construction of any of its products at any time without incurring obligation to make any changes whatsoever on units purchased. Accessories, including but not limited to fuses, pilot lamps, batteries and universal interfaces (EUI) used with EXFO products are not covered by this warranty.

This warranty excludes failure resulting from: improper use or installation, normal wear and tear, accident, abuse, neglect, fire, water, lightning or other acts of nature, causes external to the product or other factors beyond the control of EXFO.



IMPORTANT

EXFO will charge a fee for replacing optical connectors that were damaged due to misuse or bad cleaning.

Certification

EXFO certifies that this equipment met its published specifications at the time of shipment from the factory.

Service and Repairs

EXFO commits to providing product service and repair for five years following the date of purchase.

To send any equipment for service or repair:

1. Call one of EXFO's authorized service centers (see *EXFO Service Centers Worldwide* on page 38). Support personnel will determine if the equipment requires service, repair, or calibration.
2. If equipment must be returned to EXFO or an authorized service center, support personnel will issue a Return Merchandise Authorization (RMA) number and provide an address for return.
3. If possible, back up your data before sending the unit for repair.
4. Pack the equipment in its original shipping material. Be sure to include a statement or report fully detailing the defect and the conditions under which it was observed.
5. Return the equipment, prepaid, to the address given to you by support personnel. Be sure to write the RMA number on the shipping slip. *EXFO will refuse and return any package that does not bear an RMA number.*

Note: *A test setup fee will apply to any returned unit that, after test, is found to meet the applicable specifications.*

After repair, the equipment will be returned with a repair report. If the equipment is not under warranty, you will be invoiced for the cost appearing on this report. EXFO will pay return-to-customer shipping costs for equipment under warranty. Shipping insurance is at your expense.

Routine recalibration is not included in any of the warranty plans. Since calibrations/verifications are not covered by the basic or extended warranties, you may elect to purchase FlexCare Calibration/Verification Packages for a definite period of time. Contact an authorized service center (see *EXFO Service Centers Worldwide* on page 38).

EXFO Service Centers Worldwide

If your product requires servicing, contact your nearest authorized service center.

EXFO Headquarters Service Center

400 Godin Avenue
Vanier (Quebec) G1M 2K2
CANADA

1 866 683-0155 (USA and Canada)
Tel.: 1 418 683-5498
Fax: 1 418 683-9224
support@exfo.com

EXFO Europe Service Center

Omega Enterprise Park, Electron Way
Chandlers Ford, Hampshire S053 4SE
ENGLAND

Tel.: +44 2380 246810
Fax: +44 2380 246801
support.europe@exfo.com

EXFO Telecom Equipment (Shenzhen) Ltd.

3rd Floor, Building 10,
Yu Sheng Industrial Park (Gu Shu Crossing),
No. 467,
National Highway 107,
Xixiang, Bao An District,
Shenzhen, China, 518126

Tel: +86 (755) 2955 3100
Fax: +86 (755) 2955 3101
support.asia@exfo.com

A Technical Specifications



IMPORTANT

The following technical specifications can change without notice. The information presented in this section is provided as a reference only. To obtain this product's most recent technical specifications, visit the EXFO Web site at www.exfo.com.

Specifications ^a

	PPM-352C	PPM-353C
Power measurement range—pass zone for continuous data stream (dBm)		
1310 nm	8 to -40	8 to -40
1490 nm	12 to -40	12 to -40
1550 nm	25 to -40	N/A
Burst measurement capability	CO to ONT	CO to ONT
Burst measurement range ^b (dBm)		
1310 nm	8 to -30	8 to -30
ORL ^a (dB)		
1550 nm	55	55
Pass-through insertion loss ^b (dB)	1.5	1.5
Spectral passband (nm)		
1310 nm	1260 to 1360	1260 to 1360
1490 nm	1480 to 1500	1480 to 1500
1550 nm	1539 to 1565	1539 to 1565
Power uncertainty ^{b, c, d} (dB)	0.5	0.5
Calibrated wavelengths (nm)	1310/1490/1550	1310/1490
Threshold sets	10 configurable threshold sets with threshold naming	10 configurable threshold sets with threshold naming

GENERAL SPECIFICATIONS

Size (H x W x D)	195 mm x 100 mm x 57 mm (7 ¹¹ / ₁₆ in x 4 in x 2 ¹ / ₄ in)
Weight ^f	0.4 kg (0.9 lb)
Temperature	
Operating	-10 °C to 50 °C (14 °F to 122 °F)
Storage ^f	-40 °C to 70 °C (-40 °F to 158 °F)
Relative humidity	0 % to 95 % non-condensing
Autonomy ^b (hours)	
FTTx mode (burst)	35
OPM mode (CW)	80
Number of ports	2
Warranty and recommended calibration interval (years) ^g	3

Notes

- a. At room temperature.
- b. Typical.
- c. Around -7 dBm, CW.
- d. At calibrated wavelengths.
- e. For APC connectors.
- f. Without batteries.
- g. Excluding connector wear.

NOTICE

通告

CHINESE REGULATION ON RESTRICTION OF HAZARDOUS SUBSTANCES 中国关于有害物质限制的规定

NAMES AND CONTENTS OF THE TOXIC OR HAZARDOUS SUBSTANCES OR ELEMENTS
CONTAINED IN THIS EXFO PRODUCT

包含在本 EXFO 产品中的有毒有害物质或元素的名称和含量



O	Indicates that this toxic or hazardous substance contained in all of the homogeneous materials for this part is below the limit requirement in SJ/T11363-2006 表示该有毒有害物质在该部件所有均质材料中的含量均在 SJ/T11363-2006 标准规定的限量要求以下。
X	Indicates that this toxic or hazardous substance contained in at least one of the homogeneous materials used for this part is above the limit requirement in SJ/T11363-2006 表示该有毒有害物质至少在该部件的某一均质材料中的含量超出 SJ/T11363-2006 标准规定的限量要求。

Part Name 部件名称	Toxic or hazardous Substances and Elements 有毒有害物质和元素					
	Lead 铅 (Pb)	Mercury 汞 (Hg)	Cadmium 镉 (Cd)	Hexavalent Chromium 六价铬 (Cr VI)	Polybrominated biphenyls 多溴联苯 (PBB)	Polybrominated diphenyl ethers 多溴二苯醚 (PBDE)
Enclosure 外壳	O	O	O	O	O	O
Electronic and electrical sub-assembly 电子和电子组件	X	O	X	O	X	X
Optical sub-assembly ^a 光学组件 ^a	X	O	O	O	O	O
Mechanical sub-assembly ^a 机械组件 ^a	O	O	O	O	O	O

a. If applicable.
如果适用。

MARKING REQUIREMENTS

标注要求

Product 产品	Environmental protection use period (years) 环境保护使用期限 (年)	Logo 标志
This Exfo product 本 EXFO 产品	10	
Battery ^a 电池 ^a	5	

a. If applicable.
如果适用。

P/N: 1063122

www.EXFO.com · info@exfo.com

CORPORATE HEADQUARTERS	400 Godin Avenue	Quebec (Quebec) G1M 2K2 CANADA Tel.: 1 418 683-0211 · Fax: 1 418 683-2170
EXFO AMERICA	3400 Waterview Parkway Suite 100	Richardson, TX 75080 USA Tel.: 1 972-761-927 · Fax: 1 972-761-9067
EXFO EUROPE	Omega Enterprise Park, Electron Way	Chandlers Ford, Hampshire S053 4SE ENGLAND Tel.: +44 2380 246810 · Fax: +44 2380 246801
EXFO ASIA-PACIFIC	100 Beach Road, #22-01/03 Shaw Tower	SINGAPORE 189702 Tel.: +65 6333 8241 · Fax: +65 6333 8242
EXFO CHINA	Beijing Global Trade Center, Tower C, Room 1207, 36 North Third Ring Road East, Dongcheng District	Beijing 100013 P. R. CHINA Tel.: +86 (10) 5825 7755 Fax: +86 (10) 5825 7722
EXFO SERVICE ASSURANCE	270 Billerica Road	Chelmsford MA, 01824 USA Tel.: 1 978 367-5600 · Fax: 1 978 367-5700
EXFO NETHAWK	Elektroniikkatie 2	FI-90590 Oulu, FINLAND Tel.: +358 (0) 403 010 300 Fax: +358 (0) 8 564 5203
TOLL-FREE	(USA and Canada)	1 800 663-3936

© 2012 EXFO Inc. All rights reserved.
Printed in Canada (2012-06)



EXFO
EXPERTISE REACHING OUT