

Connector Inspection Guide



Connector Inspection Guide

CONNECTOR INSPECTION AND MAINTENANCE

One of the first tasks to perform when designing fiber-optic networks is to evaluate the acceptable budget loss in order to create a product that will meet application requirements. To adequately characterize the budget loss, the following key parameters are generally considered:

- › Transmitter: launch power, temperature and aging
- › Fiber connections: connectors and splices
- › Cable: fiber loss and temperature effects
- › Receiver: detector sensitivity
- › Others: safety margin and repairs

When one of the above-listed variables fails to meet specifications, the performance of the network can be greatly affected or worse, the degradation can lead to network failure. Unfortunately, not all the variables can be controlled with ease during the deployment of the network or the maintenance stage; however, there is one component—the connector—that is too often overlooked, sometimes overused (test jumpers) but that can be controlled using the proper procedure.

The Inspection Phase

Connectors are key components that interconnect the entire network elements, which is why maintaining them in good condition is essential to ensure that all the equipment operates to their maximum performance—to avoid catastrophic network failure. Since connectors are susceptible to damage that is not immediately obvious to the naked eye—the inspection phase is vital.

COMPONENTS

When proceeding with the inspection of connectors, there are two main components to inspect: the connector itself and the ferrule.

The Connector

One of the advantages with connectors is that when connector failure occurs, it can be rapidly dealt with since its main cause is often traced to the endface (also called the "ferrule") or the mechanical section of the connector. Connector failure is most frequently the result of a dirty or damaged endface. Figure 1 illustrates the parts of a SC-type fiber-optic connector.

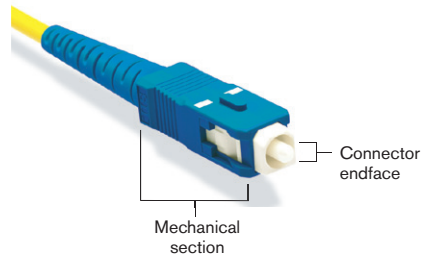

Figure 1. Fiber-optic connector: SC type

Connector Inspection Guide

The Ferrule

In the connector, the ferrule holds the fiber and provides the alignment positioning. The ferrule is the part of the connector that connects the cable either to another cable, a transmitter or a receiver. Made of either glass, plastic, metal or ceramic, the ferrule is composed of three principal zones (see Figure 2a): (1) Zone A, which is defined as the core of the fiber where the light travels; (2) Zone B, called the “cladding”, is the outer optical material surrounding the core that reflects the light into the core and (3) the buffer coating protects the fiber from damage and moisture as it surrounds the cladding and is normally made of plastic.

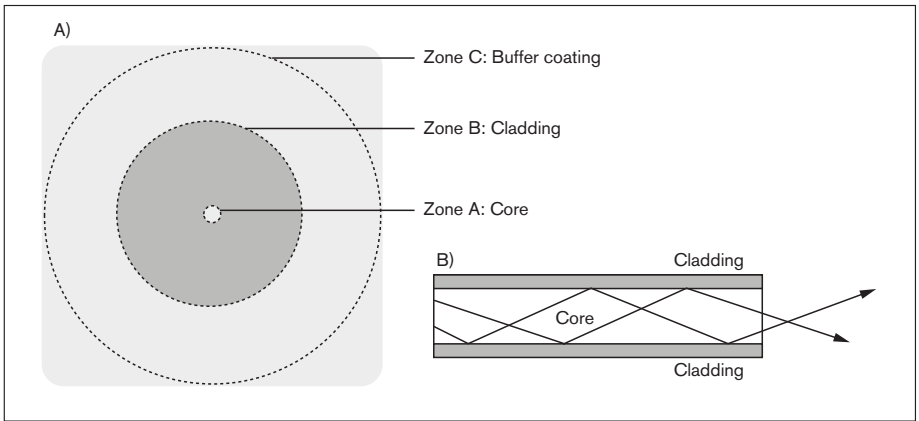

Figure 2. A) Zones defining the ferrule
B) How light is guided through an optical multimode fiber

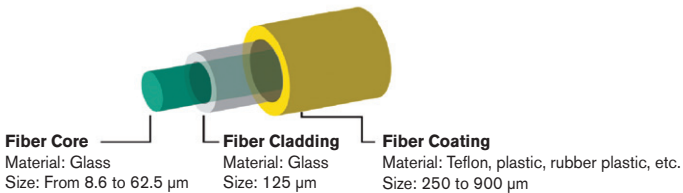

Figure 3. Layered view of a singlemode fiber

Connector Inspection Guide

INSPECTING CONNECTORS

Since the core and cladding are the two main sections of the ferrule, it is critical that they be maintained in good condition to minimize the loss that occurs when two ferrules are mated together. In order to properly carry out connector maintenance, the connector endface must first be visually inspected. As shown in Table 1, the core diameter of a singlemode fiber is less than 10 microns, which means that without the proper inspection tool, it is impossible to tell if the ferrule is clean, making it essential to have the right tools.

Fiber Type	Core Diameter (µm/inches)	Cladding Diameter (µm/inches)
Singlemode	9/0.000000394	125/0.000354
Multimode	50/0.001969 or 62.5/0.002461	125/0.000354

Table 1. Singlemode and multimode core and cladding diameters

Inspection Tool	Main Characteristics
Video fiber inspection probes	<ul style="list-style-type: none"> › Image display on an external video screen, PC or a test instrument (see Figure 3) › Eye protection from direct contact with a live signal › Image-capture capability for report documentation › Ease of use in crowded patch panels › Ideal to inspect patchcord, patch panel, multifiber connector (e.g., MTP) › Different degrees of magnification available (100x/200x/400x) › Adapter tips for all connector types available
Optical microscope	<ul style="list-style-type: none"> › Laser safety filter* to protect eyes from direct contact with a live fiber › Two different types of microscopes needed—depending on the types of connector to inspect—one to inspect patchcords and a different one to inspect connectors in bulkhead-patch panels

* It is highly recommended to never use a direct magnifying device (optical microscope) to inspect live fiber.

Table 2. Inspection tools

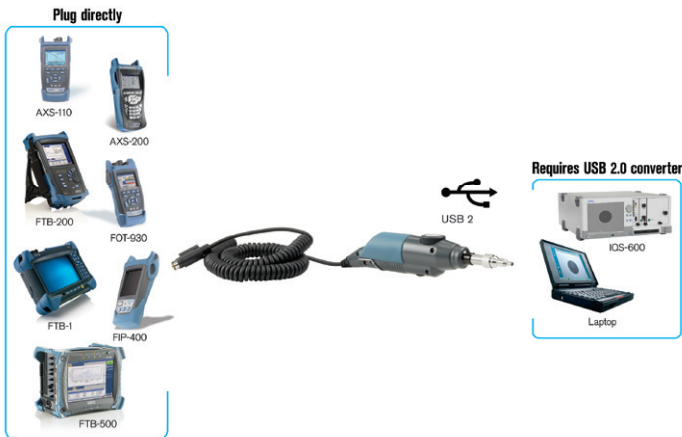

Figure 4. Video inspection probe

Connector Inspection Guide

INSPECTING FERRULES

When inspecting a connector ferrule, two types of problems can be encountered: a damaged endface or a dirty endface.

Damaged Endfaces

Physical damage to the connector endface are, in general, permanent and will, in most cases, require a connector replacement—unless the damage is not detrimental to the endface. In order to determine whether the damage is detrimental or not, a good rule of thumb is to discard or replace any connector that has scratches near or across the fiber core (see Figure 5a), since these scratches can generate high loss and affect the connector performance. For physical damage, including chipped cladding (see Figure 5b), worn connectors and/or excessive epoxy residue on the cladding, the connector must be replaced.

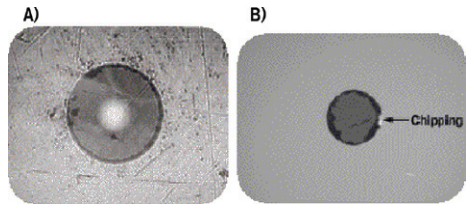

Figure 5. A) Scratch in the core region
B) Chipping on the cladding

Dirty Endfaces

In an ideal world, free of contaminants, connector endfaces would always be clean and would not require in-depth maintenance; however, this is not the present reality, and many fiber-optic connector contaminants exist. For example, a 1 μm dust particle on a singlemode core can block up to 1 % (0.05 dB loss) of the light—imagine what a 9 μm dust particle can do. Another important reason for keeping endfaces free of contaminants is the effect of high-power components on the connector endface. Some of today's telecommunication components can produce signals with a power level up to +30 dBm (1 W), which can have catastrophic results when used with a dirty or damaged connector endface (e.g., fiber fuse).

Dust, isopropyl alcohol, oil from hands, mineral oils, index matching gel, epoxy resin, oil-based black ink and gypsum are among the contaminants that can affect a connector endface. Some of these contaminants are single soil or they may come in complex soil combinations. Note that each contaminant appears differently, but regardless of its appearance, the most critical areas to inspect are the core and cladding regions—as contamination in these regions can greatly affect the quality of the signal. Figure 7 illustrates the endface of different connectors that has been inspected with a video inspection probe.

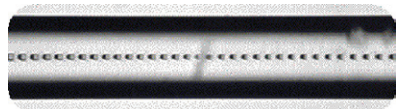

Figure 6. Effect of a fiber fuse on a fiber core

Connector Inspection Guide

Good practice for avoiding connector endface damage or contamination is to always keep a protective cap on the unused connector—thereby stressing the importance of storing unused protective caps in a sealed container to prevent contamination. When inserting the protective cap on a ferrule, do not insert it all the way since small dirt particles can accumulate at the bottom of the cap and if the bottom of a contaminated cap comes into contact with the connector endface, it can contaminate the connector endface. Note that outgassing from the manufacturing process of the dust cap can leave a residue of the mold release agent or materials in the cap. Therefore, the presence of a dust cap does not guarantee cleanliness; it is a protective device to prevent damage. Another interesting fact about test jumper and connectors, which you take right out of the sealed bag from the supplier, is that they are not always clean before sealing of the bag and therefore will be dirty. Fortunately, using the proper cleaning tools and cleaning procedures can effectively clean a soiled connector.

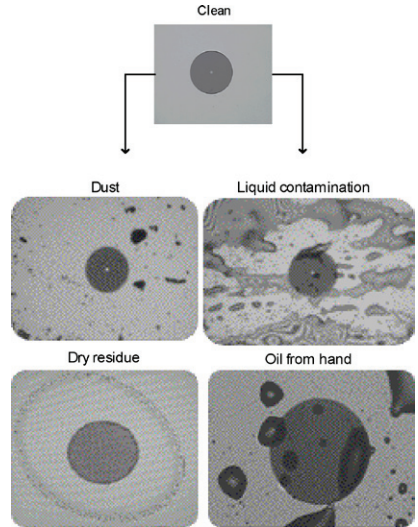

Figure 7. Clean connector endface vs. endfaces contaminated with different materials

The Cleaning Phase

A reliable network begins with connector care and cleaning. Through the years, many devices and procedures have been used. In the past, the way a connector was cleaned did not affect performance, but nowadays with fiber-optic network demands increasing to meet consumer expectations of services, the way the connector is cleaned is vital. Therefore, before connecting a connector, it is essential to make sure that it is clean and exempt of defects. To ensure connector cleanliness, the connector must first be inspected with either a fiber-optic microscope or a video inspection probe and cleaned if necessary.

Note: Always inspect a connector before cleaning—inspection may reveal that the connector does not need to be cleaned.

There exist various approaches for cleaning connectors, but for the purpose of this document, the three cleaning procedures that are the most commonly used in the industry will be discussed: dry cleaning, wet cleaning and hybrid/combination cleaning.

Advantages	Disadvantages
<ul style="list-style-type: none">› Convenience of readily available tools› Fast and easy	<ul style="list-style-type: none">› Can possibly create electrostatic charges› Not effective in removing all contaminant types› Possible cost consideration

Table 3. Advantages and disadvantages of using the dry cleaning method

Connector Inspection Guide

There are different types of dry cleaning tools on the market that are made of various materials and that come in a variety of shapes, depending on the type of connector to clean. Table 4 below lists the most popular and affordable tools used in the dry cleaning method:







Dry Cleaning	Application	Image
Lint-free swabs	Bulkhead, receptacles and patchcord endfaces	
Lint-free wipes	Pigtails and patchcord endfaces	
Compressed gas dusters	Pigtails and patchcord endfaces	
Specialized lint-free wipes	Pigtails and patchcord endfaces	
Cartridge (ReelCleaner/CLETOP)	Pigtails and patchcord endfaces	
Specialized cleaner	Bulkhead, receptacles and patchcord endfaces	

Table 4. Dry cleaning tools

THE WET CLEANING METHOD

One of the main active elements of the wet cleaning method is the solvent used and selecting the right one, along with an effective and reliable drying is essential for effective wet cleaning. The main purpose of using the wet cleaning method is to raise dust and contaminants from the connector's endface, which avoids scratching the connector. The most widely-known solvent in the industry is the 99.9 % isopropyl alcohol (IPA), which is effective for removing a large majority of the contaminants; yet some of them—such as matching gel and most lubricants—are quite resistant and can leave soil residue.

Advantages	Disadvantages
<ul style="list-style-type: none"> › Can dissolve complex soils and contaminants › Eliminates the accumulation of electrostatic charge on the ferrule 	<ul style="list-style-type: none"> › Can leave residue on the ferrule when too much solvent is used and not properly dried › Solvent choice can be confusing with issues of performance and EH&S

Table 5. Advantages and disadvantages of using the wet cleaning method

Connector Inspection Guide

Table 6 below shows the various tools available for the wet cleaning method:



Wet Cleaning	Application	Image
Pen style container	Connector endface cleaning	
Pre-saturated wipes IPA wipers	Connector endface cleaning	
Precision solvents	Connector endface cleaning in combination with an integrated drying procedure	

Table 6: Wet cleaning tools

THE HYBRID CLEANING METHOD

Hybrid cleaning (also called "combination cleaning") is a mix of wet and dry cleaning methods. The first step in hybrid cleaning is to clean the connector endface by using a solvent and then to dry any remaining residue with either a wipe or a swab, depending on the type of connector being cleaned.

Advantages	Disadvantages
<ul style="list-style-type: none"> › Cleans all soil types › Reduces potential of static field soil accumulation › Automatically dries moisture and solvent used in the cleaning process › Captures soil in wiping material as an integrated aspect of cleaning procedure › Not expensive 	<ul style="list-style-type: none"> › Requires multiple products and re-writing of existing procedures

Table 7: Advantages and disadvantages of using the hybrid cleaning method

Cleaning the connector endface using the hybrid technique:

1. Pull a wipe from the specialized wipe container (SWC).
2. Spray a small amount of specialized solvent on the wipe.
3. Place the endface in the wet portion of the wipe. For a standard polished endface (UPC), hold the endface at 90° perpendicular to the SWC platen. Tilt the container or endface to find the angle on the angled polish connector (APC).
4. In a smooth linear motion, trace the endface lightly over the platen from the wet section to the dry area without picking up the connector. Do not press too hard and do not perform the cleaning procedure over the same area. It is recommended to repeat this step three times.
5. Using a video inspection probe or other inspection device, inspect the connector endface to make sure there is no solvent residue or remaining contamination.

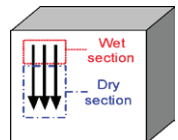
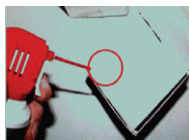

Figure 8. Cleaning procedure

Connector Inspection Guide

CONCLUSION

There are a number of reasons to be excited about by what is going on technologically in the optical telecommunication world. With the advent of 40 Gbit/s transmission and even faster in the near future, numerous challenges will be faced. However, it should never be overlooked that what may seem as a trivial task—ensuring that connectors are clean before connecting—may represent one of the most difficult challenges in the field. In light of this, it is important that connectors receive proper maintenance and that the cleaning procedures are respected to avoid network failure.

Appendix 1—Cleaning Procedure

Figure 9 below, illustrates the step-by-step inspection/cleaning procedure that should be rigorously followed before a fiber is connected to another optical component—using this simple procedure can avoid costly network downtime.

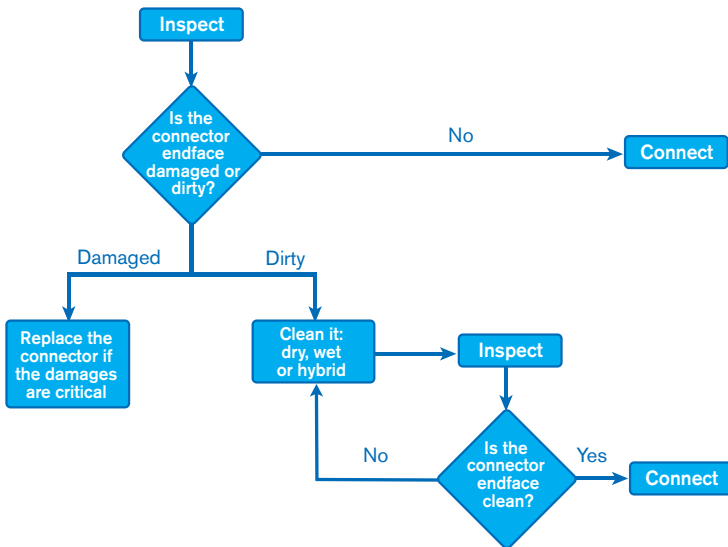
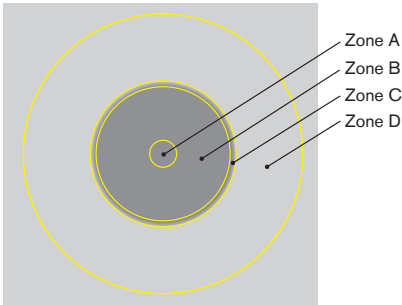

Figure 9. Connector inspection and cleaning procedure

Connector Inspection Guide

Appendix 2 – IEC 61300-3-35 and IPC 8497-1 Standards

CONNECTOR ENDFACE CRITERIA ARE DEFINED INTO DIFFERENT ZONES



Zones	Singlemode (µm)	Multimode (µm)
A: Core	0-25	0-65
B: Cladding	25-120	65-120
C: Adhesive	120-130	120-130
D: Contact	130-250	130-250

Appendix 3 – IEC 61300-3-35 and IPC 8497-1 Standards

EACH ZONE HAVE A DIFFERENT TOLERANCE

Here's an example for PC polished connectors, singlemode fiber, return loss ≥ 45 dB

Zones	Scratches	Defects
A: core (0 µm to 25 µm)	None	None
B: cladding (25 µm to 120 µm)	No limit ≤ 3 µm None > 3 µm	No limit < 2 µm Five from 2 µm to 5 µm None > 5 µm
C: adhesive (120 µm to 130 µm)	No limit	No limit
D: contact (130 µm to 250 µm)	No limit	None ≥ 10 µm

IEC 61300-3-35 STANDARD:

- › Singlemode, UPC connector, return loss of 45 dB: single and multiple fibers
- › Singlemode, UPC connector, return loss of 26 dB: single and multiple fibers
- › Multimode, UPC connector: single and multiple fibers
- › Singlemode, angled connector: single and multiple fibers

IPC 8497-1 STANDARDS:

- › Singlemode, new UPC connector: single and multiple fibers
- › Singlemode, field UPC connector: single and multiple fibers
- › Multimode, UPC connector: single and multiple fibers

Connector Inspection Guide

Appendix 4 – Tips

Model	Description	Tip	FIPT-400-AD-P5 Compatibility Status
FIPT-400-Adapter	Adapter tip (to attach any Westover probe tip to EXFO's probe)		X
FIPT-400-D4	D4 tip for bulkhead adapter		✓
FIPT-400-E2000	E2000 tip for bulkhead adapter		✓
FIPT-400-E2000-APC	E2000 APC tip for bulkhead adapter		✓
FIPT-400-FC-SC	FC/SC tip for bulkhead adapter		✓
FIPT-400-FC-SC-APC	FC/APC tip for bulkhead adapter		✓
FIPT-400-LEMO	Lemo bulkhead adapter		✓
FIPT-400-LC	LC tip for bulkhead adapter		✓
FIPT-400-LC-A6	LC angled tip for bulkhead adapter (60°)		✓
FIPT-400-LC-APC	LC/APC tip for bulkhead adapter		X





Connector Inspection Guide

Model	Description	Tip	FIPT-400-AD-P5 Compatibility Status
FIPT-400-LX5-APC	LX.5/APC tip for bulkhead adapter		✓
FIPT-400-MTP2	MTP tip for bulkhead adapter (extended, reversible)		✓
FIPT-400-MTP2-TIP	MTP tip for bulkhead adapter (extended, reversible)		✓
FIPT-400-MTPA2	MTP/APC tip for bulkhead adapter (extended, reversible)		✓
FIPT-400-MTPA-TIP	MTPA tip for bulkhead adapter (extended)		✓
FIPT-400-MTP2-K	MTP/APC/UPC tip for bulkhead adapter (extended, reversible)		✓
FIPT-400-MU	MU tip for bulkhead adapter		✓
FIPT-400-MU-L	Extended MU tip for PC bulkhead adapter		✓
FIPT-400-ODC-S	ODC Socket (male) tip		✓
FIPT-400-ODC-U	ODC Universal Guide tip		✓





Connector Inspection Guide

Model	Description	Tip	FIPT-400-AD-P5 Compatibility Status
IPT-400-ODC-2PIN-P	ODC 2 Pin Plug (female) Guide tip		✓
FIPT-400-ODC-4PIN-P	ODC 4 Pin Plug (female) Guide tip		✓
FIPT-400-ODC-2PIN-P-K	ODC 2 Pin Plug (female) Guide & Universal tip		✓
FIPT-400-ODC-4PIN-P-K	ODC 4 Pin Plug (female) Guide & Universal tip		✓
FIPT-400-ODC-2&4PIN-P-K	ODC 2 & 4 Pin Plug (female) Guides & Universal tip		✓
FIPT-400-SC-APC	SC APC tip for bulkhead adapter		✓
FIPT-400-OTAP-APC	OptiTap™ bulkhead adapter		✓
FIPT-400-OTIP-MT-APC	MT/APC type OptiTip™ multifiber adapter for male and female connectors; comes into a kit compatible with male and female cable ends		X
FIPT-400-OTIP-MT-APC/M	Male adapter tube for FIPT-400-OTIP-MT-APC tip		X
FIPT-400-FC-SC-A6	FC and SC angled tip for bulkhead adapter (60°)		✓

Connector Inspection Guide

Model	Description	Tip	FIPT-400-AD-P5 Compatibility Status
FIPT-400-SC-L	SC tip for PC bulkhead adapter (extended)		✓
FIPT-400-ST	ST tip for bulkhead adapter		✓
FIPT-400-U12M	Universal patchcord tip for 1.25 mm ferrule		✓
FIPT-400-U12MA	Universal patchcord tip for 1.25 mm APC ferrule		✓
FIPT-400-U20M2	Universal patchcord tip for 2.0 mm ferrule (D4, Lemo)		✓
FIPT-400-U25M	Universal patchcord tip for 2.5 mm ferrule		✓
FIPT-400-U25MA	Universal patchcord tip for 2.5 mm APC ferrule		✓
FIPT-400-SMA	SMA tip for bulkhead connector		✓
FIPT-400-SMAM	SMA tip for male connector		✓
FIPT-400-LX.5	LX.5 PC tip for bulkhead connector		✓

Connector Inspection Guide

Model	Description	Tip	FIPT-400-AD-P5 Compatibility Status
FIPT-400-U16M	Universal 1.6 PC tip for male connector		✓
FIPT-400-MTRJ	MTRJ tip for MTRJ bulkhead		✓
FIPT-400-SC-APC-L	SC angled tip for bulkhead connector (extended)		✓
FIPT-400-AD-P5	Adapter tip (allows the user to attach EXFO's FIP-400 probe tips to the old Westover probe)		✓

EXFO Corporate Headquarters > 400 Godin Avenue, Quebec City (Quebec) G1M 2K2 CANADA | Tel.: +1 418 683-0211 | Fax: +1 418 683-2170 | info@EXFO.com

			Toll-free: +1 800 663-3936 (USA and Canada) www.EXFO.com
EXFO America	3400 Waterview Parkway, Suite 100	Richardson, TX 75080 USA	Tel.: +1 972 761-9271 Fax: +1 972 761-9067
EXFO Asia	100 Beach Road, #22-01/03 Shaw Tower	SINGAPORE 189702	Tel.: +65 6333 8241 Fax: +65 6333 8242
EXFO China	36 North, 3 rd Ring Road East, Dongcheng District Room 1207, Tower C, Global Trade Center	Beijing 100013 P. R. CHINA	Tel.: + 86 10 5825 7755 Fax: +86 10 5825 7722
EXFO Europe	Omega Enterprise Park, Electron Way	Chandlers Ford, Hampshire S053 4SE ENGLAND	Tel.: +44 23 8024 6810 Fax: +44 23 8024 6801
EXFO NetHawk	Elektronikaite 2	FI-90599 Oulu, FINLAND	Tel.: +358 (0)403 010 300 Fax: +358 (0)8 564 5203
EXFO Service Assurance	270 Billerica Road	Chelmsford, MA 01824 USA	Tel.: +1 978 367-5600 Fax: +1 978 367-5700