

# AXS-200/850

Ethernet Test Set



---

Copyright © 2007–2009 EXFO Electro-Optical Engineering Inc. All rights reserved. No part of this publication may be reproduced, stored in a retrieval system or transmitted in any form, be it electronically, mechanically, or by any other means such as photocopying, recording or otherwise, without the prior written permission of EXFO Electro-Optical Engineering Inc. (EXFO).

Information provided by EXFO is believed to be accurate and reliable. However, no responsibility is assumed by EXFO for its use nor for any infringements of patents or other rights of third parties that may result from its use. No license is granted by implication or otherwise under any patent rights of EXFO.

EXFO's Commerce And Government Entities (CAGE) code under the North Atlantic Treaty Organization (NATO) is 0L8C3.

The information contained in this publication is subject to change without notice.

### ***Trademarks***

EXFO's trademarks have been identified as such. However, the presence or absence of such identification does not affect the legal status of any trademark.

### ***Units of Measurement***

Units of measurement in this publication conform to SI standards and practices.

December 17, 2009

Version number: 6.0.0

---

# Contents

Certification Information .....	vii
<b>1 Introducing the AXS-200/850 Ethernet Test Set .....</b>	<b>1</b>
Features and Benefits .....	1
Models .....	2
Software Options .....	3
Optical Transceivers (SFP) .....	4
Conventions .....	5
<b>2 Safety Information .....</b>	<b>7</b>
Laser Safety Warnings .....	7
Installation Instructions Warnings .....	8
<b>3 Getting Started .....</b>	<b>9</b>
Power Sources .....	9
Turning the Unit On .....	9
<b>4 Using the Smart User Interface .....</b>	<b>11</b>
Keypad .....	11
Home Menu .....	12
Page Elements .....	19
<b>5 Signal Connection and LEDs .....</b>	<b>21</b>
Electrical 10/100/1000 Mbps Ethernet Port .....	22
Optical 100/1000 Mbps Ethernet Port .....	23
AXS-200/850 Ethernet Test Set LEDs .....	25
<b>6 Configuring and Starting a Test or Tool .....</b>	<b>27</b>
Configuring an RFC 2544 Test .....	27
Configuring a BERT Test .....	28
Configuring a Traffic Generation & Monitoring Test .....	29
Configuring a Smart Loopback Test .....	31
Configuring a Ping Tool .....	31
Configuring a Trace Route Tool .....	32
Configuring Cable Test Tool .....	32

# Contents

---

<b>7 Setup .....</b>	<b>33</b>
Interface .....	33
Port .....	34
Network .....	37
Default Gateway .....	42
VLAN .....	43
SFP .....	44
Remote Selection .....	45
Module .....	51
Save & Load Config .....	52
<b>8 RFC 2544 .....</b>	<b>57</b>
Global Configuration .....	58
Stream Configuration .....	62
Throughput Configuration .....	66
Back-to-Back Configuration .....	69
Frame Loss Configuration .....	71
Latency Configuration .....	73
Summary Results .....	75
Throughput Results .....	82
Back-to-Back Results .....	84
Frame Loss Results .....	86
Latency Results .....	88
Graph .....	90
Alarms/Errors .....	91
<b>9 BERT .....</b>	<b>97</b>
Global Configuration .....	99
Stream Configuration .....	103
Summary Results .....	107
Detailed Results .....	113
Service Disruption Results .....	114
Alarms/Errors .....	116
Logger .....	119

---

<b>10 Traffic Generation &amp; Monitoring .....</b>	<b>125</b>
Global Configuration .....	127
Shaping Configuration .....	130
Stream Configuration .....	132
Sequence Configuration .....	136
Jitter/Latency Configuration .....	138
Transmit Configuration .....	142
Stream Configuration .....	144
Network Configuration .....	149
<b>Default Gateway .....</b>	<b>153</b>
VLAN Configuration .....	155
Summary Results .....	156
Throughput Results .....	165
Sequence Results .....	167
Jitter/Latency Results .....	171
Alarms/Errors Results .....	173
Frame Count Results .....	176
Frame Size Results .....	177
Flow Control Results .....	179
Logger .....	180
<b>11 Smart Loopback .....</b>	<b>185</b>
Statistics .....	185
<b>12 Tools .....</b>	<b>187</b>
Ping Configuration .....	188
Ping Results .....	190
Ping Statistics .....	193
Trace Route Configuration .....	194
Trace Route Results .....	195
Cable Test Configuration .....	198
Cable Test Results - Summary .....	201
Cable Test Results - Wire Map .....	203
Cable Test Results - Delay/Length .....	207
Report Configuration .....	209
Report File .....	211
<b>13 System .....</b>	<b>213</b>
File Manager .....	214
VNC .....	216
Module Information .....	220

# Contents

---

- 14 Maintenance .....221**
  - Calibration Statement .....222
  - Recycling and Disposal (Applies to European Union Only) .....223
- 15 Troubleshooting .....225**
  - Solving Common Problems .....225
  - Contacting the Technical Support Group .....226
  - Transportation .....227
- 16 Warranty .....229**
  - General Information .....229
  - Liability .....230
  - Exclusions .....230
  - Certification .....230
  - Service and Repairs .....231
  - EXFO Service Centers Worldwide .....232
- A Specifications .....233**
- B Glossary .....237**
  - Acronym List .....237
  - VLAN .....244
- Index .....245**

## Certification Information

### Federal Communications Commission (FCC) and Industry Canada (IC) Information

Electronic test and measurement equipment is exempt from FCC Part 15 compliance in the United States and from IC ICES 003 compliance in Canada. However, EXFO Electro-Optical Engineering Inc. (EXFO) makes reasonable efforts to ensure compliance to the applicable standards.

The limits set by these standards are designed to provide reasonable protection against harmful interference when the equipment is operated in a commercial environment. This equipment generates, uses, and can radiate radio frequency energy and, if not installed and used in accordance with the user guide, may cause harmful interference to radio communications. Operation of this equipment in a residential area is likely to cause harmful interference in which case the user will be required to correct the interference at his own expense.

### European Union (CE) Information

Electronic test and measurement equipment is subject to the EMC Directive in the European Union. The EN61326 standard prescribes both emission and immunity requirements for laboratory, measurement, and control equipment. This unit has been tested and found to comply with the limits for a Class A digital device. Please refer to the *CE Declaration of Conformity* on page ix.

**Note:** *If the equipment described herein bears the CE symbol, the said equipment complies with the applicable European Union Directive and Standards mentioned in the Declaration of Conformity.*

## Certification Information

---

### **Laser**

Class 1 laser product.

This product complies with 21 CFR 1040.10 except for deviations pursuant to Laser Notice No. 50, dated July 26, 2001 and with IEC 60825-1:2001 and EN 60825-1:1994 +A11:1996 +A2:2001 +A1:2002.



## CE Declaration of Conformity

# EXFO DECLARATION OF CONFORMITY

Application of Council Directive(s): 2006/95/EC - The Low Voltage Directive  
2004/108/EC - The EMC Directive  
and their amendments  
Manufacturer's Name: EXFO Electro-Optical Engineering Inc.  
Manufacturer's Address: 400 Godin Avenue  
Quebec, Quebec  
Canada, G1M 2K2  
Equipment Type/Environment: Test & Measurement / Industrial  
Trade Name/Model No.: AXS-200/850  
Ethernet Test Set

**Standard(s) to which Conformity is Declared:**

**EN 61010-1:2001** Safety Requirements for Electrical Equipment for Measurement, Control, and Laboratory Use, Part 1: General Requirements.

**EN 61326-1:2006** Electrical Equipment for Measurement, Control and Laboratory Use – EMC Requirements – Part 1: General Requirements.

**EN 60825-1:1994** Safety of Laser Products – Part 1: Equipment classification, requirements and user's guide.  
**+A11:1996 +A2:2001 +A1:2002**

*I, the undersigned, hereby declare that the equipment specified above conforms to the above Directive and Standards.*

**Manufacturer**

Signature:



Full Name: Stephen Bull, E. Eng  
Position: Vice-President Research and Development  
Address: 400 Godin Avenue, Quebec (Quebec),  
Canada, G1M 2K2  
Date: February 1, 2009



# 1 **Introducing the AXS-200/850 Ethernet Test Set**

The AXS-200/850 Ethernet Test Set provides Ethernet testing capability on the AXS-200. It supports one electrical interface through an RJ-45 connector and one optical interface through a standard pluggable SFP. The AXS-200/850 Ethernet Test Set provides a comprehensive offering of test features such as RFC 2544, BERT over IP, Traffic Generation & Monitoring, Smart Loopback, Ping, Trace Route, Remote loopback, and Cable Test.

## **Features and Benefits**

- All-in-one unit for installing, turning up and maintaining Metro Ethernet Circuits over IPv4/IPv6
- User-definable RFC-2544 test routines
- Asymmetrical network testing capability fully controlled from the local module (DTS RFC 2544)
- Bit-error-rate testing (BERT) up to layer 4
- Traffic Generation & Monitoring test used for performance evaluation of Ethernet or IP network
- Ethernet cable testing: **Category 3/Class C, Category 4, Category 5, Category 5e/Class D, and Category 6e/Class E**
- Intelligent network auto discovery for simplified loopback testing and asymmetrical network testing
- Configurable VLAN with Q-in-Q capability
- QoS, ToS, and Diffserv capabilities
- Pass/Fail results (LED indicators) with user defined thresholds
- Event logger for the Traffic Generation & Monitoring and BERT tests. It provides an historical account of the events recorded while a test case was running, including the threshold crossing events.

# Introducing the AXS-200/850 Ethernet Test Set

## Models

---

- One electrical interface supporting:
  - 10 Mbps
  - 100 Mbps
  - 1000 Mbps
- One optical interface supporting:
  - 100 Mbps
  - 1000 Mbps
- Service Disruption Time (SDT) measurement

## Models

Two models are available and are described as follows:

Model	Description
AXS-850	Ethernet 10Base-T/100Base-TX electrical.
AXS-850-1	Ethernet 10/100/1000 electrical and GigE optical.

## Software Options

Software keys are available to enable additional services. For information on how to install and activate software options, refer to the AXS-200 User Guide.

Options	Description
100optical	Enable support for 100 Mbps optical interface. The displayed name on the Software Options tab is 100M-O-AP.
GigE	Enable support for 1000Base-T and GigE optical interface. The displayed name on the Software Options tab is 1000M-E and 1000M-O.
Cable_Test	Enable support for Ethernet electrical cable test. The displayed name on the Software Option tab is Cable_Test.
Traffic_Gen	Enable Traffic Generation & Monitoring test. The displayed name on the Software Option tab is Traffic_Gen.
Multiple_Streams	Enable support for Background Streams Configuration and Monitoring of the Traffic Generation & Monitoring test. The Background Streams option can only be activated once the Traffic_Gen software option is activated. The displayed name on the Software Option tab is Multiple_Streams.
IPV6	Enable support for IPV6 testing. The IP version can only be configurable once the IPV6 software option is activated. The displayed name on the Software Option tab is IPV6.

## Introducing the AXS-200/850 Ethernet Test Set

### Optical Transceivers (SFP)

---

## Optical Transceivers (SFP)

The following table lists the compatible SFPs that can be ordered through EXFO.

EXFO Part Number	Description
FTB-85911	100Base-LX10, 1310 nm, 15 Km
FTB-85910	100Base-FX, 1310 nm, 2 Km
FTB-8592	1000Base-ZX, 1550 nm, 80 Km
FTB-8591	1000Base-LX, 1310 nm, 10 Km
FTB-8590	1000Base-SX, 850 nm, 550 m
FTB-8597	1000Base-BX10-U, Bi-directional 1310 nm TX, 1490 nm RX, 10 Km
FTB-8596	1000Base-BX10-D, Bi-directional 1490 nm TX, 1310 nm RX, 10 Km

## Conventions

Before using the product described in this manual, you should understand the following conventions:



### **WARNING**

Indicates a potentially hazardous situation which, if not avoided, could result in *death or serious injury*. Do not proceed unless you understand and meet the required conditions.



### **CAUTION**

Indicates a potentially hazardous situation which, if not avoided, may result in *minor or moderate injury*. Do not proceed unless you understand and meet the required conditions.



### **CAUTION**

Indicates a potentially hazardous situation which, if not avoided, may result in *component damage*. Do not proceed unless you understand and meet the required conditions.



### **IMPORTANT**

Refers to information about this product you should not overlook.





## 2 **Safety Information**

### **Laser Safety Warnings**



#### **WARNING**

Do not install or terminate fibers while a laser source is active. Never look directly into a live fiber, and ensure that your eyes are protected at all times.



#### **WARNING**

This product may employ a Class 1 SFP.



#### **WARNING**

When the LASER LED is on, the AXS-200/850 is receiving/emitting an optical signal.

# Installation Instructions Warnings



## CAUTION

No user serviceable parts are contained inside. Contact the manufacturer regarding service of this equipment.



## IMPORTANT

All wiring and installation must be in accordance with local building and electrical codes acceptable to the authorities in the countries where the equipment is installed and used.



## CAUTION

Electrostatic Discharge (ESD) Sensitive Equipment:

To minimize the risk of damage, dissipate static electricity by touching a grounded unpainted metal object

- before connecting or disconnecting cables to/from the module.
- before inserting or removing SFPs to/from the module.

# 3 **Getting Started**

Windows CE 6.0 is the baseline operating system software and is pre-installed on the Sharp Tester. If the AXS-200/850 Ethernet Test Set is not already installed, refer to the Sharp Tester User Guide for more information on how to install the module.

## **Power Sources**

The unit operates with the following power sources:

- AC adapter/charger (connected to standard power outlet—indoor use only). Compatible car outlet adapter available upon request.
- One Lithium-Ion rechargeable batteries (automatically take over if you disconnect the AC adapter/charger). Battery recharge is automatic when the AC adapter/charger is connected.

## **Turning the Unit On**









Turn on the AXS-200 by pressing the  button. Refer to the AXS-200 User Guide for more information.



# 4 Using the Smart User Interface

## Keypad

Refer to the AXS-200 User Guide for more information on how to use the keypad. The naming convention and purpose for each key is described in the AXS-200 User Guide.

	<b>Power:</b> Turns the unit on and off or puts it into suspend/resume mode.
	<b>Start/Stop:</b> Starts and stops the test/tool.
	<b>Home:</b> Brings the screen back to the <b>Home</b> menu.
	<b>Select:</b> Selects the highlighted item on the screen. Also used to edit and to close a field.
	<b>Back:</b> Returns to the previous screen or menu. In edition mode, it cancels the data-entry.
	<b>Help:</b> Opens and closes the help for the current window.
	<b>Brightness:</b> Controls lighting level of screen.
<b>F</b>	<b>Function Keys:</b> Located under the screen, the three function keys F1, F2, F3 are used to select the tabs on the screen positioned directly above each key (for example, F1 is used to select the left-most tab).
	<b>Function Arrows:</b> Displays the previous or next set of tabs.
	<b>Navigation Arrows:</b> Used to navigate and highlight items within a window. The up and down arrow keys can be used in edition mode to increase or decrease the number value.
	<b>Alpha-numeric Keypad:</b> Used to perform the following: <ul style="list-style-type: none"><li>➤ Enter numbers and letters onto the screen in the same manner as a phone keypad (for example, for the letter “B”, press the number “2” button two times).</li><li>➤ Select menu items by pressing the corresponding numbers.</li></ul>

# Using the Smart User Interface

## Home Menu

### Home Menu

Upon start up, the **Home** menu is displayed. Use the up and down navigation arrows to navigate and highlight menu items.

**Note:** To choose a menu item, press the  button or press the keypad number corresponding to the number of the item.

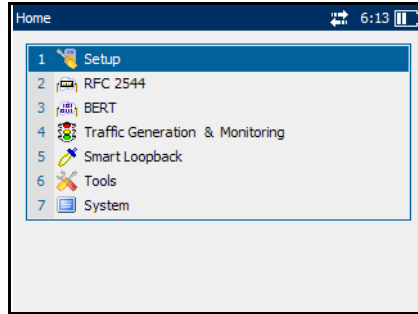

Press the  button to return to the **Home** menu from any screen.

**Setup:** Allows to configure the test interface, module, remote selection, and save/load the complete unit configuration.

**RFC 2544:** Allows configuring the subtests and viewing test results.

**BERT:** Allows Ethernet traffic generation and analysis up to Layer 4 with specific test pattern for Bit Error Rate analysis.

**Traffic Generation & Monitoring:** Allows traffic generation and analysis to qualify the performance of Ethernet or IP Network.

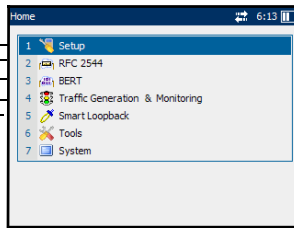

**Tools:** Allows to ping, trace route, cable test, and report.

**System:** Allows file management, system settings, software options management, and display of system information.

**Smart Loopback:** Allows transmitting back the stream of data while interchanging the source and destination addresses of the MAC, IP and UDP/TCP layers.

The **Home** menu offers the following content:

Home Menu	Submenu	Tabs/Pages
<b>1. Setup<sup>a</sup>:</b> Allows to configure the test interface, module, remote selection, and save/load the complete unit configuration.	<b>1. Interface<sup>a</sup>:</b> Displays tabs used to set up the interface before starting a test case.	<b>Port<sup>b</sup></b> <b>Network</b> <b>Default Gateway<sup>c</sup></b> <b>VLAN</b> <b>SFP</b>
	<b>2. Remote:</b> Displays tabs used to configure manual selection and discovery.	<b>Manual Selection</b> <b>Discovery</b>
	<b>3. Module:</b> Displays the page to configure the module settings.	
	<b>4. Save &amp; Load Config:</b> Displays the page to save the test settings and load them whenever required.	

## Using the Smart User Interface

### Home Menu

---

Home Menu	Submenu	Tabs/Pages
<b>2. RFC 2544:</b> Allows to configure the subtests and to view test results.	<b>1. Configuration:</b> Displays tabs to configure the global and stream settings and the subtest settings.	<b>Global</b> <b>Stream</b> <b>Throughput</b> <b>Back-to-Back</b> <b>Frame Loss</b> <b>Latency</b>
	<b>2. Results:</b> Displays tabs to view results and alarms/errors.	<b>Summary</b> <b>Throughput</b> <b>Back-to-Back</b> <b>Frame Loss</b> <b>Latency</b> <b>Graph</b> <b>Alarms/Errors</b>
<b>3. BERT:</b> Allows Ethernet traffic generation and analysis up to Layer 4 with specific test pattern for Bit Error Rate analysis.	<b>1. Configuration:</b> Displays tabs to configure the global and stream settings.	<b>Global</b> <b>Stream</b>
	<b>2. Results:</b> Displays tabs to view results and alarms/errors.	<b>Summary</b> <b>Detailed</b> <b>Service Disruption</b> <b>Alarms/Errors</b>
	<b>3. Logger:</b> Displays the list of recorded events.	



Home Menu	Submenu	Tabs/Pages
<b>4. Traffic Generation &amp; Monitoring:</b> Traffic Generation & Monitoring test is used for performance evaluation of Ethernet or IP network.	<b>1. Stream Config:</b> Displays tabs to configure the main stream and global test properties settings.	<b>Global Shaping Stream Sequence Jitter/Latency</b>
	<b>2. Background Streams Config:</b> Displays tabs to configure the Background stream properties.	<b>Transmit Stream Network Default Gateway<sup>c</sup> VLAN</b>
	<b>3. Results:</b> Displays tabs to view results.	<b>Summary Throughput Sequence Jitter/Latency Alarms/Errors Frame Counts Frame Size Flow Control</b>
	<b>4. Logger:</b> Displays the list of recorded events.	
<b>5. Smart Loopback:</b> Allows transmitting back the stream of data while interchanging the source and destination addresses of the MAC, IP and UDP/TCP layers.		

## Using the Smart User Interface

### Home Menu

---

Home Menu	Submenu	Tabs/Pages
<b>6. Tools:</b> Allows to ping, trace route, cable test, and report.	<b>1. Ping:</b> Displays tabs to configure ping and to view results and statistics.	<b>Configuration</b> <b>Results</b> <b>Statistics</b>
	<b>2. Trace Route:</b> Displays tabs to configure trace route and view results.	<b>Configuration</b> <b>Results</b>
	<b>3. Cable Test:</b> Displays tabs to configure cable test and view results.	<b>Configuration</b> <b>Results</b>
	<b>4. Report:</b> Allows to configure and save reports.	<b>Configuration<sup>b</sup></b> <b>File</b>

Home Menu	Submenu	Tabs/Pages
<b>7. System<sup>d</sup>:</b> Allows file management, system settings, software options management, and display of system information.	<b>1. Utilities:</b> Displays the <b>File Manager</b> utility and VNC support.	<b>1. File Manager</b> <b>2. VNC</b>
	<b>2. Settings:</b> Displays submenus to configure system settings.	<b>1. Date and Time</b> <b>2. Display and Language</b> <b>3. Network Connection</b> <b>4. Power</b>
	<b>3. Software Options:</b> Displays tabs to select and activate software option for module and platform.	<b>Module Platform</b>
	<b>4. Information:</b> Displays tabs to view company, system and module information.	<b>About</b> <b>Module</b> <b>Application</b> <b>Platform</b> <b>Memory</b> <b>Components</b>

- a. The items in the **Home** menu and Submenu columns are numbered and can be selected with the ✓ button or by pressing on the corresponding number on the keypad.
- b. The items that are numbered in the **Tabs/Page** column are **pages** and can be selected by pressing on the corresponding numbers. Items in this column that are not numbered are **tabs** and can be selected using the corresponding function keys (F1/F2/F3) under the screen.
- c. The **Default Gateway** tab is only available when the selected IP version is IPv6.
- d. Information on the **System** menu item is covered in the AXS-200 User Guide.

# Using the Smart User Interface

## Home Menu

The menu structure is shown as follows.

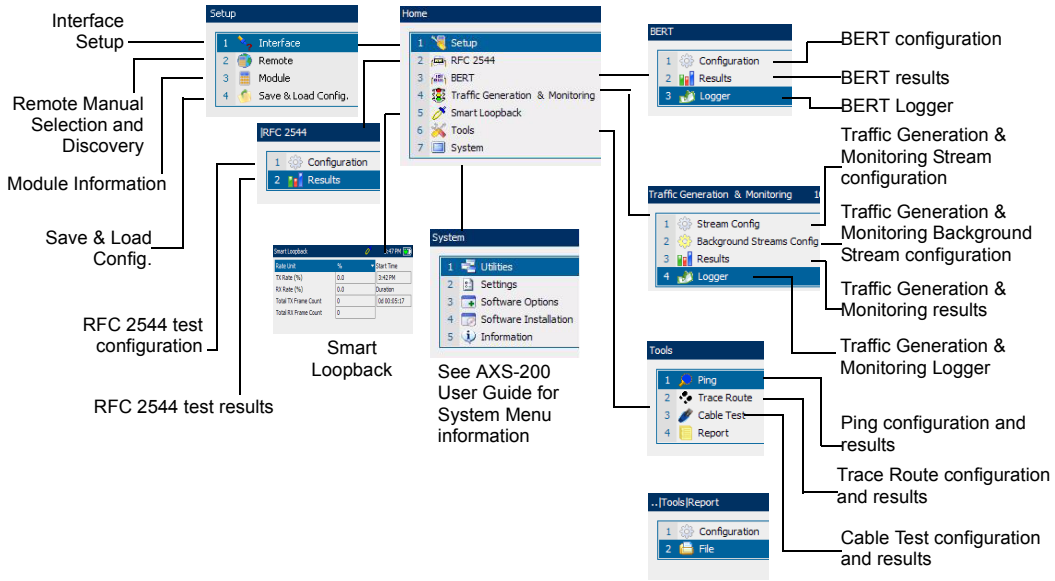

## Tabs

If more than one page exists on the same screen, the names of these pages are displayed as tabs on the bottom of the screen. To access a page, press the function (F1/F2/F3) keys beneath the tab name. If an arrow appears next to the tabs on the bottom of the screen (see the following figure), use the function arrow keys to scroll to the next set of tabs.

# Page Elements

The title bar (blue bar) on the top of the screen is common to every page. It displays the following from left to right:

- The path and name of the page
- The optical power
- Remote Loopback icon
- Test/tool icon
- Active Sync indicator
- Time (optional)
- Power source indicator

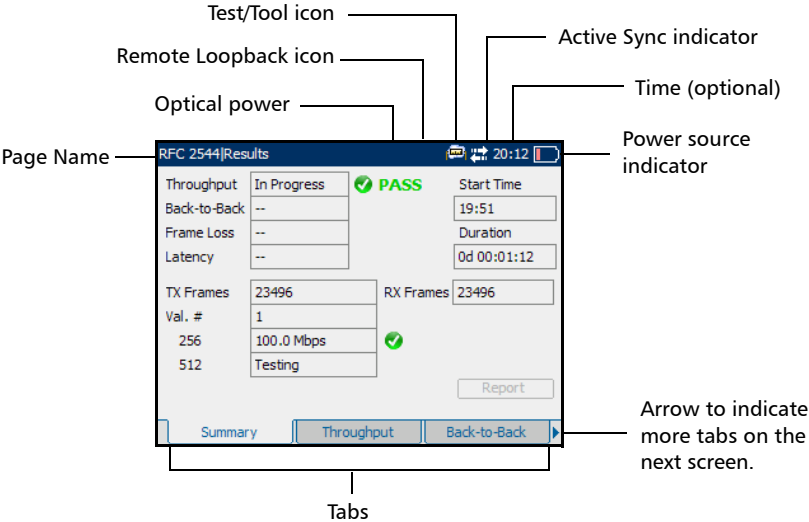

Use the arrow buttons to navigate the fields and press the ✓ button to select the parameter for each field. Press the ✓ button to open a field for editing and the ↩ button to exit the edit mode.

### **Help**

The help button (?) displays the help information on the current page. It is possible to navigate through the help information with the navigation arrows once the help window is opened. The help button (?) also closes the help window.

## 5 **Signal Connection and LEDs**

This section describes all connectors (ports) and LEDs available on the AXS-200/850 Ethernet Test Set.

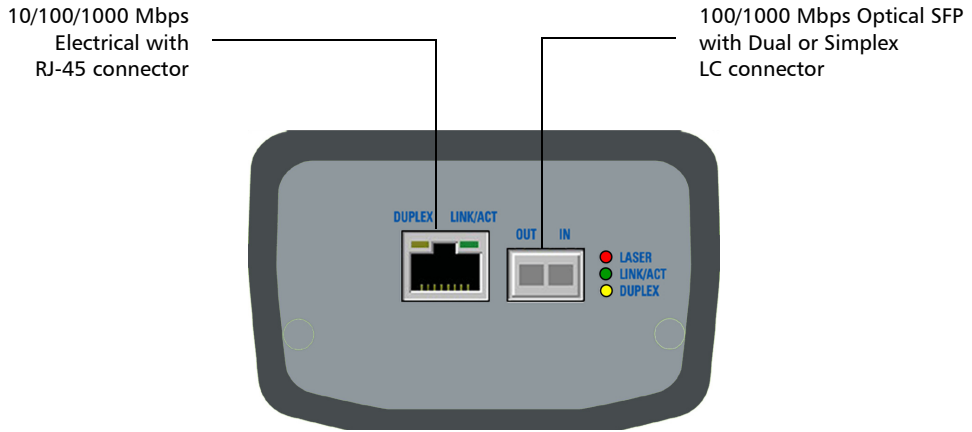

The AXS-200/850 Ethernet Test Set is equipped with one RJ-45 electrical and one SFP optical port (location of Laser/LED aperture).

**Note:** *An SFP can be replaced at any time. If an SFP is changed while the optical interface is selected and active, the laser will turn on automatically. Use caution when installing the SFP in case the laser is enabled.*

## Signal Connection and LEDs

Electrical 10/100/1000 Mbps Ethernet Port

---

### Electrical 10/100/1000 Mbps Ethernet Port

The AXS-200/850 Ethernet Test Set module provides one electrical port for 10Base-T, 100Base-TX, or 1000Base-T. This port may also be used for cable testing.

**Note:** Refer to section A for cable specifications.

- Connect the 10/100/1000 electrical signal or the cable to be tested to the port with the RJ-45 connector.
- LEDs for the electrical port:

LED	Status	Description
LINK/ACT (Green)	On	Ethernet link up.
	Off	Ethernet link down.
	Flashing	TX/RX activity.
DUPLEX (Yellow)	On	Full Duplex mode.
	Off	Half Duplex mode.
	Flashing	Collisions are detected.



## Optical 100/1000 Mbps Ethernet Port

The AXS-850-1 module provides respectively one optical port for 100Base-FX/1000Base-X Ethernet testing. The optical port is Small Form Factor Pluggable (SFP) slot type (Dual or Simplex LC connector).

- Insert one of the following SFP modules into the optical slot.

Rate	Description
100Base-X	1310 nm SFP module for 100Base-FX, MMF, 2 Km.
	1310 nm SFP module for 100Base-LX10, SMF, 15 Km.
1000Base-X	850 nm SFP module for 1000Base-SX, 550 m.
	1310 nm SFP module for 1000Base-LX, 10 Km.
	1550 nm SFP module for 1000Base-ZX, 80 Km.
1000Base-BX	1310 nm TX, 1490 nm RX, SFP module for 1000Base-BX-U, SMF, 10 Km.
	1490 nm TX, 1310 nm RX, SFP module for 1000Base-BX-D, SMF, 10 Km.

**Note:** Refer to *Optical Transceivers (SFP)* on page 4 for the list of supported SFPs that can be ordered through EXFO.

- Carefully connect optical fiber cables to the SFP's IN and OUT ports. To ensure good signal quality, make sure that the optical fiber connector is fully inserted into the optical connector port.

## Signal Connection and LEDs

*Optical 100/1000 Mbps Ethernet Port*

---

### LEDs for Optical Port

LED	Status	Description
LASER (Red)	On	An optical signal is generated
	Off	No optical signal is generated
LINK/ACT (Green)	On	Ethernet link up.
	Off	Ethernet link down.
	Flashing	TX/RX activity.
DUPLEX (Yellow)	On	Full Duplex mode.
	Off	Ethernet link down.

## AXS-200/850 Ethernet Test Set LEDs

The AXS-200/850 Ethernet Test Set displays 5 LEDs on the front. These LEDs, although built into the AXS-200 are operated by the AXS-200/850 Ethernet Test Set.



The description of the LEDs are as follows:

LED	Status	Color	Description
LASER	On	Red	An optical signal is generated
	Off		No optical signal is generated
LINK	On	Green	Ethernet link up
	Off		Ethernet link down
PASS/FAIL	On	Green	Test passed
	On	Red	Test failed
	Off		No test results
ALARM	On	Green	No alarms are present during test
	On	Red	At least 1 alarm is present during the test (current)
	On	Amber	At least 1 alarm was present during the test (history)
	Off		No test result
TEST	Flashing	Green	Test is running
	Off		Test is not running





# 6 **Configuring and Starting a Test or Tool**

The following procedures describe the overall steps to configure a test or tool.



## **Configuring an RFC 2544 Test**

### **To configure the RFC 2544 test:**

- 1.** Configure the interface by configuring the port, network, and VLAN settings. Refer to *Interface* on page 33. Ensure that the link is up (indicated by the platform LED) before proceeding to the next step.
- 2.** Optionally, set a remote module in loopback or DTS RFC 2544 mode. Refer to *Remote Selection* on page 45.
- 3.** Press , select **RFC 2544, Configuration**, and the **Global** tab.
- 4.** Configure the global settings by referring to *Global Configuration* on page 58.
- 5.** Select the **Stream** tab.
- 6.** Configure the stream settings by referring to *Stream Configuration* on page 62.
- 7.** Once the stream settings are configured, set up each subtest by referring to:
  - 7a.** *Throughput Configuration* on page 66 for **Throughput** test.
  - 7b.** *Back-to-Back Configuration* on page 69 for **Back-to-Back** test.
  - 7c.** *Frame Loss Configuration* on page 71 for **Frame Loss** test.
  - 7d.** *Latency Configuration* on page 73 for **Latency** test.
- 8.** Press  to start or stop the test.

# Configuring a BERT Test

### **To configure the BERT test:**

- 1.** Configure the interface by configuring the port, network, and VLAN settings. Refer to *Interface* on page 33. Ensure that the link is up (indicated by the platform LED) before proceeding to the next step.
- 2.** Optionally, set a remote module in loopback. Refer to *Remote Selection* on page 45.
- 3.** Press , select **BERT, Configuration**, and the **Global** tab.
- 4.** Configure the global settings by referring to *Global Configuration* on page 97.
- 5.** Select the **Stream** tab.
- 6.** Configure the stream by referring to *Stream Configuration* on page 101.
- 7.** Press  to start or stop the test.

# Configuring a Traffic Generation & Monitoring Test

## **To configure the Traffic Generation & Monitoring Test (Stream Config):**

- 1.** Configure the interface by configuring the port, network, and VLAN settings. Refer to *Interface* on page 33. Ensure that the link is up (indicated by the platform LED) before proceeding to the next step.
- 2.** Optionally set a remote module in loopback. Refer to *Remote Selection* on page 45.
- 3.** Press , select **Traffic Generation & Monitoring, Stream Config**, and the **Global** tab.
- 4.** Configure the global settings by referring to *Global Configuration* on page 125.
- 5.** Select the **Shaping** tab and configure the shaping settings by referring to *Shaping Configuration* on page 128.
- 6.** Select the **Stream** tab and configure the stream settings by referring to *Stream Configuration* on page 130.
- 7.** Select the **Sequence** tab and configure the sequence settings by referring to *Sequence Configuration* on page 134.
- 8.** Select the **Jitter/Latency** tab and configure the Jitter/Latency settings by referring to *Jitter/Latency Configuration* on page *Jitter/Latency Configuration* on page 136.

## Configuring and Starting a Test or Tool

### *Configuring a Traffic Generation & Monitoring Test*

---



#### **To configure the Traffic Generation & Monitoring Test (Background Streams Config):**

1. Press , select **Traffic Generation & Monitoring, Background Stream Config**, and the **Transmit** tab.
2. Configure the transmit settings by referring to *Transmit Configuration* on page 140.
3. Select the **Stream** tab and configure the stream settings by referring to *Stream Configuration* on page 142.
4. Select the **Network** tab and configure the network settings by referring to *Network Configuration* on page 147.
5. Select the **VLAN** tab and configure the VLAN settings by referring to *VLAN Configuration* on page 153.





### Configuring a Smart Loopback Test

**To configure the Smart Loopback test:**

1. Configure the interface by configuring the port, network, and VLAN settings. Refer to *Interface* on page 33. Ensure that the link is up before proceeding to the next step.
2. Press , and select **Smart Loopback**.
3. The test can be started from this page and the statistics are displayed on the same page.
4. Press  to start or stop the test.



### Configuring a Ping Tool

**To configure the Ping tool:**

1. Configure the interface by configuring the port, network, and VLAN settings. Refer to *Interface* on page 33. Ensure that the link is up before proceeding to the next step.
2. Press , select **Tools**, **Ping**, and the **Ping Configuration** tab.
3. Configure the **Ping** tool by referring to *Ping Configuration* on page 186.
4. Press  to start or stop the tool.



## Configuring a Trace Route Tool

### **To configure the Trace Route tool:**

1. Configure the interface by configuring the port, network, and VLAN settings. Refer to *Interface* on page 33. Ensure that the link is up before proceeding to the next step.
2. Press , select **Tools**, **Trace Route**, and the **Trace Route Configuration** tab.
3. Configure the **Trace Route** tool by referring to *Trace Route Configuration* on page 192.
4. Press  to start or stop the tool.

## Configuring Cable Test Tool

### **To configure the Cable Test tool:**

1. Configure the interface port **Transceiver Mode** to **Electrical** and the speed to either 10Mbps/100Mbps for two-pair cable test or 1Gbps for four-pair cable test. Refer to *Port* on page 34.
2. Press , select **Tools**, **Cable Test**, and the **Configuration** tab.
3. Configure the **Cable Test** tool by referring to *Cable Test Configuration* on page 196.
4. Press  to start the cable test tool.

# 7 Setup

The **Setup** menu is used to configure the test interface for the AXS-200/850 before it can be used for testing. The **Setup** menu offers the following structure:

Submenu	Tab/Page	Page
Interface	<i>Port</i>	34
	<i>Network</i>	37
	<i>Default Gateway<sup>a</sup></i>	42
	<i>VLAN</i>	43
	<i>SFP</i>	44
Remote	<i>Manual Selection</i>	48
	<i>Discovery</i>	46
Module	<i>Module</i>	51
Save & Load Config	<i>Save &amp; Load Config</i>	52

a. The Default Gateway tab is only available when the selected IP version is IPv6.

## Interface

The **Interface** is used to configure the local test interface. The required parameters correspond to the physical, data link, and network layers. The parameters are globally configured and applied to all the tests and tools. Ensure that these parameters are set before running any tests or tools. Configuring the interface includes configuring the port, network, and VLAN settings as described in the following procedures.

## Port

The **Port** tab allows the selection and the configuration of the physical port.

Press , select **Setup**, **Interface**, and the **Port** tab.

### To set up the port:

1. Select **Transceiver Mode**. Choices are **Electrical** and **Optical**. The default setting is **Electrical**.
2. Select **Cable Mode** if transceiver mode is set to electrical. Choices are **Auto Detection** or **Manual**. If **Manual** is selected, go to the next field and select the type of cable (**MDI** for straight through, **MDIX** for crossover).
3. Turn the **Laser** On or Off. This option is only applicable when the transceiver mode is optical.
4. Enable **Auto-Negotiation** if the remote connected port is also set to **Auto-Negotiation**, otherwise it should be disabled.

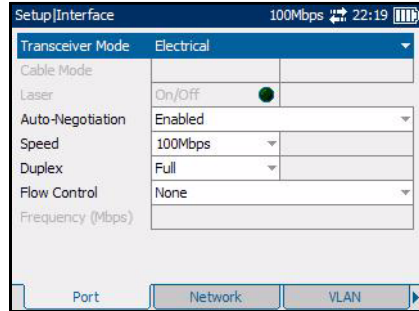

**Note:** *Auto-Negotiation is not available with the optical 100 Mbps interface. For other interfaces, this setting is enabled by default. The electrical 1000 Mbps interface is only available with **Auto-Negotiation** enabled.*

**5.** Select the **Speed** of the interface.

For electrical, the choices are **10 Mbps**, **100 Mbps**, **1000 Mbps** (requires software option) and **Auto** when **Auto-Negotiation** is **Enabled**.

For electrical, the choices are **10 Mbps**, **100 Mbps**, **1000 Mbps** (requires software option) when **Auto-Negotiation** is **Disabled**

For optical, the choices are **1000 Mbps** (requires software option) when **Auto-Negotiation** is **Enabled**.

For optical, the choices are **100 Mbps** and **1000 Mbps** (requires software option) when **Auto-Negotiation** is **Disabled**.

The default setting is **100 Mbps**.

**Note:** *The selected/negotiated speed is displayed besides the speed configuration parameter and in the title bar for the electrical interfaces.*

**6.** Select the **Duplex** mode. For 10 Mbps and 100 Mbps electrical interfaces, the choices are **Full**, **Half** and **Auto** when **Auto-Negotiation** is **Enabled**. The choices are **Full** and **Half** when **Auto-Negotiation** is **Disabled**. Half duplex is not supported for **BERT** and **Smart Loopback** tests. Default is **Full**.

**Note:** *For **Auto**, the negotiated duplex is displayed besides the duplex configuration parameter.*

The following table shows the values for the **Duplex Mode** and **Flow Control** that shall be used to be compatible with the different test applications.

Port Setup	RFC 2544	BERT	Traffic Gen.	Smart Loopback
Duplex	Half / Full	Full	Half / Full	Full
Flow Control	None / RX	None	None / RX	None

## Setup

### Port

---

7. Set the **Flow Control**. This option is applicable to the **RFC 2544** test and **Traffic Generation** test. **Flow Control** is not supported (set to **None**) for **BERT** and **Smart Loopback** tests. When **Flow Control** is enabled, the AXS-200/850 will stop transmitting for the requested time value specified by the valid flow control frame received. The choices are **None**, and **RX**. The default setting is **None**. When set to **None**, pause frames received are ignored.

**Note:** For *Auto*, the negotiated flow control is displayed besides the flow control configuration parameter.

8. **Frequency:** Indicates the frequency of the input signal in Mbps. When no frequency reading is possible, "--" is displayed.

## Network

The **Network** tab allows the configuration of the Ethernet port parameters.

Press , select **Setup**, **Interface**, and the **Network** tab.

### **To configure the Network settings:**

**Note:** The source **MAC Address** field is fixed and is not configured.

1. Select the **IP Version**. Choices are **IPv4** and **IPv6**. By default, **IPv4** option is selected.

**Note:** The **IP Version** field is configurable only when the **IPv6 software option** is activated in the **System, Software Options - Module** tab.

If **IPv4** option is selected as the IP version, configure the remaining fields as below.

2. Enable or disable the **DHCP**.

**Note:** If **DHCP** is enabled, all parameters are set to the values obtained through **DHCP**.

**Note:** If **DHCP** is disabled, **IP Address** and **Subnet Mask** fields become configurable. When **DHCP** is enabled, the **Default Gateway** is automatically obtained from **DHCP**.

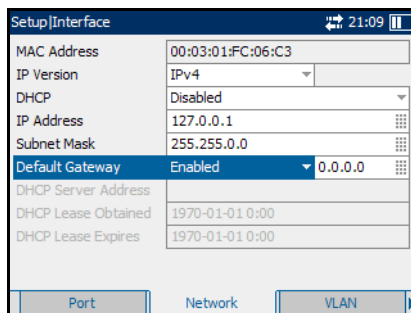

Setup Interface	
MAC Address	00:03:01:FC:06:C3
IP Version	IPv4
DHCP	Disabled
IP Address	127.0.0.1
Subnet Mask	255.255.0.0
Default Gateway	Enabled 0.0.0.0
DHCP Server Address	
DHCP Lease Obtained	1970-01-01 0:00
DHCP Lease Expires	1970-01-01 0:00

Port Network VLAN

3. Configure the **IP Address**. The default IP address is **10.10.0.0**. When the **IP Address** field is selected for editing, the **Latest IP's** button appears on the bottom of the screen. Press the corresponding function key to display the list of previously configured IP addresses. Select the desired IP address from the list, if any.

## Setup

### Network

---

4. If **DHCP** is disabled, enter the **Subnet Mask** for the Ethernet port. The default value is **255.255.0.0**.
5. Enable or disable the **Default Gateway**. The default setting is **Disabled**. If enabled, enter the default gateway address for the Ethernet port. The default value is **0.0.0.0**.
6. The **DHCP Server Address** displays the DHCP server IP address when DHCP is enabled.
7. The **DHCP Lease Obtained** displays the date and time that the IP address was leased from the DHCP server when DHCP is enabled.
8. The **DHCP Lease Expires** displays the date and time that the IP address lease will expire when DHCP is enabled.

If **IPv6** option is selected as the IP version, configure the remaining fields as below.

9. **Link-Local IPv6 Address (LLA)** is used for local communication between on-link neighbors and for Neighbor Discovery process.

#### Mode

- **StatelessAuto** allows automatic generation of the IPv6 address based on the MAC address. The **mode StatelessAuto** is selected by default.
- **Static** allows to enter the IP Address.

The screenshot shows the 'Setup/Interface' configuration window. The 'IP Version' is set to 'IPv6'. The 'Link-Local IPv6 Address' section has 'Mode' set to 'Static' and 'Address' set to 'FE80:0000:0000:0000:0203:01FF:FEFC:06C3'. The 'Global IPv6 Address' section has 'Mode' set to 'Static' and 'Address' set to '0000:0000:0000:0000 0203:01FF:FEFC:06C3'. The 'Interface ID Coupled' is set to 'Enabled' and the 'Prefix Mask' is 'FFFF:FFFF:FFFF:FFFF:0000:0000:0000:0000'. At the bottom, there are buttons for 'Port', 'Network', and 'Default Gateway'.

Setup/Interface	
MAC Address	00:03:01:FC:06:C3
IP Version	IPv6
Link-Local IPv6 Address	
Mode	Static Successful
Address	FE80:0000:0000:0000:0203:01FF:FEFC:06C3
Global IPv6 Address	
Mode	Static Successful
Address	0000:0000:0000:0000 0203:01FF:FEFC:06C3
Interface ID Coupled	Enabled
Prefix Mask	FFFF:FFFF:FFFF:FFFF:0000:0000:0000:0000



**Address:** This field is configurable only when the **Mode** is **Static**. The **Link-Local IPv6 Address** must start with **FE80**. The accepted range is from **FE80:0000:0000:0000:0000:0000:0000:0000** to **FE80:0000:0000:0000:FFFF:FFFF:FFFF:FFFF**. The default address is **FE80::[Interface ID]**, where **[Interface ID]** is generated from the source MAC address. When the **Address** field is selected for editing, the **Latest IP's** button appears on the bottom of the screen. Press the corresponding function key to display the list of previously configured IP addresses. Select the desired IP address from the list, if any.

- 10. Global IPv6 Address (GUA)** is used to communicate with on-link neighbors and for global communication with hosts outside the subnet.

#### **Mode**

- **None** disables the Global IPv6 address and the Default Gateway address.
- **StatelessAuto** allows automatic generation the IPv6 address based on the Link-Local address interface ID and the prefix obtained from the router advertisements. If no Interface ID has been obtained for the Link Local Address, the Global address will not be generated. The **mode StatelessAuto** is selected by default.
- **Static** allows to enter the IP Address.

**Address:** This field is configurable only when the **Mode** is **Static**. The accepted range is from **0000:0000:0000:0000:0000:0000:0000:0000** to **FEFF:FFFF:FFFF:FFFF:FFFF:FFFF:FFFF:FFFF**. The default address is **2001::[Interface ID]**, where the **[Interface ID]** is generated from the source MAC address. When the IP Address field is selected for editing, the **Latest IP's** button appears on the bottom of the screen. Press the corresponding function key to display the list of previously configured IP addresses. Select the desired IP address from the list, if any.

- **Interface ID Coupled:** This field is available when the **Global IPv6 Address Mode** is **Static**. This field allows to couple the interface ID of the Global address to the Link-Local source address. **Enable** or **Disable** the **Interface ID Coupled**. The default setting is **Enabled**.

When the Interface ID Coupled is **Enabled**, only the 64 bit (MSB) prefix ID in the IPv6 address is configurable, and the 64 bit (LSB) Interface ID is not configurable (read-only).

When the Interface ID Coupled is **Disabled**, the 64 bit (MSB) Prefix ID and 64 bit (LSB) Interface ID in the IPv6 address are configurable.

- 11.** Enter the **Prefix Mask**. This field is only configurable when the Global IPv6 Address Mode is **Static**. It allows to specify a prefix that defines the subnet. The accepted range is **0000:0000:0000:0000:0000:0000:0000:0000** to **FFFF:FFFF:FFFF:FFFF:0000:0000:0000:0000**. For example:

Global Address: 2001:0DB8:0001:0002:02AA:00FF:FE11:1111

Prefix Mask: FFFF:FFFF:FFFF:0000:0000:0000:0000:0000

Corresponding Prefix: 2001:0DB8:0001

The Link-Local/Global IPv6 Address Status is as below:

Mode	Status	Description
StatelessAuto	--	Undefined
	Generating	Stateless address autoconfiguration in progress.
	Successful	IP address has been generated but duplication has been detected.
	Duplication Detected	IP address has been generated but duplication has been detected
	Failed	IP address has not been generated.
Static	--	Undefined
	DAD Checking	Duplication address detection in progress.
	No Duplication	No duplication has been detected.
	Duplication Detected	Duplication has been detected. Note that duplicated address is not assigned to the interface and consequently unspecified (::) is assumed.

## Default Gateway

The **Default Gateway** tab allows the configuration of the default gateway address to forward packets outside the subnet.

Press , select **Setup**, **Interface**, and the **Default Gateway** tab.

**Note:** The **Default Gateway** tab is only available when IPv6 version is selected. See IP Version on page 37 to select IPv6 version. When IPv4 is selected, the default gateway can be configured in the **Network** tab.

➤ **Mode**

- **Automatic** allows automatic selection of the default gateway. The default setting is **Automatic**.
- **Static** allows entering the default gateway IP address.

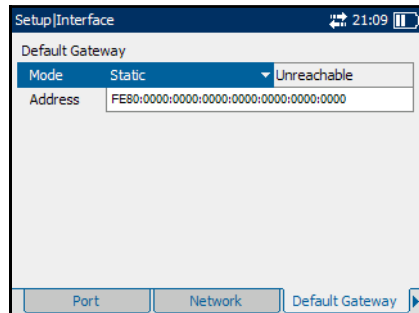

- **Address:** If the **Mode** is **Static**, enter the IP address of the **Default Gateway**. The accepted range is from **FE80:0000:0000:0000:0000:0000:0000:0000** to **FE80:0000:0000:0000:FFFF:FFFF:FFFF:FFFF**. The default address is **FE80:0000:0000:0000:0000:0000:0000:0000**. When the **Mode** is **Automatic**, the address field is not configurable.

The Default Gateway Address Status is as below:

Status	Description
--	Undefined
Checking	Detection in progress to determine if the Default Gateway is reachable or not.
Unreachable	Default Gateway is unreachable.
Reachable	Default Gateway is reachable.

## VLAN

The AXS-200/850 supports up to 2 stacked layers of VLAN. The **VLAN** tab allows users to configure the layers, its priority, type and drop eligible.

Press , select **Setup, Interface**, and the **VLAN** tab.

### To configure the VLAN settings:

1. Select the number of **VLAN** layers.  
Choices are **None**, **1** and **2** layers.  
For each layer, set the following parameters:
2. Enter the **VLAN ID**. The accepted range is from **0** to **4095**. The value **4095** is reserved while **0** and **1** have specific utility Refer to *VLAN* on page 242 for more information.  
The default value is **2**.
3. Select the **VLAN Priority**. The accepted range is from **0** to **7**. The default setting is **0** (low priority).
4. Select the **VLAN Type**. The choices for VLAN Ethernet type are **8100**, **88A8**, **9100**, **9200**, and **9300**. The default setting is **8100** for VLAN #1 and **88A8** for VLAN #2.
5. The **Drop Eligible** parameter allows the Service VLAN tag (S-TAG) to convey eight distinct priorities, each with a drop eligible indication. When enabled (DEI = 1), the drop eligible parameter is encoded in the DEI of transmitted frames. The drop eligible parameter should be enabled for a received frame if the DEI is set in the S-TAG or if the Priority Code Point Decoding Table indicates drop eligible enabled for the received PCP value. When disabled (DEI=0), the DEI is ignored on receipt. Drop Eligible is not available when VLAN type is 8100. This setting is disabled by default.

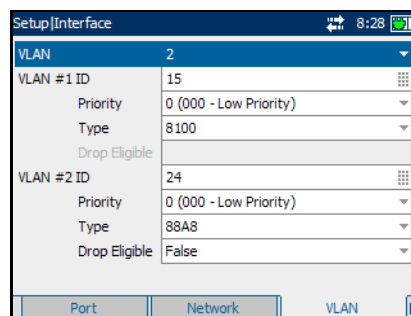

## SFP

The optical interface on the module is made available via a Small Form Factor Pluggable Module (SFP). For a list of supported SFPs, refer to *Optical Transceivers (SFP)* on page 4.

Press , select **Setup, Interface**, and the **SFP** tab.

The following information is displayed on the **SFP** page.

- **Module ID**
- **Vendor Name**
- **Part Number**
- **Serial Number**
- **Connector Type**: LC, MT-RJ, etc.
- **Speed**: 100Base-FX, 1000Base-SX, etc.

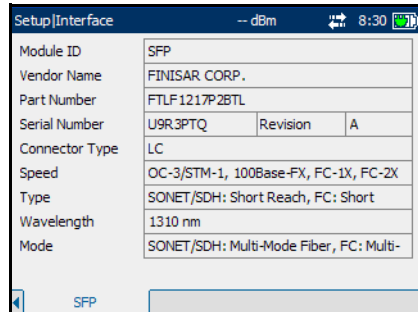

Module ID	SFP		
Vendor Name	FINISAR CORP.		
Part Number	FTLF1217P2BTL		
Serial Number	U9R3PTQ	Revision	A
Connector Type	LC		
Speed	OC-3/STM-1, 100Base-FX, FC-1X, FC-2X		
Type	SONET/SDH: Short Reach, FC: Short		
Wavelength	1310 nm		
Mode	SONET/SDH: Multi-Mode Fiber, FC: Multi-Mode Fiber		

**Note:** Ensure that the speed selected corresponds to the speed of the SFP installed.

- **Type**: Reach type: SR, IR, LR, etc.
- **Wavelength**: 850 nm, 1310 nm, 1550 nm.
- **Mode**: Single Mode Fiber (SMF) or Multi-Mode Fiber (MMF).

## Remote Selection

The AXS-200/850 can perform tests in conjunction with a second test set. A remote module can be connected to either start Smart Loopback test or perform an RFC2544 test in Dual Test Set mode (DTS).

The Remote Loopback feature provides the capability to loop up or loop down a remote device (target module). Looping up a target module is the same as setting the target module into Smart Loopback mode. This feature is especially useful for unidirectional testing whereby the test stream is transmitted from the local unit to a target module in loopback, and the test stream is received back and locally analyzed

**Note:** *When the Remote Loopback feature is used, the remote module should follow the Duplex/Flow Control configuration of the SmartLoopback test.*

The Dual Test Set (DTS) RFC 2544 allows to measure RFC 2544 conformity, where the downstream characteristics are different from the upstream. A test stream is transmitted from the local module to the remote module and from the remote module to the local module. Results of both the directions are consolidated on the local module.

The target module can be selected by entering its IP address (**Manual Selection** tab) or selecting it from an auto-discovery list (**Discovery** tab).

The local unit requests status information from remote units, which provides useful information on their state: idle, busy running a test or already looped up.

### Discovery

The AXS-200/850 scans the subnet to discover other AXS-200/850 modules and Packet Blazer modules configured as RFC 2544 Dual Test Set Remote mode such as 8510B, 8510G, 8525, 8535, 8120NGE, and 8130NGE.

- **Scan Subnet:** When scan subnet is enabled, the local module scans the subnet to discover remote modules. The scan relies on the subnet mask information configured through the **Network** tab (see *Network* on page 37).

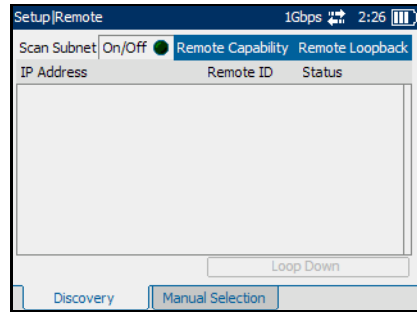

- **Remote Capability:** Select the Remote Capability. Choices are **Remote Loopback** and **DTS RFC 2544**. The default setting is **Remote Loopback**.

If **Remote Loopback** is selected, it will discover the module supporting the Remote Loopback feature.

If **DTS RFC 2544** is selected, it will discover the module supporting the DTS RFC 2544 feature.

#### **To put the remote module into Smart Loopback or DTS RFC 2544 mode:**

1. Once the list of discovered units is displayed, press the down arrow to highlight the list box (the box will be outlined in blue).
2. Press the ✓ button to select the list (the box will be outlined in yellow).
3. Use the navigation arrows to highlight the target module.
4. If **Remote Capability** is set to **Remote Loopback**, select the **Loop Up** button to enable the **Smart Loopback** mode on the target module.

If **Remote Capability** is set to **DTS RFC 2544**, select the **Connect** button to establish the connection with the target module.



An icon will be displayed in the title bar if the **Loop Up** or the **Connect** operation is successful.

5. For Remote Loopback, any test/tool can be started at this time.  
For DTS RFC 2544, only the RFC 2544, Ping and Trace Route tests/tools can be started.
6. To loop down or disconnect, press the down arrow to highlight the **Loop Down** or **Disconnect** button respectively for **Remote Loopback** or **DTS RFC 2544**.
7. Press the  button to select the **Loop Down** or **Disconnect** button to disable the **Smart Loopback** or **DTS RFC 2544** mode from the target module. Loop down or Disconnect is possible only following a successful loop up or connect process on a selected target module.

**Note:** *Even if a remote module is busy, it can still be overtaken by the **Loop Up** or **Connect** command.*

The possible statuses of the remote module are as follows:

Status	Description
<b>Idle</b>	No tests are running.
<b>Looped Up</b>	Smart Loopback mode has been started using Remote Loopback.
<b>Smart Loopback</b>	Smart Loopback mode has been started manually.
<b>Busy</b>	No tests are running but the module is busy.
<b>Busy-BERT</b>	BERT testing is running.
<b>Busy-Traffic Gen</b>	Traffic Generation & Monitoring test is running.
<b>Busy-RFC 2544</b>	RFC 2544 test is running.
<b>Busy-Ping</b>	Ping test is running.
<b>Busy-Trace Route</b>	Trace Route test is running.

### Manual Selection

Press , select **Setup**, **Remote**, and the **Manual Selection** tab.

The **Manual Selection** tab offers a manual selection of the remote module. For the module to be auto-discovered, see the **Discovery** tab.

- **Target IP Address:** Enter the IP address (**IPv4 or IPv6 as per IP version selection**) of the target module. The target IP address will be copied into the Destination Address of all the tests and tools.

When the **IP Address** field is selected for editing, the **Latest IP's** button appears on the bottom of the screen. Press the corresponding function key to display the list of previously configured IP addresses. Select the desired IP address from the list, if available.

- **Quick Ping:** Select the **Quick Ping** button to test if the destination IP address can be reached. A message will be returned to indicate if the ping attempt was **Successful** or **Failed**.
- **Status:** The state of the target module can be one of the following: **Not Responding**, **Looping Up**, **Looping Down**, **Connecting**, **Disconnecting** or any of the status listed in the table on page 47.
- **Refresh Status:** Select **Refresh Status** to refresh the status of the specified target module periodically.

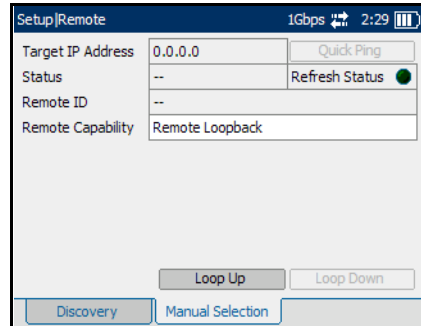

- **Remote ID:** The ID for the target module.
- **Remote Capability:** Select the Remote Capability. Choices are **Remote Loopback** and **DTS RFC 2544**. The default setting is **Remote Loopback**.

If **Remote Loopback** is selected, it will discover the module supporting the Remote Loopback feature.

If **DTS RFC 2544** is selected, it will discover the module supporting the DTS RFC 2544 feature.

## Setup

### Remote Selection

---

**To put the remote module into Smart Loopback or DTS RFC 2544 mode:**

- 1.** Select the **Remote Capability** as **Remote Loopback** or **DTS RFC 2544**.
- 2.** Select the **Loop Up** or **Connect** button to respectively enable the Smart Loopback or start the DTS RFC 2544 mode on the target module. An icon will be displayed in the title bar if the operation is successful.
- 3.** For Remote Loopback, any test/tool can be started at this time.  
For DTS RFC 2544, only the RFC 2544, Ping and Trace Route tests/tools can be started.
- 4.** Select the **Loop Down** or **Disconnect** button to respectively disable the **Smart Loopback** or **DTS RFC 2544** mode from the target module. Loop down or Disconnect is possible only following a successful loop up or disconnect process on a selected target module.

**Note:** *Even if a remote module is busy, it can still be overtaken by the **Loop Up** or **Connect** command.*

## Module

Press , select **Setup**, and the **Module** tab.

The **Module** page allows configuration of the following parameters:

- **Module ID:** The **Module ID** is used to easily identify the unit when auto-discovered in a network. Up to 16 alpha-numeric characters are supported.
- **Default Configuration:** Select the **Restore** button to restore the default settings of the module.
- **Restore Default at Start-Up:** Enable or disable the module's configuration to be restored upon start-up. If enabled, the user will be prompted at start-up if the default settings should be restored.

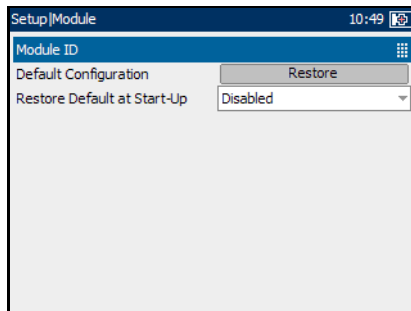

## Save & Load Config

The **Save and Load Config** menu allows to save the complete unit configuration and load them whenever required. It allows to save multiple test configurations into one file, or to load multiple tests with only one load operation. The Save and Load menu allows importing the files from external memory (USB Key) to Internal Flash Memory as well as exporting files from Internal Flash Memory to external memory (USB Key). The save, load, import, and export functions are displayed on Save & Load page when a new configuration file is created or an existing file is selected from the file list.

- **Media Selector:** Allows the selection of either the **Internal Flash Memory** or **USB key** to save or load the configuration file. USB key is available only when there is one connected to the AXS-200/850. The default value is **Internal Flash Memory**.

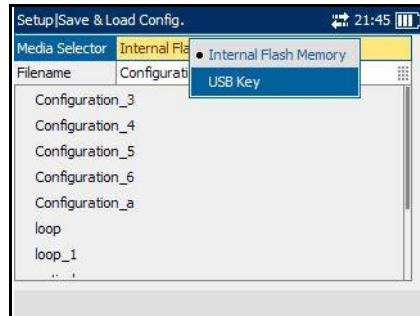

- **Filename:** Enter the name of the file in the **Filename** editor to save the new test configuration or overwrite an existing configuration file by selecting the name of the file from the file list that appears below the **Filename** editor.

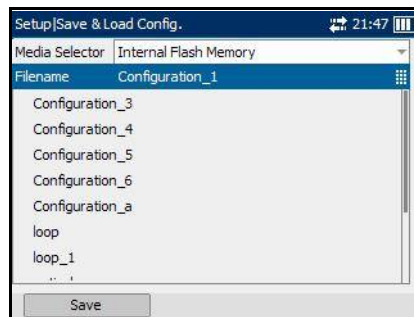

Save, Load, Import, and Export functions are displayed on the screen when an existing configuration file is selected from the file list.

These function are explained below:

## Save Function

The main aim of the save function is to store the complete unit configuration to a file on either **Internal Flash Memory** or **USB Key**.

- Press **Save** to save new configuration file or overwrite an already existing file.

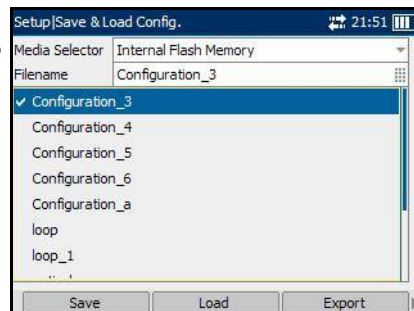

## Load Function

The main aim of the load function is to load previously saved test configuration file from either **Internal Flash Memory** or **USB Key**.

- Press **Load** to load up the selected configuration file from the file list.

## Import Function

The main aim of the import function is to copy the multiple files from the **USB Key** to the **Internal Flash Memory**.

- Press **Import** to import a single file from Internal Flash Memory to USB Key. This function tab is displayed only when Internal Flash Memory is selected as **Media Selector**.

## Export Function

The main aim of the export function is to copy multiple files from the **Internal Flash Memory** to the **USB Key**.

- Press **Export** to export a single file from USB Key to Internal Flash Memory at a time. This function tab is displayed only when USB Key is selected as **Media Selector**.

## Delete Function

The main aim of the delete function is to delete the selected files from the **Internal Flash Memory** or the **USB Key**.

- Press **Delete** to delete single configuration file or multiple configuration files from the file list.

## Sel/Unsel Function

The main aim of the Sel/Unsel function is to select or unselect the configuration file from the file list.

- Press **Sel/Unsel** to select or unselect the configuration file in the list box. The configuration file can even be selected by pressing **✓** key present on the platform.



## Sel/Unsel All Function

The main aim of the Sel/Unsel All function is to select or unselect all configuration files in the file list.

- Press **Sel/Unsel All** to select or unselect all configuration files in the list box. The configuration file can even be selected by pressing **✓** key present on the platform.

**Note:** *Configuration file has a backward compatibility (One year or three service packs).*

**Note:** *Possible incompatible load generates errors while loading a configuration file.*



## 8 RFC 2544

The AXS-200/850 allows performance testing as per RFC 2544, including Throughput, Back-to-Back, Frame Loss and Latency subtests.

The RFC 2544 test has to be executed in conjunction with a remote module. The remote module can be either in loopback configuration for unidirectional testing or in the Dual Test Set RFC 2544 mode for bidirectional testing.

The Dual Test Set RFC 2544 allows to measure RFC 2544 conformity where the downstream characteristics are different from the upstream. The Dual Test Set RFC 2544 adds the capability to the basic RFC 2544 test to perform one way Throughput, Frame Loss, and Back to Back subtests. A test stream is transmitted from the local module to the remote module, and from the remote module to the local module. Results of both directions are consolidated on the local module.

The **RFC 2544** menu offers the following structure:

Submenu	Tab	Page
Configuration	<i>Global Configuration</i>	58
	<i>Stream Configuration</i>	62
	<i>Throughput Configuration</i>	66
	<i>Back-to-Back Configuration</i>	69
	<i>Frame Loss Configuration</i>	71
	<i>Latency Configuration</i>	73
Results	<i>Summary Results</i>	75
	<i>Throughput Results</i>	82
	<i>Back-to-Back Results</i>	84
	<i>Frame Loss Results</i>	86
	<i>Latency Results</i>	88
	<i>Graph</i>	90
	<i>Alarms/Errors</i>	91

# Global Configuration

Press , select **RFC 2544, Configuration**, and the **Global** tab.

- **Unit:** Select the unit in Mbps or %. The default setting is **Mbps**.
- **Frame Size (Bytes):** Select **RFC 2544** or **User Defined**. The default value is **RFC 2544**.

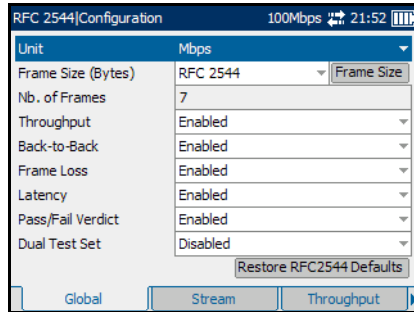

- **Nb. of Frames:** **Nb. of Frames** is only available when **User Defined** is selected. Select number of frames from the **Nb. of Frames** list. The default value is **7**.

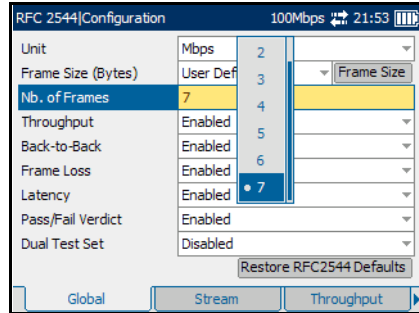

- **Frame Size:** Select the **Frame Size** button and the pop up menu will be displayed as shown in the figure. For **User Defined**, enter the value of the frame sizes.

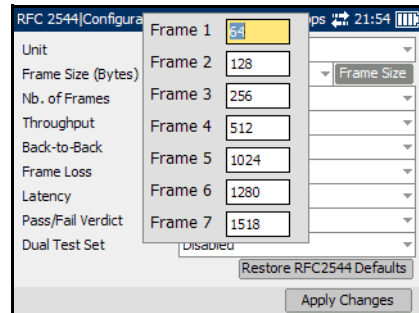

If **RFC 2544** is selected, the following frame sizes are used for IPv4 version:

VLAN Configuration	Frame 1 (Bytes)	Frame 2 (Bytes)	Frame 3 (Bytes)	Frame 4 (Bytes)	Frame 5 (Bytes)	Frame 6 (Bytes)	Frame 7 (Bytes)
No VLAN	64	128	256	512	1024	1280	1518
One VLAN	68	128	256	512	1024	1280	1518
Two VLAN	72	128	256	512	1024	1280	1518

If **RFC 2544** is selected, the following frame sizes are used for IPv6 version:

VLAN Configuration	Frame 1 (Bytes)	Frame 2 (Bytes)	Frame 3 (Bytes)	Frame 4 (Bytes)	Frame 5 (Bytes)	Frame 6 (Bytes)	Frame 7 (Bytes)
No VLAN	70	128	256	512	1024	1280	1518
One VLAN	74	128	256	512	1024	1280	1518
Two VLAN	78	128	256	512	1024	1280	1518

**Note:** *The frame size is not configurable if RFC 2544 is selected. It allows to see the standard frame sizes in read-only mode.*

If **User Defined** is selected, the following frame sizes are available for IPv4 version:

Frame Type	VLAN Configuration	Frame size (Bytes)
User Defined	No VLAN	64 to 9600
	One VLAN	68 to 9600
	Two VLAN	72 to 9600

If **User Defined** is selected, the following frame sizes are available for IPv6 version:

<b>Frame Type</b>	<b>VLAN Configuration</b>	<b>Frame size (Bytes)</b>
User Defined	No VLAN	70 to 9600
	One VLAN	74 to 9600
	Two VLAN	78 to 9600

If **User Defined** is selected, use Up or Down arrow, or  button to traverse the fields and enter the Frame Size. Press the **Apply Changes** button to apply changes.

- **Throughput:** Enable or disable **Throughput** subtest.
- **Back-to-Back:** Enable or disable **Back-to-Back** subtest.
- **Frame Loss:** Enable or disable **Frame Loss** subtest.
- **Latency:** Enable or disable **Latency** subtest.

**Note:** *All subtests are enabled by default.*

- **Pass/Fail Verdict:** Enable or disable the **Pass/Fail Verdict**. Choices are **Enabled** and **Disabled**. The default setting is **Enabled**. If enabled, the **Pass/Fail Verdict** displays the Pass/Fail verdict on the result pages.

- **Dual Test Set:** Set the mode for the Dual Test Set. Choices are **Remote** and **Local**. Select either **Remote** or **Local** to enable Dual Test Set or **Disabled** to disable it. The default setting is **Disabled**.

**Disabled:** Performs RFC 2544 test with a remote module in loopback configuration.

**Local:** Performs DTS RFC 2544 test (bidirectional) and acts as the local module.

**Remote:** Performs DTS RFC 2544 test (bidirectional) and acts as the DTS RFC 2544 remote module.

- **Restore RFC 2544 Defaults:** Select **Restore RFC 2544 Defaults** to revert the configured values to the default values.

## Stream Configuration

Press , select **RFC 2544**, **Configuration**, and the **Stream** tab.

- **Destination MAC Address:** Enter the **MAC Address** if the **Resolve MAC Address** is disabled. The default setting is: **FE:FE:FE:FE:FE:FE**.

When the **Destination MAC Address** field is selected for editing, the **Latest MAC's** button appears on the bottom left corner of the screen. Press the corresponding function key to display the list of previously configured MAC addresses. Select the desired MAC address from the list, if any.

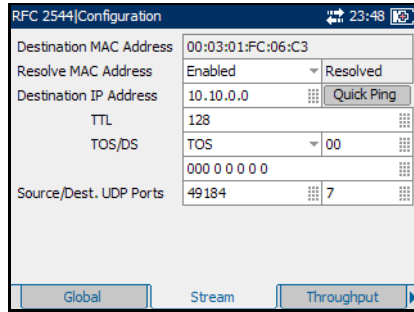

- **Resolve MAC Address:** Enable or disable **Resolve MAC Address**.The default setting is **Disabled**.

When enabled, an ARP request is sent to the network to retrieve the MAC Address corresponding to the selected IP address for IPv4.

When enabled, a Neighbor Solicitation request is sent to the network to retrieve the MAC Address corresponding to the selected IP address for IPv6.

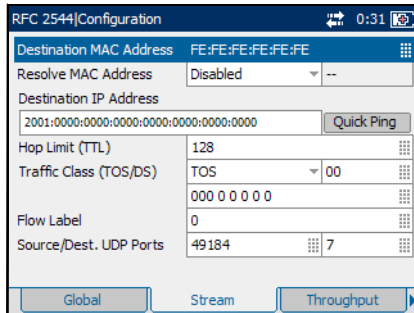

If not resolved after 3 seconds, the MAC address value becomes "--" and the stream is disabled. In the next status field, a **Failed** status will appear. The status field also displays "--" when the **Resolve MAC Address** is disabled, and other status includes **Failed**, **Not Resolved**, and **Resolved**. The default status is "--".



- **Destination IP Address:** Enter the destination IP address.

The default setting for IPv4 is **10.10.0.0**, or is set automatically to the IP address of the target module that is looped up from **Remote Loopback** mode.

The default setting for IPv6 is **2001:0000:0000:0000:0000:0000:0000:0000**, or is set automatically to the IP address of the target module that is looped up from **Remote Loopback** mode.

The accepted range for IPv4 is **0.0.0.0** to **255.255.255.255**. The default value is **0.0.0.0**.

The **IPv6 Address** can either be the **Link-Local IPv6 Address** or the **Global IPv6 Address**.

The acceptable range for IPv6 is from **000:0000:0000:0000:0000:0000:0000:0001** to **FFFF:FFFF:FFFF:FFFF:FFFF:FFFF:FFFF:FFFF**.

When the **IP Address** field is selected for editing, the **Latest IP's** button appears on the bottom of the screen. Press the corresponding function key to display the list of previously configured IP addresses. Select the desired IP address from the list, if any.

- **Quick Ping:** Select the **Quick Ping** button to test if the destination IP address can be reached. A message will be returned to indicate if the ping attempt was **Successful** or **Failed**.

**Note:** *When a remote module is looped up, the **Destination IP Address** is not configurable (read only). When a remote module is looped down, the **Destination IP Address** reverts to the previously configured value.*

- **TTL for IPv4 and Hop Limit (TTL) for IPv6**

Enter the Time to Live (**TTL**) value. The accepted range is from **0** to **255** with a default of **128**.

- **TOS/DS** for IPv4 and **Traffic Class (TOS/DS)** for IPv6  
 Select Type of Service (**TOS**) or Differentiated Services (**DS**).

**Note:** *It is possible to configure the **TOS/DS** parameter using either the hexadecimal code (00 to FF) or **TOS/DS** using binary code.*

- If **TOS** is selected, go to the next field to enter the hexadecimal code **00** to **FF** or go to the field underneath to enter the binary code.



The possible values are shown as follows:

Parameter	Value
Precedence	000 (Routine), 001 (Priority), 010 (Immediate), 011 (Flash), 100 (Flash Override), 101 (CRITIC/ECP), 110 (Internet Control), 111 (Network Control) Default: 000 (Routine)
Delay	Normal / Low (0/1) Default: Normal
Throughput	Normal / High (0/1) Default: Normal
Reliability	Normal / High (0/1) Default: Normal
Monetary Cost	Normal / Low (0/1) Default: Normal
Reserved bit	0 or 1 Default: 0

- If **DS** is selected, go to the next field to enter the hexadecimal code **00** to **FF** or go to the field underneath to enter the binary code.

The possible values are shown as follows:

Parameter	Value
DSCP Codepoints	000000 (CS0), 001000 (CS1), 010000 (CS2), 011000 (CS3), 100000 (CS4), 101000 (CS5), 110000 (CS6), 111000 (CS7), 001010 (AF11), 001100 (AF12), 001110 (AF13), 010010 (AF21), 10100 (AF22), 010110 (AF23), 011010 (AF31), 011100 (AF32), 011110 (AF33), 100010 (AF41), 100100 (AF42), 100110 (AF43), 101110 (EF) Default: 000000 (CS0)
ECN	00 (Not-ECT), 01 (ECT-1), 10 (ECT 0), 11 (CE) Default: 00 (Not-ECT)

- **Flow Label** (For IPv6 only): Enter the **Flow Label** value. The acceptable range is from **0** to **1048575**. The default value is **0**.
- **Source/ Dist. UDP Ports**: Enter the **Source UDP Port**. The accepted range is from **0** to **65535**. The default value is **49184**. **Destination UDP Port**: Enter the **Destination UDP Port**. The accepted range is from **0** to **65535**. The default value is **7**.

## Throughput Configuration

The objective of this test is to find the throughput of the device under test for which there is no frame loss. Starting at the specified maximum rate (**Maximum Rate**), the rate converges towards the highest throughput without frame loss with the test having a predefined duration (**Test Time**). The search is done with a halving/doubling method until a final value is reached. The throughput measurement is validated the number of times specified (**Nb. of Validations**). The **Accuracy (Frames)** settings specify how precise that result must be. The test is performed for each defined frame size.

Press , select **RFC 2544, Configuration**, and the **Throughput** tab.

**Note:** *This page is not available when the **Dual Test Set** parameter is set to **Remote** in Global Configuration on page 58.*

**Note:** *Throughput must be enabled from Global Configuration on page 58.*

- **Test Time (MM:SS):** Enter the **Test Time** value in seconds. Possible values are **1** second to **30** minutes. The default setting is **1** second (00:01).
- **Accuracy:** Enter the **Accuracy** value as a percentage of the line rate or in Mbps. The accuracy is not based on the configured **Maximum Rate** but on the Ethernet line rate.

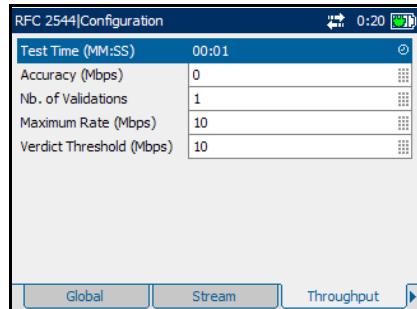

The accepted values are as follows:

Interface Speed	Accuracy	
	%	Mbps
10 Mbps	0.1 - 10, default = 1	0.01 - 1, default = 0.1
100 Mbps		0.1 - 10, default = 1.0
1000 Mbps		1 - 100, default = 10

- **Nb. of Validations:** Select the number of times the result should be validated. Choices are **1** to **50** times. The default setting is **1** time.
- **Maximum Rate:** Select the **Maximum Rate** so that the throughput test should begin with, in terms of a percentage of the line rate or in Mbps.

The accepted values are as follows:

Interface Speed	Maximum Rate	
	%	Mbps
10 Mbps	0.001 - 100.000, default = 100.000	0.001 - 10.000, default = 10.000
100 Mbps		0.001 - 100.000, default = 100.000
1000 Mbps		0.001 - 1000.000, default = 1000.000

- **Verdict Threshold:** Select the threshold value in percentage of the line rate or in Mbps. If the determined throughput value is greater or equal to the threshold value, the test is declared as **PASS**. If the determined throughput value for a specific frame size is lower than the threshold value, the test is declared as **FAIL**. This value applies to all the 7 RFC 2544 frame sizes or for the 7 user-defined frame sizes.

The accepted values are as follows:

## RFC 2544

### Throughput Configuration

---

Interface Speed	Verdict Threshold	
	%	Mbps
10 Mbps	0.000 - 100.000, default = 100.000	0.000 - 10.000, default = 10.000
100 Mbps		0.000 - 100.000, default = 100.000
1000 Mbps		0.000 - 1000.000, default = 1000.000

**Note:** When the **Dual Test Set** parameter is set to **Local** in Global Configuration on page 58, the **Maximum Rate** and **Verdict Threshold** are configured independently for each direction: **Local-to-Remote** and **Remote-to-Local**.

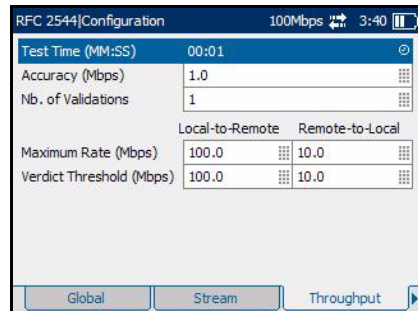

## Back-to-Back Configuration

The objective of this test is to find the maximum number of frames that can be sent at maximum throughput without frame loss. A burst of frames (**Max. Burst Duration**) is sent with minimum inter-frame gaps to the device under test and the number of forwarded frames is counted. If the count of transmitted frames is equal to the number of forwarded frames, the length of the burst is increased and the test is rerun. If the number of forwarded frames is less than the number of transmitted frames, the length of the burst is reduced and the test is rerun. The back-to-back value is the number of frames in the longest burst that the device under test (DUT) can handle without the loss of any frames. The test performs the number of defined trials (**Number of Trials**). The **Accuracy (Frames)** settings specify how precise that result must be. The test is performed for each defined frame size.

Press , select **RFC 2544, Configuration**, and the **Back-to-Back** tab.

**Note:** This page is not available when the **Dual Test Set** parameter is set to **Remote** in Global Configuration on page 58.

**Note:** **Back-to-Back** must be enabled from Global Configuration on page 58.

➤ **Max. Burst Duration:** Enter the **Max. Burst Duration** in seconds. Choices are **1** to **5** seconds. The default setting is **2** seconds.

➤ **Accuracy (Frames):** Enter the **Accuracy** measurement value in frames. Choices are **1** to **50** frames. The default setting is **1**.

➤ **Number of Trials:** Select the number of trials to average. Choices are **1** to **100** trials. The default setting is **1** trial.

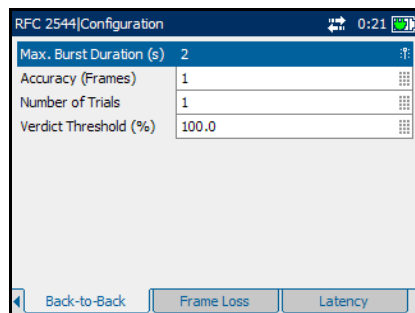

## RFC 2544

### Back-to-Back Configuration

---

- **Verdict Threshold:** Set the threshold value in percentage of frames per burst for the test. If the determined back-to-back value is greater or equal to the threshold value, the test is declared as **PASS**. If the determined back-to-back value for a specific frame size is lower than the threshold value, the test is declared as **FAIL**. This value should range from **0.1%** to **100%** and applies to all the 7 RFC 2544 frame sizes or for the 7 user-defined frame sizes.

**Note:** When the **Dual Test Set** parameter is set to **Local** in Global Configuration on page 58, the **Verdict Threshold** is configured independently for each direction: **Local-to-Remote** and **Remote-to-Local**.

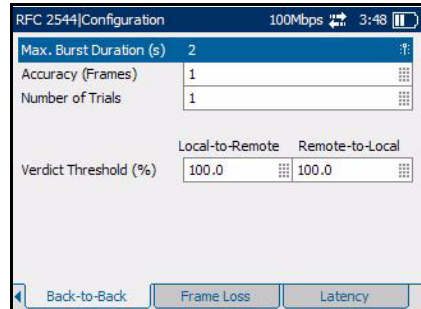



## Frame Loss Configuration

The objective of this test is to find the percentage of frames that are lost due to lack of resources. Starting at the specified maximum rate (**Maximum Rate**), the test is performed for a specific frame size and for the specified duration (**Test Time**). The test is repeated by decreasing the throughput by 10%, then the test is repeated again until there are two successive trials in which no frames are lost. The test is performed for each defined frame size.

Press , select **RFC 2544, Configuration**, and the **Frame Loss** tab.

**Note:** This page is not available when the **Dual Test Set** parameter is set to **Remote** in Global Configuration on page 58.

**Note:** **Frame Loss** must be enabled from Global Configuration on page 58.

- **Test Time (MM:SS):** Select the **Test Time** value. Possible values are **1** second to **30** minutes. The default setting is **1** second (00:01).

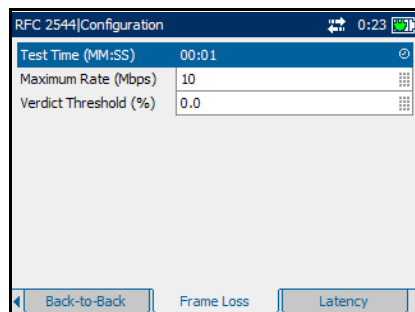

- **Maximum Rate:** Select the **Maximum Rate** for the test, in terms of a percentage of the line rate or in Mbps.

The accepted values are as follows:

Interface Speed	Maximum Rate	
	%	Mbps
10 Mbps	0.1 - 100, default = 100	0.01 - 10, default = 10
100 Mbps		0.1 - 100, default = 100
1000 Mbps		1 - 1000, default = 1000

- **Verdict Threshold (%)**: Set the threshold value in percentage of frame loss. If the determined frame loss value is lower or equal to the threshold value, the test is declared as **PASS**. If the determined frame loss value for a specific frame size is greater than the threshold value, the test is declared as **FAIL**. This value should range from **0.1 %** to **100 %** and applies to all the 7 RFC 2544 frame sizes or for the 7 user-defined frame sizes.

**Note:** When the **Dual Test Set** parameter is set to **Local** in Global Configuration on page 58, the **Maximum Rate** and **Verdict Threshold** are configured independently for each direction: **Local-to-Remote** and **Remote-to-Local**.

**Note:** **Verdict Threshold** parameter will be *editable only when the RFC 2544 Pass/Fail Verdict parameter is **Enabled** in Global Configuration on page 58.*

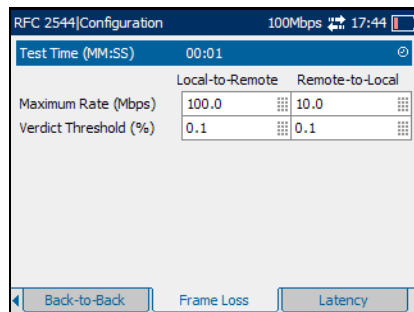

## Latency Configuration

The objective of this test is to find the time required for the sent frame to go through the device under test and return to the AXS-200/850 module. Starting by sending a stream of frames for the predefined duration (**Test Time**) and throughput (**Maximum Rate**) at a particular frame size, an identifying dependent tag is included in one frame. The time at which this frame is transmitted is recorded (**timestamp A**). When the tagged frames come back, the time is recorded again (**timestamp B**) and the Latency result is: **timestamp B - timestamp A**. The test is repeated for the defined number of times (**Number of Trials**) and the average result is calculated. The test is performed for each defined frame size.

Press , select **RFC 2544, Configuration**, and the **Latency** tab.

**Note:** *This page is not available when the **Dual Test Set** parameter is set to **Remote** in Global Configuration on page 58.*

**Note:** *Latency must be enabled from Global Configuration on page 58.*

- **Test Time (MM:SS):** Select the test time value. Choices are **1** second to **2** minutes. The default setting is **1** second (00:01).
- **Number of Trials:** Select the number of trials to average. Choices are from **1** to **50** trials. The default setting is **1** trial.

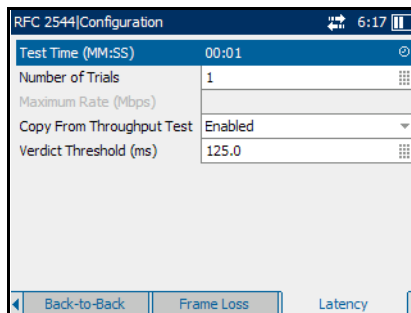

- **Maximum Rate:** Enter the **Maximum Rate** as a percentage of the line rate or in Mbps. The accepted values are as follows:

Interface Speed	Maximum Rate	
	%	Mbps
10 Mbps	0.1 - 100, default = 100	0.01 - 10, default = 10
100 Mbps		0.1 - 100, default = 100
1000 Mbps		1 - 1000, default = 1000

- **Copy from Throughput Test:** Enable to get values from the Throughput subtest results. This setting is enabled by default. When the **Copy from Throughput Test** parameter is enabled, the Throughput subtest results will be used as the **Maximum Rate** individually for each corresponding frame size.
- **Verdict Threshold:** Set the threshold value as the maximum delay in ms. If the determined latency value is less than or equal to the threshold value, the test is declared as **PASS**. If the determined latency value is higher than the threshold value, the test is declared as **FAIL**. The accepted range is **0.015** to **8000** ms with a default value of **125** ms, and this value applies to all the 7 RFC 2544 frame sizes or for the 7 user-defined frame sizes.

## Summary Results

When the RFC 2544 test is run, a summary of the results as well as the detailed results per subtest is collected. The **Summary** results page displays the progress of each subtest. The progress per subtest is monitored and updated on a per second basis. Once the subtest is completed, its Pass/Fail result is displayed. The top half of the **Summary** results page is static and is common for all subtests, however the bottom half is dynamic and changes with each subtest.



### IMPORTANT

Test results/statistics are cleared when changing test or tool selection. It is highly advised to generate and save the report once the current test is completed. See *Report Generation* on page 79 to generate and save a report file.

Press , select **RFC 2544, Results**, and the **Summary** tab.

The progress **Status** of each subtest is indicated as follows:

- “--” (test has not started)
- **In Progress**
- **Completed**
- **Aborted**
- **Aborted – No remote connection**

RFC 2544 Results		Start Time
Throughput	In Progress	19:51
Back-to-Back	--	Duration
Frame Loss	--	0d 00:01:12
Latency	--	
TX Frames	23496	RX Frames
Val. #	1	
256	100.0 Mbps	
512	Testing	
		Report
Summary		Throughput
		Back-to-Back

**Note:** When the **Dual Test Set** parameter is set to **Remote** in Global Configuration on page 58, only **Start Time** and **Duration** will be displayed for the remote module.

- **Aborted – Invalid Configuration**
- **Aborted – Loss of remote connection**

**Note:** *This status will appear only when the Dual Test Set Connection is lost during the DTS RFC 2544 test.*

Once the RFC 2544 subtests are completed or stopped, the **Pass/Fail** verdict is displayed for each subtest, when enabled. To set the **Pass/Fail** verdict, see **Pass/Fail Verdict** on the Global Configuration page 60.

- **Start Time:** The time when the RFC 2544 test was started.
- **Duration:** The length of time from when the RFC 2544 test was started, until when the test was completed.
- **Report:** Select the **Report** button to generate the report file of the results and statistics. See *Report Generation* on page 79 to generate and save a report file.

**Note:** *While a subtest is in progress, the status and results are displayed on the bottom half of the page in real time, and are retained in the detailed results tab of each subtest. These values do not appear if subtests are not in progress.*

The current test **Frame Size** status and the previous tested **Frame Size** results are listed. The results are described as follows:

- **Val. #:** Available only for the Throughput subtest. This value indicates the current validation number in progress.
- **Trial #:** Available only for Back-to-Back and Latency subtests. This value indicates the current trial number in progress.

- **Step:** Available only for the Frame Loss subtest. This value indicates the 10 % interval of throughput decreased. The subtest is repeated at each decreased throughput. The subtest is stopped for a frame size when there are 2 successive trials in which no frames are lost or when the throughput has reached 0 % of the full media speed.
- **TX Frames:** Available only for Throughput, Frame Loss and Back-to-Back subtests. The count of transmitted frames for the iteration in progress. This value is kept throughout the iteration until the next iteration begins. When the next iteration begins, the value displayed will momentarily be “0” while data is collected.
- **RX Frames:** The count of received frames for the iteration in progress after the test frames have been transmitted and a pause of 2 seconds has passed. This value is kept throughout the iteration until the next iteration begins. When the next iteration starts, the value displayed will momentarily be “0” while data is collected.

**Note:** For *DTS RFC 2544*, the results for the *Local-to-Remote* direction are obtained between test iterations.

The possible subtest statuses that reflect the test phase or results of the currently tested frame size are listed as follows:

#### Test Phase

- **Initializing**
- **Learning:** Sending learning frames.
- **Testing:** Sending test frames.
- **Waiting**

RFC 2544 Results		100Mbps	4:47
Throughput	In Progress	Start Time	4:46
Back-to-Back	--	Duration	0d 00:00:54
Frame Loss	--		
Latency	--		
Val. #	3		
	Local-to-Remote	Remote-to-Local	
TX Frames	0	0	
RX Frames	0	0	
64	Waiting	Waiting	
Report			
Summary		Throughput	Back-to-Back

#### **Results**

- **Not measurable:** Latency not measurable.
- **Test completed**
- **Aborted:** Aborted by user.
- **Link is down**
- **MAC not resolved:** MAC address is not resolved.



## Report Generation

Reports can be generated for the test and tools results. The report button is available on the **BERT**, **Traffic Generation & Monitoring**, **RFC 2544** summary tabs, and **Ping**, **Trace Route**, and **Cable Test** result tabs.

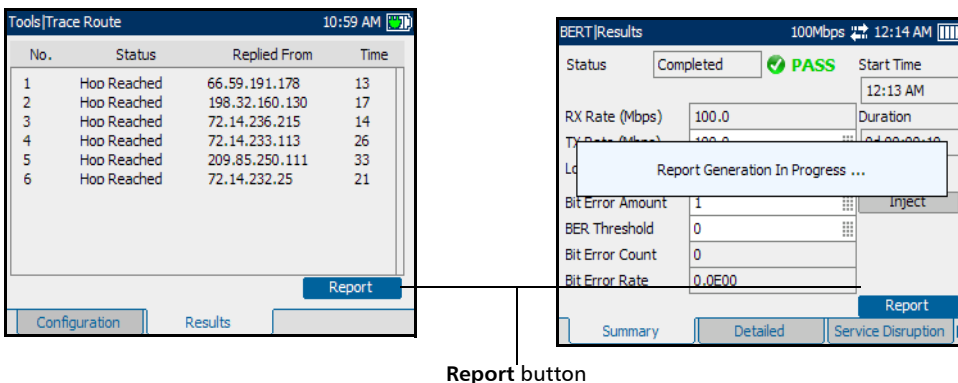

### To generate a report:

1. Select the **Report** button from the **Results** page, if not already selected, and press the **✓** button.
2. The report is being generated and is displayed on screen.
3. Press the **✓** button to select the report section, and use the up and down arrows to scroll through the report.
4. Press the **↶** button to have access to the function keys.
5. Press **Bottom** to move to the bottom of the page.

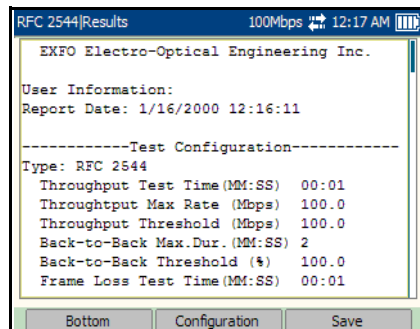

**Note:** When the bottom of the page is displayed, **Bottom** changes to **Top**.

6. Press the function key under **Configuration** on the bottom of the screen to configure the titles and headings of the report.

7. Customize the following fields. Refer to *Report Configuration* on page 207 for information on the parameters:

- **Report Header**
- **Report Title**
- **User Information**
- **File Name**

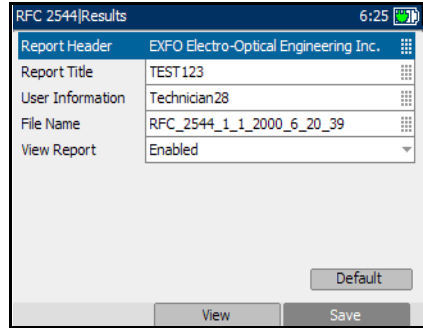

- **View Report:** If enabled, the report page will automatically display after a report is generated. If disabled, the **Report Configuration** page will be displayed after a report is generated.

8. Select **Default** to revert all parameters back to the default settings.

9. Select **View** to display the changes on the report file.

10. Select **Save** to save the report file.

The report will be saved on the selected media. Refer to *Media Selector* on page 207.

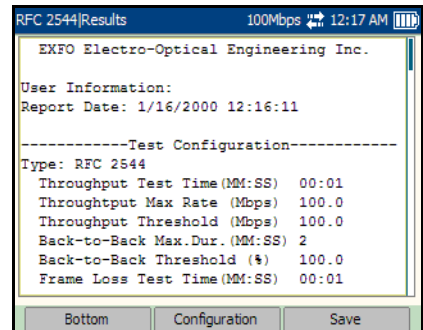

11. A message is displayed to indicate that the report file is successfully saved.
12. Select the **OK** button by pressing the function key underneath it. Use the navigation arrows to scroll up and down the page to view the report.
13. To exit the report page, press the  button.

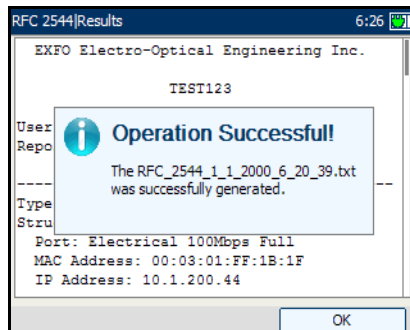

## Throughput Results

Press , select **RFC 2544, Results**, and the **Throughput** tab.

- **Status:** Displays the test status as “...”, **In Progress**, **Completed**, or **Aborted**. Once the Throughput test is completed or stopped, the **Pass/Fail** verdict is displayed, when enabled.
- **Max. Rate:** Displays the configured value of maximum rate in **Mbps** or **%**.

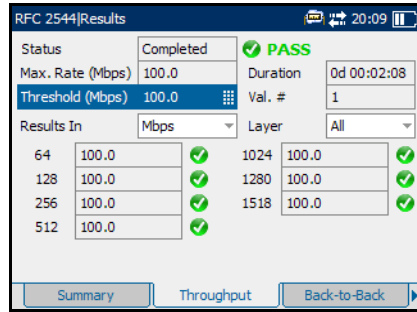

**Note:** *Max. Rate* will not be displayed when the **Dual Test Set** parameter is set to **Local** in Global Configuration on page 58.

- **Duration:** Displays subtest duration in D HH:MM:SS format.
- **Val. #:** Displays the configured number of validations.
- **Threshold:** The throughput Pass/Fail threshold can be configured at all times in Mbps or %. When the value is changed, the verdict of the subtest gets re-evaluated and updated.
- **Results In:** The throughput value is expressed in **Mbps** by default. The user can also specify the values to be displayed as a percentage of the line rate or in Frames per Second (**fps**).

- **Layer:** Select the layer for determining the throughput results layer to display. Choices are **All**, **Ethernet** and **IP**. The default setting is **All**.
  - **All:** Considers all layers to display the **Throughput Results** and represents the Ethernet line utilization.
  - **Ethernet:** Displays the **Throughput Results** calculated at the Ethernet layer.
  - **IP:** Displays the **Throughput Results** calculated at the IP layer.

The throughput results displayed on the bottom half of the page are displayed for the selected frame size distribution.

**Note:** When the **Dual Test Set** parameter is set to **Local** in Global Configuration on page 58, the Throughput subtest results are presented independently for each direction: **Local-to-Remote** and **Remote-to-Local**.

**Note:** For **DTS RFC 2544**, the results for the **Local-to-Remote** direction are obtained between test iterations.

**Note:** The **Pass/Fail** verdict is displayed for each frame size. To set the **Pass/Fail** verdict, refer to the **RFC 2544 Global Configuration** tab. See **Pass/Fail Verdict** on page 60.

RFC 2544 Results		100Mbps	22:22
Status	--	Duration	--
Val. #	--	Results In	Mbps
		Layer	All
		Local-to-Remote	Remote-to-Local
Threshold (Mbps)	100.0	10.0	
64	--	--	
128	--	--	
256	--	--	
512	--	--	
1024	--	--	
1280	--	--	
1518	--	--	

Summary    Throughput    Back-to-Back

✔ = PASS

✘ = FAIL

## Back-to-Back Results

Press , select **RFC 2544, Results**, and the **Back-to-Back** tab.

- **Status:** Displays the test status as “--”, **In Progress**, **Completed**, or **Aborted**. Once the Back-to-Back test is completed or stopped, the **Pass/Fail** verdict is displayed, when enabled.
- **Max. Burst:** Displays the configured value of maximum burst in seconds.

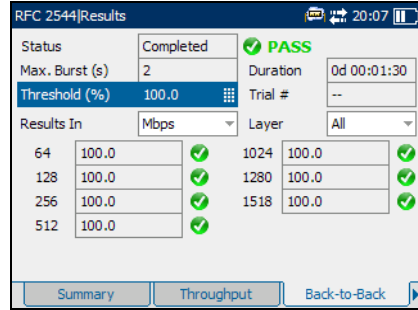

**Note:** *Max. Burst* will be displayed only when the **Dual Test Set** parameter is set to **Disabled** in Global Configuration on page 58.

- **Duration:** Displays test duration in D HH:MM:SS format.
- **Threshold:** The back-to-back Pass/Fail threshold can be configured in percentage at all times. When the value is changed, the verdict of the subtest gets re-evaluated and updated.
- **Trial #:** Displays the number of the current trial.
- **Results In:** The back-to-back value is expressed in **Mbps** by default. The user can also specify the values to be displayed as a percentage of the maximum number of frames in a burst as specified by the burst duration or in Frames per Burst (**Frames/burst**). Back-to-back results are displayed for all frame sizes.

- **Layer:** Select the layer for determining the back-to-back results layer to display. Choices are **All**, **Ethernet** and **IP**. The default setting is **All**.
  - **All:** Considers all layers to display the **Back-to-Back Results** and represents the Ethernet line utilization.
  - **Ethernet:** Displays the **Back-to-Back Results** calculated at the Ethernet layer.
  - **IP:** Displays the **Back-to-Back Results** calculated at the IP layer.

The back-to-back results displayed on the bottom half of the page are displayed for the selected frame size distribution.

**Note:** When the **Dual Test Set** parameter is set to **Local** in Global Configuration on page 58, the Back-to-Back subtest results are presented independently for each direction: **Local-to-Remote** and **Remote-to-Local**.

**Note:** For **DTS RFC 2544**, the results for the **Local-to-Remote** direction are obtained between test iterations.

**Note:** The **Pass/Fail** verdict is displayed for each frame size. To set the **Pass/Fail** verdict, refer to the **RFC 2544 Global Configuration** tab. See **Pass/Fail Verdict** on page 60.

RFC 2544 Results		100Mbps	22:23
Status	--	Duration	--
Trial #	--	Results In	Mbps
		Layer	All
		Local-to-Remote	Remote-to-Local
Threshold (%)	100.0	100.0	100.0
64	--	--	--
128	--	--	--
256	--	--	--
512	--	--	--
1024	--	--	--
1280	--	--	--
1518	--	--	--

✓ = PASS

✗ = FAIL

## Frame Loss Results

Press , select **RFC 2544, Results**, and the **Frame Loss** tab.

- **Status:** Displays the test status as “--”, **In Progress**, **Completed**, or **Aborted**. Once the Frame Loss test is completed or stopped, the **Pass/Fail** verdict is displayed, when enabled.
- **Max. Rate:** Displays the configured value of maximum rate in **Mbps** or **%**.

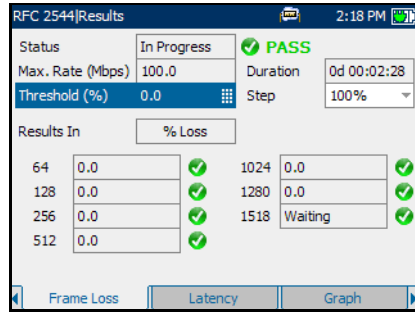

**Note:** *Max. Rate* will be displayed only when the **Dual Test Set** parameter is set to **Disabled** in Global Configuration on page 58.

- **Duration:** Displays the test duration in D HH:MM:SS format.
- **Threshold:** The frame loss Pass/Fail threshold can be configured in percentage at all times. When the value is changed, the verdict of the subtest gets re-evaluated and updated.

**Note:** *Threshold* will not be displayed when the **Dual Test Set** parameter is set to **Local** in Global Configuration on page 58.



- **Step:** Determines which step is displayed.
- **Results In:** The frame loss value is expressed in %.

The frame loss results displayed on the bottom half of the page are displayed for the selected frame size distribution.

**Note:** When the **Dual Test Set** parameter is set to **Local** in Global Configuration on page 58, the Frame Loss subtest results are presented independently for each direction: **Local-to-Remote** and **Remote-to-Local**.

**Note:** For **DTS RFC 2544**, the results for the **Local-to-Remote** direction are obtained between test iterations.

**Note:** The **Pass/Fail** verdict is displayed for each frame size. To set the **Pass/Fail** verdict, refer to the **RFC 2544 Global Configuration** tab. See **Pass/Fail Verdict** on page 60.

RFC 2544 Results		100Mbps	17:47
Status	--		
Results In	%		
Step (Mbps)	--		
	Local-to-Remote	Remote-to-Local	
Threshold (%)	0.1	0.1	
64	--	--	
128	--	--	
256	--	--	
512	--	--	
1024	--	--	
1280	--	--	
1518	--	--	

Navigation buttons: Frame Loss, Latency, Graph

✓ = PASS

✗ = FAIL

## Latency Results

Press , select **RFC 2544, Results**, and the **Latency** tab.

**Note:** This page is not available when the **Dual Test Set** parameter is set to **Remote** in Global Configuration on page 58

- **Status:** Displays the test status as “--”, **In Progress**, **Completed**, or **Aborted**. Once the Latency test is completed or stopped, the **Pass/Fail** verdict is displayed, when enabled.
- **Max. Rate:** Displays the configured value of maximum rate in Mbps or %.
- **Duration:** Displays subtest duration in D HH:MM:SS format.
- **Threshold:** The latency Pass/Fail threshold can be configured at all times in ms. When the value is changed, the verdict of the subtest gets re-evaluated and updated.
- **Trial #:** Displays the number of the current trial.
- **Mode:** The latency results can be expressed in either **Cut-Through** or **Store and Forward (S&F)** mode. The default setting is **Cut-Through**. **Cut-Through** (Bit Latency) allows the calculation of the propagation time of a bit and **S&F** (Frame Latency) allows the calculation of the propagation time of a frame.

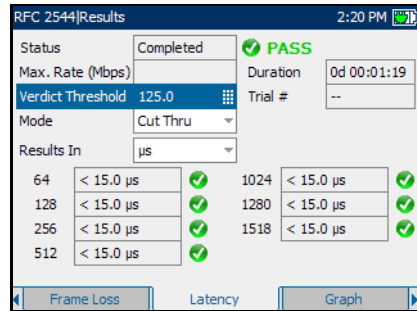



**Note:** **S&F** (Frame Latency) is not applicable when the **Dual Test Set** parameter is set to **Local**.

- **Results In:** The latency value is expressed in **ms** by default. The user can also specify the values to be displayed as **μs**.

The latency results displayed on the bottom half of the page are displayed for the selected frame size distribution.

**Note:** The **Pass/Fail** verdict is displayed for each frame size. To set the **Pass/Fail** verdict, refer to the **RFC 2544 Global Configuration** tab. See Pass/Fail Verdict on page 60.

 = PASS

 = FAIL

## Graph

Gives the graph showing the Throughput, Back-to-Back, Frame Loss, or Latency measurement.

Press , select **RFC 2544, Results**, and the **Graph** tab.

The X axis shows the frame sizes for **Throughput, Back-to-Back, Latency** or the **TX Rate** for **Frame Loss**. The Y axis shows the subtest results.

- **Test:** Select the test that has to be displayed from the upper portion of the tab. Choices are **Throughput, Back-to-Back, Frame Loss, and Latency**.
- **Frame Size (Bytes):** For **Frame Loss** subtest, select the **Frame Size** results to be displayed.

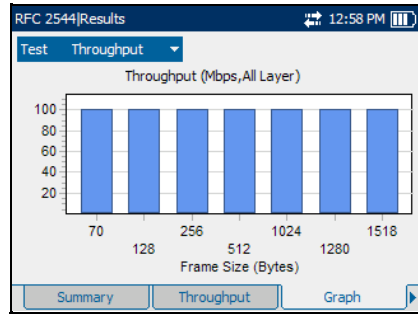

**Note:** When the **Dual Test Set** parameter is set to **Local** in Global Configuration on page 58, the results are presented independently for each direction: **Local-to-Remote** and **Remote-to-Local**.

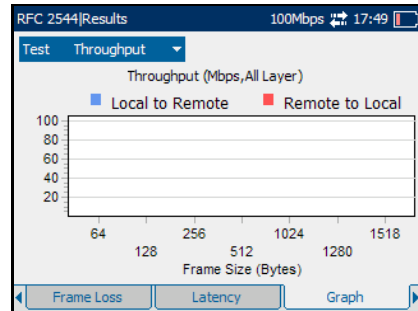

## Alarms/Errors









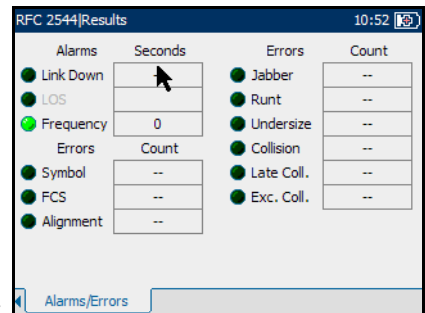



Press , select **RFC 2544, Results**, and the **Alarms/Errors** tab.

The Alarms/Errors page displays alarms and errors with green, red, or amber indicators. The error count and the amount of time in seconds that the alarm remained raised during test execution is also displayed. The description of each alarm and error is provided as follows:

### Alarms

- **Link Down:** Indicates that the Ethernet connection is down. The Ethernet connection is down when there is a local or a remote fault condition.
- **LOS:** Indicates a loss of signal on the optical port.
- **Frequency:** A frequency alarm is raised when the frequency offset of the receiving signal is over the standard limit ( $\pm 100$  ppm).



Alarms		Seconds	Errors		Count
	Link Down			Jabber	--
	LOS			Runt	--
	Frequency	0		Undersize	--
Errors		Count		Collision	--
	Symbol	--		Late Coll.	--
	FCS	--		Exc. Coll.	--
	Alignment	--			

**Note:** The total number of alarmed seconds for Link Down, LOS, and Frequency is recorded and displayed in the field next to the alarm name.

**Note:** Alarms/Errors are updated only during test execution.

The **Alarm** LEDs are described as follows:

<b>LED Label</b>	<b>Color</b>	<b>Meaning</b>
Link Down	Green	Link up.
	Red	Link down (Current).
	Amber	Link down was present (History).
	Black	Not applicable.
LOS (loss of signal)	Green	No LOS is present during test.
	Red	LOS alarm is present (Current).
	Amber	LOS was present (History).
	Black	Not applicable.
Frequency	Green	No frequency offset alarm is present during the test.
	Red	Frequency offset alarm is present (Current).
	Amber	Frequency offset alarm was present (History).
	Black	Not applicable.

## Errors

- **Symbol** (100/1000 Mbps): A Symbol Error is declared when an invalid code-group in the transmission code is detected.
- **FCS**: The number of received frames with an invalid FCS.
- **Alignment** (10/100 Mbps): Indicates the number of received frames without an integral number of octets in length.
- **Jabber**: The number of received frames larger than 1518 (no VLAN tag), 1522 (One VLAN tag), 1526 (Two VLAN tags), or 1530 (3 VLAN tags) bytes with an invalid FCS.
- **Runt**: The number of received frames that are smaller than 64 bytes with an invalid FCS.
- **Undersize**: The number of received frames smaller than 64 bytes with a valid FCS.

The following errors are only available with **Half Duplex** mode (only for electrical interface at speeds of 10 Mbps and 100 Mbps).

- **Collision**: Indicates the number of collisions on the link.
- **Late Coll.:** Indicates the number of collisions that have occurred after a 64 bytes transmission.
- **Exc. Coll.:** Indicates the number of frames that were sent 16 times unsuccessfully due to consecutive collisions.

The **Errors** LEDs are described as follows:

Color	Meaning
Green	No error.
Red	A test is running and there is at least one error present (Current).
Amber	There was at least 1 error reported (History).
Black	Not applicable.





# 9 **BERT**

The Bit Error Rate Test (BERT) measures the level of transmission impairment on a communication channel. Specific test patterns are sent through Ethernet frames and then analyzed to detect data integrity problem (bit error).

The BERT test case offers several options:

- Traffic configuration:
  - Ethernet or Ethernet/IPv4/UDP (when the IPV4 version is selected)  
Ethernet or Ethernet/IPv6/UDP (when the IPv6 version is selected)
  - Frame size
  - Transmit rate
  - Test pattern
- Capability to change dynamically the rate and frame size while the test is running.
- Injection of impairments on the transmitted traffic (bit errors).
- Capability to reset all results/statistics while the test is running.
- Errors/Alarms monitoring.
- Capability to measure the service disruption time based on no traffic received (No Traffic mode).
- Global verdict based on bit error count & SDT or bit error rate & SDT.
- Capability to configure and view the list of recorded events while a test case was running, including threshold crossing events.

Although the AXS-200/850 Ethernet Test Set has a single port, both unidirectional and bidirectional BERT testing can be performed.

Unidirectional BERT testing is performed whereby the test stream is transmitted from the local module to a remote device in loopback, and the test stream is received back and locally analyzed. The results are reported at the local end.

Bidirectional BERT testing is composed of two independent tests where traffic transmitted from one end will be analyzed at the other end. Test synchronization between 2 units is performed on a best-effort basis. Any alarms/errors due to incorrect synchronization can be cleared while the test is running. The test results for each direction are reported only at the receive end. There is no exchange of results between test units. The local and remote modules can be either an AXS-200/850 Ethernet Test Set or FTB-8510/8510B/8510G.

The **BERT** menu offers the following structure:

<b>SubMenu</b>	<b>Tab</b>	<b>Page</b>
Configuration	<i>Global Configuration</i>	97
	<i>Stream Configuration</i>	101
Results	<i>Summary Results</i>	105
	<i>Detailed Results</i>	111
	<i>Service Disruption Results</i>	112
	<i>Alarms/Errors</i>	114
Logger	<i>Logger</i>	117

## Global Configuration

The rate and frame size can be changed dynamically while the test is running. The Pass/Fail verdict can be set at anytime independent of whether a test is started.

Press , select **BERT, Configuration**, and the **Global** tab.

**Note:** *Service Disruption Time feature is always active.*

- **Framing:** Select **Ethernet**, **Ethernet/IPv4/UDP** or **Ethernet/IPv6/UDP**. The default value is **Ethernet**.
- **Rate Unit:** Select the unit for the transmission and receive rate. Choices are **Mbps** and **%**. The default setting is **Mbps**.
- **TX Rate:** Set the transmission rate in terms of a percentage of the line rate or in Mbps. The accepted range and increments are as follows:

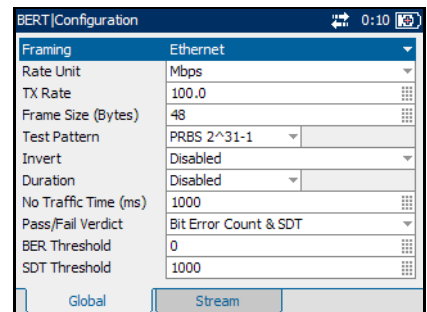

Interface	Maximum Rate	
	%	Mbps
10 Mbps	0.1 - 100, default = 100	0.01 - 10, default = 10
100 Mbps		0.1 - 100, default = 100
1000 Mbps		1 - 1000, default = 1000

## BERT

### Global Configuration

---

- **Frame Size (Bytes):** Set the frame size up to 9600 bytes. The default value is **64** bytes. By default, No VLAN is selected. If **Ethernet** framing is selected, the minimum frame size is **48**.

If **Ethernet/IPv4/UDP** framing is selected, the minimum frame size is according to the number of VLAN layers:

- No VLAN = 64 bytes
- One VLAN = 68 bytes
- Two VLAN = 72 bytes

If **Ethernet/IPv6/UDP** framing is selected, the minimum frame size is according to the number of VLAN layers:

- No VLAN = 84 bytes
- One VLAN = 88 bytes
- Two VLAN = 92 bytes

**Note:** *The frame size can be changed at any time whether or not a test is running.*

- **Test Pattern:** Select a test pattern. Choices are as follows:

**PRBS 2<sup>9</sup> -1**

**PRBS 2<sup>11</sup> -1**

**PRBS 2<sup>15</sup> -1**

**PRBS 2<sup>20</sup> -1**

**PRBS 2<sup>23</sup> -1**

**PRBS 2<sup>31</sup> -1 (default)**

**User Pattern:** Go to the next field to define the user pattern parameter that indicates the test pattern to be used. The user pattern is a 32-bit (4-byte) value. The default value is **0**.

- **Invert:** Enable or disable **Invert**. If enabled, the test pattern is transmitted/analyzed with all bits inverted meaning that every 0 is changed to 1, and every 1 to 0. For example, the pattern 1100 will be sent as 0011. The test pattern inversion is disabled by default.
- **Duration:** Set the duration of the test. The choices are as follows:
  - **15-Min**
  - **1-Hour**
  - **2-Hours**
  - **4-Hours**
  - **6-Hours**
  - **12-Hours**
  - **24-Hours**
  - **User Defined**
  - **Disabled:** Runs the test for infinite time. It can be stopped manually at any point of time.

The default value is **Disabled**. Select the duration field next to **User Defined** and a pop up menu will be displayed to configure the test duration.

- **No Traffic Time:** The No Traffic Time configuration allows a user to set the time between two Ethernet Frames that is acceptable without raising an alarm. It also describes when a Service Disruption event occurs. Enter the acceptable delay between the two frames. The acceptable range is from **0.01 ms** to **1000 ms**. The default value is **1000 ms**.

## BERT

### Global Configuration

---

- **Pass/Fail Verdict:** The **Pass/Fail Verdict** configuration enables or disables the use of the pass/fail verdict for the **BER Threshold** and **SDT Threshold** (SDT is always a part of the verdict when the verdict is enabled). Select the Pass/Fail verdict as **Bit Error Count & SDT**, **Bit Error Rate & SDT**, or **Disabled** to specify over which thresholds the pass/fail verdict will be done.

The Bit Error measurement (BER Threshold) and the SDT have influence over the global verdict.

In addition, the Global Pass/Fail verdict is declared as Fail when at least one of the following alarms is raised during the test:

- Link Down
- LOS
- Pattern Loss
- **BER Threshold:** If the **BER Threshold** is enabled, enter the threshold amount as follows:
  - If the **Pass/Fail Verdict** is **Bit Error Count & SDT**, the accepted BER threshold range is a 6 digit figure with default value of **0**. The BER Threshold indicates the number of accepted errors before failing the Test.
  - If the **Pass/Fail Verdict** is **Bit Error Rate & SDT**, the accepted BER threshold range is 1.0E-14 to 1.0E0 with default value of 1.0E-2. The BER Threshold indicates the accepted Bit error rate before failing the Test.
- **SDT Threshold:** The **SDT Threshold** represents the amount of time with no traffic that is accepted before failing the test. Enter the threshold value. The accepted range is from **0.01 ms** to **300000 ms**. The threshold value cannot be less than the **No Traffic Time** value.

## Stream Configuration

Press , select **BERT**, **Configuration**, and the **Stream** tab.

**Note:** Only **Destination MAC Address** is configurable, if **Ethernet framing** is selected in **Global Configuration**.

- **Destination MAC Address:** Enter the **MAC Address** if the **Resolve MAC Address** is not enabled. The default setting is:  
**FE:FE:FE:FE:FE:FE.**

When the **Destination MAC Address** field is selected for editing, the **Latest MAC's** button appears on the bottom of the screen. Press the corresponding function key to display the list of previously configured MAC addresses. Select the desired MAC address from the list, if any.

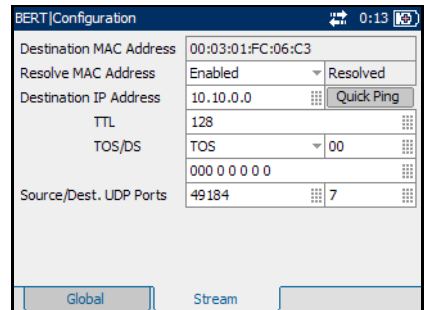

BERT Configuration		0:13
Destination MAC Address	00:03:01:FC:06:C3	
Resolve MAC Address	Enabled	Resolved
Destination IP Address	10.10.0.0	Quick Ping
TTL	128	
TOS/DS	TOS	00
	000 0 0 0 0 0	
Source/Dest. UDP Ports	49184	7

- **Resolve MAC Address:** Enable or disable **Resolve MAC Address** The default setting is **Disabled**.

When enabled, an ARP request is sent to the network to retrieve the MAC Address corresponding to the selected IP address for IPv4.

When enabled, a Neighbor Solicitation request is sent to the network to retrieve the MAC Address corresponding to the selected IP address for IPv6.

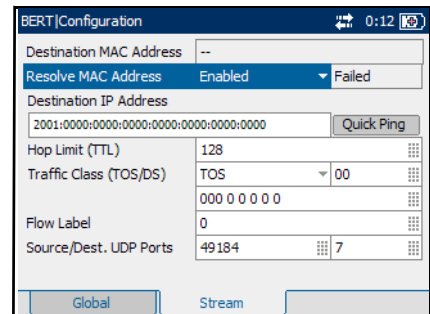

BERT Configuration		0:12
Destination MAC Address	--	
Resolve MAC Address	Enabled	Failed
Destination IP Address	2001:0000:0000:0000:0000:0000:0000:0000	Quick Ping
Hop Limit (TTL)	128	
Traffic Class (TOS/DS)	TOS	00
	000 0 0 0 0 0	
Flow Label	0	
Source/Dest. UDP Ports	49184	7

If not resolved after 3 seconds, the MAC value becomes "--" and the stream is disabled. In the next status field, a **Not Resolved** status will appear. The status field also displays "--" when the **Resolve MAC Address** is disabled, and other status includes **Failed**, **Not Resolved**, and **Resolved**. The default status is "--".

➤ **Destination IP Address:** Enter the **Destination IP Address**.

The default setting for IPv4 is **10.10.0.0** or is set automatically to the IP address of the target module from **Remote Loopback** mode. The default setting for IPv6 is **2001:0000:0000:0000:0000:0000:0000:0000**. It can also be set automatically to the IP address of the target module from **Remote Loopback** mode. It should be a valid **Link-Local IPv6 Address (LLA)** or **Global IPv6 Address (GUA)** address.

The accepted range for IPv4 is **0.0.0.0** to **255.255.255.255**. The default value is **0.0.0.0**. The **IPv6 Address** can either be the **Link-Local IPv6 Address** or the **Global IPv6 Address**. The acceptable range for IPv6 is from **000:0000:0000:0000:0000:0000:0000:0001** to **FFFF:FFFF:FFFF:FFFF:FFFF:FFFF:FFFF:FFFF**.

When the **IP Address** field is selected for editing, the **Latest IP's** button appears on the bottom of the screen. Press the corresponding function key to display the list of previously configured IP addresses. Select the desired IP address from the list, if any.

➤ **Quick Ping:** Select the **Quick Ping** button to test if the destination IP address can be reached. A message will be returned to indicate if the ping attempt was **Successful** or **Failed**.

**Note:** *When a remote module is looped up, the **Destination IP Address** is not configurable (read only). When a remote module is looped down, the **Destination IP Address** reverts to the previously configured value.*

➤ **TTL** for IPv4 and **Hop Limit (TTL)** for IPv6

Enter the Time to Live (**TLL**) value. The accepted range is from **0** to **255** with a default of **128**.



- **TOS/DS** for IPv4 and **Traffic Class (TOS/DS)** for IPv6

Select Type of Service (**TOS**) or Differentiated Services (**DS**).

**Note:** *It is possible to configure the **TOS/DS** parameter using either the hexadecimal code (00 to FF) or **TOS/DS** using binary code.*

- If **TOS** is selected, go to the next field to enter the hexadecimal code **00** to **FF** or go to the field underneath to enter the binary code.

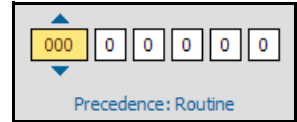

The possible values are shown as follows:

Parameter	Value	Bit
Precedence	000 (Routine), 001 (Priority), 010 (Immediate), 011 (Flash), 100 (Flash Override), 101 (CRITIC/ECP), 110 (Internet Control), 111 (Network Control) Default: 000 (Routine)	1-3
Throughput	Normal / High (0/1) Default: Normal	4
Monetary Cost	Normal / Low (0/1) Default: Normal	5
Delay	Normal / Low (0/1) Default: Normal	6
Reliability	Normal / High (0/1) Default: Normal	7
Reserved bit	0 or 1 Default: 0	8

## BERT

### Stream Configuration

---

- If **DS** is selected, go to the next field to enter the hexadecimal code **00** to **FF** or go to the field underneath to enter the binary code.

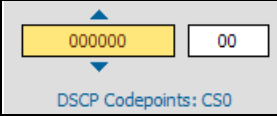

DSCP Codepoints: CS0

The possible values are shown as follows:

Parameter	Value	Bit
DSCP Codepoints	000000 (CS0), 001000 (CS1), 010000 (CS2), 011000 (CS3), 100000 (CS4), 101000 (CS5), 110000 (CS6), 111000 (CS7), 001010 (AF11), 001100 (AF12), 001110 (AF13), 010010 (AF21), 10100 (AF22), 010110 (AF23), 011010 (AF31), 011100 (AF32), 011110 (AF33), 100010 (AF41), 100100 (AF42), 100110 (AF43), 101110 (EF), Default: 000000 (CS0)	1-6
ECN	00 (Not-ECT), 01 (ECT-1), 10 (ECT 0), 11 (CE) Default: 00 (Not-ECT)	7-8

- **Flow Label** (For IPv6 only): Enter the **Flow Label** value. The acceptable range is from **0** to **1048575**. The default value is **0**.
- **Source/ Dest. UDP Ports**: Enter the **Source UDP Port**. The accepted range is from **0** to **65535**. The default value is **49184**. Enter the **Destination UDP Port**. The accepted range is from **0** to **65535**. The default value is **7**.

## Summary Results

The Summary Results page allows the user to not only view the status of the test, but to also change certain parameters dynamically as the test is running, such as injecting and resetting errors, changing the transmission rate, frame size, and threshold.



### IMPORTANT

Test results/statistics are cleared when changing test or tool selection. It is highly advised to generate and save the report once the current test is completed. Refer to *Report Generation* on page 79 to generate and save a report file.

Press , select **BERT, Results**, and the **Summary** tab.

- **Status:** The BERT test progress is monitored and updated on a per second basis. The status displays the following:
  - “--”: test is not running and results are not available.
  - **In Progress:** test is running.
  - **Completed:** test is completed, stopped at the planned time, or manually stopped when there is no set timer.
  - **Aborted:** test is interrupted; test is stopped before the set time.

BERT Results		20:13
Status	In Progress	🟢 PASS
RX Rate (Mbps)	100.0	Start Time: 19:53
TX Rate (Mbps)	100.0	Duration: 0d 00:00:12
Longest SDT (ms)	0	
Bit Error Amount	1	Inject
BERT Threshold	1.0E-02	Reset
Bit Error Count	0	
Bit Error Rate	0.0E00	Report
Summary		Detailed   Service Disruption

Once the BERT test is stopped, the **Pass/Fail** verdict is displayed, when enabled.

## BERT

### Summary Results

---

- **Start Time:** The time when the BERT test was started.
- **Duration:** The length of time from when the test was started, until when the test was completed.
- **RX Rate:** Display the receive rate in terms of a percentage of the line rate or Mbps.
- **TX Rate:** Set the transmission rate in terms of a percentage of the line rate or in Mbps.

The accepted range and increments are as follows:

Interface	Maximum Rate	
	%	Mbps
10 Mbps	0.001 - 100.000, default = 100.000	0.001 - 10.000, default = 10.000
100 Mbps	0.001 - 100.000, default = 100.000	0.001 - 100.000, default = 100.000
1000 Mbps	0.001 - 1000.000, default = 1000.000	0.001 - 1000.000, default = 1000.000

- **Longest SDT (ms):** Displays the longest service disruption time measured from the beginning of the test.
- **Bit Error Amount:** Set the bit error amount to inject into traffic. The accepted range is from **1** to **50** with a default value of **1**. This parameter is configurable at any time whether or not a test is running.
- **Inject:** Select this button to inject bit errors on the transmitted traffic. Bit errors are injected only while a test is running.

- **BER Threshold:** Enter the threshold amount as follows (if the bit error results exceed this value, the test will be declared as failed):
  - If the **Pass/Fail Verdict** is **Bit Error Count**, the accepted threshold range is 6 digits with a default value of **0**.
  - If the **Pass/Fail Verdict** is **Bit Error Rate**, the accepted threshold range is **1.0E-14** to **1.0E0** with a default value of **1.0E-2**.
  - The **Pass/Fail Verdict** is displayed on the screen with the help of the following symbols:
    - ✔ = PASS
    - ✘ = FAIL
- **Reset:** Press this button at any time to clear the results and statistics. This does not interrupt the monitoring process nor cause errors on the transmitted stream while a test is running. Use after an injection of bit errors to clear results.
- **Bit Error Count:** Displays the sum of mismatch '0' and mismatch '1' errors.
- **Bit Error Rate:** Displays the bit error rate with a range of 1.0E-14 to 1.0E0.
- **Report:** Select the **Report** button to generate the report file of the results and statistics. Refer to *Report Generation* on page 79 to generate and save a report file.

## Report Generation

Reports can be generated for the test and tools results. The report button is available on the **BERT, Traffic Generation & Monitoring, RFC 2544** summary tabs, and **Ping, Trace Route, and Cable Test** result tabs.

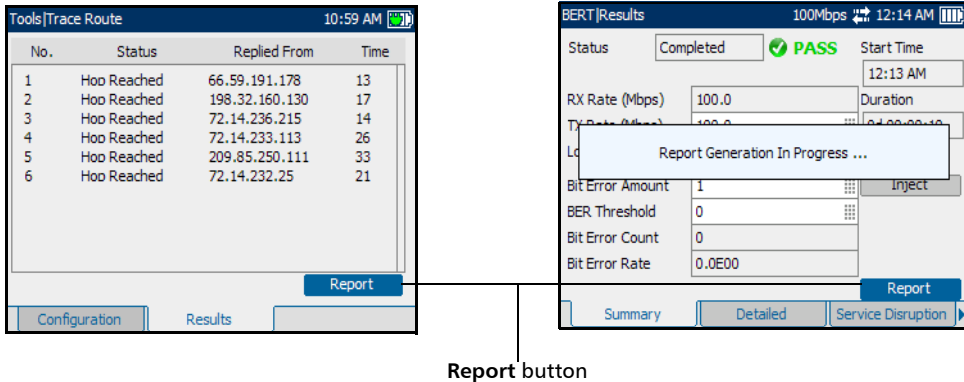

### To generate a report:

1. Select the **Report** button from the **Results** page, if not already selected, and press the **✓** button.
2. The report is being generated and is displayed on screen.
3. Press the **✓** button to select the report section, and use the up and down arrows to scroll through the report.
4. Press the **↶** button to have access to the function keys.
5. Press **Bottom** to move to the bottom of the page.

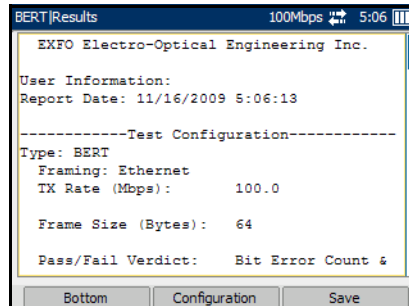

**Note:** When the bottom of the page is displayed, **Bottom** changes to **Top**.

6. Press the function key under **Configuration** on the bottom of the screen to configure the titles and headings of the report.
7. Customize the following fields.  
Refer to *Report Configuration* on page 207 for information on the parameters:

➤ **Report Header**

➤ **Report Title**

➤ **User Information**

➤ **File Name**

➤ **Logger in Report:** Allows to enable or disable the Logger section in Report. Choices are **Enabled** and **Disabled**. The default setting is **Enabled**. If **Disabled**, the Logger section will not be displayed in the report.

If **Enabled**, the report generated will display the Logger section at the bottom of the page as shown in the figure.

**Note:** *The report page lists the events in incremental order.*

8. Select **Default** to revert all parameters back to the default settings.

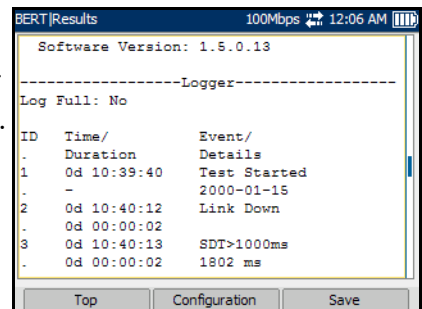
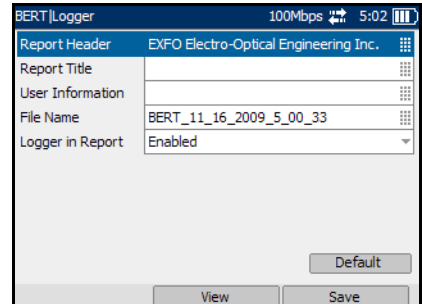

## BERT

### Summary Results

---

9. Select **View** to display the changes on the report file.

10. Select **Save** to save the report file.

The report will be saved on the selected media. Refer to *Media Selector* on page 207.

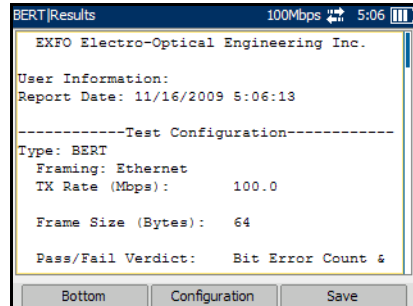

11. A message is displayed to indicate that the report file is successfully saved.

12. Select the **OK** button by pressing the function key underneath it. Use the navigation arrows to scroll up and down the page to view the report.

13. To exit the report page, press the **↶** button.

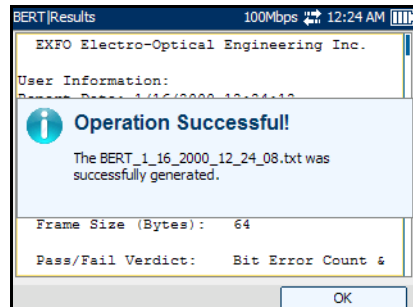



## Detailed Results

Press , select **BERT, Results**, and the **Detailed** tab.

### Alarms

- **Pattern Loss:** Alarm is raised when the bit error rate is above 0.2.
- **No Traffic:** Alarm is raised when there is no traffic for a period specified by the **No Traffic Time** configuration. Since the monitoring starts at the beginning of the test, this alarm is in an undefined state for the time configured in the **No Traffic Time** field after a test case is started.

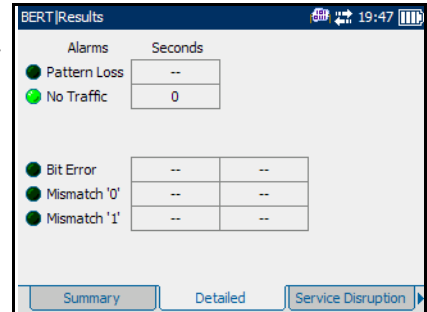

Alarms	Seconds
● Pattern Loss	--
● No Traffic	0
● Bit Error	--
● Mismatch '0'	--
● Mismatch '1'	--

- The **Pass/Fail Verdict** is displayed on the screen with the help of the following symbols:
  - ✔ = PASS
  - ✘ = FAIL

### Errors

- **Bit Error:** A bit error indicates that there are logic errors in the bit stream. (i.e. zeros that should be ones and vice versa).
- **Mismatch '0':** A mismatch '0' error indicates a bit error on a binary '0' (i.e. ones that should be zeros) found in the receiving test pattern only.
- **Mismatch '1':** A mismatch '1' error indicates a bit error on a binary '1' (i.e. zeros that should be ones) found in the receiving test pattern only.

**Note:** *The errors are monitored only on the Test Pattern and not on the Ethernet frame header, CRC, Preamble, or Idle code-group.*

## Service Disruption Results

The Service Disruption Results page allows the user to view the results and change the SDT Threshold parameter dynamically as the test is running.

Press , select **BERT, Results**, and the **Service Disruption** tab.

- **Longest (ms):** Displays the longest service disruption time measured from the beginning of the test. If the longest SDT is greater than the configured SDT Threshold, the SDT will Fail. If the Longest SDT is less than the SDT Threshold, the SDT will PASS. Statistics are always calculated, regardless of the verdict.

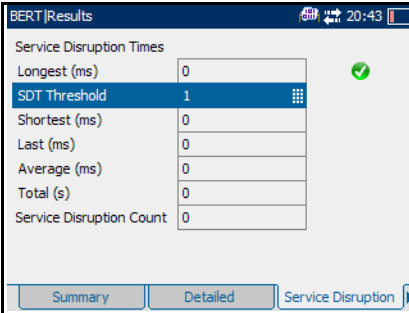

Service Disruption Times	
Longest (ms)	0
<b>SDT Threshold</b>	<b>1</b>
Shortest (ms)	0
Last (ms)	0
Average (ms)	0
Total (s)	0
Service Disruption Count	0

Summary Detailed Service Disruption

The **Pass/Fail Verdict** is displayed on the screen with the help of the following symbols:

 = PASS

 = FAIL

- **SDT Threshold:** Enter the **SDT Threshold**. The SDT Threshold value cannot be less than the **No Traffic Time** value.
- **Shortest (ms):** Displays the shortest service disruption time measured from the beginning of the test.
- **Last (ms):** Displays the last or current service disruption time measured.

- **Average (ms):** Displays the average service disruption time from the beginning of the test.
- **Total (s):** Displays the total service disruption time from the beginning of the test.
- **Service Disruption Count:** Displays the number of disruption events, that is, the number of times the period without traffic exceeded the No traffic time.

## Alarms/Errors

Press , select **BERT, Results**, and the **Alarms/Errors** tab.

The **Alarms/Errors** page displays alarms and errors with green, red, or amber indicators. The error count and the amount of time in seconds that the alarm remained raised during test execution is also displayed. The description of each alarm and error is provided as follows:

### Alarms

- **Link Down:** Indicates that the Ethernet connection is down. The Ethernet connection is down when there is a local or a remote fault condition.
- **LOS:** Indicates a loss of signal on the optical port.
- **Frequency:** A frequency alarm is raised when the frequency offset of the receiving signal is over the standard limit ( $\pm 100$  ppm).

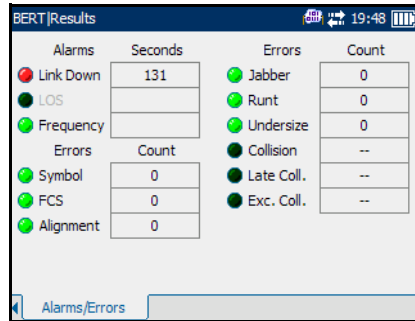

Alarms	Seconds	Errors	Count
Link Down	131	Jabber	0
LOS		Runt	0
Frequency		Undersize	0
Symbol	0	Collision	--
FCS	0	Late Coll.	--
Alignment	0	Exc. Coll.	--

**Note:** The total number of alarmed seconds for Link Down, LOS, and Frequency is recorded and displayed in the field next to the alarm name.

**Note:** Alarms/Errors are updated only during test execution.

The **Alarm** LEDs are described as follows:

<b>LED Label</b>	<b>Color</b>	<b>Meaning</b>
Link Down	Green	Link up.
	Red	Link down (Current).
	Amber	Link down was present (History).
	Black	Not applicable.
LOS (loss of signal)	Green	No LOS is present during test.
	Red	LOS alarm is present (Current).
	Amber	LOS was present (History).
	Black	Not applicable.
Frequency	Green	No frequency offset alarm is present during the test.
	Red	Frequency offset alarm is present (Current).
	Amber	Frequency offset alarm was present (History).
	Black	Not applicable.

## Errors

- **Symbol** (100/1000 Mbps): A Symbol Error is declared when an invalid code-group in the transmission code is detected.
- **FCS:** The number of received frames with an invalid FCS.
- **Alignment** (10/100 Mbps): Indicates the number of received frames without an integral number of octets in length.
- **Jabber:** The number of received frames larger than 1518 (no VLAN tag), 1522 (One VLAN tag), 1526 (Two VLAN tags), or 1530 (3 VLAN tags) bytes with an invalid FCS.
- **Runt:** The number of received frames that are smaller than 64 bytes with an invalid FCS.
- **Undersize:** The number of received frames smaller than 64 bytes with a valid FCS.

The following errors are only available with **Half Duplex** mode (only for electrical interface at speeds of 10 Mbps and 100 Mbps).

- **Collision:** Indicates the number of collisions on the link.
- **Late Coll.:** Indicates the number of collisions that have occurred after a 64 bytes transmission.
- **Exc. Coll.:** Indicates the number of frames that were sent 16 times unsuccessfully due to consecutive collisions.

The **Errors** LEDs are described as follows:

Color	Meaning
Green	No error.
Red	A test is running and there is at least one error present (Current).
Amber	There was at least 1 error reported (History).
Black	Not applicable.

## Logger

The Logger page allows the user to configure and view the Logger events based on Event ID, Time, Event, Duration and Details.

Press , select **BERT**, and **Logger**.

- **Sort By:** Select the **Sort By** parameter to sort the events. Choices are **ID/Time** and **Event**. The default setting is **ID/Time**.

When the **Sort By** parameter is set to **ID/Time**, the Event Logger entries will be displayed in numeric ascending order based on the ID field of the Event Logger table.

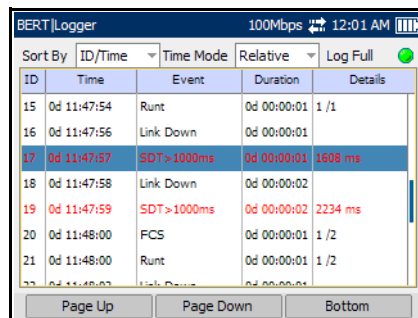

ID	Time	Event	Duration	Details
15	0d 11:47:54	Runt	0d 00:00:01	1 / 1
16	0d 11:47:56	Link Down	0d 00:00:01	
17	0d 11:47:57	SDT>1000ms	0d 00:00:01	1608 ms
18	0d 11:47:58	Link Down	0d 00:00:02	
19	0d 11:47:59	SDT>1000ms	0d 00:00:02	2234 ms
20	0d 11:48:00	FCS	0d 00:00:01	1 / 2
21	0d 11:48:00	Runt	0d 00:00:01	1 / 2

When the **Sort By** parameter is set to **Event**, the Event Logger entries will be displayed in alphanumeric ascending order based on the type of events.

- **Time Mode:** Select the mode of time representation. Choices are **Relative** and **Absolute**. The default setting is **Relative**.
  - **Relative:** Displays the time relative to the beginning of the test or the last test results reset. The format of the time is Dd HH:MM:SS.
  - **Absolute:** Displays the time relative to the test start time and start date. The time format depends upon the platform time.

When the platform is configured in 24 hours time format, the time format in the **Time** column will be MM/DD HH:MM:SS.

When the platform is configured in 12 hours time format, the time format in the **Time** column will be MM/DD HH:MM:SS <AM or PM>.

- **Log Full:** Indicates that the logger exceeds its maximum of 500 entries.

The Log Full indicator can have three conditions:

Color	Condition
Green	Log not full
Red	Log full
Black	Test not started

The Logger table provides the Event Logger information with the following columns:

- **ID:** Indicates the event identification number. The events are sequentially numbered.
- **Time:** Indicates when the event has been detected.
- **Event:** Provides the event type and threshold crossing information.
- **Duration:** Indicates the number of seconds within which the event occurred.

**Note:** *The test events like Test Started and Test Stopped will have no duration.*

- **Details:** Provides contextual information.



The following table displays the nature of information reported by type of event:

Type of Event	Nature of Information
Test Started	Start Date
Test Stopped	Pass/Fail Verdict
Alarm Events	None
Bit Error Events	Current Count and Total Count
SDT Events	Service Disruption Time
BER Threshold Crossing Event	Value at the end of the test

**Note:** *The alarm events will not display any details.*

**Note:** *The Logger table can display up to 500 event entries. Once the Logger table reports 500 event entries, the **Log Full** indicator will change to Red and no further entries will be possible but the events in the **Pending** state will be updated if a test is running.*

The Event Logger information will be cleared under the following conditions:

- When the test is reset or started.
- When the unit is suspended.
- When stopping the current test and navigating to other tests.
- When the unit is restarted.

**Note:** *The entry remains in the **Pending** state as long as the event is not completed and it is highlighted in **Yellow** color.*

**Note:** *The Threshold Crossing events are displayed in **Red** color.*

The following tabs are displayed at the bottom of the table:

- **Page Up:** Allows to scroll up by one page.
- **Page Down:** Allows to scroll down by one page.
- **Top/Bottom:** Allows to toggle between the top and bottom of the table.

When the bottom of the page is displayed, **Top** changes to **Bottom** and vice versa.

When the top of the page is currently displayed, pressing **Bottom** will display the bottom of the page and vice versa.

The Logger table provides the Auto-Scroll feature. It allows to display the latest events in the table as soon as they occur. Pressing **Bottom** will allow to jump to the last entry.

Auto-Scroll will be active when:

- The test is running.
- The latest event is being displayed.
- The **Sort By** parameter is set to **ID/Time**.

**Note:** *When a test is started and the **Sort By** parameter is set to **ID/Time**, the Auto-Scroll function is active by default.*



# 10 **Traffic Generation & Monitoring**

The main goal of Traffic Generation & Monitoring test is to qualify the performance of Ethernet or IP network. The Traffic Generation & Monitoring test can be used to confirm the Service Level Agreements between service providers and the customers. The Traffic Generation & Monitoring Test measures simultaneously the following fundamental criteria:

- Available bandwidth (Throughput)
- Frame Loss
- Transmission Delay (Latency)
- Delay Variation (Jitter)
- Out-of-Sequence

**Note:** *The Traffic Generation & Monitoring Test is enabled by a software option. The Background Streams is a software option, and can only be activated once the Traffic\_Gen software option is activated.*

In addition, the Traffic Generation & Monitoring Test offers statistics on Flow control, Ethernet frame count, and Ethernet frame size.

The Traffic Generation & Monitoring test generates up to four streams i.e. one main stream and three background streams. The stream properties are configured independently for each stream. The main stream parameters are common with the test interface while the three background streams have individual configuration.

## Traffic Generation & Monitoring

---

The Traffic Generation & Monitoring test offers the following structure:

<b>SubMenu</b>	<b>Tab</b>	<b>Page</b>
Stream Config: The Stream Config allows configuring main stream and global test properties.	<i>Global Configuration</i>	125
	<i>Shaping Configuration</i>	128
	<i>Stream Configuration</i>	130
	<i>Sequence Configuration</i>	134
	<i>Jitter/Latency Configuration</i>	136
Background Streams Config: The background streams are available through a software option. When the Multiple Streams software option is enabled, up to 3 background streams are generated. The three background streams have individual Transmit, Stream, Network, Default Gateway, and VLAN configuration.	<i>Transmit Configuration</i>	140
	<i>Stream Configuration</i>	130
	<i>Network Configuration</i>	147
	<i>Default Gateway</i>	151
	<i>VLAN Configuration</i>	153
Results: Result page allows user to not only view the status of the test, but also to change certain parameters dynamically as the test is running.	<i>Summary Results</i>	154
	<i>Throughput Results</i>	163
	<i>Sequence Results</i>	165
	<i>Jitter/Latency Results</i>	169
	<i>Alarms/Errors Results</i>	171
	<i>Frame Count Results</i>	174
	<i>Frame Size Results</i>	175
	<i>Flow Control Results</i>	177
Logger: Logger page allows you to configure and view the list of recorded events with the history of the events recorded while a test case was running, including threshold crossing events.	<i>Logger</i>	178

## Global Configuration

The Global page allows configuring the main stream properties and global test parameters such as duration and rate unit.

Press , select **Traffic Generation & Monitoring, Stream Config**, and the **Global** tab.

➤ **Rate Unit:** Select the unit for the transmission and receive rate. Choices are **Mbps** and **%**. The default setting is **Mbps**.

➤ **Duration:** Set the duration of the test. The choices are as follows:

➤ **15-Min**

➤ **1-Hour**

➤ **2-Hours**

➤ **4-Hours**

➤ **6-Hours**

➤ **12-Hours**

➤ **24-Hours**

➤ **User Defined**

➤ **Disabled:** Runs the test for infinite time. It can be stopped manually at any point of time.

The default value is **Disabled**. Select the duration field next to **User Defined** and a pop up menu will be displayed to configure the test duration.

➤ **TX:** Enable or disable main stream transmission. The default value is **Enabled**.

➤ **Framing:** Select the frame structure of the main stream. Choices are **Ethernet/IPv4/UDP** or **Ethernet/IPv6/UDP** and **Ethernet**. The default setting is **Ethernet**.

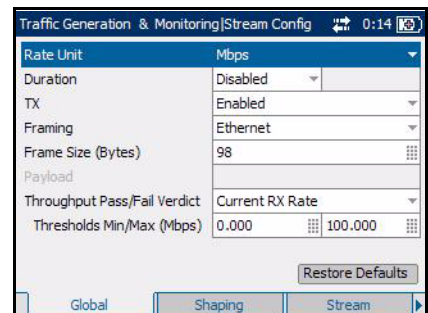

## Traffic Generation & Monitoring

### Global Configuration

- **Frame Size (Bytes):** Set the frame size for **Ethernet** and **Ethernet/IPv4/UDP** or **Ethernet/IPv6/UDP**. The default value will be equal to the minimum frame size or to 64 bytes if the minimum frame size is under 64 bytes. The minimum frame size varies with the framing selection, number of VLAN layers configured, and proprietary information insertion for jitter, latency and sequence tracking.

The following table displays the minimum and maximum frame size:

Frame Type		Minimum Frame Size (Bytes)								Maximum Frame Size (Bytes)	
		Jitter	Yes				No				
		Latency	Yes		No		Yes		No		
		Sequence Tracking	Yes	No	Yes	No	Yes	No	Yes		No
Ethernet	No VLAN	98	84	84	70	80	66	66	48	9600	
	One VLAN	102	88	88	74	84	70	70	48	9600	
	Two VLAN	106	92	92	78	88	74	74	48	9600	
Ethernet/IPv4/UDP	No VLAN	98	84	84	70	80	66	66	52	9600	
	One VLAN	102	88	88	74	84	70	70	56	9600	
	Two VLAN	106	92	92	78	88	74	74	60	9600	
Ethernet/IPv6/UDP	No VLAN	118	104	104	90	100	86	86	72	9600	
	One VLAN	122	108	108	94	104	90	90	76	9600	
	Two VLAN	126	112	112	98	108	94	94	80	9600	

- **Payload:** **Payload** is available only when Jitter is disabled. Set the payload of the frames in hexadecimal format. The accepted range is from 00 to FF. The default value is CC.



- **Throughput Pass/Fail Verdict:** Select the type of **Throughput Pass/Fail Verdict** criteria. Choices are **Current RX Rate**, **Average RX Rate**, and **Disabled**. The **Current RX Rate** correspond to the **Average RX Rate** of the last second. The **Average RX Rate** corresponds to the average rate since the beginning of the test.
- **Thresholds Min/Max:** Set the Minimum and Maximum threshold values if threshold is enabled.

When the **Throughput Pass/Fail Verdict** is selected as **Current RX Rate**, the Pass/Fail Verdict is declared as Fail as soon as the test-stream current receive rate is over the maximum threshold or below the minimum threshold.

When the **Throughput Pass/Fail Verdict** is selected as **Average RX Rate**, the Pass/Fail Verdict is declared as Fail as soon as the test-stream average receive rate is over the maximum threshold or below the minimum threshold. The Pass/Fail Verdict is evaluated every second, the final Pass/Fail Verdict correspond to the verdict at the last second of the test.

When the **Throughput Pass/Fail Verdict** is selected as **Disabled**, the Pass/Fail Verdict is not displayed.

- **Restore Defaults:** Press **Restore Defaults** to restore the default configuration for main and background streams.

## Shaping Configuration

The main stream is configured to send frames evenly distributed in time (constant) or to follow a specific shape: square wave burst or repetitive multiple step ramp.

Press , select **Traffic Generation & Monitoring, Stream Config**, and the **Shaping** tab.

- **Shaping:** Select the shape of the main stream. Choices are **Constant**, **Burst**, and **Ramp**. The default setting is **Constant**.

*The shaping is forced to **Constant** when Jitter is selected as User Defined. See Jitter Configuration on page 136.*

**Constant** transfers the frame continuously according to the configured TX rate.

**Burst** transfers the frames at Max TX Rate during the percentage of the Burst Period determined by the Duty cycle parameter.

**Ramp** transfers the frames by incrementing successively the transmit rate up to the Max TX Rate. The transmit rate progression is divided into a number of Steps. Each step duration is determined by the Step Time parameter.

- **Burst Duty Cycle:** Enter the value of **Burst Duty Cycle**. This parameter determines the burst duration within the burst period. The accepted range is from 1 % to 100 %. The default value is 50 %. The burst duty cycle parameter is available only when the **Burst** shaping mode is selected in the **Shaping** field.

**Period:** Determine the burst pattern duration. The accepted range is from **1 ms** to **8000 ms**. The default value is **1000 ms**.

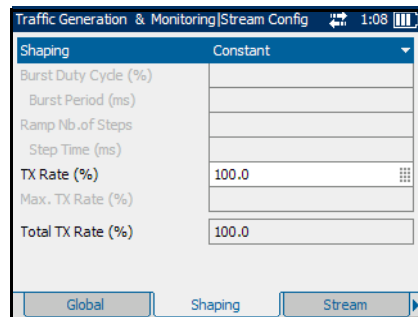

- **Ramp Nb. of Steps:** Enter the number of steps in the ramp pattern. The accepted range is from 2 to 100. The default value is **10**. The **Ramp Nb. of Steps** parameter is available only when the Ramp shaping mode is selected in the **Shaping** field.

**Step Time:** Enter the duration of each step that constitutes the ramp. The accepted range is from **1 ms** to **8000 ms**. The default value is **1000 ms**.

- **TX Rate:** Set the transmission rate in terms of a percentage of the line rate or in Mbps. When the traffic shaping is **Constant**, the **TX Rate** parameter determines the transmission rate in terms of a percentage of the line rate or in Mbps. When the traffic shaping is **Ramp** or **Burst**, the **TX Rate** parameter is calculated and represents the average transmission rate.
- **Max. TX Rate:** Determine the maximum transmit rate for **Burst** or **Ramp** shaping mode.
- **Total TX Rate:** The **Total TX Rate** presents the sum of the transmit rate of all streams enabled for transmission.

### Stream Configuration

The Sequence Tracking parameter determines if proprietary information is inserted in the payload of the transmitted frames for Frame Loss and Out-Of-Sequence detection.

Press , select **Traffic Generation & Monitoring, Stream Config**, and the **Stream** tab.

**Note:** Only **Destination MAC Address** is configurable, if **Ethernet framing** is selected in **Global Configuration**.

- **Destination MAC Address:** Enter the MAC Address if the **Resolve MAC Address** is disabled. The default setting is **FE:FE:FE:FE:FE:FE**.

When the **Destination MAC Address** field is selected for editing, the **Latest MAC's** button appears on the bottom left corner of the screen. Press the corresponding function key to display the list of previously configured MAC addresses. Select the desired MAC address from the list, if any.

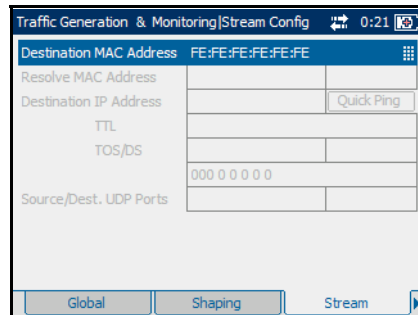

- **Resolve MAC Address:** Enable or disable **Resolve MAC Address**. The default setting is **Disabled**.

When enabled, an ARP request is sent to the network to retrieve the MAC Address corresponding to the selected IP address for IPv4.

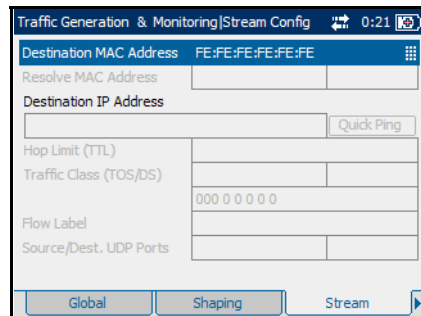

When enabled, a Neighbor Solicitation request is sent to the network to retrieve the MAC Address corresponding to the selected IP address for IPv6.

If not resolved after 3 seconds, it gives status as Failed. If the MAC address is resolved then the status is displayed as Resolved. The status field also displays "--" when the **Resolve MAC Address** is disabled, and other status includes **Failed**, **Not Resolved**, and **Resolved**. The default status is "--".

► **Destination IP Address:** Enter the **Destination IP Address**.

The default setting for IPv4 is **10.10.0.0**, or is set automatically to the IP address of the target module that is looped up from Remote Loopback mode. The destination IP address can be configured in **Ethernet/IPv4/UDP** mode.

The default setting for IPv6 is **2001:0000:0000:0000:0000:0000:0000**, or is set automatically to the IP address of the target module that is looped up from Remote Loopback mode. The destination IP address can be configured in **Ethernet/IPv6/UDP** mode.

The accepted range for IPv4 is **0.0.0.0** to **255.255.255.255**. The default value is **0.0.0.0**.

The **IPv6 Address** can either be the **Link-Local IPv6 Address** or the **Global IPv6 Address**.

The acceptable range for IPv6 is from **000:0000:0000:0000:0000:0000:0000:0001** to **FFFF:FFFF:FFFF:FFFF:FFFF:FFFF:FFFF:FFFF**.

► **Quick Ping:** Select the **Quick Ping** button to test if the destination IP address can be reached. A message will be returned to indicate if the ping attempt was **Successful** or **Failed**.

**Note:** *When a remote module is looped up, the Destination IP Address is not configurable (read only). When a remote module is looped down, the Destination IP Address reverts to the previously configured value.*

## Traffic Generation & Monitoring

### Stream Configuration

- **TTL** for IPv4 and **Hop Limit (TTL)** for IPv6  
Enter the Time to Live (**TTL**) value. The accepted range is from **0** to **255** with a default of **128**.
- **TOS/DS** for IPv4 and **Traffic Class (TOS/DS)** for IPv6  
Select Type of Service (**TOS**) or Differentiated Services (**DS**).

**Note:** It is possible to configure the **TOS/DS** parameter using either the hexadecimal code (**00** to **FF**) or binary code.

- If **TOS** is selected, go to the next field to enter the hexadecimal code **00** to **FF** or go to the field underneath to enter the binary code.



The possible values are shown as follows:

Parameter	Value
Precedence	000 (Routine), 001 (Priority), 010 (Immediate), 011 (Flash), 100 (Flash Override), 101 (CRITIC/ECP), 110 (Internet Control), 111 (Network Control) Default: 000 (Routine)
Delay	Normal / Low (0/1) Default: Normal
Throughput	Normal / High (0/1) Default: Normal
Reliability	Normal / High (0/1) Default: Normal
Monetary Cost	Normal / Low (0/1) Default: Normal
Reserved bit	0 or 1 Default: 0

- If **DS** is selected, go to the next field to enter the hexadecimal code **00** to **FF** or go to the field underneath to enter the binary code.

The possible values are shown as follows:

Parameter	Value	Bit
DSCP Codepoints	000000 (CS0), 001000 (CS1), 010000 (CS2), 011000 (CS3), 100000 (CS4), 101000 (CS5), 110000 (CS6), 111000 (CS7), 001010 (AF11), 001100 (AF12), 001110 (AF13), 010010 (AF21), 10100 (AF22), 010110 (AF23), 011010 (AF31), 011100 (AF32), 011110 (AF33), 100010 (AF41), 100100 (AF42), 100110 (AF43), 101110 (EF), Default: 000000 (CS0)	1-6
ECN	00 (Not-ECT), 01 (ECT-1), 10 (ECT 0), 11 (CE) Default: 00 (Not-ECT)	7-8

- **Flow Label** (For IPv6 only): Enter the **Flow Label** value. The acceptable range is from **0** to **1048575**. The default value is **0**.
- **Source/Destination UDP Ports**: Enter the **Source UDP Port**. The accepted range is from **0** to **65535**. The default value is **49184**. Enter the **Destination UDP Port**. The accepted range is from **0** to **65535**. The default value is **7**.

## Sequence Configuration

The Sequence Configuration page defines the sequence tracking function parameters and allows to enable or disable the sequence tracking feature for the main stream. Sequence tracking functions are based on a sequence number inserted in the frame/packet payload. This sequence number allows detecting out-of-sequence and lost frame/packet.

Press , select **Traffic Generation & Monitoring, Stream Config**, and the **Sequence** tab.

- **Sequence Tracking:** Enable or Disable the sequence tracking. The default value is **Enabled**. The sequence tracking determines if proprietary information is inserted in the payload of the transmitted frames for Frame Loss and Out-Of-Sequence detection.

- **Frame Loss Pass/Fail Verdict:**

Select the type of verdict for declaring the frame loss. Choices are **Count**, **Rate**, and **Disabled**. The default value is **Count**.

**Threshold:** Set the threshold value for declaring the frame loss. The Frame Loss Pass/Fail verdict is declared as **PASS** when the count or rate value is smaller than or equal to the threshold. The Frame Loss Pass/Fail verdict is declared as **FAIL** when the count or rate value is greater than the threshold.

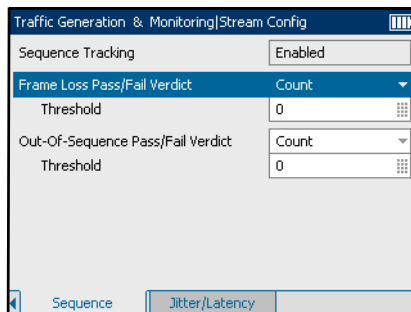



- **Out of Sequence Pass/Fail Verdict:** Select the type of verdict for declaring the number of frames that went out of sequence. Choices are **Count**, **Rate**, and **Disabled**.

**Threshold:** Set the threshold value for declaring number of frames that went out of sequence. The Out-Of-Sequence Pass/Fail verdict is declared as **PASS** when the count or rate value is smaller than or equal to the threshold. The Out-Of-Sequence Pass/Fail verdict is declared as **FAIL** when the count or rate value is greater than the threshold.

## Jitter/Latency Configuration

Press , select **Traffic Generation & Monitoring**, **Stream Config**, and the **Jitter/Latency** tab.

### Jitter Configuration

- **Jitter:** The **Jitter** parameter allows to enable or disable the Jitter proprietary information insertion in the payload and offers a pre-defined selection of profiles.

The following pre-defined profiles are available when frame structure **Ethernet/IPv4/UDP** or **Ethernet/IPv6/UDP** is selected. See **Framing** on page 125.

- **VoIP G.711**
- **VoIP G.723.1**
- **VoIP G.729**
- **IPTV SDTV (MPEG-2)**
- **IPTV HDTV (MPEG-2)**
- **IPTV HDTV (MPEG-4)**
- **User defined**
- **Disabled**

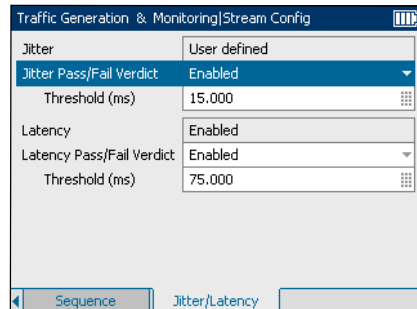

- The following pre-defined profiles are available when frame structure **Ethernet** is selected.
  - **User Defined**
  - **Disabled**

**Note:** If **User Defined** is selected, **Shaping** is forced to **Constant**. See **Shaping** on page 128.

**Note:** If **User Defined** is selected, **Payload** is disabled. See **Payload** on page 141.

**Note:** If **Disabled** is selected, the **Jitter meter** is disabled. See **Jitter** on page 157.

**Note:** When **VoIP G.723.1** or **VoIP G.729** is selected, **Sequence Tracking in Sequence tab** and **Latency in the Jitter/Latency tab** will be disabled.

The following table displays the supported speed, frame size, and transmit rate for all Jitter predefined profiles:

For IPv4:

Jitter pre-defined profile	Supporting speed	Frame size	Transmit rate
VoIP G.711	10/100/1000 Mbps	138 Bytes	0.1264 Mbps
VoIP G.723.1	10/100/1000 Mbps	82 Bytes	0.0271728 Mbps
VoIP G.729	10/100/1000 Mbps	78 Bytes	0.0392 Mbps
IPTV SDTV (MPEG-2)	10/100/1000 Mbps	1374 Bytes	3.972264 Mbps
IPTV HDTV (MPEG-2)	100/1000 Mbps	1374 Bytes	20.539255 Mbps
IPTV HDTV (MPEG-4)	100/1000 Mbps	1374 Bytes	10.592705 Mbps

## Traffic Generation & Monitoring

### Jitter/Latency Configuration

---

For IPv6:

Jitter pre-defined profile	Supporting speed	Frame size	Transmit rate
VoIP G.711	10/100/1000 Mbps	158 Bytes	0.1424 Mbps
VoIP G.723.1	10/100/1000 Mbps	102 Bytes	0.032533 Mbps
VoIP G.729	10/100/1000 Mbps	98 Bytes	0.0472 Mbps
IPTV SDTV (MPEG-2)	10/100/1000 Mbps	1394 Bytes	4.029255 Mbps
IPTV HDTV (MPEG-2)	100/1000 Mbps	1394 Bytes	20.833936 Mbps
IPTV HDTV (MPEG-4)	100/1000 Mbps	1394 Bytes	10.744681 Mbps

- **Jitter Pass/Fail Verdict:** Enable **Jitter Pass/Fail Verdict** to display Jitter Pass/Fail Verdict on Jitter/Latency results page.

**Threshold:** When the **Jitter Pass/Fail Verdict** is enabled, Threshold value can be set in milliseconds. **Jitter Pass/Fail Verdict** is declared as **PASS** when the maximum jitter value is smaller than or equal to the threshold. **Jitter Pass/Fail Verdict** is declared as **FAIL** when the maximum jitter value is greater than the threshold.

## Latency Configuration

- **Latency:** The **Latency** parameter allows to enable or disable the Latency proprietary information insertion in the payload.

**Note:** *If **Disabled** is selected, the Latency meter is disabled. See **Latency** on page 157.*

- **Latency Pass/Fail Verdict:** Enable **Latency Pass/Fail Verdict** to display Latency Pass/Fail Verdict on the Jitter/Latency results page.

**Threshold:** When the **Latency Pass/Fail Verdict** is enabled, Threshold value can be set in milliseconds. **Latency Pass/Fail Verdict** is declared as **PASS** when the maximum latency value is smaller than or equal to the threshold. **Latency Pass/Fail Verdict** is declared as **FAIL** when the maximum latency value is greater than the threshold.

## Transmit Configuration

The transmit configuration allows to configure the background stream properties.

Press , select **Traffic Generation & Monitoring, Background Streams Config**, and the **Transmit** tab.

- **Background Stream:** Select any of the three background streams for which the parameters are to be configured.
- **TX:** Enable or disable the selected background stream transmission. The default setting is **Enabled**.
- **Framing:** Select **Ethernet**, **Ethernet/IPv4/UDP** or **Ethernet/IPv6/UDP**. The default value is **Ethernet**.
- **Frame size (Bytes):** Set the frame size for **Ethernet** and **Ethernet/IPv4/UDP** or **Ethernet/IPv6/UDP** frame structure. The default value will be equal to the minimum frame size or to 64 bytes if the minimum frame size is under 64 bytes. The minimum frame size varies with the framing selection and the number of VLAN layers configured.

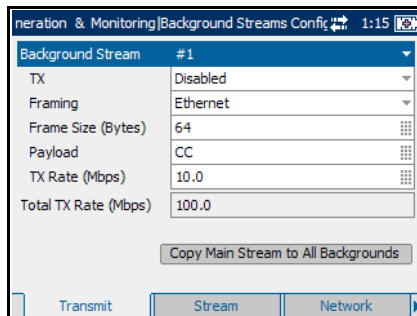

The following table displays the minimum and maximum frame size:

Frame Type	VLAN Configuration	Minimum Frame Size (Bytes)	Maximum Frame size (Bytes)
Ethernet	No VLAN	48	9600
	One VLAN	48	9600
	Two VLAN	48	9600
Ethernet/IPv4/UDP	No VLAN	52	9600
	One VLAN	56	9600
	Two VLAN	60	9600
Ethernet/IPv6/UDP	No VLAN	72	9600
	One VLAN	76	9600
	Two VLAN	80	9600

- **Payload:** Set the **Payload** of the frames in hexadecimal format. The accepted range is from **00** to **FF**. The default value is **CC**.
- **TX Rate:** Set the transmission rate in terms of a percentage of the line rate or in Mbps.
- **Total TX Rate:** The Total TX Rate indicates the sum of the transmit rate of all streams enabled for transmission.
- **Copy Main Stream to All Backgrounds:** Select the **Copy Main Stream to All Backgrounds** button to copy main stream and interface setup configuration parameters to background streams configuration.

### Stream Configuration

The stream configuration parameters define the Ethernet, UDP, and IP layer header values for background streams.

Press , select **Traffic Generation & Monitoring, Background Stream Config**, and the **Stream** tab.

**Note:** Only **Background Stream** and **Destination MAC Address** is configurable, if **Ethernet framing** is selected in **Global Configuration**.

- **Background Stream:** Select any of the three background streams for which the stream parameters are to be configured.
- **Destination MAC Address:** Enter the MAC address if the **Resolve MAC Address** is disabled. The MAC address range is from **00:00:00:00:00:00** to **FF:FF:FF:FF:FF:FF**. The default value is **FE:FE:FE:FE:FE:FE**.

When the **Destination MAC Address** field is selected for editing, the **Latest MAC's** button appears on the bottom left corner of the screen. Press the corresponding function key to display the list of previously configured MAC addresses. Select the desired MAC address from the list, if any.

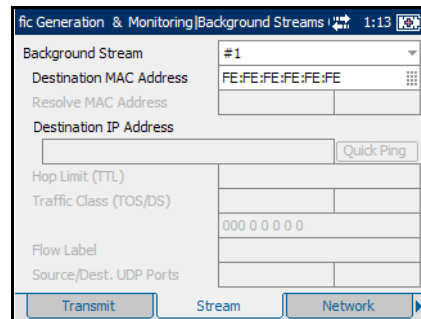
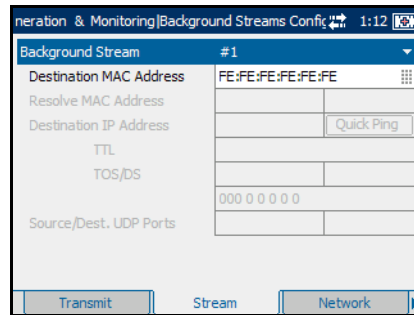



- **Resolve MAC Address:** Enable or disable **Resolve MAC Address**. The default setting is **Disabled**.

When enabled, an ARP request is sent to the network to retrieve the MAC Address corresponding to the selected IP address for IPv4.

When enabled, a Neighbor Solicitation request is sent to the network to retrieve the MAC Address corresponding to the selected IP address for IPv6.

If not resolved after 3 seconds, it gives status as **Failed**. If the MAC address is resolved then the status is displayed as **Resolved**. The status field also displays "--" when the **Resolve MAC Address** is disabled, and other status includes **Failed**, **Not Resolved**, and **Resolved**. The default status is "--".

- **Destination IP Address:** Configure the destination IP address in the **Destination IP Address** field.

The default setting for IPv4 is **10.10.0.0** or is set automatically to the IP address of the target module from the Remote Loopback mode. The destination IP address is configured only when **Ethernet/IPv4/UDP** is selected.

The default setting for IPv6 is **2001:0000:0000:0000:0000:0000:0000:0000** or is set automatically to the IP address of the target module from the Remote Loopback mode. The destination IP address is configured only when **Ethernet/IPv6/UDP** is selected.

The accepted range for IPv4 is **0.0.0.0** to **255.255.255.255**. The default value is **0.0.0.0**.

The **IPv6 Address** can either be the **Link-Local IPv6 Address** or the **Global IPv6 Address**.

The acceptable range for IPv6 is from **000:0000:0000:0000:0000:0000:0000:0001** to **FFFF:FFFF:FFFF:FFFF:FFFF:FFFF:FFFF:FFFF**.

## Traffic Generation & Monitoring

### Stream Configuration

---

- **Quick Ping:** Select the **Quick Ping** button to test if destination IP address can be reached. A message will be returned to indicate if the **Ping** attempt was **Successful** or **Failed**.
- **TTL** for IPv4 and **Hop Limit (TTL)** for IPv6  
Enter the Time to Live (**TTL**) value. The accepted range is from **0** to **255** with a default of **128**.
- **TOS/DS** for IPv4 and **Traffic Class (TOS/DS)** for IPv6  
Select Type of Service (**TOS**) or Differentiated Services (**DS**).

**Note:** *It is possible to configure the **TOS/DS** parameter using either the hexadecimal code (**00** to **FF**) or **TOS/DS** using binary code.*

- If **TOS** is selected, go to the next field to enter the hexadecimal code **00** to **FF** or go to the field underneath to enter the binary code.

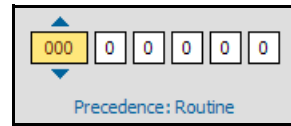

The image shows a configuration field for TOS/DS. It features a dropdown menu with '000' selected, followed by five input boxes containing '0'. Below the input fields, the text 'Precedence: Routine' is displayed in blue.

The possible values are shown as follows:

Parameter	Value	Bit
Precedence	000 (Routine), 001 (Priority), 010 (Immediate), 011 (Flash), 100 (Flash Override), 101 (CRITIC/ECP), 110 (Internet Control), 111 (Network Control) Default: 000 (Routine)	1-3
Throughput	Normal / High (0/1) Default: Normal	4
Monetary Cost	Normal / Low (0/1) Default: Normal	5
Delay	Normal / Low (0/1) Default: Normal	6
Reliability	Normal / High (0/1) Default: Normal	7
Reserved bit	0 or 1 Default: 0	8

- If **DS** is selected, go to the next field to enter the hexadecimal code **00** to **FF** or go to the field underneath to enter the binary code.

The image shows a configuration interface for DSCP Codepoints. It features a yellow input field containing the hexadecimal value '000000' and a white input field containing the binary value '00'. Below these fields, the text 'DSCP Codepoints: CS0' is displayed. The interface includes up and down arrow buttons above the yellow field.

## Traffic Generation & Monitoring

### Stream Configuration

---

The possible values are shown as follows:

Parameter	Value	Bit
DSCP Codepoints	000000 (CS0), 001000 (CS1), 010000 (CS2), 011000 (CS3), 100000 (CS4), 101000 (CS5), 110000 (CS6), 111000 (CS7), 001010 (AF11), 001100 (AF12), 001110 (AF13), 010010 (AF21), 10100 (AF22), 010110 (AF23), 011010 (AF31), 011100 (AF32), 011110 (AF33), 100010 (AF41), 100100 (AF42), 100110 (AF43), 101110 (EF), Default: 000000 (CS0)	1-6
ECN	00 (Not-ECT), 01 (ECT-1), 10 (ECT 0), 11 (CE) Default: 00 (Not-ECT)	7-8

- **Flow Label** (For IPv6 only): Enter the **Flow Label** value. The acceptable range is from **0** to **1048575**. The default value is **0**.
- **Source/Destination UDP Ports**: Enter the **Source UDP Port**. The accepted range is from **0** to **65535**. The default value is **49184**. Enter the **Destination UDP Port**. The accepted range is from **0** to **65535**. The default value is **7**.

## Network Configuration

Network Configuration allows to configure the network parameters for the background streams.

Press , select **Traffic Generation & Monitoring, Background Stream Config**, and the **Network** tab.

When IPv4 version is selected, configure the following fields in the **Stream** tab.

- **Background Stream:** Select any of the three background streams for which the network parameters are to be configured.
- **IP Address:** Configure the source **IP Address** for the selected background stream. The default IP address is **10.10.0.0**.
- **Subnet Mask:** Configure the **Subnet Mask** for the selected background stream. The accepted range is from **0.0.0.0** to **255.255.255.255**. The default value is **255.255.0.0**.
- **Default Gateway:** Enable or disable the **Default Gateway**. The default setting is **Enabled**. If enabled, enter the default gateway address for the Ethernet port. The default value is **0.0.0.0**.

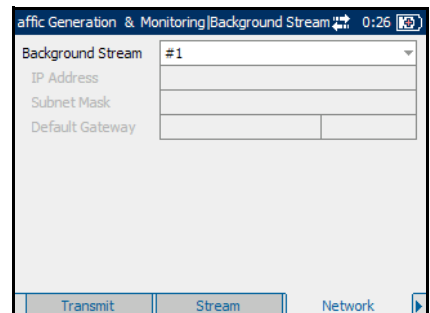

## Traffic Generation & Monitoring

### Network Configuration

When IPv6 version is selected, configure the following fields in the **Stream** tab.

1. **Background Stream:** Select any of the three background streams for which the network parameters are to be configured.
2. **Link-Local IPv6 Address (LLA)** is used for local communication between on-link neighbors and for Neighbor Discovery process.

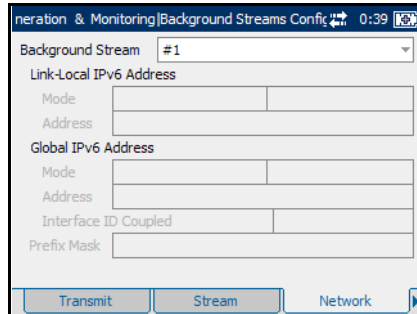

#### Mode

- **StatelessAuto** allows automatic generation of the IPv6 address based on the MAC address. The **mode StatelessAuto** is selected by default.
- **Static** allows to enter the IP Address.

**Address:** This field is configurable only when the **Mode** is **Static**. The **Link-Local IPv6 Address** must start with **FE80**. The accepted range is from **FE80:0000:0000:0000:0000:0000:0000:0000** to **FE80:0000:0000:0000:FFFF:FFFF:FFFF:FFFF**. The default address is **FE80::[Interface ID]**, where **[Interface ID]** is generated from the source MAC address. When the **Address** field is selected for editing, the **Latest IP's** button appears on the bottom of the screen. Press the corresponding function key to display the list of previously configured IP addresses. Select the desired IP address from the list, if any.

3. **Global IPv6 Address (GUA)** is used to communicate with on-link neighbors and for global communication with hosts outside the subnet.

#### Mode

- **None** disables the Global IPv6 address and the Default Gateway address.

- **StatelessAuto** allows automatic generation the IPv6 address based on the Link-Local address interface ID and the prefix obtained from the router advertisements. If no Interface ID has been obtained for the Link Local Address, the Global address will not be generated. The **mode StatelessAuto** is selected by default.
- **Static** allows to enter the IP Address.

**Address:** This field is configurable only when the **Mode** is **Static**. The accepted range is from **0000:0000:0000:0000:0000:0000:0000:0000** to **FEFF:FFFF:FFFF:FFFF:FFFF:FFFF:FFFF:FFFF**. The default address is **2001::[Interface ID]**, where the **[Interface ID]** is generated from the source MAC address. When the IP Address field is selected for editing, the **Latest IP's** button appears on the bottom of the screen. Press the corresponding function key to display the list of previously configured IP addresses. Select the desired IP address from the list, if any.

- **Interface ID Coupled:** This field is available when the **Global IPv6 Address Mode** is **Static**. This field allows to couple the interface ID of the Global address to the Link-Local source address. **Enable** or **Disable** the **Interface ID Coupled**. The default setting is **Enabled**.

When the Interface ID Coupled is **Enabled**, only the 64 bit (MSB) prefix ID in the IPv6 address is configurable, and the 64 bit (LSB) Interface ID is not configurable (read-only).

When the Interface ID Coupled is **Disabled**, the 64 bit (MSB) Prefix ID and 64 bit (LSB) Interface ID in the IPv6 address are configurable.

4. Enter the **Prefix Mask**. This field is only configurable when the Global IPv6 Address Mode is **Static**. It allows to specify a prefix that defines the subnet. The accepted range is **0000:0000:0000:0000:0000:0000:0000:0000** to **FFFF:FFFF:FFFF:FFFF:0000:0000:0000:0000**. For example:

Global Address: 2001:0DB8:0001:0002:02AA:00FF:FE11:1111

Prefix Mask: FFFF:FFFF:FFFF:0000:0000:0000:0000:0000

Corresponding Prefix: 2001:0DB8:0001

## Traffic Generation & Monitoring

### Network Configuration

---

#### ***Link-Local/Global IPv6 Address Status***

<b>Mode</b>	<b>Status</b>	<b>Description</b>
StatelessAuto	--	Undefined
	Generating	Stateless address autoconfiguration in progress.
	Successful	IP address has been generated but duplication has been detected.
	Duplication Detected	IP address has been generated but duplication has been detected
Static	--	Undefined
	DAD Checking	Duplication address detection in progress.
	No Duplication	No duplication has been detected.
	Duplication Detected	Duplication has been detected. Note that duplicated address is not assigned to the interface and consequently unspecified (::) is assumed.



## Default Gateway

The **Default Gateway** tab allows the configuration of the default gateway address to forward packets outside the subnet.

Press , select **Traffic Generation & Monitoring, Background Stream Config**, and the **Default Gateway** tab.

**Note:** The **Default Gateway** tab is only available when the selected IP version is IPv6. See *IP Version* on page 37 to select IPv6 version

- **Background Stream:** Select any of the three background streams for which the network parameters are to be configured.

- **Mode:**

**Automatic** allows automatic selection of the default gateway. The default setting is **Automatic**.

**Static** allows entering the default gateway IP address.

- **Address:** If the **Mode** is **Static**, enter the IP address of the **Default Gateway**. The accepted range is from **FE80:0000:0000:0000:0000:0000:0000** to **FE80:0000:0000:0000:FFFF:FFFF:FFFF:FFFF**. The default address is **FE80:0000:0000:0000:0000:0000:0000:0000**. When the **Mode** is **Automatic**, the address field is not configurable.

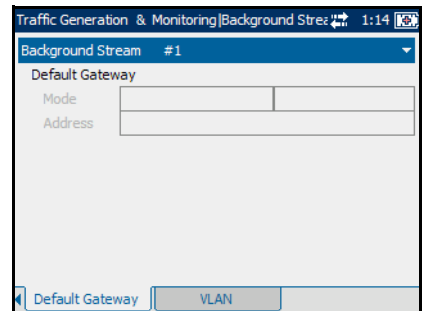

## Traffic Generation & Monitoring

### Default Gateway

---

#### **Default Gateway Address Status**

<b>Status</b>	<b>Description</b>
--	Undefined
Checking	Detection in progress to determine if the Default Gateway is reachable or not.
Unreachable	Default Gateway is unreachable.
Reachable	Default Gateway is reachable.

## VLAN Configuration

VLAN Configuration page allows the user to configure the layers, its priority, type, and drop eligible.

Press , select **Traffic Generation & Monitoring, Background Stream Config**, and the **VLAN** tab.

### To configure VLAN settings:

1. Select the **Background Stream** for which VLAN parameters are to be configured.
2. Select the number of **VLAN layers** for which VLAN parameters are to be configured. Choices are **None**, **1 Layer**, and **2 Layers**.
3. Enter the **VLAN ID**. The accepted range is from **0** to **4095**. The default value is **2**. See *VLAN* on page 242.
4. Select the **VLAN Priority**. The accepted range is from **0** to **7**. The default value is **0** (Low priority). See *VLAN* on page 242.
5. Select the **VLAN Type**. Choices for VLAN Ethernet type are **8100**, **88A8**, **9100**, **9200**, and **9300**. The default value is **8100** for **VLAN 1** and **88A8** for **VLAN 2**.
6. The **Drop Eligible** parameter allows the Service VLAN tag (S-TAG) to convey eight distinct priorities, each with a drop eligible indication. When enabled (DEI = 1), the drop eligible parameter is encoded in the DEI of transmitted frames. The drop eligible parameter should be enabled for a received frame if the DEI is set in the S-TAG or if the Priority Code Point Decoding Table indicates drop eligible enabled for the received PCP value. When disabled (DEI=0), the DEI is ignored on receipt. Drop Eligible is not available when VLAN type is 8100. This setting is disabled by default.

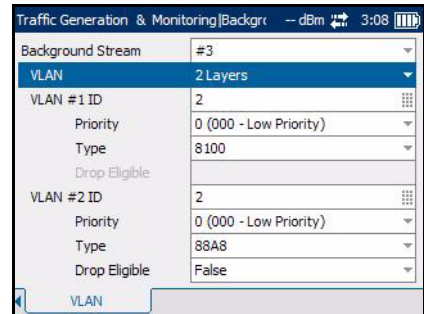

## Summary Results

Press , select **Traffic Generation & Monitoring, Results**, and the **Summary** tab.



### IMPORTANT

Test results/statistics are cleared when changing test or tool selection. It is highly advised to generate and save the report once the current test is completed. Refer to *Report Generation* on page 79 to generate and save a report file.

- **Status:** The status field displays the current status of the traffic generation test. The Pass/Fail Verdict is displayed on the screen with the help of the following symbols:

 = PASS

 = FAIL

The status displays the following:

- “--”: Test is not running and results are not available.
- **In-Progress:** Test is running.
- **Completed:** Test is completed, stopped at the planned time, or manually stopped when there is no set timer.
- **Aborted:** Test is interrupted, test is stopped before the set time.
- **Start Time:** The time when the Traffic Generation and Monitoring test was started.

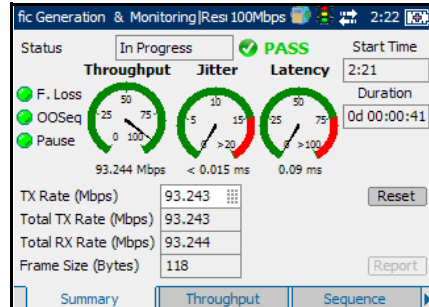

- **Frame Loss (F.Loss):** A frame loss event is declared when a sequence number is not received after 20 ms of the previously received frame or packet.
- **Out-of-Sequence (OOSeq):** An out-of-sequence event is declared when the received frame sequence number is smaller than the expected frame sequence number.
- **Pause:** Pause frames are received to declare the event when valid flow control frames are injected to interrupt the packet transmission for the requested pause time.

## Traffic Generation & Monitoring

### Summary Results

---

The Alarm LEDs are described as follows:

LED Label	Color	Meaning
Frame Loss (F.Loss)	Green	No frame loss declared.
	Red	Frame loss declared in the last second.
	Amber	Frame loss was declared (History).
	Black	Not applicable.
Out-of-Sequence (OOSeq)	Green	No out-of-sequence declared.
	Red	Out-of-sequence declared in the last second.
	Amber	Out-of-sequence was declared (History).
	Black	Not applicable.
Pause	Green	No pause frames received.
	Red	At least one pause frame received in the last second.
	Amber	At least one pause frame has been received since the beginning of the test.
	Black	Not applicable.

- **Duration:** The length of time from when the test was started, until when the test was completed.
- **Throughput:** Throughput meter displays current RX rate of the main stream graphically. The green region is delimited by the minimum and maximum thresholds corresponding to a **PASS** verdict. The red regions beyond the minimum and maximum thresholds corresponds to a **FAIL** verdict.

- **Jitter:** The Jitter meter displays current Jitter Statistics of the main stream graphically. The green region as shown in the graph corresponds to a **PASS** verdict and the red region corresponds to a **FAIL** verdict.

**Note:** *If **Jitter** is disabled, the Jitter meter will also be disabled.*

- **Latency:** The Latency meter displays current Latency Statistics of the main stream graphically. The green region as shown in the graph corresponds to a **PASS** verdict and the red region corresponds to a **FAIL** verdict.

**Note:** *If **Latency** is disabled, the Latency meter will also be disabled.*

- **TX Rate:** Configure the main stream transmission rate in terms of a percentage of the line rate or Mbps.

## Traffic Generation & Monitoring

### Summary Results

- **Frame size (Bytes):** Set the frame size for **Ethernet** and **Ethernet/IPv4/UDP** or **Ethernet/IPv6/UDP** frame structure. The default value for **Ethernet/IPv4/UDP** framing mode is **64 bytes**. The default value for **Ethernet/IPv6/UDP** framing mode is **70 bytes**. The minimum frame size varies with the framing selection and the number of VLAN layers configured.

The following table displays the minimum and maximum frame size:

Frame Type		Minimum Frame Size (Bytes)								Maximum Frame Size (Bytes)	
		Jitter	Yes				No				
		Latency	Yes		No		Yes		No		
		Sequence Tracking	Yes	No	Yes	No	Yes	No	Yes		No
Ethernet	No VLAN	98	84	84	70	80	66	66	48	9600	
	One VLAN	102	88	88	74	84	70	70	48	9600	
	Two VLAN	106	92	92	78	88	74	74	48	9600	
Ethernet /IPv4/UDP	No VLAN	98	84	84	70	80	66	66	52	9600	
	One VLAN	102	88	88	74	84	70	70	56	9600	
	Two VLAN	106	92	92	78	88	74	74	60	9600	
Ethernet /IPv6/UDP	No VLAN	118	104	104	90	100	86	86	72	9600	
	One VLAN	122	108	108	94	104	90	90	76	9600	
	Two VLAN	126	112	112	98	108	94	94	80	9600	



**Note:** *The frame size can be changed for Ethernet frames even when test is running.*

- **Total TX Rate:** The **Total TX Rate** displays the sum of the transmit rate of all streams enabled for transmission.
- **Total RX Rate:** The **Total RX Rate** displays the sum of the receive rate of all streams enabled for transmission.
- **Report:** Select the **Report** button to generate the report of the results. Refer to *Report Generation* on page 79 to generate and save a report file.

### Report Generation

Reports can be generated for the test and tools results. The report button is available on the **BERT**, **Traffic Generation & Monitoring, RFC 2544** summary tabs, and **Ping**, **Trace Route**, and **Cable Test** result tabs.

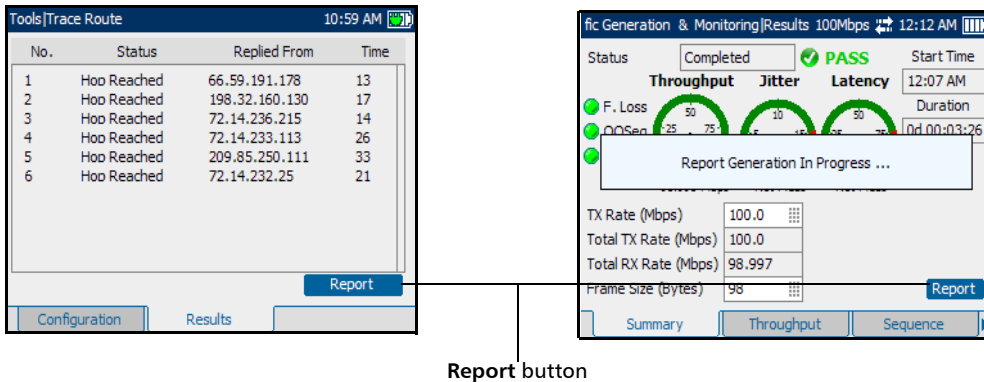

Report button

#### To generate a report:

1. Select the **Report** button from the **Results** page, if not already selected, and press the **✓** button.
2. The report is being generated and is displayed on screen.
3. Press the **✓** button to select the report section, and use the up and down arrows to scroll through the report.
4. Press the **↶** button to have access to the function keys.
5. Press **Bottom** to move to the bottom of the page.

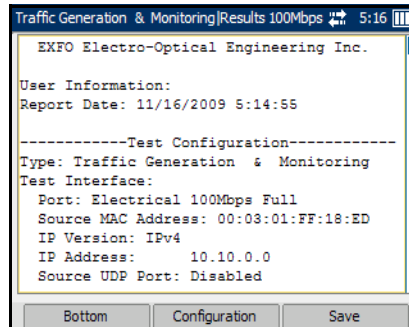

**Note:** When the bottom of the page is displayed, **Bottom** changes to **Top**.

6. Press the function key under **Configuration** on the bottom of the screen to configure the titles and headings of the report.
7. Customize the following fields. Refer to *Report Configuration* on page 207 for information on the parameters:

- **Report Header**
- **Report Title**
- **User Information**
- **File Name**

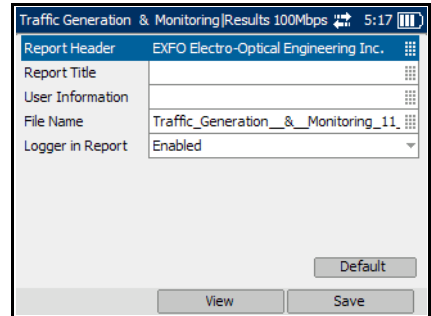

- **Logger in Report:** Allows to enable or disable the Logger section in Report. Choices are **Enabled** and **Disabled**. The default setting is **Enabled**. If **Disabled**, the Logger section will not be displayed in the report.

If **Enabled**, the report generated will display the Logger section at the bottom of the page as shown in the figure.

**Note:** *The report page lists the events in incremental order.*

8. Select **Default** to revert all parameters back to the default settings.

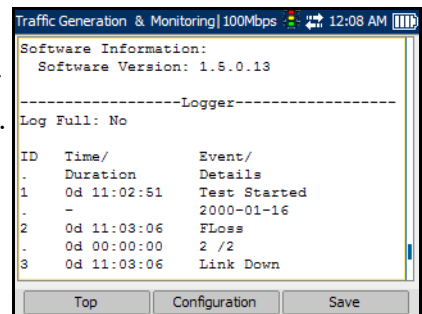

## Traffic Generation & Monitoring

### Summary Results

---

9. Select **View** to display the changes on the report file.

10. Select **Save** to save the report file.

The report will be saved on the selected media. Refer to *Media Selector* on page 207.

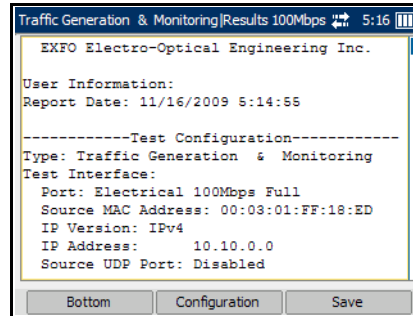

11. A message is displayed to indicate that the report file is successfully saved.

12. Select the **OK** button by pressing the function key underneath it. Use the navigation arrows to scroll up and down the page to view the report.

13. To exit the report page, press the **↶** button.

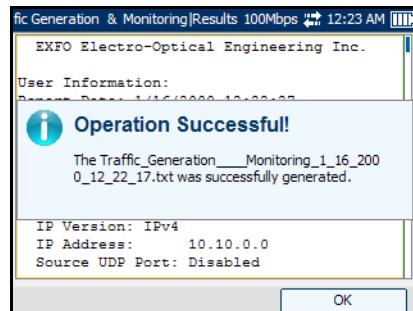

## Throughput Results

Press , select **Traffic Generation & Monitoring, Results**, and the **Throughput** tab.

- **TX Rate:** Displays the transmission rate in terms of a percentage of the line rate or Mbps. The transmit rate is displayed individually for main stream and each background stream.
- **RX Rate:** Displays the receive rate in terms of a percentage of the line rate or Mbps. The receive rate is displayed individually for main stream and each background stream.
  - **Current:** Displays average RX rate value of the last second.
  - **Average:** Displays average RX rate value from the beginning of the test.
  - **Minimum:** Displays minimum RX rate value from the beginning of the test.
  - **Maximum:** Displays maximum RX rate value from the beginning of the test.
  - **Threshold Min:** Set the minimum threshold value. The accepted range is **0.0** to **100.0** in percentage (**0** to **10** in Mbps). The default value in percentage is **0.0** and in Mbps is **0**.
  - **Threshold Max:** Set the maximum threshold value. The accepted range is **0.0** to **100.0** in percentage (**0** to **10** in Mbps). The default value in percentage is **100.0** and in Mbps is **10**.

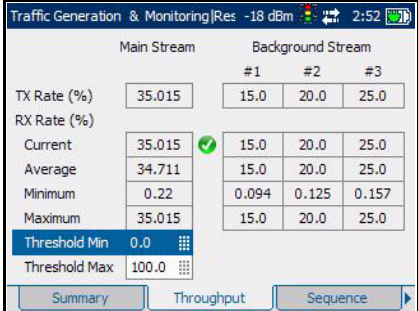

Main Stream		Background Stream		
		#1	#2	#3
TX Rate (%)	35.015	15.0	20.0	25.0
RX Rate (%)				
Current	35.015 	15.0	20.0	25.0
Average	34.711	15.0	20.0	25.0
Minimum	0.22	0.094	0.125	0.157
Maximum	35.015	15.0	20.0	25.0
Threshold Min	0.0			
Threshold Max	100.0			

Summary    Throughput    Sequence

## Traffic Generation & Monitoring

### Throughput Results

---

**Note:** *When the Throughput Pass/fail verdict is selected as the Current RX Rate, the Pass/Fail Verdict is declared as Fail as soon as the test-stream current receive rate is over the maximum threshold or below the minimum threshold.*

**Note:** *When the Throughput Pass/fail verdict is selected as the Average RX Rate, the Pass/Fail Verdict is declared as Fail as soon as the test-stream average receive rate is over the maximum threshold or below the minimum threshold. The Pass/Fail Verdict is evaluated every second and the final Pass/Fail Verdict correspond to the verdict at the last second of the test. See Throughput Pass/Fail Verdict on 127.*

## Sequence Results

Press , select **Traffic Generation & Monitoring, Results**, and the **Sequence** tab.

### Statistics for Frame Loss Parameters

Frame Loss is declared when a missing sequence number is not received within the next 20 ms. The frame loss parameters are applied to the main stream only.

- **Seconds:** Displays the total number of seconds in which one or more Frame Loss event occurred.
- **Count:** Displays the total number of times the Frame Loss event occurred.
- **Rate:** Displays the rate of frames that are lost during transmission.
- **Threshold:** Set the threshold value for Count or Rate as per the selected type of verdict. See Frame Loss Pass/Fail Verdict on page 134.

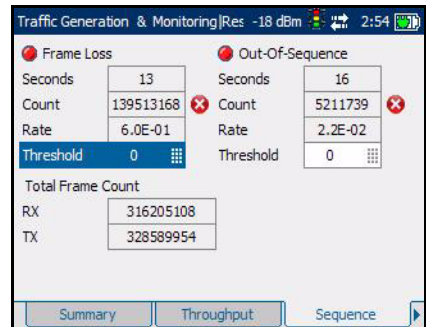

 = PASS

 = FAIL

## Traffic Generation & Monitoring

### *Sequence Results*

---

The Alarm LEDs are described as follows:

<b>LED Label</b>	<b>Color</b>	<b>Meaning</b>
Frame Loss	Green	No frame loss declared.
	Red	Frame loss declared in the last second.
	Amber	Frame loss was declared (History).
	Black	Not applicable.



## Statistics for Out-Of-Sequence Frames

Out-Of-Sequence is declared when a frame/packet has its sequence number smaller than the previously received frame/packet. The out-of-sequence parameters are applied to the main stream only.

- **Seconds:** Displays the total number of seconds in which one or more Out-Of-Sequence event occurred.
- **Count:** Displays the total number of times the Out-Of-Sequence event occurred.
- **Rate:** Displays the rate of frames that are received out of order.
- **Threshold:** Set the threshold value for Count or Rate as per the selected type of verdict. See Out-Of-Sequence Pass/Fail Verdict on page 135.

 = PASS

 = FAIL

## Traffic Generation & Monitoring

### Sequence Results

---

The Alarm LEDs are described as follows:

LED Label	Color	Meaning
Out-of-Sequence	Green	No out-of-sequence declared.
	Red	Out-of-sequence declared in the last second.
	Amber	Out-of-sequence was declared (History).
	Black	Not applicable.

### Statistics for Total Frame Count

- **RX:** Displays the total number of frames that are received.
- **TX:** Displays the total number of frames that are transmitted.

## Jitter/Latency Results



Press , select **Traffic Generation & Monitoring, Results**, and the **Jitter/Latency** tab.

**Note:** The Jitter/Latency parameters are calculated for the main stream only.

### Jitter Statistics:

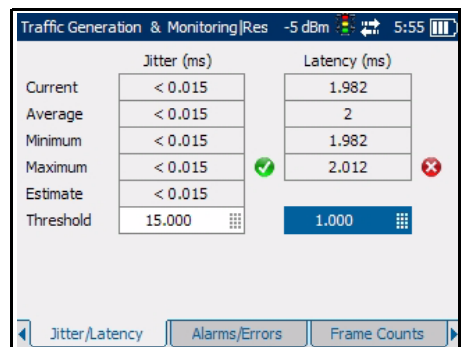
- **Current:** Displays average of the measured delay variation values of the last second for the main stream.
- **Average:** Displays average of the measured delay variation values from the beginning of the test for the main stream.



	Jitter (ms)	Latency (ms)
Current	< 0.015	1.982
Average	< 0.015	2
Minimum	< 0.015	1.982
Maximum	< 0.015 	2.012 
Estimate	< 0.015	
Threshold	15.000	1.000

- **Minimum:** Displays minimum measured delay variation value from the beginning of the test for the main stream.
- **Maximum:** Displays maximum measured delay variation value from the beginning of the test for the main stream.
- **Estimate:** Displays last jitter estimate value based on an exponential filter of 1/16 for the main stream.
- **Threshold:** When the **Jitter Pass/Fail Verdict** is enabled, Threshold value can be set in milliseconds. Jitter Pass/Fail verdict is declared as **PASS** when the maximum jitter value is smaller than or equal to the threshold. Jitter Pass/Fail verdict is declared as **FAIL** when the maximum jitter value is greater than the threshold.

### **Latency Statistics:**

- **Current:** Displays average of the measured delay values of the last second.
- **Average:** Displays average of the measured delay values from the beginning of the test.
- **Minimum:** Displays minimum measured delay value from the beginning of the test.
- **Maximum:** Displays maximum measured delay value from the beginning of the test.
- **Threshold:** When the **Latency Pass/Fail Verdict** is enabled, Threshold value can be set in milliseconds. Latency Pass/Fail verdict is declared as **PASS** when the maximum latency value is smaller than or equal to the threshold. Latency Pass/Fail verdict is declared as **FAIL** when the maximum latency value is greater than the threshold.

**Note:** *Delay variation measurements smaller than 15 us are discarded.*

**Note:** *Only the round-trip latency can be measured (loopback testing topology).*

### Alarms/Errors Results









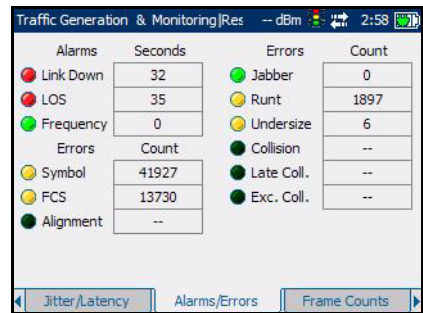



Press , select **Traffic Generation & Monitoring, Results**, and the **Alarms/Errors** tab.

The Alarms/Errors page displays the alarms and errors with green, red, or amber indicators. The error count and the amount of time in seconds that the alarm remained raised during the test execution is also displayed. The description of each alarm and error is described as follows:

#### Alarms

- **Link Down:** Indicates that the Ethernet connection is down. The Ethernet connection is down when there is local or remote fault condition.
- **LOS:** Indicates a loss of signal on the optical port.
- **Frequency:** A frequency alarm is raised when the frequency offset of receiving signal is over the standard limit ( $\pm 100$  ppm).



Alarms	Seconds	Errors	Count
 Link Down	32	 Jabber	0
 LOS	35	 Runt	1897
 Frequency	0	 Undersize	6
Errors		 Collision	--
 Symbol	41927	 Late Coll.	--
 FCS	13730	 Exc. Coll.	--
 Alignment	--		

**Note:** The total number of alarmed seconds for Link Down, LOS, and Frequency is recorded and displayed in the field next to the alarm name.

**Note:** Alarms/Errors are updated only during test execution.

## Traffic Generation & Monitoring

### Alarms/Errors Results

---

The **Alarm** LEDs are described as follows:

LED Label	Color	Meaning
Link Down	Green	Link up.
	Red	Link down (Current).
	Amber	Link down was present (History).
	Black	Not applicable.
LOS (loss of signal)	Green	No LOS is present during test.
	Red	LOS alarm is present (Current).
	Amber	LOS was present (History).
	Black	Not applicable.
Frequency	Green	No frequency offset alarm is present during the test.
	Red	Frequency offset alarm is present (Current).
	Amber	Frequency offset alarm was present (History).
	Black	Not applicable.

## Errors

- **Symbol:** A symbol error is declared when an invalid code group in the transmission is detected.
- **FCS:** The number of received frames with invalid FCS.
- **Alignment:** Indicates the number of received frames without an integral number of octets in length.
- **Jabber:** The number of received frames larger then 1518 (no VLAN tag), 1522 (One VLAN tag) or 1526 (Two VLAN tags) bytes with invalid FCS.

- **Runt:** The number of received frames that are smaller than 64 bytes with invalid FCS.
- **Undersized** number of received frames that are smaller than 64 bytes with valid FCS.

The following errors are available with half duplex mode (only for electrical interface at speeds of 10 and 100 Mbps).

- **Collision:** Indicates the number of collisions on the link.
- **Late Coll:** Indicates the number of collisions that have occurred after a 64 byte transmission.
- **Exec. Coll:** Indicates the number of frames that were sent 16 times unsuccessfully due to consecutive collisions.

The **Errors** LEDs are described as follows:

Color	Meaning
Green	No error.
Red	A test is running and there is at least one error present (Current).
Amber	There was at least 1 error reported (History).
Black	Not applicable.

## Frame Count Results

Press , select **Traffic Generation & Monitoring, Results**, and the **Frame Count** tab.

- **Multicast:** Displays the number of multicast frames transmitted and received with a valid FCS and multicast destination MAC address.
- **Broadcast:** Displays the number of broadcast frames transmitted and received with a valid FCS and broadcast destination MAC address.
- **Unicast:** Displays the number of unicast frames transmitted and received with a valid FCS and a unicast destination MAC address.
- **Non-Unicast:** Displays the sum of multicast and broadcast frames with a valid FCS.
- **Total:** Displays the total number of frames transmitted and received with a valid FCS.

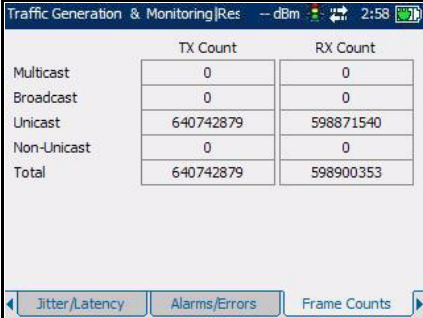

The screenshot shows a window titled "Traffic Generation & Monitoring|Res" with a status bar at the top displaying "-- dBm", signal strength icons, and the time "2:58". The main content area displays a table with two columns: "TX Count" and "RX Count". The rows are: Multicast (0, 0), Broadcast (0, 0), Unicast (640742879, 598871540), Non-Unicast (0, 0), and Total (640742879, 598900353). At the bottom, there are three tabs: "Jitter/Latency", "Alarms/Errors", and "Frame Counts", with "Frame Counts" being the active tab.

	TX Count	RX Count
Multicast	0	0
Broadcast	0	0
Unicast	640742879	598871540
Non-Unicast	0	0
Total	640742879	598900353



### Frame Size Results

Press , select **Traffic Generation & Monitoring, Results**, and the **Frame Size** tab.

- **RX Count:** The **RX Count** parameter gives the count of each received frames (with or without FCS error).
- **%:** The **%** parameter gives the percentage ratio of each received frames (with or without FCS error) based on the total count of frames.

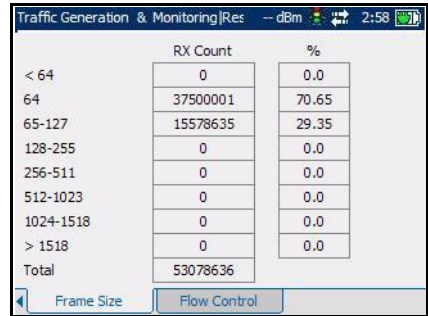

	RX Count	%
< 64	0	0.0
64	37500001	70.65
65-127	15578635	29.35
128-255	0	0.0
256-511	0	0.0
512-1023	0	0.0
1024-1518	0	0.0
> 1518	0	0.0
Total	53078636	

## Traffic Generation & Monitoring

### Frame Size Results

---

The following table displays the received frame size count statistics:

Frame size	Description
<64	The total number of frames received with an Ethernet frame size smaller than 64 bytes
64	The total number of frames received with an Ethernet frame size of 64 bytes
65-127	The total number of frames received with an Ethernet frame size greater than 64 bytes but smaller than 128 bytes
128-255	The total number of frames received with an Ethernet frame size greater than or equal to 128 bytes but smaller than 256 bytes
256-511	The total number of frames received with an Ethernet frame size greater than or equal to 256 bytes but smaller than 512 bytes
512-1023	The total number of frames received with an Ethernet frame size greater than or equal to 512 bytes but smaller than 1024 bytes
1024-1518	The total number of frames received with an Ethernet frame size greater than or equal to 1024 bytes but smaller than or equal to 1518 bytes
>1518	The total number of frames received with an Ethernet frame size greater than 1518 bytes
Total	The total number of frames received

## Flow Control Results

Press , select **Traffic Generation & Monitoring, Results**, and the **Flow Control** tab.

### Statistics for Pause Time

- **Maximum:** Displays the maximum pause time received from the link partner.
- **Total:** Displays the total of all pause time received from the link partner.
- **Unit:** Select the unit to determine the total pause time and maximum pause time. Choices are **Quanta** and **ms**. The default setting is **Quanta**.

1 Quanta = 512 bits-time

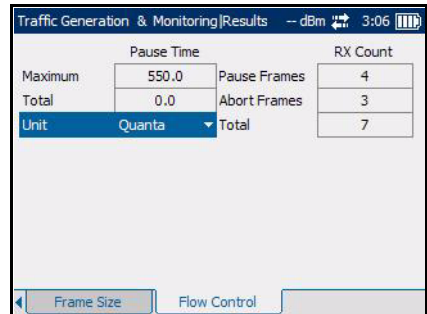

The screenshot shows a window titled "Traffic Generation & Monitoring|Results" with a status bar indicating "-- dBm" and "3:06". The main content area displays statistics for "Pause Time" and "RX Count".

Pause Time		RX Count	
Maximum	550.0	Pause Frames	4
Total	0.0	Abort Frames	3
Unit	Quanta	Total	7

At the bottom of the window, there are tabs for "Frame Size" and "Flow Control".

### Statistics for RX Count

- **Pause Frames:** Displays the total number of valid flow control frames received, excluding Abort Frames RX.
- **Abort Frames:** Displays the total number of valid Flow Control frames received that contained a zero value of Pause Time.
- **Total:** Displays the total number of valid flow control frames received including Abort Frames RX.

### Logger

The Logger page allows the user to configure and view the Logger events based on Event ID, Time, Event, Duration and Details.

Press , select **Traffic Generation & Monitoring**, and **Logger**.

- **Sort By:** Select the **Sort By** parameter to sort the events. Choices are **ID/Time** and **Event**. The default setting is **ID/Time**.

When the **Sort By** parameter is set to **ID/Time**, the Event Logger entries will be displayed in numeric ascending order based on the ID field of the Event Logger table.

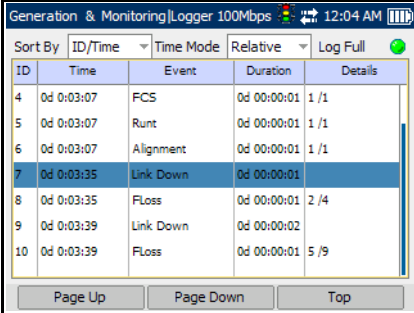

ID	Time	Event	Duration	Details
4	0d 0:03:07	FCS	0d 00:00:01	1 / 1
5	0d 0:03:07	Runt	0d 00:00:01	1 / 1
6	0d 0:03:07	Alignment	0d 00:00:01	1 / 1
7	0d 0:03:35	Link Down	0d 00:00:01	
8	0d 0:03:35	FLoss	0d 00:00:01	2 / 4
9	0d 0:03:39	Link Down	0d 00:00:02	
10	0d 0:03:39	FLoss	0d 00:00:01	5 / 9

When the **Sort By** parameter is set to **Event**, the Event Logger entries will be displayed in alphanumeric ascending order based on the type of events.

- **Time Mode:** Select the mode of time representation. Choices are **Relative** and **Absolute**. The default setting is **Relative**.
  - **Relative:** Displays the time relative to the beginning of the test or the last test results reset. The format of the time is Dd HH:MM:SS.
  - **Absolute:** Displays the time relative to the test start time and start date. The time format depends upon the platform time.

When the platform is configured in 24 hours time format, the time format in the **Time** column will be MM/DD HH:MM:SS.

When the platform is configured in 12 hours time format, the time format in the **Time** column will be MM/DD HH:MM:SS <AM or PM>.

- **Log Full:** Indicates that the logger exceeds its maximum of 500 entries. The Log Full indicator can have three conditions:

Color	Condition
Green	Log not full
Red	Log full
Black	Test not started

The Logger table provides the Event Logger information with the following columns:

- **ID:** Indicates the event identification number. The events are sequentially numbered.
- **Time:** Indicates when the event has been detected.
- **Event:** Provides the event type and threshold crossing information.
- **Duration:** Indicates the number of seconds within which the event occurred.

**Note:** *The test events like Test Started and Test Stopped will have no duration.*

- **Details:** Provides contextual information.

## Traffic Generation & Monitoring

### Logger

---

The following table displays the nature of information reported by type of event:

Type of Event	Nature of Information
Test Started	Start Date
Test Stopped	Pass/Fail Verdict
Alarm Events	None
Current Throughput Threshold Minimum Crossing Event	Minimum value while under the threshold
Current Throughput Threshold Maximum Crossing Event	Maximum value reach while above the threshold
Average Throughput Threshold Minimum Crossing Event	Value at the end of the test
Average Throughput Threshold Maximum Crossing Event	Value at the end of the test
Jitter Threshold Crossing Event	Maximum value while above the threshold
Latency Threshold Crossing Event	Maximum value while above the threshold
Frame Loss Rate Threshold Crossing Event	Value at the end of the test
OOSeq Rate Threshold Crossing Event	Value at the end of the test

**Note:** *The alarm events will not display any details.*

**Note:** *The Logger table can display up to 500 event entries. Once the Logger table reports 500 event entries, the **Log Full** indicator will change to Red and no further entries will be possible but the events in the **Pending** state will be updated if a test is running.*

The Event Logger information will be cleared under the following conditions:

- When the test is reset or started.
- When the unit is suspended.
- When stopping the current test and navigating to other tests.
- When the unit is restarted.

**Note:** *The entry remains in the **Pending** state as long as the event is not completed and it is highlighted in **Yellow** color.*

**Note:** *The Threshold Crossing events are displayed in **Red** color.*

The following tabs are displayed at the bottom of the table:

- **Page Up:** Allows to scroll up by one page.
- **Page Down:** Allows to scroll down by one page.
- **Top/Bottom:** Allows to toggle between the top and bottom of the table.

When the bottom of the page is displayed, **Top** changes to **Bottom** and vice versa.

When the top of the page is currently displayed, pressing **Bottom** will display the bottom of the page and vice versa.

The Logger table provides the Auto-Scroll feature. It allows to display the latest events in the table as soon as they occur. Pressing **Bottom** will allow to jump to the last entry.

## Traffic Generation & Monitoring

### Logger

---

Auto-Scroll will be active when:

- The test is running.
- The latest event is being displayed.
- The **Sort By** parameter is set to **ID/Time**.



**Note:** *When a test is started and the **Sort By** parameter is set to **ID/Time**, the Auto-Scroll function is active by default.*



# 11 Smart Loopback

The Smart Loopback test allows looping back an Ethernet data stream simply based on the interface setup parameters. The incoming frames are re-transmitted after exchanging the source and destination addresses at multiple layers (Ethernet MAC, IP, UDP).

## Statistics

Press , and select **Smart Loopback**. Press  to start or stop the test. The Smart Loopback statistics are displayed as follows:

- **Rate Unit:** Select the rate unit as % or Mbps.
- **TX Rate:** Transmission rate as a percentage of the line rate or Mbps.
- **RX Rate:** Receive rate as a percentage of the line rate or Mbps.
- **Total TX Frame Count:** The Total TX frame count includes all frames transmitted (related and not related to the test).
- **Total RX Frame Count:** The Total RX frame count includes all frames received (related and not related to the test).
- **Start Time:** The time when the Smart Loopback test was started.
- **Duration:** The length of time from when the test was started, until when the test was completed.

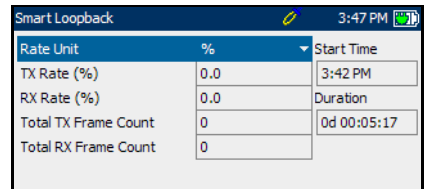

Smart Loopback			3:47 PM
Rate Unit	%	Start Time	
TX Rate (%)	0.0	Duration	3:42 PM
RX Rate (%)	0.0		
Total TX Frame Count	0		0d 00:05:17
Total RX Frame Count	0		

**Note:** *Half duplex mode is not supported while in Smart Loopback.*



# 12 Tools

The tools available on the AXS-200/850 Ethernet Test Set are Ping, Trace Route, and Report. The **Tools** menu offers the following structure:

<b>SubMenu</b>	<b>Tab/Page</b>	<b>Page</b>
Ping	<i>Ping Configuration</i>	186
	<i>Ping Results</i>	188
	<i>Ping Statistics</i>	191
Trace Route	<i>Trace Route Configuration</i>	192
	<i>Trace Route Results</i>	193
Cable Test	<i>Cable Test Configuration</i>	196
	<i>Cable Test Results - Summary</i>	199
	<i>Cable Test Results - Wire Map</i>	201
	<i>Cable Test Results - Delay/Length</i>	205
Report	<i>Report Configuration</i>	207
	<i>Report File</i>	209

## Ping Configuration

The Ping tool is used to determine if a network device is reachable.

Press , select **Tools**, **Ping**, and the **Configuration** tab.

- **IP Address:** Enter the IP address of the network device to be detected.

The default setting for IPv4 is **10.10.0.0** or is set automatically to the IP address of the target module from the Remote Loopback mode. The destination IP address is configured only when **Ethernet/IPv4/UDP** is selected.

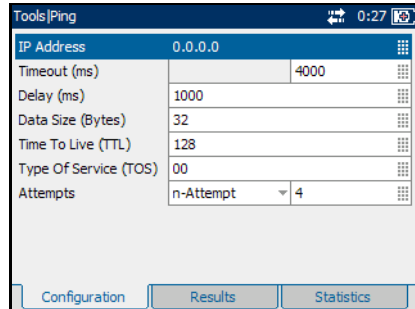

The default setting for IPv6 is **2001:0000:0000:0000:0000:0000:0000** or is set automatically to the IP address of the target module from the Remote Loopback mode. The destination IP address is configured only when **Ethernet/IPv6/UDP** is selected.

The accepted range for IPv4 is **0.0.0.0** to **255.255.255.255**. The default value is **0.0.0.0**.

The **IPv6 Address** can either be the **Link-Local IPv6 Address** or the **Global IPv6 Address**.

The acceptable range for IPv6 is from **000:0000:0000:0000:0000:0000:0000:0001** to **FFFF:FFFF:FFFF:FFFF:FFFF:FFFF:FFFF:FFFF**.

When the **IP Address** field is selected for editing, the **Latest IP's** button appears on the bottom of the screen. Press the corresponding function key to display the list of previously configured IP addresses. Select the desired IP address from the list, if any.

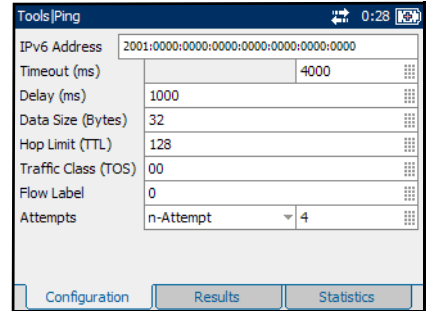

- **Timeout (ms):** Enter the maximum time allowed between an ICMP echo and response. Choices are **200 ms** to **10000 s**. The default setting is **4000 ms**.
- **Delay (ms):** Enter the delay between each attempt (PING). Choices are **100** to **10000 ms**. The default setting is **1000 ms**.
- **Data Size (Bytes):** Enter the buffer size that will be sent to the network device to be detected. Choices are **0** to **1452 bytes**. Default value is **32 bytes**.
- **TTL for IPv4 and Hop Limit (TTL) for IPv6**  
Enter the maximum number of hops the packet can go through. Choices are **1** to **255**. The default setting is **128**.
- **TOS for IPv4 and Traffic Class (TOS) for IPv6**  
Enter the type of service. Choices are **00** to **FF**. The default setting is **00**.
- **Flow Label (For IPv6 Only):** Enter the **Flow Label** value. The acceptable range is from **0** to **1048575**. The default value is **0**.
- **Attempts** Select **n-Attempts** to specify the number of ping requests to send following a ping activation or select **Continuous** to ping continuously until manually stopped. If **n-Attempts** is selected, enter the number of ping attempts from **1** to **100** (default setting is **4** and **Continuous** is disabled).

## Ping Results

Press , select **Tools**, **Ping**, and the **Results** tab.



### IMPORTANT

Test results/statistics are cleared when changing test or tool selection. It is highly advised to generate and save the report once the current test is completed. See *Report Generation* on page 79 to generate and save a report file.

To succeed, a Ping command shall be acknowledged by the network device within a given delay (**Timeout**). Typically a Ping command can fail for the following reasons:

- The IP address is unavailable or unknown.
- The time allowed to perform the Ping command is too short.
- The remote device is not supporting ICMP messaging.

The Ping results are displayed with the following columns:

- **No.:** Indicates the attempt number.



The screenshot shows a window titled 'Tools|Ping' with a timestamp of 10:41 AM. The window contains a table with the following data:

No.	Status	Replied From	Bytes	Time	TTL
1	Successful	10.1.200.87	32	10	128
2	Successful	10.1.200.87	32	10	128

Below the table, there are three tabs: 'Configuration', 'Results', and 'Statistics'. A 'Report' button is located to the right of the table.

- **Status:** Indicates the status of the attempt as follows:

Status	Description
<b>Successful</b>	Valid ICMP echo reply received.
<b>Aborted</b>	When a user has manually stopped the Ping function before the end of attempts.
<b>Time Out</b>	When an ICMP echo reply was not received within the defined timeout.
<b>Dest. Invalid</b>	Specified IP address is reserved for IPv4 and IPv6.
<b>TTL Expired</b>	When the number of TTL was insufficient to reach the destination host.
<b>Unreachable</b>	When the IP address is unreachable (no default gateway for an IP address, not in the same subnet, or the MAC address is unresolved).
<b>Data Corrupted</b>	Parameter problem message is received or data corruption is found.
<b>Discarded</b>	Congestion has been detected and the request cannot be transmitted. It is only applicable for the <b>IPv4 version</b> .
<b>Packet Too Big</b>	Packet Too Big message is received in response to a packet that the router cannot forward because the packet is larger than the MTU of the outgoing link. It is only applicable for the <b>IPv6 version</b> .
<b>Undefined</b>	For any other errors in Ping that do not fall into one of the above description.

## Tools

### Ping Results

---

- **Replied From:** Indicates the IP address of the replier.
- **Bytes:** Indicates the buffer size of the ICMP echo response.
- **Time:** Indicates the time of response in milliseconds.
- **TTL:** Indicates the TTL of the ICMP echo response.

**Note:** For IPv6 version, **Bytes**, **Time** and **Hop Limit** (*TTL is replaced with Hop Limit for IPv6*) will be displayed below the **Details** column.

- **Report:** Select the **Report** button to generate a report of the ping results. See *Report Generation* on page 79 to generate and save a report file.

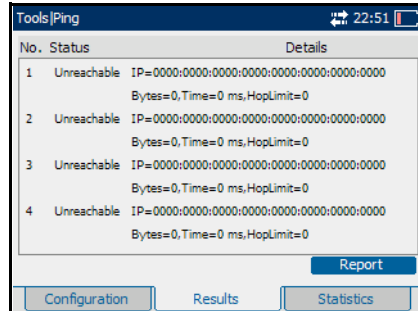



## Ping Statistics

Press , select **Tools**, **Ping**, and the **Statistics** tab.



### IMPORTANT

Test results/statistics are cleared when changing test or tool selection. It is highly advised to generate and save the report once the current test is completed. See *Report Generation* on page 79 to generate and save a report file.

- **Packets Transmitted:** Indicates the number of sent packets.
- **Packets Received:** Indicates the number of received packets.
- **Percentage Lost:** Indicates the percentage of packets lost.
- **Minimum Round Trip Time (ms):** Indicates the minimum time recorded for a Ping request to be answered.
- **Maximum Round Trip Time (ms):** Indicates the maximum time recorded for a Ping request to be answered.
- **Average Round Trip Time (ms):** Indicates the average time required for a Ping request to be answered.

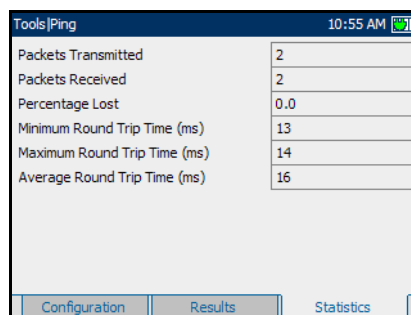

Tools Ping		10:55 AM
Packets Transmitted	2	
Packets Received	2	
Percentage Lost	0.0	
Minimum Round Trip Time (ms)	13	
Maximum Round Trip Time (ms)	14	
Average Round Trip Time (ms)	16	

Configuration Results Statistics

## Trace Route Configuration

Trace Route is used to obtain the list of all hops identified between the local port (AXS-200/850) and the destination IP port.

Press , select **Tools**, **Trace Route**, and the **Configuration** tab.

- **IP Address:** Enter the IP address of the network device to be detected.

The accepted range for IPv4 is **0.0.0.0** to **255.255.255.255**. The default value is **0.0.0.0**.

The acceptable range for IPv6 is from **000:0000:0000:0000:0000:0000:000:0001** to **FFFF:FFFF:FFFF:FFFF:FFFF:FFFF:FFFF:FFFF**.

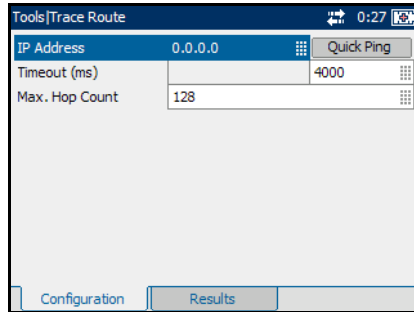

When the **IP Address** field is selected for editing, the **Latest IP's** button appears on the bottom of the screen. Press the corresponding function key to display the list of previously configured IP addresses. Select the desired IP address from the list, if any.

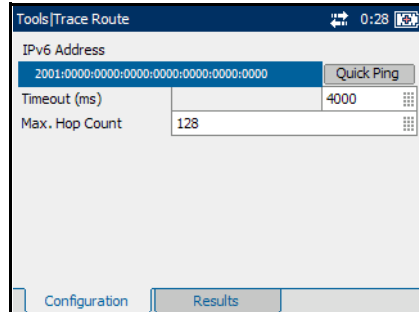

- **Timeout (ms):** Enter the maximum time allowed between an ICMP echo and response at each hop. Choices are **200 ms** to **10000 ms**. The default setting is **4000 ms**.
- **Max Hop Count:** Enter the maximum network device the packet is allowed to go through. Choices are **1** to **255**. The default setting is **128**.

## Trace Route Results

Press , select **Tools**, **Trace Route**, and the **Results** tab.



### IMPORTANT

Test results and statistics are cleared when changing test or tool selection. It is highly advised to generate and save the report once the current test is completed. See *Report Generation* on page 79 to generate and save a report file.

To succeed, a **Trace Route** command shall be acknowledged by the network device within a given delay. Typically a **Trace Route** command can fail for the following reasons:

- The IP address is unavailable or unknown.
- The time allowed to perform the **Trace Route** command is too short.
- The remote device is not supporting ICMP messaging.

The Trace Route results are displayed with the following columns:

No.	Status	Replied From	Time
1	Hop Reached	66.59.191.178	13
2	Hop Reached	198.32.160.130	17
3	Hop Reached	72.14.236.215	14
4	Hop Reached	72.14.233.113	26
5	Hop Reached	209.85.250.111	33
6	Hop Reached	72.14.232.25	21

For IPv4

No.	Status	Replied From	Time
1	Unreachable	0000:0000:0000:0000:0000:0000:0000:0000	0

For IPv6

## Tools

### Trace Route Results

---

- **No.:** Indicates the attempt number.
- **Status:** Indicates the status of the attempt.

Status	Description
<b>Successful</b>	Valid ICMP echo reply received.
<b>Aborted</b>	When a user has manually stopped the Trace Route function before the end of attempts.
<b>Time Out</b>	When an ICMP echo reply was not received within the defined timeout.
<b>Dest. Invalid</b>	Specified IP address is reserved for IPv4 and IPv6.
<b>Hop Reached</b>	When a Time Exceeded message is received from a host while executing the Trace Route function.
<b>Unreachable</b>	When the IP address is unreachable (no default gateway for an IP address, not in the same subnet, or the MAC address is unresolved).
<b>Data Corrupted</b>	Parameter problem message is received or data corruption is found.
<b>Discarded</b>	Congestion has been detected and the request cannot be transmitted. It is only applicable for the <b>IPv4 version</b> .
<b>Packet Too Big</b>	Packet Too Big message is received in response to a packet that the router cannot forward because the packet is larger than the MTU of the outgoing link. It is only applicable for the <b>IPv6 version</b> .
<b>Undefined</b>	For any other errors in Trace Route that do not fall into one of the above description.

- **Replied From:** Indicates the IP address of the replier.
- **Time:** Indicates the time of response in milliseconds.
- **Report:** Select the **Report** button to generate a report of the trace route results. See *Report Generation* on page 79 to generate and save a report file.

## Cable Test Configuration

The cable test tool is used to diagnose UTP twisted pairs cables (up to Category 6e/Class E).

Cable test can be performed everywhere in the network where an electrical 10/100/1000 Mbps Ethernet interface is available for testing. Only the pairs used by the Ethernet signal will be tested. For 10Base-T and 100Base-TX, pair 2 and 3 will be tested; for 1000Base-T, all pairs will be tested. However, if the Ethernet signal is unknown, all four pairs will be tested.

Even if a link up is not required when testing with a far end equipment, it is preferable to have the far end equipment powered up to maximize the cable test results.

Supported Ethernet cable categories are: **Category 3/Class C**, **Category 4**, **Category 5**, **Category 5e/Class D**, and **Category 6e/Class E**.

**Note:** *Cable test is only available when the **Transceiver Mode** is set to **Electrical** (Refer to Port on page 34).*

The cable test **Configuration** tab allows to select the UTP wiring scheme, the length unit, and to enable and set the Pass/Fail verdict threshold parameters.

Press , select **Tools**, **Cable Test**, **Configuration**, and the **Configuration** tab.

**Wiring Standard:** Select the pin-to-pair assignment corresponding to the UTP cable used. Choices are **T568A** and **T568B**. The default setting is **T568A**.

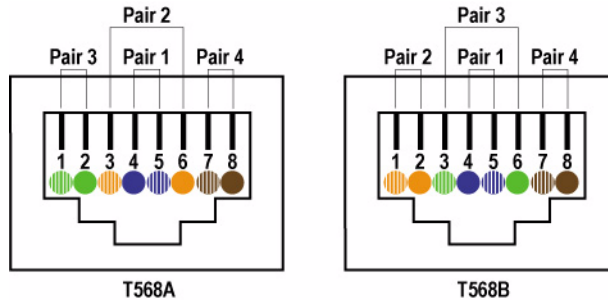
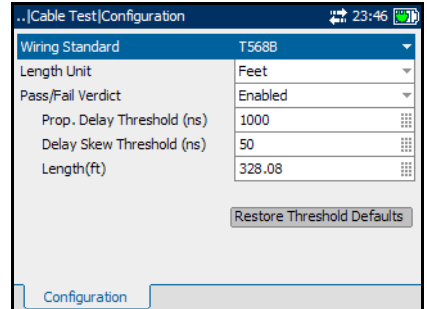

- **Length Unit:** Select the unit that will be used for cable length and distance to fault results. Choices are **Meter** and **Feet**. The default setting is **Meter**.
- **Pass/Fail Verdict:** Enable **Pass/Fail Verdict** to display the Pass/Fail verdict on the cable test result pages. The default setting is enabled.

**Note:** The following parameters are only available when the **Pass/Fail Verdict** is enabled.

## Tools

### *Cable Test Configuration*

---

- **Prop. Delay Threshold (ns):** Set the threshold value as the maximum time for a pulse to reach the far end. If the determined propagation delay is less than or equal to the threshold value, the test is declared as **PASS**. If the determined propagation delay is higher than the threshold value, the test is declared **FAIL**. The accepted range is **0 to 1000 ns** with a default value of **1000 ns** for 10Mbps, **556 ns** for 100Mbps, and **570 ns** for 1Gbps.
- **Delay Skew Threshold (ns):** Set the threshold value as the maximum time between the fastest and slowest pairs of a 1000Base-T signal. If the determined delay skew is less than or equal to the threshold value, the test is declared as **PASS**. If the determined delay skew is higher than the threshold value, the test is declared **FAIL**. The accepted range is **0 to 120 ns** with a default value of **50 ns**.
- **Length Threshold (m/ft):** Set the threshold value as the maximum acceptable cable length. If the determined cable length is less than or equal to the threshold value, the test is declared as **PASS**. If the determined cable length is higher than the threshold value, the test is declared **FAIL**. The accepted range is **0 to 120 m** or **0 to 393.7 feet** with a default value of **100 m (328 ft)**.
- **Restore Threshold Defaults:** Restores the default configuration values for **Prop. Delay Threshold**, **Delay Skew Threshold**, and **Length Threshold**.



## Cable Test Results - Summary

The cable test result **Summary** tab gives the cable test status and Pass/Fail verdict, when enabled. The worst pair's **Wire Map**, **Prop. Delay**, **Delay Skew**, and **Length** results are also displayed with the Pass/Fail verdict (when enabled).

**Note:** Cable test is only available when the **Transceiver Mode** is set to **Electrical** (Refer to **Port** on page 34).

Press , select **Tools**, **Results**, and the **Summary** tab.

➤ **Status:** The progress **Status** of the cable test is indicated as follows:

- **Idle** (test has not started)
- **In Progress**
- **Completed**

The Pass/Fail verdict is displayed, when enabled, once the cable test is completed. If the worst **Wire**

**Map**, **Prop. Delay**, **Delay Skew**, and **Length** Pass/Fail verdict are all **PASS**, the test is declared as **PASS**. If one of the **Wire Map**, **Prop. Delay**, **Delay Skew**, and **Length** Pass/Fail verdict is **FAIL**, the test is declared as **FAIL**.

**Wire Map:** Indicates the Wire Map result for the pair having the worst Wire Map. The distance to fault is also displayed when a fault is identified. The Pass/Fail verdict is also displayed when enabled. See *Cable Test Results - Wire Map* for more details. For details on Pass/Fail verdict, see page 204.

**Prop. Delay (ms):** Indicates the propagation delay value for the pair having the longest propagation delay. The Pass/Fail verdict is also displayed when enabled. See *Cable Test Results - Delay/Length* on page 205 for more details.

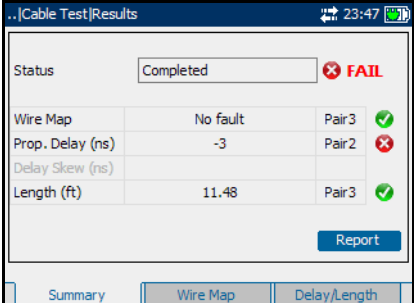

Cable Test Results			
Status	Completed	❌ FAIL	
Wire Map	No fault	Pair3	✅
Prop. Delay (ns)	-3	Pair2	❌
Delay Skew (ns)			
Length (ft)	11.48	Pair3	✅
Report			
Summary   Wire Map   Delay/Length			

## Tools

### *Cable Test Results - Summary*

---

**Delay Skew (ns):** Indicates the delay skew value for the pair having the worst delay skew. The Pass/Fail verdict is also displayed when enabled. The **Delay Skew** result is only available for 1000Base-T interface when the link is up.

**Length (m/ft):** Indicates the length for the pair having the worst cable length value. The Pass/Fail verdict is also displayed when enabled. See *Cable Test Results - Delay/Length* on page 205 for more details.

**Note:** When no value is available, "--" is displayed.

- The **Pass/Fail** verdict is also displayed for each test parameter when enabled. To set the **Pass/Fail** verdict, see **Pass/Fail Verdict** on page 196.
  - ✔ = PASS
  - ✘ = FAIL
- **Report:** Select the **Report** button to generate the report file of the results and statistics. See *Report Generation* on page 79 to generate and save a report file.

## Cable Test Results - Wire Map

The cable test result **Wire Map** tab gives the cable pinout, and connectivity errors for each pair. The fault distance is also displayed when a fault is identified. The Pass/Fail verdict is also displayed when enabled.

**Note:** Cable test is only available when the **Transceiver Mode** is set to **Electrical** (Refer to *Port* on page 34).

Press , select **Tools**, **Results**, and the **Wire Map** tab.

- **Pair:** Indicates the pair number.
- **Pins:** Indicates the pair's pin numbers and color of each wire corresponding to the selected wiring standard (see page 197).

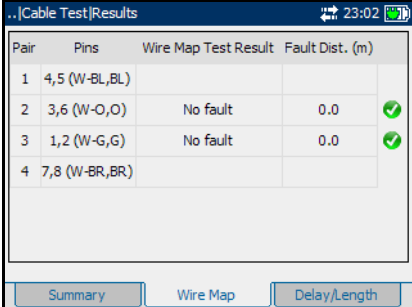

Pair	Pins	Wire Map Test Result	Fault Dist. (m)
1	4,5 (W-BL,BL)		
2	3,6 (W-O,O)	No fault	0.0
3	1,2 (W-G,G)	No fault	0.0
4	7,8 (W-BR,BR)		

<b>W-BL</b>	=	White-Blue
<b>BL</b>	=	Blue
<b>W-O</b>	=	White-Orange
<b>O</b>	=	Orange
<b>W-G</b>	=	White-Green
<b>G</b>	=	Green
<b>W-BR</b>	=	White-Brown
<b>BR</b>	=	Brown

## Tools

### *Cable Test Results - Wire Map*

---

**Wire Map Test Result:** Gives the wire map test result for each pair.

When the link is up: The wire map result for each pair is given as seen by the AXS-200/850 to get a link up. This means that the wire map result may not correspond to the type of cable tested depending on the cable(s) used and/or the configuration of the cable mode (MDI, MDIX, or autodetection) on both the AXS-200/850 and the far end equipment. For example, two crossed pair cables end to end used between the AXS-200/850 and a far end equipment may give a straight pair (MDI) wire map result.

**MDI:** Straight pair.

**MDIX:** Crossed pair.

**MDI (-):** For 1Gbps, straight pair with swapped wires within pair.

**MDIX (-):** For 1Gbps, crossed pair with pair A swapped with pair B and/or pair C swapped with pair D.

**Noise:** Excessive noise on a pair most likely caused by a link partner running in 10/100Mbps forced mode. In this case, no propagation delay or length is reported and there is no comparison with any threshold.

**Note:** *For 1Gbps, both MDI and MDIX can be reported simultaneously since crossed pairs detection is performed independently for pairs A-B and C-D.*

When the link is down:

**Short:** Short-circuit between Tip and Ring wires of a pair or Tip or ring wire of a pair is connected with an alien wire grounded.

**Open:** No cable plugged in, remote end open, or either one or two wires of a pair are not connected.

**Short-between-pairs:** Short between one or two wires of a pair with one or two wires of another pair. Short between more than two pairs, including one or two wires for each pair.

**Noise:** Excessive noise on a pair most likely caused by a link partner running in 10/100Mbps forced mode. In this case, no distance is reported and there is no comparison with any threshold.

**Unknown:** No fault has been identified but the link is down. To maximize the cable test result, it is preferable to have the far end equipment powered up.

**Note:** Refer to *Ethernet Cables* on page 232 for cable pinout.

## Tools

### Cable Test Results - Wire Map

---

- **Fault Dist. (m/ft):** Gives the distance to fault from the near end for each pair, unless the problem is due to excessive noise. Noise may be due to electrical noise causing communication error.

**Note:** When no value is available, "--" is displayed.

- The **Pass/Fail** verdict is also displayed for each pair when enabled. To enable the **Pass/Fail** verdict, see **Pass/Fail Verdict** on page 196.

 = PASS

 = FAIL

If the determined Wire Map is either **MDI**, **MDIX**, **MDI (-)**, **MDIX (-)**, or **Noise** (Link up), the test is declared as **PASS**. If the determined Wire Map is either **Short**, **Short-between-pair**, **Open**, **Noise** (Link down), or **Unknown**, the test is declared as **FAIL**.

## Cable Test Results - Delay/Length

The cable test result **Delay/Length** tab gives the propagation delay and cable length for each pair. The Pass/Fail verdict is also displayed for propagation delay and cable length (when enabled).

**Note:** Cable test is only available when the **Transceiver Mode** is set to **Electrical** (Refer to *Port* on page 34).

Press , select **Tools**, **Results**, and the **Delay/Length** tab.

- **Pair:** Indicates the pair number.
- **Pins:** Indicates the pair's pin numbers and color of each wire corresponding to the selected wiring standard (see page 197).

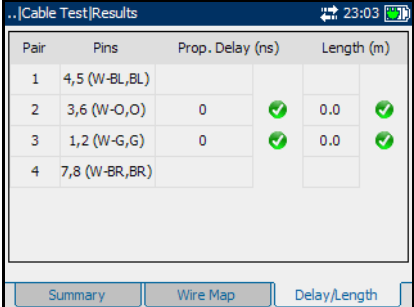

Pair	Pins	Prop. Delay (ns)	Length (m)
1	4,5 (W-BL,BL)		
2	3,6 (W-O,O)	0	0.0
3	1,2 (W-G,G)	0	0.0
4	7,8 (W-BR,BR)		

<b>W-BL</b>	=	White-Blue
<b>BL</b>	=	Blue
<b>W-O</b>	=	White-Orange
<b>O</b>	=	Orange
<b>W-G</b>	=	White-Green
<b>G</b>	=	Green
<b>W-BR</b>	=	White-Brown
<b>BR</b>	=	Brown

## Tools

### *Cable Test Results - Delay/Length*

---

- **Prop. Delay (ns):** Indicates the propagation delay of a signal through each pair.
- **Length (m/ft):** Indicates the cable length of each pair.

**Note:** *When no value is available, "--" is displayed.*

- The **Pass/Fail** verdict is also displayed for each pair, when enabled, for both **Prop. Delay** and **Length** results. To set the **Pass/Fail** verdict, see **Pass/Fail Verdict** on page 196.

 = PASS

 = FAIL



## Report Configuration

The configurable parameters appear on the top of the report page.

Press , select **Tools**, **Report**, and the **Configuration** page.

- **Report Header:** Enter the Report header information. The header can be the company name for example, and must be less than 30 characters long.
- **Report Title:** Enter the report title which must be less than 30 characters long. This can be the name of the product, name of test, or test number for example.
- **User Information:** Enter any additional information of up to 30 characters.
- **Report Prompt:** When enabled, a prompt will pop up every time a test case is stopped or completed to ask the user if a report generation is desired.
- **Media Selector:** Allows the selection of the media where the report files will be saved. Choices are **Internal Flash Memory** or **USB key**. The default media is **Internal Flash Memory**.

..Report Configuration	
Report Header	EXFO Electro-Optical Engineering Inc.
Report Title	
User Information	
Report Prompt	Enabled
Media Selector	Internal Flash (Data)
Logger in Report	Enabled

When **Internal Flash Memory** is selected, the report file will be saved to the **\Data\My Documents\NetBlazer850\Reports** folder.

When **USB key** is selected, the report file will be saved on an USB memory media. However, if no USB key is not present, the user will be prompted to save the report to the internal flash.

## Tools

### *Report Configuration*

---

- **Logger in Report:** Allows to enable or disable the Logger section in Report. Choices are **Enabled** and **Disabled**. The default setting is **Enabled**. If **Disabled**, the Logger section will not be displayed in the report.

If **Enabled**, the report generated will display the Logger section at the bottom of the page as shown in the figure

## Report File

Report files from the internal flash memory can be opened or deleted from this page.

Press , select **Tools**, **Report**, and the **File** tab.

**Note:** Refer to *File Manager* on page 212 for more information on how to transfer files to/from a USB storage device to/from the AXS-200/850 Ethernet Test Set module.

- **Files:** Select the list box by pressing the  key (the box outline will change from blue to yellow).
- **Open:** Use the up and down arrows to highlight the file to open. Select **Open** by using the corresponding function key.
- **Delete:** Use the up and down arrows to highlight the file to delete. Select **Delete** by using the corresponding function key.

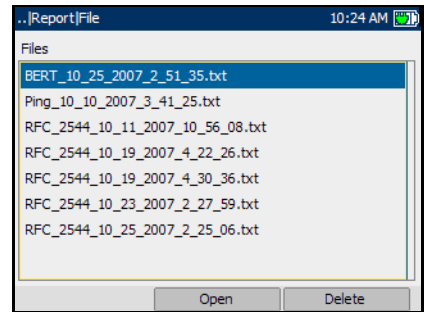



# 13 System

The **System** menu gives access to tabs containing functions related to the AXS-200. The **System** menu offers the following structure:

Submenu item	Tab/Page
Utilities	File Manager <sup>a</sup>
	VNC <sup>a</sup>
Settings	Date and Time
	Display and Language
	Network Connection
	Power
Software Options	Module
	Platform
Information	About
	Module <sup>a</sup>
	Application
	Platform
	Memory
	Components

- a. This information is specific to the AXS-200/850 Ethernet Test Set module and is described in this chapter.

**Note:** Refer to the Sharp Tester User Guide for information on the System tabs.

## File Manager

The File Manager allows files and folders to be copied or deleted from the AXS-200/850 Ethernet Test Set module. Files and folders can be transferred to and from an external USB media.

**To transfer files to and from the USB port:**

1. Press , select **System**, **Utilities**, and the **File Manager** page.

2. Select the desired file or folder as follows:

2a. Select the media where the file is located.

2b. Select the folder where the file is located.

2c. Use the down arrow to highlight the list of files and press the  button to select the list.

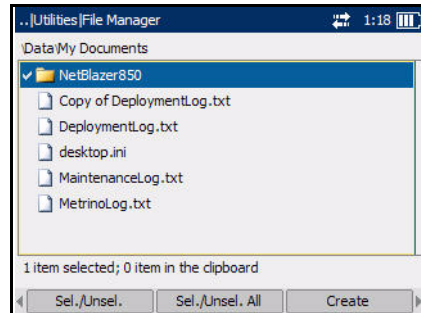

➤ Use the up/down arrows to navigate in the list. To open a folder, highlight it, then select **Open Folder** on the bottom of the screen using the corresponding function key.

➤ Once on the desired file, select **Sel./Unsel.** or select them all with **Sel./Unsel All** using the corresponding function key.

3. Use the function arrows to go to the next available options, and select **Copy** using the corresponding function key.

4. Paste the file or folder as follows:

4a. Find the destination folder in the same manner to find the copy folder.

4b. Use the function arrows to go to the next available options, and select **Paste** using the corresponding function key.

5. To exit the list box, press the  button.

**Note:** Transferring report files can also be done using an FTP connection. Open an Internet browser and type `ftp://x.x.x.x`, where `x.x.x.x` is the IP address of the AXS-200. Go to the `\Data\My Documents\NetBlazer\Reports` folder to retrieve the report file.

**To delete files:**

1. Press , select **System**, **Utilities**, and the **File Manager** page.
2. Select the desired file or folder as follows:

- 2a. Select the media where the file is located.
- 2b. Select the folder where the file is located.
- 2c. Use the down arrow to highlight the list of files and press the  button to select the list.

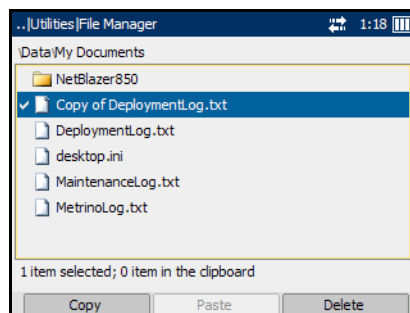

- Use the up/down arrows to navigate in the list. To open a folder, highlight it, then select **Open Folder** using the corresponding function key.
  - Once on the desired file, select **Sel./Unsel.** or select them all with **Sel/Unsel All** using the corresponding function key.
3. Use the function arrows to go to the next available options, and select **Delete** using the corresponding function key.
  4. Select **Yes** using the corresponding function key to confirm the deletion.
  5. To exit the list box, press the  button.

## VNC

VNC can be enabled in order for a computer running **VNC Viewer** to gain remote access to the AXS-200/850 Ethernet Test Set module. The **VNC Viewer** software is included in the AXS-200/850 Ethernet Test Set CD.

***To connect the AXS-200/850 Ethernet Test Set to the computer:***

Connect the module to the same network as the computer. Plug the Ethernet cable to the RJ-45 connector on the side of the module as illustrated in the following diagram.

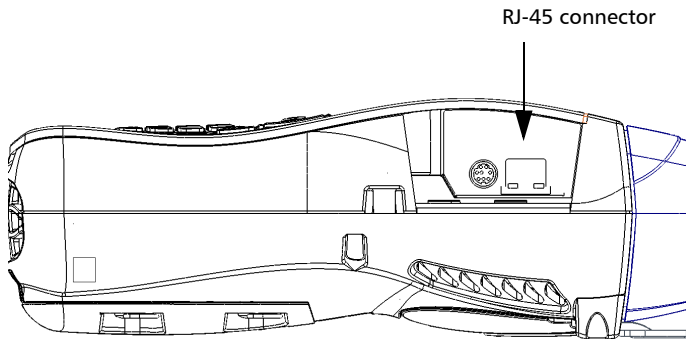





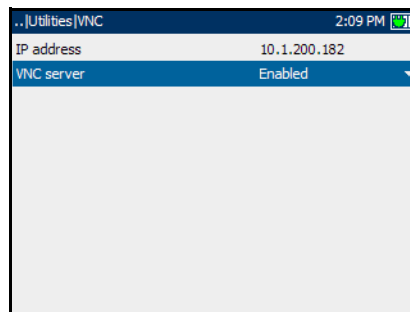

**To enable VNC and connect from a computer:**

1. Press , select **System, Utilities**, and the **VNC** page.
2. Select **VNC Server** and select **Enable**.
3. Take note of the module's IP address displayed on the top of the screen.
4. Launch the **VNC Viewer** from the computer (included in the AXS-200/850 Ethernet Test Set CD).
5. Enter the IP address of the module into the **VNC Viewer** window. The window from the remote module will appear on the computer.







To control the AXS-200/850 Ethernet Test Set remotely from the **VNC Viewer**, use the following keys on the computer keyboard (they are mapped directly to the AXS-200/850 Ethernet Test Set keypad).

Computer Keyboard	AXS-200/850 Ethernet Test Set Keypad <sup>a</sup>	
F1		Help
F2		Start/Stop Test
F3		Brightness
F4		Left Function Arrow
F5	F1 Function Key	
F6	F2 Function Key	
F7	F3 Function Key	
F8		Right Function Arrow

## System

VNC

---

Computer Keyboard	AXS-200/850 Ethernet Test Set Keypad <sup>a</sup>	
ESC		Back
Up, Down, Left, Right arrows <sup>b</sup> on keyboard (not on the NumLock keypad).		Navigation Arrows
Enter		Select
Home <sup>b</sup>		Home
Top numbers on keyboard (not the NumLock keypad).	The Alpha-numeric Keypad	
> and . key <sup>b</sup>	* and . key	
? and / key <sup>b</sup>	#, +, and - key	

- a. Refer to *Keypad* on page 11 for the description of the AXS-200/850 Ethernet Test Set keypad.
- b. See diagram of keyboard for location of the key(s).

The diagram below illustrates the location and function of keys used to remotely operate the AXS-200/850 Ethernet Test Set module.

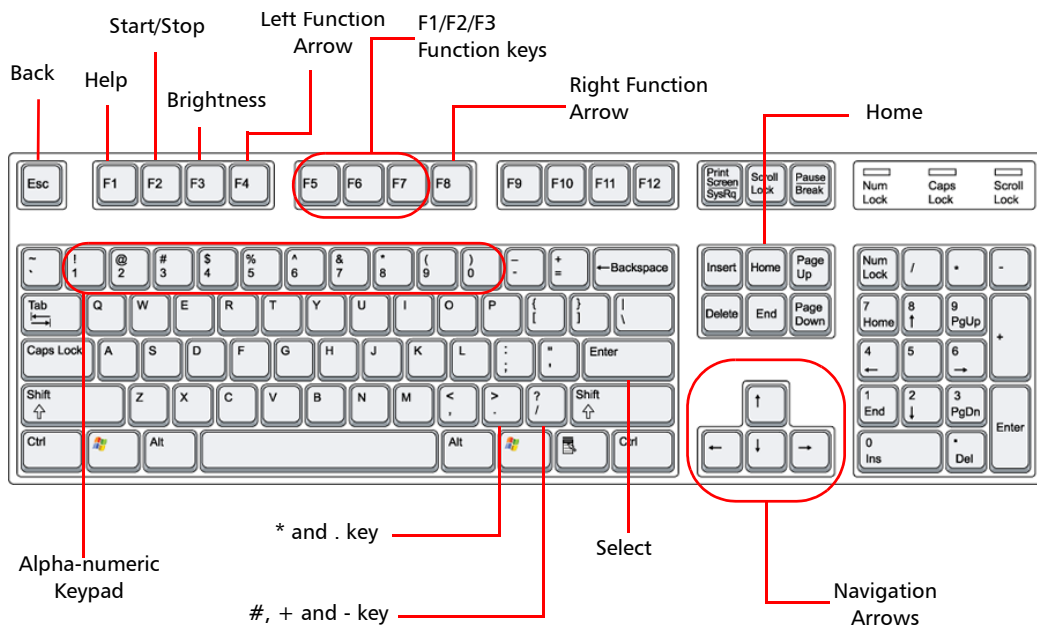

### Module Information

The **Module** tab contains information about the AXS-200/850 Ethernet Test Set module.

Press , select **System**, **Information**, and the **Module** tab.

The following module information is displayed:

- **Information**
- **Module**
- **Name**
- **Module ID**
- **Serial number**

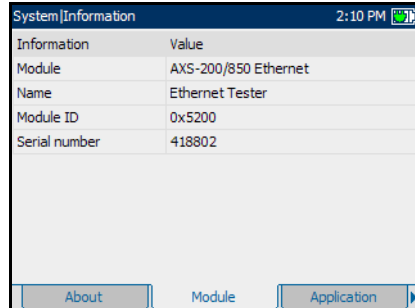

The screenshot shows a window titled "System|Information" with a timestamp of "2:10 PM" and a battery icon. The window contains a table with the following data:

Information	Value
Module	AXS-200/850 Ethernet
Name	Ethernet Tester
Module ID	0x5200
Serial number	418802

At the bottom of the window, there are three tabs: "About", "Module", and "Application". The "Module" tab is currently selected.

# 14 Maintenance

To help ensure long, trouble-free operation:

- Always clean fiber-optic connectors before using them.
- Keep the unit free of dust.
- Clean the unit casing and front panel with a cloth slightly dampened with water.
- Store unit at room temperature in a clean and dry area. Keep the unit out of direct sunlight.
- Avoid high humidity or significant temperature fluctuations.
- Avoid unnecessary shocks and vibrations.
- If any liquids are spilled on or into the unit, turn off the power immediately and let the unit dry completely.



## WARNING

Use of controls, adjustments, and procedures for operation and maintenance other than those specified herein may result in hazardous radiation exposure.

## Calibration Statement

All EXFO optical products (Light Sources, Fiber-Optic Power Meters, etc) require a calibration for which local calibration centers with STQC labs (ERTL, ETDC) can be availed. EXFO's manufacturing and service center calibrations are based on the ISO/IEC 17025 Standard, which states that calibration documents must not contain a recommended calibration interval, unless this has been previously agreed upon with the customer. Validity of specifications depends on operating conditions. For example, the calibration validity period can be longer or shorter depending on the intensity of use, environmental conditions and unit maintenance. Under normal use, EXFO recommends calibrating these units every year.

In order to ensure appropriate calibration follow-up, EXFO applies a special label on its instruments; this label complies with the ISO/IEC 17025 standard and indicates the previous and next calibration dates. However, until the required empirical data has been collected, EXFO recommends that the next calibration date of an instrument be established according to the following equation:

Next calibration date = Date of first usage + recommended calibration period (as specified in the instrument user guide)

For Transport Datacom products, (SDH Analyzer, Ethernet traffic analyzers, etc) validity of specifications depends also on operating conditions. The calibration validity period can be longer or shorter depending on the intensity of use, environmental conditions and unit maintenance. Under normal use, EXFO recommends calibrating these units every two years.

## **Recycling and Disposal (Applies to European Union Only)**



Recycle or dispose of your product (including electric and electronic accessories) properly, in accordance with local regulations. Do not dispose of it in ordinary garbage receptacles.



This equipment was sold after August 13, 2005 (as identified by the black rectangle).

- Unless otherwise noted in a separate agreement between EXFO and a customer, distributor or commercial partner, EXFO will cover costs related to the collection, treatment, recovery and disposal of end-of-lifecycle waste generated by electronic equipment introduced after August 13, 2005 to an European Union member state with legislation regarding Directive 2002/96/EC.
- Except for reasons of safety or environmental benefit, equipment manufactured by EXFO, under its brand name, is generally designed to facilitate dismantling and reclamation.

For complete recycling/disposal procedures and contact information, visit the EXFO Web site at [www.exfo.com/recycle](http://www.exfo.com/recycle).





# 15 Troubleshooting

## Solving Common Problems

Before calling EXFO's technical support, please read the following common problems that can occur and their respective solution.

Problem	Possible Cause	Solution
Optical Laser LED is off and the connector is not generating the signal.	➤ The <b>Transceiver Mode</b> is not set to Optical.	➤ Ensure that the <b>Transceiver Mode</b> is set to Optical. Refer to <b>Port on page 34</b> for more information.
	➤ There is a configuration mismatch between the inserted SFP and the current interface speed.	➤ Ensure that the SFP is supporting the current interface speed. Refer to <b>Port on page 34</b> for more information.
	➤ The SFP is not compatible with the AXS-200/850.	➤ Ensure to use a compatible SFP. Refer to <i>Optical Transceivers (SFP)</i> on page 4.

## Troubleshooting

### Contacting the Technical Support Group

---

## Contacting the Technical Support Group

To obtain after-sales service or technical support for this product, contact EXFO at one of the following numbers. The Technical Support Group is available to take your calls from Monday to Friday, 8:00 a.m. to 7:00 p.m. (Eastern Time in North America).

For detailed information about technical support, visit the EXFO Web site at [www.exfo.com](http://www.exfo.com).

### Technical Support Group

400 Godin Avenue  
Quebec (Quebec) G1M 2K2  
CANADA

1 866 683-0155 (USA and Canada)  
Tel.: 1 418 683-5498  
Fax: 1 418 683-9224  
[support@exfo.com](mailto:support@exfo.com)

To accelerate the process, please have information such as the name and the serial number (see the product identification label—an example is shown below), as well as a description of your problem, close at hand.

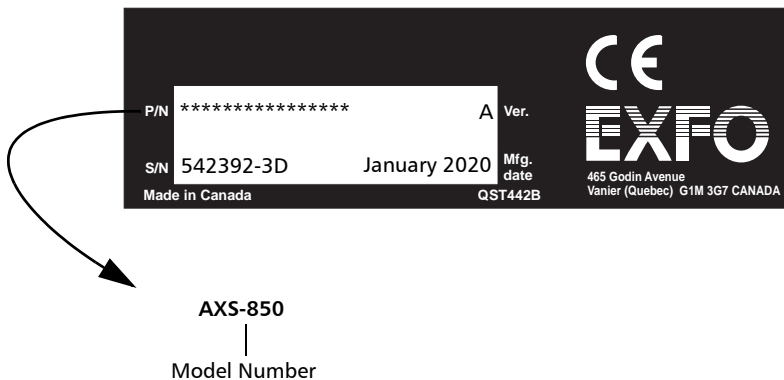

## **Transportation**

Maintain a temperature range within specifications when transporting the unit. Transportation damage can occur from improper handling. The following steps are recommended to minimize the possibility of damage:

- Pack the unit in its original packing material when shipping.
- Avoid high humidity or large temperature fluctuations.
- Keep the unit out of direct sunlight.
- Avoid unnecessary shocks and vibrations.



# 16 Warranty

## General Information

EXFO Electro-Optical Engineering Inc. (EXFO) warrants this equipment against defects in material and workmanship for a period of one year from the date of original shipment. EXFO also warrants that this equipment will meet applicable specifications under normal use.

During the warranty period, EXFO will, at its discretion, repair, replace, or issue credit for any defective product, as well as verify and adjust the product free of charge should the equipment need to be repaired or if the original calibration is erroneous. If the equipment is sent back for verification of calibration during the warranty period and found to meet all published specifications, EXFO will charge standard calibration fees.



### IMPORTANT

The warranty can become null and void if:

- unit has been tampered with, repaired, or worked upon by unauthorized individuals or non-EXFO personnel.
- warranty sticker has been removed.
- case screws, other than those specified in this guide, have been removed.
- case has been opened, other than as explained in this guide.
- unit serial number has been altered, erased, or removed.
- unit has been misused, neglected, or damaged by accident.

THIS WARRANTY IS IN LIEU OF ALL OTHER WARRANTIES EXPRESSED, IMPLIED, OR STATUTORY, INCLUDING, BUT NOT LIMITED TO, THE IMPLIED WARRANTIES OF MERCHANTABILITY AND FITNESS FOR A PARTICULAR PURPOSE. IN NO EVENT SHALL EXFO BE LIABLE FOR SPECIAL, INCIDENTAL, OR CONSEQUENTIAL DAMAGES.

## **Warranty**

### *Liability*

---

## **Liability**

EXFO shall not be liable for damages resulting from the use of the product, nor shall be responsible for any failure in the performance of other items to which the product is connected or the operation of any system of which the product may be a part.

EXFO shall not be liable for damages resulting from improper usage or unauthorized modification of the product, its accompanying accessories and software.

## **Exclusions**

EXFO reserves the right to make changes in the design or construction of any of its products at any time without incurring obligation to make any changes whatsoever on units purchased. Accessories, including but not limited to fuses, pilot lamps, batteries and universal interfaces (EUI) used with EXFO products are not covered by this warranty.

This warranty excludes failure resulting from: improper use or installation, normal wear and tear, accident, abuse, neglect, fire, water, lightning or other acts of nature, causes external to the product or other factors beyond EXFO's control.

## **Certification**

EXFO certifies that this equipment met its published specifications at the time of shipment from the factory.

## Service and Repairs

EXFO commits to providing product service and repair for five years following the date of purchase.

**To send any equipment for service or repair:**

1. Call one of EXFO's authorized service centers (see *EXFO Service Centers Worldwide* on page 230). Support personnel will determine if the equipment requires service, repair, or calibration.
2. If equipment must be returned to EXFO or an authorized service center, support personnel will issue a Return Merchandise Authorization (RMA) number and provide an address for return.
3. If possible, back up your data before sending the unit for repair.
4. Pack the equipment in its original shipping material. Be sure to include a statement or report fully detailing the defect and the conditions under which it was observed.
5. Return the equipment, prepaid, to the address given to you by support personnel. Be sure to write the RMA number on the shipping slip. *EXFO will refuse and return any package that does not bear an RMA number.*

**Note:** *A test setup fee will apply to any returned unit that, after test, is found to meet the applicable specifications.*

After repair, the equipment will be returned with a repair report. If the equipment is not under warranty, you will be invoiced for the cost appearing on this report. EXFO will pay return-to-customer shipping costs for equipment under warranty. Shipping insurance is at your expense.

Routine recalibration is not included in any of the warranty plans. Since calibrations/verifications are not covered by the basic or extended warranties, you may elect to purchase FlexCare Calibration/Verification Packages for a definite period of time. Contact an authorized service center (see *EXFO Service Centers Worldwide* on page 230).

## **Warranty**

*EXFO Service Centers Worldwide*

---

### **EXFO Service Centers Worldwide**

If your product requires servicing, contact your nearest authorized service center.

#### **EXFO Headquarters Service Center**

400 Godin Avenue  
Quebec (Quebec) G1M 2K2  
CANADA

1 866 683-0155 (USA and Canada)  
Tel.: 1 418 683-5498  
Fax: 1 418 683-9224  
[quebec.service@exfo.com](mailto:quebec.service@exfo.com)

#### **EXFO Europe Service Center**

Omega Enterprise Park, Electron Way  
Chandlers Ford, Hampshire S053 4SE  
ENGLAND

Tel.: +44 2380 246810  
Fax: +44 2380 246801  
[europe.service@exfo.com](mailto:europe.service@exfo.com)

#### **EXFO China Service Center/ Beijing OSIC**

Beijing New Century Hotel  
Office Tower, Room 1754-1755  
No. 6 Southern Capital Gym Road  
Beijing 100044  
P. R. CHINA

Tel.: +86 (10) 6849 2738  
Fax: +86 (10) 6849 2662  
[beijing.service@exfo.com](mailto:beijing.service@exfo.com)



# A Specifications



## IMPORTANT

The following technical specifications can change without notice. The information presented in this section is provided as a reference only. To obtain this product's most recent technical specifications, visit the EXFO Web site at [www.exfo.com](http://www.exfo.com).

### OPTICAL INTERFACES

Optical interfaces	One port at 100M or GigE						
Available wavelengths (nm)	850, 1310 and 1550						
	100Base-FX	100Base-LX	1000Base-SX	1000Base-LX	1000Base-ZX	1000BASE-BX10-D	1000BASE-BX10-U
Wavelength (nm)	1310	1310	850	1310	1550	Tx: 1490 Rx: 1310	Tx: 1310 Rx: 1490
Tx level (dBm)	-20 to -15	-15 to -8	-9 to -3	-9.5 to -3	0 to +5	-9 to -3	-9 to -3
Rx level sensitivity (dBm)	-31	-28 to -8	-20	-22	-22	-20	-20
Maximum reach	2 km	15 km	550 m	10 km	80 km	10 km	10 km
Transmission bit rate (Gbit/s)	0.125	0.125	1.25	1.25	1.25	1.25	1.25
Reception bit rate (Gbit/s)	0.125	0.125	1.25	1.25	1.25	1.25	1.25
Tx operational wavelength range (nm)	1280 to 1380	1261 to 1360	830 to 860	1270 to 1360	1540 to 1570	1480 to 1500	1260 to 1360
Measurement accuracy							
Frequency (ppm)	±15	±15	±15	±15	±15	±15	±15
Optical power (dB)	±2	±2	±2	±2	±2	±2	±2
Maximum Rx before damage (dBm)	+3	+3	+6	+6	+6	+6	+6
Jitter compliance	ANSI X3.166	IEEE 802.3	IEEE 802.3	IEEE 802.3		IEEE 802.3ah	IEEE 802.3ah
Ethernet classification	ANSI X3.166	IEEE 802.3	IEEE 802.3	IEEE 802.3		IEEE 802.3ah	IEEE 802.3ah
Laser type	LED	FP	VCSSEL	FP	DFB	DFB	FP
Eye safety	CLASS 1	CLASS 1	CLASS 1	CLASS 1	CLASS 1	CLASS 1	CLASS 1
Connector	LC	LC	LC	LC	LC	LC	LC
Transceiver type	SFP	SFP	SFP	SFP	SFP	SFP	SFP

### ELECTRICAL INTERFACES

Electrical interfaces	One port 10/100Base-T or 1000Base-T		
	Automatic detection of straight/crossover cable		
	10Base-T	100Base-TX	1000Base-T
Tx bit rate	10 Mbit/s	125 Mbit/s	1 Gbit/s
Tx accuracy (ppm)	±15	±15	±15
Rx bit rate	10 Mbit/s	125 Mbit/s	1 Gbit/s
Rx measurement accuracy (ppm)	±15	±15	±15
Duplex mode	Half and full duplex	Half and full duplex	Full duplex
Jitter compliance	IEEE 802.3	IEEE 802.3	IEEE 802.3
Connector	RJ-45	RJ-45	RJ-45
Maximum reach (m)	100	100	100

### GENERAL SPECIFICATIONS

Size (H x W x D)	289.5 mm x 119.8 mm x 96.5 mm	(11.298 in x 4.717 in x 3.8 in)
Weight (with battery)	1.356 kg	(2.989 lb)
Temperature		
operating	0 °C to 50 °C	(32 °F to 122 °F)
storage	-40 °C to 60 °C	(-40 °F to 140 °F)
Relative humidity	0 % to 93 %, non-condensing	
Battery life (typical usage)	Up to 5 hours	
Battery charging time	2 hours from full discharge to full charge	
Languages	English, Chinese	

# Specifications

---

## Ethernet Cables

Minimum Category 3 cable is required for 10Base-T connection while Category 5 cable is required for 100Base-TX and 1000Base-T connections.

Maximum cable length (between two nodes) for 10Base-T, 100Base-TX, or 1000Base-T connection is 328 feet (100 meters).

➤ **Straight Through Cable (10/100 Mbps)**

An Unshielded Twisted Pair (UTP) straight through cable is required to connect a 10Base-T/100Base-TX AXS-200/850 Ethernet Test Set port to a layer 1 or 2 device (ex: HUB, switch).

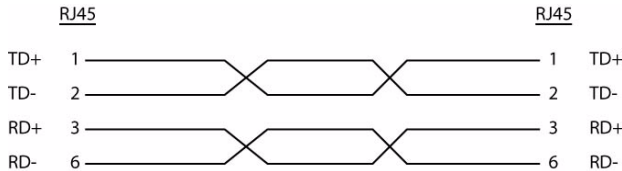

► Crossover Cable (10/100 Mbps)

An Unshielded Twisted Pair (UTP) crossover cable is required to connect the 10Base-T/100Base-TX AXS-200/850 Ethernet Test Set port to a layer 3 device (ex: router).

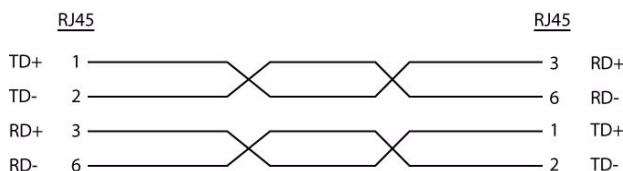

► Straight Through Cable (1000 Mbps)

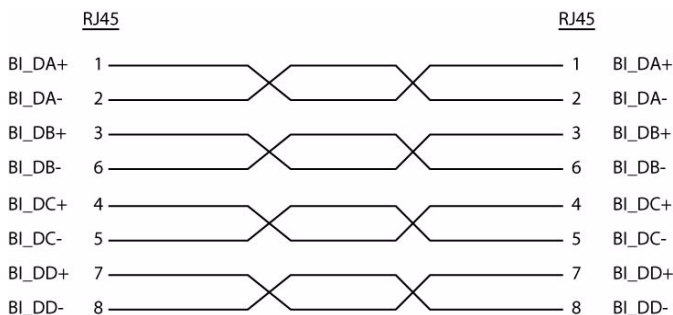

► Crossover Cable (1000 Mbps)

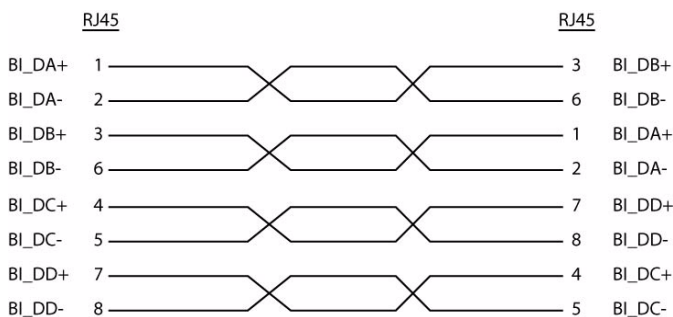



# **B** *Glossary*

## **Acronym List**

?	Help
---	------

### A

AC	Alternating Current
ARP	Address Resolution Protocol

### B

BER	Bit Error Rate
BERT	Bit Error Rate Test
bps	Bit Per Second
Bps	Byte Per Second

### C

C	Current
CE	European Conformity
CRITIC	Critical
CRITIC/ECP	Critical and Emergency Call Processing

### D

dB	Decibel
dBm	Decibel - milliwatts
DHCP	Dynamic Host Configuration Protocol

## Glossary

### Acronym List

---

DS	Differentiated Services
DSCP	Differentiated Services Code Point
DTE	Data Terminal Equipment
DTS	Dual Test Set
DUT	Device Under Test

### E

ECN	Explicit Congestion Notification
ECP	Emergency Call Processing
EMC	Electromagnetic Compatibility
EOF	End Of Frame
ESD	Electrostatic Discharge

### F

FC	Fixed Connection
FCC	Federal Communications Commission
FCS	Frame Check Sequence
fps	frame per second

### G

Gbps	GigaBit Per Second
GMT	Greenwich Mean Time
GUA	Global IPv6 Address

**H**

HDTV	High Definition Television
Hz	Hertz

**I**

ICMP	Internet Control Message Protocol
ID	Identification
IEC	International Electrotechnical Commission
IEEE	Institute of Electrical & Electronics Engineers
IFG	Inter Frame Gap
IN	Input
IP	Internet Protocol
IPTV	Internet Protocol Television
IPv4	Internet Protocol version 4
IPv6	Internet Protocol version 6
ISO	International Organization for Standardization

**L**

L3	Layer 3
L4	Layer 4
LAN	Local Area Network
LC	Lucent Connector
LED	Light-Emitting Diode
lb	Pound

## Glossary

### Acronym List

---

If	Line Feed
LOS	Loss Of Signal
LLA	Link Local IPv6 Address

### M

m	Minute
m	Meter
MAC	Media Access Control
Mbps	Megabit Per Second
MDI	Media Dependant Interface (straight through Ethernet cable)
MDIX	Media Dependant Interface Crossover (crossover Ethernet cable)
ms	millisecond
MT-RJ	Mechanical Transfer Registered Jack
MTTR	Mean Time to Repair

### N

Nb	Number
NE	Network Element
nm	Nanometer



**O**

OS	Operating System
OUI	Organizationally Unique Identifier
OUT	OUTput

**P**

PC	Personal Computer
PHY	Physical Layer Device
ppm	parts per million
PRBS	Pseudo Random Bit Sequence
PSP	Primitive Sequence Protocol
PVID	Port VLAN Identifier

**Q**

QoS	Quality of Service
Q-in-Q	Queue in Queue – Stacked VLAN

**R**

RFC	Request For Comments
RJ-45	Registered Jack 45
RMA	Return Merchandise Authorization
RX	Receive

## Glossary

### Acronym List

---

#### S

s	second
SC	Subscriber Connector
SDTV	Standard Digital Television
SFP	Small Form Factor Pluggable
SLA	Service-Level Agreement
SONET	Synchronous Optical NETWORK
ST	Straight Tip
SUI	Smart User Interface

#### T

TCP	Transport Control Protocol
TLV	Type-Length Variable
TOS	Type Of Service
TTL	Time To Live
TX	Transmit

#### U

UAS	Unavailable Second
UDP	User Data Protocol
$\mu$ s	microsecond
UTC	Universal Time Coordinated
UTP	Unshielded Twisted Pair

## V

VID	VLAN Identifier
VLAN	Virtual Local Area Network
VoIP	Voice over Internet Protocol

## VLAN

### Special VID values (IEEE Std 802.1Q-1998)

ID	Description
0	The null VLAN ID. Indicates that the tag header contains only user priority information; no VLAN identifier is present in the frame. This VID value must not be configured as a PVID, configured in any Filtering Database entry, or used in any Management operation.
1	The default PVID value used for classifying frames on ingress through a Bridge Port. The PVID value can be changed on a per-Port basis.
4095	Reserved for implementation use. This VID value shall not be configured as a PVID, configured in any Filtering Database entry, used in any Management operation, or transmitted in a tag header.

### VLAN Priority

0	000 - Low Priority	4	100 - High Priority
1	001 - Low Priority	5	101 - High Priority
2	010 - Low Priority	6	110 - High Priority
3	011 - Low Priority	7	111 - High Priority

# Index

# Ping results table .....	190
? .....	20

## A

Abort Frames .....	179
Absolute .....	119, 180
accuracy .....	66, 69
acronym .....	237
Address .....	39, 151
address .....	42, 153
after-sales service .....	226
alarmed seconds .....	91, 116, 173
Alarms .....	116
alarms .....	91
Alarms/Errors Results .....	173
alignment .....	93, 118
attempts .....	189
Auto Detect .....	34
Auto-Negotiation .....	34
Average Round Trip Time (ms) .....	193
Average RX Rate .....	129
AXS-200/850 .....	1

## B

Background Stream .....	142, 144
Back-to-Back .....	60, 69
Back-to-Back Results .....	84
BERT Alarms and Errors .....	116
BERT Configuration Stream .....	14
BERT Detailed Results .....	113, 114
BERT Errors .....	113
BERT Global Configuration .....	99
BERT Results	
Alarms/Errors .....	14
Detailed .....	14
Summary .....	14

BERT Summary Results .....	107
BERT test configuration .....	28
Bit Error .....	113
Bit Error Amount .....	108
Bit Error Count .....	102, 109
Bit Error Rate .....	102, 109
Broadcast .....	176
Burst .....	130
Burst Duty Cycle .....	130
bytes .....	192

## C

cable .....	234
Cable Mode .....	34
Cable Test .....	16
Status .....	201
Cable Test Configuration .....	198
Cable Test Results - Delay/Length .....	207
Cable Test Results - Summary .....	201
Cable Test Results - Wire Map .....	203
caution	
of personal hazard .....	5
of product hazard .....	5
CE .....	vii, ix
class 1 .....	7
cleaning	
front panel .....	221
collision .....	93, 118
connection	
10/100/1000 Mbps .....	22
100/1000 Mbps .....	23
1000Base-LX .....	23
1000Base-SX .....	23
1000Base-T .....	22
1000Base-ZX .....	23
100Base-FX .....	23
100Base-LX10 .....	23
100Base-TX .....	22
10Base-T .....	22
connectors .....	21
Continuous .....	189

## Index

---

- conventions, safety ..... 5  
Copy from Throughput Test ..... 74  
copying files ..... 214  
Count ..... 167, 169  
Current RX Rate ..... 129  
customer service ..... 231
- D**
- data size ..... 189  
default  
    gateway ..... 42  
Default Configuration ..... 51  
Default Gateway ..... 42, 149, 153, 155  
delay ..... 189  
Delay Skew ..... 202  
Delay Skew Threshold ..... 200  
Delete ..... 211  
Delete Function ..... 54  
deleting files ..... 215  
Destination IP Address ..... 63, 133, 145  
Destination MAC Address .... 62, 103, 132, 144  
Destination UDP Port ..... 65  
DHCP ..... 37, 38  
DHCP Lease Expires ..... 38  
DHCP Lease Obtained ..... 38  
DHCP Lease Server ..... 38  
Discovery ..... 46  
Drop Eligible ..... 43, 155  
DS ..... 65, 106, 134, 135, 147  
DUPLEX ..... 22, 24  
Duration .... 76, 82, 84, 86, 101, 108, 127, 185
- E**
- Electrical ..... 34  
electrical interface ..... 22  
electrical port ..... 21  
equipment returns ..... 231  
ESD ..... 8  
Ethernet ..... 99, 142  
Ethernet/IP/UDP ..... 99, 142  
excessive collision ..... 93, 118
- EXFO service centers ..... 232  
Export ..... 54
- F**
- FCC ..... vii  
FCS ..... 93, 118  
Filename ..... 52  
Files ..... 211  
files  
    copying ..... 214  
    deleting ..... 215  
    manager ..... 214, 215  
Flow Control ..... 36  
Flow Control Results ..... 179  
folders  
    copying ..... 214  
    deleting ..... 215  
Frame Count Results ..... 176  
Frame Loss ..... 60, 71, 157  
Frame Loss Configuration ..... 71  
Frame Loss Results ..... 86  
Frame Size ..... 58, 90, 100, 128  
Frame size ..... 160  
Frame Size Results ..... 177  
Framing ..... 99, 142  
Frequency ..... 91  
front panel, cleaning ..... 221  
FTP ..... 215  
Full ..... 35
- G**
- glossary ..... 237  
Graph ..... 90  
graph displayed ..... 90  
GUA ..... 39, 150

<b>H</b>	
Half .....	35
Help .....	20
Home menu .....	12
Home menu structure .....	13
<b>I</b>	
IC.....	vii
identification label .....	226
Import .....	53
Inject .....	108
Interface.....	13
Interface Tabs.....	33
Internal Flash (Data) .....	209
Invert.....	101
IP Address .....	188, 194
IPv4 .....	37
IPv6 .....	38
<b>J</b>	
jabber.....	93, 118
Jitter/Latency Results .....	171
<b>L</b>	
label, identification .....	226
LASER .....	24, 25
Laser.....	34
laser .....	viii, 7
late collision .....	93, 118
Latency.....	60, 141
Latency Results.....	88
LED.....	21
DUPLEX.....	22, 24
electrical port.....	22
LASER .....	24, 25
laser.....	7
LINK.....	25
LINK/ACT.....	22, 24
optical port.....	24, 25
Length.....	202
Length Threshold.....	200
Length Unit .....	199
LINK.....	25
Link Down .....	91, 116
LINK/ACT.....	22, 24
LLA .....	38
Load .....	53
Log Full.....	120, 181
Logger .....	14, 15, 111, 180, 210
Loop Down.....	47
Loop Up.....	47
LOS.....	91, 116
<b>M</b>	
maintenance.....	221
front panel.....	221
general information .....	221
Manual.....	34
max. hop count.....	194
Max. Rate .....	82, 84, 86
Maximum Burst Duration .....	69
maximum rate .....	74
maximum rate - TX-to-RX .....	67, 71
Maximum Round Trip Time (ms).....	193
MDI .....	34
MDIX .....	34
Media Selector.....	52
menu structure.....	18
Minimum Round Trip Time (ms) .....	193
Mismatch '0' .....	113
Mismatch '1' .....	113
Mode.....	39, 150
mode.....	42
models.....	2
Module Setup.....	51
Multicast .....	176

# Index

---

## N

nb of validation .....	67
Nb. of Frames .....	58
Network Setup .....	37
No Traffic .....	113
No. ....	190
No. of Trials .....	84
No. trace route result table .....	196
Non-Unicast .....	176
Number of Trials .....	69, 73

## O

Open .....	211
Optical .....	34
optical interface .....	23
Out-of-Sequence .....	157

## P

Packets Received .....	193
Packets Transmitted .....	193
Pair .....	203, 207
Pass/Fail Verdict .....	199
Pass/Fail verdict .....	60
Pattern Loss .....	113
Pause .....	157
Pause Frames .....	179
Payload .....	128
Percentage Lost .....	193
Period .....	130
Ping .....	187
Ping Configuration .....	188
ping configuration .....	31
Ping Results .....	190
ports .....	21
power sources .....	9
product	
identification label .....	226
specifications .....	233
Prop. Delay .....	201
Prop. Delay Threshold .....	200

## Q

Quick Ping .....	48, 63, 104, 133
------------------	------------------

## R

Ramp .....	130
Ramp Nb. of Steps .....	131
Rate .....	167, 169
Rate Unit .....	46, 61, 99, 127
Refresh Status .....	48
Relative .....	119, 180
Remote ID .....	49, 51
Remote Loopback .....	45
Removable Disk (USB) .....	209
replied from .....	192, 197
Report .....	76, 109, 187, 192, 197
Report Header .....	209
Report Manager Configuration .....	209
Report Prompt .....	209
Report Title .....	209
Reset .....	109
Resolve MAC Address ..	62, 104, 132, 133, 145
Restore Default at Start-Up .....	51
Restore RFC Defaults .....	61
Restore Threshold Defaults .....	200
Results In .....	82, 84, 87
return merchandise authorization (RMA) ..	231
RFC 2544	
Back-to-Back .....	14
Configuration .....	14
Frame Loss .....	14
Latency .....	14
Stream .....	14
Throughput .....	14
RFC 2544 Alarms and Errors .....	91
RFC 2544 Configuration .....	14, 58
RFC 2544 Errors .....	93, 118
RFC 2544 Global Configuration .....	58
RFC 2544 Results	
Alarms/Errors .....	14
Back-to-back .....	14
Frame Loss .....	14



Graph .....	14
Latency .....	14
Summary .....	14
Throughput .....	14
RFC 2544 Results Graph .....	90
RFC 2544 Stream Configuration .....	62, 132
RJ-45 connector .....	216
runt .....	93, 118
RX .....	193
RX Frames .....	77
RX Rate .....	108, 165, 185

## S

safety	
caution .....	5
conventions .....	5
laser .....	7
warning .....	5
Save .....	53
Scan Subnet .....	46
SDT .....	102, 114
Average .....	115
Count .....	115
Last .....	114
Longest .....	108, 114
Shortest .....	114
Threshold .....	114
Total .....	115
Seconds .....	167, 169
Sel/Unsel All Function .....	55
Sel/Unsel Function .....	54
Sequence Results .....	167
Sequence Tracking .....	136
service and repairs .....	231
service centers .....	232
Service Disruption .....	114
Setup .....	13
Setup Interface	
Network .....	13
Port .....	13
SFP .....	13
VLAN .....	13
Setup Module .....	13
Setup Remote .....	13
Discovery .....	13
Loopback .....	13
SFP .....	4, 225
Connector Type .....	44
Mode .....	44
Module ID .....	44
Part Number .....	44
Serial Number .....	44
Speed .....	44
Type .....	44
Vendor Name .....	44
Wavelength .....	44
shipping to EXFO .....	231
signal connection .....	21
Smart Loopback .....	15
Smart Loopback configuration .....	31
smart loopback statistics .....	185
software options, keys .....	3
Source UDP Port .....	65, 106, 134, 135
special VID values .....	244
specifications, product .....	233
Start Time .....	76, 108, 185
Status .. 48, 76, 82, 84, 86, 107, 156, 191, 201	
Address .....	42
status .....	196
generating .....	39, 150
Step .....	87
Step Time .....	131
storage requirements .....	221
subnet mask .....	38
Symbol .....	93, 118
symbols, safety .....	5
System Information	
About .....	17
Application .....	17
Components .....	17
Memory .....	17
Module .....	17
Platform .....	17

# Index

---

- System menu ..... 213
- System Settings
  - Date and Time ..... 17
  - Display and Language..... 17
  - Power ..... 17
- System Software Options
  - Module ..... 17
  - Platform..... 17
- System tabs ..... 213
- System Utilities
  - File Manager..... 17
  - VNC ..... 17

**T**

- tab
  - Back-to-Back..... 69
  - Back-to-Back Results ..... 84
  - BERT Global Configuration ..... 99
  - Cable Test Configuration ..... 198
  - Cable Test Results - Delay/Length..... 207
  - Cable Test Results - Summary ..... 201
  - Cable Test Results - Wire Map..... 203
  - Discovery ..... 46
  - Frame Loss..... 71
  - Frame Loss Configuration ..... 71
  - Frame Loss Results..... 86
  - Latency Results ..... 88
  - Network Setup..... 37
  - Ping Configuration ..... 188
  - Report Manager Configuration ..... 209
  - RFC 2544 Alarms and Errors ..... 91
  - RFC 2544 Global Configuration ..... 58
  - RFC 2544 Results Graph..... 90
  - RFC 2544 Stream Configuration .... 62, 132
  - Throughput Configuration..... 66
  - Throughput Results ..... 82
  - Trace Route Configuration..... 194
  - Trace Route Results..... 195
- Tabs ..... 18
- technical specifications ..... 233
- technical support ..... 226

- temperature for storage ..... 221
- Test Pattern ..... 100
- Test Time ..... 66
- test time ..... 66, 71, 73
- Threshold ..... 82, 84, 86, 102, 109, 167, 169
- Throughput ..... 60
- Throughput Configuration ..... 66
- Throughput Results ..... 82, 165
- time ..... 192, 197
- Time Mode ..... 119, 180
- time to live ..... 189
- timeout ..... 189, 194
- Tools Cable Test..... 16
- Tools Ping
  - Configuration ..... 16
  - Results ..... 16
  - Statistics ..... 16
- Tools Report
  - Configuration ..... 16
  - File ..... 16
- Tools Trace Route
  - Configuration ..... 16
  - Results ..... 16
- TOS..... 64, 105, 134, 146
- TOS/DS ..... 64, 105, 134, 146
- Total RX Frame Count..... 185
- Total Tx Frame Count..... 185
- Trace Route ..... 187
- trace route..... 194
  - No. table column ..... 196
- Trace Route Configuration..... 194
- Trace Route configuration ..... 32
- Trace Route Results..... 195

---

Traffic Generation & Monitoring .....	125
Transceiver Mode .....	34
transportation requirements .....	221, 227
Trial # .....	76
troubleshooting .....	225
TTL .....	64, 105, 134, 146, 192
TX Frames .....	77
TX Rate .....	165
Tx Rate .....	99, 108, 185
type of service .....	189

## U

undersize .....	93, 118
Unicast .....	176
User Defined frame size .....	60
User Information .....	209

## V

Verdict Threshold .....	67, 70, 72, 74
VID .....	244
VLAN .....	43, 244
VLAN ID .....	43
VLAN Priority .....	43, 244
VLAN Type .....	43
VLAN, priority .....	244

## W

warranty .....	229
certification .....	230
exclusions .....	230
general .....	229
liability .....	230
null and void .....	229
Wire Map .....	201
Wire Map Test Result .....	204
Wiring Standard .....	199

**NOTICE**  
**通告**

**CHINESE REGULATION ON RESTRICTION OF HAZARDOUS SUBSTANCES**  
**中国关于有害物质限制的规定**



NAMES AND CONTENTS OF THE TOXIC OR HAZARDOUS SUBSTANCES OR ELEMENTS  
CONTAINED IN THIS EXFO PRODUCT  
包含在本 **EXFO** 产品中的有毒有害物质或元素的名称和含量

O	Indicates that this toxic or hazardous substance contained in all of the homogeneous materials for this part is below the limit requirement in SJ/T11363-2006 表示该有毒有害物质在该部件所有均质材料中的含量均在 SJ/T11363-2006 标准规定的限量要求以下。
X	Indicates that this toxic or hazardous substance contained in at least one of the homogeneous materials used for this part is above the limit requirement in SJ/T11363-2006 表示该有毒有害物质至少在该部件的某一均质材料中的含量超出 SJ/T11363-2006 标准规定的限量要求。

Part Name 部件名称	Toxic or hazardous Substances and Elements 有毒有害物质和元素					
	Lead 铅 (Pb)	Mercury 汞 (Hg)	Cadmium 镉 (Cd)	Hexavalent Chromium 六价铬 (Cr VI)	Polybrominated biphenyls 多溴联苯 (PBB)	Polybrominated diphenyl ethers 多溴二苯醚 (PBDE)
Enclosure 外壳	O	O	O	O	O	O
Electronic and electrical sub-assembly 电子和电子组件	X	O	X	O	X	X
Optical sub-assembly <sup>a</sup> 光学组件 <sup>a</sup>	X	O	O	O	O	O
Mechanical sub-assembly <sup>a</sup> 机械组件 <sup>a</sup>	O	O	O	O	O	O

a. If applicable.  
如果适用。

MARKING REQUIREMENTS  
标注要求

Product 产品	Environmental protection use period (years) 环境保护使用期限 (年)	Logo 标志
This Exfo product 本 EXFO 产品	10	
Battery <sup>a</sup> 电池 <sup>a</sup>	5	

- a. If applicable.  
如果适用。

P/N: 1057574

[www.EXFO.com](http://www.EXFO.com) · [info@exfo.com](mailto:info@exfo.com)

<b>CORPORATE HEADQUARTERS</b>	400 Godin Avenue	Quebec (Quebec) G1M 2K2 CANADA Tel.: 1 418 683-0211 · Fax: 1 418 683-2170
<b>EXFO AMERICA</b>	3701 Plano Parkway, Suite 160	Plano TX, 75075 USA Tel.: 1 972 907-1505 · Fax: 1 972 836-0164
<b>EXFO EUROPE</b>	Omega Enterprise Park, Electron Way	Chandlers Ford, Hampshire S053 4SE ENGLAND Tel.: +44 2380 246810 · Fax: +44 2380 246801
<b>EXFO ASIA-PACIFIC</b>	151 Chin Swee Road #03-29, Manhattan House	SINGAPORE 169876 Tel.: +65 6333 8241 · Fax: +65 6333 8242
<b>EXFO CHINA</b>	No. 88 Fuhua First Road, Central Tower, Room 801, Futian District	Shenzhen 518048 P. R. CHINA Tel.: +86 (755) 8203 2300 · Fax: +86 (755) 8203 2306
	Beijing New Century Hotel Office Tower, Room 1754-1755, No. 6 Southern Capital Gym Road	Beijing 100044 P. R. CHINA Tel.: +86 (10) 6849 2738 · Fax: +86 (10) 6849 2662
<b>EXFO SERVICE ASSURANCE</b>	285 Mill Road	Chelmsford MA, 01824 USA Tel.: 1 978 367-5600 · Fax: 1 978 367-5700
<b>TOLL-FREE</b>	(USA and Canada)	1 800 663-3936

© 2009 EXFO Electro-Optical Engineering Inc. All rights reserved.  
Printed in Canada (2009-12)

