

FIP-400B Series

Fiber Inspection Probe and ConnectorMax2

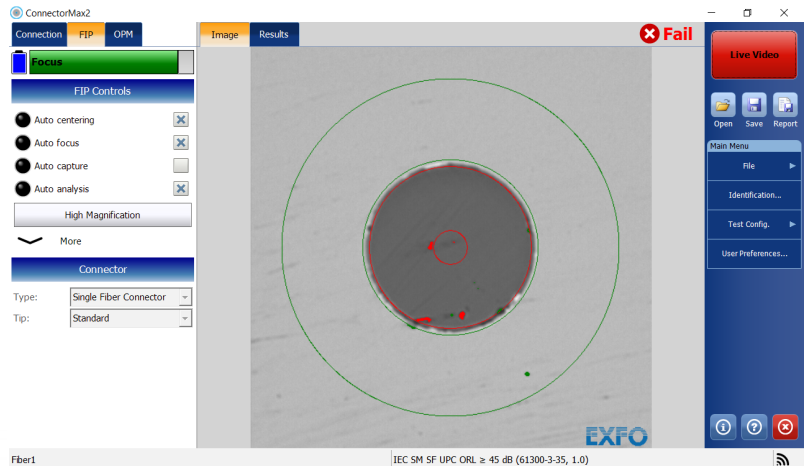

Copyright © 2013–2019 EXFO Inc. All rights reserved. No part of this publication may be reproduced, stored in a retrieval system or transmitted in any form, be it electronically, mechanically, or by any other means such as photocopying, recording or otherwise, without the prior written permission of EXFO Inc. (EXFO).

Information provided by EXFO is believed to be accurate and reliable. However, no responsibility is assumed by EXFO for its use nor for any infringements of patents or other rights of third parties that may result from its use. No license is granted by implication or otherwise under any patent rights of EXFO.

EXFO's Commerce And Government Entities (CAGE) code under the North Atlantic Treaty Organization (NATO) is 0L8C3.

The information contained in this publication is subject to change without notice.

Trademarks

EXFO's trademarks have been identified as such. However, the presence or absence of such identification does not affect the legal status of any trademark.

Units of Measurement

Units of measurement in this publication conform to SI standards and practices.

Patents

Feature(s) of this product is/are protected by one or more of: US design patent D713751 and equivalents in other countries; US design patent D751434 and equivalents in other countries; US design patent D742394; US patent 9,841,579 and equivalent patent(s) pending and/or granted in other countries; US patent 9,921,373; patent appl. US 2017/0003195 A1 and equivalent patent(s) pending and/or granted in other countries; US 2019/0170610 A1 and equivalent patent(s) pending and/or granted in other countries; and/or other US design patent pending.

Version number: 20.0.0.1

Contents

Regulatory Information	v
1 Introducing the FIP-400B Series Fiber Inspection Probe and ConnectorMax2	1
Probe	2
Available Probe Models	6
Probe Tips	7
Probe LED Indicators	8
Using Your Unit with TestFlow	10
ConnectorMax2 Software	11
Technical Specifications	12
Conventions	13
2 Safety Information	15
Other Safety Symbols on Your Unit	17
Electrical Safety Information	18
3 Setting up Your Fiber Inspection Probe and ConnectorMax2	23
Connecting or Disconnecting the Wireless Probe	23
Setting the Automatic Connection	26
Changing the Fiber Inspection Probe Tip	28
Changing the FIP Nozzle (MF-Ready Probes Only)	29
Selecting the Multifiber Tip Type (MF-Ready Probes Only)	35
Adjusting Brightness	36
Setting up Autonaming	38
Managing and Selecting Test Configurations	45
Setting the Default Storage Folder	62
Enabling the Multifiber Inspection as a Batch (Manual-Scanning Tip)	63
Displaying Multifiber Connector Overlay (Manual-Scanning Tip)	64
Stopping the Analysis Process on First Fail (3-Step Inspections Only)	66
Editing the Power Meter Test Configurations	67
Reverting to Factory Settings	69
Changing Fiber Information of Existing Captures	70

Contents

4 Inspecting Fiber Ends	71
Inspecting Fiber Ends (Single Fiber and Transceiver - Fiber Receptacles)	71
Inspecting Multiple Fiber Ends	77
Retesting Fibers of Connectors With Multifiber Ends (Manual-Scanning Tip)	109
Saving Files	113
Opening Files	117
Analyzing Captures	118
Displaying or Hiding the Power Meter and VFL Controls	126
Clearing Power Meter Measurements Automatically	127
Measuring Power or Insertion Loss	128
Viewing Power Meter Results	129
Identifying Fiber Faults Visually with the VFL	130
Creating Reports	131
Updating the Firmware and Software	135
5 Maintenance	139
General Maintenance	139
Battery Safety Recommendations	140
Cleaning MPO-Type Connectors	141
Cleaning Lenses	142
Recharging the Battery (FIP-415B/425B/435B Models Only)	143
Replacing the Battery (FIP-415B/425B/435B Models Only)	144
Recycling and Disposal	146
6 Troubleshooting	147
Solving Common Problems	147
Changing the File Contents (3-Step Inspections Only)	151
Contacting the Technical Support Group	152
Viewing Information About ConnectorMax2	152
Viewing Online Help	152
Transportation	153
7 Warranty	155
General Information	155
Liability	156
Exclusions	156
Certification	156
Service and Repairs	157
EXFO Service Centers Worldwide	158
A Fiber Inspection Probe Tip Compatibility Chart	159
Index	165

Regulatory Information

Canada and USA Electromagnetic Interference Regulatory Statement

Electronic test and measurement equipment is exempt from FCC part 15, subpart B compliance in the United States of America and from ICES-003 compliance in Canada. However, EXFO Inc. makes reasonable efforts to ensure compliance to the applicable standards.

The limits set by these standards are designed to provide reasonable protection against harmful interference when the equipment is operated in a commercial environment. This equipment generates, uses, and can radiate radio frequency energy and, if not installed and used in accordance with the user documentation, may cause harmful interference to radio communications. Operation of this equipment in a residential area is likely to cause harmful interference in which case the user will be required to correct the interference at his own expense.

Modifications not expressly approved by the manufacturer could void the user's authority to operate the equipment.

European Electromagnetic Compatibility Regulatory Statement

Warning: This is a class A product. In a domestic environment, this product may cause radio interference in which case the user may be required to take adequate measures. Your product is certified for (or is suitable for) use in industrial electromagnetic environments.

Canada and USA Wireless Compliance Related Information

The wireless probe comes with an internal wireless module (adapter) and antenna for which the information hereafter applies:

- This product does not contain any wireless user-serviceable components. Any unauthorized product changes or modifications will invalidate warranty and all applicable regulatory certifications and approvals.
- This device complies with Part 15 of the FCC Rules.
- This device complies with Innovation, Sciences and Economic Development Canada license-exempt RSS standards.
- Operation is subject to the following two conditions:
 - (1) This device may not cause harmful interference
 - and
 - (2) this device must accept any interference received, including interference that may cause undesired operation.

Use in Specific Environments:

- The use of wireless products in hazardous locations is limited by the constraints posed by the safety directors of such environments.
- The use of wireless products on airplanes is governed by the Federal Aviation Administration (FAA).
- The use of wireless products in hospitals is restricted to the limits set forth by each hospital.
- Do not operate a portable transmitter near unshielded blasting caps or in an explosive environment.

Radiation Exposure Statement:

- The product complies with the US/Canada portable RF exposure limit set forth for an uncontrolled environment and is safe for intended operation as described in this user documentation.
- Further RF exposure reduction can be achieved if the device can be kept as far as possible from the user's body.

European Community Wireless Compliance Related Information

The information about the Wi-Fi frequency bands is as follows:

Between the frequencies 2400.0 MHz - 2483.5 MHz.

The maximum output power is 15 dBm.

This device is a 2.4 GHz wideband transmission system (transceiver), intended for use in all EU member states and EFTA countries, except in France and Italy where restrictive use applies.

In Italy, the end-user should apply for a license at the national spectrum authorities in order to obtain authorization to use the device for setting up outdoor radio links and/or for supplying access to telecommunications and/or network services.

This device may not be used for setting up radio links in France, and in some areas the RF output power may be limited to 10 mW EIRP in the frequency range of 2454 - 2483.5 MHz. For detailed information, the end-user should contact the national spectrum authority in France.

Local Restrictions on 802.11a, 802.11b, 802.11d, 802.11g, 802.11n, and 802.11ac Radio Usage

Due to the fact that the frequencies used by 802.11a, 802.11b, 802.11d, 802.11g, 802.11n, and 802.11ac wireless LAN devices may not yet be harmonized in all countries, 802.11a, 802.11b, 802.11d, 802.11g, 802.11n, and 802.11ac products are designed for use only in specific countries, and are not allowed to be operated in countries other than those of designated use. As a user of these products, you are responsible for ensuring that the products are used only in the countries for which they were intended and for verifying that they are configured with the correct selection of frequency and channel for the country of use.

European Declaration of Conformity

Hereby, EXFO declares that the radio equipment type “Wideband Data Transmission” is in compliance with European Directive 2014/53/EU.

The full text of the EU declaration of conformity is available at the following Internet address: www.exfo.com/en/resources/legal-documentation.

Japanese Technical Conformity Mark for Radio Law

Technical parameters:

- Standards: IEEE 802.11b/g/n
- Operation Frequency: 2412 ~ 2483.5 MHz
- Throughput: 150 Mbps, 1T1R

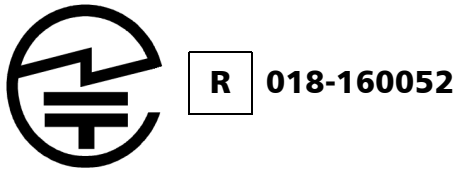

1 **Introducing the FIP-400B Series Fiber Inspection Probe and ConnectorMax2**

The FIP-400B Series Fiber Inspection Probe is a portable video microscope used to inspect fiber ends. Unlike traditional microscopes, the FIP-400B Series facilitates the examination of patchcord connectors and also hard-to-reach connectors on the back of patch panels and bulkhead adapters.

There are two different types of probes:

- USB-wired probes, that are connected to platforms
- wireless probes, that can be connected with a Wi-Fi or USB connection to platforms or with a Wi-Fi connection to a mobile smart device (Android or iOS)
 - standard wireless probes can inspect single fibers and transceivers
 - MF-Ready probes can inspect single fibers, transceivers and multifiber connectors.

Note: *The appearance of the application may vary with operating systems and units.*

Note: *In this documentation, the words “tap” and “double-tap” (related to the use of a touchscreen) replace the words “click” and “double-click”.*

Introducing the FIP-400B Series Fiber Inspection Probe and ConnectorMax2

Probe

Probe

The FIP-400B Series is designed to be an intuitive, easy-to-use piece of equipment. This video microscope is used for inspecting fiber ends.

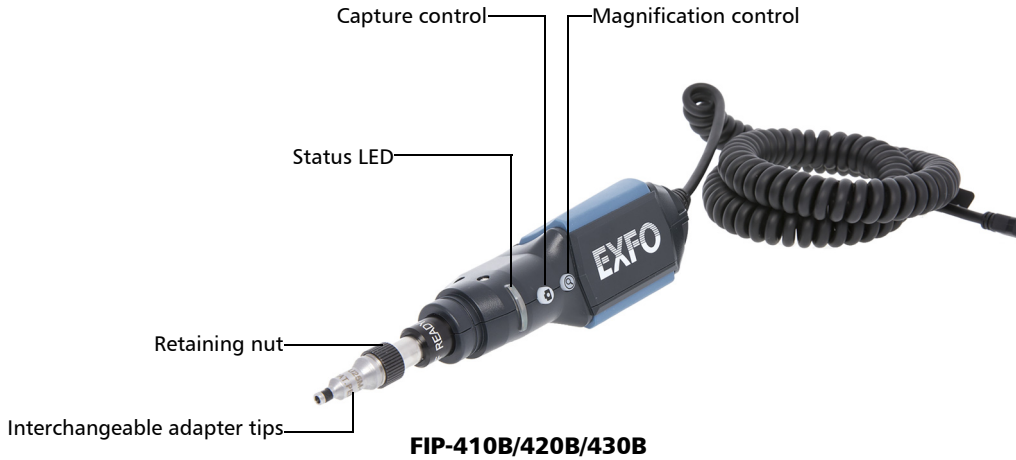

Introducing the FIP-400B Series Fiber Inspection Probe and ConnectorMax2

Probe

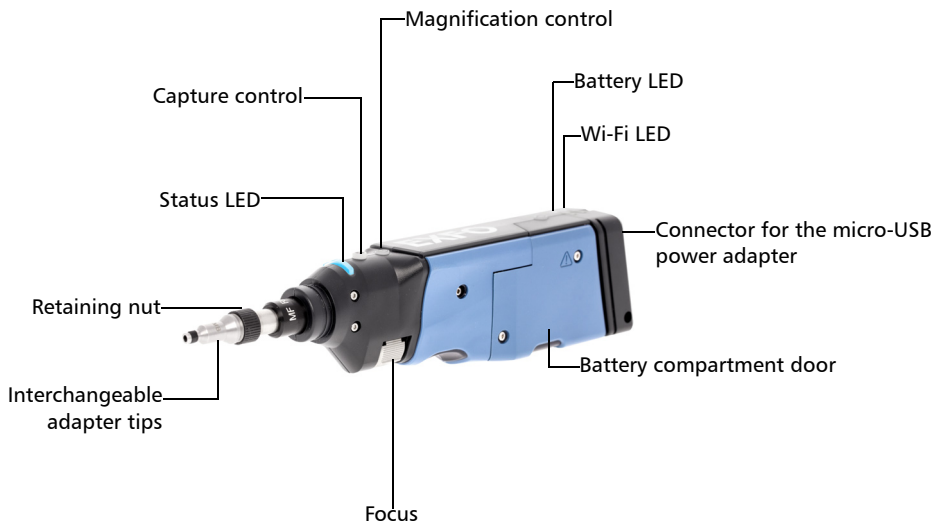

FIP-425B/435B

Introducing the FIP-400B Series Fiber Inspection Probe and ConnectorMax2

Probe

MF-Ready probe with inspection tip and removable nozzle

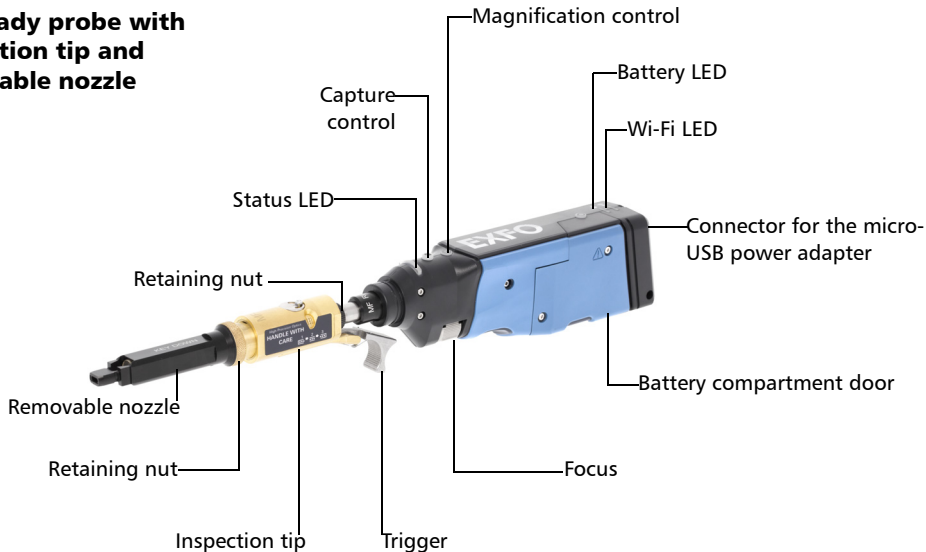

FIP-415B/425B/435B MF-Ready

- The focus knob can be turned in either direction to focus the image.
- The magnification control button allows you to shift between three levels of magnification. When pressed for one second, it activates the auto focus. See *Analyzing Captures* on page 118 for details.
- The capture control button allows you to capture an image, perform an analysis, or return to the live video mode.
- The retaining nut holds tips securely in place, ensuring they are always fastened in the correct position.

- The status LED gives you information about the probe or the analysis results. See *Probe LED Indicators* on page 8 for details.
- The battery LED indicates the charge status of the probe. See *Probe LED Indicators* on page 8 for details.
- The Wi-Fi LED gives you information about the transmission process. See *Probe LED Indicators* on page 8 for details.
- The interchangeable adapter tips give you the possibility to use various tips depending on the type of connector you are inspecting. See *Changing the Fiber Inspection Probe Tip* on page 28 for details.
- Removable nozzles can be used with MF-Ready probes to inspect multifiber dense panels. See *Changing the FIP Nozzle (MF-Ready Probes Only)* on page 29 for details.
- The micro-USB power adapter recharges the battery of the probe when it is low. You can recharge the battery with the provided USB cable and the power adapter that you connect to a power outlet. You can also use the provided USB cable alone that you connect to a USB port of a computer. See *Recharging the Battery (FIP-415B/425B/435B Models Only)* on page 143 for details.

When the probe is connected to a power outlet or to a USB port, it still works via Wi-Fi.

- The battery compartment door is for battery replacement. See *Replacing the Battery (FIP-415B/425B/435B Models Only)* on page 144 for details.
- The trigger allows you to inspect single-row or dual-row multifiber connectors.
- The design of the inspection tip enables you to connect any of the interchangeable nozzles.

The probe comes equipped with a protective cap that fits over basic tips; therefore, you do not need to remove the tip before putting the cap on.

Introducing the FIP-400B Series Fiber Inspection Probe and ConnectorMax2

Available Probe Models

Available Probe Models

The features available for your probe are automatically detected when you connect it to your unit. The table below shows which feature is available for each model.

Models	Inspection	Auto analysis	Auto centering	Auto focus	Auto capture	Wireless
FIP-410B	X	-	-	-	-	-
FIP-415B MF-Ready	X	X ^a	X ^b	X	X ^b	X
FIP-420B	X	X	X	-	-	-
FIP-425B	X	X	X	-	-	X
FIP-425B MF-Ready	X	X	X ^b	-	-	X
FIP-430B	X	X	X	X	X	-
FIP-435B	X	X	X	X	X	X
FIP-435B MF-Ready	X	X	X ^b	X	X ^b	X

- a. Contact EXFO to purchase this option.
- b. This feature is available when testing single fibers and transceivers. It is disabled when multifiber connectors are inspected.

Note: When the internal temperature of the FIP-415B, FIP-430B and FIP-435B is too low, the probe performs a warmup that can last up to a minute.

Probe Tips

The FIP-400B Series comes with two interchangeable tips included in two different packages (UPC or APC). Additional models are also available.

- UPC package:
 - FIPT-400-FC-SC: FC-SC Bulkhead tip
 - FIPT-400-U25M: Universal patchcord tip (2.5 mm ferrule)
- APC package:
 - FIPT-400-SC-APC: SC APC tip for bulkhead adapter
 - FIPT-400-U25MA: Universal patchcord tip for 2.5 mm ferrules

Other tip models are available for various bulkhead adapters and patchcord connectors. For more information about tips and their use, see the *Fiber Inspection Probe Tip Compatibility Chart* on page 159, or visit the EXFO Web site.

Introducing the FIP-400B Series Fiber Inspection Probe and ConnectorMax2

Probe LED Indicators

Probe LED Indicators

The LEDs located on the probe give you information about the probe or the analysis results.

FIP-410B/420B/430B



Status LED	Meaning
Flashing blue	<ul style="list-style-type: none">▶ Detection of the probe in progress.▶ Analysis in progress.▶ Waiting mode. The auto focus process starts automatically when you insert an optical fiber connector (FIP-430B only).▶ Auto focus in progress (FIP-430B only).▶ Probe is initializing.
Flashing red	There is a major problem preventing the probe from functioning properly.
Blue	<ul style="list-style-type: none">▶ Probe detected and ready.▶ On a computer, the USB port is in suspend mode.
Red	In capture mode, current FIP result status is Fail (FIP-420B and FIP-430B).
Green	In capture mode, current FIP result status is Pass (FIP-420B and FIP-430B).

Introducing the FIP-400B Series Fiber Inspection Probe and ConnectorMax2

Probe LED Indicators

FIP-415B/425B/435B



Status LED	Meaning
Flashing blue	Processing data.
Flashing red	<ul style="list-style-type: none">➤ There is a problem with the probe. Follow the instructions on screen.➤ The auto focus is in timeout.➤ There is an analysis error.
Blue	The probe is ready and operational.
Red	In capture mode, current FIP result status is Fail.
Green	In capture mode, current FIP result status is Pass.

Introducing the FIP-400B Series Fiber Inspection Probe and ConnectorMax2

Using Your Unit with TestFlow

Battery LED	Meaning
Flashing blue	USB connected, battery charging.
Blue	USB connected, battery fully charged.
Red	Battery error (only visible when connected to a USB cable).
Flashing yellow	USB connected, battery not charging because its temperature does not allow the charging process.
Yellow	USB not connected, battery level is critical.
Not lit	USB not connected, battery above low level.

Wi-Fi LED	Meaning
Blue	<ul style="list-style-type: none">➤ Ready to transmit.➤ Wireless transmission in progress.
Red	Transmission error.
Not lit	<ul style="list-style-type: none">➤ Probe is off.OR➤ Probe is initializing.

Using Your Unit with TestFlow

You can use this product for your test jobs in the TestFlow application. For more information about using TestFlow or other instruments as part of your tests, refer to the corresponding user documentation.

Note: *Some of the features for your product are not available while in TestFlow mode.*

ConnectorMax2 Software

ConnectorMax2 is the application used to view the fiber inspections. You can also use specific test configurations and analyze the fibers automatically upon capturing a picture.

All models, except MF-Ready probes testing multifiber connectors

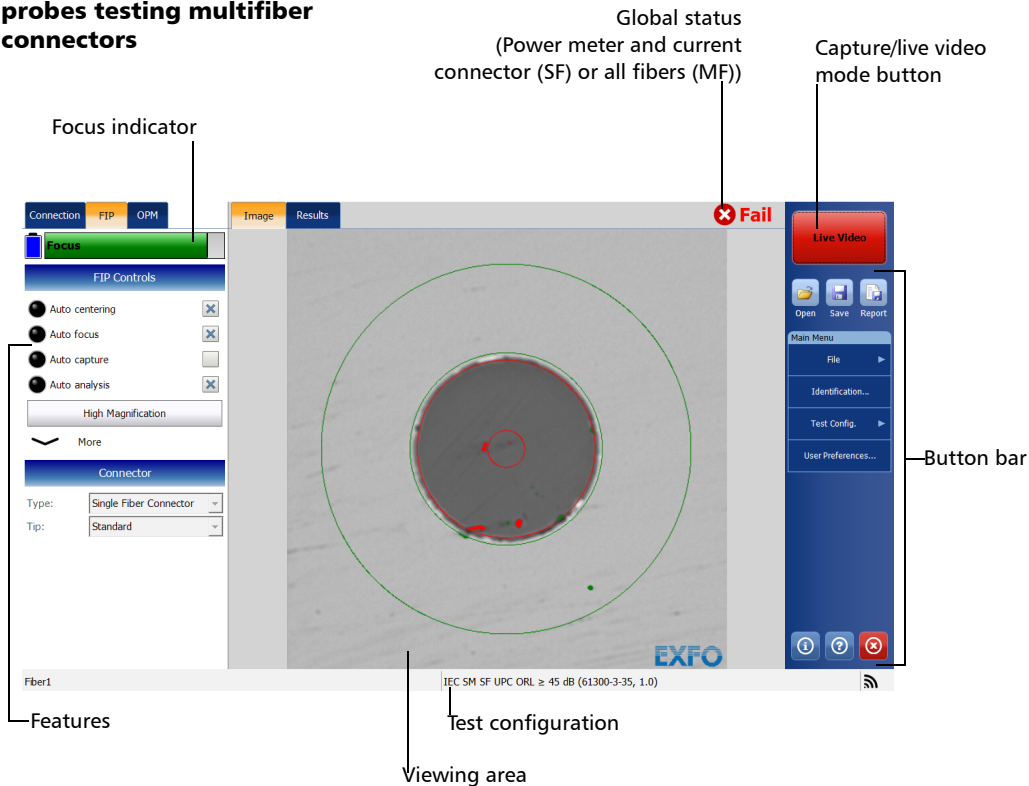

Introducing the FIP-400B Series Fiber Inspection Probe and ConnectorMax2

Technical Specifications

FIP-415B/425B/435B MF-Ready probes testing multifiber connectors

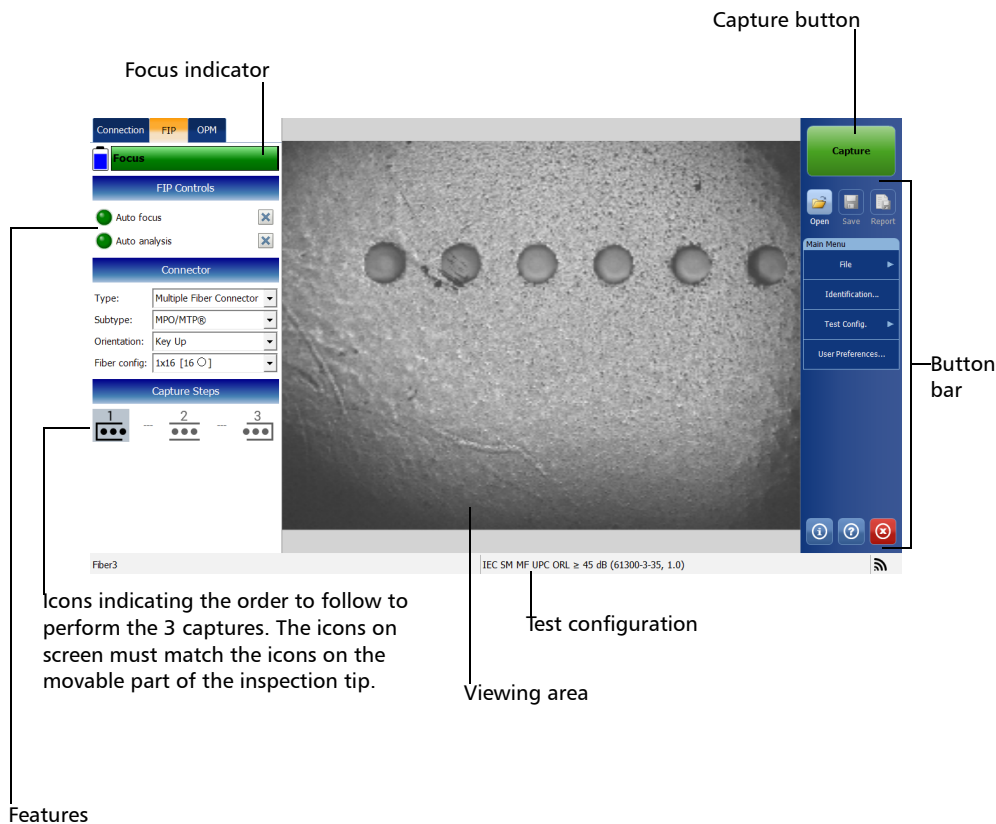

Technical Specifications

To obtain this product's technical specifications, visit the EXFO Web site at www.exfo.com.

Conventions

Before using the product described in this guide, you should understand the following conventions:



WARNING

Indicates a potentially hazardous situation which, if not avoided, could result in *death or serious injury*. Do not proceed unless you understand and meet the required conditions.



CAUTION

Indicates a potentially hazardous situation which, if not avoided, may result in *minor or moderate injury*. Do not proceed unless you understand and meet the required conditions.



CAUTION

Indicates a potentially hazardous situation which, if not avoided, may result in *component damage*. Do not proceed unless you understand and meet the required conditions.



IMPORTANT

Refers to information about this product you should not overlook.

2 **Safety Information**



WARNING

Do not install or terminate fibers while a light source is active. Never look directly into a live fiber and ensure that your eyes are protected at all times.



WARNING

The use of controls, adjustments and procedures, namely for operation and maintenance, other than those specified herein may result in hazardous radiation exposure or impair the protection provided by this unit.



WARNING

If the equipment is used in a manner not specified by the manufacturer, the protection provided by the equipment may be impaired.



WARNING

Use only accessories designed for your unit and approved by EXFO. For a complete list of accessories available for your unit, refer to its technical specifications or contact EXFO.



IMPORTANT

Refer to the documentation provided by the manufacturers of any accessories used with your EXFO product. It may contain environmental and/or operating conditions limiting their use.



IMPORTANT

When you see the following symbol on your unit , make sure that you refer to the instructions provided in your user documentation. Ensure that you understand and meet the required conditions before using your product.



IMPORTANT

When you see the following symbol on your unit , it indicates that the unit is equipped with a laser source, or that it can be used with instruments equipped with a laser source. These instruments include, but are not limited to, modules and external optical units.



IMPORTANT

Other safety instructions relevant for your product are located throughout this documentation, depending on the action to perform. Make sure to read them carefully when they apply to your situation.













CAUTION

Do not use the fiber probe outdoors in wet locations.

Other Safety Symbols on Your Unit

One or more of the following symbols may also appear on your unit.

Symbol	Meaning
	Direct current
	Alternating current
	The unit is equipped with an earth (ground) terminal.
	The unit is equipped with a protective conductor terminal.
	The unit is equipped with a frame or chassis terminal.
	On (Power)
	Off (Power)
	On/off (Power)
OR 	
	Fuse

Electrical Safety Information



WARNING

- If you need to ensure that the unit is completely turned off, disconnect the USB cable and remove the battery. For more information on how to remove the battery, see the section about replacing the battery in this user documentation
- Use the external electrical power supply (USB power adapter) indoors only.
- Never connect the unit to the AC mains (with the USB power adapter) when it is used outdoors.
- Never connect the unit to a computer with the USB cable when it is used outdoors.
- To avoid electrical shock, do not operate the unit if any part of the outer surface (covers, panels, etc.) is damaged.
- Only authorized personnel should carry out adjustments, maintenance or repair of opened units under voltage. A person qualified in first aid must also be present. Do not replace any components while the USB cable and battery are connected.



WARNING

- Unless otherwise specified, all interfaces are intended for connection to Safety Extra Low Voltage (SELV) circuits only.
- Capacitors inside the unit may be charged even if the unit has been disconnected from its electrical supply.
- Use only the listed and certified USB power adapter provided by EXFO with your unit. It provides reinforced insulation between primary and secondary, and is suitably rated for the country where the unit is sold.
- When you use the unit outdoors, ensure that it is protected from liquids, dust, direct sunlight, precipitation, and full wind pressure.



CAUTION

- Position the unit so that the air can circulate freely around it.
- The use of voltages higher than those indicated on the label affixed to your unit may damage the unit.

Safety Information

Electrical Safety Information

Equipment Ratings for FIP-410B/FIP-420B/FIP-430B

Equipment Ratings	
Temperature	
▶ Operation	-10 °C to 50 °C (14 °F to 122 °F)
▶ Storage	-40 °C to 70 °C (-40 °F to 158 °F)
Relative humidity	0 % to 95 % non-condensing
Maximum operation altitude	2000 m (6562 ft)
Pollution degree	3 ^a
Overvoltage category	I

- a. Equipment should be normally protected against exposure to direct sunlight, precipitations and full wind pressure.

Equipment Ratings for FIP-415B/FIP-425B/FIP-435B

Equipment Ratings	
Temperature ➤ Operation ➤ Storage	➤ Unit powered by batteries: -10 °C to 40 °C (14 °F to 104 °F) ➤ Unit connected to USB power adapter: 0 °C to 40 °C (32 °F to 104 °F) ➤ Unit without batteries: -40 °C to 70 °C (-40 °F to 158 °F) ➤ Unit with batteries: -20 °C to 60 °C (-4 °F to 140 °F)
Relative humidity ^a	➤ unit: ≤ 95 % non-condensing ➤ USB power adapter: 5 % to 95 % for storage and 8 % to 90 % for operating temperature
Maximum operation altitude	➤ 2000 m (6562 ft) (unit connected to USB power adapter) ➤ 3000 m (9843 ft) (unit operated from batteries)
Pollution degree	➤ 2 (unit connected to external USB power adapter) ➤ 3 (unit operated from batteries) ^b
Overvoltage category	➤ unit: I ➤ USB power adapter: II
Measurement category	Not rated for measurement categories II, III, or IV
Input power ^c	➤ unit: --- 5 VDC; 1.8 A ➤ USB power adapter: ~ 100 - 240 Vac; 50 Hz to 60 Hz; 0.4 A Max

a. Measured in 0 °C to 31 °C (32 °F to 87.8 °F) range, decreasing linearly to 50 % at 40 °C (104 °F).

b. Equipment must be normally protected against exposure to direct sunlight, precipitation and full wind pressure.

c. Not exceeding ± 10 % of the nominal voltage.

3 **Setting up Your Fiber Inspection Probe and ConnectorMax2**

You can change several settings in ConnectorMax2, such as the default storage location or the automated file name. These settings are stored for each user and kept for future work sessions.

Connecting or Disconnecting the Wireless Probe



IMPORTANT

- Working with a wireless probe is not possible on FTB-200v2 and IQS platforms.
- On supported platforms, the Wi-Fi option must be installed and the wireless communication must be enabled if you want to work with a wireless probe. For more information, refer to the corresponding user guide.

When your wireless probe is detected, it is added to the list of the available probes. The probes are identified by their serial numbers and type.

It is also possible to disconnect the probe if you want to perform the following:

- Work with another probe
- Work with another platform

Note: *Once a connection has been established with a wireless probe, the latter remains connected as long as you do not disconnect it. However, when the application is in standby mode, the connection is lost. The application will try to reconnect automatically when the image reappears on screen.*

Setting up Your Fiber Inspection Probe and ConnectorMax2

Connecting or Disconnecting the Wireless Probe

To connect the wireless probe:

1. Turn on the probe by pressing the **ON** button.
2. Ensure that the Wi-Fi is activated on your platform.
3. Start the ConnectorMax2 application.
4. Select the wireless probe you want to work with and tap **Connect**.



Note: The probes are identified by their serial numbers and types.

Setting up Your Fiber Inspection Probe and ConnectorMax2

Connecting or Disconnecting the Wireless Probe

To disconnect the wireless probe:

1. Select the **Connection** tab.

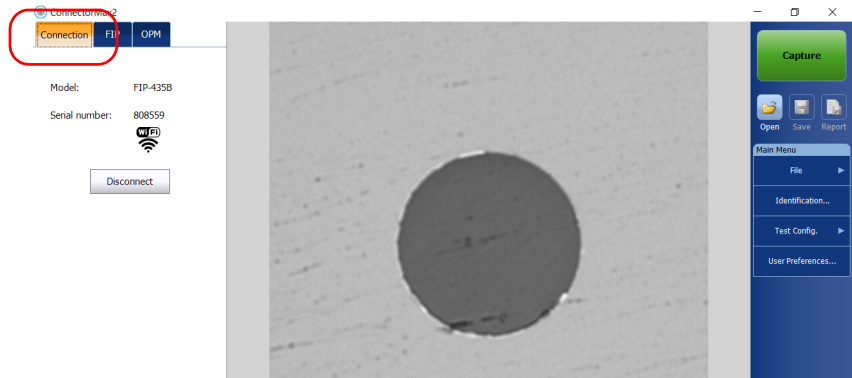

2. Tap **Disconnect**.

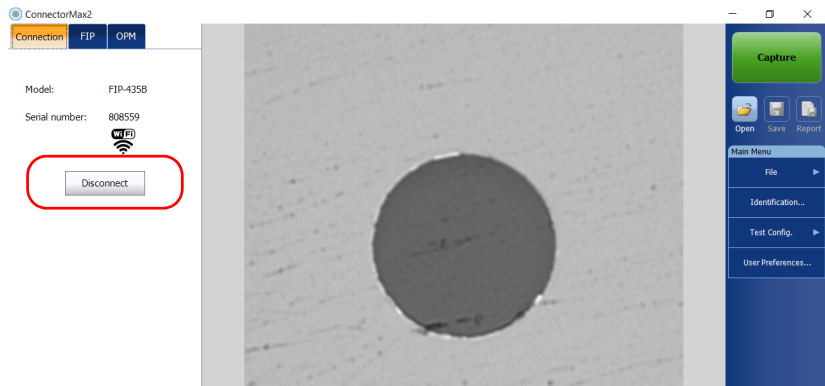

Setting up Your Fiber Inspection Probe and ConnectorMax2

Setting the Automatic Connection

Setting the Automatic Connection

This feature allows you to choose how the application automatically connects to a probe:

- It connects to the first USB probe it detects (default value).
- It connects to the last probe used.
- It never connects automatically.



IMPORTANT

If you set the automatic connection to the last probe used, remember that this last probe could be wireless. This can impact other applications that use Wi-Fi, as ConnectorMax2 will take control over any connection already in use.

Setting up Your Fiber Inspection Probe and ConnectorMax2

Setting the Automatic Connection

To set the automatic connection:

1. From the **Main Menu**, tap **User Preferences**.
2. Select the **General** tab.
3. Under **Automatic connection**, select the type of automatic connection you want to use.

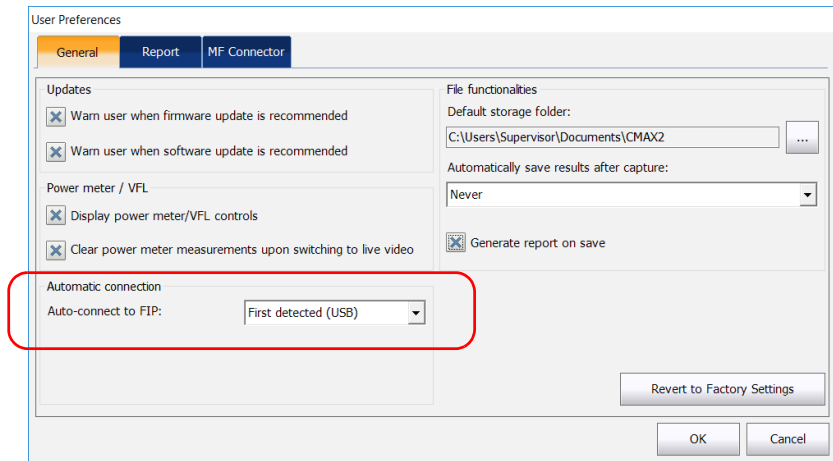

4. Tap **OK** to confirm your choice and close the window.

Setting up Your Fiber Inspection Probe and ConnectorMax2

Changing the Fiber Inspection Probe Tip

Changing the Fiber Inspection Probe Tip

You can use various tips depending on the type of connector you are inspecting. For more information about tips you can use, see the *Fiber Inspection Probe Tip Compatibility Chart* on page 159, or [contact your vendor for additional information](#).

To inspect single fibers or transceivers with MF-Ready probes, you need to remove the inspection tip first. You also need to select the tip corresponding to the type of connector you want to inspect. See *Changing the FIP Nozzle (MF-Ready Probes Only)* on page 29 for details.



To change a tip:

1. Untighten the tip's retaining nut.
2. Remove the tip.
3. Insert a new tip on the probe by aligning the key of the probe with the notch of the tip.
4. Retighten the retaining nut.

Changing the FIP Nozzle (MF-Ready Probes Only)

The MF-Ready probe, which is composed of a removable nozzle and an inspection tip, allows you to inspect various multifiber connector models. The nozzle is interchangeable but it must always be installed on the inspection tip first. Depending on the patch panel you are inspecting, the nozzle can be inserted in two different ways (key up or key down).

If you decide to inspect single fibers and transceivers, you can also remove the inspection tip and work with the MF-Ready probe as you would with the standard probe. See *Changing the Fiber Inspection Probe Tip* on page 28 for details.

For more information about tips you can use, see the *Fiber Inspection Probe Tip Compatibility Chart* on page 159, or [contact your vendor for additional information](#).

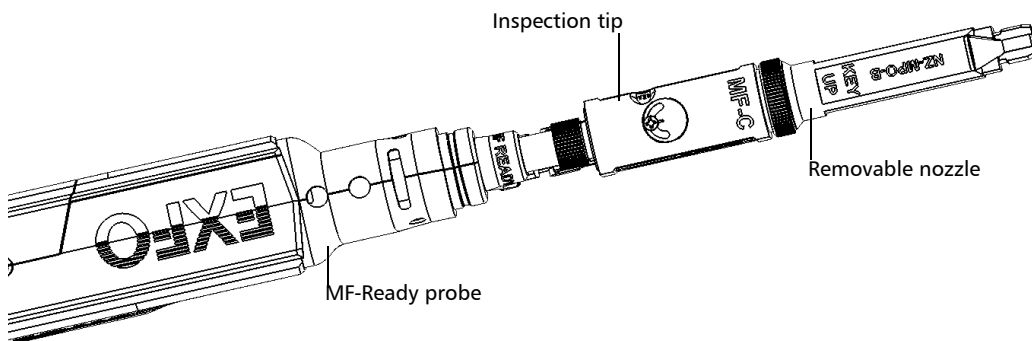

IMPORTANT

To facilitate the installation process of all components, EXFO recommends to install the removable nozzle on the inspection tip first.

Setting up Your Fiber Inspection Probe and ConnectorMax2

Changing the FIP Nozzle (MF-Ready Probes Only)

To install the removable nozzle and the inspection tip on the MF-Ready probe:

1. Depending on the patch panel you are inspecting, insert the removable nozzle on the metal rod of the inspection tip key up or key down (as written on the nozzle).
2. Align the key of the nozzle with the notch of the inspection tip until you feel it click in place. When this step is performed adequately, you cannot move the nozzle freely.

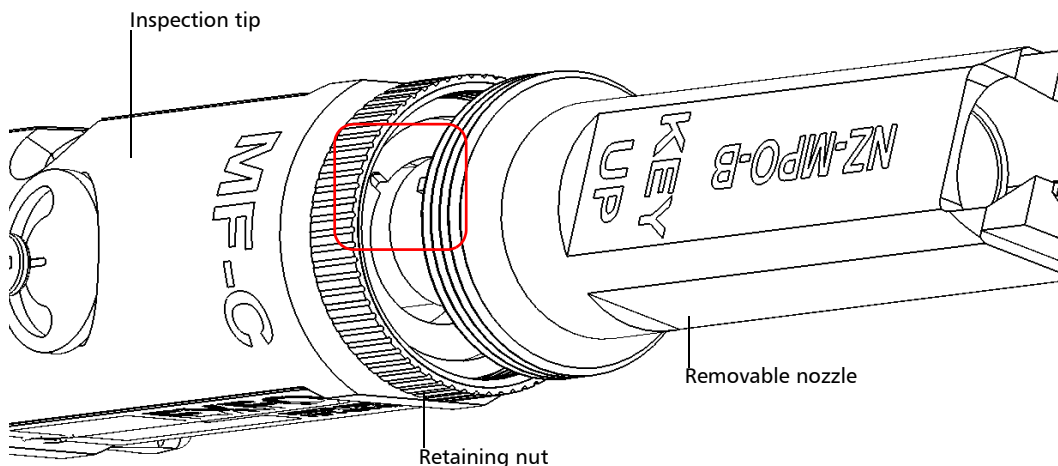

IMPORTANT

The key of the nozzle, whether it is installed key up or key down, **MUST BE** aligned with the notch of the inspection tip. Otherwise, it will be impossible to perform an acquisition.

Setting up Your Fiber Inspection Probe and ConnectorMax2

Changing the FIP Nozzle (MF-Ready Probes Only)

3. Tighten the retaining nut clockwise.

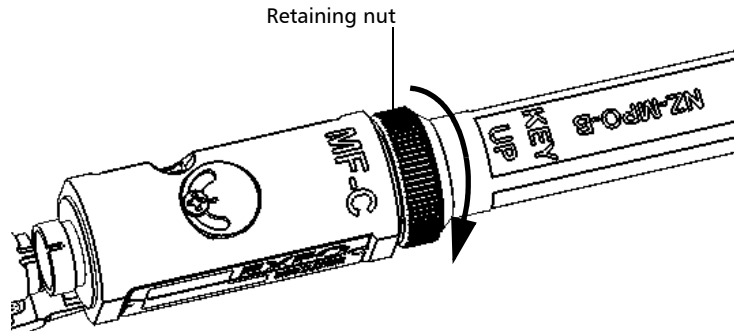

4. Insert the inspection tip on the MF-Ready probe by aligning the key of the probe with the notch of the inspection tip.

Note: *If you cannot see the notch of the inspection tip, slide the movable part of the inspection tip with the trigger towards the nozzle.*

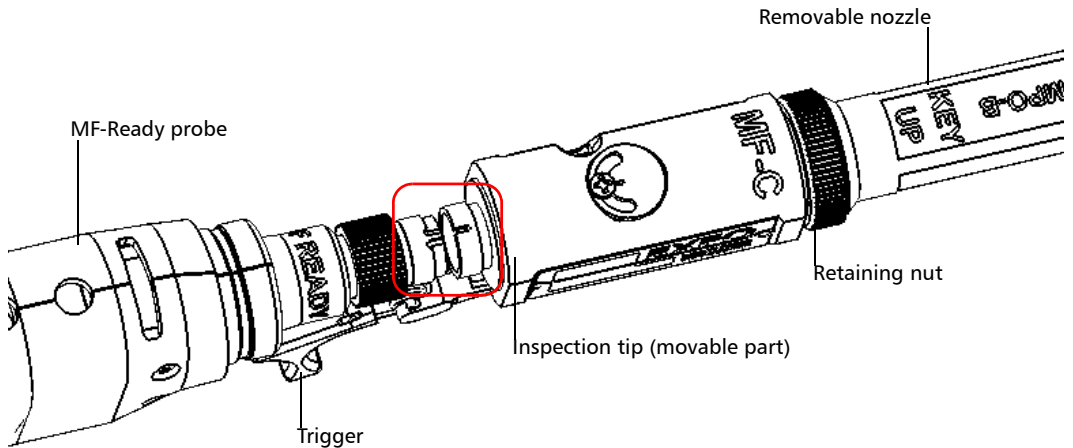

Setting up Your Fiber Inspection Probe and ConnectorMax2

Changing the FIP Nozzle (MF-Ready Probes Only)

5. Tighten the retaining nut clockwise.

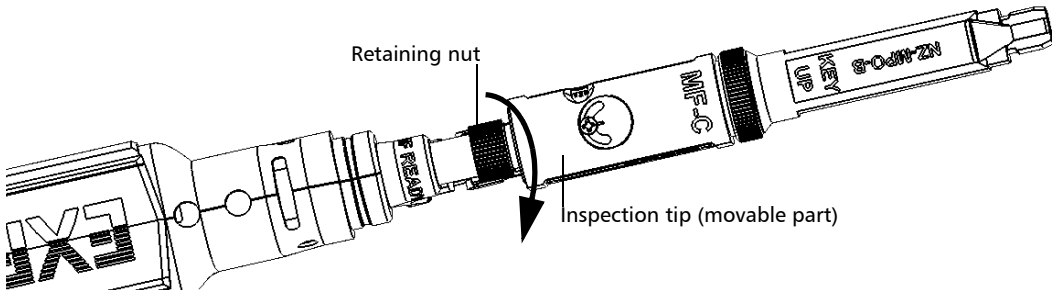

You are now ready to perform a multifiber capture.

To change the removable nozzle:

1. Untighten the retaining nut counterclockwise.

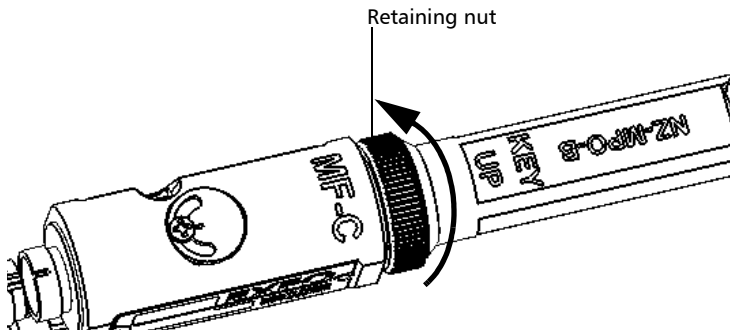

2. Remove the nozzle from the inspection tip.
3. Depending on the patch panel you are inspecting, insert a removable nozzle on the metal rod of the inspection tip key up or key down (as written on the nozzle).

Setting up Your Fiber Inspection Probe and ConnectorMax2

Changing the FIP Nozzle (MF-Ready Probes Only)

4. Align the key of the nozzle with the notch of the inspection tip until you feel it click in place. When this step is performed adequately, you cannot move the nozzle freely.

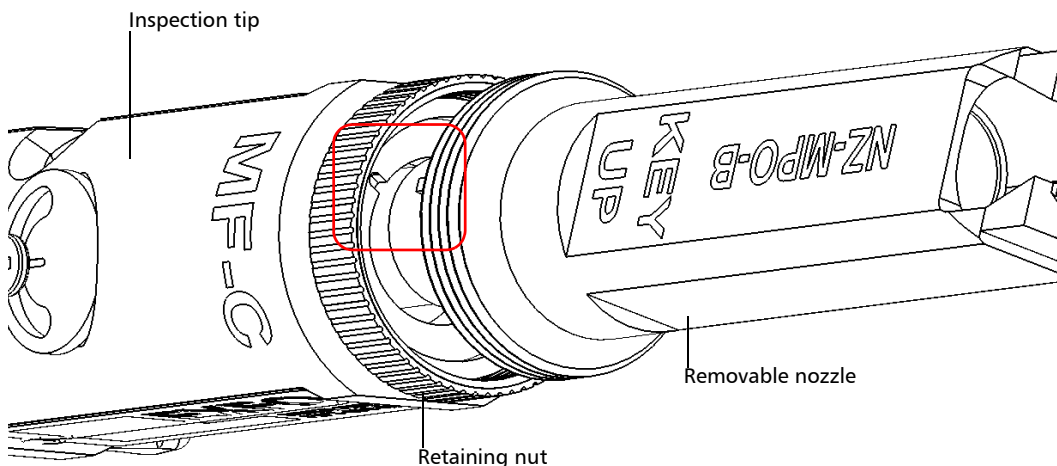

IMPORTANT

The key of the nozzle, whether it is installed key up or key down, **MUST BE** aligned with the notch of the inspection tip. Otherwise, it will be impossible to perform an acquisition.

5. Retighten the retaining nut clockwise.

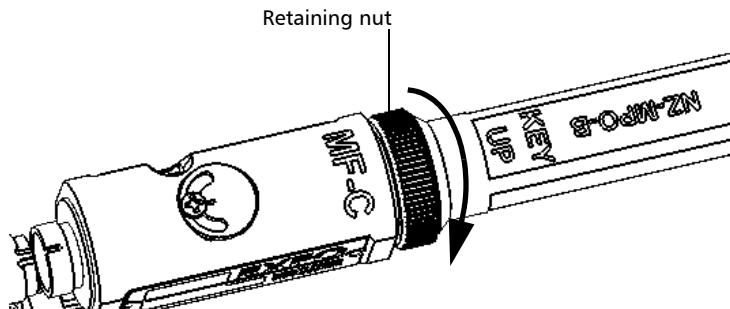

Setting up Your Fiber Inspection Probe and ConnectorMax2

Changing the FIP Nozzle (MF-Ready Probes Only)

To remove the inspection tip:

1. To expose the retaining nut, slide the movable part of the inspection tip, using the trigger, until it stops.

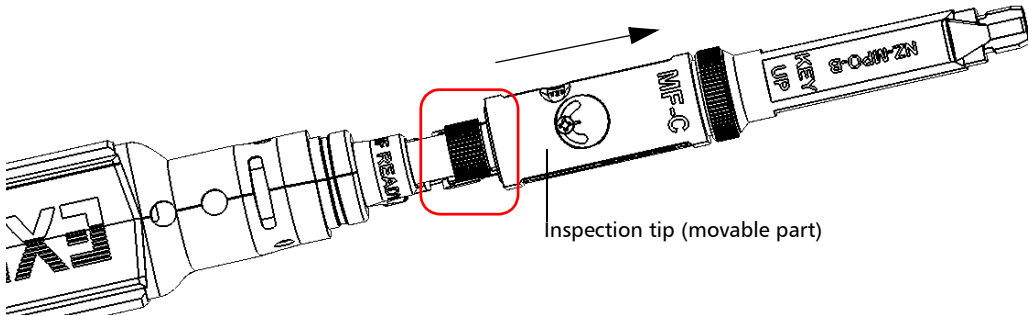

2. Untighten the retaining nut counterclockwise.
3. Remove the inspection tip from the MF-Ready probe.

You can insert a tip which is not dedicated to multifiber inspection on your MF-Ready probe. See *Changing the Fiber Inspection Probe Tip* on page 28 for details.

Selecting the Multifiber Tip Type (MF-Ready Probes Only)

When performing a multifiber inspection with an MF-Ready probe, you have to specify which tip type you are using. You can choose between two types of tips:

- the manual-scanning tip allows you to analyze the fibers separately or as a batch.
- the 3-step inspection tip requires three captures. As soon as the third capture is performed, the analysis process starts automatically.

If you do not select the appropriate multifiber tip type before performing the inspection, it will be impossible to perform an acquisition.

To select the multifiber tip type:

1. From the **Main Menu**, tap **User Preferences**.
2. Select the **MF Connector** tab.
3. Select the multifiber tip type you want to use.

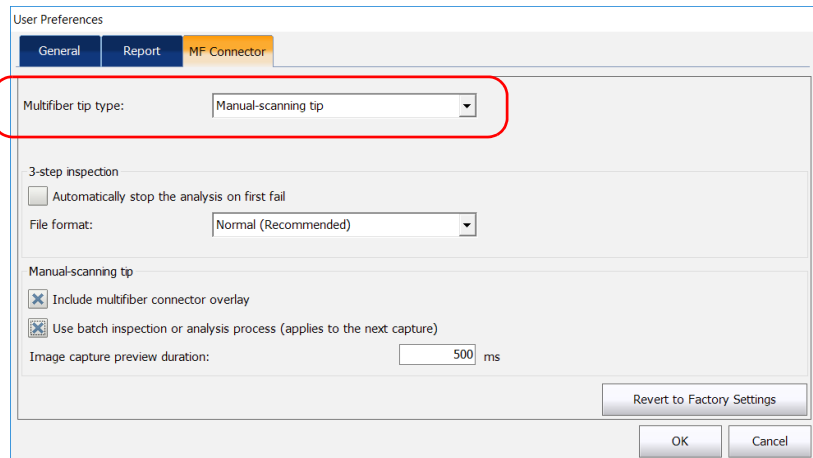

4. Tap **OK** to return to the main window.

Adjusting Brightness

Note: *This feature is not available for FIP-415B, FIP-425B and FIP-435B MF-Ready probes testing multifiber connectors with the 3-step inspection tip.*

Note: *To optimize the analysis of the connector, EXFO recommends to set the brightness to **Automatic** most of the time.*

Once the probe is connected to a fiber, you can adjust brightness in order to better view the fiber under inspection.

Note: *The brightness level is persisted according to the serial number of the probe.*

The default brightness value is 50 %. This corresponds to the automatic brightness mode. The brightness automatically returns to 50 %:

- when you exit the application and the probe is still connected
- when the application is opened and you plug and unplug the probe
- when the platform is in suspend or resume mode
- when you lock or unlock a session (except on a MAX-700B)
- when you log in or log out of a session (except on a MAX-700B)

Setting up Your Fiber Inspection Probe and ConnectorMax2

Adjusting Brightness

To adjust brightness:

1. In the **FIP** tab, tap the arrow.

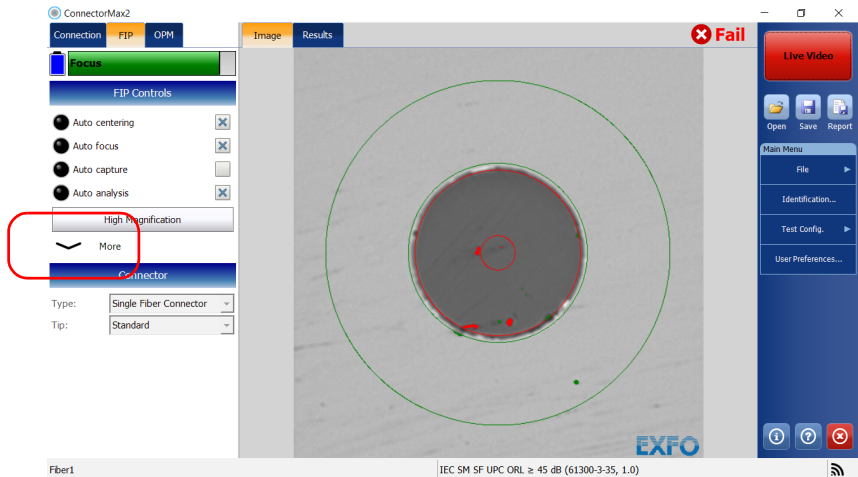

2. Use the brightness slider to set the levels to suit your needs.

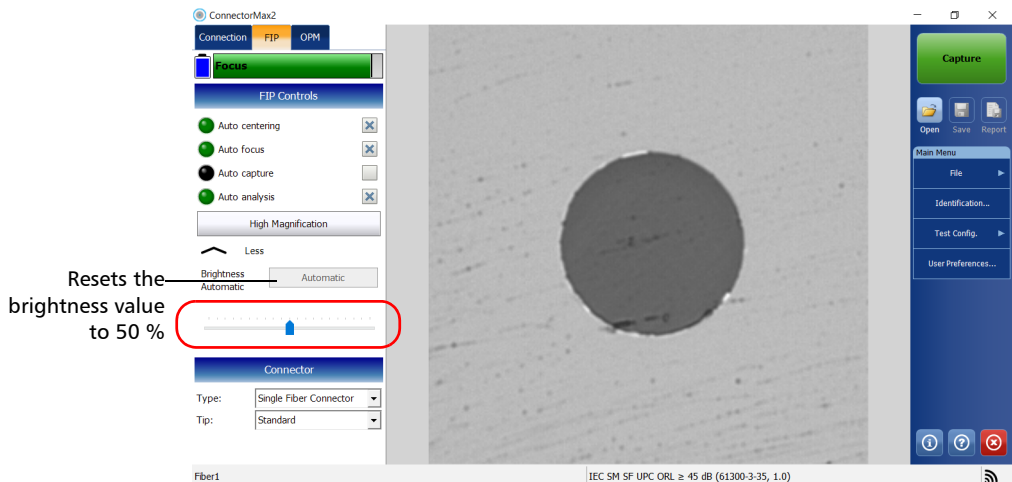

Setting up Autonaming

The autonaming feature is useful to make a relevant naming scheme for your tests. This also ensures that you do not overwrite files by mistake. You can select which item goes in the file name (appears at the bottom of the window), as well as the type of separator you want to use in between.

A preview is available to show you the final output of the file name.

The file name is made of one or more static parts (alphanumeric) and one or more variable parts (numeric) that will be incremented or decremented, according to your selection, as follows:

If you choose incrementation...	If you choose decrementation...
Variable part increases until it reaches the <i>highest possible value</i> with the selected number of digits, then restarts at 1.	Variable part decreases until it reaches 1, then restarts at the <i>highest possible value</i> with the selected number of digits.

Note: *To decrement values, the start number must be higher than the stop number.*

The file name can be incremented using one or more identifiers. Selecting a single identifier will follow the incrementation (or decrementation) value you have set.

For single fibers (SF or transceivers), when selecting more than one identifier, the latter appear sequentially in the order that you have set, and the incrementation will start with the last item in the list (the one with the farthest indentation). For example, if you have a file name with the Location, Cable and Fiber identifiers, in that order, the first item to be incremented is the Fiber identifier, then Cable, then Location:

Location 1, Cable 1, Fiber 1

Location 1, Cable 1, Fiber 2

Location 1, Cable 2, Fiber 1

Location 1, Cable 2, Fiber 2

and so forth.

For multifibers, when several identifiers for the file name are selected, they appear sequentially in the order you have set. However, only one increment can be used to create a multifiber set of captures. If several increments are selected, only the most indented identifier will be used as the increment. If no auto increment is defined, the identifier Frame is used (whether or not it is selected for the file name).

After a result is saved, you have to return to the live video mode so that the application prepares the next file name by incrementing (or decrementing) the suffix.

Note: *If you choose not to save a particular file, the suggested file name remains available for the next capture. This applies to all type of connectors.*

If you deactivate the automatic file naming function, the application displays a **Save As** window and no default file name is suggested.

It is also possible to revert the settings to their default values.

Setting up Your Fiber Inspection Probe and ConnectorMax2

Setting up Autonaming

To configure the automatic file naming:

1. From the Main Menu, tap Identification.

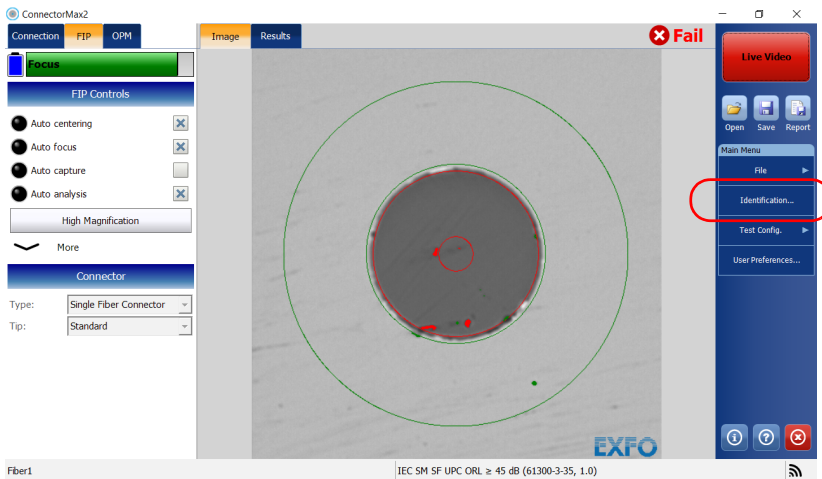

2. From the Apply to list, ensure that Next capture is selected.

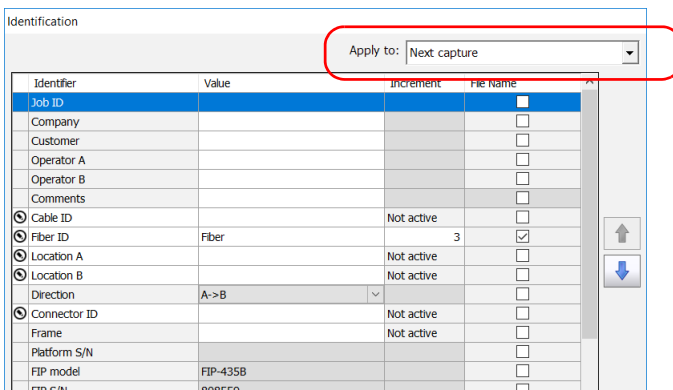

Setting up Your Fiber Inspection Probe and ConnectorMax2

Setting up Autonoming

3. Select the desired identifiers to include in the file name. You can change the order of appearance of the highlighted component with the up and down arrow buttons.

If an identifier has an arrow icon, a predefined list with choices is available, but you can also enter your own customized identifier name. If you select **None**, it disables the field from the list.

Note: You cannot edit the information in the dark gray boxes.

Apply to: Next capture

Identifier	Value	Increment	File Name
Job ID			<input type="checkbox"/>
Company			<input type="checkbox"/>
Customer			<input type="checkbox"/>
Operator A			<input type="checkbox"/>
Operator B			<input type="checkbox"/>
Comments			<input type="checkbox"/>
<input checked="" type="radio"/> Cable ID		Not active	<input type="checkbox"/>
<input checked="" type="radio"/> Fiber ID	Fiber	3	<input checked="" type="checkbox"/>
<input checked="" type="radio"/> Location A		Not active	<input type="checkbox"/>
<input checked="" type="radio"/> Location B		Not active	<input type="checkbox"/>
Direction	A->B		<input type="checkbox"/>
<input checked="" type="radio"/> Connector ID		Not active	<input type="checkbox"/>
Frame		Not active	<input type="checkbox"/>
Platform S/N			<input type="checkbox"/>
FIP model	FIP-435B		<input type="checkbox"/>
FIP S/N	808559		<input type="checkbox"/>
Inspection date			<input type="checkbox"/>
Analysis date			<input type="checkbox"/>

File name preview: Fiber3.cmax2

Separator: Underscore (_)

Increment... Clear Values

Revert to Factory Settings

OK Cancel

Items that can be included in the file name

To modify the order of appearance of the selected identifiers in the file name

To select the separator in the automatic numbering section

This preview is updated automatically as you make your selections

To revert to factory settings (not available for the Current acquisition)

Setting up Your Fiber Inspection Probe and ConnectorMax2

Setting up Autonaming

4. If you want to increment automatically the cable ID, the fiber ID, the location (A and/or B), the connector ID, or the frame, proceed as follows:

- 4a. Tap the **Increment** button.

Identification

Apply to: Next capture

Identifier	Value	Increment	File Name
Job ID			<input type="checkbox"/>
Company			<input type="checkbox"/>
Customer			<input type="checkbox"/>
Operator A			<input type="checkbox"/>
Operator B			<input type="checkbox"/>
Comments			<input type="checkbox"/>
<input checked="" type="radio"/> Cable ID		Not active	<input type="checkbox"/>
<input checked="" type="radio"/> Fiber ID	Fiber	3	<input checked="" type="checkbox"/>
<input checked="" type="radio"/> Location A		Not active	<input type="checkbox"/>
<input checked="" type="radio"/> Location B		Not active	<input type="checkbox"/>
Direction	A->B		<input type="checkbox"/>
<input checked="" type="radio"/> Connector ID		Not active	<input type="checkbox"/>
Frame		Not active	<input type="checkbox"/>
Platform S/N			<input type="checkbox"/>
FIP model	FIP-435B		<input type="checkbox"/>
FIP S/N	808559		<input type="checkbox"/>
Inspection date			<input type="checkbox"/>
Analysis date			<input type="checkbox"/>

File name preview: Fiber3.cmax2

Separator: Underscore (_) Increment...

- 4b. In the **Increment** window, select the **Auto Increment** check box corresponding to the identifier you want to increment.

4c. Enter the start, stop and increment values as desired.

Increment

Identifier	Auto Increment	Start	Stop	Step
Cable ID	<input checked="" type="checkbox"/>	1	50	10
Fiber ID	<input checked="" type="checkbox"/>	1	75	5
Location A	<input type="checkbox"/>	1	99	1
Location B	<input type="checkbox"/>	1	99	1
Connector ID	<input checked="" type="checkbox"/>	1	99	1
Frame	<input type="checkbox"/>	1	99	1

'Connector ID' must reach stop value before 'Fiber ID' is incremented. 'Fiber ID' must reach stop value before 'Cable ID' is incremented.

OK Cancel

Note: The identifiers are processed in order, from the one with the largest indentation to the one with the smallest. For a given identifier, when the increment value reaches the stop value, the incrementation automatically switches to the next identifier. The order of the identifiers in the increment window (and thereby the order of increment) follows the order of the identification window.

Note: An identifier set to **None** will not appear in the increment window.

Note: To decrement values, the start number must be higher than the stop number.

4d. Tap **OK** to confirm your new settings and to return to the **Identification** window.

The new settings will apply the next time you perform a capture.

Setting up Your Fiber Inspection Probe and ConnectorMax2

Setting up Autonaming

To clear the values:

1. From the **Main Menu**, tap **Identification**.
2. In the **Apply to** list, select **Next capture**.
3. Tap the **Clear Values** button.

Identification

Apply to: Next capture

Identifier	Value	Increment	File Name
Job ID			<input type="checkbox"/>
Company			<input type="checkbox"/>
Customer			<input type="checkbox"/>
Operator A			<input type="checkbox"/>
Operator B			<input type="checkbox"/>
Comments			<input type="checkbox"/>
<input checked="" type="radio"/> Cable ID		Not active	<input type="checkbox"/>
<input checked="" type="radio"/> Fiber ID	Fiber	3	<input checked="" type="checkbox"/>
<input checked="" type="radio"/> Location A		Not active	<input type="checkbox"/>
<input checked="" type="radio"/> Location B		Not active	<input type="checkbox"/>
Direction	A->B		<input type="checkbox"/>
<input checked="" type="radio"/> Connector ID		Not active	<input type="checkbox"/>
Frame		Not active	<input type="checkbox"/>
Platform S/N			<input type="checkbox"/>
FIP model	FIP-435B		<input type="checkbox"/>
FIP S/N	808559		<input type="checkbox"/>
Inspection date			<input type="checkbox"/>
Analysis date			<input type="checkbox"/>

File name preview: Fiber3.cmax2

Separator: Underscore (_)

Increment... Clear Values

Revert to Factory Settings

OK Cancel

4. Tap **OK** to return to the main window.

All values in the **Value** column are erased from the white boxes.

Managing and Selecting Test Configurations

You can create and select specific test configurations according to the type of fiber you are analyzing, the connector type you are using or the type of anomaly you are looking for.

Note: *If you have the FIP-420B or FIP-430B probe, some test configurations as per IEC 61300-3-35 and IPC 8497-1 standards, and other configurations with an enlarged adhesive C zone are available by default.*

Creating custom test configurations is done through duplicating an existing configuration, and then modifying the desired criteria.

If you create configurations on one unit or computer, and want to transfer them to another unit or computer, you can do so.

To select a test configuration:

1. From the Main Menu, tap **Test Config.**

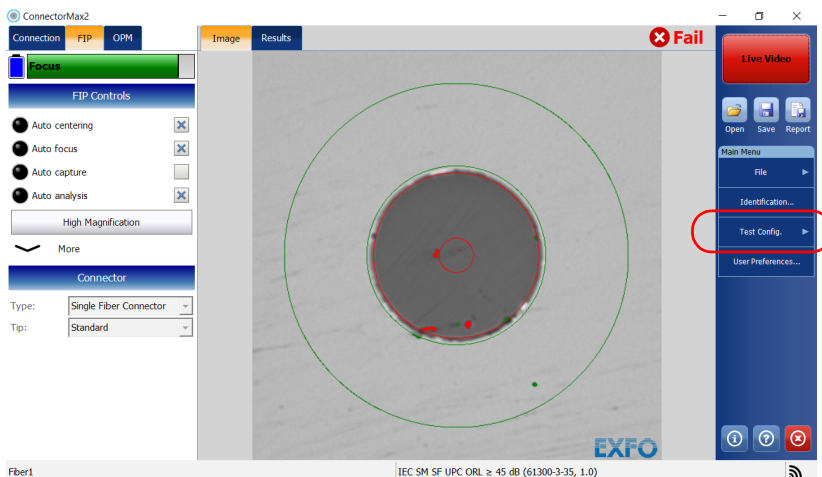

Setting up Your Fiber Inspection Probe and ConnectorMax2

Managing and Selecting Test Configurations

2. Tap FIP.

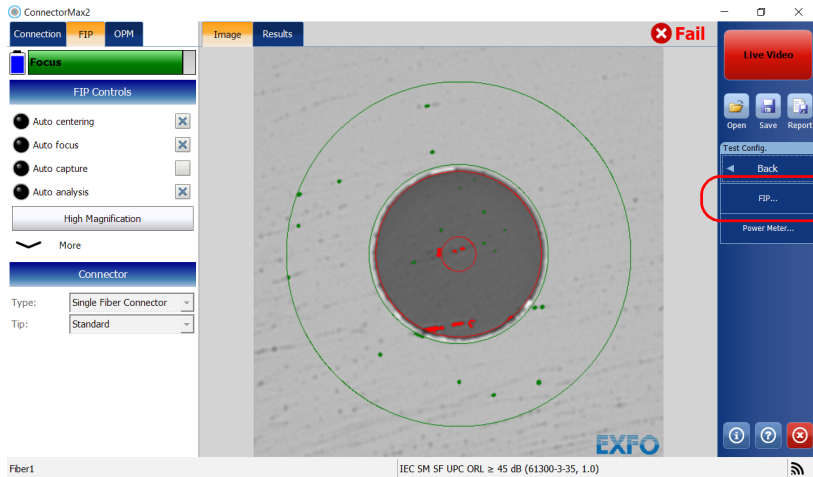

3. Choose the type of connector you want to use (single fiber, transceiver or multiple fiber), as well as the type of connector tip.

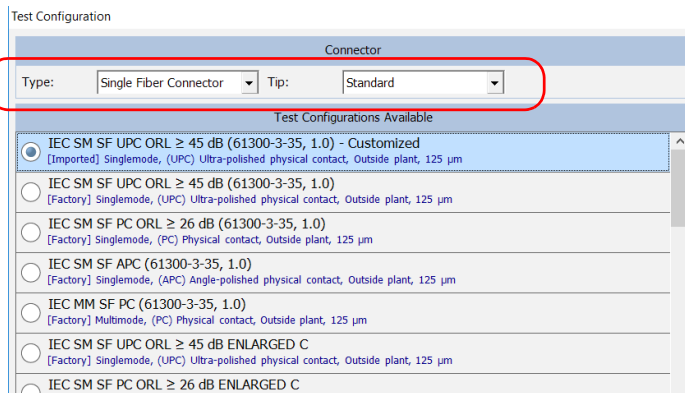

Note: The test configuration list is updated according to the connector type you have selected.

4. Select the test configuration you want to use and tap Close.

Setting up Your Fiber Inspection Probe and ConnectorMax2

Managing and Selecting Test Configurations

To create a test configuration:

1. From the Main Menu, tap **Test Config**.

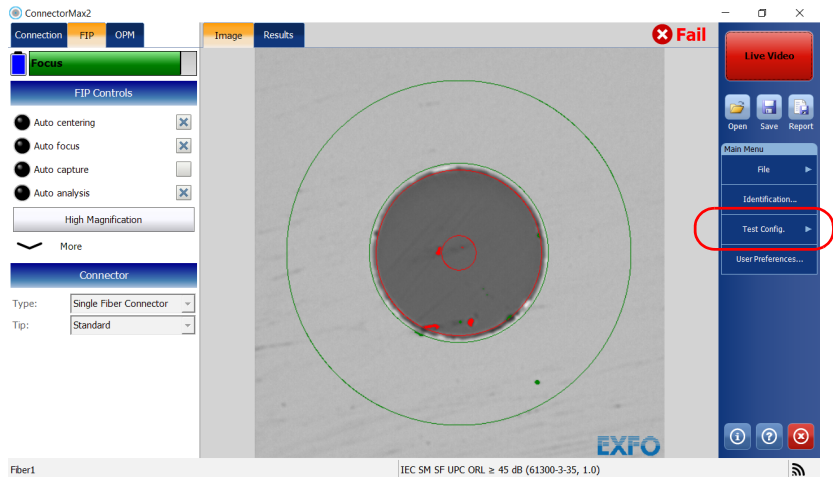

2. Tap **FIP**.

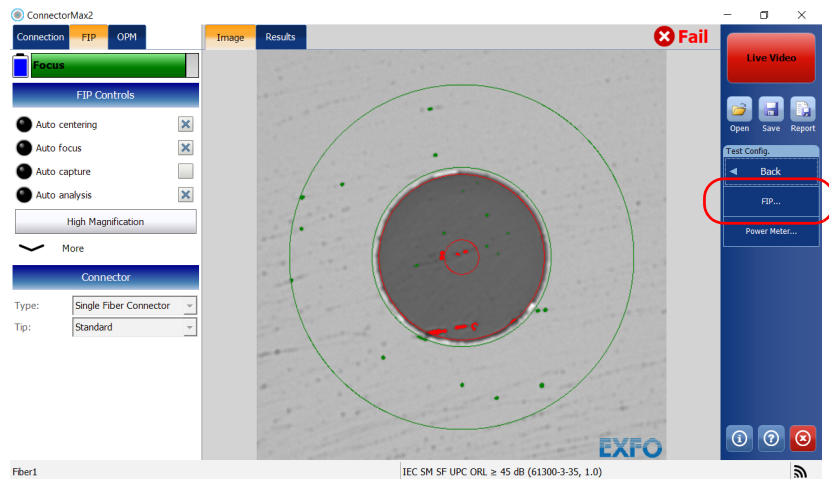

Setting up Your Fiber Inspection Probe and ConnectorMax2

Managing and Selecting Test Configurations

- Choose the type of connector you want to use (single fiber, transceiver or multiple fiber), as well as the type of connector tip.

The screenshot shows the 'Test Configuration' dialog box. At the top, there is a 'Connector' section with two dropdown menus: 'Type' set to 'Single Fiber Connector' and 'Tip' set to 'Standard'. Below this is a list of 'Test Configurations Available'. The first option is selected with a radio button and is highlighted in blue. The list includes:

- IEC SM SF UPC ORL \geq 45 dB (61300-3-35, 1.0) - Customized
[Imported] Singlemode, (UPC) Ultra-polished physical contact, Outside plant, 125 μ m
- IEC SM SF UPC ORL \geq 45 dB (61300-3-35, 1.0)
[Factory] Singlemode, (UPC) Ultra-polished physical contact, Outside plant, 125 μ m
- IEC SM SF PC ORL \geq 26 dB (61300-3-35, 1.0)
[Factory] Singlemode, (PC) Physical contact, Outside plant, 125 μ m
- IEC SM SF APC (61300-3-35, 1.0)
[Factory] Singlemode, (APC) Angle-polished physical contact, Outside plant, 125 μ m
- IEC MM SF PC (61300-3-35, 1.0)
[Factory] Multimode, (PC) Physical contact, Outside plant, 125 μ m
- IEC SM SF UPC ORL \geq 45 dB ENLARGED C

Note: The test configuration list is updated according to the connector type you have selected.

- Select the test configuration that is the closest to the one you want to create, then tap **Duplicate**.

This screenshot is identical to the previous one, showing the 'Test Configuration' dialog box with the same 'Connector' settings and 'Test Configurations Available' list. The 'Duplicate' button at the bottom of the dialog is circled in red.

5. If you want to customize the test configuration you have just created, proceed as follows:
 - 5a. In the **Test Configuration** window, locate the new test configuration and tap **Details**.
 - 5b. In the **General Information** tab, modify the parameters as needed.
 - *Configuration name*: the application suggests a name for the configuration. You can change it as needed (maximum 256 characters), but if you select a name that already exists, a suffix will automatically be added so as not to overwrite files.
 - *Connector type*: Select which type of connector you are using for your inspection.

Note: *When you duplicate and edit a test configuration, you cannot change the connector type field.*

- *Fiber type*: Select whether you are inspecting singlemode or multimode fibers.
- *Polishing type*: Select the type of polishing for the fibers between APC, PC or UPC.
- *Analysis mode*: Select the type of analysis between **Outside plant** (selected by default) and **Manufacturing**. The manufacturing mode is more sensitive for scratches and defects detection.

Setting up Your Fiber Inspection Probe and ConnectorMax2

Managing and Selecting Test Configurations

- *Cladding diameter:* This value is set at 125 μm by default.
- *Antireflective coating:* When working with some MPO connectors, you can activate this parameter to prevent the reflection of the light on the surface of the connector.
- *Zone diameters:* You can change the zone dimension for single fiber connectors, transceiver fiber receptacles, and multifiber connectors.

Note: *Zone C (adhesive) cannot be removed and the superior diameter of zone D cannot exceed 280 μm .*

Test Configuration Details

General Information | Zone A | Zone B | Zone C | Zone D

Configuration name: IEC SM SF UPC ORL \geq 45 dB (61300-3-35, 1.0)

Connector type: Single Fiber Connector

Fiber type: Singlemode

Polishing type: (UPC) Ultra-polished physical contact

Analysis mode: Outside plant

Cladding diameter: 125 μm

Antireflective coating: Enabled

Zone diameters

0	Zone A μm	25	Zone B μm	120	Zone C μm	130	Zone D μm	250	μm
---	-------------------------	----	-------------------------	-----	-------------------------	-----	-------------------------	-----	---------------

OK Cancel

Note: *When a multifiber connector is selected, zone D is not available.*

Setting up Your Fiber Inspection Probe and ConnectorMax2

Managing and Selecting Test Configurations

6. If you want to modify the information about the inspection zones, in the **Test Configuration Details** window, proceed as follows:
 - 6a. Select the tab corresponding to the inspection zone you want to modify.
 - 6b. Modify the parameters as needed to indicate whether you want to be notified of scratches, defects or both for each zone in the fiber, then set thresholds for each item you select.

You can set up to 3 criteria per zone, and per anomaly type (scratches or defects). The thresholds are divided into three categories:

- Any: this enables the next criterion, which requires a specific value.
- 1 to 10: the next criterion is automatically filled out to show the infinity symbol (∞) and 0 as a threshold.
- 0: the criterion definition is complete.

Note: Zone C, as well as zone dimensions cannot be modified, as they are set as per IEC and IPC recommendations.

The screenshot shows the 'Test Configuration Details' window with the 'Zone B' tab selected. It contains two tables: 'Activate scratches' and 'Activate defects'. Each table has three rows for criteria and their corresponding thresholds.

#	Criteria (μm)	Thresholds
1	$0 \leq \text{size} < 3$	Any
2	$3 \leq \text{size} < \infty$	0
3	---	---

#	Criteria (μm)	Thresholds
1	$0 \leq \text{size} < 2$	Any
2	$2 \leq \text{size} < \infty$	5
3	---	---

7. Tap **OK** to close the **Test Configuration Details** window.
8. Tap **Close** to return to the main window.

Setting up Your Fiber Inspection Probe and ConnectorMax2

Managing and Selecting Test Configurations

To edit a test configuration:

1. From the Main Menu, tap **Test Config.**

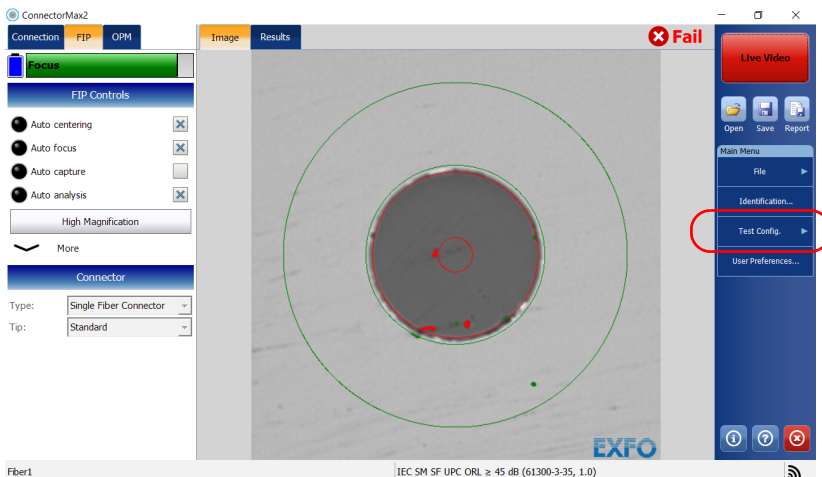

2. Tap **FIP**.

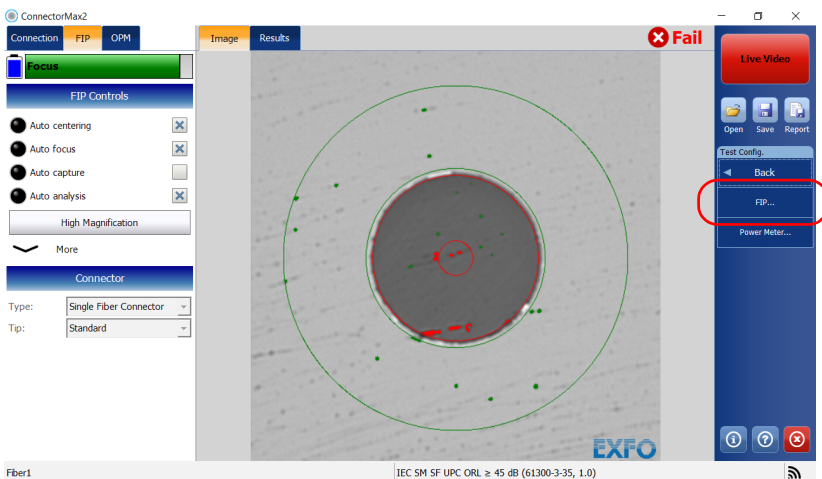

Setting up Your Fiber Inspection Probe and ConnectorMax2

Managing and Selecting Test Configurations

3. Choose the type of connector you want to use (single fiber, transceiver or multiple fiber), as well as the type of connector tip.

Test Configuration

Connector

Type: Tip:

Test Configurations Available

- IEC SM SF UPC ORL \geq 45 dB (61300-3-35, 1.0) - Customized
[Imported] Singlemode, (UPC) Ultra-polished physical contact, Outside plant, 125 μ m
- IEC SM SF UPC ORL \geq 45 dB (61300-3-35, 1.0)
[Factory] Singlemode, (UPC) Ultra-polished physical contact, Outside plant, 125 μ m
- IEC SM SF PC ORL \geq 26 dB (61300-3-35, 1.0)
[Factory] Singlemode, (PC) Physical contact, Outside plant, 125 μ m
- IEC SM SF APC (61300-3-35, 1.0)
[Factory] Singlemode, (APC) Angle-polished physical contact, Outside plant, 125 μ m
- IEC MM SF PC (61300-3-35, 1.0)
[Factory] Multimode, (PC) Physical contact, Outside plant, 125 μ m
- IEC SM SF UPC ORL \geq 45 dB ENLARGED C
[Factory] Singlemode, (UPC) Ultra-polished physical contact, Outside plant, 125 μ m
- IEC SM SF PC ORL \geq 26 dB ENLARGED C
[Factory] Singlemode, (PC) Physical contact, Outside plant, 125 μ m

Import... Export... Duplicate Delete Details... Close

Note: The test configuration list is updated according to the connector type you have selected.

4. Select the test configuration you want to edit and tap **Details**.

Note: You cannot edit standard test configurations.

5. Change the criteria as required. For details, see the section on creating a test configuration.

Setting up Your Fiber Inspection Probe and ConnectorMax2

Managing and Selecting Test Configurations

To delete a test configuration:

1. From the Main Menu, tap **Test Config.**

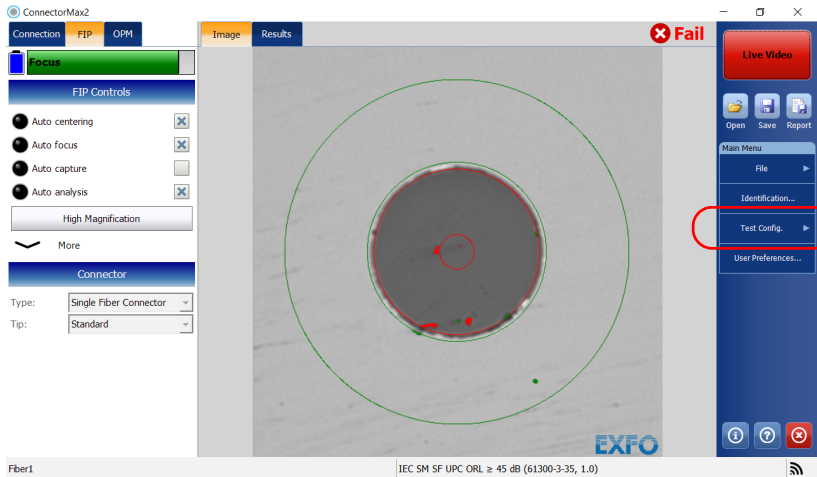

2. Tap **FIP.**

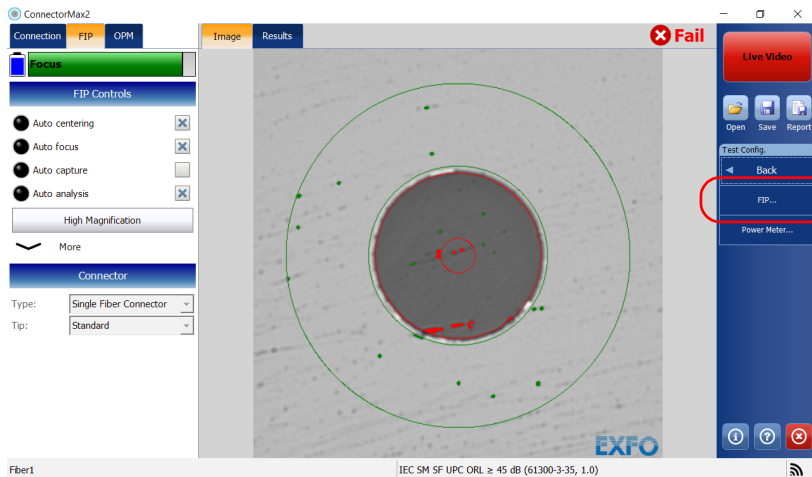

Setting up Your Fiber Inspection Probe and ConnectorMax2

Managing and Selecting Test Configurations

3. Choose the type of connector you want to use (single fiber, transceiver or multiple fiber), as well as the type of connector tip.

Test Configuration

Connector

Type: Tip:

Test Configurations Available

- IEC SM SF UPC ORL \geq 45 dB (61300-3-35, 1.0) - Customized
[Imported] Singlemode, (UPC) Ultra-polished physical contact, Outside plant, 125 μ m
- IEC SM SF UPC ORL \geq 45 dB (61300-3-35, 1.0)
[Factory] Singlemode, (UPC) Ultra-polished physical contact, Outside plant, 125 μ m
- IEC SM SF PC ORL \geq 26 dB (61300-3-35, 1.0)
[Factory] Singlemode, (PC) Physical contact, Outside plant, 125 μ m
- IEC SM SF APC (61300-3-35, 1.0)
[Factory] Singlemode, (APC) Angle-polished physical contact, Outside plant, 125 μ m
- IEC MM SF PC (61300-3-35, 1.0)
[Factory] Multimode, (PC) Physical contact, Outside plant, 125 μ m
- IEC SM SF UPC ORL \geq 45 dB ENLARGED C
[Factory] Singlemode, (UPC) Ultra-polished physical contact, Outside plant, 125 μ m
- IEC SM SF PC ORL \geq 26 dB ENLARGED C
[Factory] Singlemode, (PC) Physical contact, Outside plant, 125 μ m

Import... Export... Duplicate Delete Details... Close

Note: *The test configuration list is updated according to the connector type you have selected.*

Setting up Your Fiber Inspection Probe and ConnectorMax2

Managing and Selecting Test Configurations

4. Select the test configuration you want to remove, then tap **Delete**.

Test Configuration

Connector

Type: Tip:

Test Configurations Available

- IEC SM SF UPC ORL \geq 45 dB (61300-3-35, 1.0) - Customized
[Imported] Singlemode, (UPC) Ultra-polished physical contact, Outside plant, 125 μ m
- IEC SM SF UPC ORL \geq 45 dB (61300-3-35, 1.0)
[Factory] Singlemode, (UPC) Ultra-polished physical contact, Outside plant, 125 μ m
- IEC SM SF PC ORL \geq 26 dB (61300-3-35, 1.0)
[Factory] Singlemode, (PC) Physical contact, Outside plant, 125 μ m
- IEC SM SF APC (61300-3-35, 1.0)
[Factory] Singlemode, (APC) Angle-polished physical contact, Outside plant, 125 μ m
- IEC MM SF PC (61300-3-35, 1.0)
[Factory] Multimode, (PC) Physical contact, Outside plant, 125 μ m
- IEC SM SF UPC ORL \geq 45 dB ENLARGED C
[Factory] Singlemode, (UPC) Ultra-polished physical contact, Outside plant, 125 μ m
- IEC SM SF PC ORL \geq 26 dB ENLARGED C
[Factory] Singlemode, (PC) Physical contact, Outside plant, 125 μ m

Import... Export... Duplicate Delete Details... Close

Note: You cannot delete standard test configurations.

5. When the application prompts you, tap **Yes** or **No**.
6. Tap **Close** to return to the main window.

Setting up Your Fiber Inspection Probe and ConnectorMax2

Managing and Selecting Test Configurations

To import test configurations:

1. From the Main Menu, tap **Test Config.**

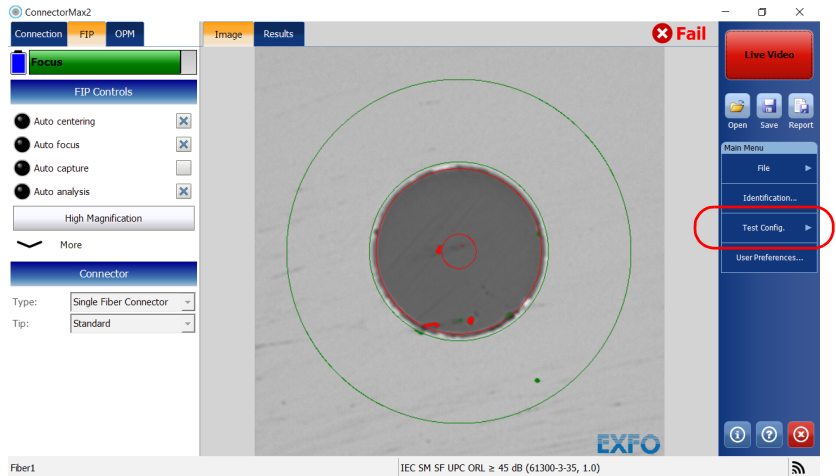

2. Tap **FIP.**

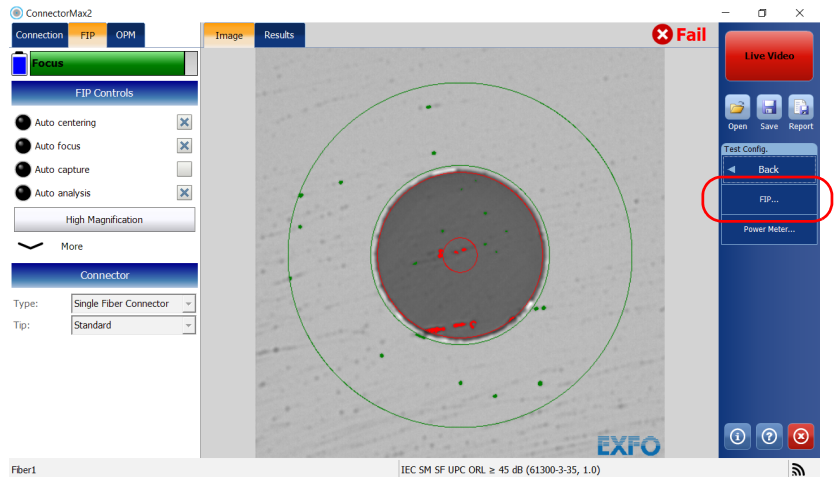

Setting up Your Fiber Inspection Probe and ConnectorMax2

Managing and Selecting Test Configurations

3. Choose the type of connector you want to use (single fiber, transceiver or multiple fiber), as well as the type of connector tip.

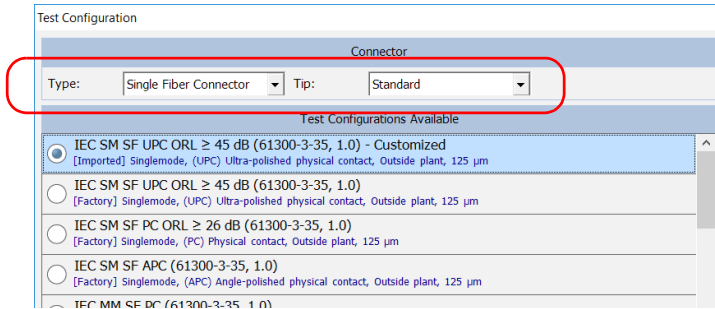

Note: The test configuration list is updated according to the connector type you have selected.

4. Tap **Import**.

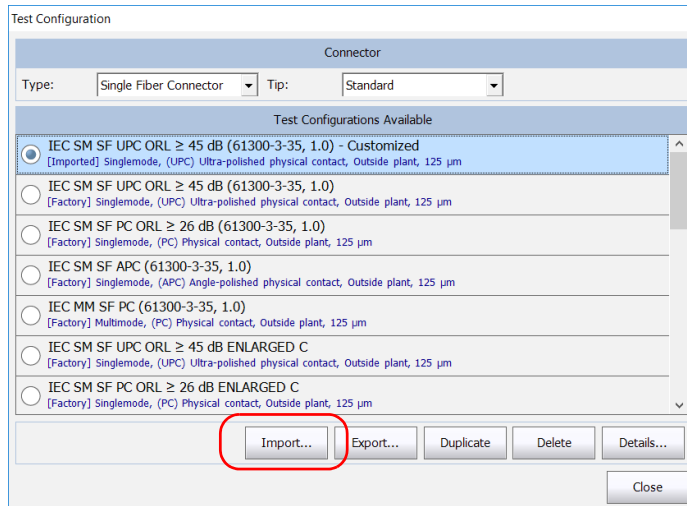

5. From the **Open** dialog box, select the file you want to import.
6. Tap **Open** to close the window.

Setting up Your Fiber Inspection Probe and ConnectorMax2

Managing and Selecting Test Configurations

To export test configurations:

1. From the Main Menu, tap **Test Config.**

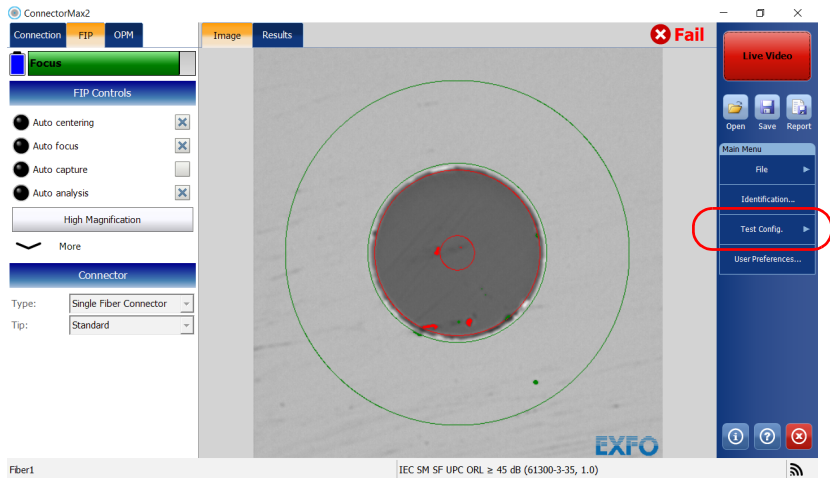

2. Tap **FIP.**

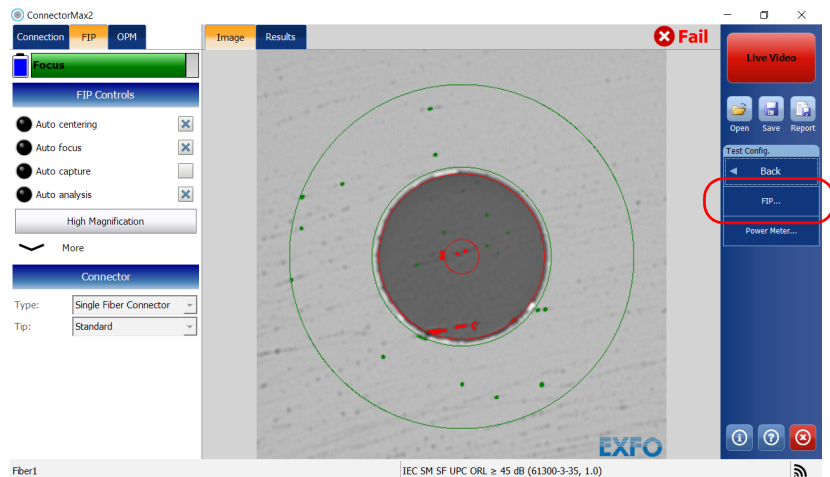

Setting up Your Fiber Inspection Probe and ConnectorMax2

Managing and Selecting Test Configurations

3. Choose the type of connector you want to use (single fiber, transceiver or multiple fiber), as well as the type of connector tip.

The screenshot shows a 'Test Configuration' dialog box. At the top, there is a 'Connector' section with two dropdown menus: 'Type' set to 'Single Fiber Connector' and 'Tip' set to 'Standard'. This section is highlighted with a red rounded rectangle. Below this is a list of 'Test Configurations Available' with radio buttons. The first option is selected: 'IEC SM SF UPC ORL \geq 45 dB (61300-3-35, 1.0) - Customized'. Other options include 'IEC SM SF UPC ORL \geq 45 dB (61300-3-35, 1.0)', 'IEC SM SF PC ORL \geq 26 dB (61300-3-35, 1.0)', 'IEC SM SF APC (61300-3-35, 1.0)', 'IEC MM SF PC (61300-3-35, 1.0)', 'IEC SM SF UPC ORL \geq 45 dB ENLARGED C', and 'IEC SM SF PC ORL \geq 26 dB ENLARGED C'. At the bottom of the dialog are buttons for 'Import...', 'Export...', 'Duplicate', 'Delete', 'Details...', and 'Close'.

Note: The test configuration list is updated according to the connector type you have selected.

4. Select the test configuration you want to export.

Note: You cannot export standard test configurations.

Setting up Your Fiber Inspection Probe and ConnectorMax2

Managing and Selecting Test Configurations

5. Tap **Export**.

Test Configuration

Connector

Type: Tip:

Test Configurations Available

- IEC SM SF UPC ORL \geq 45 dB (61300-3-35, 1.0) - Customized
[Imported] Singlemode, (UPC) Ultra-polished physical contact, Outside plant, 125 μ m
- IEC SM SF UPC ORL \geq 45 dB (61300-3-35, 1.0)
[Factory] Singlemode, (UPC) Ultra-polished physical contact, Outside plant, 125 μ m
- IEC SM SF PC ORL \geq 26 dB (61300-3-35, 1.0)
[Factory] Singlemode, (PC) Physical contact, Outside plant, 125 μ m
- IEC SM SF APC (61300-3-35, 1.0)
[Factory] Singlemode, (APC) Angle-polished physical contact, Outside plant, 125 μ m
- IEC MM SF PC (61300-3-35, 1.0)
[Factory] Multimode, (PC) Physical contact, Outside plant, 125 μ m
- IEC SM SF UPC ORL \geq 45 dB ENLARGED C
[Factory] Singlemode, (UPC) Ultra-polished physical contact, Outside plant, 125 μ m
- IEC SM SF PC ORL \geq 26 dB ENLARGED C
[Factory] Singlemode, (PC) Physical contact, Outside plant, 125 μ m

Import... **Export...** Duplicate Delete Details... Close

6. From the **Save As** dialog box, select the folder where you want to export your file.
7. If desired, modify the file name.
8. Tap **Save** to close the window.

Setting up Your Fiber Inspection Probe and ConnectorMax2

Setting the Default Storage Folder

The default storage folder is Users\Supervisor\Documents\CMAX2 but you can change the folder to better suit your needs. You can also work with a USB key. If the USB key is not connected to the device upon saving, the measurements are saved in the default storage folder.

Note: *The **Save As** button allows you to save your files to a folder different than the default storage folder. If you change the storage folder from the **Save As** dialog box, it will be used the next time you use the **Save As** feature again. The default storage folder will not be modified.*

To set the default storage folder:

1. From the **Main Menu**, tap **User Preferences**.
2. Select the **General** tab.
3. Under **File functionalities**, tap the  button next to **Default storage folder**.

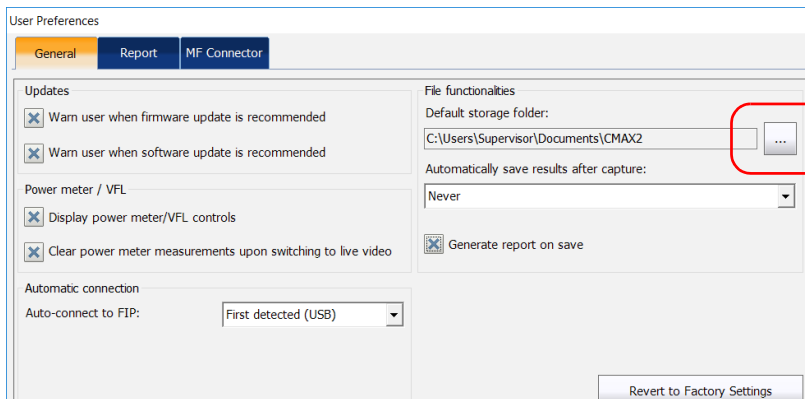

4. In the **Browse For Folder** window, select the location where you want to save the file.
5. Tap **OK** to exit the **Browse For Folder** window.
6. Tap **OK** to return to the main window.

Enabling the Multifiber Inspection as a Batch (Manual-Scanning Tip)

You can inspect and analyze multifiber connectors with the manual-scanning tip separately for each fiber or as a batch. The batch inspection feature is a way to speed up the inspection and analysis process by capturing and previewing the fibers one after the other for a configured period of time. At any time during the multifiber inspection, you can decide to process the results for the fibers you have already tested.

If you decide to disable the feature, the inspection and the analysis are done separately, meaning there is a transition between the live video mode and the capture mode after an image is captured.

To enable the batch inspection and analysis process:

1. From the **Main Menu**, tap **User Preferences**.
2. Select the **MF Connector** tab.
3. Under **Manual-scanning tip**, activate the **Use batch inspection or analysis process (applies to the next capture)** option and enter the time you want the preview to last.

The screenshot shows the 'User Preferences' dialog box with the 'MF Connector' tab selected. The 'Manual-scanning tip' section contains the following settings:

- Multifiber tip type: Manual-scanning tip
- 3-step inspection: Automatically stop the analysis on first fail
- File format: Normal (Recommended)
- Manual-scanning tip: Include multifiber connector overlay
- Use batch inspection or analysis process (applies to the next capture)
- Image capture preview duration: 500 ms

Buttons at the bottom include 'Revert to Factory Settings', 'OK', and 'Cancel'.

4. Tap **OK** to confirm your choice and close the window.

Setting up Your Fiber Inspection Probe and ConnectorMax2

Displaying Multifiber Connector Overlay (Manual-Scanning Tip)

Displaying Multifiber Connector Overlay (Manual-Scanning Tip)

By default, ConnectorMax2 displays the multifiber overlay only in high magnification. The overlay is used to see which of the fiber in a multifiber connector is being inspected. It is possible to see four fibers at a time when the overlay is displayed.

Note: The FIP-410B probe does not display the overlay in multifiber.

To display the multifiber connector overlay:

1. From the **Main Menu**, tap **User Preferences**.
2. Select the **MF Connector** tab.
3. Activate the **Include multifiber connector overlay** option.

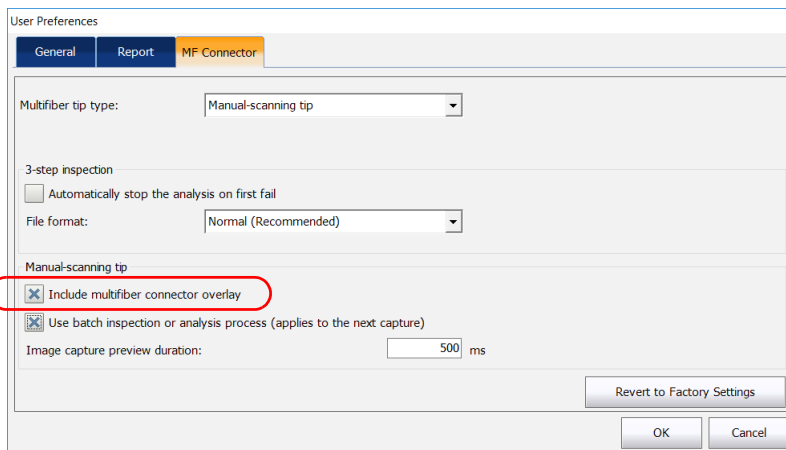

4. Tap **OK** to confirm your choice and close the window.

Setting up Your Fiber Inspection Probe and ConnectorMax2

Displaying Multifiber Connector Overlay (Manual-Scanning Tip)

In the main window, a blue arrow now indicates the fiber under test.

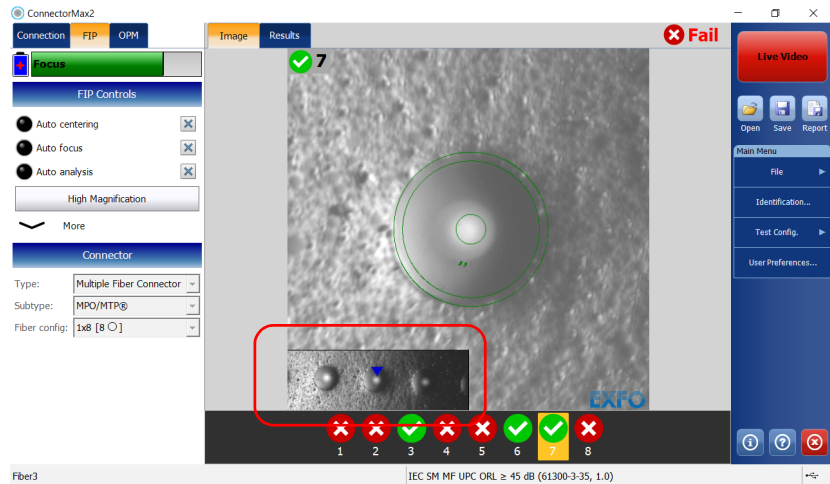

Setting up Your Fiber Inspection Probe and ConnectorMax2

Stopping the Analysis Process on First Fail (3-Step Inspections Only)

Stopping the Analysis Process on First Fail (3-Step Inspections Only)

When inspecting multifiber connectors, you can choose to stop the analysis process as soon as the application detects a fail status on a fiber. This feature is particularly useful when you need to test many fibers in the connector because you do not have to wait for the analysis process to finish and you can clean the connector end right away.

To stop the analysis process on the first fail:

1. From the **Main Menu**, tap **User Preferences**.
2. Select the **MF Connector** tab.
3. Under **3-step inspection**, select **Automatically stop the analysis on first fail**.

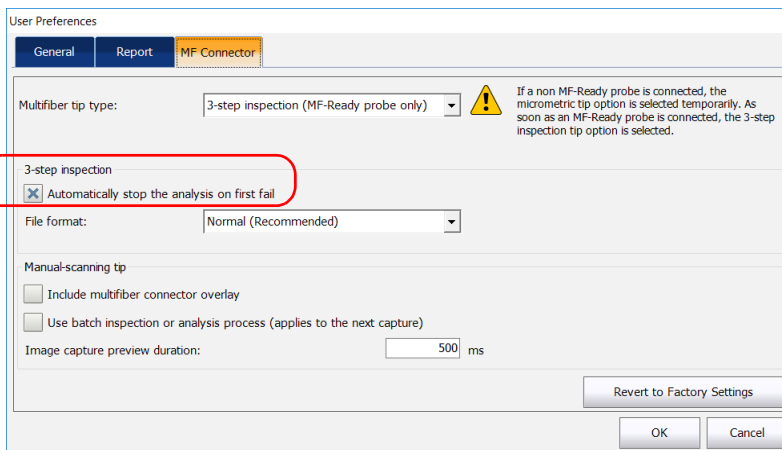

4. Tap **OK** to close the window.

Editing the Power Meter Test Configurations

You can activate and set pass/fail threshold parameters for your power meter measurements. You can set thresholds for absolute power and insertion loss. You can set different pass/fail thresholds for each available test wavelength, or apply the same thresholds to all wavelengths. Values that are greater than the predefined thresholds are displayed in white on a red background. Values that are pass are displayed in green.

To edit the power meter test configurations:

1. From the Main Menu, tap Test Config.

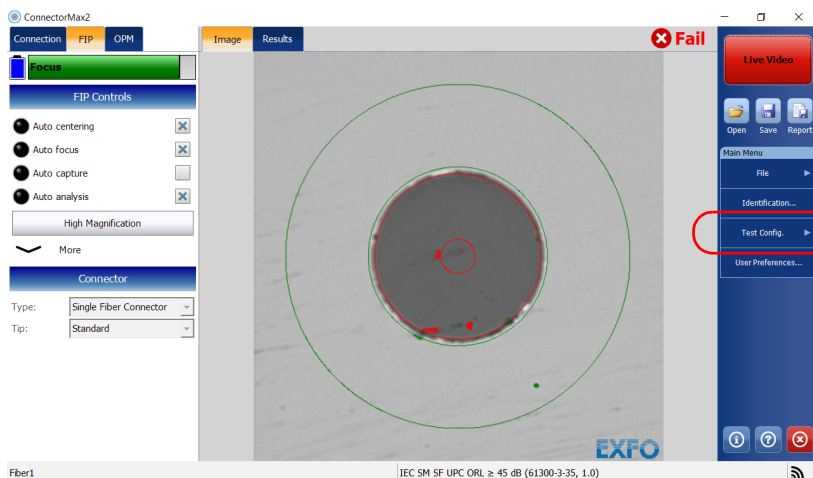

Setting up Your Fiber Inspection Probe and ConnectorMax2

Editing the Power Meter Test Configurations

2. Tap Power Meter.

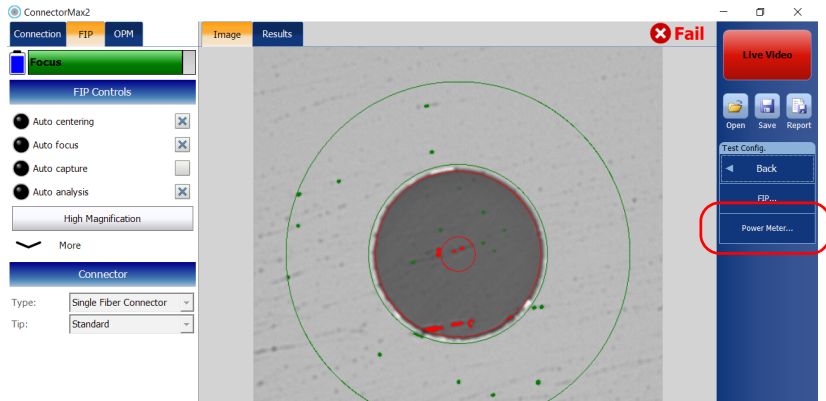

3. Select **Apply thresholds (Pass/Fail status)** to display the pass or fail status for each wavelength.

4. From the **Wavelengths** list, select the wavelengths for which you want to set a threshold.

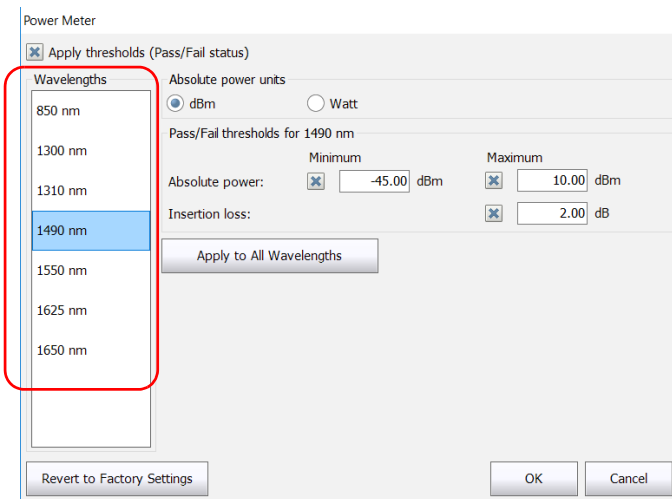

5. Modify the thresholds for the selected wavelength.

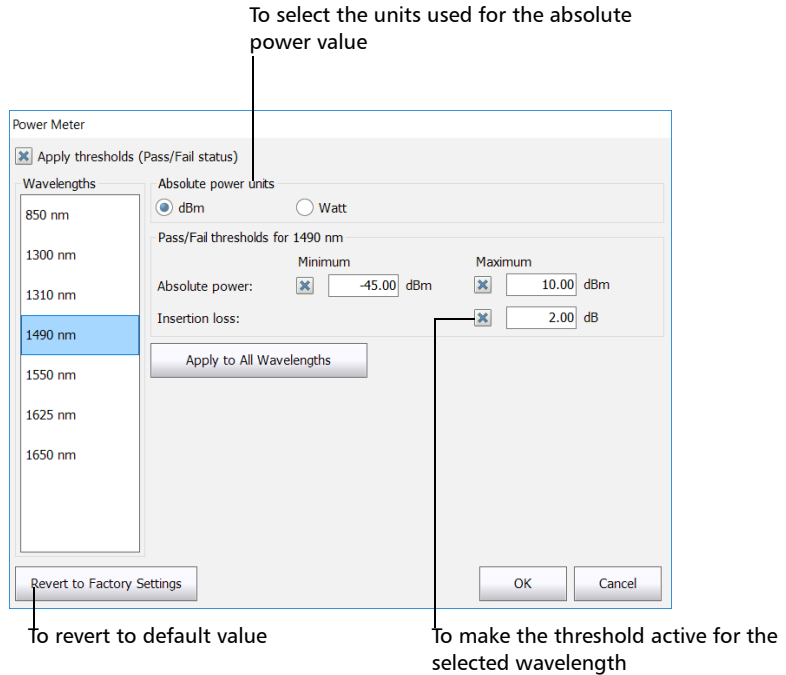

6. Tap **OK** to return to the main window.

Reverting to Factory Settings

At any time in the application, you can revert to factory settings in your menus. However, the **Revert to Factory Settings** button is valid only for the window or tab where you use it.

Changing Fiber Information of Existing Captures

It is possible to modify the information for an existing capture. This information is provided by the automatic file naming. The procedure is almost the same as the one for autonaming but the changes apply to the current capture only.

To change fiber information:

1. From the **Main Menu**, tap **Identification**.
2. From the **Apply to** list, ensure that **Current capture** is selected.

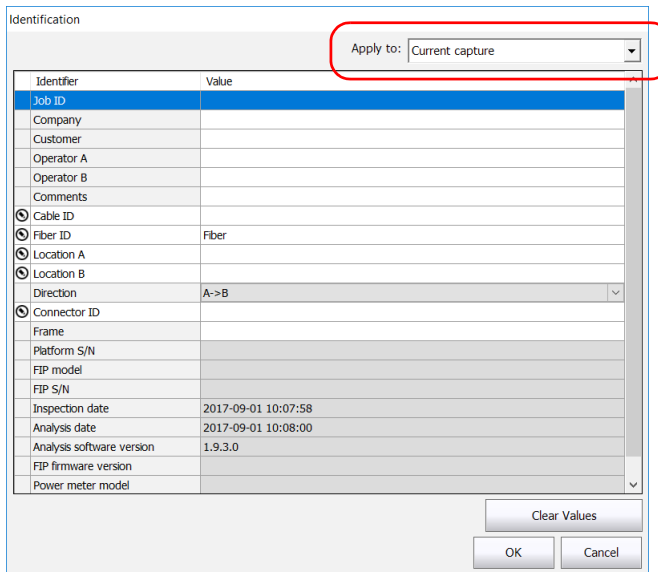

The screenshot shows the 'Identification' dialog box. At the top right, there is a dropdown menu labeled 'Apply to:' with 'Current capture' selected. Below this is a table with two columns: 'Identifier' and 'Value'. The table contains the following rows:

Identifier	Value
Job ID	
Company	
Customer	
Operator A	
Operator B	
Comments	
<input checked="" type="checkbox"/> Cable ID	
<input checked="" type="checkbox"/> Fiber ID	Fiber
<input checked="" type="checkbox"/> Location A	
<input checked="" type="checkbox"/> Location B	
Direction	A->B
<input checked="" type="checkbox"/> Connector ID	
Frame	
Platform S/N	
FIP model	
FIP S/N	
Inspection date	2017-09-01 10:07:58
Analysis date	2017-09-01 10:08:00
Analysis software version	1.9.3.0
FIP firmware version	
Power meter model	

At the bottom right of the dialog box, there are three buttons: 'Clear Values', 'OK', and 'Cancel'.

3. Set the parameters as needed. For more information, see *Setting up Autonaming* on page 38.

4 **Inspecting Fiber Ends**

Viewing the fiber inspection is done using ConnectorMax2. You can start the application before or after connecting the probe, and the view on-screen will be automatically updated.



WARNING

Never look directly into a live fiber. It could cause serious eye damage. Always use your FIP-400B Series Fiber Inspection Probe.

Inspecting Fiber Ends (Single Fiber and Transceiver - Fiber Receptacles)

When you connect the FIP-400B Series Fiber Inspection Probe to your unit, you can view and inspect fiber ends right away. This direct viewing mode is known as the *live video* mode.

Since the available controls depend on the probe that is connected, if you disconnect the probe, the application will show an empty window. The controls become available again as soon as you reconnect the probe (no need to restart the application).

Note: *When the internal temperature of the FIP-415B, FIP-430B and FIP-435B is too low, the probe performs a warmup that can last up to a minute.*

You can also capture images of your inspections to include in reports, or save them for future analyses. This is known as the *capture* mode.

Note: *A digital watermark is added to the images generated by the application. This also applies to ConnectorMax1 files converted to the ConnectorMax2 format.*

Inspecting Fiber Ends

Inspecting Fiber Ends (Single Fiber and Transceiver - Fiber Receptacles)

The focus indicator, which is displayed in the upper left part of the main window, shows whether the current view is optimized for a capture. A green indicator shows a picture that can be captured and analyzed. Analysis will be more difficult with a yellow indicator, and impossible with a red indicator. A black bar displays the peak focus level.

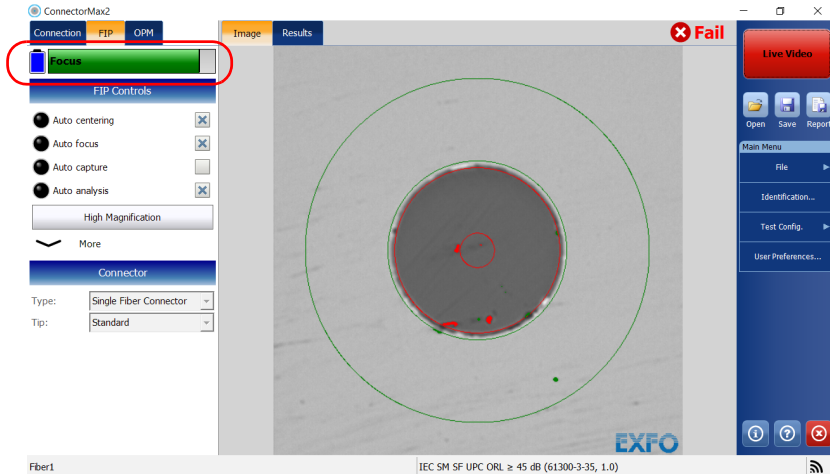

For more information on analysis, see *Analyzing Captures* on page 118.

To inspect fiber ends (single fiber and transceiver):

1. Install a probe tip (see *Changing the Fiber Inspection Probe Tip* on page 28 for details).
2. Insert the fiber into the probe tip.
3. Start ConnectorMax2 if it is not already started.
4. Configure the automatic file naming as needed (see *Setting up Autonaming* on page 38 for details).
5. Choose the type of connector you want to use (single fiber or transceiver).

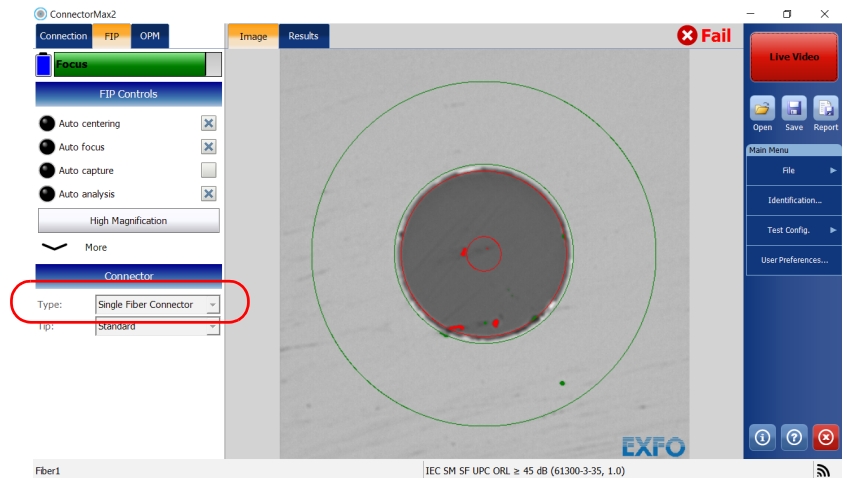

Inspecting Fiber Ends

Inspecting Fiber Ends (Single Fiber and Transceiver - Fiber Receptacles)

6. Choose the type of connector tip you want to use (standard, LC APC or E2000 APC).

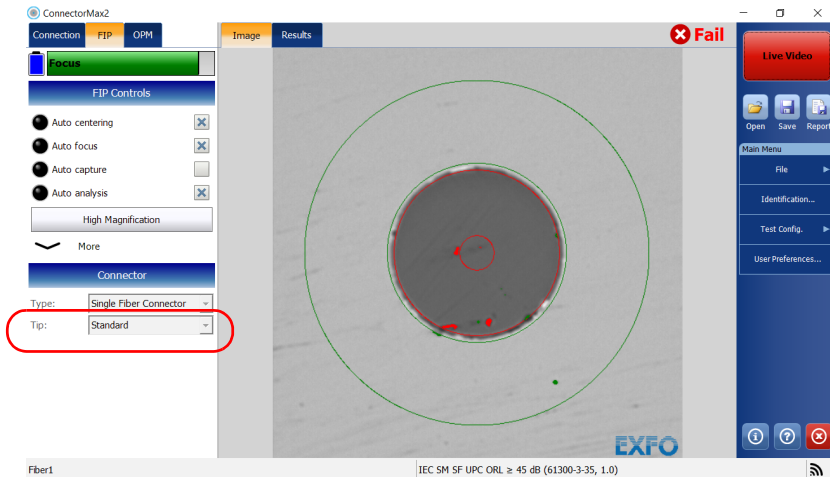

Inspecting Fiber Ends

Inspecting Fiber Ends (Single Fiber and Transceiver - Fiber Receptacles)

7. If you want to use a specific test configuration for your test, tap **Test Config.** See *Managing and Selecting Test Configurations* on page 45 for details.

Note: *The test configuration list is updated according to the connector type you have selected in the **FIP** tab.*

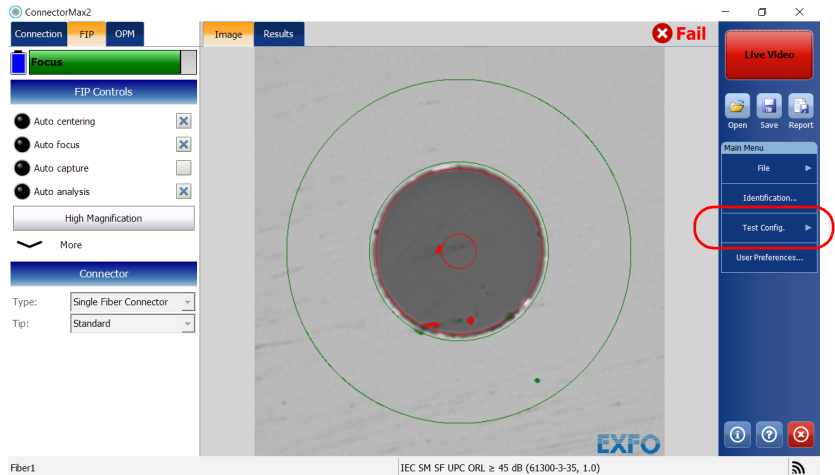

Inspecting Fiber Ends

Inspecting Fiber Ends (Single Fiber and Transceiver - Fiber Receptacles)

8. Depending on the probe you are using, proceed as follows:
 - If you have an FIP-415B, activate the auto centering, the auto focus, and the auto capture. You can also activate the auto analysis option if you have purchased it from EXFO.

Note: *You cannot activate the auto analysis option from a computer. You must activate it using a smart device. Once activated, the auto analysis option will also be available when you use the FIP-415B with a computer.*

- If you have an FIP-420B or FIP-425B, activate the auto analysis and the auto centering, then adjust the magnification level and the image focus to have the best view of the fiber end.
- If you have an FIP-430B or FIP-435B, activate the auto analysis, the auto centering, the auto focus, and the auto capture.

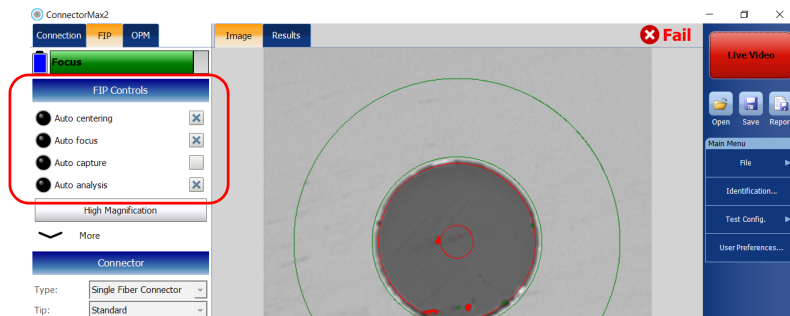

For more information, see *Analyzing Captures* on page 118.

9. If the fiber end is dirty, remove the fiber from the probe, clean the fiber end, and reinspect it.
10. Once you are satisfied with the inspection, while in high-magnification level, press **Capture**.
OR
Press the Fiber Inspection Probe capture control button.
11. Go to the next connector or close the application.

Inspecting Multiple Fiber Ends

The multifiber inspection with an FIP-415B, FIP-430B or an FIP-435B probe allows you to see multiple fibers at a time.

When you connect a standard or an MF-Ready probe to your unit, you can view and inspect multiple fiber ends right away. This direct viewing mode is known as the *live video* mode.

Since the available controls depend on the probe that is connected, if you disconnect the probe, the application will show an empty window. The controls become available again as soon as you reconnect the probe (no need to restart the application).

Depending on the probe you are using, you can attach two types of connector tips to perform a multiple fiber end inspection:

- the manual-scanning tip can be used with both probes (MF-Ready or not). With this type of inspection, the analysis process can be done separately for each fiber, or as a batch.
- the 3-step inspection tip can be used with MF-Ready probes only.

Note: *When the internal temperature of the FIP-415B, FIP-430B and FIP-435B is too low, the probe performs a warmup that can last up to a minute.*

You can also capture images of your inspections to include in reports, or save them for future analyses. This is known as the *capture* mode.

Note: *A digital watermark is added to the images generated by the application. This also applies to ConnectorMax1 files converted to the ConnectorMax2 format.*

Inspecting Fiber Ends

Inspecting Multiple Fiber Ends

The focus indicator, which is displayed in the upper left part of the main window, shows whether the current view is optimized for a capture. A green indicator shows a picture that can be captured and analyzed. Analysis will be more difficult with a yellow indicator, and impossible with a red indicator. A black bar displays the peak focus level.

Single-row multifiber connector

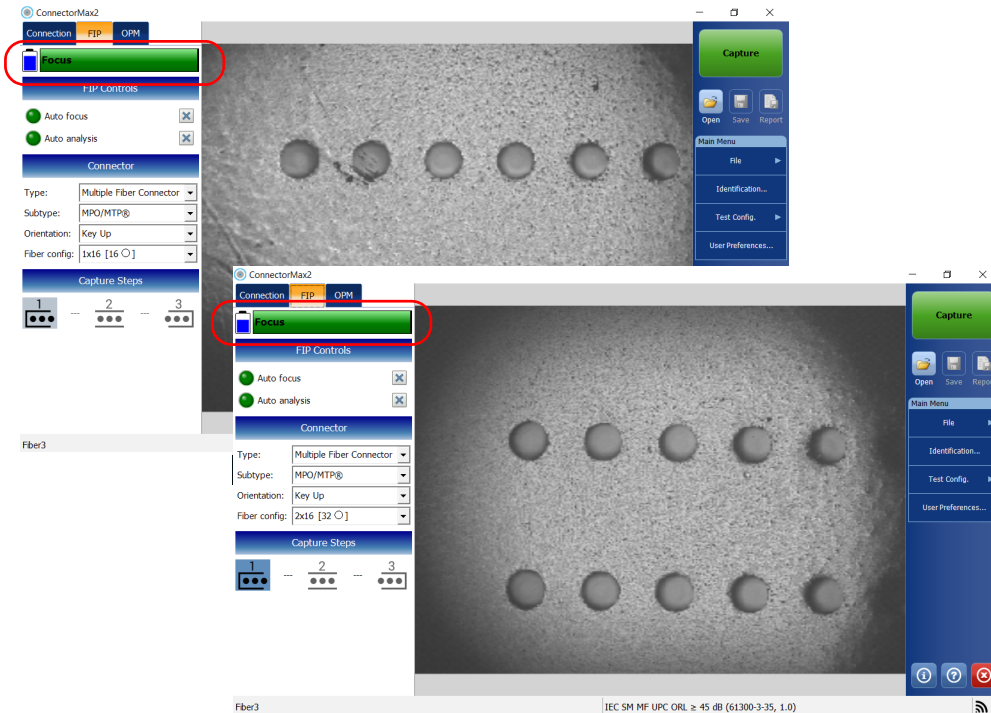

Dual-row multifiber connector

For more information on analysis, see *Analyzing Captures* on page 118.

Inspecting Fiber Ends As a Batch (Manual-Scanning Tip)

To speed up the process of inspecting and analyzing connectors and fibers, you can use the batch inspection feature (see *Enabling the Multifiber Inspection as a Batch (Manual-Scanning Tip)* on page 63 for details).

With this feature, all fibers are captured and previewed one after the other. It can be particularly useful when you need to test many fibers in the connector, because you can process the results of the already-tested fibers at any time during the multifiber inspection. Since you do not have to wait for all fibers to be tested, you can clean the connector end right away and even retest a fiber that has already been tested.

To inspect multiple fiber ends as a batch:

- 1.** Insert an MTP/MPO single-row or multi-row tip on the probe by aligning the key of the probe with the notch of the tip (see *Changing the Fiber Inspection Probe Tip* on page 28 for details).
- 2.** Insert a replaceable APC or UPC nozzle in and tighten it.



- 3.** Insert the bulkhead adapter on the nozzle.
- 4.** Insert the connector into the bulkhead adapter.
- 5.** Start ConnectorMax2 if it is not already started.

Inspecting Fiber Ends

Inspecting Multiple Fiber Ends

- 6. Ensure that the batch inspection feature is enabled (see *Enabling the Multifiber Inspection as a Batch (Manual-Scanning Tip)* on page 63 for details).
- 7. Ensure that the multifiber connector overlay is enabled (see *Displaying Multifiber Connector Overlay (Manual-Scanning Tip)* on page 64 for details).
- 8. If you are working with an MF-Ready probe, proceed as follows:
 - 8a. Tap **User Preferences**.

Indicates the overlay feature is enabled

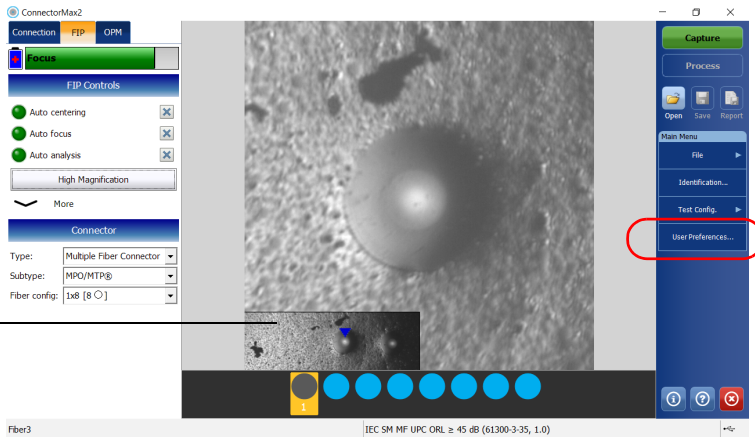

8b. Select the **MF Connector** tab.

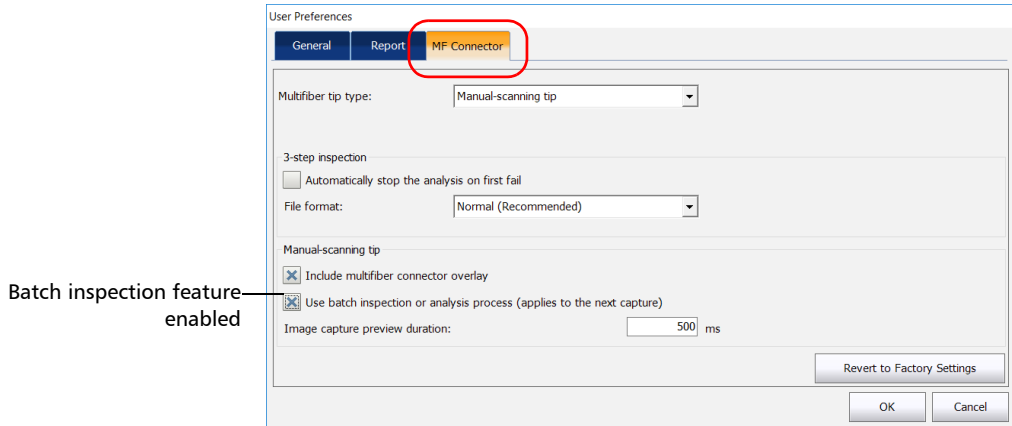

8c. Select **Manual-scanning tip** in the **Multifiber tip type** list.

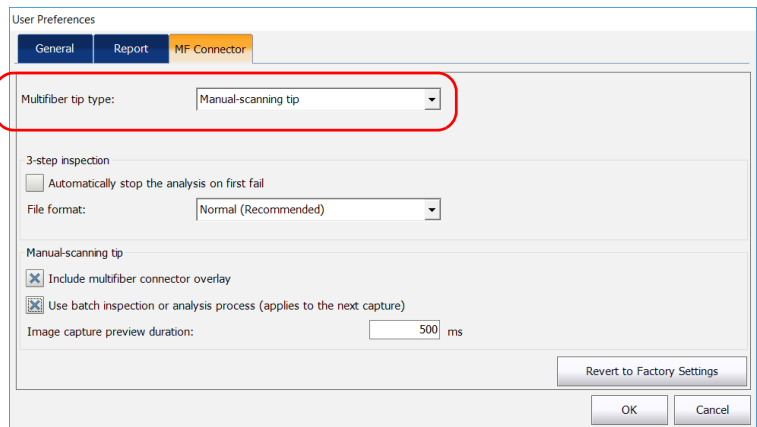

8d. Tap **OK** to return to the main window.

9. Configure the automatic file naming as needed (see *Setting up Autonoming* on page 38 for details).

Inspecting Fiber Ends

Inspecting Multiple Fiber Ends

10. From the main window, choose **Multiple Fiber Connector**.

When the **Process** button is visible, it indicates the batch inspection feature is enabled.

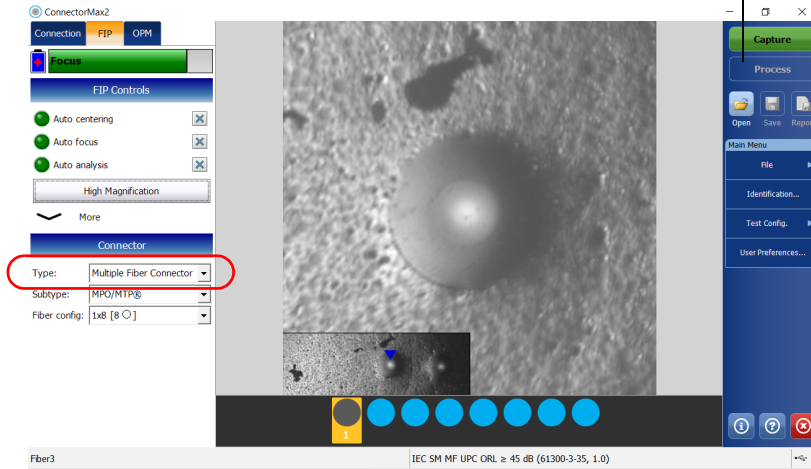

11. Select a connector subtype.

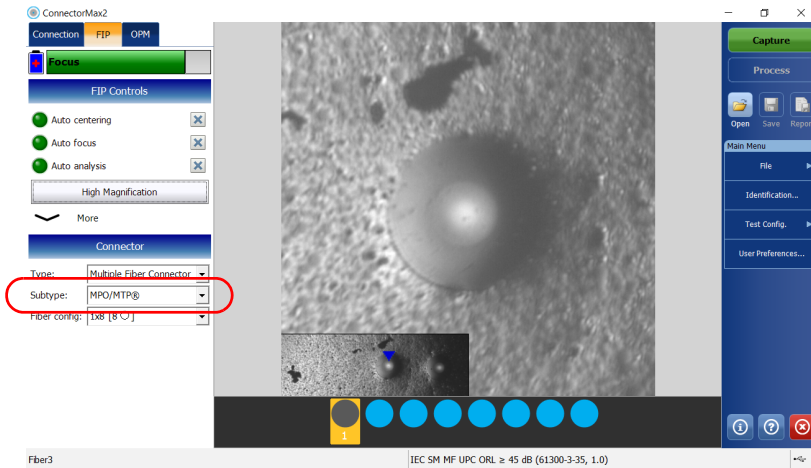

- 12.** Select the fiber configuration applying to the connector you use for your inspection.

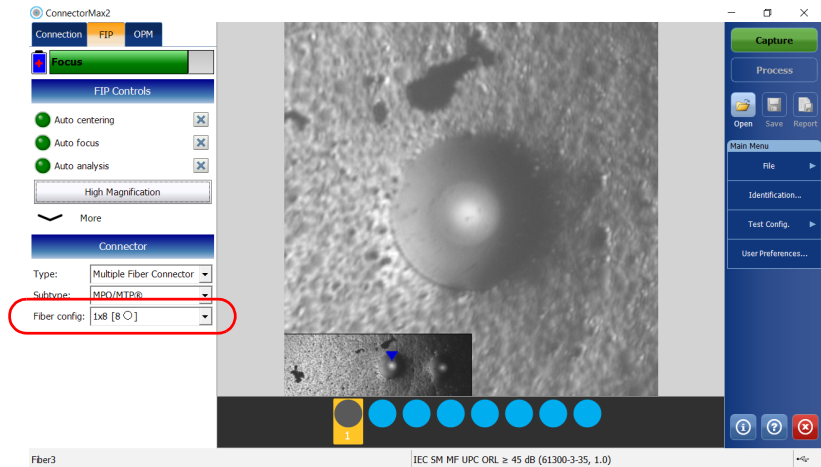

Inspecting Fiber Ends

Inspecting Multiple Fiber Ends

- 13.** If you want to use a specific test configuration for your test, tap **Test Config.** See *Managing and Selecting Test Configurations* on page 45 for details.

Note: The test configuration list is updated according to the connector type you have selected in the **FIP** tab.

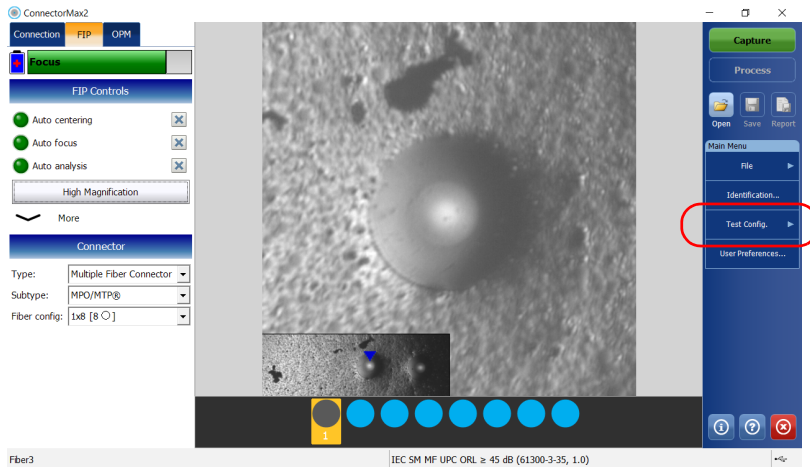

14. Depending on the probe you are using, proceed as follows:

- If you have an FIP-415B, activate the auto centering, the auto focus, and the auto capture. You can also activate the auto analysis option if you have purchased it from EXFO.

Note: *You cannot activate the auto analysis option from a computer. You must activate it using a smart device. Once activated, the auto analysis option will also be available when you use the FIP-415B with a computer.*

- If you have an FIP-420B or FIP-425B, activate the auto analysis and the auto centering.
- If you have an FIP-430B or FIP-435B, activate the auto analysis, the auto centering, the auto focus and the auto capture.

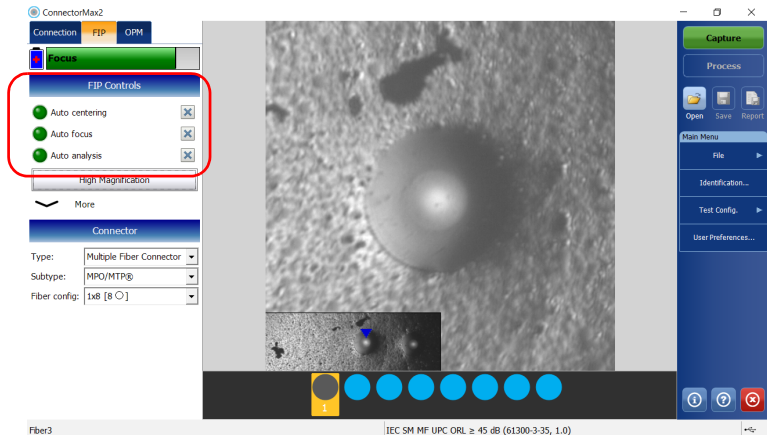

For more information, see *Analyzing Captures* on page 118.

15. Set the probe to **Low Magnification** and locate the first fiber.

Note: *If you are having trouble locating the fiber, you can use the X and Y wheels on the manual-scanning tip.*

Inspecting Fiber Ends

Inspecting Multiple Fiber Ends

- 16.** When you have located the desired fiber, set the probe to **High Magnification**.

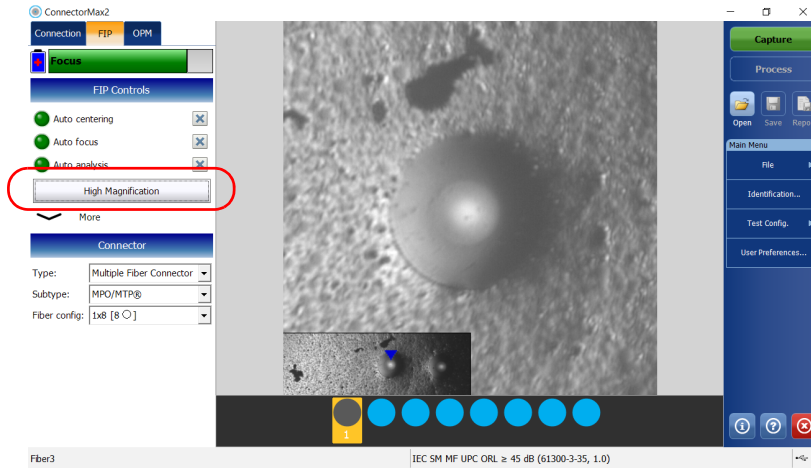

Note: The FIP-415B, FIP-420B/FIP-425B and FIP-430B/FIP-435B probes show a low-magnification connector image in the overlay.

- 17.** By looking at the overlay, ensure that the blue arrow is pointing in the middle of the fiber under test (see *Displaying Multifiber Connector Overlay (Manual-Scanning Tip)* on page 64 for details):

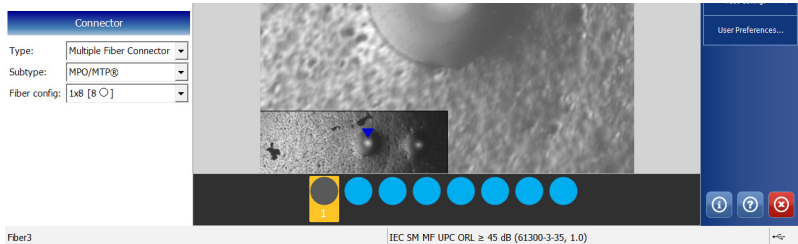

- For multi-row tips, use the Y wheel to select the required fiber row.
- For multi-row and single-row tips, use the X wheel to select the required fiber.



Inspecting Fiber Ends

Inspecting Multiple Fiber Ends

18. If the results on-screen are not optimal, you can do the following:

Note: *The auto focus starts automatically only for the first fiber (FIP-415B, FIP-430B and FIP-435B only).*

- Hold the magnification control button located on the probe for one second to reactivate the auto focus process (FIP-415B, FIP-430B and FIP-435B only).

OR

- Adjust focus manually.

19. If the connector is dirty, remove the fiber from the probe, clean the fiber end, and reinspect it.

20. While in high-magnification level, press **Capture**.

OR

Press the Fiber Inspection Probe capture control button.

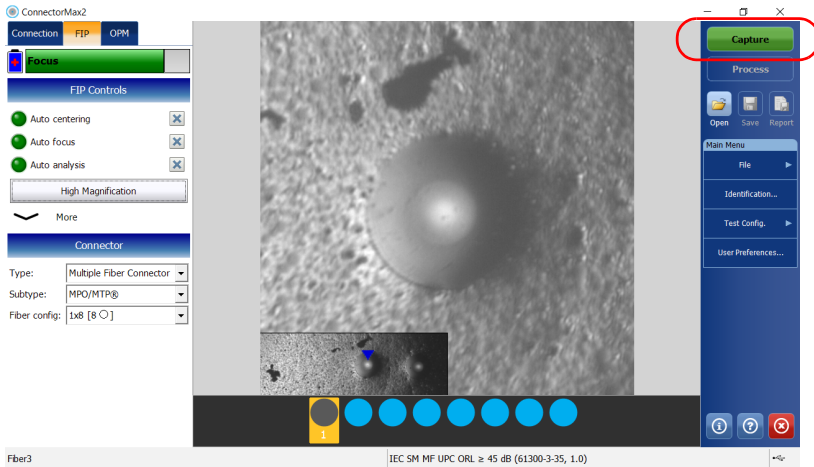

21. Repeat steps 16 to 20 until you reach the end of the connector.

22. Tap Process.

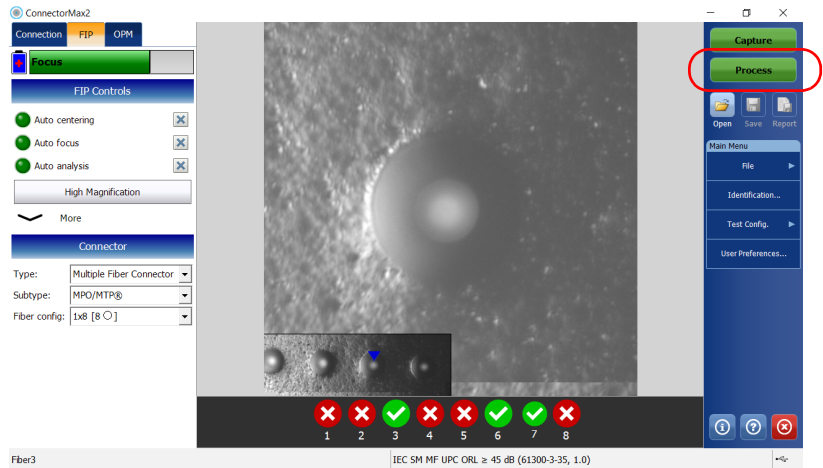

Note: You can tap **Process** to view the status for each fiber that you have tested at any time. You can also retest a fiber (see Retesting Fibers of Connectors With Multifiber Ends (Manual-Scanning Tip) on page 109 for details).

23. When you have reached the end of the connector, tap **File**, then **New** to inspect another connector.

Note: If you have not save the results of your inspection, the application will prompt you to save them.

Inspecting Fiber Ends

Inspecting Multiple Fiber Ends

Inspecting Fiber Ends Separately (Manual-Scanning Tip)

When the inspection and the analysis are done separately, there is a transition between the live video mode and the capture mode after an image is captured.

Note: *You must disable the batch inspection feature when you want to inspect multiple fiber ends separately. See Enabling the Multifiber Inspection as a Batch (Manual-Scanning Tip) on page 63 for details.*

To inspect multiple fiber ends separately:

1. Insert an MTP/MPO single-row or multi-row tip on the probe by aligning the key of the probe with the notch of the tip (see *Changing the Fiber Inspection Probe Tip* on page 28 for details).
2. Insert a replaceable APC or UPC nozzle in and tighten it.



3. Insert the bulkhead adapter on the nozzle.
4. Insert the connector into the bulkhead adapter.

5. Start ConnectorMax2 if it is not already started.
6. Ensure that the multifiber connector overlay is enabled (see *Displaying Multifiber Connector Overlay (Manual-Scanning Tip)* on page 64 for details).
7. If you are working with an MF-Ready probe, proceed as follows:
 - 7a. Tap **User Preferences**.

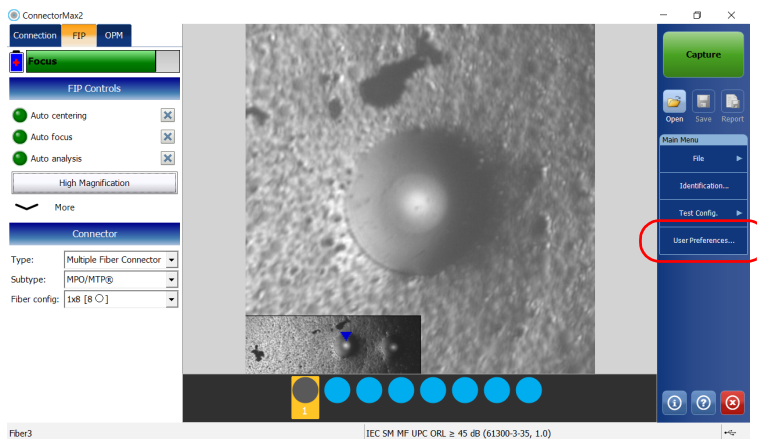

Inspecting Fiber Ends

Inspecting Multiple Fiber Ends

7b. Select the **MF Connector** tab.

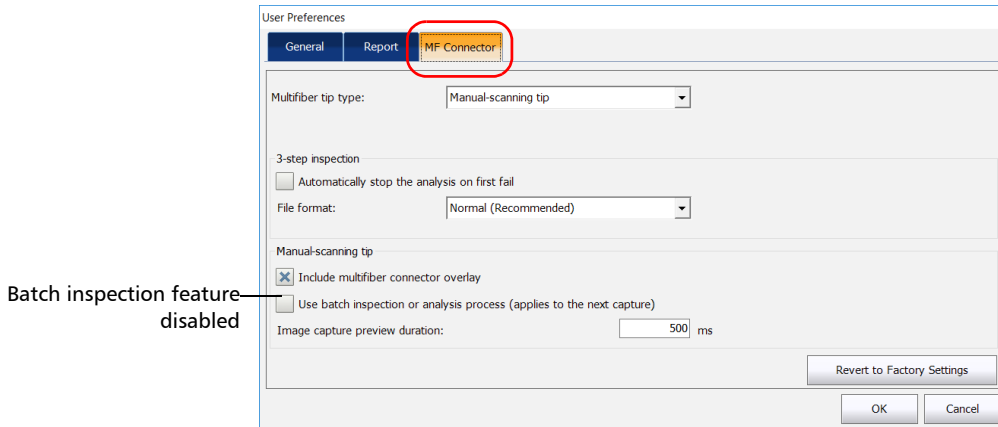

7c. Select **Manual-scanning tip** in the **Multifiber tip type** list.

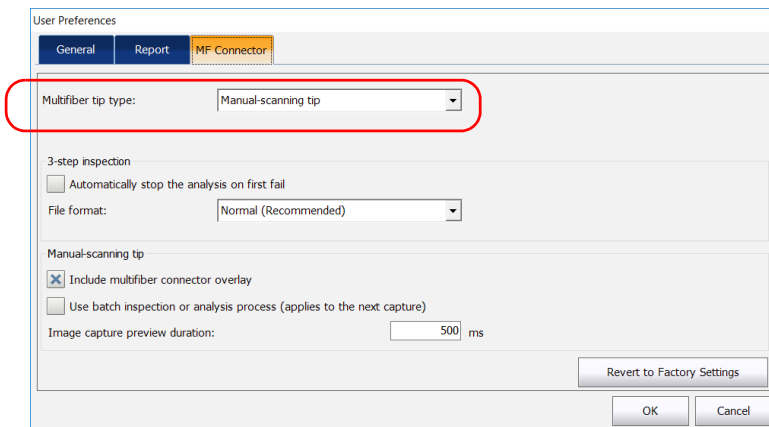

7d. Tap **OK** to return to the main window.

8. Configure the automatic file naming as needed (see *Setting up Autonoming* on page 38 for details).

9. From the main window, choose **Multiple Fiber Connector**.

When the **Process** button is not visible, it indicates the batch inspection feature is disabled.

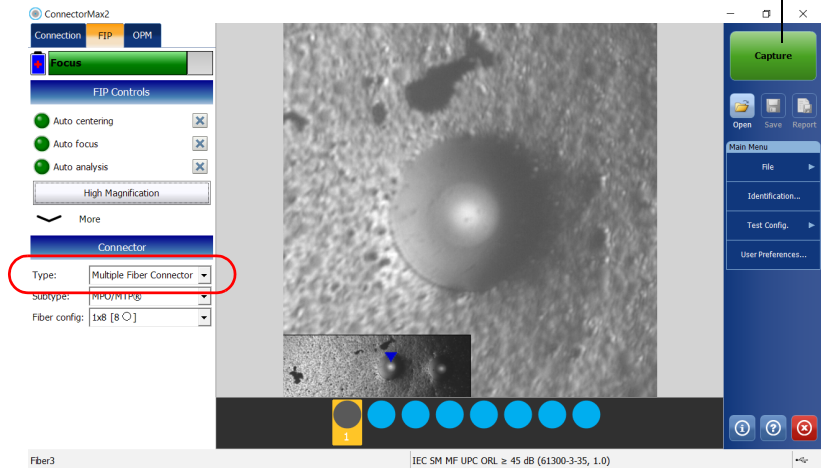

10. Select a connector subtype.

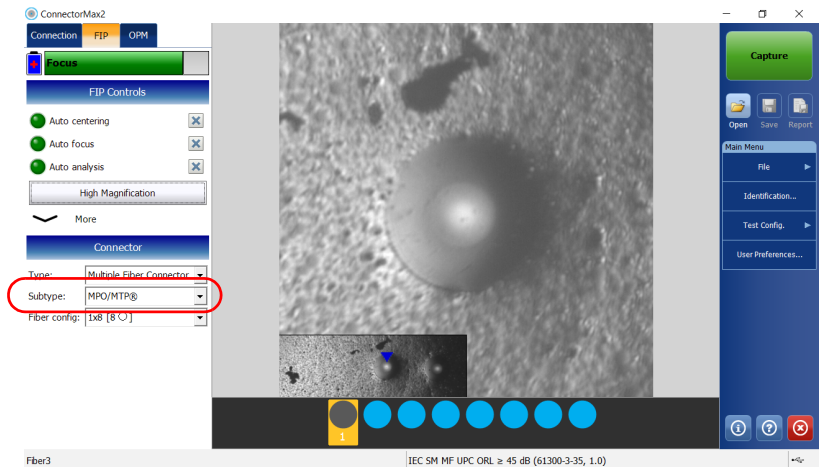

Inspecting Fiber Ends

Inspecting Multiple Fiber Ends

11. Select the fiber configuration applying to the connector you use for your inspection.

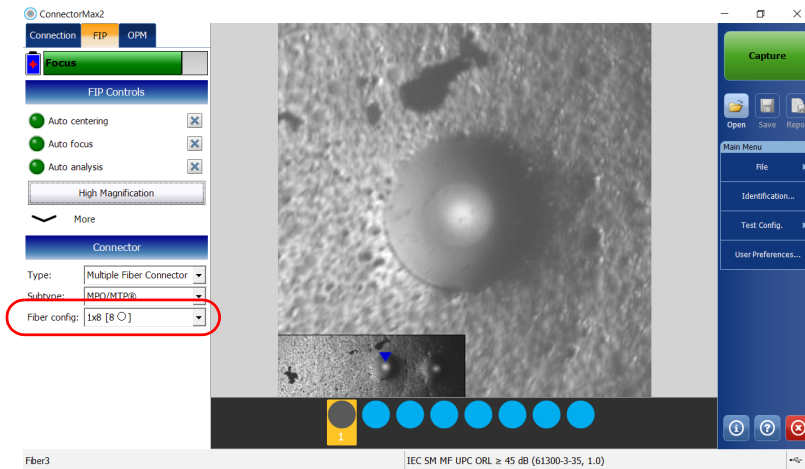

- If you want to use a specific test configuration for your test, tap **Test Config.** See *Managing and Selecting Test Configurations* on page 45 for details.

Note: The test configuration list is updated according to the connector type you have selected in the **FIP** tab.

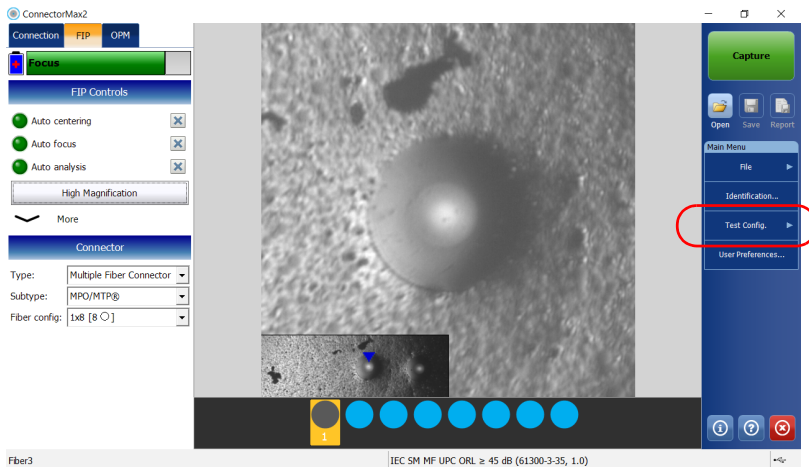

Inspecting Fiber Ends

Inspecting Multiple Fiber Ends

13. Depending on the probe you are using, proceed as follows:

- If you have an FIP-415B, activate the auto centering, the auto focus, and the auto capture. You can also activate the auto analysis option if you have purchased it from EXFO.

Note: *You cannot activate the auto analysis option from a computer. You must activate it using a smart device. Once activated, the auto analysis option will also be available when you use the FIP-415B with a computer.*

- If you have an FIP-420B or FIP-425B, activate the auto analysis and the auto centering.
- If you have an FIP-430B or FIP-435B, activate the auto analysis, the auto centering, the auto focus and the auto capture.

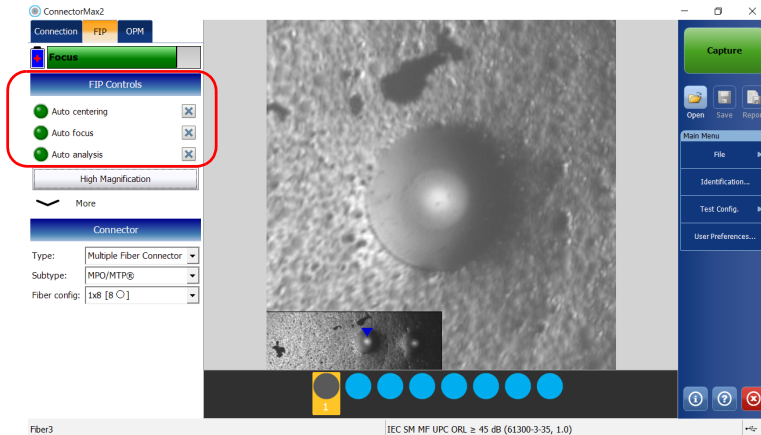

For more information, see *Analyzing Captures* on page 118.

14. Set the probe to **Low Magnification** and locate the first fiber.

Note: *If you are having trouble locating the fiber, you can use the X and Y wheels on the manual-scanning tip.*

15. When you have located the desired fiber, set the probe to **High Magnification**.

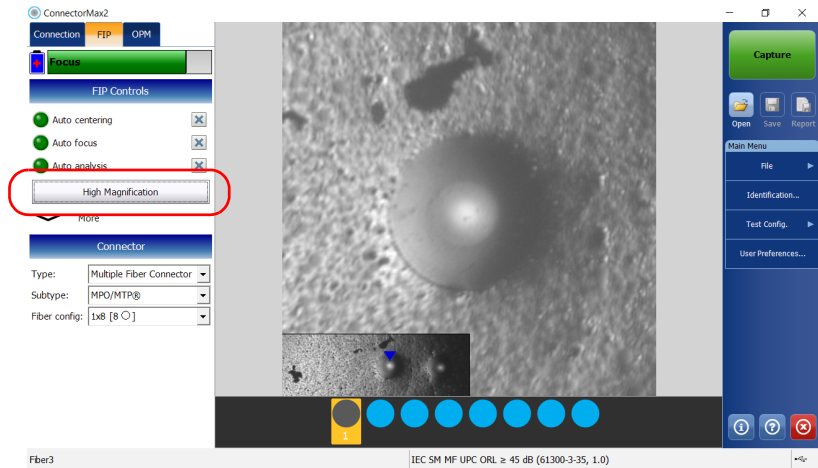

Note: The FIP-415B, FIP-420B/FIP-425B and FIP-430B/FIP-435B probes show a low-magnification connector image in the overlay.

Inspecting Fiber Ends

Inspecting Multiple Fiber Ends

- 16.** By looking at the overlay, ensure that the blue arrow is pointing in the middle of the fiber under test (see *Displaying Multifiber Connector Overlay (Manual-Scanning Tip)* on page 64 for details):

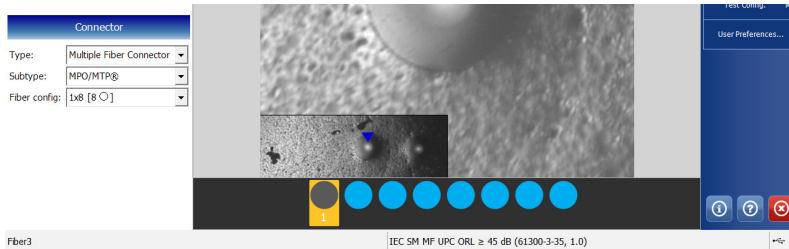

- For multi-row tips, use the Y wheel to select the required fiber row.
- For multi-row and single-row tips, use the X wheel to select the required fiber.



17. If the results on-screen are not optimal, you can do the following:

Note: *The auto focus starts automatically only for the first fiber (FIP-415B, FIP-430B and FIP-435B only).*

- Hold the magnification control button located on the probe for one second to reactivate the auto focus process (FIP-415B, FIP-430B and FIP-435B only).

OR

- Adjust focus manually.

18. If the connector is dirty, remove the fiber from the probe, clean the fiber end, and reinspect it.

19. While in high-magnification level, press **Capture**.

OR

Press the Fiber Inspection Probe capture control button.

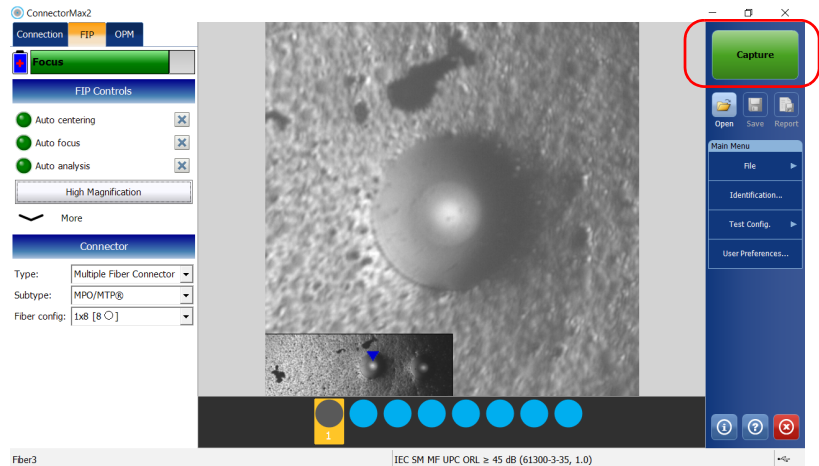

Inspecting Fiber Ends

Inspecting Multiple Fiber Ends

20. Return to live video mode.

21. Repeat steps 15 to 20 until you reach the end of the connector.

Note: *You can retest a fiber at any time after a capture is made (see Retesting Fibers of Connectors With Multifiber Ends (Manual-Scanning Tip) on page 109 for details).*

22. When you have reached the end of the connector, tap **File**, then **New** to inspect another connector.

Note: *If you have not saved the results of your inspection, the application will prompt you to do so.*

Inspecting Fiber Ends With the 3-Step Inspection Tip (MF-Ready Probes Only)

The inspection of multiple fiber ends with the 3-step inspection tip requires three captures. As soon as the third capture is performed, the analysis process starts automatically.

To inspect multiple fiber ends with the 3-step inspection tip:

1. Install a removable nozzle on the MF-Ready probe (see *Changing the FIP Nozzle (MF-Ready Probes Only)* on page 29 for details).
2. Insert the connector into the removable nozzle.
3. Start ConnectorMax2 if it is not already started.
4. Configure the automatic file naming as needed (see *Setting up Autonaming* on page 38 for details).
5. From the main window, choose **Multiple Fiber Connector**.

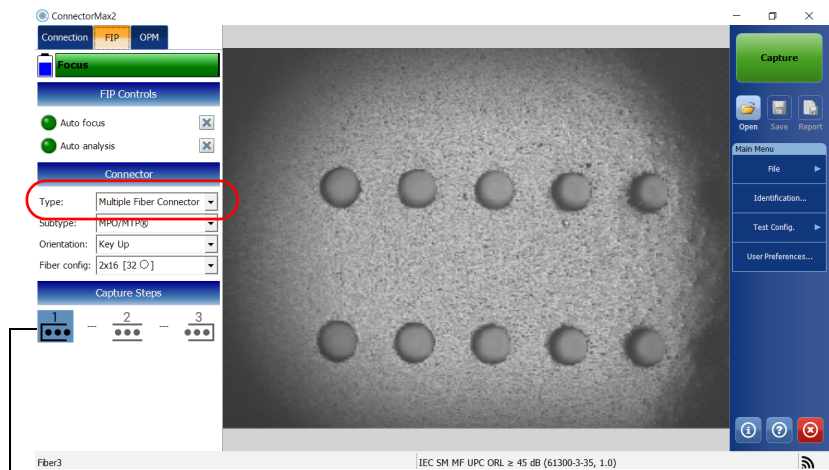

Icons indicating the order to follow to perform the 3 captures. The icons on screen must match the icons on the movable part of the inspection tip.

Inspecting Fiber Ends

Inspecting Multiple Fiber Ends

6. To select the multifiber tip type, proceed as follows:

6a. Tap User Preferences.

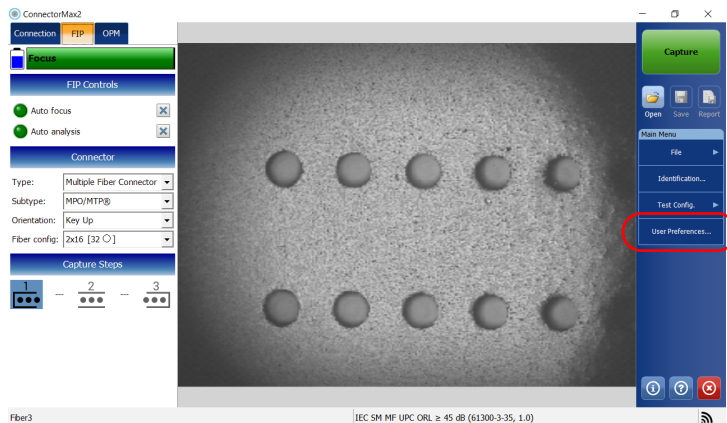

6b. Select the MF Connector tab.

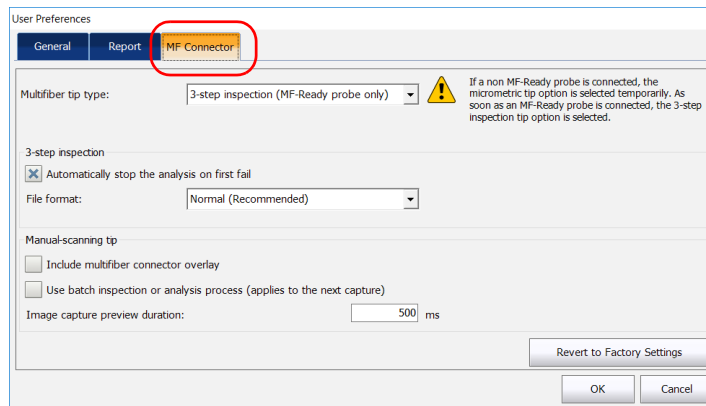

6c. Select **3-step inspection (MF-Ready probe only)** in the **Multifiber tip type** list.

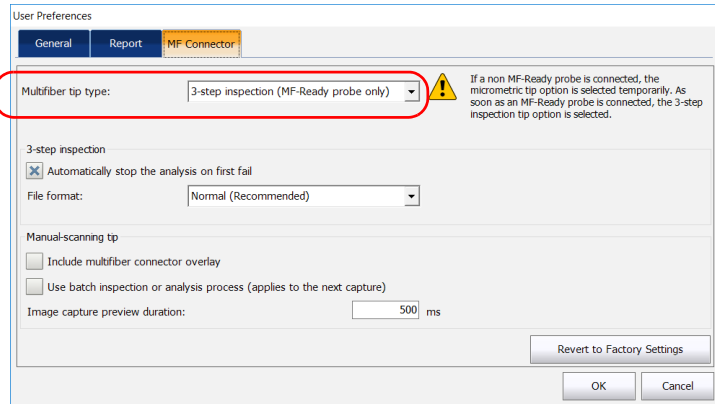

6d. Tap **OK** to return to the main window.

7. Select a connector subtype.

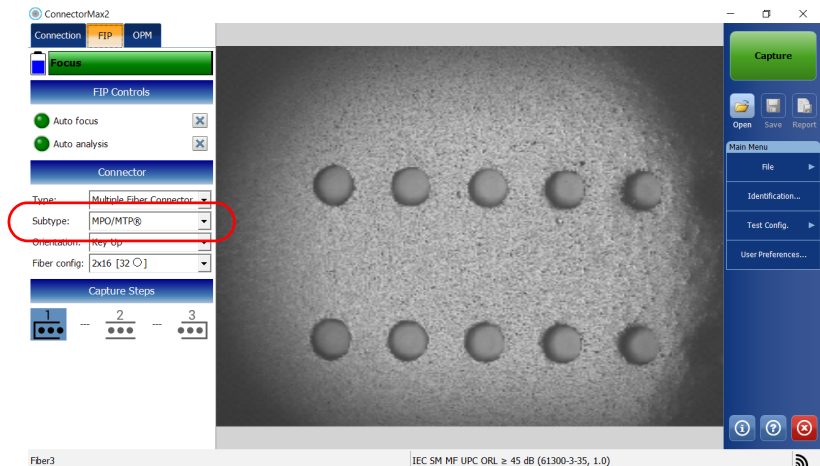

Inspecting Fiber Ends

Inspecting Multiple Fiber Ends

8. Select if you have inserted the removable nozzle key up or key down.

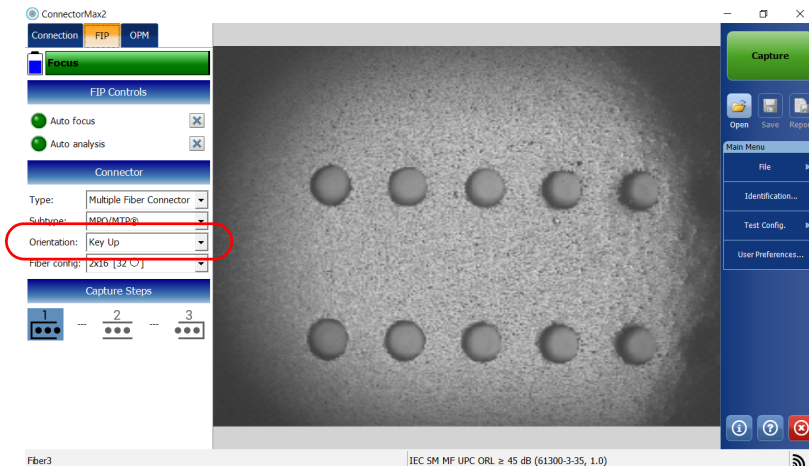

9. Select the fiber configuration applying to the connector you use for your inspection.

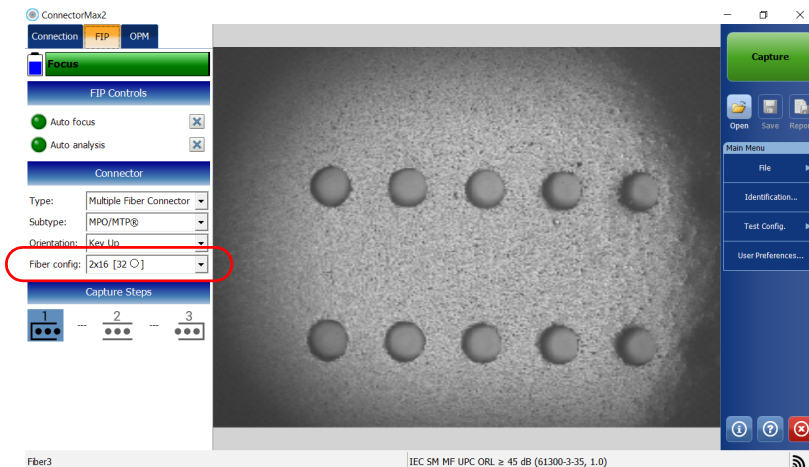

Note: *The application does not analyze dark fibers even if they do appear in live video mode.*

10. If you want to use a specific test configuration for your test, tap **Test Config.** See *Managing and Selecting Test Configurations* on page 45 for details.

Note: The test configuration list is updated according to the connector type you have selected in the **FIP** tab.

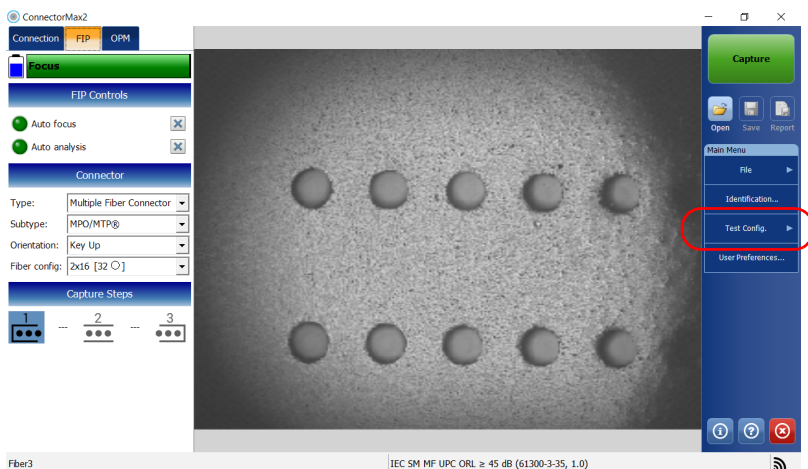

Inspecting Fiber Ends

Inspecting Multiple Fiber Ends

11. Depending on the probe you are using, proceed as follows:

- If you have an FIP-415B, activate the auto focus. You can also activate the auto analysis option if you have purchased it from EXFO.

Note: *You cannot activate the auto analysis option from a computer. You must activate it using a smart device. Once activated, the auto analysis option will also be available when you use the FIP-415B with a computer.*

- If you have an FIP-425B, activate the auto analysis.
- If you have an FIP-435B, activate the auto analysis and the auto focus.

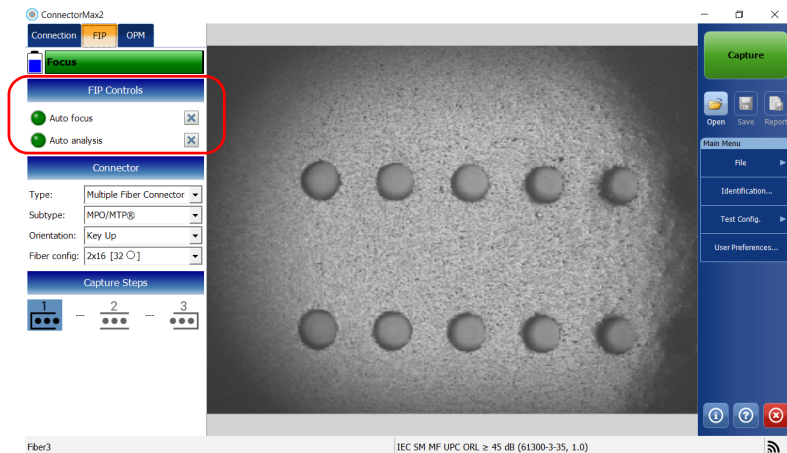

For more information, see *Analyzing Captures* on page 118.

12. If the connector is dirty, remove the fiber from the probe, clean the fiber end, and reinspect it.

13. To perform the first capture (out of three), proceed as follows:

13a. Using the trigger, slide the movable part of the inspection tip towards the nozzle until it stops.

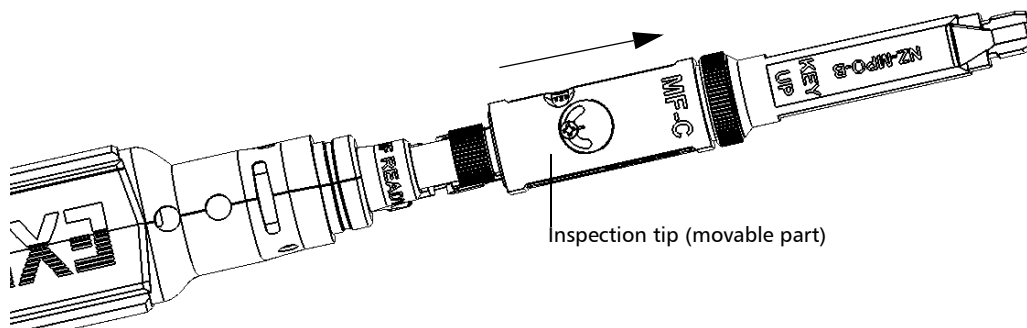

13b. Once you are satisfied with the inspection, tap **Capture**.

OR

Press the Fiber Inspection Probe capture control button.

Note: *If you are not satisfied with capture number one, you can take it again. When the first capture is done, the application automatically switches to*

2. Tap 1 to perform capture number one again.

Inspecting Fiber Ends

Inspecting Multiple Fiber Ends

14. To perform the second capture, proceed as follows:

14a. Using the trigger, slide the movable part of the inspection tip at position 2 (halfway between position 1 and 3). Position 2 is illustrated with this icon $\frac{2}{\dots}$ on the MF-Ready probe.

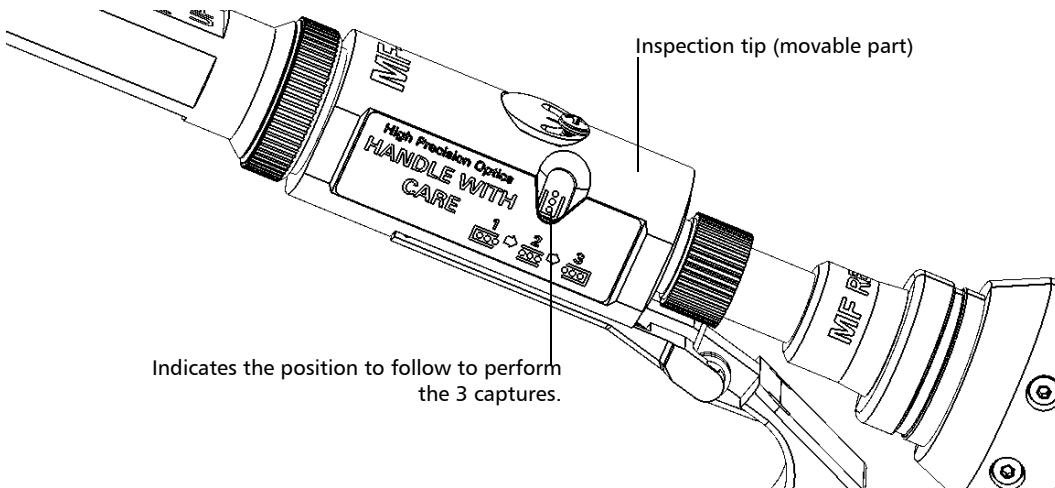

14b. Once you are satisfied with the inspection, tap **Capture**.

OR

Press the Fiber Inspection Probe capture control button.

Note: *If you are not satisfied with capture number two, you can take it again. When the second capture is done, the application automatically switches to $\frac{3}{\dots}$. Tap $\frac{2}{\dots}$ to perform capture number two again. As long as the third capture is not performed, you can retake the first and second captures. Redoing capture one when capture two was already made means that you will have to redo capture two as well.*

15. To perform the third and last capture, proceed as follows:

15a. Using the trigger, slide the movable part of the inspection tip until it stops to hide the retaining nut.

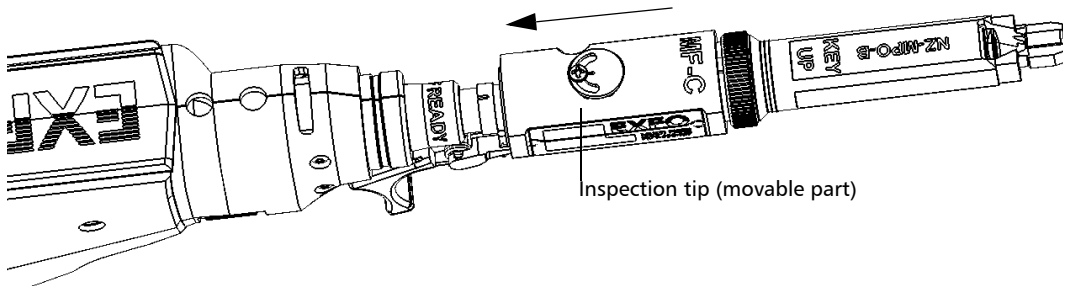

15b. Once you are satisfied with the inspection, tap **Capture**.

OR

Press the Fiber Inspection Probe capture control button.

When the last capture is performed, the analysis starts immediately.

Retesting Fibers of Connectors With Multifiber Ends (Manual-Scanning Tip)

Once you have enabled the batch inspection feature, you can process the results for the fibers you have already tested at any time during the multifiber inspection (see *Enabling the Multifiber Inspection as a Batch (Manual-Scanning Tip)* on page 63 for details). After the results are displayed, you may want to retest fibers with a fail status, for example.

You can also retest a fiber when the batch inspection feature is disabled.

Inspecting Fiber Ends

Retesting Fibers of Connectors With Multifiber Ends (Manual-Scanning Tip)

To retest a fiber:

1. Ensure that the application is in live video mode.
2. Set the probe to **Low Magnification** and locate the fiber you want to test again.

Note: If you are having trouble locating the fiber, you can use the X and Y wheels on the manual-scanning tip.

3. When you have located the desired fiber, set the probe to **High Magnification**.

When the **Process** button is visible, it indicates the batch inspection feature is enabled.

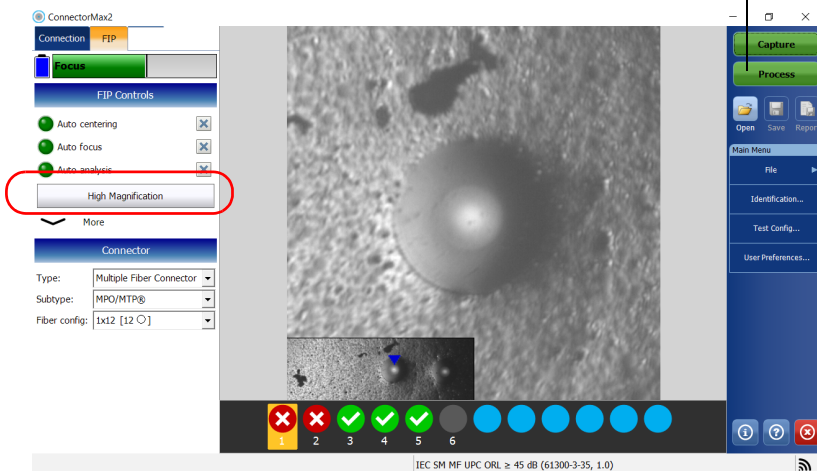

Note: The FIP-415B, FIP-420B/FIP-425B and FIP-430B/FIP-435B probes show a low-magnification connector image in the overlay.

Inspecting Fiber Ends

Retesting Fibers of Connectors With Multifiber Ends (Manual-Scanning Tip)

By looking at the overlay, ensure that the blue arrow is pointing in the middle of the fiber under test (see *Displaying Multifiber Connector Overlay (Manual-Scanning Tip)* on page 64 for details):

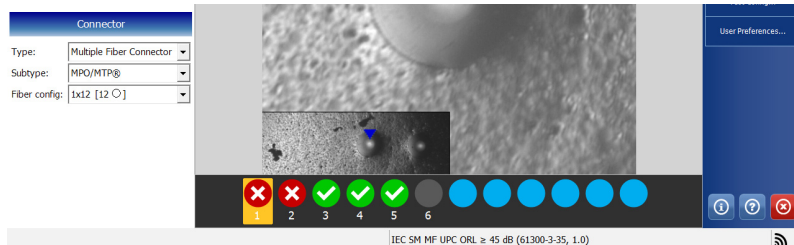

- For multi-row tips, use the Y wheel to select the required fiber row.
- For multi-row and single-row tips, use the X wheel to select the required fiber.



Inspecting Fiber Ends

Retesting Fibers of Connectors With Multifiber Ends (Manual-Scanning Tip)

- If the results on-screen are not optimal, you can do the following:
Hold the magnification control button located on the probe for one second to reactivate the auto focus process (FIP-415B, FIP-430B and FIP-435B only).

OR

- Adjust focus manually.

- Select the fiber you want to test again.

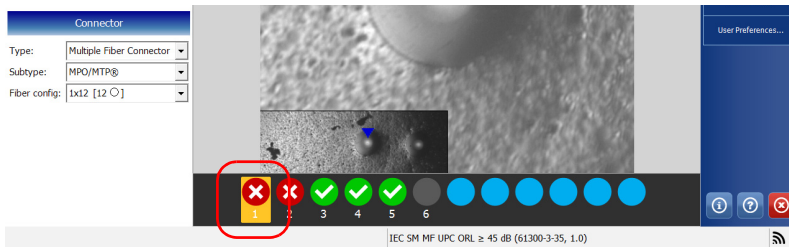

Note: The fiber you see in the overlay must match the fiber you select.

- While in high-magnification level, tap **Capture**.

OR

Press the Fiber Inspection Probe capture control button.

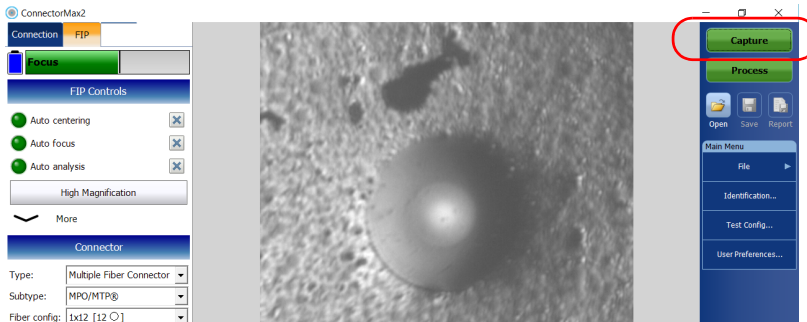

Saving Files

You can save the acquisition files manually for future reference.

You can also set ConnectorMax2 so that it saves the capture automatically only if the result is Pass, only if the result is Fail, or regardless of the status.

Note: *Saving a file automatically after a capture is not possible in multifiber mode when the manual-scanning tip is used. You cannot save a file manually or automatically after performing the first and second captures with the 3-step inspection tip either.*

Note: *When you return to the live video mode, your file name structure will be automatically incremented or decremented so that you do not overwrite your work.*

To save files automatically:

1. From the Main Menu, tap **User Preferences**.

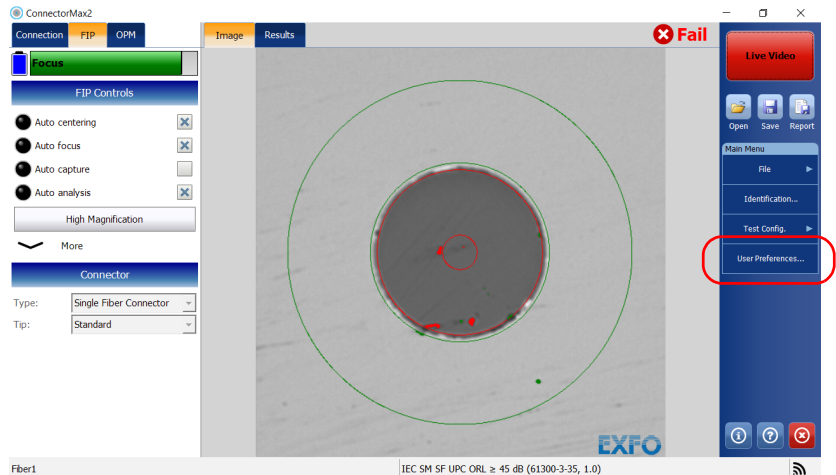

Inspecting Fiber Ends

Saving Files

2. Select the **General** tab.

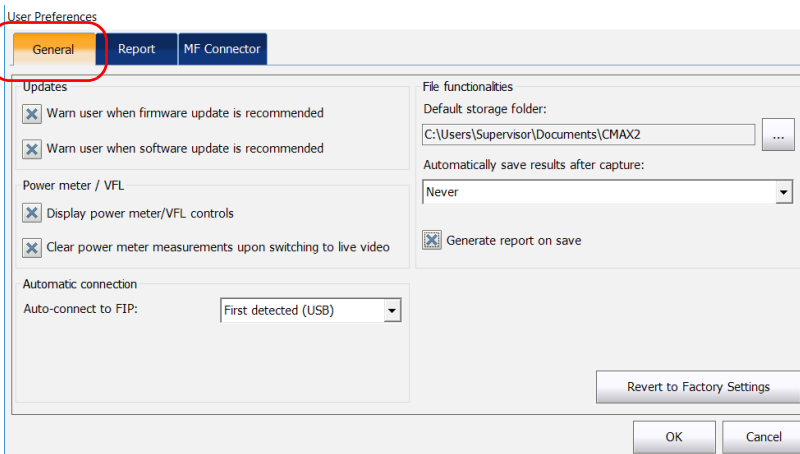

3. In the list of available choices, select the option that better suit your needs.

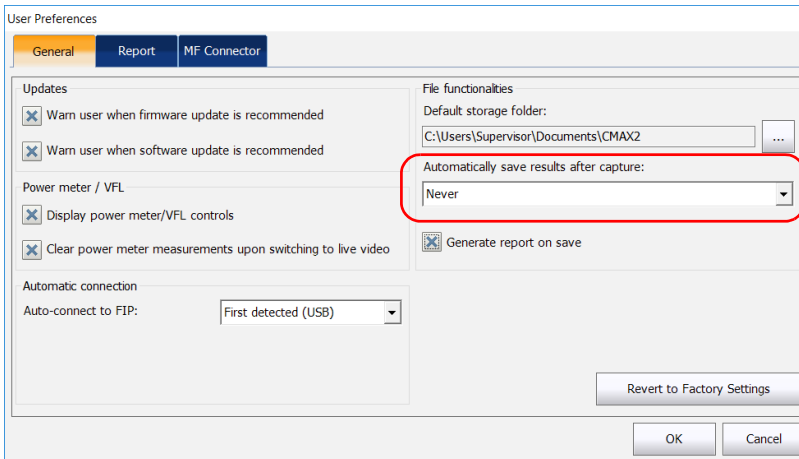

4. Tap **OK** to confirm your choice.

To save files manually:

From the main window, tap the  button.

OR

From the **Main Menu**, tap **File**, then **Save**.

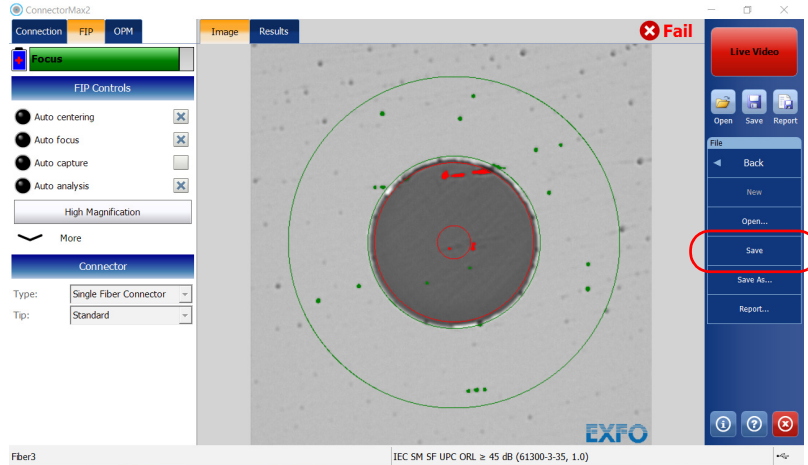

Inspecting Fiber Ends

Saving Files

To save files under a different name or location:

1. From the **Main Menu**, tap **File**, then **Save As**.

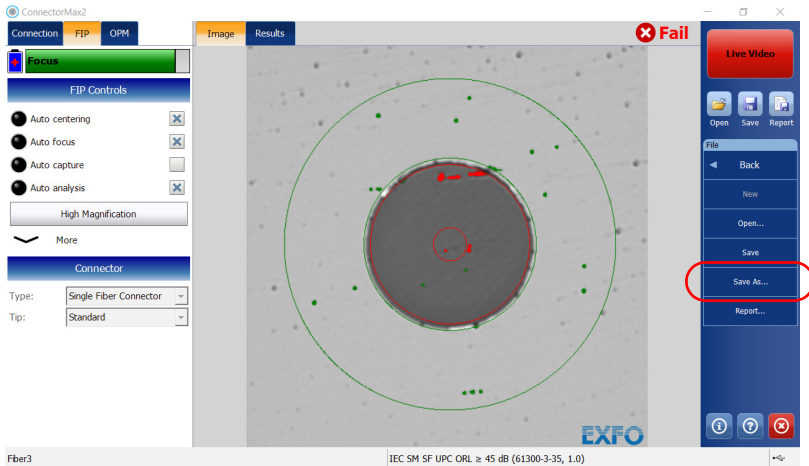

2. Select the location where you will store your file as needed.
3. Change the name of the file as needed.
4. Tap **Save**.

Note: *If you change the location for saving the files, this location will remain as the default location for the remainder of the work session, or until you change the location again.*

Opening Files

You can open captured files directly from the application to view them.

You can either open current .cmax2 files, .cmax files (not supported by MAX-700B and MAX-FIP), or a legacy image file taken from a previous fiber inspection.

The .cmax files, when saved with the ConnectorMax2 application, are compatible with any EXFO applications. However, the .cmax2 files can be opened with the ConnectorMax2 application only.

Note: The accepted image formats for legacy files are .bmp, .jpg and .gif.

Note: Sample files are available on the platform.

To open a file:

1. From the main window, tap the  button.

OR

From the **Main Menu**, tap **File**, then **Open**.

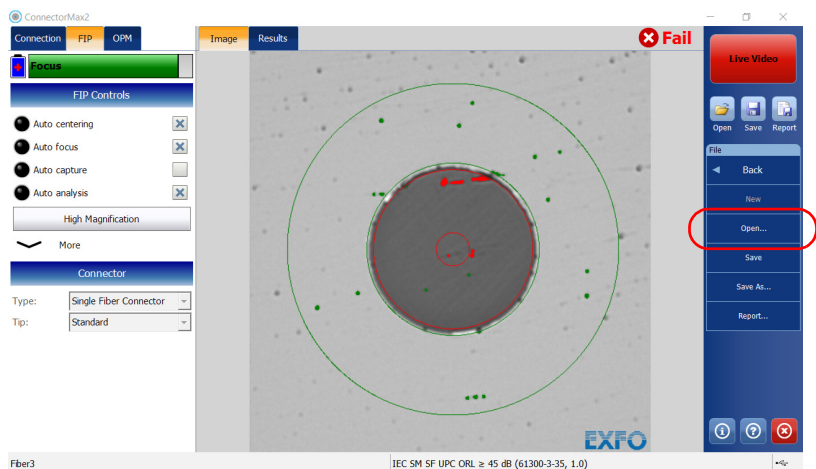

2. Select the desired file and tap **Open**.

Analyzing Captures

With the capture analysis option (FIP-420B/FIP-425B and FIP-430B/FIP-435B), you can perform automated pass/fail analyses according to the criteria you have set.

Note: *Analysis is not available for the FIP-410B.*

Note: *If you have an FIP-415B, you can activate the auto analysis option if you have purchased it from EXFO. However, you cannot activate this option from a computer. You must activate it using a smart device. Once activated, the auto analysis option will also be available when you use the FIP-415B with a computer.*

Depending on the probe that you have, you may have access to the following features:

- **Auto centering:** displays the fiber in the middle of the image. It is compatible with connector and fibers with a cladding of 125 μm . The auto centering is enabled only in high magnification. Working with this feature can be useful with standard connectors. When inspecting special connectors, it is also possible to uncheck the auto centering check box.

Note: *The auto centering feature is not available for FIP-415B, FIP-425B and FIP-435B MF-Ready probes when testing multifiber connectors.*

- **Auto focus:** focuses on the connector image. It is enabled if the auto centering is activated and only in high magnification. The auto focus is only possible in live video mode, and if the focus is not done manually. It starts automatically when you insert an optical fiber connector. For more information, see the *Fiber Inspection Probe Tip Compatibility Chart* on page 159.

Note: *The auto focus feature is not available for FIP-425B MF-Ready probes when testing multifiber connectors.*

- Auto capture: is possible with an acceptable focus level. It is enabled if the auto centering and auto focus are activated. The auto capture is possible only in high magnification.

Note: *The auto capture feature is not available for FIP-430B probes testing multifiber connectors with the manual-scanning tip. It is not available either for FIP-415B, FIP-425B and FIP-435B MF-Ready probes when testing multifiber connectors with the 3-step inspection tip.*

- Auto analysis: displays 4 inspection zones: core, cladding, adhesive, and contact. It is enabled only in high magnification and with a good focus. When testing multifiber connectors with the manual-scanning tip (FIP-430B probes only), the auto analysis is available for zone A and B only.

Inspecting Fiber Ends

Analyzing Captures

An indicator is located at the left of the available features. The color of this indicator shows the status of the feature:

Color	Meaning
Grey	The item is not selected
Green	The item is selected and the conditions allow the analysis.
Black	<ul style="list-style-type: none">➤ The item is selected but the conditions do not allow the analysis.➤ The auto focus process was aborted by the user.
Red	<p>The application is in timeout state because it is unable to complete the auto focus process. There are three ways to reapply the auto focus:</p> <ul style="list-style-type: none">➤ Clear the auto focus check box and select it again➤ Press the FIP-400B Series magnification button for 1 second➤ From capture mode, return to live video mode

To enable or disable the analysis features:

Select the check boxes corresponding to the features that you want to use for the captures. Clear the check boxes to disable the features that you no longer want to use.

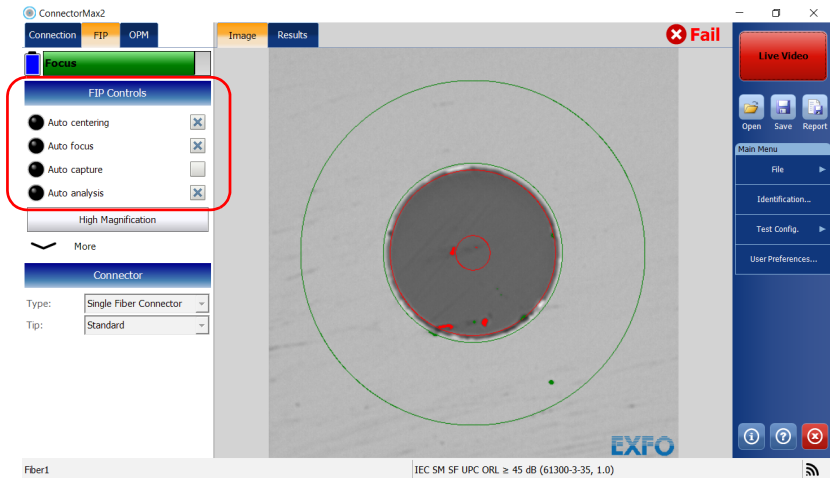

Inspecting Fiber Ends

Analyzing Captures

The results are available as an image or in a detailed table.

- The **Image** tab shows the snapshot of what has been captured. You can see all the anomalies that have been detected.

Note: As soon as a capture is performed, the **Image** tab is displayed by default.

Single fiber and transceivers

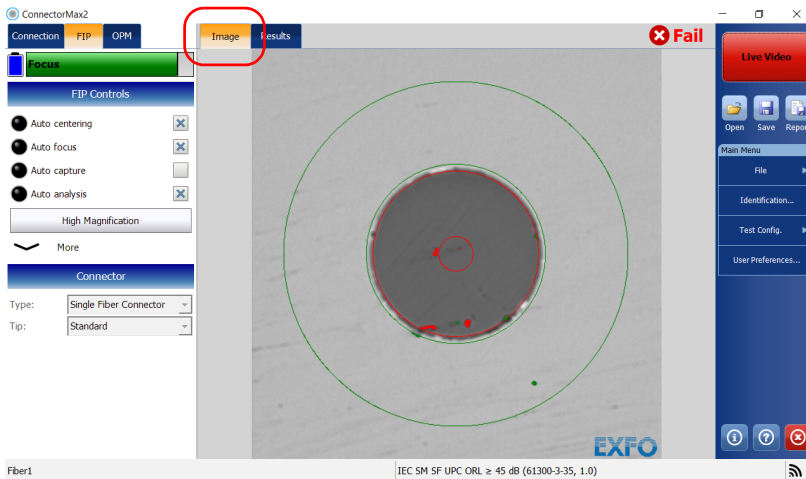

Single-row multifiber connector

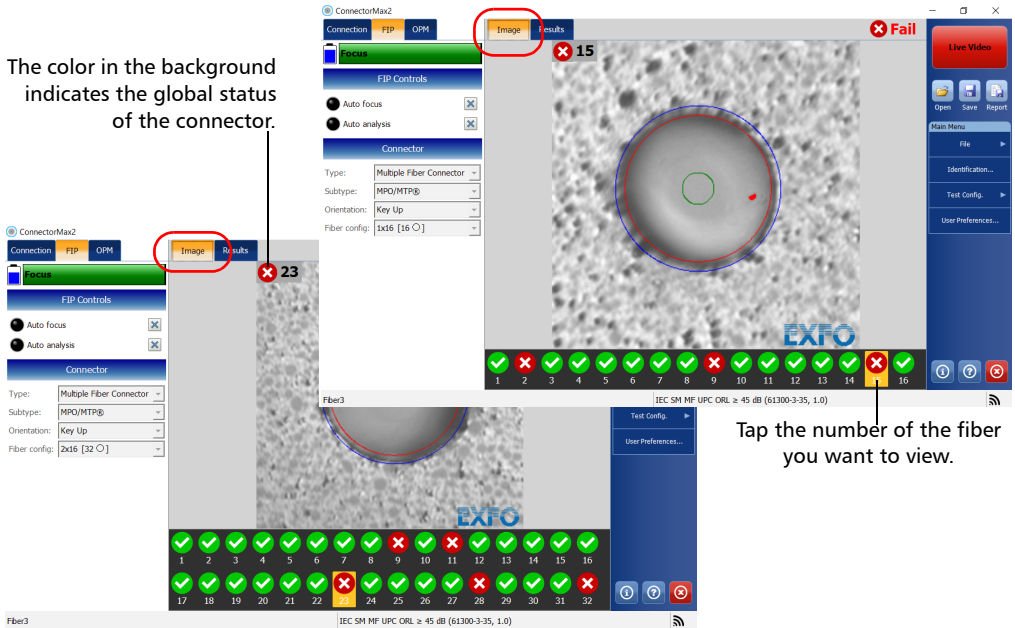

Dual-row multifiber connector

- The overlay shows the status of the analysis, the status per zone, the analysis zones, any anomaly (defects, scratches) found on the fiber endface. The color of the circles shows the status of the analysis zone:
 - Green: pass
 - Blue: no analysis was performed or the function is disabled
 - Red: fail

Note: You can change the diameter of the analysis zones. For more information, see *Managing and Selecting Test Configurations on page 45*.

By default, the overlay is shown after an analysis, but you can hide it by tapping the image on screen.

Inspecting Fiber Ends

Analyzing Captures

- The **Results** tab shows detailed information for scratches and defects detected in each test zone and the corresponding test status.

Note: When there is no analysis, the **Results** tab does not appear.

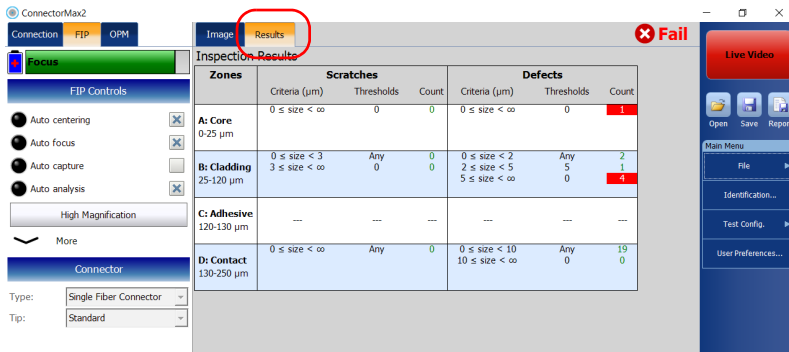

To view the results (single fiber or transceiver):

Select the **Results** tab.

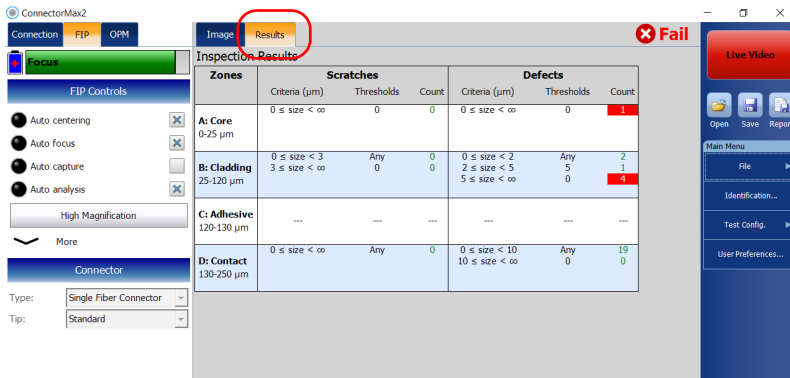

To view the results (manual-scanning tip or 3-step inspection tip):

When you have reached the end of the connector (manual-scanning tip) or you have performed the three captures (3-step inspection tip), select the **Results** tab.

Single-row multifiber connector

The screenshot shows the ConnectorMax2 software interface. The 'Results' tab is selected, displaying the following data:

Zones	Criteria (µm)	Scratches	Thresholds	Count	Defects	Thresholds	Count
A: Core 0-25 µm	0 ≤ size < ∞			0	0 ≤ size < ∞	0	0
B: Cladding 25-115 µm	0 ≤ size < 3 3 ≤ size < ∞	Any	0	0	0 ≤ size < 2 2 ≤ size < 5 5 ≤ size < ∞	Any 5 0	0 1 0
C: Adhesive 115-130 µm	---	---	---	---	---	---	---

Below the table, the 'Test Configuration' section shows:

Test Configuration	Connector	Cladding
IEC SM MF UPC ORL ≥ 45 dB (61300-3-35, 1.0)	MF	125 µm

The fiber status bar shows 16 fibers, with fiber 14 marked as 'Fail' (red X) and fiber 23 marked as 'Pass' (green checkmark).

Tap the number of the fiber you want to view.

Dual-row multifiber connector

Inspecting Fiber Ends

Displaying or Hiding the Power Meter and VFL Controls

Displaying or Hiding the Power Meter and VFL Controls

When the unit you are using is equipped with an optical power meter you can view all controls related to the power meter and VFL. The controls are displayed by default.

Note: *This feature is not available on computers and on units not equipped with a power meter.*

To display or hide the power meter and VFL controls:

1. From the **Main Menu**, tap **User Preferences**.
2. Select the **General** tab.
3. Under **Power meter/VFL**, select **Display power meter/VFL controls**.

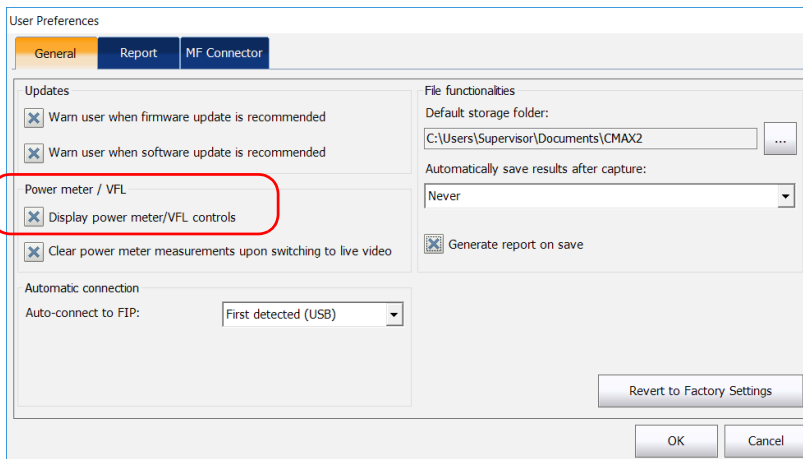

4. Tap **OK** to confirm your choice and close the window.

Clearing Power Meter Measurements Automatically

Measurements can be automatically erased from memory upon returning to live video mode.

Note: *This feature is not available on computers and on units not equipped with a power meter.*

To clear power meter measurements automatically:

1. From the **Main Menu**, tap **User Preferences**.
2. Select the **General** tab.
3. Under **Power meter/VFL**, select **Clear power meter measurements upon switching to live video**.

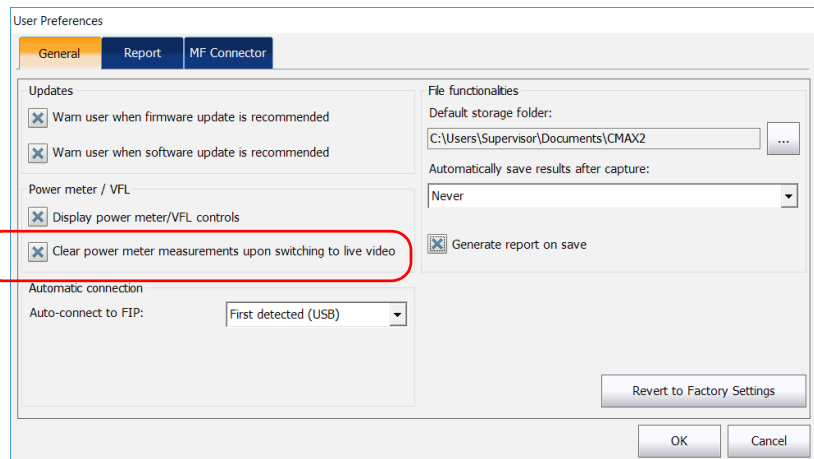

4. Tap **OK** to confirm your choice and close the window.

Inspecting Fiber Ends

Measuring Power or Insertion Loss

Measuring Power or Insertion Loss

If your unit is equipped with a power meter, ConnectorMax2 provides power meter measurements. The power meter view displays current power and loss measurements. This view is available either in live video mode or capture mode.

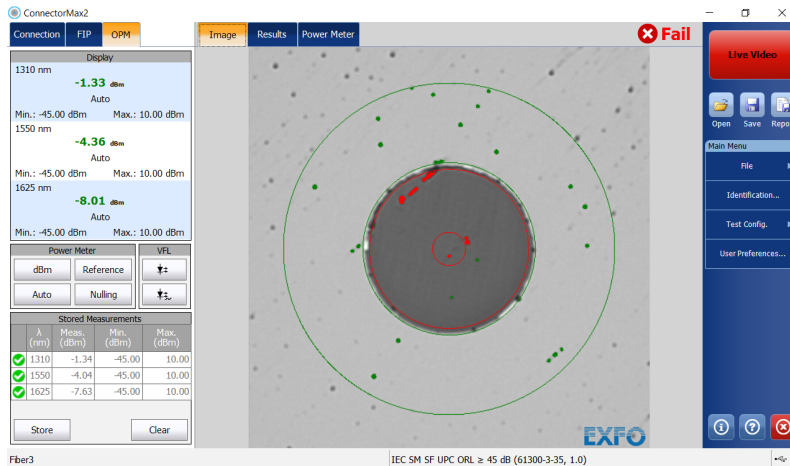

For the MAX-700B platform, you can either perform measurements manually and select each wavelength yourself, or you can use the auto-wavelength and auto-switching modes of your source.

Note: When there is a selected wavelength and the source is in Auto mode, the power meter switches automatically to Auto mode.

The correction factors and the offset nulling are not supported by ConnectorMax2. For more information on your power meter, refer to the corresponding user guide.

Viewing Power Meter Results

You can view the power meter results stored in memory as well as the current measurement. The global pass/fail status also takes the power meter measurements into account.

To view power or insertion loss measurements:

Select the **Power Meter** tab. All your measurements are displayed in the order they were performed.

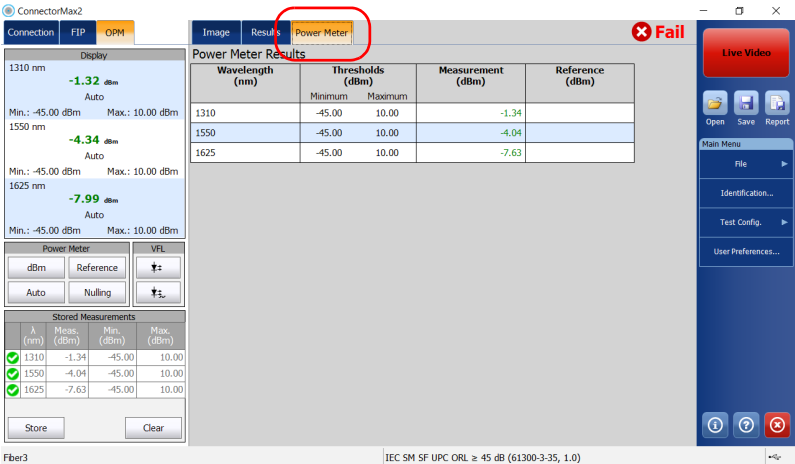

Inspecting Fiber Ends

Identifying Fiber Faults Visually with the VFL

Identifying Fiber Faults Visually with the VFL

Your unit can be equipped with an optional visual fault locator (VFL) to help you identify bends, faulty connectors, splices and other causes of signal loss. It can also help the person at the other end of the link to identify the fiber under test, which could be particularly useful when working with cables containing many fibers.

From its dedicated port, the VFL emits a red signal which becomes visible at the location of a fault on the fiber. This signal can be continuous (CW) or blinking (1 Hz).

The VFL is available either in live video mode or capture mode. It can be switched from one state to another (on, off or blink).



WARNING

When the VFL is active, the VFL port emits visible laser radiation. Avoid exposure and do not stare directly into the beam. Protect any unused port with a cap.

The screenshot shows the ConnectorMax2 software interface. On the left, there is a 'Display' section with three rows of data for 1310 nm, 1550 nm, and 1625 nm. The 1310 nm row shows a value of -1.33 dBm. The 1550 nm row shows a value of -4.36 dBm. The 1625 nm row shows a value of -8.01 dBm. Below this is a 'Power Meter' section with buttons for 'dBm', 'Reference', 'Auto', and 'Nulling'. A red box highlights the 'VFL' section, which contains a 'VFL' label and a red circle with a white cross. The main area shows a fiber inspection image with a red laser spot and a 'Fail' indicator. The bottom of the interface shows a table of 'Stored Measurements'.

λ (nm)	Meas. (dBm)	Min. (dBm)	Max. (dBm)
1310	-1.34	-45.00	10.00
1550	-4.04	-45.00	10.00
1625	-7.63	-45.00	10.00

For more information on your VFL, refer to the corresponding user guide.

Creating Reports

You can create a report based on the current inspection and analysis results by customizing it with various items, then save it in different formats. You can set the application to generate a report automatically after a capture is made and send it in a folder you have determined, or you can generate the reports manually.



IMPORTANT

Your application has been designed for optimal viewing of the fonts shown in reports in all supported languages. Ensure that the language settings for Non-Unicode applications remains to English (United States).

To customize reports:

1. From the **Main Menu**, tap **User Preferences**.
2. Select the **Report** tab.
3. Select the desired file type.

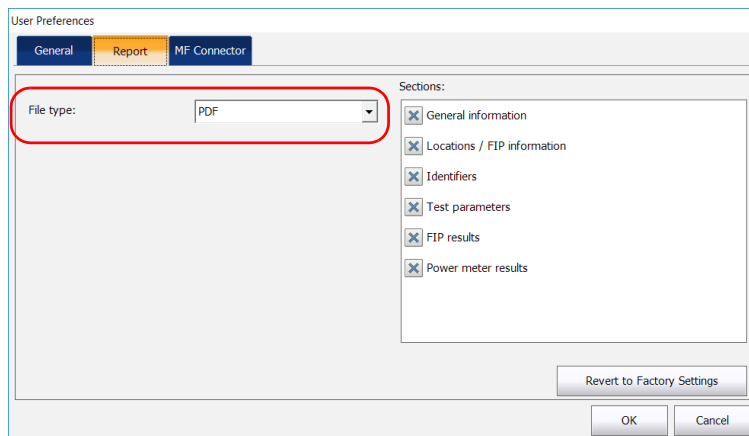

Inspecting Fiber Ends

Creating Reports

4. Select the items you want to include in the reports.

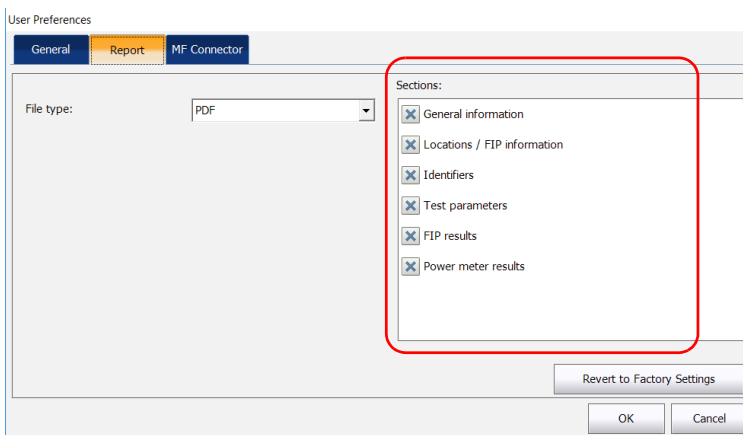

5. Tap **OK** to confirm your choice and close the window.

To activate automated report creation:

- 1.** From the **Main Menu**, tap **User Preferences**.
- 2.** Select the **General** tab.
- 3.** Under **File functionalities**, select **Generate report on save**.

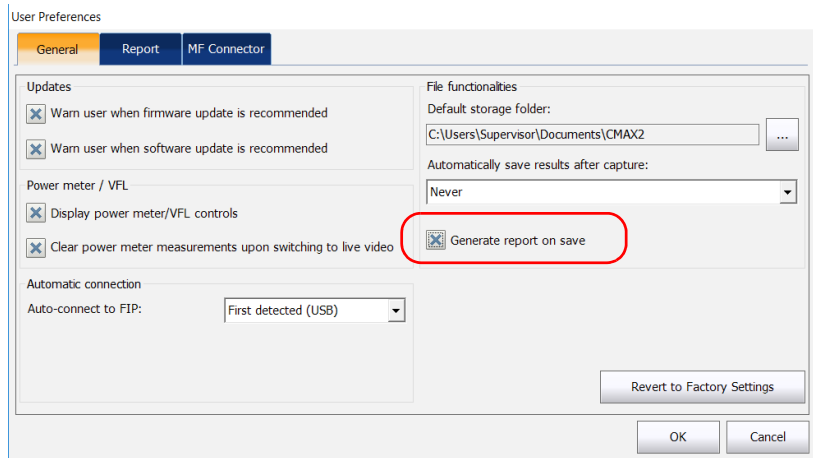

- 4.** Tap **OK** to confirm your choice and close the window.

Inspecting Fiber Ends

Creating Reports

To create a report manually:

1. From the main window, tap the  button.

OR

From the **Main Menu**, tap **File**, then **Report**.

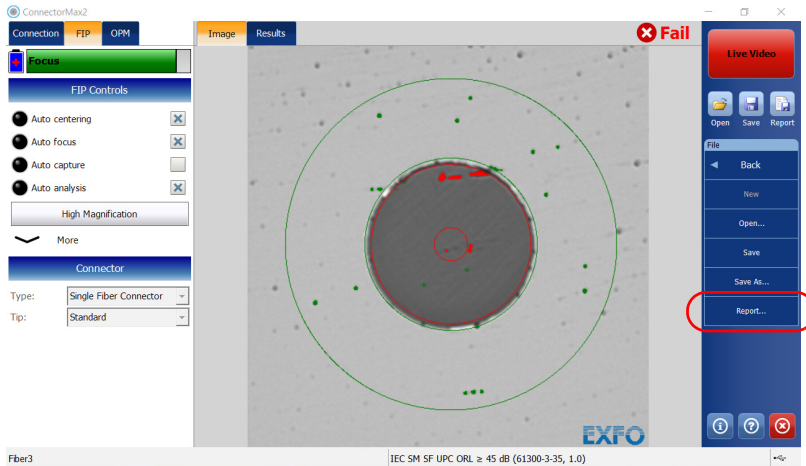

2. From the **Save As** dialog box, select a folder or create one to save your file.
3. If desired, modify the file name and the file type.
4. Tap **Save** to save the report.

Updating the Firmware and Software

The FIP-400B Series is designed to provide automatic software update notifications and firmware updates whenever necessary. This allows you to benefit from the updates of your unit each time you use it. The firmware and software updates can be recommended or required.

To notify you, a message box appears each time a firmware or software update is recommended.

When a firmware update is required, the application shows an error if you choose not to update the FIP-400B Series. If a firmware update fails, ConnectorMax2 performs a fault recovery procedure the next time the FIP-400B Series is connected.

The FIP-400B Series becomes unavailable if a software update is required or when a firmware update is in progress. The live video button becomes disabled in capture view and in video view. The capture button becomes disabled as well.



CAUTION

Do not disconnect the probe or turn off the unit when an update is in progress.

Once an update is started, follow the indications to complete the process.



IMPORTANT

During the automatic upgrade of the firmware of your FIP-400B Series probe, you may be prompted to install USB drivers for your instrument. In that case, you need to map your fiber inspection probe with the necessary driver.

Inspecting Fiber Ends

Updating the Firmware and Software

To be notified of the firmware or software updates automatically:

1. From the **Main Menu**, tap **User Preferences**.
2. Select the **General** tab.
3. Under **Updates**, select the appropriate option.

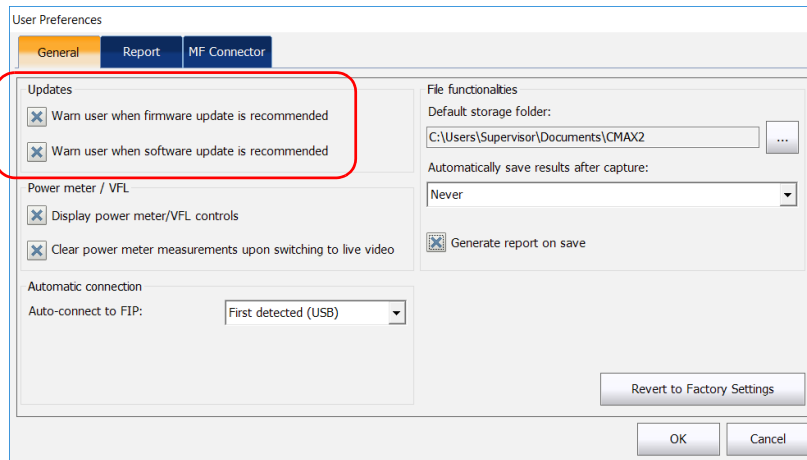

Note: By default, both check boxes are selected.

4. Tap **OK** to confirm your choice and close the window.

To configure the USB driver for your probe:

1. Confirm the firmware upgrade when ConnectorMax2 prompts you.
2. During the upgrade process, the **Found New Hardware** wizard can be displayed. In this case, if the application prompts you to connect to Windows Update to search for software, select **No, not this time**, and then click **Next**.

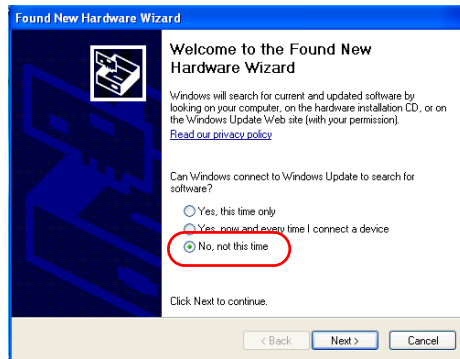

3. Make sure that the **Install the software automatically (Recommended)** option is selected, and click **Next**.

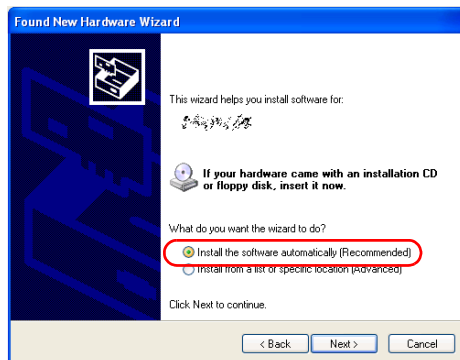

Inspecting Fiber Ends

Updating the Firmware and Software

4. The wizard may display a warning message indicating that the hardware has not passed Windows Logo testing. In this case, since it has been verified that the drivers work with Windows, click **Continue Anyway**.
5. Follow the on-screen instructions, and then click **Finish** when the installation is complete.
6. When the application displays an error message indicating that the FIP firmware update has failed, click **OK** to close the message. The automatic upgrade process will continue normally since the driver has been associated with your fiber inspection probe already.

Note: *If the application continues to display the firmware update error message even after the driver has been associated correctly with your fiber inspection probe, contact technical support.*

5 **Maintenance**

General Maintenance

To help ensure long, trouble-free operation:

- Always inspect fiber-optic connectors before using them and clean them if necessary.
- Keep the unit free of dust.
- Clean the unit casing with a cloth slightly dampened with water.
- Store unit at room temperature in a clean and dry area. Keep the unit out of direct sunlight.
- Avoid high humidity or significant temperature fluctuations.
- Avoid unnecessary shocks and vibrations.
- If any liquids are spilled on or into the unit, turn off the power immediately, disconnect from any external power source, remove the batteries and let the unit dry completely.



WARNING

The use of controls, adjustments and procedures, namely for operation and maintenance, other than those specified herein may result in hazardous radiation exposure or impair the protection provided by this unit.

Battery Safety Recommendations



WARNING

RISK OF EXPLOSION IF BATTERY IS REPLACED BY AN INCORRECT TYPE. DISPOSE OF USED BATTERIES ACCORDING TO THE MANUFACTURER'S INSTRUCTIONS.



WARNING

Do not throw batteries into fire or water and do not short-circuit the battery electrical contacts. Do not disassemble.



IMPORTANT

Recycle or dispose of used batteries properly, in accordance with local regulations. Do not dispose of them in ordinary garbage receptacles. For more information, see the section about recycling and disposal in this user documentation.

Cleaning MPO-Type Connectors

MPO-type connectors are fixed on your unit and can be cleaned using a multifiber mechanical cleaner.



WARNING

Never look directly into a live fiber. It could cause serious eye damage. Always use your FIP-400B Series Fiber Inspection Probe.

To clean an MPO-type connector using a multifiber mechanical cleaner:

1. Insert the cleaning tip into the optical adapter, and push the outer shell into the cleaner.

Note: *The cleaner makes a clicking sound to indicate that the cleaning is done.*

2. Verify connector surface with a Fiber Inspection Probe (for example, EXFO's FIP).

Cleaning Lenses

Lenses are part of the Fiber Inspection Probe. To help you with the cleaning process:

- With a filtered air blower or a soft bristled brush, remove as much dust and dirt as possible.
- Apply a few drops of cleaning solution, which is used to clean camera lenses, on a lens tissue, a cleaning cloth or a cotton swab. The lens cleaning solution especially manufactured by camera lens manufacturers can be used safely. Reagent grade isopropyl alcohol as well as deionized water can also be used safely.
- Gently remove oil, fingerprints and grime from the lens surface, using a circular motion from the center outwards.

Recharging the Battery (FIP-415B/425B/435B Models Only)

The battery in your Fiber Inspection Probe is a Li-ion polymer battery with three-cell format. The charge status is shown with the LEDs on the Fiber Inspection Probe. The application also indicates the charge status.



CAUTION

Only charge the battery with the USB cable and USB power adapter provided by EXFO with your unit.

You can purchase a new battery from EXFO.



IMPORTANT

- The battery is not charged at the factory. You must fully charge it before using the unit for the first time. The battery is fully charged after a few hours or when the battery LED indicator stops flashing (see *Probe LED Indicators* on page 8 for details). The charge cycle starts and stops automatically.
- The time required to charge the battery depends on various factors such as the ambient temperature.
- To ensure that the battery functions or charges properly, keep it within operation and storage temperature range.

The micro-USB power adapter recharges the battery of the probe when it is low. You can recharge the battery with the provided USB cable and the USB power adapter that you connect to a power outlet. You can also use the provided USB cable alone that you connect to a USB port of a computer. It is possible to recharge the battery of the probe when it is connected to the USB port of a computer (500 mA).

When the probe is connected to a power outlet or to a USB port, it still works via Wi-Fi.

Maintenance

Replacing the Battery (FIP-415B/425B/435B Models Only)

Replacing the Battery (FIP-415B/425B/435B Models Only)

Your probe is powered by a Li-ion polymer rechargeable battery.



WARNING

- Your unit uses a three-cell battery that has been especially designed for EXFO. For this reason, you can only replace it with a battery of the same type and model. The use of other batteries may damage your unit and compromise your safety.
- Battery replacement should only be done by a qualified technician with the appropriate tools on an electronic bench or similar environment.



CAUTION

To avoid irremediable damage to the battery, always remove the battery compartment door carefully, ensuring that the battery does not fall.

To replace the battery:

- 1.** Turn off the probe.
- 2.** Disconnect any power cable and fibers.
- 3.** Using a screwdriver, remove the two screws that are located on the side of the probe.

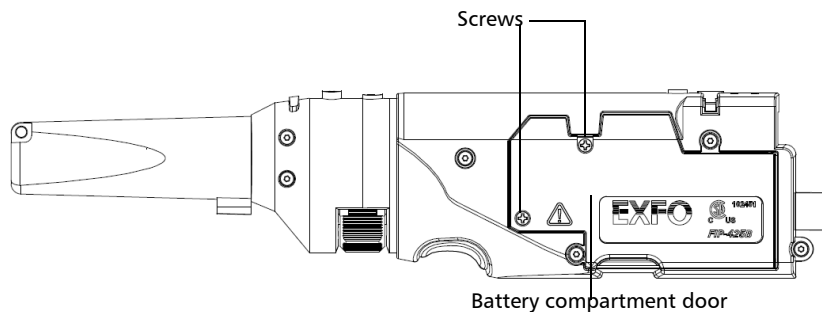

- 4.** Remove the battery compartment door.



CAUTION

Gently pull on the battery to avoid damaging the wires.

Maintenance

Recycling and Disposal

5. Remove the battery.

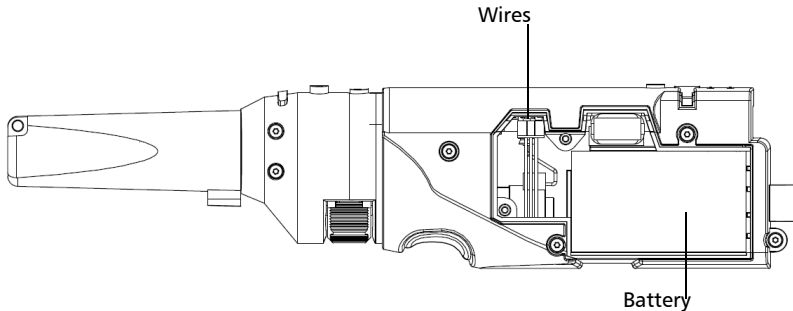

6. Replace the battery, respecting the polarity (black, yellow, and red wires).
7. Close the battery compartment door.
8. Using a screwdriver, put the screws that you have removed at step 3 back in place.

Recycling and Disposal



This symbol on the product means that you should recycle or dispose of your product (including electric and electronic accessories) properly, in accordance with local regulations. Do not dispose of it in ordinary garbage receptacles.

For complete recycling/disposal information, visit the EXFO Web site at www.exfo.com/recycle.

6 Troubleshooting

Solving Common Problems

The table below presents common problems and their solutions.

Problem	Solution
I cannot analyze an image	<ul style="list-style-type: none">➤ The image is not focused properly; use the focus knob on the probe until the focus indicator displays the best value available. Yellow indicates an acceptable range, and green shows the preferred range.➤ Ensure that the connector is aligned properly. When testing a multifiber connector with an MF-Ready probe, ensure that the key of the nozzle is properly aligned with the notch of the inspection tip (see <i>Changing the FIP Nozzle (MF-Ready Probes Only)</i> on page 29 for details).➤ Ensure that the focus value is sufficient to perform the analysis.➤ Ensure that you are using a high magnitude level.
I cannot see the fiber on-screen	<ul style="list-style-type: none">➤ Connect the probe to the USB port of the unit.➤ Verify the probe connection status to see if ConnectorMax2 is detecting the probe properly. If the probe is connected properly, close ConnectorMax2 and open it again.➤ Ensure that the Wi-Fi is on.➤ Ensure that the probe is on.
The FIP internal temperature is too high	Let the FIP cool down.
The FIP has encountered a critical internal error	Contact EXFO for technical support.

Troubleshooting

Solving Common Problems

Problem	Solution
The auto centering does not function properly	<ul style="list-style-type: none">➤ Clean the connector.➤ Adjust the image focus.➤ When working with the manual-scanning tip, ensure that the appropriate connector between MPO/MTP or OptiTip is selected.
The analysis was interrupted before it was completed FIP_ERROR_CODE_101	<ul style="list-style-type: none">➤ Ensure that the live video mode is selected.➤ Adjust the image settings.
A connection error occurred	<ul style="list-style-type: none">➤ Ensure that the probe is not currently in use by another application.➤ On a MAX-700B, ensure that the Wi-Fi communication with the probe is not encrypted in the platform settings. For more information on how to define manual configurations, refer to the MaxTester Series user guide. You will find the information in the section about connecting to a wireless network, in the procedure about manual configurations.➤ On a MAX-700B, ensure that the connection with the probe was made as explained in <i>Connecting or Disconnecting the Wireless Probe</i> on page 23, and not through the Wi-Fi connection of the platform.➤ The probe may be outside of the working range.➤ Try to connect to the probe again.
An APC fiber is connected to an FIP-415B, FIP-430B or FIP-435B probe, the blue LED is blinking and the motor is not running	Try to put the fiber back in place.

Problem	Solution
Refresh rate is very low	<ul style="list-style-type: none"> ➤ Ensure that the CPU throttling is not in degrade mode. ➤ Choose another power scheme which is not Max Battery. For more information about power scheme, refer to the power management options section in your platform user guide. ➤ Reduce the number of probes operating in the vicinity.
The FIP status LED blinks red for 2 seconds in live video mode and turns from unlit to blue (auto focus timeout)	Try to put the fiber back in place.
The FIP status LED blinks red for 2 seconds when a capture is performed and no analysis results are available	There was an analysis error. Repeat the inspection process.
On a computer, in live video mode, the probe no longer works when it loses its focus	Tap anywhere in the application window to bring it back to the front.
The firmware update fails when the driver installation process is too long.	Disconnect the probe and try to connect it again.
On a Dell computer, the same image is displayed twice, one on top of the other, when the Dell Webcam Central software is installed and the Show Original Video option is enabled.	Ensure that the Show Original Video option is disabled.

Troubleshooting

Solving Common Problems

Problem	Solution
An error message regarding the initialization of the application may appear when starting the ConnectorMax2 application.	You must install .NET Framework 3.5 SP1 or higher on your unit.
The list of available FIPs is empty.	<ul style="list-style-type: none">➤ Ensure that the Wi-Fi is on.➤ Ensure that the probe is on.
A probe is no longer listed among the list of available FIPs for connection.	<ul style="list-style-type: none">➤ Wait a few minutes for the probe to appear in the list of available FIPs.➤ Connect the Wi-Fi probe with a USB cable.➤ Restart the platform.
The status LED blinks magenta at startup.	The probe is in standalone mode. From ConnectorMax2, connect to the probe to return to standard mode.

Changing the File Contents (3-Step Inspections Only)

When inspecting multifiber connectors, the application allows you to choose between two different file formats upon saving your files. Each format is used for different purposes.

- enhanced format: used to troubleshoot problems. This format should only be selected when recommended by technical support, as it increases significantly the file size.
- normal format: selected by default.

To change the file contents:

1. From the **Main Menu**, tap **User Preferences**.
2. Select the **MF Connector** tab.
3. Under **3-step inspection**, select the file format you want to use.

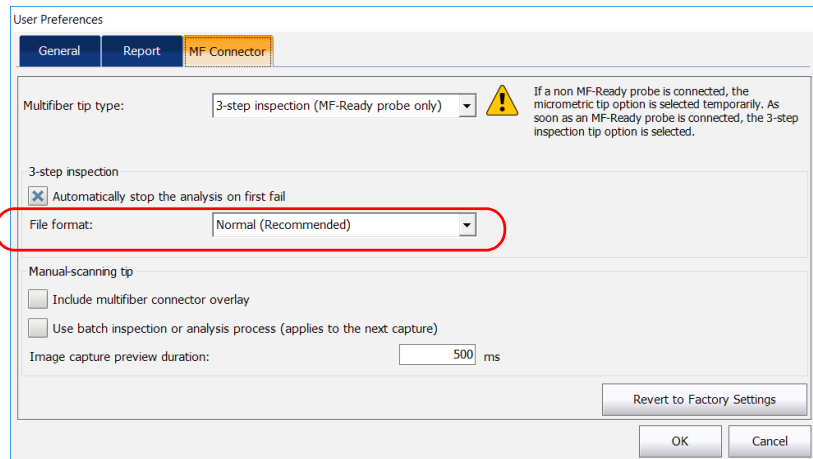

4. Tap **OK** to close the window.

Troubleshooting

Contacting the Technical Support Group

Contacting the Technical Support Group

To obtain after-sales service or technical support for this product, contact EXFO at one of the following numbers. The Technical Support Group is available to take your calls from Monday to Friday, 8:00 a.m. to 7:00 p.m. (Eastern Time in North America).

Technical Support Group

400 Godin Avenue
Quebec (Quebec) G1M 2K2
CANADA

1 866 683-0155 (USA and Canada)
Tel.: 1 418 683-5498
Fax: 1 418 683-9224
support@exfo.com

For detailed information about technical support, and for a list of other worldwide locations, visit the EXFO Web site at www.exfo.com.

If you have comments or suggestions about this user documentation, you can send them to customer.feedback.manual@exfo.com.

To accelerate the process, please have information such as the name and the serial number (see the product identification label), as well as a description of your problem, close at hand.

Viewing Information About ConnectorMax2

You can view information about ConnectorMax2 such as the version number and contact information for technical support on your platform.

To view ConnectorMax2 information:

From the main window, tap .

Viewing Online Help

You can view the online help for ConnectorMax2 at any time.

To view the online help:

From the main window, tap .

Transportation

Maintain a temperature range within specifications when transporting the unit. Transportation damage can occur from improper handling. The following steps are recommended to minimize the possibility of damage:

- Pack the unit in its original packing material when shipping.
- Avoid high humidity or large temperature fluctuations.
- Keep the unit out of direct sunlight.
- Avoid unnecessary shocks and vibrations.

7 **Warranty**

General Information

EXFO Inc. (EXFO) warrants this equipment against defects in material and workmanship for a period of one year from the date of original shipment. EXFO also warrants that this equipment will meet applicable specifications under normal use.

During the warranty period, EXFO will, at its discretion, repair, replace, or issue credit for any defective product, as well as verify and adjust the product free of charge should the equipment need to be repaired or if the original calibration is erroneous. If the equipment is sent back for verification of calibration during the warranty period and found to meet all published specifications, EXFO will charge standard calibration fees.



IMPORTANT

The warranty can become null and void if:

- **unit has been tampered with, repaired, or worked upon by unauthorized individuals or non-EXFO personnel.**
- **warranty sticker has been removed.**
- **case screws, other than those specified in this guide, have been removed.**
- **case has been opened, other than as explained in this guide.**
- **unit serial number has been altered, erased, or removed.**
- **unit has been misused, neglected, or damaged by accident.**

THIS WARRANTY IS IN LIEU OF ALL OTHER WARRANTIES EXPRESSED, IMPLIED, OR STATUTORY, INCLUDING, BUT NOT LIMITED TO, THE IMPLIED WARRANTIES OF MERCHANTABILITY AND FITNESS FOR A PARTICULAR PURPOSE. IN NO EVENT SHALL EXFO BE LIABLE FOR SPECIAL, INCIDENTAL, OR CONSEQUENTIAL DAMAGES.

Warranty

Liability

Liability

EXFO shall not be liable for damages resulting from the use of the product, nor shall be responsible for any failure in the performance of other items to which the product is connected or the operation of any system of which the product may be a part.

EXFO shall not be liable for damages resulting from improper usage or unauthorized modification of the product, its accompanying accessories and software.

Exclusions

EXFO reserves the right to make changes in the design or construction of any of its products at any time without incurring obligation to make any changes whatsoever on units purchased. Accessories, including but not limited to fuses, pilot lamps, batteries and universal interfaces (EUI) used with EXFO products are not covered by this warranty.

This warranty excludes failure resulting from: improper use or installation, normal wear and tear, accident, abuse, neglect, fire, water, lightning or other acts of nature, causes external to the product or other factors beyond the control of EXFO.



IMPORTANT

In the case of products equipped with optical connectors, EXFO will charge a fee for replacing connectors that were damaged due to misuse or bad cleaning.

Certification

EXFO certifies that this equipment met its published specifications at the time of shipment from the factory.

Service and Repairs

EXFO commits to providing product service and repair for five years following the date of purchase.

To send any equipment for service or repair:

- 1.** Call one of EXFO's authorized service centers (see *EXFO Service Centers Worldwide* on page 158). Support personnel will determine if the equipment requires service, repair, or calibration.
- 2.** If equipment must be returned to EXFO or an authorized service center, support personnel will issue a Return Merchandise Authorization (RMA) number and provide an address for return.
- 3.** If possible, back up your data before sending the unit for repair.
- 4.** Pack the equipment in its original shipping material. Be sure to include a statement or report fully detailing the defect and the conditions under which it was observed.
- 5.** Return the equipment, prepaid, to the address given to you by support personnel. Be sure to write the RMA number on the shipping slip. *EXFO will refuse and return any package that does not bear an RMA number.*

Note: *A test setup fee will apply to any returned unit that, after test, is found to meet the applicable specifications.*

After repair, the equipment will be returned with a repair report. If the equipment is not under warranty, you will be invoiced for the cost appearing on this report. EXFO will pay return-to-customer shipping costs for equipment under warranty. Shipping insurance is at your expense.

Routine recalibration is not included in any of the warranty plans. Since calibrations/verifications are not covered by the basic or extended warranties, you may elect to purchase FlexCare Calibration/Verification Packages for a definite period of time. Contact an authorized service center (see *EXFO Service Centers Worldwide* on page 158).

Warranty

EXFO Service Centers Worldwide

EXFO Service Centers Worldwide

If your product requires servicing, contact your nearest authorized service center.

EXFO Headquarters Service Center

400 Godin Avenue
Quebec (Quebec) G1M 2K2
CANADA

1 866 683-0155 (USA and Canada)
Tel.: 1 418 683-5498
Fax: 1 418 683-9224
support@exfo.com

EXFO Europe Service Center

Winchester House, School Lane
Chandlers Ford, Hampshire S053 4DG
ENGLAND

Tel.: +44 2380 246800
Fax: +44 2380 246801
support.europe@exfo.com

EXFO Telecom Equipment (Shenzhen) Ltd.

3rd Floor, Building C,
FuNing Hi-Tech Industrial Park, No. 71-3,
Xintian Avenue,
Fuhai, Bao'An District,
Shenzhen, China, 518103

Tel: +86 (755) 2955 3100
Fax: +86 (755) 2955 3101
support.asia@exfo.com

To view EXFO's network of partner-operated Certified Service Centers nearest you, please consult EXFO's corporate website for the complete list of service partners:

<http://www.exfo.com/support/services/instrument-services/exfo-service-centers>.

A **Fiber Inspection Probe Tip Compatibility Chart**

With some tips that include lenses, and before performing an automatic focus, you must adjust the focus manually for the first inspection.

Note: *The tips for which the probe requires a manual focus before the first inspection are listed in the table below.*

To reach the focus level manually:

1. Bring the focus manually close to the focal point.
2. Activate the auto focus or press the magnification control button on the probe and hold it down until the auto focus is activated again.

The table below establishes the Fiber Inspection Probe tip compatibility with the different operations: fiber inspection, auto analysis (option), auto focus (option), and auto detection (option) provided with the ConnectorMax2 application.

Note: *You can install the tips described below on FIP-415B, FIP-425B and FIP-435B MF-Ready probes. For more information on the features available for your probe, see Available Probe Models on page 6.*

Tip Description	Tip Code	Inspection (all models)	Analysis (FIP-415B/ FIP-420B/ FIP-425B/ FIP-430B/ FIP-435B)	Auto focus (FIP-415B/ FIP-430B/ FIP-435B)	Connector Auto detection (FIP-415B/ FIP-430B/ FIP-435B)
Uni.2.5mm for PC connector	FIPT-400-U25M	OK	OK	OK	OK
Uni.2.5mm for APC connector	FIPT-400-U25MA	OK	OK	OK	OK
Uni.1.25mm for PC Connector	FIPT-400-U12M	OK	OK	OK	OK

Fiber Inspection Probe Tip Compatibility Chart

Tip Description	Tip Code	Inspection (all models)	Analysis (FIP-415B/ FIP-420B/ FIP-425B/ FIP-430B/ FIP-435B)	Auto focus (FIP-415B/ FIP-430B/ FIP-435B)	Connector Auto detection (FIP-415B/ FIP-430B/ FIP-435B)
Uni.1.25mm for APC connector	FIPT-400-U12MA	OK	OK	OK	OK
FC APC tip for bulkhead adapter	FIPT-400-FC-APC	OK	OK	OK	OK
FC and SC tip for bulkhead adapter	FIPT-400-FC-SC	OK	OK	OK	OK
ST for UPC bulkhead adapter	FIPT-400-ST	OK	OK	OK	OK
E-2000 for PC bulkhead	FIPT-400-E2000	OK	OK	OK	OK ^a
E-2000 for APC bulkhead adapter	FIPT-400-E2000-APC	OK	OK ^a	OK	OK ^a
FIPT-400-FC-SC-A6 bulkhead adapter	FIPT-400-FC-SC-A6	OK	OK	OK	NO
MU for UPC bulkhead adapter	FIPT-400-MU	OK	OK	OK	OK
MU-L for UPC bulkhead adapter	FIPT-400-MU-L	OK	OK	OK	OK
149 mm, Extended MU tip for PC bulkhead adapter	FIPT-400-MU-L-149	OK	OK	OK ^b	NO
ODC 4 Pin Plug (female) Guide tip	FIPT-400-ODC-4PIN-P	OK	OK	OK	OK
ODC Socket (male) tip	FIPT-400-ODC-S	OK	OK	OK	OK

Fiber Inspection Probe Tip Compatibility Chart

Tip Description	Tip Code	Inspection (all models)	Analysis (FIP-415B/ FIP-420B/ FIP-425B/ FIP-430B/ FIP-435B)	Auto focus (FIP-415B/ FIP-430B/ FIP-435B)	Connector Auto detection (FIP-415B/ FIP-430B/ FIP-435B)
ODC Universal Guide tip	FIPT-400-ODC-U	OK	OK	OK	OK
ODC 2 Pin Plug (female) Guide tip	FIPT-400-ODC-2PIN-P	OK	OK	OK	OK
D4 bulkhead adapter	FIPT-400-D4	OK	OK	OK	OK
FIPT-400-U20M2 is for male ferule connector	FIPT-400-U20M2	OK	OK	OK	OK
FIPT-400-Lemo for bulkhead adapter	FIPT-400-Lemo	OK	OK	OK	OK
OptiTap for APC bulkhead adapter	FIPT-400-OTAP-APC	OK	OK	OK	OK
MT/APC type OptiTip and OptiTap multifiber adapter for male and female connectors	FIPT-400-OTAP-MTP-APC	OK	OK	OK	OK
LC for PC bulkhead	FIPT-400-LC	OK	OK	OK	OK
LC for APC bulkhead adapter	FIPT-400-LC-APC	OK	OK	OK	OK
LC for bulkhead adapter 60 Degree Angled	FIPT-400-LC-A6	OK	OK	OK	NO

Fiber Inspection Probe Tip Compatibility Chart

Tip Description	Tip Code	Inspection (all models)	Analysis (FIP-415B/ FIP-420B/ FIP-425B/ FIP-430B/ FIP-435B)	Auto focus (FIP-415B/ FIP-430B/ FIP-435B)	Connector Auto detection (FIP-415B/ FIP-430B/ FIP-435B)
Extended LC tip for PC bulkhead adapter	FIPT-400-LC-L	OK	OK	OK ^b	OK ^a
137 mm, Extended LC tip for PC bulkhead adapter	FIPT-400-LC-L-137	OK	OK	OK ^b	NO
LX5 for UPC bulkhead adapter	FIPT-400-LX.5	OK	OK	OK	OK
LX5 for APC bulkhead adapter	FIPT-400-LX5-APC	OK	NO	OK	OK
MTP/APC Tip for bulkhead adapter - Extended & Improved	FIPT-400-MTPA2	OK	OK	OK	OK
FIPT-400-MTP2 bulkhead adapter	FIPT-400-MTP2	OK	OK	OK	OK
Bulkhead adapter Westover	FIPT-400-ADAPTER	OK	N/A	N/A	N/A
SMA bulkhead adapter	FIPT-400-SMA	OK	NO	OK ^c	OK ^c
SMA male connector	FIPT-400-SMAM	OK	NO	OK ^c	OK ^c
Uni. 1.6 for PC connector	FIPT-400-U16M	OK	NO	OK	OK
MTRJ bulkhead adapter	FIPT-400-MTRJ	OK	NO	NO	NO

Fiber Inspection Probe Tip Compatibility Chart

Tip Description	Tip Code	Inspection (all models)	Analysis (FIP-415B/ FIP-420B/ FIP-425B/ FIP-430B/ FIP-435B)	Auto focus (FIP-415B/ FIP-430B/ FIP-435B)	Connector Auto detection (FIP-415B/ FIP-430B/ FIP-435B)
SC APC for bulkhead	FIPT-400-SC-APC	OK	OK	OK	OK
Extended SC tip for PC bulkhead adapter	FIPT-400-SC-L	OK	OK	OK ^b	OK ^a
149 mm Extended SC tip for PC bulkhead adapter	FIPT-400-SC-L-149	OK	OK	OK ^b	NO
SC for APC bulkhead adapter – extended	FIPT-400-SC-APC-L	OK	OK ^a	OK	OK ^a

- a. Use version B of the tip or higher.
- b. A manual focus is required for the first inspection.
- c. Only with a 125 μm ferrule.

Contact your vendor for additional information regarding the most recent Fiber Inspection Probe tips that are not listed above.

Index

- 3-step inspection tip
 - multifiber inspection..... 35, 101, 103
 - stopping analysis on first fail 66
 - viewing results..... 125

- A**
- about window..... 152
- activating features
 - auto analysis..... 76, 85, 96, 106
 - auto capture 76, 85, 96
 - auto centering 76, 85, 96
 - auto focus 76, 85, 96, 106
 - automated report creation 133
- adhesive, inspection zone 119
- adjusting brightness..... 36, 37
- after-sales service 152
- analysis
 - disabling features 121
 - enabling features..... 121
 - mode 49
 - of captures 118
 - status..... 11, 123
 - stopped on first fail 66
 - zones 123
- antireflective coating..... 50
- auto
 - analysis 76, 85, 96, 106, 119
 - capture 76, 85, 96, 119
 - centering 76, 85, 96, 118
 - focus..... 76, 85, 96, 106, 118
- auto mode, power meter 128
- automated report creation..... 133
- automatic connection 26, 27
- autonaming
 - configuration..... 40
 - feature..... 38
 - preview..... 38, 41

- available
 - features..... 6
 - models..... 6

- B**
- batch inspection feature..... 63, 79, 80, 109
- battery
 - compartment door, probe 3, 4, 5, 145
 - LED indicator, probe 3, 4, 5, 9, 10, 143
 - recharging, probe 5, 143
 - replacement, probe..... 144, 145
 - safety information 140
- brightness..... 36, 37
- button
 - capture, in application 11, 12, 88, 99
107, 108, 109, 112
 - capture, on probe 2, 3, 4
 - description 11
 - live video..... 11
 - magnification control .. 2, 3, 4, 88, 99, 112
 - process..... 89

- C**
- capture
 - analyzing 118
 - autonaming 38
 - button, in application 11, 12, 88, 99
107, 108, 109, 112
 - button, on probe 2, 3, 4
 - changing fiber information..... 70
 - mode 71, 77
 - with 3-step inspection tip 107, 108, 109
- caution
 - of personal hazard 13
 - of product hazard 13
- changing
 - default folder 62
 - default name 38

Index

fiber information, existing captures.....	70
file contents.....	151
nozzle.....	29, 32
tips.....	28
charge status.....	5, 143
choosing	
automatic connection.....	26, 27
connector subtype.....	82, 93, 103
connector tip.....	74
multifiber connector.....	82, 93, 101
multifiber tip.....	35, 81, 92, 103
single fiber connector.....	73
test configuration.....	45, 75, 84, 95, 105
transceiver connector.....	73
cladding	
diameter.....	50
inspection zone.....	119
cleaning	
lenses.....	142
MPO connectors.....	141
clearing	
power meter measurements.....	127
values.....	44
configuration of fibers.....	104
configuring	
file name.....	40
name of configuration.....	49
test.....	45
USB driver.....	137
connecting the probe.....	23, 24
connection, lost.....	23
connector	
3-step inspection tip.....	77, 103
global status.....	11, 123
key orientation.....	104
manual-scanning tip.....	77, 81, 92
multifiber.....	82, 93
single fiber.....	73
subtype.....	82, 93, 103
transceiver.....	73
ConnectorMax2, introduction.....	11
contact, inspection zone.....	119
conventions, safety.....	13
core, inspection zone.....	119
creating	
report, automatically.....	133
report, manually.....	134
test configurations.....	47
custom configurations	
creating.....	45, 47
deleting.....	54
duplicating.....	48
editing.....	52
exporting.....	59
importing.....	57
customer service.....	157
customizing	
antireflective coating.....	50
cladding diameter.....	50
inspection zones thresholds.....	51
reports.....	131
test configuration name.....	49
zone diameters.....	50
D	
dark fiber.....	104
decrementing file name.....	38, 113
default	
file folder.....	62
settings.....	69
defects found on fiber endface.....	123
deleting test configurations.....	54
digital watermark.....	71, 77
disabling analysis features.....	121
disconnecting the probe.....	23, 25
displaying	
multifiber connector overlay.....	64
power meter controls.....	126
VFL controls.....	126
documentation, user.....	152
duplicating test configurations.....	48

- E**
- editing
 - power meter test configurations 67
 - test configurations 52
 - electrical safety information 18
 - enabling
 - analysis features 121
 - multifiber inspection as a batch..... 63
 - equipment ratings..... 20, 21
 - equipment returns 157
 - erasing values..... 44
 - existing captures, changing
 - fiber information..... 70
 - exporting test configurations 59
- F**
- factory settings 69
 - fail status detected on fiber 66
 - feature
 - automatic connection..... 26, 27
 - disabling..... 121
 - enabling 121
 - file contents..... 151
 - status with color..... 120
 - fiber
 - changing existing information..... 70
 - configuration in connector..... 104
 - dark 104
 - endface..... 123
 - identifying faults 130
 - retesting 109
 - type 49
 - file name
 - configuration..... 40
 - preview..... 38, 41
 - files
 - legacy 117
 - modifying contents..... 151
 - name decrementing..... 38, 113
 - name incrementing 38, 113
 - naming 38
 - opening 117
 - saving automatically 113
 - saving manually 113, 115
 - firmware update..... 135, 136, 149
 - first capture with 3-step inspection tip..... 107
 - focus
 - indicator 11, 12, 72, 78, 147
 - knob 3, 4, 147
 - level 119, 159
 - peak..... 72, 78
 - frequency, Wi-Fi vii
- G**
- generating report
 - automatically 133
 - manually 134
 - global status
 - displayed in the application 11
 - of the connector 123
 - green indicator, focus..... 72, 78, 147
- H**
- help 152
 - hiding
 - overlay 123
 - power meter controls 126
 - VFL controls 126
- I**
- identification label..... 152
 - identifying fiber faults 130
 - Image tab 122
 - importing test configurations..... 57
 - incrementing file name..... 38, 113
 - information about ConnectorMax2 152
 - inserting tip 28
 - insertion loss, measurement 128
 - inspecting fiber ends
 - as a batch 63, 79
 - separately 90

Index

- single fiber 71, 73
- transceiver 71, 73
- with 3-step inspection tip 101
- inspection mode
 - capture 71, 77
 - live video 73, 77, 79, 90, 101
- inspection tip
 - installation 28
 - location on probe 4
 - movable part 31
 - notch 28, 30, 31, 32, 147
 - removing 34
- inspection zone
 - adhesive 119
 - cladding 119
 - contact 119
 - core 119
 - defects 51
 - scratches 51
 - thresholds 51
- installing
 - inspection tip on probe 28, 30
 - nozzle 32
- interchangeable adapter tips 2, 3, 5, 7
- internal temperature 6, 71, 77, 147

K

- key
 - down 30, 32, 104
 - of the nozzle 30, 32, 147
 - of the probe 28, 31
 - up 30, 32, 104

L

- label, identification 152
- LED
 - battery, probe 3, 4, 5, 9, 10, 143
 - status 2, 3, 4, 5, 8, 9, 149
 - Wi-Fi 3, 4, 5, 9, 10
- legacy picture files 117
- lenses, cleaning 142

- level of magnification 4, 86, 97, 110
- Li-ion polymer battery 143, 144
- live video
 - button, in the application 11
 - inspection mode 73, 77, 79, 90, 101
- lost connection 23

M

- magnification
 - control button 2, 3, 4, 88, 99, 112
 - level 86, 97, 110
- maintenance
 - general information 139
 - recharging the battery, probe 143
 - replacing the battery, probe 144, 145
- managing test configurations 45
- manual focus level 159
- manual-scanning tip
 - inspecting as a batch 63, 79
 - inspecting fibers separately 90
 - multifiber inspection 35, 81, 92
 - overlay 64, 87, 98, 111
 - retesting fibers 109
 - viewing results 125
 - X wheel 87, 98, 111
 - Y wheel 87, 98, 111
- measuring
 - insertion loss 128
 - power loss 128
- micro-USB power adapter 3, 4, 5, 143
- models available 6
- modifying
 - antireflective coating parameter 50
 - default folder 62
 - existing fiber information 70
 - file contents 151
 - inspection zones thresholds 51
 - test configuration parameters 49, 50
- movable part of the inspection tip 31, 34
- MPO, cleaning connector 141

- multifiber
 - 3-step inspection tip 35, 101
 - inspection as a batch 63
 - manual-scanning tip inspection 35, 77
79, 90
 - overlay 64, 87, 98, 111
 - retesting fibers 109
 - selecting connector 82, 93, 101
 - tip selection 35, 81, 92, 103

- N**
- naming files automatically 38, 113
- notch of the inspection tip 28, 30, 31
32, 147
- nozzle
 - changing 29
 - installation 32
 - key down 104
 - key for installation 30, 147
 - key up 104

- O**
- online help 152
- opening files 117
- orientation of the key 104
- overlay 64, 87, 98, 111, 123

- P**
- peak focus 72, 78
- performing
 - first capture 107
 - second capture 108
 - third capture 109
- polishing type 49
- position displayed on inspection tip 108
- power loss, measurement 128
- power meter
 - analysis status 11
 - auto mode 128
 - automatically clearing measurements.. 127
 - configuration 67
 - displaying controls 126
 - results 129
- Power Meter tab 129
- preview of the file name 38, 41
- probe
 - battery compartment door 3, 4, 5, 145
 - battery LED 3, 4, 5, 9, 10
 - capture control button 2, 3, 4
 - connection 23, 24
 - disconnection 23, 25
 - focus knob 3, 4, 147
 - inspection tip 4, 5, 29
 - interchangeable adapter tips 2, 3, 5, 7
 - key 31
 - magnification control button 2, 3, 4, 88
99, 112
 - micro-USB power adapter 3, 4, 5, 143
 - nozzle 4, 5, 29
 - protective cap 5
 - recharging the battery 143
 - retaining nut 2, 3, 4, 28
 - status LED 2, 3, 4, 5, 8, 9
 - trigger 4, 5, 31, 34
 - USB driver 137
 - warmup 6, 71, 77
 - Wi-Fi LED 3, 4, 5, 9, 10
- probe features
 - auto analysis 119
 - auto capture 119
 - auto centering 118
 - auto focus 118
- process button 89
- product
 - identification label 152
 - specifications 12
- protective cap 5

R

reaching the focus level manually 159
recharging the battery, probe 5, 143
red indicator..... 72, 78
regulatory information.....v
removable nozzle 4, 5, 29
removing
 inspection tip..... 28, 34
 nozzle 32
replacing the battery, probe..... 5, 144, 145
report creation
 automatically..... 133
 customizing with items 131
 manually..... 134
restoring to default settings..... 69
Results tab 124
results, power meter 129
retaining nut 2, 3, 4, 28
retesting fibers 109
return merchandise authorization (RMA) .. 157

S

safety
 caution 13
 conventions 13
 electrical information..... 18
 warning 13
saving files
 automatically..... 113
 manually..... 113, 115
scratches found on fiber endface 123
second capture with 3-step
 inspection tip 108
selecting
 3-step inspection tip 103
 automatic connection..... 26, 27
 fiber configuration 104
 file contents..... 151
 multifiber tip 35, 81, 92
 test configurations 45, 75, 84, 95, 105

selecting features
 auto analysis 76, 85, 96, 106
 auto capture 76, 85, 96
 auto centering 76, 85, 96
 auto focus..... 76, 85, 96, 106
separator in the file name 38, 41
sequencing tests with TestFlow 10
service and repairs 157
service centers 158
setting up
 autonaming 38
 brightness 36, 37
 default storage folder 62
 thresholds for inspection zones 51
shipping to EXFO 157
single fiber
 connector 73
 inspection 71, 73
 viewing results 124
software update 135, 136
specifications, product 12
standby mode 23
status
 features..... 120
 LED 2, 3, 4, 5, 8, 9, 149
 of the analysis..... 11, 123
 per zone..... 123
stopping analysis on first fail..... 66
storage requirements 139
storing files..... 113, 115
symbols, safety 13

T

tabs
 Image..... 122
 Power Meter 129
 Results 124
technical specifications..... 12
technical support..... 152
temperature for storage 139

- test configurations
 - creating 47
 - deleting 54
 - duplicating 48
 - editing 52
 - exporting 59
 - importing 57
 - managing 45
 - power meter 67
 - selecting 45, 75, 84, 95, 105
 - TestFlow 10
 - third capture with 3-step inspection tip 109
 - tip
 - 3-step inspection 35
 - changing 28
 - compatibility chart..... 159
 - manual-scanning 35
 - transceivers
 - connector 73
 - inspection 71, 73
 - viewing results..... 124
 - transportation requirements 139, 153
 - trigger 4, 5, 31, 34
 - types of separator 38, 41
- U**
- updating
 - firmware..... 135, 136, 149
 - software 135, 136
 - USB
 - cable..... 5, 143
 - device 62
 - driver configuration..... 137
 - power adapter..... 143
- V**
- VFL
 - displaying controls..... 126
 - identifying fiber faults 130
- viewing
 - area..... 11, 12
 - fibers as a batch..... 79
 - fibers separately..... 90
 - fibers with 3-step inspection tip 101
 - information about ConnectorMax2..... 152
 - online help 152
 - power meter results 129
 - results with 3-step inspection tip 125
 - results with manual-scanning tip 125
 - single fiber ends..... 71
 - single fiber results..... 124
 - transceivers..... 71
 - transceivers results..... 124
- W**
- warmup period..... 6, 71, 77
 - warranty
 - certification..... 156
 - exclusions 156
 - general..... 155
 - liability..... 156
 - null and void..... 155
 - watermark..... 71, 77
 - Wi-Fi
 - frequency band data.....vii
 - LED 3, 4, 5, 9, 10
 - wireless probe
 - connection 23, 24
 - disconnection 23, 25
- X**
- X wheel 87, 98, 111
- Y**
- Y wheel..... 87, 98, 111
 - yellow indicator 72, 78, 147
- Z**
- zone diameters 50

CHINESE REGULATION ON RESTRICTION OF HAZARDOUS SUBSTANCES (RoHS)
中国关于有害物质限制的规定

NAMES AND CONTENTS OF THE TOXIC OR HAZARDOUS SUBSTANCES OR ELEMENTS
CONTAINED IN THIS EXFO PRODUCT
包含在本 EXFO 产品中的有毒有害物质或元素的名称及含量

Part Name 部件名称	Lead 铅 (Pb)	Mercury 汞 (Hg)	Cadmium 镉 (Cd)	Hexavalent Chromium 六价铬 (Cr(VI))	Polybrominated biphenyls 多溴联苯 (PBB)	Polybrominated diphenyl ethers 多溴二苯醚 (PBDE)
Enclosure 外壳	O	O	O	O	O	O
Electronic and electrical sub-assembly 电子和电气组件	X	O	X	O	X	X
Optical sub-assembly ^a 光学组件 ^a	X	O	O	O	O	O
Mechanical sub-assembly ^a 机械组件 ^a	O	O	O	O	O	O

Note:

注:

This table is prepared in accordance with the provisions of SJ/T 11364.

本表依据 SJ/T 11364 的规定编制。

O: Indicates that said hazardous substance contained in all of the homogeneous materials for this part is below the limit requirement of GB/T 26572.

O: 表示该有害物质在该部件所有均质材料中的含量均在 GB/T 26572 标准规定的限量要求以下。

X: indicates that said hazardous substance contained in at least one of the homogeneous materials used for this part is above the limit requirement of GB/T 26572. Due to the limitations in current technologies, parts with the "X" mark cannot eliminate hazardous substances.



X: 表示该有害物质至少在该部件的某一均质材料中的含量超出 GB/T 26572 标准规定的限量要求。

标记 "X" 的部件, 皆因全球技术发展水平限制而无法实现有害物质的替代。

a. If applicable.

如果适用。

MARKING REQUIREMENTS
标注要求

Product 产品	Environmental protection use period (years) 环境保护使用期限 (年)	Logo 标志
This EXFO product 本 EXFO 产品	10	
Battery ^a 电池	5	

a. If applicable.
如果适用。

P/N: 1076176

www.EXFO.com · info@EXFO.com

CORPORATE HEADQUARTERS 400 Godin Avenue

Quebec (Quebec) G1M 2K2 CANADA
Tel.: 1 418 683-0211 · Fax: 1 418 683-2170

TOLL-FREE (USA and Canada)

1 800 663-3936

© 2019 EXFO Inc. All rights reserved.
Printed in Canada (2019-10)

EXFO

