FIP-500

Fiber Inspection Scope



Copyright © 2021–2023 EXFO Inc. All rights reserved. No part of this publication may be reproduced, stored in a retrieval system or transmitted in any form, be it electronically, mechanically, or by any other means such as photocopying, recording or otherwise, without the prior written permission of EXFO Inc. (EXFO).

Information provided by EXFO is believed to be accurate and reliable. However, no responsibility is assumed by EXFO for its use nor for any infringements of patents or other rights of third parties that may result from its use. No license is granted by implication or otherwise under any patent rights of EXFO.

EXFO's Commerce And Government Entities (CAGE) code under the North Atlantic Treaty Organization (NATO) is 0L8C3.

The information contained in this publication is subject to change without notice.

Trademarks

EXFO's trademarks have been identified as such. However, the presence or absence of such identification does not affect the legal status of any trademark.

Where applicable, the Bluetooth[®] word mark and logos are registered trademarks owned by Bluetooth SIG, Inc. and any use of such marks by EXFO Inc. is under license. Where applicable, the MTP[®] mark is a registered trademark of US Conec Ltd. Other third party trademarks and trade names are those of their respective owners.

Units of Measurement

Units of measurement in this publication conform to SI standards and practices.

Patents

The exhaustive list of patents is available at EXFO.com/patent.

Version number: 7.0.0.2

Contents

| | |
|---|-----------|
| Regulatory Information | vi |
| 1 Introducing the FIP-500 Fiber Inspection Scope | 1 |
| Main Features | 1 |
| LED Indicators Description | 4 |
| Battery Status Icon Description | 6 |
| Power Sources | 7 |
| Technical Specifications | 8 |
| Conventions | 8 |
| 2 Safety Information | 9 |
| General Safety Information | 9 |
| Other Safety Symbols on Your Unit | 11 |
| Electrical Safety Information | 12 |
| 3 Getting Started with Your Unit | 15 |
| Turning on Your Unit | 15 |
| Turning off Your Unit | 16 |
| Configuring Your Unit at First Startup | 17 |
| Understanding the Inspection Screen | 19 |
| Using the Control Center | 20 |
| Changing Your Unit's SmarTip | 21 |
| Changing Your Unit's Optical Head | 27 |
| Cleaning and Connecting Optical Fibers | 31 |
| Temperature Management | 33 |
| 4 Setting up Your Unit | 35 |
| Adjusting Display Brightness | 35 |
| Selecting the Inspection Mode | 36 |
| Configuring Pass/Fail Criteria | 39 |
| Configuring the Auto Save | 43 |
| Configuring the Auto Navigation | 45 |
| Selecting the Language of Operation | 47 |
| Adjusting the Date, Time and Time Zone | 49 |
| Configuring the Sleep Mode | 51 |
| Enabling or Disabling Sound Effects | 53 |
| Reverting to Factory Settings | 55 |
| Working with the Remote Control Mode | 57 |

Contents

- 5 Working With Jobs63**
 - Understanding the My Jobs Page63
 - Selecting an Active Job65
 - Viewing Job Properties67
 - Deleting a Job From Your Unit69
 - Synchronizing Job Results With a USB Connection71
 - Synchronizing Job Results With a Wi-Fi Connection72

- 6 Inspecting Fiber Ends73**
 - Selecting the Connector and Interface Types73
 - Selecting the Fiber Type80
 - Inspecting Single-, Duplex- and Multi-Fiber Connectors83
 - Returning to the Live Feed88
 - Viewing Duplex-Fiber Captures89
 - Navigating Through Multi-Fiber Captures91
 - Understanding the Unit’s Behaviour When Saving Results93
 - Navigating Through Saved Tests95
 - Displaying or Hiding the Overlay97
 - Turning on or Turning off the Flashlight98

- 7 Working with the EXFO Exchange Application99**
 - Installing the EXFO Exchange Application on Your Smart Device99
 - Establishing or Closing a Connection With a Smart Device Via the Bluetooth Technology ..100
 - Enabling or Disabling the Wireless Communication105
 - Working With a Wireless Network108
 - Synchronizing Job Results With the Smart Device and the Cloud Server117

- 8 Maintenance119**
 - Cleaning Lenses120
 - Cleaning the Touchscreen130
 - Battery Maintenance Recommendations131
 - Recharging the Battery133
 - Replacing the Battery136
 - Updating Software With a Wi-Fi Connection145
 - Clearing All Data147
 - Recycling and Disposal148

| | |
|--|------------|
| 9 Troubleshooting | 149 |
| Solving Common Problems | 149 |
| Restoring Your Unit to Normal Operation | 153 |
| Accessing the Online Documentation | 155 |
| Contacting the Technical Support Group | 156 |
| Sharing Information With the Technical Support Group With a Wi-Fi Connection | 157 |
| Viewing System Information | 159 |
| Viewing Contact Information | 165 |
| Transportation | 166 |
| 10 Warranty | 167 |
| General Information | 167 |
| Gray Market and Gray Market Products | 168 |
| Liability | 169 |
| Exclusions | 169 |
| Certification | 169 |
| Service and Repairs | 170 |
| EXFO Service Centers Worldwide | 171 |
| Index | 173 |

Regulatory Information

USA Electromagnetic Interference Regulatory Statement

Electronic test and measurement equipment is exempt from FCC part 15, subpart B compliance in the United States of America. However, EXFO Inc. makes reasonable efforts to ensure compliance to the applicable standards.

The limits set by these standards are designed to provide reasonable protection against harmful interference when the equipment is operated in a commercial environment. This equipment generates, uses, and can radiate radio frequency energy and, if not installed and used in accordance with the user documentation, may cause harmful interference to radio communications. Operation of this equipment in a residential area is likely to cause harmful interference in which case the user will be required to correct the interference at his own expense.

Modifications not expressly approved by the manufacturer could void the user's authority to operate the equipment.

Canada Electromagnetic Interference Regulatory Statement

This equipment generates, uses, and can radiate radio frequency energy and, if not installed and used in accordance with the instruction manual, may cause harmful interference to radio communications. Operation of this equipment in a residential area is likely to cause harmful interference.

Cet équipement génère, utilise et peut émettre de l'énergie radio-fréquence et, s'il n'est pas installé et utilisé conformément à la documentation de l'utilisateur, il peut occasionner une interférence néfaste aux communications radio. L'utilisation de cet équipement dans une zone résidentielle est susceptible d'occasionner une interférence néfaste.

Caution: This equipment is not intended for use in residential environments and may not provide adequate protection to radio reception in such environments.

Attention : Cet appareil n'est pas destiné à être utilisé dans des environnements résidentiels et peut ne pas assurer la protection adéquate à la réception radioélectrique dans ce type d'environnements.

This is a class A, group 1 product.

Ceci est un produit de classe A, groupe 1.

- Class A equipment: Equipment that is, by virtue of its characteristics, highly unlikely to be used in a residential environment, including a home business shall be classified as class A and shall comply with the class A limits specified in the applicable ICES standard. Characteristics considered in this assessment include price, marketing and advertising methodology, the degree to which the functional design inhibits applications suitable to residential environments, or any combination of features that would effectively preclude the use of such equipment in a residential environment.

Classe A : Matériel qui, en raison de ses caractéristiques, ne sera fort probablement pas utilisé dans un milieu domiciliaire ni par des entreprises établies à domicile. Parmi les caractéristiques considérées dans cette évaluation, il y a le prix, les méthodes de commercialisation et de publicité, la mesure dans laquelle les fonctions de l'appareil font qu'il ne se prête pas à des applications convenant au milieu domiciliaire ou toute combinaison de ces caractéristiques qui aurait pour conséquence d'en prévenir effectivement l'utilisation à domicile. Utilisé également pour indiquer les limites d'émission correspondantes qui s'appliquent à un tel matériel.

- Class B equipment: Equipment that cannot be classified as Class A shall comply with the Class B limits specified in the applicable ICES standard.

Classe B : Matériel qui ne peut pas être inclus dans la classe A. Utilisé également pour indiquer les limites d'émission correspondantes qui s'appliquent à un tel matériel.

- Group 1 equipment: group 1 contains all equipment which is not classified as group 2 equipment, and includes equipment such as laboratory and scientific equipment, industrial process, measurement and control equipment.

Group 2 equipment: group 2 contains all ISM RF equipment in which radio-frequency energy in the frequency range 9 kHz to 400 GHz is intentionally generated and used or only used locally, in the form of electromagnetic radiation, inductive and/or capacitive coupling, for the treatment of material for inspection/analysis purposes, or for transfer of electromagnetic energy.

Appareils du groupe 1 : le groupe 1 réunit tous les appareils compris dans le domaine d'application de la présente Norme, qui ne sont pas classés comme étant des appareils du groupe 2. Le groupe 1 inclut les appareils scientifiques et de laboratoire, les processus industriels, appareils de mesure ou de contrôle.

Appareils du groupe 2 : le groupe 2 réunit tous les appareils ISM à fréquences radioélectriques dans lesquels de l'énergie à fréquences radioélectriques dans la plage de fréquences comprises entre 9 kHz et 400 GHz est produite et utilisée volontairement ou uniquement utilisée localement sous forme de rayonnement électromagnétique, de couplage inductif et/ou capacitif, pour le traitement de la matière, à des fins d'examen ou d'analyse ou pour le transfert d'énergie électromagnétique.

Supplier's Declaration of Conformity (SDoC)

The SDoC for your product is as follows:

CAN ICES-001 (A) / NMB-001 (A)

EU and UK Electromagnetic Compatibility Regulatory Statement

Warning: This is a class A product. In a domestic environment, this product may cause radio interference in which case the user may be required to take adequate measures. Your product is suitable for use in industrial electromagnetic environments.

General Wireless Compliance Related Information

Your unit comes with internal wireless modules for which the information hereafter applies:

This product does not contain any wireless user-serviceable components. Any unauthorized product changes or modifications will invalidate warranty and all applicable regulatory certifications and approvals.

Canada and USA Wireless Compliance Related Information

Your unit comes with internal wireless modules for which the information hereafter applies:

- This device complies with Part 15 of the FCC Rules.
- This device complies with Innovation, Sciences and Economic Development Canada license-exempt RSS standards.
- Operation is subject to the following two conditions:
 - (1) This device may not cause harmful interference
 - and
 - (2) this device must accept any interference received, including interference that may cause undesired operation.

Use in Specific Environments:

- The use of wireless products in hazardous locations is limited by the constraints posed by the safety directors of such environments.
- The use of wireless products on airplanes is governed by the Federal Aviation Administration (FAA).
- The use of wireless products in hospitals is restricted to the limits set forth by each hospital.
- Do not operate a portable transmitter near unshielded blasting caps or in an explosive environment.

Radiation Exposure Statement:

- The product complies with the US/Canada portable RF exposure limit set forth for an uncontrolled environment and is safe for intended operation as described in this user documentation.
- Further RF exposure reduction can be achieved if the device can be kept as far as possible from the user's body.

RF Function and Frequency Range:

Your unit is designed to operate in the Bluetooth and WLAN 2.4 GHz bands, and at 13.56 MHz for NFC/RFID.

The information about the Bluetooth and Wi-Fi frequency bands is as follows:

- Bluetooth: Between the frequencies 2402 MHz - 2480 MHz.
The output power is 11.7 dBm typical.
- Wi-Fi: Channels 1 through 11 - Between the frequencies 2412 MHz - 2462 MHz.
The maximum output power is 18.5 dBm.

EU and UK Wireless Compliance Related Information

Your unit is designed to operate in the Bluetooth and WLAN 2.4 GHz bands, and at 13.56 MHz for NFC/RFID.

The information about the Bluetooth and Wi-Fi frequency bands is as follows:

- ▶ **Bluetooth:** Between the frequencies 2402 MHz - 2480 MHz.
The output power is 11.7 dBm typical.
- ▶ **Wi-Fi:** Channels 1 through 13 - Between the frequencies 2412 MHz - 2472 MHz.
The maximum output power is 18.5 dBm typical.

This is a 2.4 GHz wideband transmission system (transceiver), intended for use in all EU member states, United Kingdom, and EFTA countries.

Local Restrictions on 802.11a, 802.11b, 802.11d, 802.11g, 802.11n, and 802.11ac Radio Usage

Due to the fact that the frequencies used by 802.11a, 802.11b, 802.11d, 802.11g, 802.11n, and 802.11ac wireless LAN devices may not yet be harmonized in all countries, 802.11a, 802.11b, 802.11d, 802.11g, 802.11n, and 802.11ac products are designed for use only in specific countries, and are not allowed to be operated in countries other than those of designated use. As a user of these products, you are responsible for ensuring that the products are used only in the countries for which they were intended and for verifying that they are configured with the correct selection of frequency and channel for the country of use.

Simplified EU and UK Declaration of Conformity

Hereby, EXFO declares that the radio equipment type “FIP-500” is in compliance with European Directive 2014/53/EU and the UK legislation S.I. 2017/1206 Radio Equipment Regulations 2017.

The full text of the declaration of conformity is available at the following Internet address: *www.exfo.com/en/resources/legal-documentation*.

Note: *Information such as the FCC and IC numbers is available directly from your unit. From the main menu, tap **Settings** and then **Regulatory**. The information is listed on the **Regulatory** screen.*

EU Economic Operator

EXFO Solutions SAS
2, rue Jacqueline Auriol,
Saint-Jacques-de-la-Lande,
35091 Rennes Cedex 9
FRANCE

Japanese Technical Conformity Mark for Radio Law

This equipment contains specified radio equipment that has been certified to the Technical Regulation Conformity Certification for Japan, under the Radio Law.

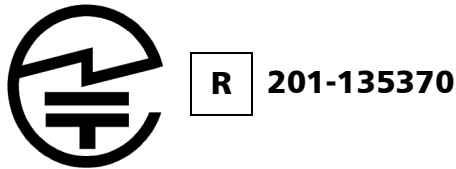

Japan Wireless Compliance Related Information

Your unit is designed to operate in the Bluetooth and WLAN 2.4 GHz bands.

The information about the Bluetooth and Wi-Fi frequency bands is as follows:

- ▶ Bluetooth: Channels 1 through 13 - Between the frequencies 2412 MHz - 2472 MHz.
The output power is 11.7 dBm typical.
- ▶ Wi-Fi: Channels 1 through 13 - Between the frequencies 2412 MHz - 2472 MHz.
The maximum output power is 18.5 dBm.

1 **Introducing the FIP-500 Fiber Inspection Scope**

The FIP-500 Fiber Inspection Scope is a portable video microscope used to inspect optical fiber and cable ends. Its built-in 2.4-inch capacitive touchscreen and quick-change SmarTips facilitate the examination of patchcord connectors and also hard-to-reach connectors on the back of patch panels and bulkhead adapters.

Main Features

- Ergonomic design
- 2.4-inch capacitive touchscreen directly on unit allowing standalone measurements
- Fast autofocus, auto centering, auto acquisition and auto analysis
- Quick change of SmarTips
- Designed to support single-fiber, duplex-fiber and multi-fiber connectors
- Visual feedback
- Wi-Fi and Bluetooth® connectivity (if your unit has wireless capabilities)
- Easy software updates

Introducing the FIP-500 Fiber Inspection Scope

Main Features



CAUTION

The optical head of your unit contains precision components. To ensure optimum protection when you do not use the unit or during transportation, cover the optical head with the provided protective cap.

Side view

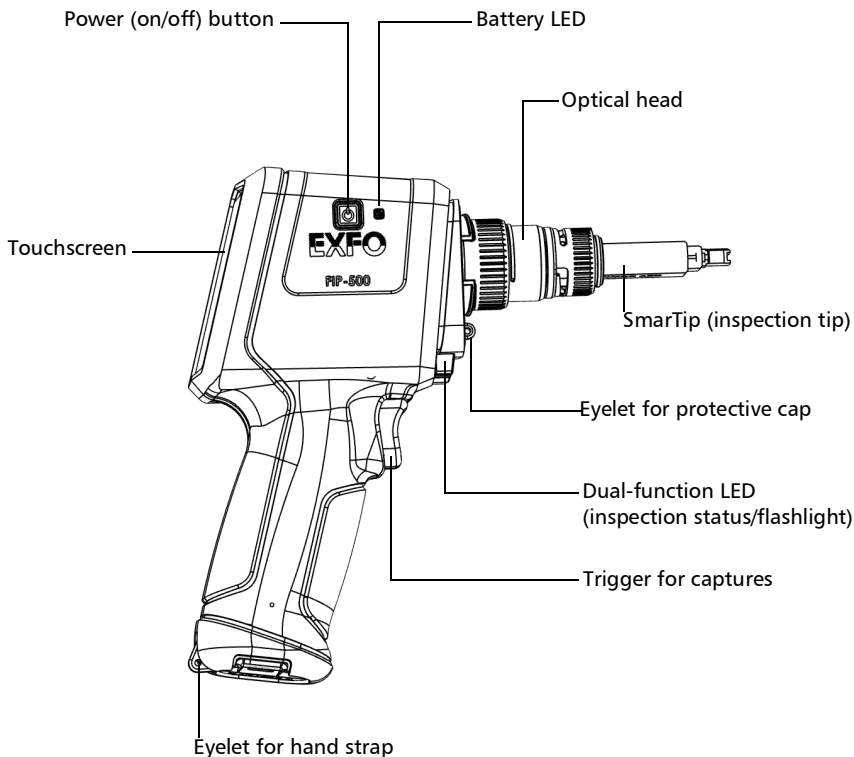

Introducing the FIP-500 Fiber Inspection Scope

Main Features

Back view

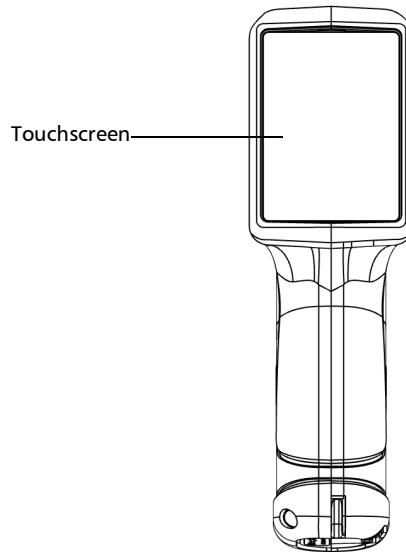

Bottom view

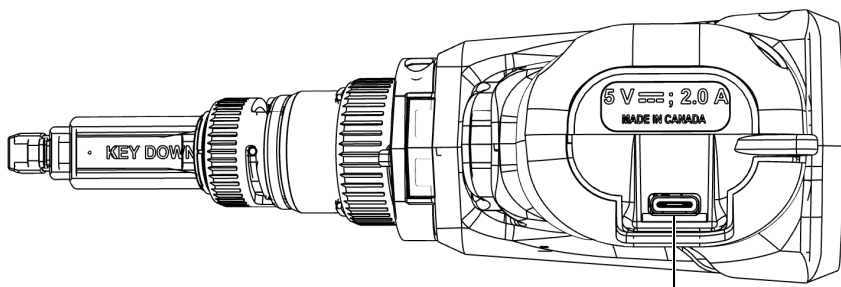

USB 2.0 Type-C connector for battery charging
(see *Power Sources* on page 7)

Introducing the FIP-500 Fiber Inspection Scope

LED Indicators Description

LED Indicators Description

Your unit is equipped with a battery LED and a dual-function LED.

Battery LED

The battery LED, located next to the power button, on the side of your unit, provides you with information about the battery status.

The table below indicates the possible statuses.

| Unit | Status | Meaning |
|---|--------------------------------|--|
| Connected to an external power source | Off | The external power source does not provide sufficient power to charge the battery. |
| | Blue | The battery is fully charged. |
| | Blue, blinking – slow blinking | The battery is charging. |
| | Blue, blinking – fast blinking | The battery charge has been interrupted, possibly because the unit may not be within the recommended charging temperatures. For more information, see <i>Equipment Ratings</i> on page 13. |
| | Red, fast blinking | Charge or temperature error. |
| | Red, steady for 5 seconds | The battery level is too low to start the unit. |
| | White | The unit is starting up. |
| Not connected to an external power source | Off | The unit is not connected to an external power source. |
| | Red, steady for 5 seconds | The unit is off and the battery level is too low to start the unit. |
| | White | The unit is starting up. |

Dual-Function LED

The dual-function LED is located just above the trigger used for captures, on the front of your unit. It can indicate the status of the inspection or be used as a flashlight to help you see the connectors you have to inspect in darker environments (see *Turning on or Turning off the Flashlight* on page 98).

The table below indicates the possible statuses.



| Status | Meaning |
|-----------------------------|--|
| Blue | The unit is ready and operational. The flashlight feature is disabled. |
| Blue, blinking | The capture process is in progress. |
| Green, steady for 5 seconds | The analysis found no defects or scratches exceeding the pass criteria. |
| Red, blinking for 5 seconds | <ul style="list-style-type: none"> ➤ The capture process could not be completed successfully. Follow the instructions on the screen. ➤ The autofocus operation has timed out. ➤ There is a mismatch between the number of fibers found and the selected multi-fiber connector layout. |
| Red, steady for 5 seconds | The analysis found defects or scratches that do not meet the pass criteria. |
| White | The unit is ready and operational. The flashlight feature is enabled. |

Introducing the FIP-500 Fiber Inspection Scope

Battery Status Icon Description

Battery Status Icon Description

The battery status icon is shown in the upper right corner of the title bar. It complements the information provided by the unit's LED.

| Icon | Meaning |
|---|--|
|  | The portion of the icon that appears in white in the title bar (in gray here) reflects the current battery level. |
|  | A red icon indicates that the battery level is running low and that you should connect the unit to a power outlet. |
|  | A flash symbol indicates that the unit is connected to an external power source. |

Power Sources

The Fiber Inspection Scope operates with the following power sources:

- Indoor use only: USB power adapter connected to a power outlet (fastest way to charge the battery).

Note: *The standard USB ports of a computer cannot power your unit or charge its battery while the unit is on. If you connect your unit to such a USB port with the USB cable, the unit will still consume battery power. If the unit is off when you connect it to the USB port of a computer, its battery could charge, but slowly.*

Note: *If you have a vehicle equipped with dedicated USB charging ports, you could connect your unit to one of these ports to charge the battery. The actual results will vary with each vehicle. You could also use a certified USB power bank (portable charger) to charge your unit.*

- Indoor and outdoor use: One lithium-ion (Li-ion) rechargeable battery (battery that automatically takes over if you disconnect the unit from its external power source).

Possible to switch from an external power source to battery power or vice versa without affecting operation.

The battery recharges automatically when the unit is connected to an external power source.

Note: *When the ambient temperature is below 0 °C (32 °F) or when it reaches or exceeds about 40 °C (104°F), the battery can either charge more slowly than usual, or not charge at all, depending on the internal temperature of your unit.*

Note: *You can replace the battery yourself (see Replacing the Battery on page 136).*

For more information, see *Electrical Safety Information* on page 12.

Technical Specifications

To obtain this product's technical specifications, visit the EXFO Web site at www.exfo.com.

Conventions

Before using the product described in this guide, you should understand the following conventions:



WARNING

Indicates a potentially hazardous situation which, if not avoided, could result in *death or serious injury*. Do not proceed unless you understand and meet the required conditions.



CAUTION

Indicates a potentially hazardous situation which, if not avoided, may result in *minor or moderate injury*. Do not proceed unless you understand and meet the required conditions.



CAUTION

Indicates a potentially hazardous situation which, if not avoided, may result in *component damage*. Do not proceed unless you understand and meet the required conditions.



IMPORTANT

Refers to information about this product you should not overlook.

2 **Safety Information**

General Safety Information



WARNING

Do not install or terminate fibers while a light source is active. Never look directly into a live fiber and ensure that your eyes are protected at all times.



WARNING

The use of controls, adjustments and procedures, namely for operation and maintenance, other than those specified herein may result in hazardous radiation exposure or impair the protection provided by this unit.



WARNING

If the equipment is used in a manner not specified by the manufacturer, the protection provided by the equipment may be impaired.



WARNING

Use only accessories designed for your unit and approved by EXFO. For a complete list of accessories available for your unit, refer to its technical specifications or contact EXFO.

Safety Information

General Safety Information



IMPORTANT

Refer to the documentation provided by the manufacturers of any accessories used with your EXFO product. It may contain environmental and/or operating conditions limiting their use.



IMPORTANT

When you see the following symbol on your unit , make sure that you refer to the instructions provided in your user documentation. Ensure that you understand and meet the required conditions before using your product.



IMPORTANT

When you see the following symbol on your unit , it indicates that the unit is equipped with a laser source, or that it can be used with instruments equipped with a laser source. These instruments include, but are not limited to, modules and external optical units.



IMPORTANT

Other safety instructions relevant for your product are located throughout this documentation, depending on the action to perform. Make sure to read them carefully when they apply to your situation.













CAUTION

Do not use the fiber inspection scope outdoors in wet locations.

Other Safety Symbols on Your Unit

One or more of the following symbols may also appear on your unit.

| Symbol | Meaning |
|--|--|
|  | Direct current |
|  | Alternating current |
|  | The unit is equipped with an earth (ground) terminal. |
|  | The unit is equipped with a protective conductor terminal. |
|  | The unit is equipped with a frame or chassis terminal. |
|  | On (Power) |
|  | Off (Power) |
|  OR  | On/off (Power) |
|  | Fuse |

Electrical Safety Information



WARNING

If you need to ensure that the unit is completely turned off, disconnect the power cable and remove the battery. For more information on how to remove the battery, see the section about replacing the battery in this user documentation.



WARNING

- ▶ Use the external power supply (USB power adapter) indoors only.
- ▶ Never connect the unit to the AC mains (with the USB power adapter) when it is used outdoors.
- ▶ Never connect the unit to a computer with the USB cable when it is used outdoors.
- ▶ To avoid electrical shock, do not operate the unit if any part of the outer surface (covers, panels, etc.) is damaged.
- ▶ Only authorized personnel should carry out adjustments, maintenance or repair of opened units under voltage. A person qualified in first aid must also be present. Do not replace any components while the USB cable and battery are connected.
- ▶ Unless otherwise specified, all interfaces are intended for connection to ES1 circuits only.
- ▶ Use only the listed and certified USB power adapter provided by EXFO with your unit. It provides reinforced insulation between primary and secondary, and is suitably rated for the country where the unit is sold.
- ▶ Capacitors inside the unit may be charged even if the unit has been disconnected from its electrical supply.



CAUTION

- Position the unit so that the air can circulate freely around it.
- When you use the unit outdoors, ensure that it is protected from liquids, dust, direct sunlight, precipitation, and full wind pressure.



CAUTION

The use of voltages higher than those indicated on the label affixed to your unit may damage the unit.

| Equipment Ratings | |
|---|--|
| Temperature ➤ Operation ➤ Storage | <ul style="list-style-type: none"> ➤ unit powered by battery: -10 °C to 40 °C (14 °F to 104 °F) ➤ unit connected to AC power (with USB power adapter): 0 °C to 40 °C (32 °F to 104 °F)^a ➤ unit – short-term storage^b: -40 °C to 70 °C (-40 °F to 158 °F) ➤ unit – long-term storage^c: 10 °C to 35 °C (50 °F to 95 °F) |
| Relative humidity ^d | <ul style="list-style-type: none"> ➤ unit: ≤ 93 % non-condensing ➤ USB power adapter: 10 % to 90 % non-condensing |
| Maximum operation altitude | <ul style="list-style-type: none"> ➤ 3000 m (9843 ft) (unit connected to external power source) ➤ 4000 m (13123 ft) (unit operated from battery) |
| Pollution degree | <ul style="list-style-type: none"> ➤ 2 (unit connected to external power source) ➤ 3 (unit operated from battery)^e |

Safety Information

Electrical Safety Information

| Equipment Ratings | |
|--------------------------|--|
| Overvoltage category | <ul style="list-style-type: none">➤ unit: I➤ USB power adapter: II |
| Measurement category | Not rated for measurement categories II, III, or IV |
| Input power ^f | <ul style="list-style-type: none">➤ unit: 5 V ---; 2 A➤ USB power adapter: 100 - 240 V ~; 50/60 Hz; 1 A max |

- a. When the ambient temperature is below 0 °C (32 °F) or when it reaches or exceeds about 40 °C (104°F), the battery can either charge more slowly than usual, or not charge at all, depending on the internal temperature of your unit.
- b. Short-term storage corresponds to the storage of the unit for a maximum of 48 hours.
- c. Long-term storage corresponds to the storage of the unit for more than three months.
- d. Measured in 0 °C to 31 °C (32 °F to 87.8 °F) range, decreasing linearly to 50 % at 40 °C (104 °F).
- e. Equipment must be normally protected against exposure to direct sunlight, precipitation and full wind pressure.
- f. Not exceeding ± 10 % of the nominal voltage.

3 Getting Started with Your Unit

Turning on Your Unit

When you turn on the unit for the very first time, you will be prompted to read and accept the EXFO license agreement and set the date and time (see the section about the first startup for more information).

Note: *The settings you modify at startup can be modified later if necessary.*

To turn on the unit:

Press the on/off button until the unit beeps once. The battery LED will light up during the startup process (until the FIP-500 splash screen is displayed).

Side view

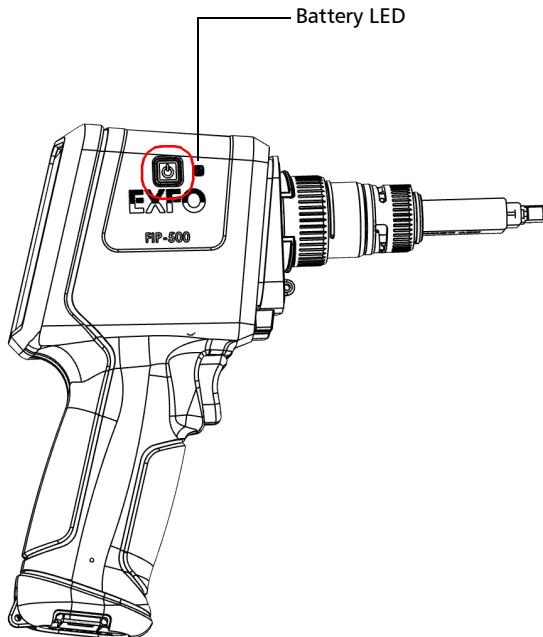

Turning off Your Unit

Unless specified otherwise in this documentation, the settings you configure on your unit are kept in memory even when you turn the unit off.

There are several ways to turn off the unit, including the following:

- *Sleep*: keeps the unit's status information in memory (RAM). The next time you turn your unit on, you will quickly return to your work environment (running applications will still be running). If you intend to leave your unit in sleep mode for a long period of time (one day or more), you should perform a shutdown instead to save battery power.
- *Shutdown*: completely cuts power to the unit; the unit will perform a complete restart routine the next time you use it. You should perform a shutdown if you do not intend to use your unit for several hours.

After a shutdown, the unit will start in the inspection screen.

Note: *Should the unit ever stop responding, you can force a hardware reset by pressing and holding down the on/off button for at least 10 seconds. To restart your unit, release the on/off button, and then press it again as you normally do to start your unit. The last capture or modifications made to the settings may be lost, but the rest of the data will still be available.*

To enter the sleep mode:

Briefly press the on/off button. The unit's touchscreen will turn off and be deactivated.

To exit the sleep mode and resume your work:

Press the on/off button or press the trigger.

To turn off the unit completely (shutdown):

Press the on/off button for about three seconds. A shutdown animation will be displayed on the screen.

Configuring Your Unit at First Startup

The first time you turn on the unit, you are prompted to select the language, read and accept the EXFO license agreement, set the date and time, and then read and accept the safety instructions.

Note: *You can change the language and regional parameters later if necessary.*

Once the configuration is complete, you are presented with a QR code allowing you to download the user documentation to a smart device.

Note: *If your unit has wireless capabilities and you use it in association with a smart device, the appearance of the EXFO Exchange application may vary slightly from the illustrations presented in this documentation depending on the type of smart device you are using. Unless otherwise specified, the information applies both to the Android- and iOS-based smart devices.*

Note: *Both on your unit and in the EXFO Exchange application, the period is used as the decimal separator in numerical values, when applicable.*

Note: *On your unit, the period is used as the decimal separator in numerical values, when applicable.*

To configure your unit at first startup:

- 1.** If it is not already done, turn on the unit (see *Turning on Your Unit* on page 15).
- 2.** Select a language, then tap **Next**.
- 3.** Read and accept the EXFO license agreement as follows:
 - 3a.** Use the QR code to download the license agreement to your smart device.
 - 3b.** Select the **I agree with the terms of this license agreement** box, then tap **Next**.

Getting Started with Your Unit

Configuring Your Unit at First Startup

4. If necessary, configure the date and time (tap the line corresponding to the item you want to modify). When it is done, tap **Next**.
5. Read the safety instructions and confirm as follows:
 - 5a. Use the QR code to download the user documentation to your smart device.
 - 5b. Select the **I have read the safety instructions** box, then tap **Close**.
6. EXFO recommends to configure a Wi-Fi network that will allow you to retrieve the software updates if your unit has wireless capabilities. You can proceed as follows:
 - 6a. Install the EXFO Exchange application on your smart device (see *Installing the EXFO Exchange Application on Your Smart Device* on page 99).
 - 6b. Establish a Bluetooth connection between the FIP-500 and the smart device (see *Establishing or Closing a Connection With a Smart Device Via the Bluetooth Technology* on page 100).
 - 6c. Configure a wireless network (see *Working With a Wireless Network* on page 108).

You are now ready to start working with your FIP-500.

Understanding the Inspection Screen

From the inspection screen, you can take captures of connectors under inspection and view these captures. If your unit has wireless capabilities, this screen provides information on elements such as the Bluetooth and Wi-Fi connections, as well as battery level.

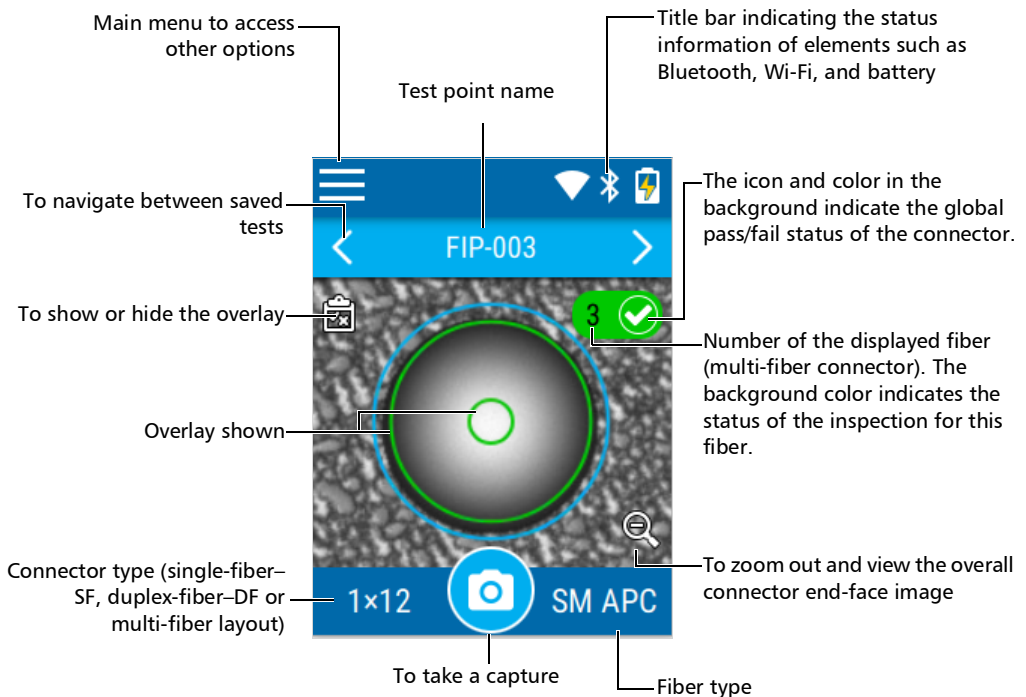

Note: You can also show or hide the overlay by tapping anywhere in the non-active area (gray background) of the image or directly on the image of the fiber when you view a specific fiber.

Getting Started with Your Unit

Using the Control Center

Using the Control Center

You can swipe in a downward motion from the upper-right corner of the screen as you would on a smart device to quickly access the most frequently used features such as the brightness settings, flashlight and inspection modes. If your unit has wireless capabilities, you can also activate or deactivate Bluetooth and Wi-Fi connections.

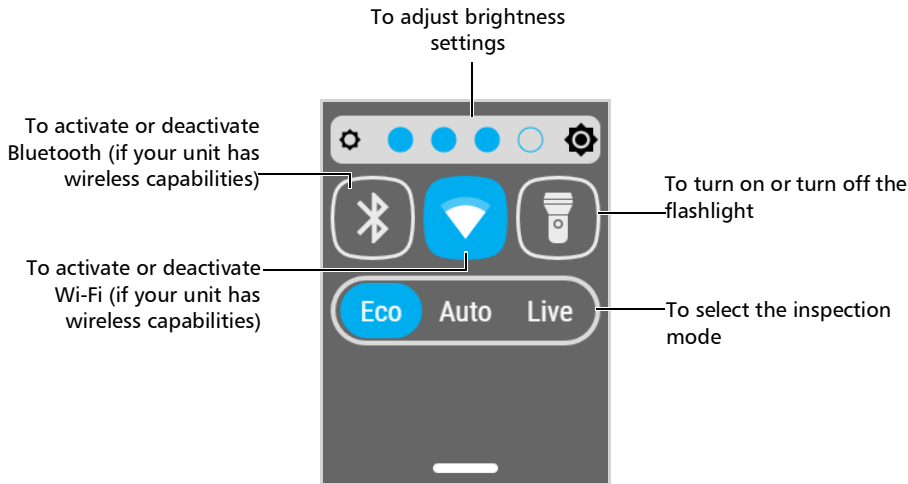

You can also access these features from the settings menu. For more information, see *Setting up Your Unit* on page 35.

Note: You can only activate and deactivate Bluetooth and Wi-Fi connections from the control center. To configure Bluetooth connections, see *Establishing or Closing a Connection With a Smart Device Via the Bluetooth Technology* on page 100. To configure a Wi-Fi network, see *Working With a Wireless Network* on page 108.

Changing Your Unit's SmartTip

You can change the SmartTip of your unit to fit the type of connector that you need to inspect. This is particularly useful if you need to inspect APC connectors, followed by UPC connectors, or vice versa.



IMPORTANT

You can only install single-fiber SmartTips on a single-fiber optical head, and duplex-fiber SmartTips and multi-fiber SmartTips on a multi-fiber optical head.

If you need to inspect single-fiber, duplex-fiber and multi-fiber connectors, you may find useful to leave the most frequently used SmartTip attached to its optical head and change the complete SmartTip–optical head assembly instead. For more information, see *Changing Your Unit's Optical Head* on page 27.

Your unit can use wireless tag detection similar to credit card technology to identify tip configurations automatically instead of having to configure manually multiple parameters and settings. On detection, the application shows on screen which connector types are supported by the tip.

Getting Started with Your Unit

Changing Your Unit's SmarTip

Note: *You can still use FIP-400 tips with your FIP-500 by installing an adapter. You can use several adapters, however you will not be able to benefit from your unit's quick-connect feature.*

Note: *Not all single-fiber FIP-400 tips can be used with your FIP-500. Please contact EXFO to obtain the complete list of supported tips. For contact information, see *Contacting the Technical Support Group* on page 156.*



IMPORTANT

If you are using an SFADP-400 adapter for FIP-400 tips, take the necessary precautions to avoid scratching or dirtying the lens when installing an FIP-400 tip to the assembly.

EXFO recommends to first add the FIP-400 tip to the adapter and then connect the assembly to the optical head to reduce the risk of damaging the lens.

The illustrations shown in the procedure hereafter are for the multi-fiber SmarTips, but the principle remains the same for the single- and duplex-fiber SmarTips.

To change your unit's SmartTip:

1. If necessary, remove the protective cap from the unit.
2. Turn the SmartTip retaining nut counterclockwise until the pins are aligned with the widest part of the SmartTip anchoring slots.

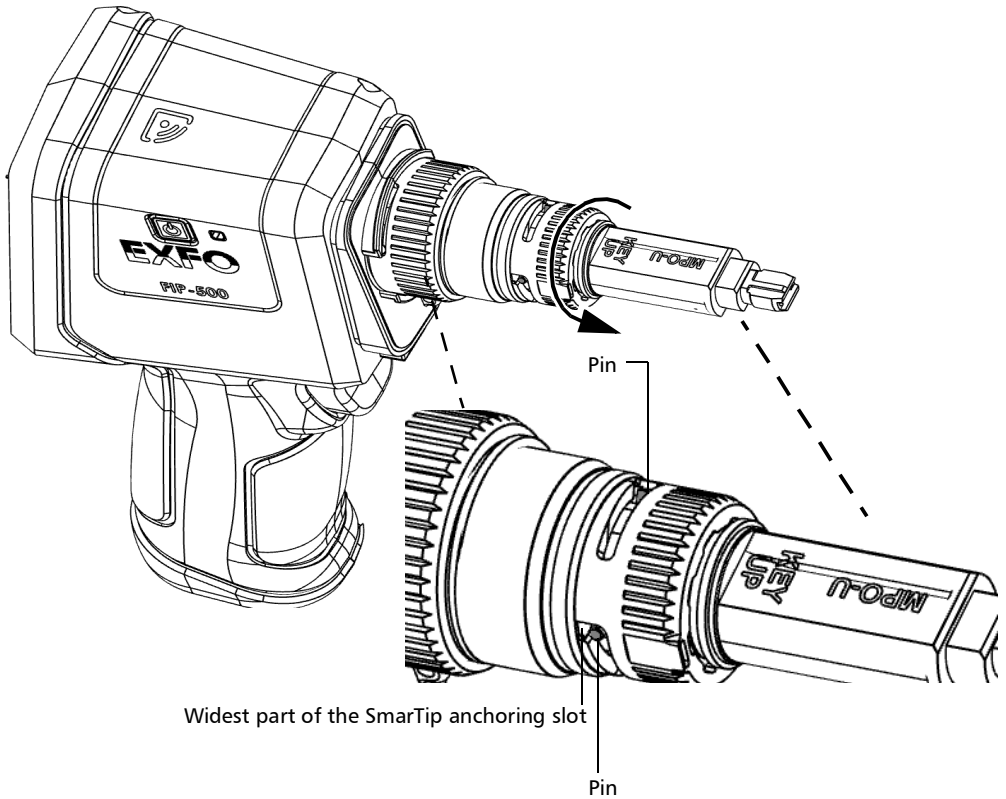

Getting Started with Your Unit

Changing Your Unit's SmartTip

3. Pull on the SmartTip to remove it.

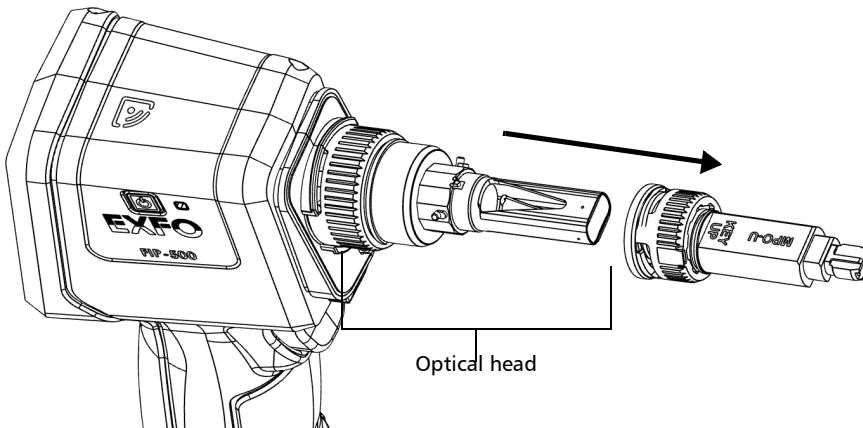

4. If your unit has wireless capabilities and you want it to automatically detect the tip, proceed as follows:
 - 4a. From the main menu, tap **Tip detection**.

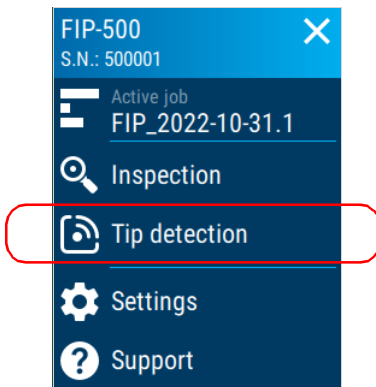

- 4b. Align the same logo  found on the unit and on the ring.
- 4c. Tap the logos together for the detection to occur. Your unit detects the tip and displays its name and information related to the tip. The information stays on the screen for 12 seconds and closes automatically. You can also tap the 'X' or pull the trigger to close the information window.

Note: *If your unit is unable to identify the tip, you may want to update the software to the latest version.*

5. Align the new SmartTip with the optical head, ensuring that the orientation of the SmartTip (either key up or key down, when applicable) suits your test setup. In all cases, ensure that the widest part of the anchoring slots is aligned with the pins.

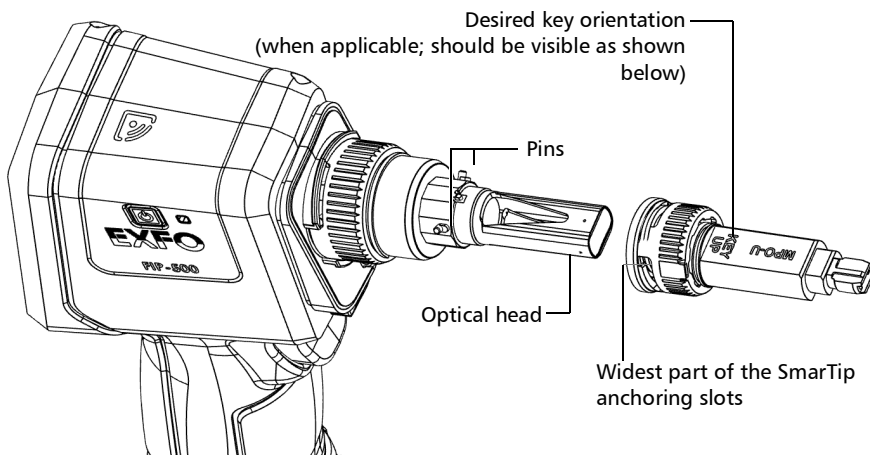

6. Slide the SmartTip toward the unit until it stops.

Getting Started with Your Unit

Changing Your Unit's SmarTip

7. Turn the SmarTip retaining nut clockwise until the pins are aligned with the narrowest part of the anchoring slots to secure the SmarTip in place.

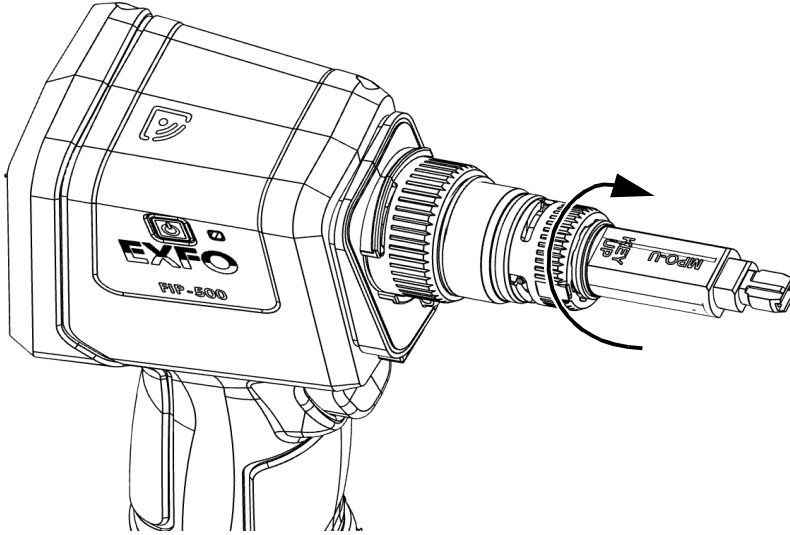

The new SmarTip is now ready to use.

Changing Your Unit's Optical Head

You can change the optical head on your unit depending on the type of inspection you want to perform. There is no need to disassemble the SmarTip from your unit before changing the optical head.

To change the optical head:

1. Slightly turn the optical head retaining nut counterclockwise to release it from your unit (the pins on the unit will be aligned with the widest part of the anchoring slots on the optical head).

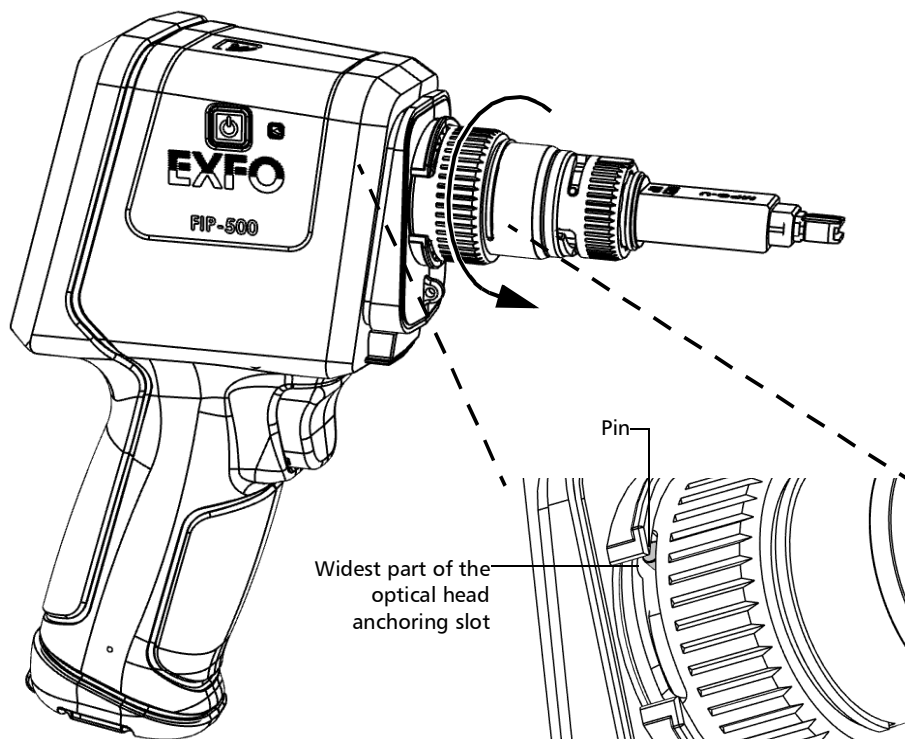

Getting Started with Your Unit

Changing Your Unit's Optical Head

2. Gently pull on the optical head to remove it.

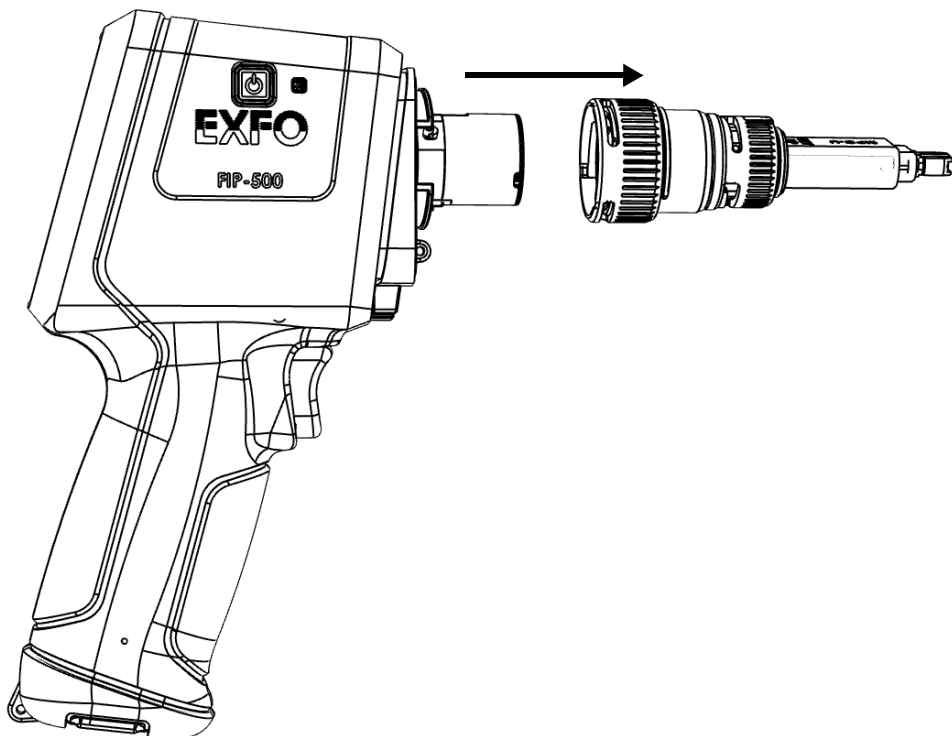

Getting Started with Your Unit

Changing Your Unit's Optical Head

3. Align the arrow on the new optical head with the arrow on your unit and then, gently put the optical head back in place.

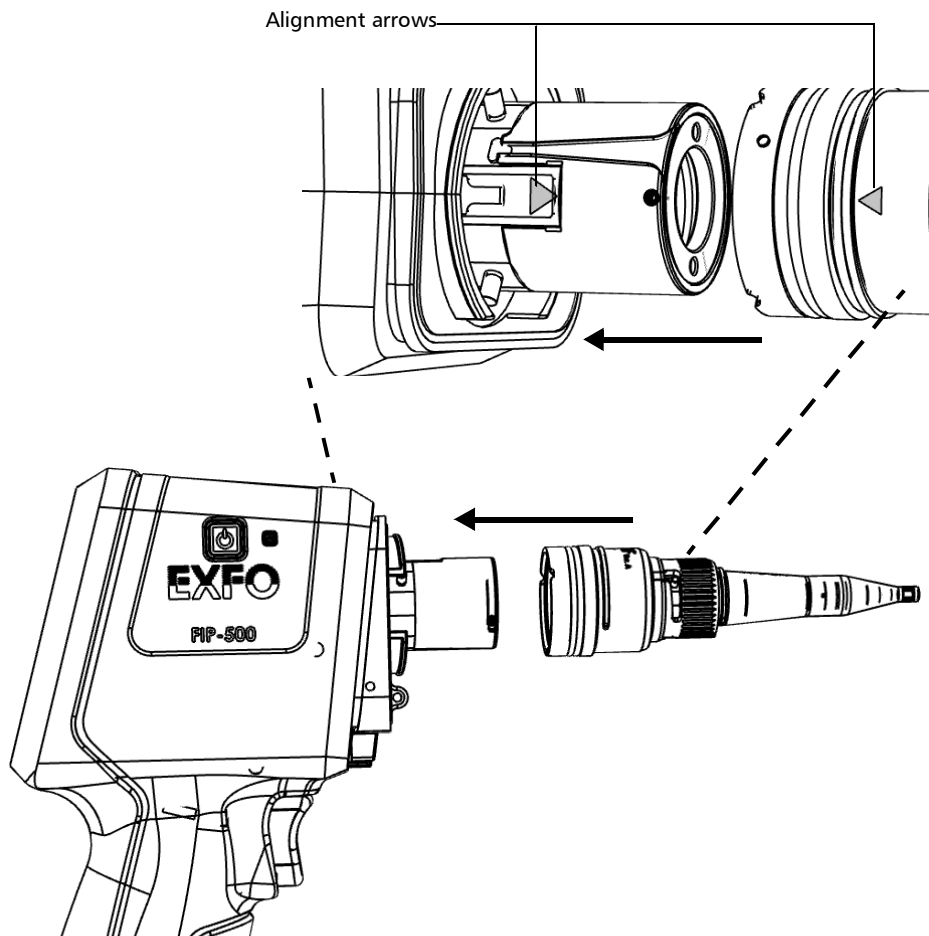

Getting Started with Your Unit

Changing Your Unit's Optical Head

4. Slightly turn the optical head retaining nut clockwise to secure it in place (the pins on the unit will be aligned with the narrowest part of the anchoring slots on the optical head).

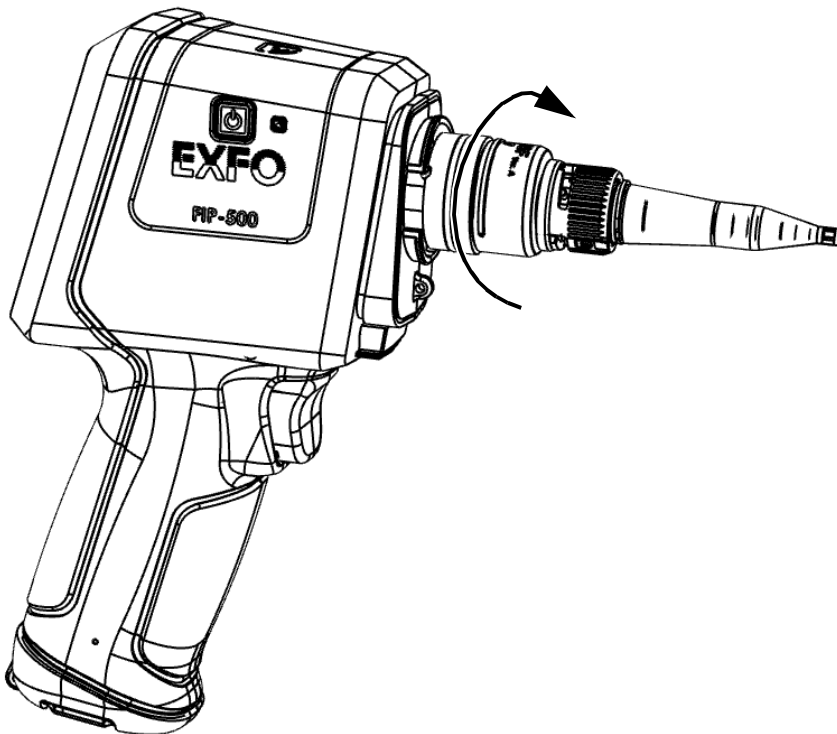

5. Configure the settings as required according to the type of optical head and SmarTip that you have installed (see *Selecting the Connector and Interface Types* on page 73 and *Selecting the Fiber Type* on page 80).
Your unit is now ready to use.

Cleaning and Connecting Optical Fibers



CAUTION

To ensure maximum power and to avoid erroneous readings:

- Always inspect fiber ends and make sure that they are clean as explained below before inserting them into the port. EXFO is not responsible for damage or errors caused by bad fiber cleaning or handling.
- Ensure that your patchcord has appropriate connectors. Joining mismatched connectors will damage the ferrules.

To connect the fiber-optic cable to the port:

1. Inspect the fiber using a fiber inspection scope (or probe). If the fiber is clean, proceed to connecting it to the port. If the fiber is dirty, clean it as explained below.
2. Clean the fiber ends as follows:
 - 2a. Gently wipe the fiber end with a lint-free swab dipped in optical-grade liquid cleaner.
 - 2b. Use a dry swab to dry the connector completely.
 - 2c. Visually inspect the fiber end to ensure its cleanliness.

Getting Started with Your Unit

Cleaning and Connecting Optical Fibers

3. Carefully align the connector and port to prevent the fiber end from touching the outside of the port or rubbing against other surfaces.

If your connector features a key, ensure that it is fully fitted into the port's corresponding notch.

4. Push the connector in so that the fiber-optic cable is firmly in place, thus ensuring adequate contact.

If your connector features a screw sleeve, tighten the connector enough to firmly maintain the fiber in place. Do not overtighten, as this will damage the fiber and the port.

Note: *If your fiber-optic cable is not properly aligned and/or connected, you will notice heavy loss and reflection.*

EXFO uses good quality connectors in compliance with EIA-455-21A standards.

To keep connectors clean and in good condition, EXFO strongly recommends inspecting them with a fiber inspection scope (or probe) before connecting them. Failure to do so may result in permanent damage to the connectors and degradation in measurements.

Temperature Management

The internal temperature of your unit will vary with the ambient temperature, but also with the type of tests you perform and their intensity.

In high-temperature conditions, your unit could stop working. If the temperature keeps rising and reaches the limit, a message is displayed warning you that the unit is shutting down due to high temperature. After a few seconds, it turns off as self-protection.

For more information on the effects of temperature on battery charging, see *Power Sources* on page 7.



IMPORTANT

For optimum performance of your unit:

- Ensure that it remains within the recommended operation and storage temperatures (see *Equipment Ratings* on page 13).
- Avoid leaving your unit in an overheated vehicle. You may have to let your unit cool down before being able to use it.
- If the unit was left in a vehicle during cold weather, you will have to let your unit warm up before using it.
- Ensure that your unit is normally protected from direct sunlight (during use and storage).

4 *Setting up Your Unit*

Adjusting Display Brightness

You may want to adjust the display brightness yourself to better fit your work environment or preferences.

You may also want to reduce the display brightness to save battery power (the higher the brightness level, the higher the power consumption).

The brightness value is kept in memory even when you turn the unit off.

To adjust the display brightness:

1. From the main menu, tap **Settings**.

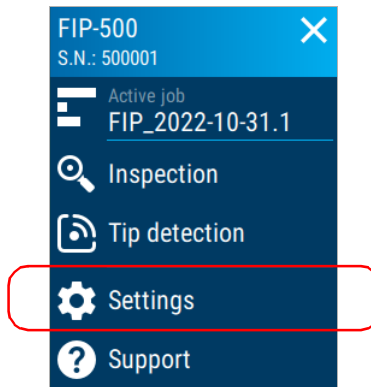

Setting up Your Unit

Selecting the Inspection Mode

2. Under **Brightness**, tap the dots until the screen appearance is to your liking. You can also tap the desired brightness icon to quickly set the brightness to the minimum or the maximum value.

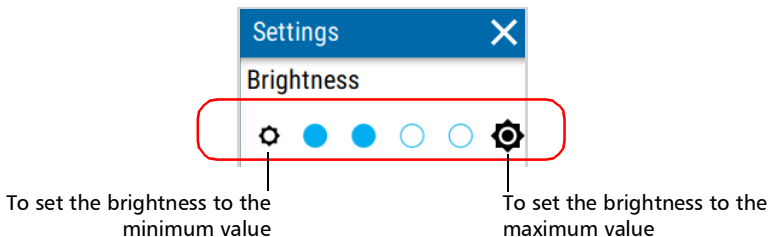

The new brightness value is taken into account immediately.

Note: You can also adjust the display brightness on your unit from the control center menu. For more information, see *Using the Control Center* on page 20.

Selecting the Inspection Mode

There are several types of inspection modes available with your unit.

- Auto mode: the unit automatically detects the removal and the insertion of a new connector when you are in the inspection screen. When you insert a connector, the unit automatically begins the capture process.
- Eco mode: the autofocus is always performed and you perform the captures on demand. This mode is the most battery efficient.
- Live mode: a live view of the connector is displayed on the screen. You can activate or deactivate the autofocus, manually adjust the focus through the user interface, and tap on the screen to change the zoom level for duplex- and single-fiber inspections. You can perform the capture on demand.

To select the inspection mode:

1. From the main menu, tap **Settings**.

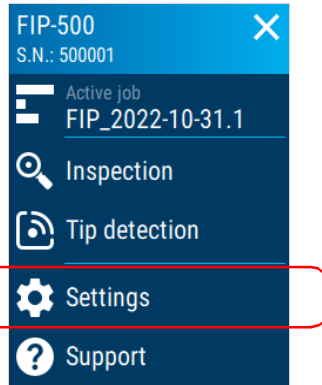

2. Scroll down to the **Inspection** section.
3. Tap **Inspection mode**.

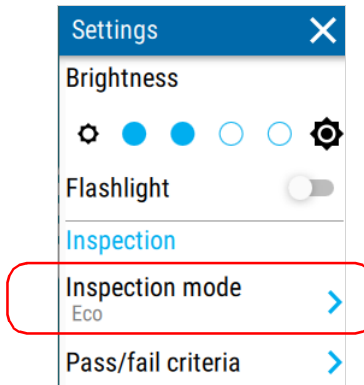

Note: You can also select the inspection mode on your unit from the control center menu. For more information, see *Using the Control Center* on page 20.

Setting up Your Unit

Selecting the Inspection Mode

4. Select the inspection mode.

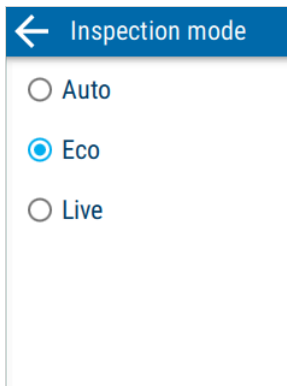

5. For the Live mode, you can enable or disable the **Autofocus** feature with the corresponding toggle. The toggle is only available when you select the Live mode.

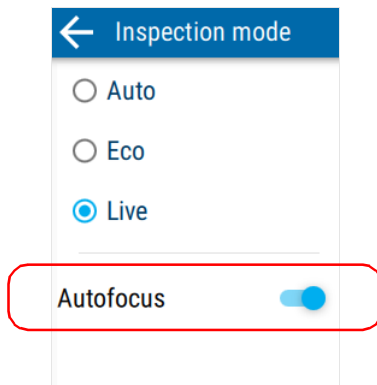

The new mode is taken into account immediately.

Configuring Pass/Fail Criteria

You can configure the pass/fail criteria for the analysis of captures performed on your unit according to industry standards. The pass/fail criteria are defined for fiber inspections and optical connector end-face analysis, with distinct criteria specified for different types of fibers and connectors used. You can also activate or deactivate the analysis process performed on captures.

To configure pass/fail criteria:

1. From the main menu, tap **Settings**.

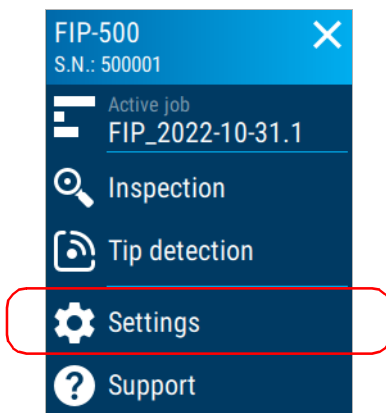

2. Scroll down to the **Inspection** section.

Setting up Your Unit

Configuring Pass/Fail Criteria

3. Tap **Pass/fail criteria**.

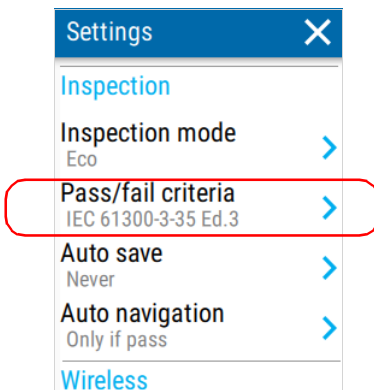

4. Ensure the analysis process is enabled using the corresponding toggle if necessary.

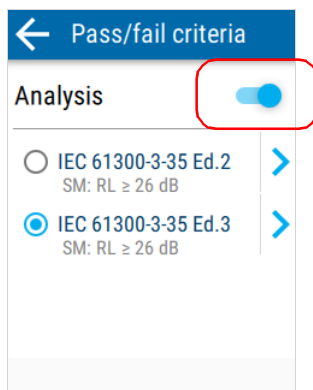

Note: With the Analysis toggle disabled, you can still perform and save captures. Your unit will not provide a pass/fail status for the connectors, detect fibers or display the overlay.

5. Select a standard. If you wish to more precisely define the applied pass/fail criteria, tap the right arrow.

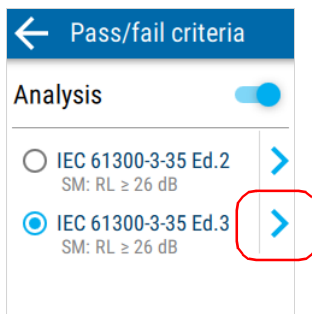

6. If you selected the IEC 61300-3-35 Edition 3, you can analyze the entire multi-fiber end-face. This feature is activated by default and can impact the analysis time. If you wish to only analyze fibers and not the end-face, tap the corresponding toggle to disable the analysis.

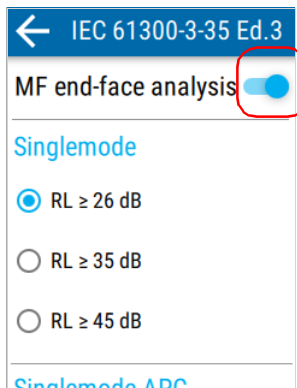

Setting up Your Unit

Configuring Pass/Fail Criteria

7. Select the desired Singlemode (UPC) connector performance. The selection only applies to single- and duplex-fiber connector types.

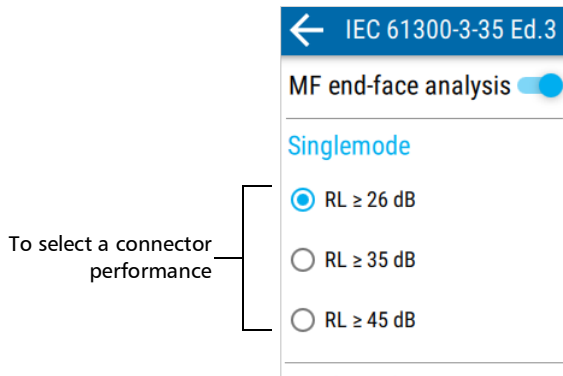

8. Tap the  twice to return to the **Settings** menu.
The pass/fail criteria will be taken into account for the next inspection.

Configuring the Auto Save

You may want to enable the auto save feature on your unit according to your preferences when taking captures. The following options are available:

- **Never:** your units never saves the test results automatically. You have to tap the save icon at the top of the screen to save the results. For more information, see *Understanding the Unit's Behaviour When Saving Results* on page 93.
- **Only if pass:** your unit only saves the test results that pass according to configured criteria. If a test fails, you can still save on demand or perform a new capture.
- **Always:** your unit always saves the test results. If you have enabled the analysis process, your unit saves the test results whether the test passes or fails.

Note: You can choose one of the options above for the default job your unit creates. For jobs that were created using EXFO Exchange, the auto save is always enabled and you cannot disable it from the Settings menu.

To configure the auto save:

1. From the main menu, tap **Settings**.

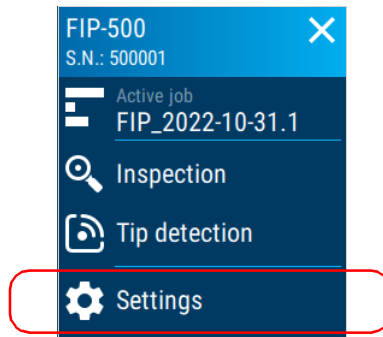

2. Scroll down to the **Inspection** section.

Setting up Your Unit

Configuring the Auto Save

3. Tap **Auto save**.

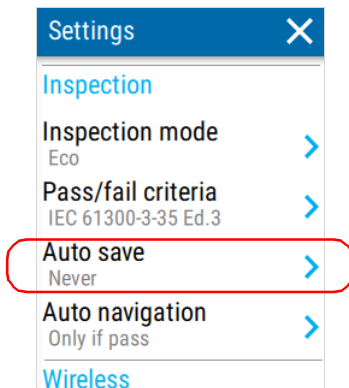

4. Select the desired setting from the list.

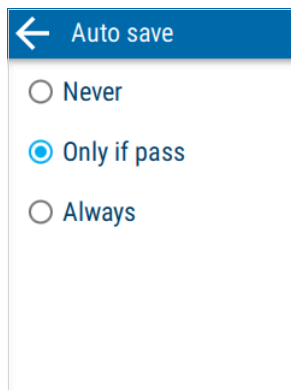

The new setting will be taken into account for the next inspection.

Note: If you selected **Only if pass** and your unit generates a diagnostic that requires your attention after performing a test that is part of a default job, the test will not save automatically. You need to tap the save icon in the header to save the test.

Configuring the Auto Navigation

You may want to enable the auto navigation feature on your unit according to your preferences when taking captures. The following options are available:

- **Never:** Your unit never navigates to the next test point once the capture process is complete.
- **Only if pass:** Your unit navigates to the next test point once the analysis process is complete only if the test has a pass status. If the current test is the last one in the job, your unit stays on the current test point.
- **Always:** Your unit always navigates to the next test point once the capture process is complete. If the current test is the last one in the job, your unit stays on the current test point.

To configure the auto navigation:

1. From the main menu, tap **Settings**.

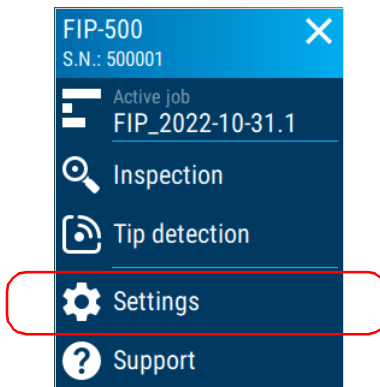

2. Scroll down to the **Inspection** section.

Setting up Your Unit

Configuring the Auto Navigation

3. Tap Auto navigation.

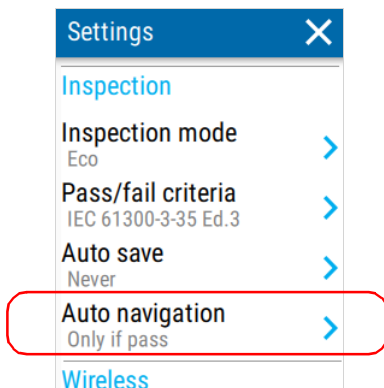

4. Select the desired setting from the list.

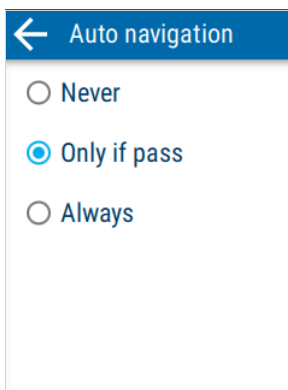

The new setting will be taken into account for the next inspection.

Note: *If you selected **Only if pass** and your unit generates a diagnostic that requires your attention after performing a test, your unit will not navigate to the next test point automatically. You need to tap the save icon in the header to save the test, then tap the right arrow to navigate to the next test point.*

Selecting the Language of Operation

You may display the user interface in one of the available languages. English is the default language.

The selected language is kept in memory even when you turn the unit off.

To select a new interface language:

1. From the main menu, tap **Settings**.

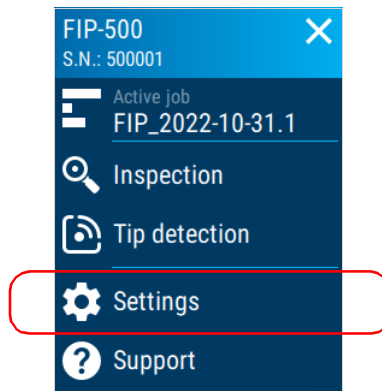

2. Scroll down to the **Unit settings** section.

Setting up Your Unit

Selecting the Language of Operation

3. Tap **Language**.

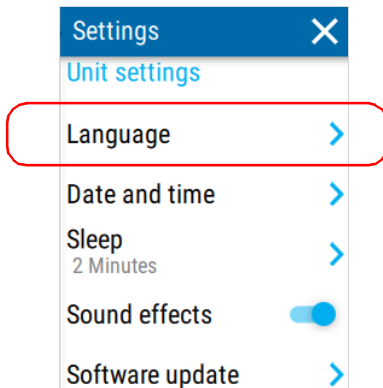

4. Select the desired language from the list.

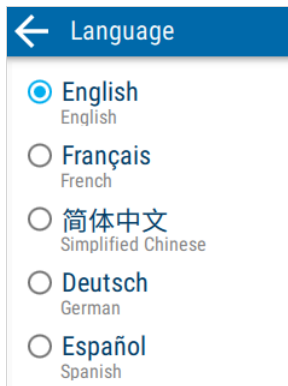

5. Tap  to return to the **Settings** screen.
The new language is applied immediately.

Adjusting the Date, Time and Time Zone

When saving results, the unit also saves the corresponding date and time.

Your unit expresses the date and time in international format.

You can set the date, time and time zone manually or let the unit synchronize them automatically with the EXFO Exchange application if your unit has wireless capabilities.

If you use your unit in conjunction with a smart device, each time you establish a connection between the two, by default, the date, time and time zone of the unit synchronize with those of the smart device.

To adjust the date, time and time zone manually:

1. From the main menu, tap **Settings**.

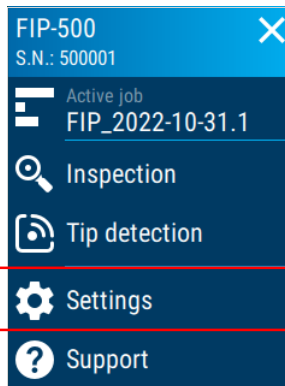

2. Scroll down to the **Unit settings** section.

Setting up Your Unit

Adjusting the Date, Time and Time Zone

3. Tap **Date and time**.

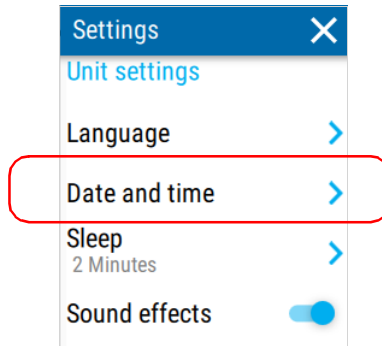

4. Tap the entry corresponding to the element that you want to modify.

Note: For units with wireless capabilities, to authorize the synchronization of your unit's time zone setting with the smart device, the **Sync time zone** toggle must be enabled. With the toggle enabled, the time zone of the smart device takes precedence over your unit's time zone setting.

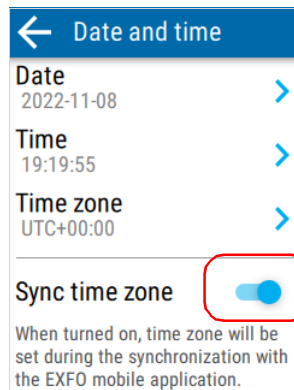

5. Modify the settings according to your preferences, and then tap  to return to the **Date and time** screen.

The new values are taken into account immediately.

Configuring the Sleep Mode

To help you get the optimum performance out of your unit, it comes with a predefined set of parameters to manage power.

When you do not use your unit for a while, it will go into sleep mode automatically to save power (see *Turning off Your Unit* on page 16).

By default, the duration after which the unit goes into sleep mode is 15 minutes, but you can select another value.

The value that you set is kept in memory even when you turn the unit off.

Note: *While data is synchronizing, the unit delays going into sleep mode while the synchronization process is ongoing (for units with wireless capabilities).*



IMPORTANT

- ▶ If you intend to leave your unit in sleep mode for one day or more, you should turn it off (shutdown) to save battery power.
- ▶ The unit will not enter sleep mode while you are using it.

To configure the duration after which the unit enters sleep mode:

1. From the main menu, tap **Settings**.

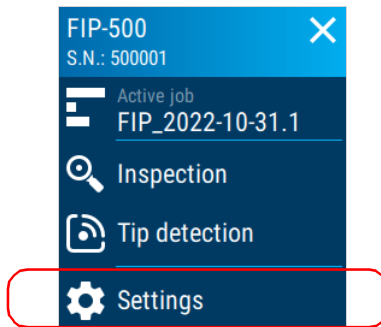

Setting up Your Unit

Configuring the Sleep Mode

2. Scroll down to the **Unit settings** section.
3. Tap **Sleep**.

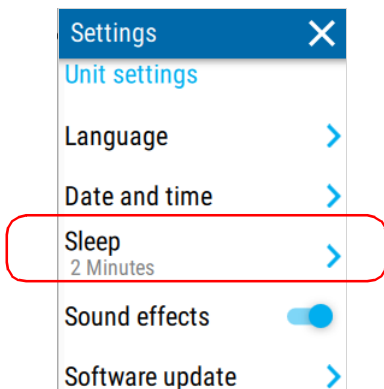

4. Select the desired number of minutes, and then tap  to return to the Settings screen.

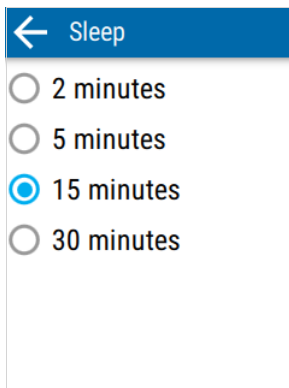

The new value is taken into account immediately.

Enabling or Disabling Sound Effects

Your unit emits sounds when performing certain actions during key capture events such as:

- At the end of the capture process. A short beep indicates that you can move or remove the connector. A different sound is generated when an error occurs during the capture process.
- At the end of the analysis process. This process determines if the test passes or fails.

You can disable the sound notifications if you prefer. Your preference is kept in memory even when you turn the unit off.

To enable or disable sound effects:

1. From the main menu, tap **Settings**.

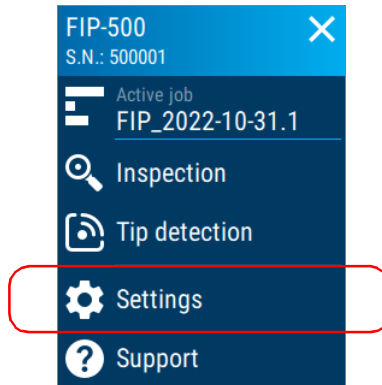

2. Scroll down to the **Unit settings** section.

Setting up Your Unit

Enabling or Disabling Sound Effects

3. Enable or disable the sound effects with the corresponding toggle.

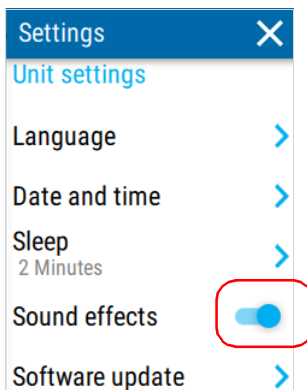

4. Close **Settings** to return to the inspection view.

The new settings are taken into account immediately.

Reverting to Factory Settings

At any time, you can reset all settings that you have customized, such as the delay before the unit switches to sleep mode, to their default values.

This operation does not affect the current date and time and does not delete any stored test data.

To revert values to factory settings:

1. From the main menu, tap **Settings**.

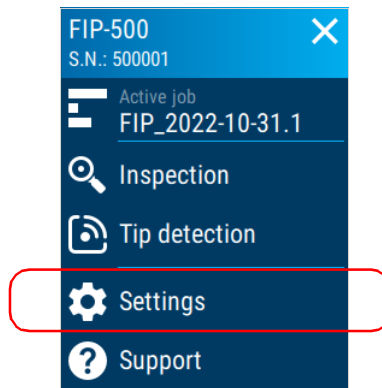

2. Scroll down to the **Unit settings** section.

Setting up Your Unit

Reverting to Factory Settings

3. Tap **Reset options**.

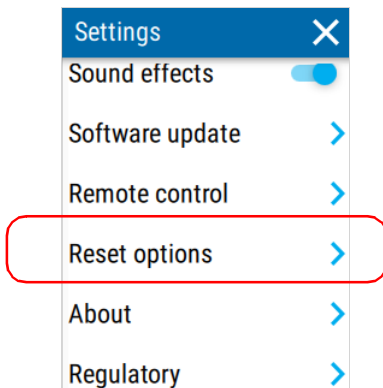

4. Tap **Factory settings**.

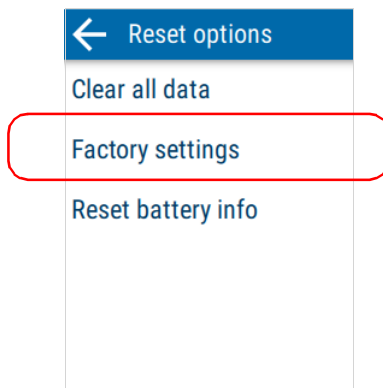

5. Tap **RESET** to confirm your choice and start the operation.
When the operation is complete, the unit will restart.
6. Configure the settings as you did when you first received your unit (see *Configuring Your Unit at First Startup* on page 17).

Working with the Remote Control Mode

You can remotely control your FIP-500 with an external library (using a REST API). With this mode, you can control your unit either through a wireless (Wi-Fi) if your unit has wireless capabilities or a wired connection (USB).



IMPORTANT

In remote control mode, your unit does not automatically go into sleep mode when it is not in use. EXFO strongly recommends putting your unit in sleep mode or turning it off (shutdown) to save battery power.

Note: For more information, refer to the documentation that accompanies the REST API.

To switch to the remote control mode:

1. From the main menu, tap **Settings**.

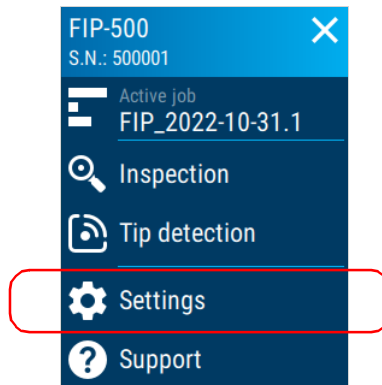

2. Scroll down to **Unit settings** section.

Setting up Your Unit

Working with the Remote Control Mode

3. Tap **Remote control**.

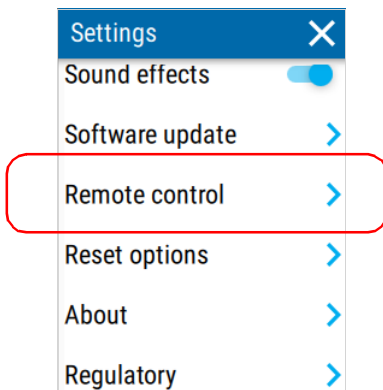

4. Tap the **Switch to Remote Control Mode** button.

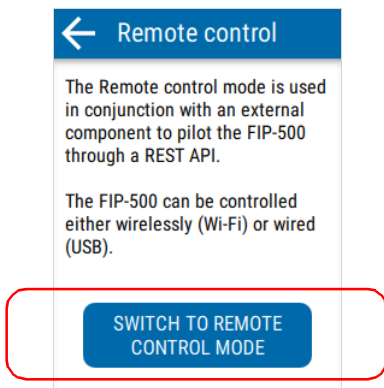

5. Tap **RESTART** to confirm your choice and start the operation.
When the operation is complete, the unit will restart.

6. Your unit is now ready to be controlled remotely. You can view information on your unit and the current connection state. To access the remote control mode settings, tap **Settings**.

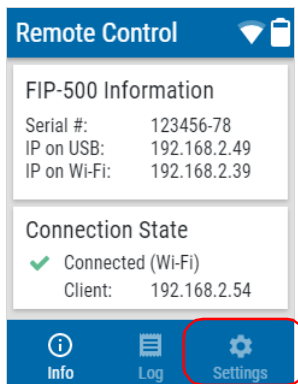

7. You can enable or disable the Wi-Fi network with the corresponding toggle. If you wish to configure a new Wi-Fi network, you must switch back to the inspection mode. For more information, see the procedure below on disabling the remote control mode.

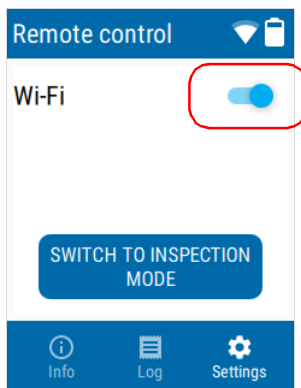

Setting up Your Unit

Working with the Remote Control Mode

8. To view information logged by your unit such as possible detection and fiber layout mismatch issues, tap **Log**.

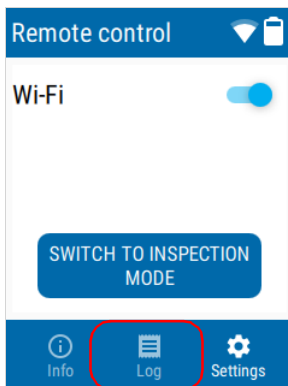

To switch back to the inspection mode:

1. To exit the remote control mode, tap **Settings**.

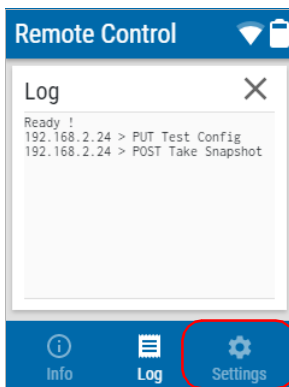

2. Tap the **Switch to Inspection Mode** button.

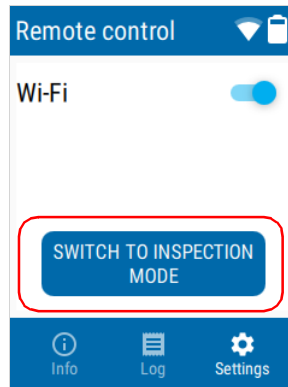

3. Tap **RESTART** to confirm your choice and start the operation.
When the operation is complete, the unit will restart.

5 Working With Jobs

Every test you perform on your unit is part of a job. At least one job is always available on your unit and contains a minimum of one test point. A job can be the default job created by your unit that contains 1000 test points (FIP-000 to FIP-999), or a job that someone created for you and sent to your unit using the EXFO Exchange mobile application if your unit has wireless capabilities.

Understanding the My Jobs Page



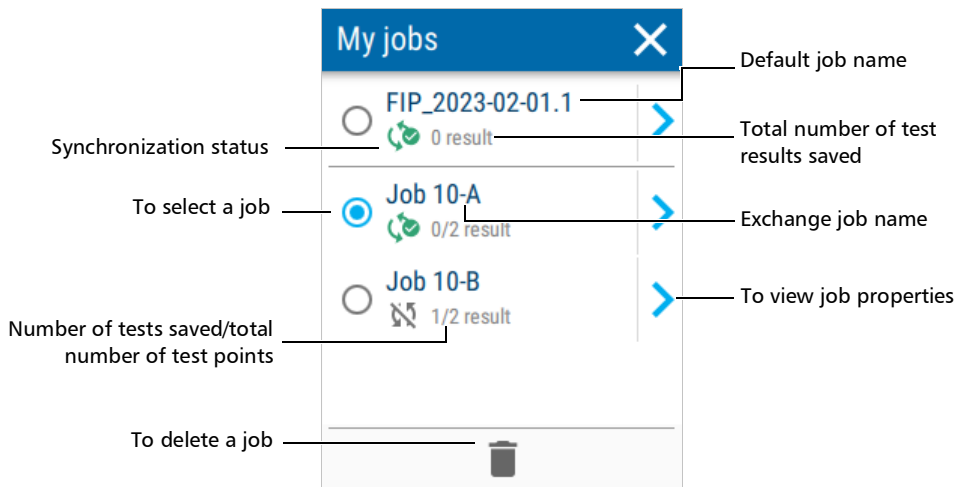

From the My jobs page, you can view the list of jobs, change the active job, view the synchronization status of each job and delete jobs.



Working With Jobs

Understanding the My Jobs Page

The icon below the job name indicates the current synchronization status of the job's test results. The table below shows the different possible synchronization statuses and their respective meanings.

| Icon | Meaning |
|---|--|
|  | All new test results acquired from the unit have synchronized their summary data. |
|  | At least one test result acquired from the unit has not synchronized their summary data and associated image(s). |
|  | At least one test result acquired from the unit has not synchronized its data yet. |
|  | The job is currently synchronizing its data. |

Selecting an Active Job

There is always one active job on your unit. The active job can be the default job your unit creates, or a job that was created using the EXFO Exchange mobile application. If there is more than one job available on your unit, you may want to select a different active job.

To select an active job:

1. From the main menu, tap **Active job**.

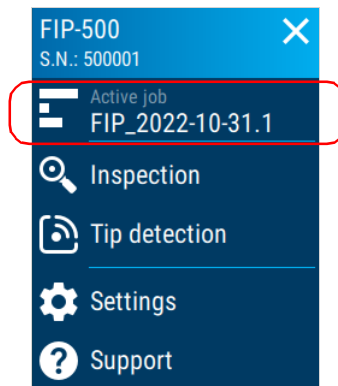

Working With Jobs

Selecting an Active Job

- From the list of available jobs, select a job name.

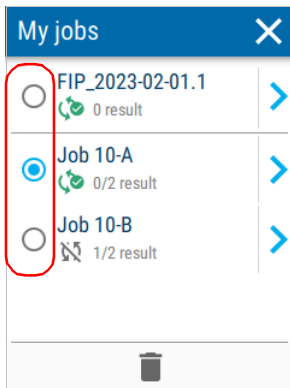

- Tap the  to return to the main menu.

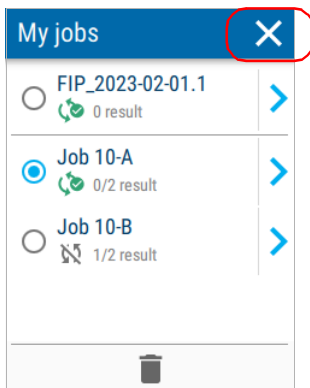

The job you selected is now the active job.

Viewing Job Properties

You can view the properties of the different jobs available on your unit. For jobs created using the EXFO Exchange mobile application, you can view specific job information such as location, operator name, as well as planned and due dates of the job, if applicable.

Note: *The job name is the only property displayed for the default job created by your unit.*

To view job properties:

1. From the main menu, tap **Active job**.

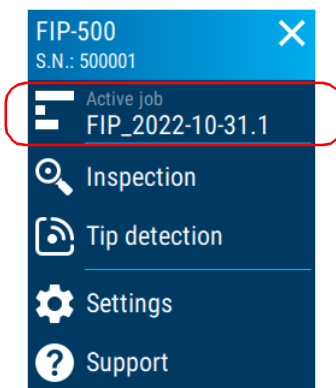

Working With Jobs

Viewing Job Properties

- From the list of available jobs, tap the right arrow to access the job properties.

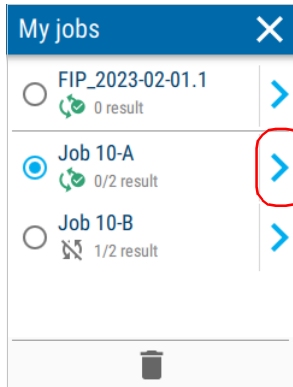

- The list of properties of the selected job is displayed. Tap the left arrow to return to the My jobs page.

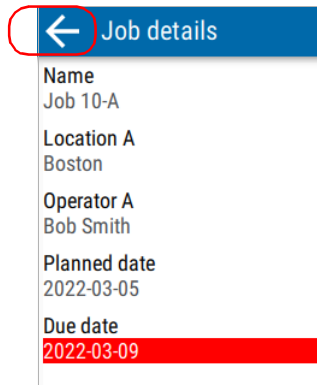

Note: If the job's due date is anterior to your unit's current date, the due date is highlighted in red.

Deleting a Job From Your Unit

You can delete jobs directly from your unit. When you delete a job, all its associated test results are deleted from your unit only. If you use your unit in conjunction with the EXFO Exchange mobile application, your results will still be available on the smart device. Before your unit deletes the job, you will receive a confirmation message inviting you to transfer all the results in the job if you have not already done so. The test details are still available for you to share with EXFO's technical support group. For more information, see *Sharing Information With the Technical Support Group With a Wi-Fi Connection* on page 157 if your unit has wireless capabilities.

After you delete a job, your unit will select the next available job in the list as the new active job.

Note: *If you delete the only job available in the My jobs page, your unit automatically creates a new job with 1000 new test points (FIP-000 to FIP-999).*

To delete a job from your unit:

1. From the main menu, tap **Active job**.

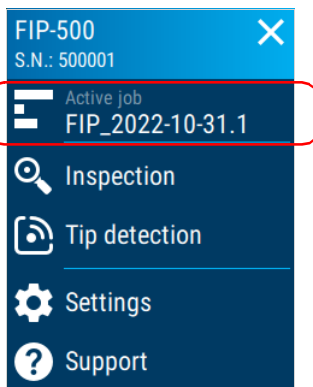

Working With Jobs

Deleting a Job From Your Unit

- From the list of available jobs, if it is not already selected, tap the job name you want to delete.

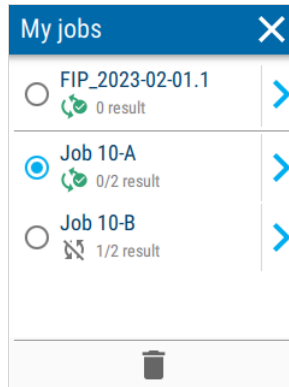

- Tap the garbage can icon at the bottom of the screen.

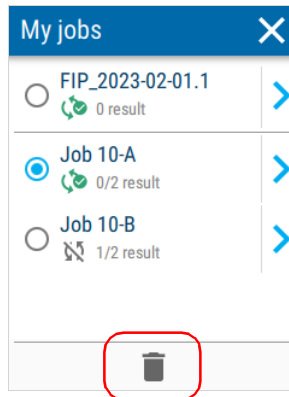

A confirmation message appears asking you to confirm. After you confirm, the job is deleted from the list.

Synchronizing Job Results With a USB Connection

If desired or if your unit does not have wireless capabilities, you can synchronize the job results saved on the unit with a PC using a USB connection. With FastReporter 3, you can perform post-processing tasks and generate reports. You can download the latest version of FastReporter 3 from the EXFO website.

To synchronize job results with a USB connection:

- 1.** Using a USB cable, connect the unit to a PC that has FastReporter 3 already installed.
- 2.** From FastReporter 3, select the **Instrument** tab.
- 3.** To synchronize job results, see EXFO's FastReporter 3 documentation for more detailed information.

Synchronizing Job Results With a Wi-Fi Connection

If your unit has wireless capabilities, you can synchronize the job results saved on the unit with a PC using a Wi-Fi connection. With FastReporter 3, you can perform post-processing tasks and generate reports. You can download the latest version of FastReporter 3 from the EXFO website.

Note: *Both the unit and the PC you are using must be connected to the same Wi-Fi network.*

To synchronize job results with a Wi-Fi connection:

- 1.** If you have not already done so, turn on your unit, the PC and the FastReporter 3 application.
- 2.** Make sure your unit and PC are connected to the same wireless network. For more information, see *Connecting to a Wireless Network From Your Unit* on page 112.
- 3.** From FastReporter 3, select the **Instrument** tab.
- 4.** To synchronize job results, see EXFO's FastReporter 3 documentation for more detailed information.

6 Inspecting Fiber Ends

You can inspect fiber ends and view the result of this inspection directly on the built-in touchscreen of your unit.



WARNING

- Never look directly into a live fiber. It could cause serious eye damage. Always use your FIP-500 Fiber Inspection Scope.
- To protect your eyes, do not stare into the violet light that comes out of your unit.

Selecting the Connector and Interface Types

Once its initialization is complete, the unit displays the inspection screen from which you can select the connector type (single-, duplex- or multi-fiber) as well as the interface (connector or fiber stub transceiver) for the next capture.

- Selecting the single- or duplex-fiber connector type allows you to inspect single- or duplex-fiber connectors or transceivers such as the LC, FC and SC.

- Selecting the multi-fiber connector type allows you to inspect multi-fiber connectors or fiber stub transceivers such as the MPO, MTP® connector, OptiTip™ and Q-ODC.

By default, the auto-detect fiber layout (MF) is selected. With this selection, your unit automatically detects the fiber layout when you perform a capture. You can also select a pre-defined or custom fiber layout that will correspond to the connector you need to inspect. The application displays a graphical representation for each fiber layout available. It also displays the used and unused fibers in the connector.

Depending on the patch panel you are inspecting, the SmarTip can be positioned in two different ways (key up or key down). By default, the key up orientation is selected, but you can change it according to your work environment.

Note: *Only the fibers identified as used will be analyzed.*

Inspecting Fiber Ends

Selecting the Connector and Interface Types

To select the connector and interface types:

1. From the inspection screen, tap **SF** (single-fiber connector type), **DF** (duplex-fiber connector type), **MF** (multi-fiber connector type is automatically detected) or the numbers corresponding to the fiber layout (multi-fiber type connector selected).

The multi-fiber connector type is automatically detected by default (MF)

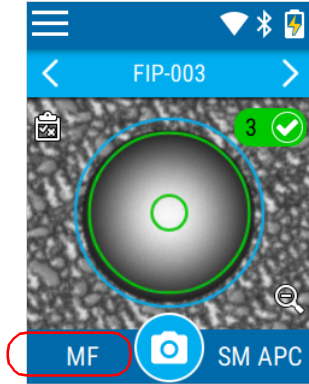

2. In the **Connector type** screen, select the type of connector. The **Layout** and **Key orientation** menus are available for a multi-fiber connector type selection only. If you only work with single- and duplex-fiber connector types, proceed to step 11 for information on selecting the type of interface.

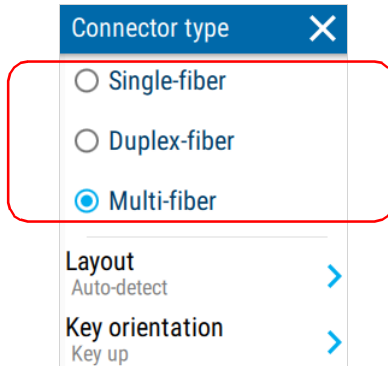

3. Tap **Layout** to select the fiber layout corresponding to the connector you want to inspect.

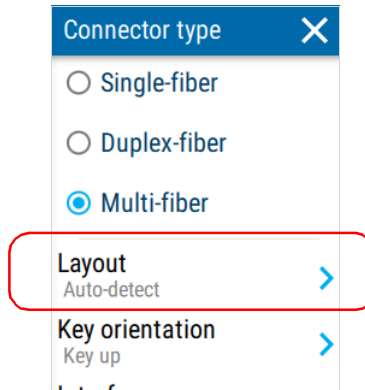

4. If you want to have your unit automatically detect the fiber layout, select **Auto-detect**. Otherwise, select the available fiber layout corresponding to the connector you want to inspect. Once you have made your selection, tap  and proceed to step 9. If you did not find the fiber layout, proceed to step 5 to configure your own layout.

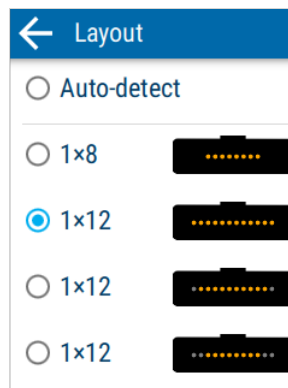

Inspecting Fiber Ends

Selecting the Connector and Interface Types

5. If the fiber layout you wish to inspect is not in the list, scroll down to the custom layout option at the bottom of the screen. Tap the blue arrow to configure your custom fiber layout.

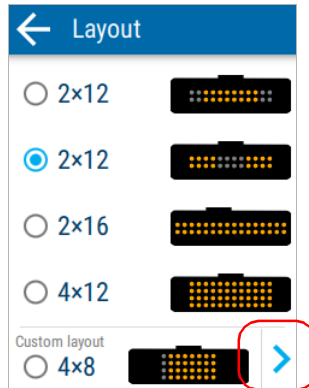

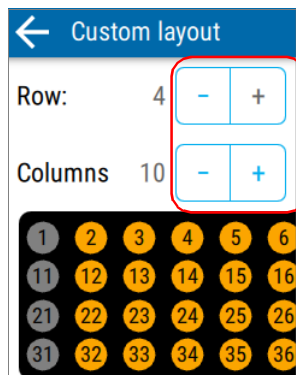

6. Using the + and - buttons, select the number of rows and columns for your custom fiber layout. You can set a minimum of 1 row and 1 column, and a maximum of 4 rows and 16 columns.

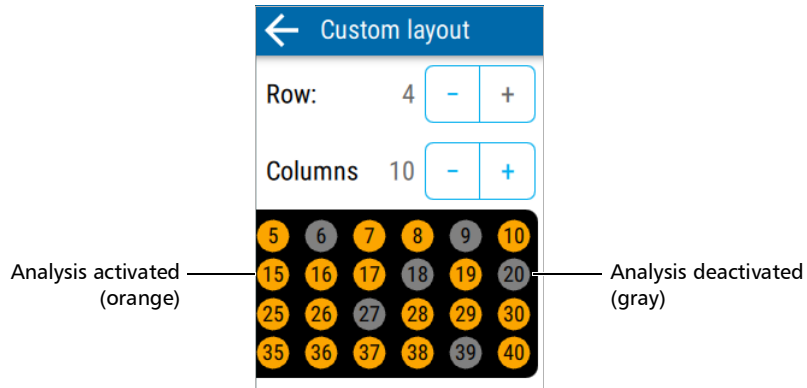

Note: When you add a row, the activation status of the fibers on the new row are duplicated from the previous row. When you remove a row, the last row is removed. When you add a column, the analysis is activated by default for all fibers. When you remove a column, the last column is removed.

7. Tap a fiber number to activate its analysis status (orange) or deactivate its analysis status (gray). If necessary, swipe left or right on the screen to see the entire layout. Tap  to return to the Layout menu.



8. Tap the radio button to select your custom fiber layout. Tap  to return to the Connector type menu.



Inspecting Fiber Ends

Selecting the Connector and Interface Types

9. Tap **Key orientation** to choose the type of orientation for the key.

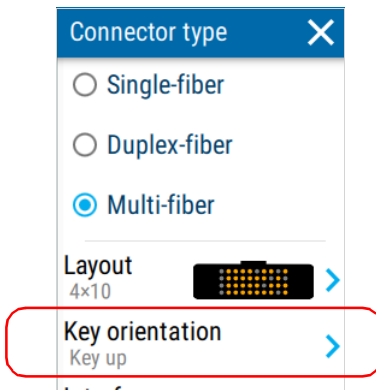

10. Select either **Key up** or **Key down**. Tap  to return to the Connector type menu.

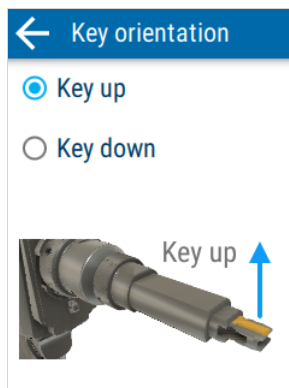

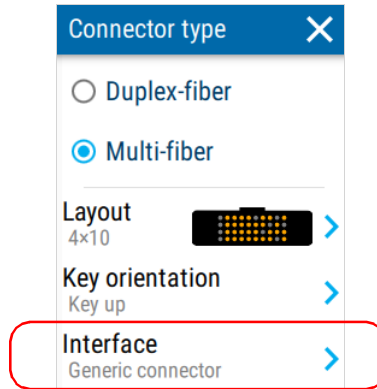

- 11.** To select or change the type of interface corresponding to the connector you want to inspect, tap **Interface**.

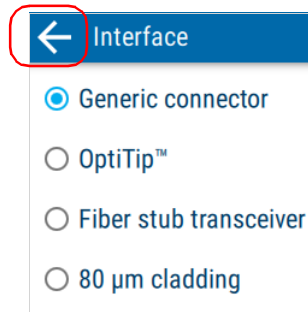

- 12.** Select the type of interface you want to use. Tap  to return to the Connector type menu.



The new settings will be taken into account for the next inspection.

Note: In the lower left-hand corner of the inspection screen, an  icon appears for an OptiTip™ selection (multi-fiber only), a  icon appears for a Fiber stub transceiver selection, and an  icon appears for an 80 μm cladding selection.

Inspecting Fiber Ends

Selecting the Fiber Type

Selecting the Fiber Type

Your unit allows you to inspect singlemode and multimode fiber connectors.

The fiber type that you select for single-fiber connectors is independent of the one that you select for multi-fiber connectors. This means that you can select different fiber types if necessary to better suit your test environment. Both selections are kept in memory even when you turn the unit off.

The possible fiber types for these connectors are listed below.

| Fiber Type | Features |
|--|--|
| Singlemode (single-fiber connectors only) | Corresponds to singlemode fiber with a PC or UPC connector. Fiber type selected by default. Fiber jacket is usually yellow and connector is dark blue. |
| Singlemode APC | Fiber type selected by default for multi-fiber connectors. Fiber jacket is usually yellow and connector is green. |
| Multimode OM1 | Modal bandwidth: 200-500 MHz·km. Fiber channel designation: M6. Fiber jacket is orange or slate. |

| Fiber Type | Features |
|-------------------|--|
| Multimode OM2 | Modal bandwidth: 500 MHz·km. Fiber channel designation: M5. Fiber jacket is orange. |
| Multimode OM3 | Modal bandwidth: 1500-2000 MHz·km. Laser optimized (VCSEL) at 850 nm. Fiber channel designation: M5E. Fiber jacket is aqua. |
| Multimode OM4 | Modal bandwidth: 3500-4700 MHz·km. Laser optimized (VCSEL) at 850 nm. Fiber channel designation: M5F. Fiber jacket is aqua or violet. |
| Multimode OM5 | Modal bandwidth: 3500-4700 MHz·km. Wideband multimode from 850-953 nm. Fiber jacket is violet or lime green. |

As you select the fiber type for your inspection, your unit displays the typical colors of singlemode and multimode fiber jackets to help you identify it.

Inspecting Fiber Ends

Selecting the Fiber Type

To select the fiber type:

1. From the inspection screen, tap the fiber type.

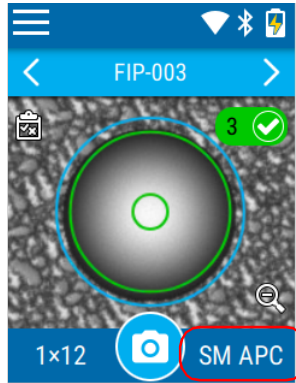

2. In the **Fiber type** screen, select the desired type of fiber. If you are not sure whether your setup uses singlemode or multimode fiber, you can have a look at the color chart displayed on the screen.

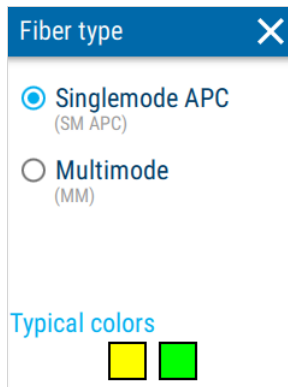

The new settings will be taken into account for the next inspection.

Inspecting Single-, Duplex- and Multi-Fiber Connectors

Your unit allows you to inspect single-, duplex- and multi-fiber connectors. Before beginning to inspect fiber ends, you must first ensure that the appropriate optical head is installed on your unit.

You must ensure that the SmarTip installed on your unit corresponds to the type of connector that you need to inspect. You must also select the proper fiber type (ex.: singlemode APC) in the application.

There are several types of inspection modes currently available with your unit.

For more information on the inspection modes and how to select them, see *Selecting the Inspection Mode* on page 36.



Note: *A camera icon in the upper right-hand corner indicates you are currently viewing a connector in Live mode  and not a static image of a connector.*

To inspect single-, duplex- and multi-fiber connectors:

1. If applicable, ensure that the proper optical head is installed on your unit (see *Changing Your Unit's Optical Head* on page 27).
2. Ensure that the proper SmarTip is installed on your unit (see *Changing Your Unit's SmarTip* on page 21).
3. Select the desired connector type, including the fiber layout and key orientation (multi-fiber inspection), as well as the interface. For more information, see *Selecting the Connector and Interface Types* on page 73.
4. Select the desired fiber type. For more information, see *Selecting the Fiber Type* on page 80.

Inspecting Fiber Ends

Inspecting Single-, Duplex- and Multi-Fiber Connectors

5. Insert the connector that you want to inspect into the tip of your unit. In Auto mode, the capture process begins automatically if you are in the inspection screen.
6. Pull the trigger located on the handle of the unit or tap  to begin the capture process. If you wish to stop the capture process, pull the trigger or tap the  button.

The inspection results are displayed on the screen.

If you have disabled the analysis process, a gray icon  is displayed in the inspection screen. Your unit will not provide a pass/fail status for the connectors, detect fibers or display the overlay. You can tap the icon to see information such as the date and time of the capture, and details on the connector type. For more information on activating the analysis process, see *Configuring Pass/Fail Criteria* on page 39.

If a detection error appears, you can tap the  icon for details on the possible reasons and solutions in case of defects or scratches.

For more information on navigation through multi-fiber captures, see *Navigating Through Multi-Fiber Captures* on page 91. For more information on the overlay, see *Displaying or Hiding the Overlay* on page 97.

Note: *If your unit has wireless capabilities and the connectors you are inspecting are part of a job that was created using the EXFO Exchange mobile application, the results will be synchronized and available on the mobile application. For more information on jobs, see *Working With Jobs* on page 63. For more information on working with the EXFO Exchange mobile application, see *Working with the EXFO Exchange Application* on page 99.*

Using the Autofocus in Live Mode

In Live mode, the autofocus is performed in the following situations:

- When you navigate from a test that has already been performed to a new test point where a test has yet to be performed. During this process, the capture button and the navigation arrows are not available. The camera icon is displayed when the unit is ready for a capture.
- When you navigate from one side to the other in multi-fiber mode on the same test point.
- When you switch to another inspection mode, such as from Eco to the Live inspection mode.
- When a connector is inserted into the tip.

Note: *The image is centered automatically on the fiber.*

If you prefer to adjust the focus manually, you can disable the autofocus. For more information, see *Selecting the Inspection Mode* on page 36.

Note: For single- and duplex-fiber inspections in Live mode, you may also tap on the screen to change between three available zoom levels. Your unit maintains the latest zoom level chosen until you reboot your unit.

Inspecting Fiber Ends

Inspecting Single-, Duplex- and Multi-Fiber Connectors

Using the Manual Focus in Live Mode



In Live mode, you can manually adjust the focus quality of the image.

Note: *The image is centered automatically on the fiber.*

To use the manual focus in Live mode:

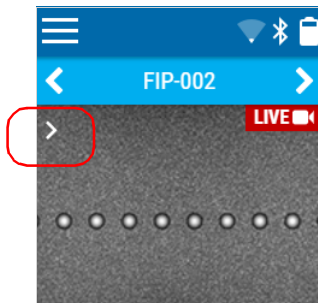
1. Tap the right arrow on the left-hand side to expand the manual focus menu bar.



2. Tap the  or  icons to adjust the image quality to your liking. The gauge changes color according to the focus quality. Green indicates optimal quality, yellow indicates average quality and red indicates poor quality. To accelerate the process, perform a long press on either icon.

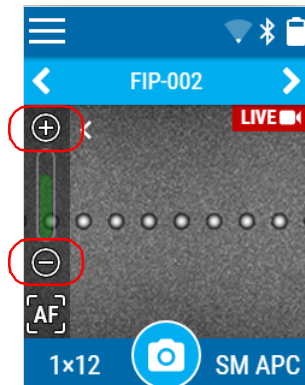

Inspecting Fiber Ends

Inspecting Single-, Duplex- and Multi-Fiber Connectors

3. Tap the **AF** icon at any time to perform an autofocus of the connector side currently displayed.

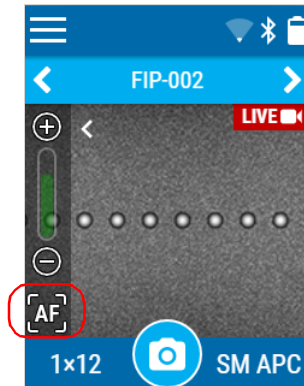

4. Tap the left arrow to collapse the manual focus menu bar.

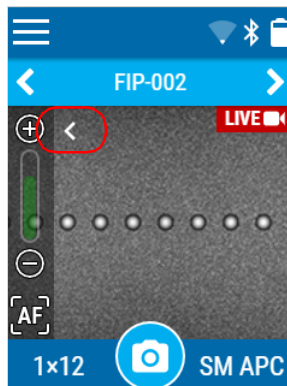

Note: In multi-fiber mode, you can adjust the focus manually for the side (left or right) you are currently viewing. If you swipe left or right, the unit will optimize the new image automatically if the autofocus is enabled in the settings menu.

Inspecting Fiber Ends

Returning to the Live Feed

Returning to the Live Feed

In Live mode, you may want to return to the live feed from a test point where a test has already been performed or when you wish to navigate to a new test point.

To return to the live feed:

Once a capture has been taken, a video camera icon appears instead of the usual camera. Pull the trigger or tap the video camera to return to the live feed at the same test point.

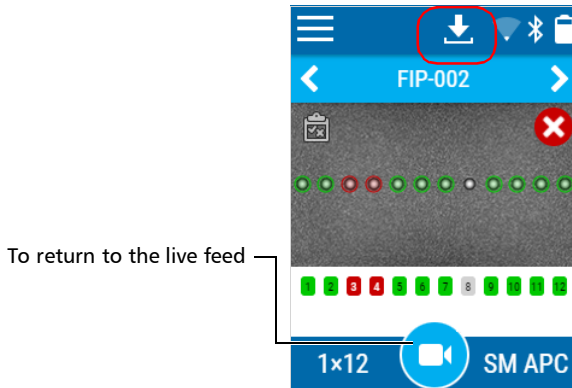

Your unit returns to the live feed. The icon changes to a camera.



Viewing Duplex-Fiber Captures

When you inspect duplex-fiber connectors, once the analysis is complete, the application displays an overview of the connector (where two fibers are visible at a time). It allows you to have a global view of the inspection results as well as a way to localize large debris that could be located outside the perimeter of the fibers themselves.



From this overview, you can access the detailed capture of either inspected fibers that are part of the connector, and vice versa.

From the inspection screen, you can navigate from one fiber to the other.

To navigate between the inspection results:

Tap a fiber number. Swipe left or right on the screen to navigate from one fiber to the other.

To view details of the pass/fail status of the connector:

Tap the corresponding icon:  (pass) or  (fail).

Details such as the date/time, connector type and settings applied for the capture are displayed. If present, you can also tap the  icon to view diagnostic details on the possible reasons and solutions for defects or scratches.

Inspecting Fiber Ends

Viewing Duplex-Fiber Captures

To access the detailed capture of a fiber:

From the overview, tap the image of a fiber or the desired fiber number.

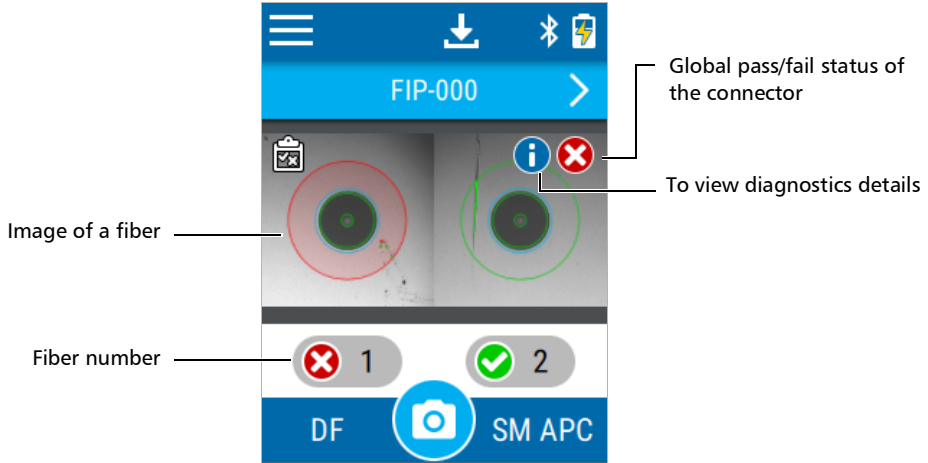

To return to the overview:

From the detailed capture view, tap the  icon.



Navigating Through Multi-Fiber Captures

When you inspect multi-fiber connectors, once the analysis is complete, the application displays an overview of the connector (where several fibers are visible at a time). It allows you to have a global view of the inspection results as well as a way to localize large debris that could be located outside the perimeter of the fibers themselves.

From this overview, you can access the detailed capture of any of the inspected fibers that are part of the connector, and vice versa.

From a specific fiber view, you can navigate to the previous or next fiber on the same row. You can also navigate from one row to another when you work with connectors having a multi-row fiber layout.



To scroll through the inspection results:

Swipe left or right on the screen.

To switch from one fiber row to the other (multi-row fiber layouts):

Swipe up or down on the screen.

To view details of the pass/fail status of the connector:

Tap the corresponding icon:  (pass) or  (fail).

Details such as the date/time, connector type and settings applied for the capture are displayed. If present, you can also tap the  icon to view diagnostic details on the possible reasons and solutions for defects or scratches.

If you have disabled the analysis process, a gray icon  is displayed in the inspection screen. Your unit will not provide a pass/fail status for the connectors, detect fibers or display the overlay. You can tap the icon to see information such as the date and time of the capture, and details on the connector type. For more information on activating the analysis process, see *Configuring Pass/Fail Criteria* on page 39.

Inspecting Fiber Ends

Navigating Through Multi-Fiber Captures

To access the detailed capture of any of the inspected fibers:

From the overview, tap the image of the fiber (small circle) or the desired fiber number.

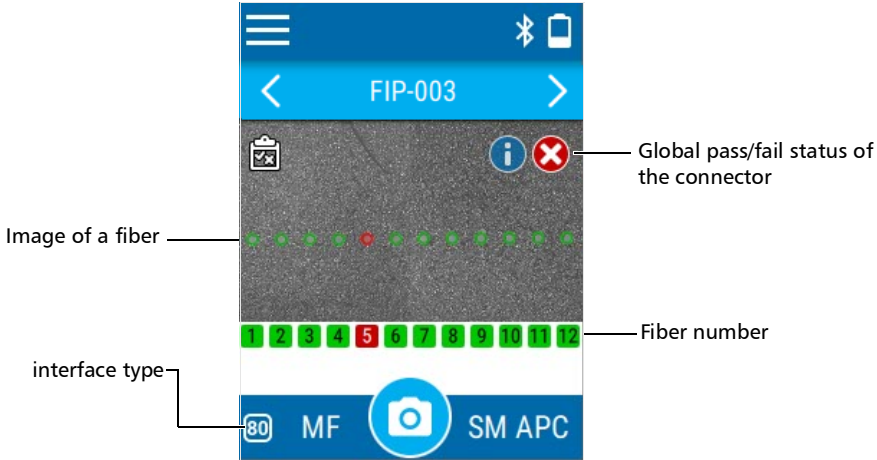

To return to the overview:

From the detailed capture view, tap the  icon.

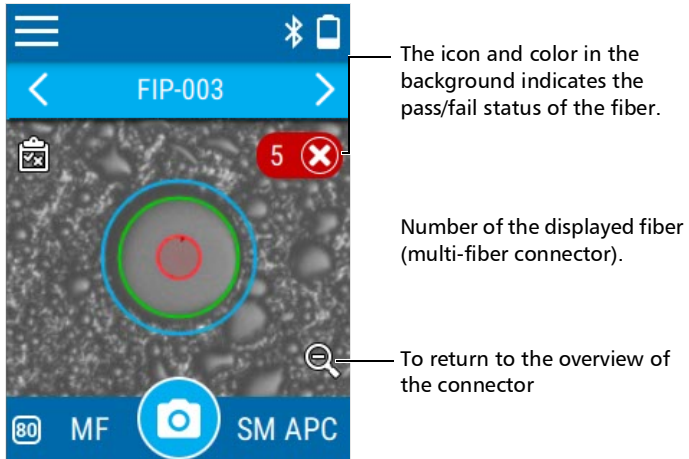

Understanding the Unit's Behaviour When Saving Results

You can define your unit's behavior once the analysis process is complete. For default jobs, you can choose to have your unit always automatically save results, never save results or only save results with a pass status.

Note: *If the job was created using the EXFO Exchange mobile application, the results are saved automatically.*

For more information on the auto save feature, see *Configuring the Auto Save* on page 43. For more information on jobs, see *Working With Jobs* on page 63.

You can also define your unit's behavior once the saving process is complete. You can choose to have your unit always automatically navigate to the next test point, never navigate to the next test point or only navigate to the next test point when you save a result with a pass status. For more information on the auto navigation feature, see *Configuring the Auto Navigation* on page 45.

If you attempt to save a new capture on a test point that has already been saved, a warning message is displayed allowing you to either overwrite the saved result or cancel the operation.

If you tap a navigation arrow without saving the current result, you will be prompted to either save the test or discard it. You also have the option of canceling this operation by tapping the 'X' in the upper right-hand corner.

Note: *If your unit reaches 95 % storage capacity, you will be prompted to transfer existing captures and clear all of the data. You can still take captures without saving them and losing any data.*

Inspecting Fiber Ends

Understanding the Unit's Behaviour When Saving Results

To save the current capture:

Tap the  icon.

Your unit either stays on the current test point or navigates to the next one, depending on your unit's current selection for auto navigation:

- Never
- Only if pass
- Always

Note: *If the result you save is the last test point in the job, your unit does not navigate to another test point.*

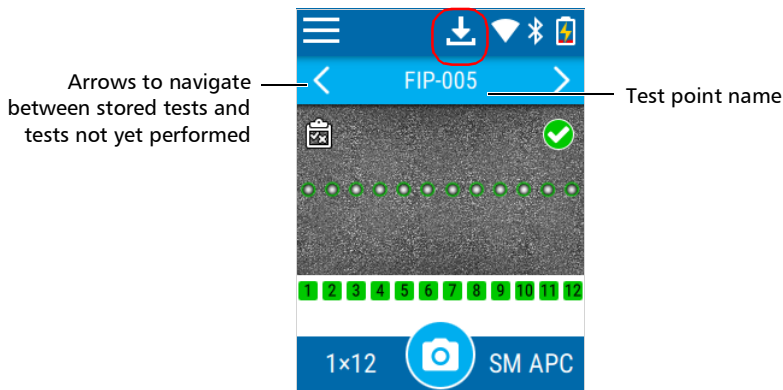

Navigating Through Saved Tests

You can navigate from one test to another through the tests saved on your unit by tapping on one of the arrows below the menu bar:

- You can navigate from one saved test point to another. If you tap an arrow without saving the current test, you will be prompted to either save the test or discard it.
- You can also accelerate the navigation between saved test points. The navigation stops automatically at a changed state. More specifically, the unit navigates quickly through saved tests and stops at the first test point ready for a new capture. Conversely, the unit navigates quickly through test points and stops at the first saved test it encounters.

You can also view additional information on stored tests.

Note: *When you turn on the unit, the first test point not associated with a saved test will be displayed.*

To navigate from one test result to another:

Tap the left or right arrow to move between stored tests or test points.

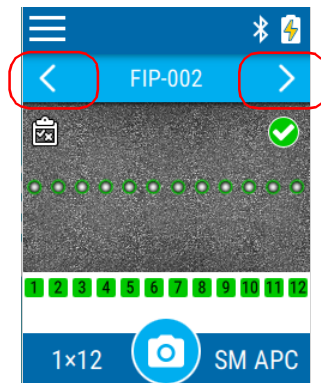

Note: *You can also swipe the screen left and right with the same results.*

Inspecting Fiber Ends

Navigating Through Saved Tests

To accelerate the navigation between saved tests or test points:

Keep your finger on the left or right arrow. The navigation accelerates between saved tests or test points and stops automatically at a changed state.

To view additional information on saved tests:

1. To view additional information pertaining to a particular test result, perform a long press on a test point name.

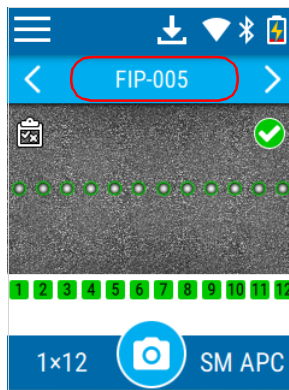

2. The complete test name is displayed in a ribbon.

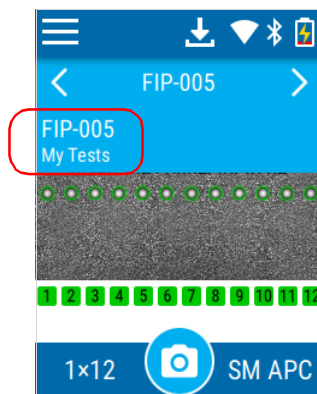

3. Tap on the ribbon again to close it.

Displaying or Hiding the Overlay

The overlay is shown by default after an analysis. The application displays a circle around each of the active fibers.

The overlay shows the status of the analysis, the status per zone, the analysis zones and any anomaly (defects and scratches) found on the fiber end-face. The different regions on a fiber such as the core, the cladding and the adhesive are represented with circles.

The color of the circles shows the status of the analysis zone:

- green: pass
- red: fail
- blue: no analysis performed

The overlay applied on a specific fiber in a multi-fiber connector is independent from the overlay of the whole connector. You can show or hide the overlay from the connector overview (where several fibers are visible at a time) or from the view showing a specific fiber.

Note: *If you have disabled the analysis process, the overlay will not be displayed in the inspection screen. For more information, see [Configuring Pass/Fail Criteria](#) on page 39.*

To display or hide the overlay:

Tap the  icon.

OR

Tap either anywhere in the non-active area (gray background) of the image or directly on the image of the fiber when you view a specific fiber.

Inspecting Fiber Ends

Turning on or Turning off the Flashlight

Turning on or Turning off the Flashlight

Your unit comes equipped with a dual-function LED that can serve as a flashlight to help you locate the connectors. This is particularly useful when the environment in which you must perform the inspection is dark.

To turn on or turn off the flashlight:

1. From the main menu, tap **Settings**.

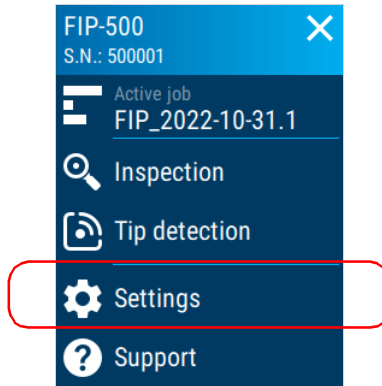

2. Turn on or turn off the flashlight with the corresponding toggle.

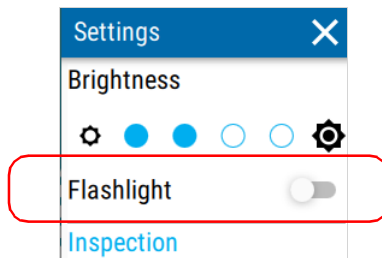

3. Close the **Settings** page to return to the inspection screen.

Note: You can also turn on or turn off the flashlight on your unit from the control center menu. For more information, see *Using the Control Center* on page 20.

7 Working with the EXFO Exchange Application

If your FIP-500 has wireless capabilities, you can use it in association with a smart device equipped with the EXFO Exchange application allowing you to retrieve the software updates and send captures to EXFO for technical support.

Note: *The appearance of the EXFO Exchange application may vary slightly from the illustrations presented in this documentation depending on the type of smart device you are using. Unless otherwise specified, the information applies both to the Android- and iOS-based smart devices.*

Installing the EXFO Exchange Application on Your Smart Device

Before you start working, if you intend to retrieve the software updates for your unit, you will need to install the EXFO Exchange application on your smart device.

To install the EXFO Exchange application:

1. Ensure that you have access to an Internet connection.
2. From your Android-based smart device, open the Google Play Store (usually **Play Store** or **Play** icon).

OR



From your iOS-based smart device, open the App Store (usually **App Store** icon).

3. From the Play Store or the App Store, search for *EXFO* or *EXFO Exchange* to localize the EXFO Exchange mobile application.
4. Start the installation and follow the on-screen instructions.

Establishing or Closing a Connection With a Smart Device Via the Bluetooth Technology

When you want to configure Wi-Fi networks to receive updates for your unit, interactions are necessary between the unit and a smart device equipped with the EXFO Exchange application. These interactions are accomplished using the Bluetooth Low Energy technology. By default, the Bluetooth communication is enabled on your unit, but if you have disabled it, you must enable it before trying to connect to a smart device (see *Enabling or Disabling the Wireless Communication* on page 105).

On your FIP-500 unit, the status of the Bluetooth communication is indicated with an icon in the title bar. The table below shows the possibilities.

| Icon | Meaning |
|---|---|
| Not visible | The Bluetooth communication is disabled. |
|  | The Bluetooth communication is enabled, but no connection has been established yet between the unit and a smart device. |
|  | A connection has been established between the unit and a smart device. |

If a connection has been established with a smart device already, but you wish to use your unit with another smart device, you can close the current connection directly from your unit.

Working with the EXFO Exchange Application

Establishing or Closing a Connection With a Smart Device Via the Bluetooth Technology

To establish a connection via the Bluetooth technology:

- 1.** If necessary, enable the Bluetooth communication on your unit (see *Enabling or Disabling the Wireless Communication* on page 105).
- 2.** If it is not already done, install the EXFO Exchange application on your smart device (see *Installing the EXFO Exchange Application on Your Smart Device* on page 99).
- 3.** On the smart device, establish the connection as follows.
 - 3a.** Open the EXFO Exchange application.
 - 3b.** From the **Test units** screen, tap the **CONNECT A TEST UNIT** button.



Working with the EXFO Exchange Application

Establishing or Closing a Connection With a Smart Device Via the Bluetooth Technology

- 3c.** From the list of FIP-500 units, tap the item corresponding to the desired unit.

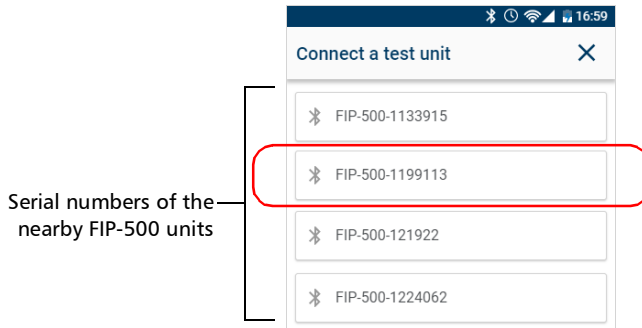

- 4.** On your FIP-500 unit, when you are prompted, tap **ACCEPT** to authorize the pairing with the smart phone

The application establishes the communication automatically.

Note: *When the connection is successful, the  icon remains displayed in the title bar of your FIP-500 unit. The unit (identified with its serial number) is added to the list of test units in the EXFO Exchange application.*

Note: *If the FIP-500 unit that you want to use is already connected to another smart device, you must first close the connection between the FIP-500 unit and the other smart device before being able to see it on the list of the nearby FIP-500 units.*

Working with the EXFO Exchange Application

Establishing or Closing a Connection With a Smart Device Via the Bluetooth Technology

To close the connection with a smart device from your unit:

1. From the main menu, tap **Settings**.

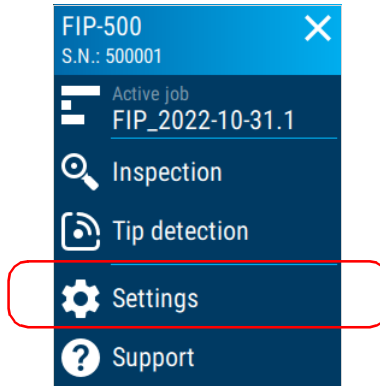

2. From the **Wireless** section, tap **Disconnect mobile app**.

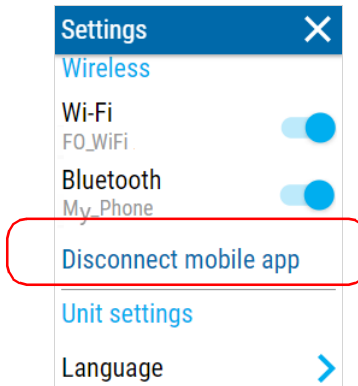

3. When the application prompts you, confirm the disconnection by tapping **YES**.

Note: *A new pairing will be required the next time you want to work with the disconnected smart device.*

Working with the EXFO Exchange Application

Establishing or Closing a Connection With a Smart Device Via the Bluetooth Technology

To close the connection with an FIP-500 from a smart device:

1. From the **Test units** screen, tap the line corresponding to your FIP-500 unit.

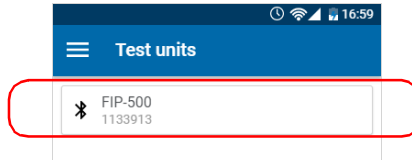

2. Tap **FORGET THIS TEST UNIT**.

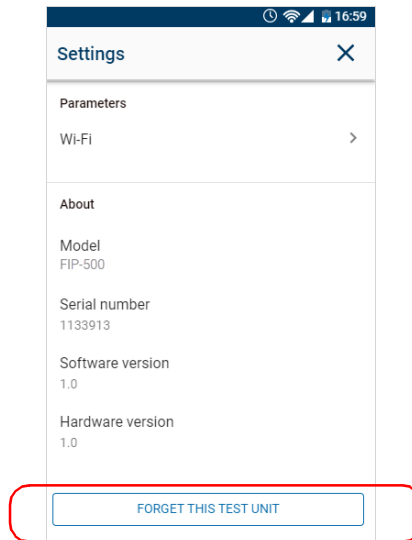

The smart device is no longer connected to the FIP-500 and you are ready to connect it to another unit.

Enabling or Disabling the Wireless Communication

The interactions between your unit and a smart device are accomplished using the Bluetooth Low Energy technology.

The interactions between your unit and the EXFO update services (to retrieve software updates), are accomplished using a connection to a wireless network.

By default, the Bluetooth communication is enabled on your unit, but the Wi-Fi is not.

You can enable or disable the Bluetooth communication from your unit only, and the Wi-Fi communication both from your unit and from the EXFO Exchange application.

If you do not need to connect to a wireless network for a certain period of time, you may wish to disable the Wi-Fi communication to save battery power.

Working with the EXFO Exchange Application

Enabling or Disabling the Wireless Communication

To enable or disable the wireless communication from your unit:

1. From the main menu, tap **Settings**.

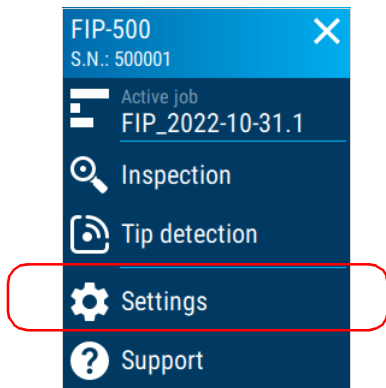

2. From the **Wireless** section, use the **Wi-Fi** or **Bluetooth** toggle to enable or disable the communication as needed.

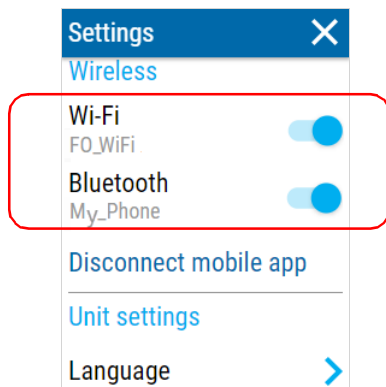

The changes are taken into account immediately.

Note: You can also enable or disable the wireless communications on your unit from the control center menu. For more information, see *Using the Control Center* on page 20.

Working with the EXFO Exchange Application

Enabling or Disabling the Wireless Communication

To enable or disable the Wi-Fi communication from the smart device:

1. Ensure that a Bluetooth connection has already been established between your unit and a smart device (see *Establishing or Closing a Connection With a Smart Device Via the Bluetooth Technology* on page 100).
2. On the smart device, open the EXFO Exchange application.
3. From the **Test units** screen, tap the line corresponding to your FIP-500 unit.

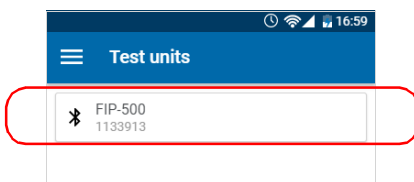

4. Tap **Wi-Fi**.

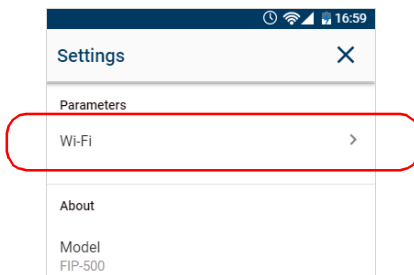

5. Use the **Wi-Fi** toggle to enable or disable the Wi-Fi communication.



The change is taken into account immediately.

Working With a Wireless Network

Note: *You need a smart device equipped with the EXFO Exchange application to configure a wireless network to which your unit will be able to connect later.*

By connecting your unit to a wireless network, you can check for updates, download these updates and install them directly from your unit (see *Updating Software With a Wi-Fi Connection* on page 145).

By default, the Wi-Fi connection is disabled on the FIP-500 unit. You must enable it before trying to connect to a wireless network (see *Enabling or Disabling the Wireless Communication* on page 105).

A Wi-Fi connection is necessary to send raw data of the latest captures to technical support, if necessary.

Before being able to connect your unit to a Wi-Fi network, you must first configure the desired networks with the EXFO Exchange application.

Your unit supports IPv4 wireless routers having the following characteristics:

- With dynamic IPv4 address assignment
- Not secured, or secured with WPA/WPA2-Personal standards (WPA-PSK/WPA2-PSK versions)
- Broadcasting their network names (SSID) or not (SSID visible or hidden)
- Configured with a 2.4 GHz Wi-Fi band (b/g/n frequencies).



Note: *Your unit does not support the WEP and WPS standards.*

Note: *Your unit does not support public Wi-Fi hotspots requiring authentication from a Web page.*

Note: *Every work environment has its own specifications. If you need information about the configuration of your router, contact your network administrator.*

Note: *To save battery power, you may wish to disable the wireless communication when you do not use it.*

The information about the Wi-Fi connection is indicated with an icon appearing both in the title bar (on your unit) and next to the name of the wireless networks (in the EXFO Exchange application). The table below shows the possibilities.

| Icon | Meaning |
|--|--|
| No Wi-Fi icon visible in the title bar | The Wi-Fi communication is disabled. |
|  | The Wi-Fi communication is enabled, but the unit is not connected to any wireless network. |
|  | The portion of the icon that appears in white (title bar) or in dark gray (list of wireless networks) reflects the strength of the signal. |
|  | Password-protected (secured) networks are identified by a lock in the list of wireless networks (EXFO Exchange). |

Configuring a Wireless Network

Before being able to connect your unit to a Wi-Fi network, you must first configure the desired networks with the EXFO Exchange application. Once the configuration and first connection are successful, the configured network is automatically added to the list of possible networks on your unit.

The list of configured networks as well as the last network used are kept in memory for future use even when you turn your unit off.



IMPORTANT

You must first establish a Bluetooth connection between your unit and a smart device before attempting to configure a Wi-Fi network.

To configure a wireless network:

1. Ensure that a Bluetooth connection has already been established between your unit and a smart device (see *Establishing or Closing a Connection With a Smart Device Via the Bluetooth Technology* on page 100).
2. If necessary, enable the Wi-Fi communication on your unit (see *Enabling or Disabling the Wireless Communication* on page 105).
3. On the smart device, open the EXFO Exchange application.

4. From the **Test units** screen, tap the line corresponding to your FIP-500 unit.

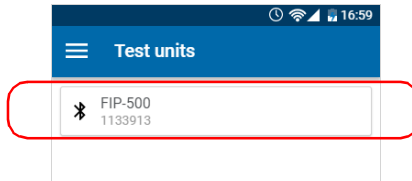

5. Tap **Wi-Fi**.

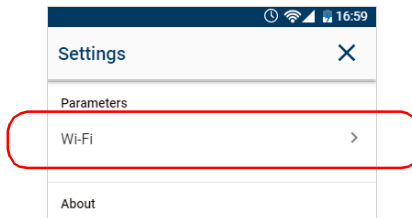

6. Tap the item corresponding to the wireless network that you want to configure.

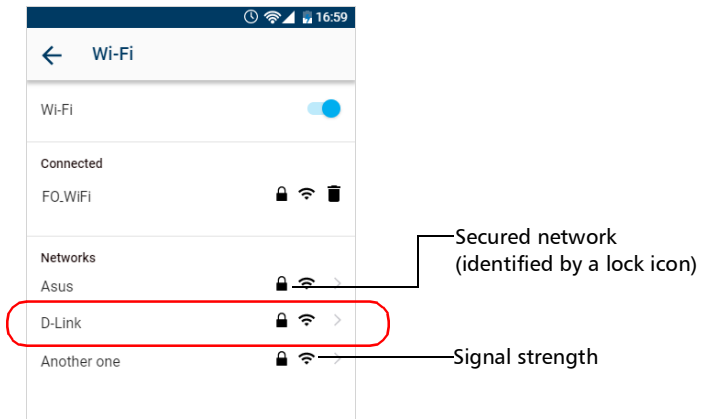

Working with the EXFO Exchange Application

Working With a Wireless Network

7. If the network is protected by a network security key (password), enter it.

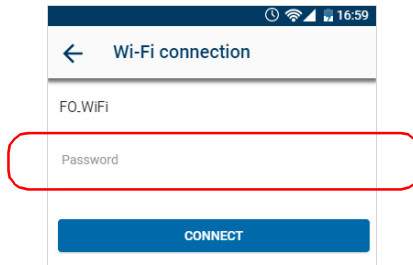

8. Tap **CONNECT**.
9. Follow the on-screen instructions.

The application establishes the communication automatically.

Connecting to a Wireless Network From Your Unit

When you start a new work session with your unit, it will automatically connect to the last network used, unless this network is not available or its password has changed in the meantime (reconfiguration necessary). In this case, your unit will try to establish a connection with another network you have previously configured.

To connect to a wireless network from your unit:

1. Ensure that a connection has already been established between your unit and a smart device via the Bluetooth technology (see *Working With a Wireless Network* on page 108).

2. From the main menu, tap **Settings**.

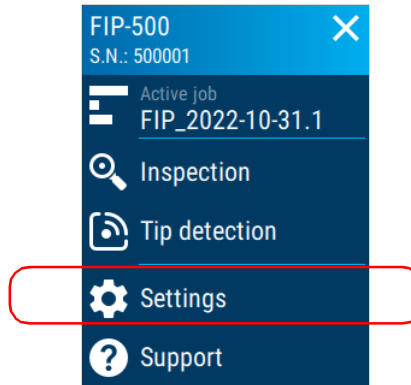

3. If it is not already done, enable the Wi-Fi communication on your unit using the corresponding toggle.

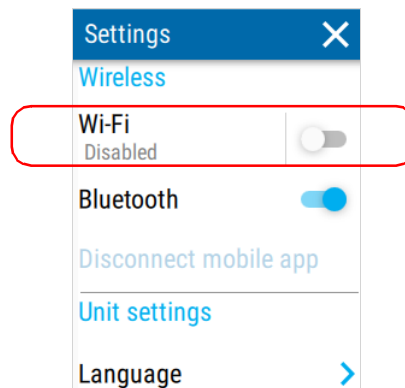

4. Tap **Wi-Fi**.

Working with the EXFO Exchange Application

Working With a Wireless Network

5. Under **Available networks**, tap the item corresponding to the wireless network to which you want to connect.

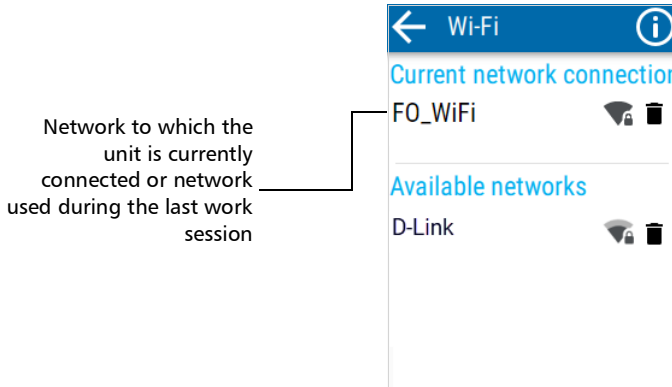

The application establishes the communication automatically.

Note: *If a Wi-Fi network you have already configured is no longer available, your unit will automatically connect to the Wi-Fi network with the strongest signal available from the list of current configured networks.*

Removing a Configured Network From Your Unit

You can remove configured networks from the list to prevent automatic connections to these networks (forget network feature). If you remove the network currently in use, the unit (or the EXFO Exchange application) will try to connect to the next configured network on the available list.

On your unit, removed networks are no longer visible unless you reconfigure these networks from the EXFO Exchange application. If these networks are still in range, they will reappear on the list of available networks as if they have never been configured before. This means that for secured networks, their passwords will need to be re-entered if you decide to reconfigure these networks.

To remove a configured network from the list:

1. From the main menu, tap **Settings**.

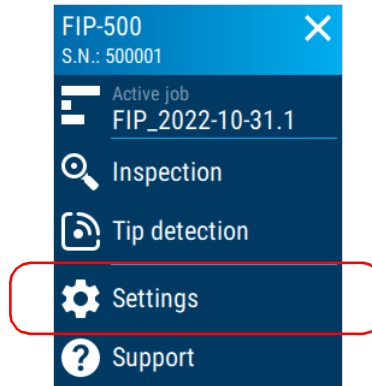

OR

From the EXFO Exchange application, tap the line corresponding to your FIP-500 unit.

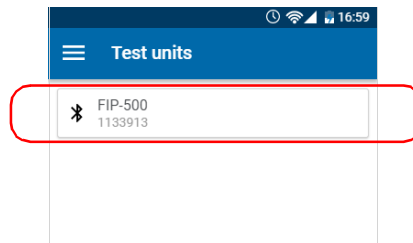

Working with the EXFO Exchange Application

Working With a Wireless Network

2. Tap **Wi-Fi**.

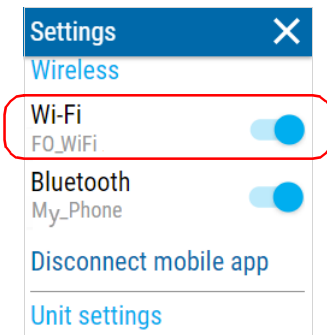

3. Tap the icon corresponding to the wireless network that you want to remove.

Network to which the unit is currently connected or network used during the last work session



4. When prompted by the application to confirm the removal of the network, confirm by tapping **FORGET**.

The network is removed from the list automatically.



In the EXFO Exchange application, if these networks are still in range, they will reappear on the list of available networks at the bottom of the page.

Synchronizing Job Results With the Smart Device and the Cloud Server

The EXFO Exchange mobile application manages the measurements associated with jobs automatically for you.

The synchronization of the results is done in two steps. You can start the synchronization process as soon as a Bluetooth connection is established between your unit and the smart device. Test results are sent to the mobile application. By sending the results to the EXFO Exchange mobile application, you can synchronize the entire job or the tests already done in a job. This way, you can resume a job that has already been started by someone else on another unit. You cannot view the details for the tests already completed and transferred from another unit.

Note: *You can transfer results with or without images. You can enable or disable this feature from the Settings menu in the EXFO Exchange mobile application.*

Note: *You may receive a job on your unit from the EXFO Exchange application that contains test points with saved captures that were performed on another unit. The results for each of these test points are not available locally on your unit. In this case, each test point contains a message indicating that the results are not available on your unit. You can tap the verdict icon:  or  to see the date and time of the capture.*

8 **Maintenance**

To help ensure long, trouble-free operation:

- Always inspect fiber-optic connectors before using them and clean them if necessary.
- Keep the unit free of dust.
- Clean the unit casing and front panel with a cloth slightly dampened with water.
- Store unit at room temperature in a clean and dry area. Keep the unit out of direct sunlight.
- Avoid high humidity or significant temperature fluctuations.
- Avoid unnecessary shocks and vibrations.
- If any liquids are spilled on or into the unit, turn off the power immediately, disconnect from any external power source, remove the batteries and let the unit dry completely.



WARNING

The use of controls, adjustments and procedures, namely for operation and maintenance, other than those specified herein may result in hazardous radiation exposure or impair the protection provided by this unit.

Cleaning Lenses

Keeping your unit's lenses clean and free of contaminants such as dust particles, greasy substances and fingerprints will ensure that you get the optimum performance out of your unit.

The proper autodetection of ferrules is particularly sensitive to the presence of greasy substances and fingerprints on lenses of optical heads. These contaminants are harder to detect than dust particles.

The following recommendations will help you with the cleaning process:

- With a filtered air blower or a soft bristled brush, remove as much dust and dirt as possible.
- Apply a few drops of cleaning solution, which is used to clean camera lenses, on a lens tissue, a cleaning cloth or a lint-free swab. The lens cleaning solution especially manufactured by camera lens manufacturers can be used safely. Reagent grade isopropyl alcohol as well as deionized water can also be used safely.
- Gently remove oil, fingerprints and grime from the lens surface, using a circular motion from the center outwards.



IMPORTANT

EXFO recommends to clean the lenses only when necessary, beginning with the parts that are the most exposed to dust and dirt. For example, the lens that is located at the end of the optical head (just behind the SmarTip) can need cleaning, but not the other lenses.

Attempting to clean lenses that do not need cleaning, especially without the right tools or method, can worsen a situation.

To clean lenses:

1. If necessary, turn off your unit and remove the protective cap.
2. Turn the SmarTip retaining nut counterclockwise until the pins are aligned with the widest part of the SmarTip anchoring slots.

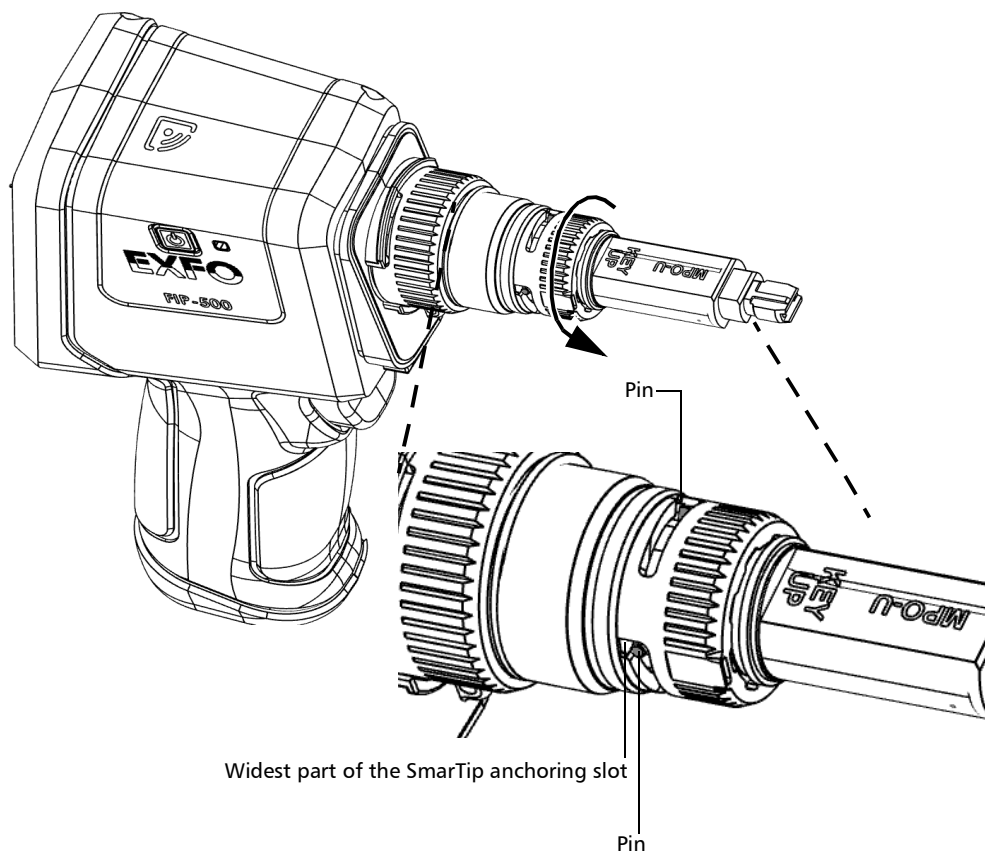

Maintenance

Cleaning Lenses

3. Pull on the SmarTip to remove it.

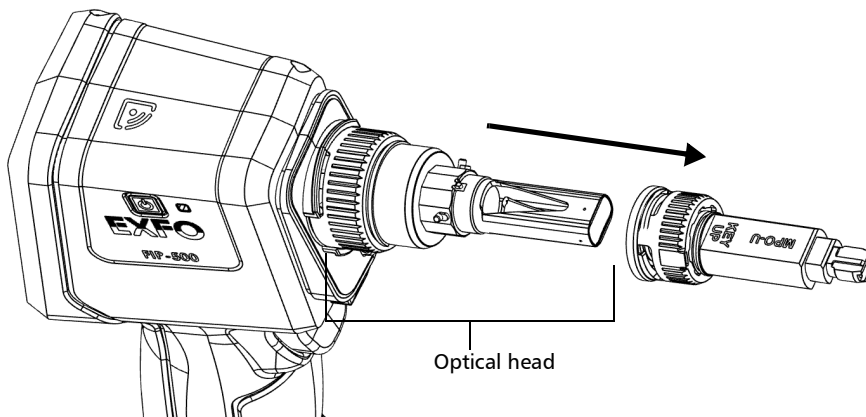

4. Clean the lens that is located at the end of the optical head.

Multi-fiber optical head

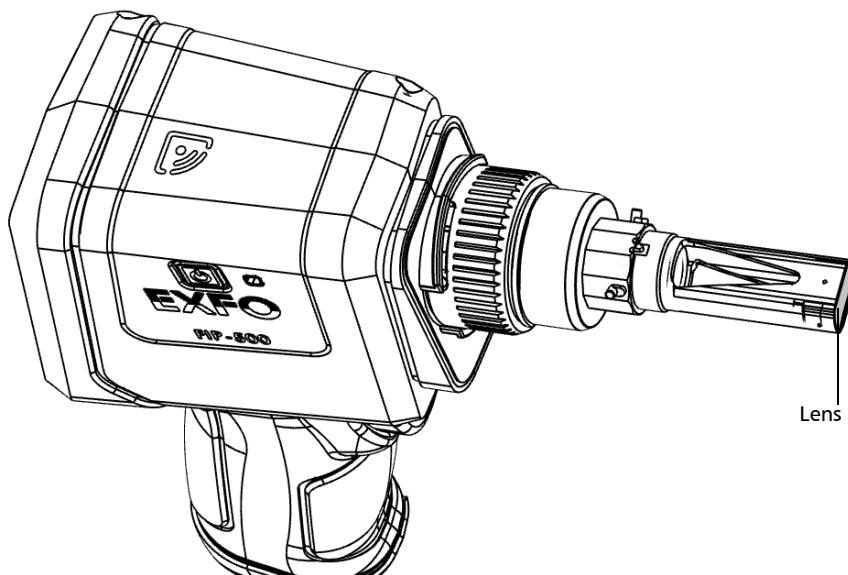

Single-fiber optical head

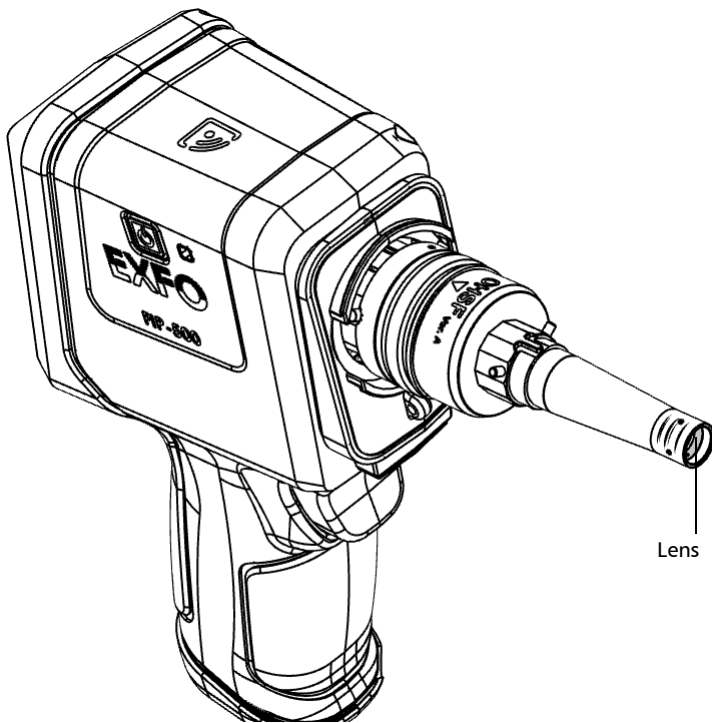

Maintenance

Cleaning Lenses

5. Slightly turn the optical head retaining nut counterclockwise to release it from your unit (the pins on the unit will be aligned with the widest part of the anchoring slots on the optical head).

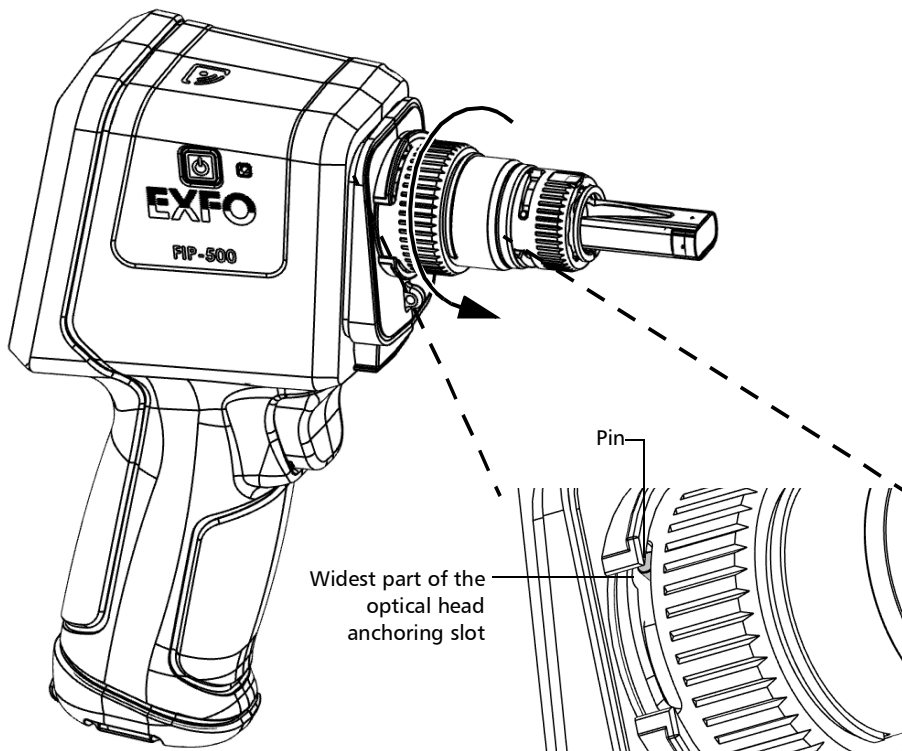

6. Gently pull on the optical head to remove it.

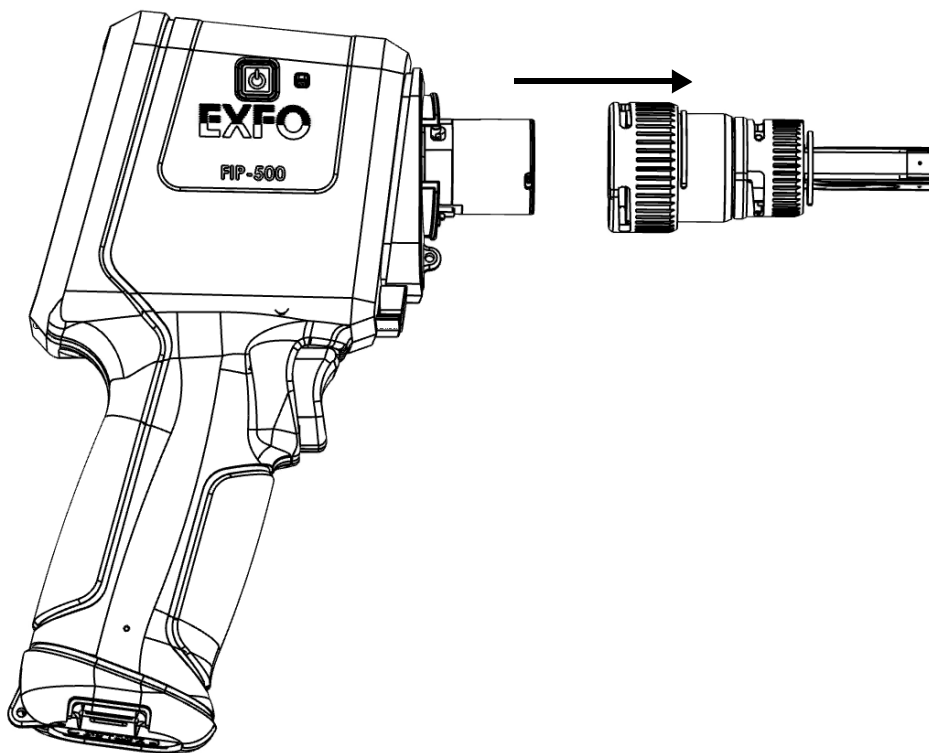

Maintenance

Cleaning Lenses

7. Using a lint-free swab, clean the inner part of the lens that is located at the end of the optical head.

Note: You will need a swab measuring at least 15 cm (6 inches) to clean the inner part of the single-fiber optical head lens.

Multi-fiber optical head

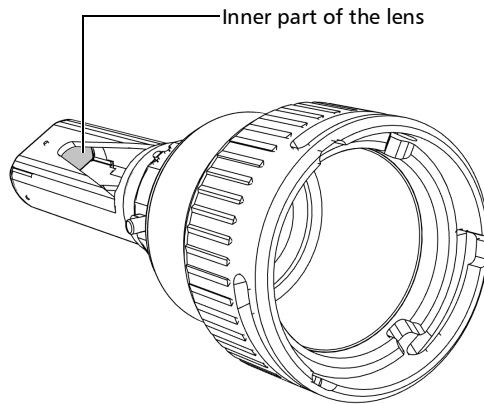

Single-fiber optical head

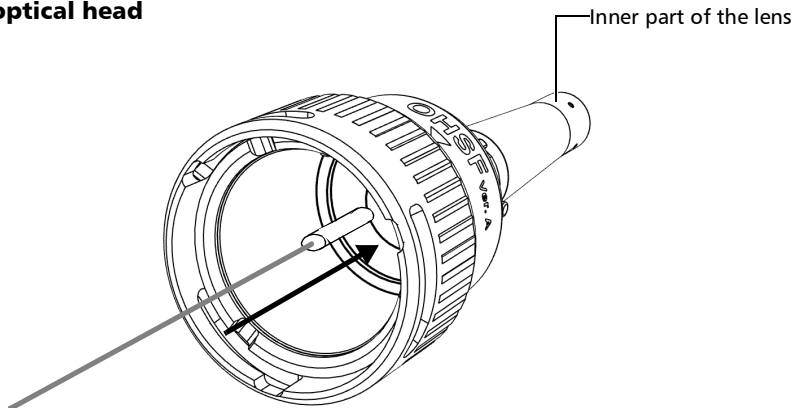

8. Using a lint-free swab, clean the focus lens.

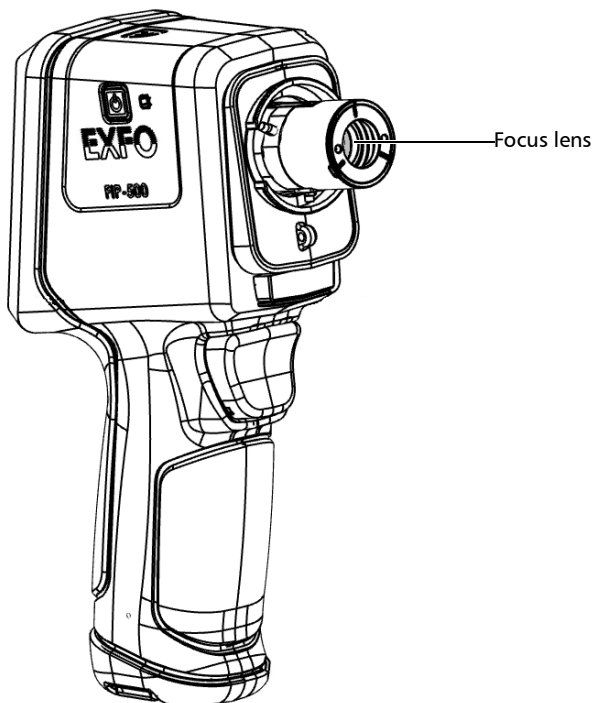

Maintenance

Cleaning Lenses

9. Align the arrow on the optical head with the arrow on your unit and then, gently put the optical head back in place.

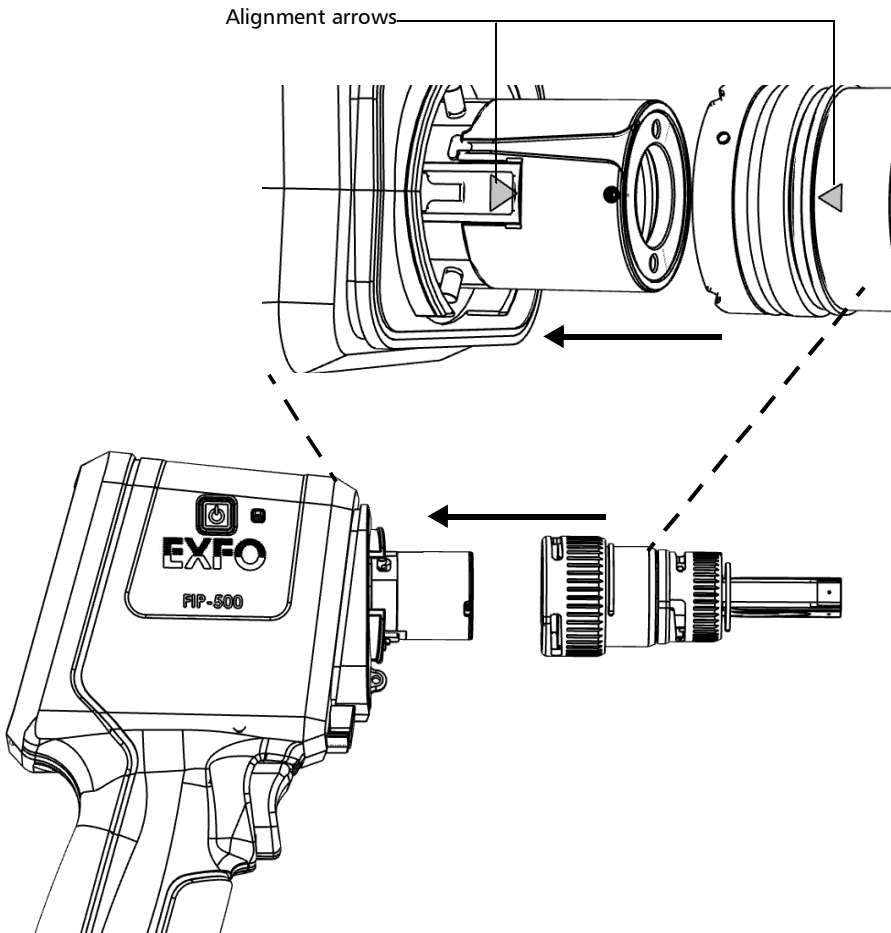

- 10.** Slightly turn the optical head retaining nut clockwise to secure it in place (the pins on the unit will be aligned with the narrowest part of the anchoring slots on the optical head).

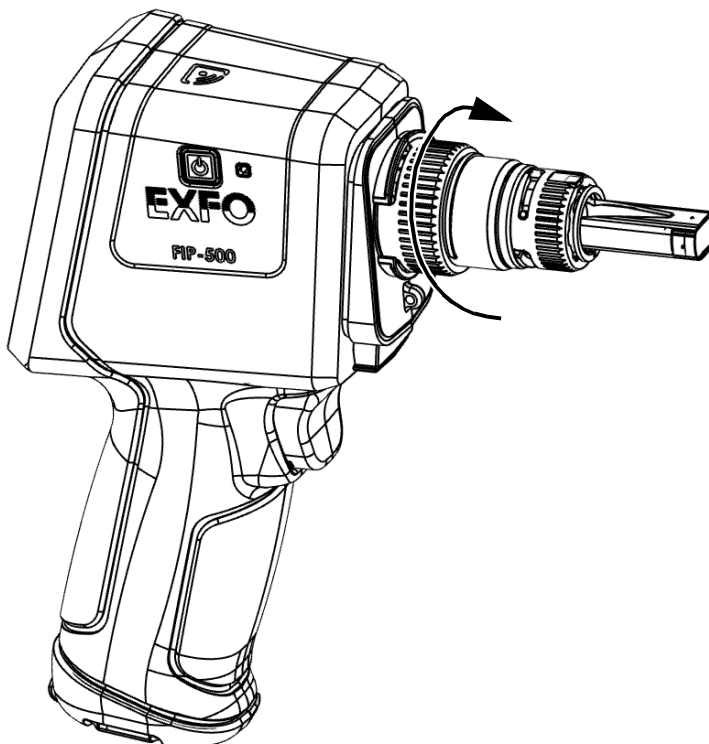

Maintenance

Cleaning the Touchscreen

- 11.** Put the SmarTip back in place.
- 12.** Turn the SmarTip retaining nut clockwise until the pins are aligned with the narrowest part of the anchoring slots to secure the SmarTip in place.

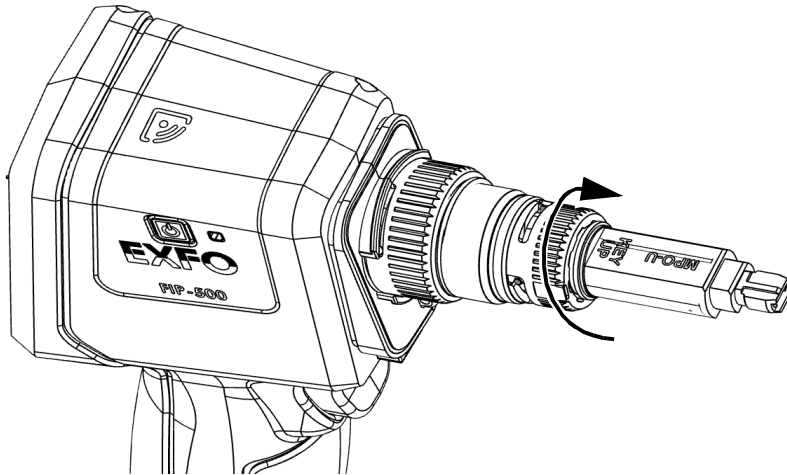

Your unit is now ready to use.

Cleaning the Touchscreen

Clean the touchscreen with a soft, non-abrasive cloth, such as one used for cleaning reading glasses, dampened with water.



CAUTION

Using anything else than water can damage the special coating of the touchscreen.

Battery Maintenance Recommendations



WARNING

Your unit uses the following type of batteries: Lithium-ion (Li-ion). These are batteries with built-in protection that have been especially designed for EXFO. For this reason, you can only replace them with EXFO-approved batteries of the same type and model.



WARNING

The use of unapproved batteries may result in the batteries expanding or igniting (that is, catching fire).



WARNING

Risk of explosion if battery is replaced by an incorrect type. Dispose of used batteries according to the manufacturer's instructions.



WARNING

Do not throw batteries into fire or water and do not short-circuit their electrical contacts. Do not disassemble.



IMPORTANT

Recycle or dispose of used batteries properly, in accordance with local regulations. Do not dispose of them in ordinary garbage receptacles. For more information, see the section about recycling and disposal in this user documentation.

Maintenance

Battery Maintenance Recommendations

- At EXFO, we take the safety of our customers very seriously and want to make sure any battery replacement is done properly.

The batteries of all EXFO-branded products are tested, certified, and in compliance with these international safety standards:

- United Nations (UN) Transport Regulations UN38.3: Covers battery safety during air transport.
- UL 61010-1, CAN/CSA C22.2 61010-1 and International Standard IEC/EN 61010-1: Covers the use of batteries for test and measurement equipment.
- International Standard IEC 62133: Covers secondary cells and batteries containing alkaline or other non-acid electrolytes.
- In some countries, when required, EXFO-approved batteries have been certified and are marked as per local regulation.
- To get pricing and correct part number for replacement batteries for your products, please contact (via email):
 - For Americas: Isales.us@exfo.com
 - For Europe: Isales.emea@exfo.com
 - For APAC: Isales.apac@exfo.com
 - For China: Isales.China@exfo.com
- You may also obtain replacement batteries for your products by contacting your local distributor:
<https://www.exfo.com/en/how-to-buy/find-distributor>
- You may return your unit for service at your local service center:
<https://www.exfo.com/en/services/field-network-testing/exfo-service-centers/>

Recharging the Battery

Your unit uses one lithium-ion (Li-ion) battery.

- The charge status is shown in the upper right corner of the title bar. A red icon indicates that the battery level is running low and that you should connect the unit to a power outlet. For more information, see *Battery Status Icon Description* on page 6.
- The unit also indicates the charge status with the LED on its side (see *LED Indicators Description* on page 4).



WARNING

Use only the listed and certified USB power adapter provided by EXFO with your unit. It provides reinforced insulation between primary and secondary, and is suitably rated for the country where the unit is sold.

Maintenance

Recharging the Battery



IMPORTANT

- ▶ The battery is not charged at the factory. You must fully charge it before using the unit for the first time. The battery is fully charged after a few hours or when the battery LED indicator is steady blue.
- ▶ The time required to charge the battery depends on various factors such as the type of tests currently performed and the ambient temperature.
- ▶ To ensure that the battery functions properly, keep it in temperatures between $-10\text{ }^{\circ}\text{C}$ and $40\text{ }^{\circ}\text{C}$ ($14\text{ }^{\circ}\text{F}$ and $104\text{ }^{\circ}\text{F}$). Store it between $10\text{ }^{\circ}\text{C}$ to $35\text{ }^{\circ}\text{C}$ ($50\text{ }^{\circ}\text{F}$ to $95\text{ }^{\circ}\text{F}$).
When the ambient temperature is below $0\text{ }^{\circ}\text{C}$ ($32\text{ }^{\circ}\text{F}$) or when it reaches or exceeds about $40\text{ }^{\circ}\text{C}$ ($104\text{ }^{\circ}\text{F}$), the battery can either charge more slowly than usual, or not charge at all, depending on the internal temperature of your unit.
- ▶ Do not leave a battery discharged for several days.
- ▶ After 300 cycles (approximately 18 months of use), you may want to replace the battery with a new one to maintain optimal operation conditions. Otherwise, the operating time might be reduced.



IMPORTANT

- ▶ If you need to store the unit (or a battery) for an extended period of time, ensure that the battery is charged at around 50 % of its capacity, and then turn the unit off (shutdown).
- ▶ Place the unit (or the battery) in a cool dry place, and ensure that the battery is charged at around 50 % of its capacity. Every three months during the storage period, verify the battery level. Recharge the battery when necessary, so that its charge level remains around 50 % of the total capacity. This will ensure that you get the optimum performance out of the battery.

To recharge the battery:

Connect the unit to a power outlet using the USB power adapter (fastest way to charge the battery).

Note: *The standard USB ports of a computer cannot power your unit or charge its battery while the unit is on. If you connect your unit to such a USB port with the USB cable, the unit will still consume battery power. If the unit is off when you connect it to the USB port of a computer, its battery could charge, but slowly.*

Note: *If you have a vehicle equipped with dedicated USB charging ports, you could connect your unit to one of these ports to charge the battery. The actual results will vary with each vehicle. You could also use a certified USB power bank (portable charger) to charge your unit.*

The charge cycle will start and end automatically.

Replacing the Battery

Your unit can be powered either by battery or from an appropriate power outlet when used with the provided USB power adapter.



WARNING

- ▶ Your unit uses a lithium-ion (Li-ion) battery with built-in protection that has been especially designed for EXFO. For this reason, you can only replace it with batteries of the same type and model. The use of other batteries may damage your unit and compromise your safety. You can purchase new batteries from EXFO.
- ▶ Battery replacement should only be done by a qualified technician with the appropriate tools on an electronic bench or similar environment.

For more information on the available power sources for your unit, as well as their characteristics, refer to the *Technical Specifications* of your product.



CAUTION

Electrostatic discharge (ESD) damage can cause complete or intermittent equipment failures.

- ▶ Always use an ESD-preventive wrist or ankle strap when replacing the battery. Ensure that the antistatic strap makes good skin contact and that the end of its wire is grounded properly.
- ▶ Never touch any component inside the unit other than those identified in the procedure hereafter, either with tools or your fingers.

To replace the battery:

1. Turn off the unit by pressing the on/off button for about three seconds. A shutdown animation will be displayed on the screen.
2. If applicable, disconnect the USB cable.
3. Position the unit so that its side panel with the on/off button rests on a flat surface such as a table.
4. On the case of the unit, using a 2.5 mm hex socket screwdriver, turn the screws (6) counterclockwise until they are loose, and remove them.

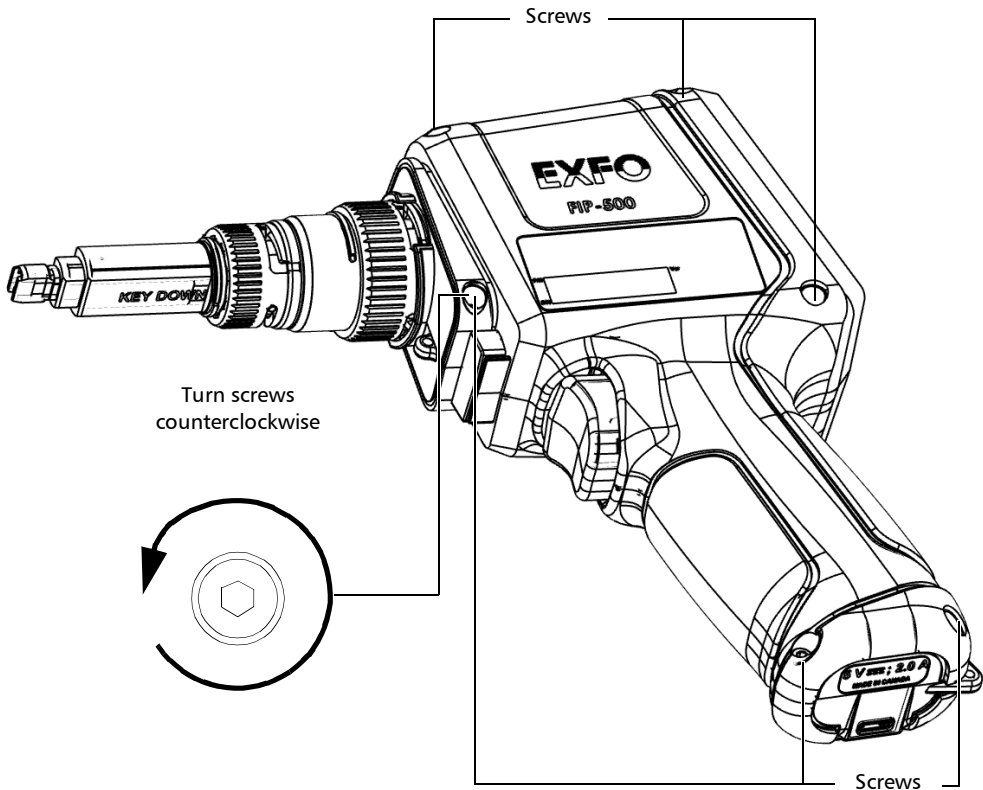

Maintenance

Replacing the Battery

5. Hold the cover by its sides and pull it up to remove it.

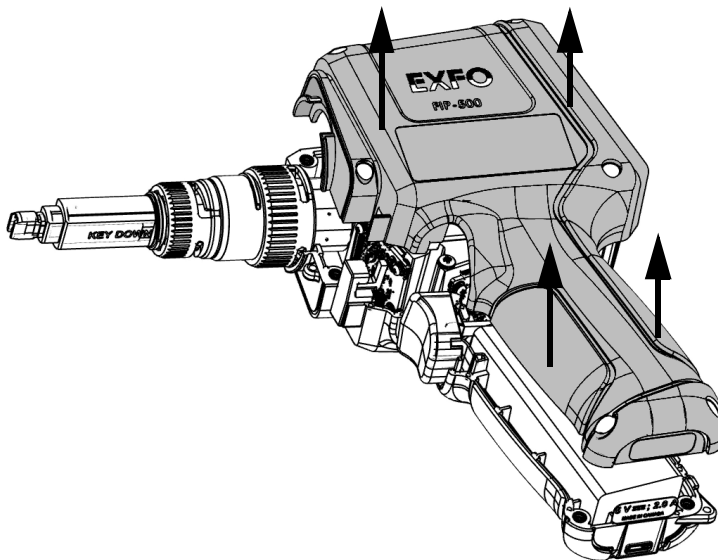

6. Gently pull on the battery connector to disconnect it from its socket.

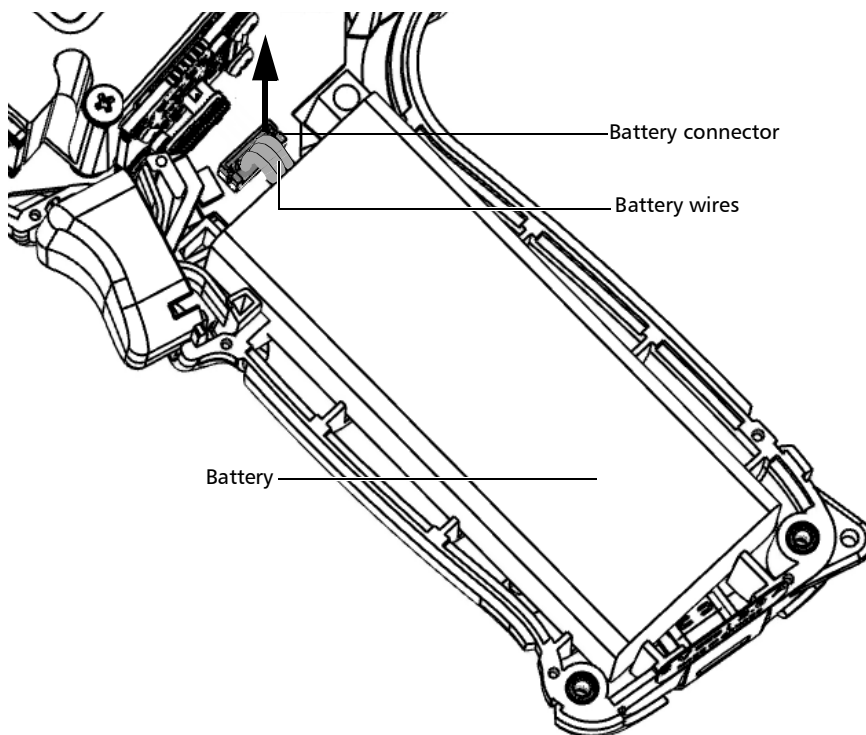

Maintenance

Replacing the Battery

7. Pull the battery up to remove it.

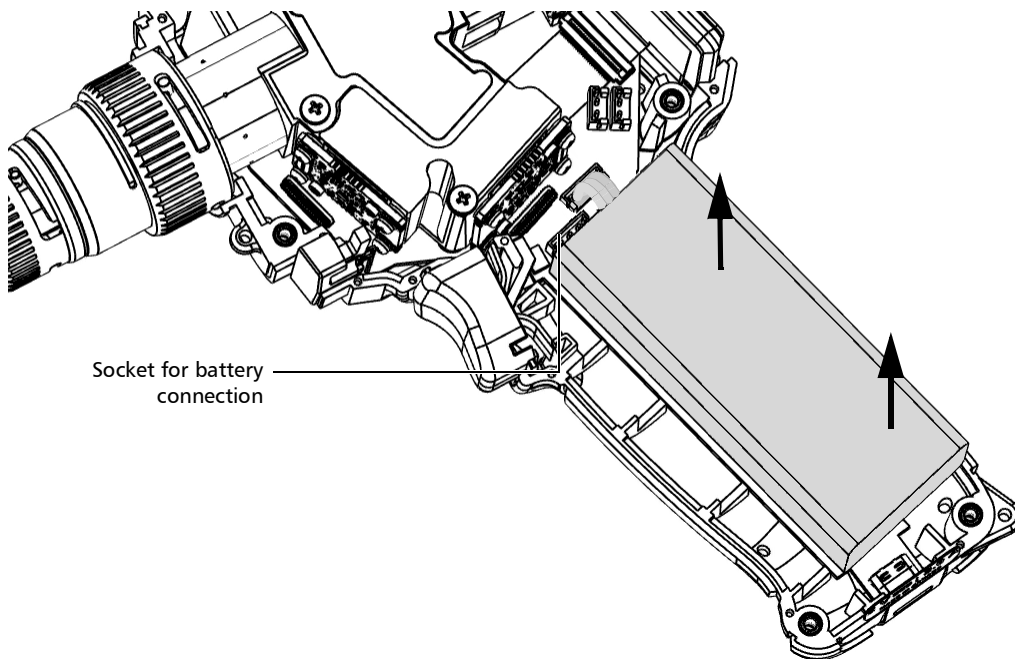

- 8.** Place the new battery so that its wires and connector are located on the same side as the socket in your unit's case. The battery connector should be facing down.
- 9.** Place the new battery in the bottom of the case.

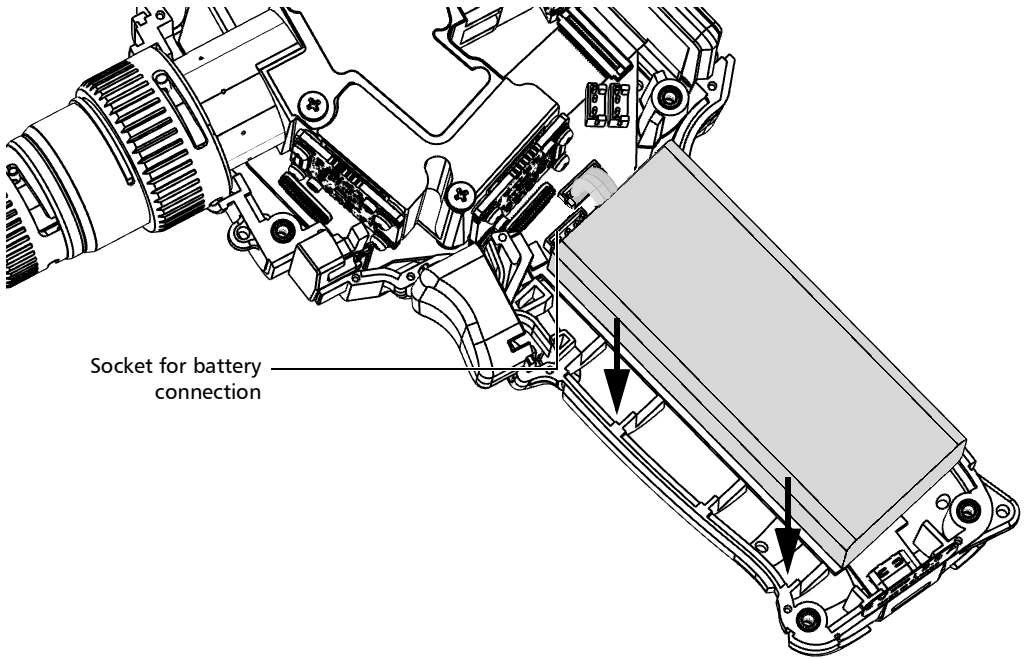

- 10.** Connect the battery connector to the corresponding socket.

Maintenance

Replacing the Battery

- 11.** Carefully place the side panel back on the unit, making sure that it is aligned properly with the other side of the unit and that the trigger has not moved. There should be no gap between both sides of the unit. If necessary, slightly move the side panel until alignment is correct.

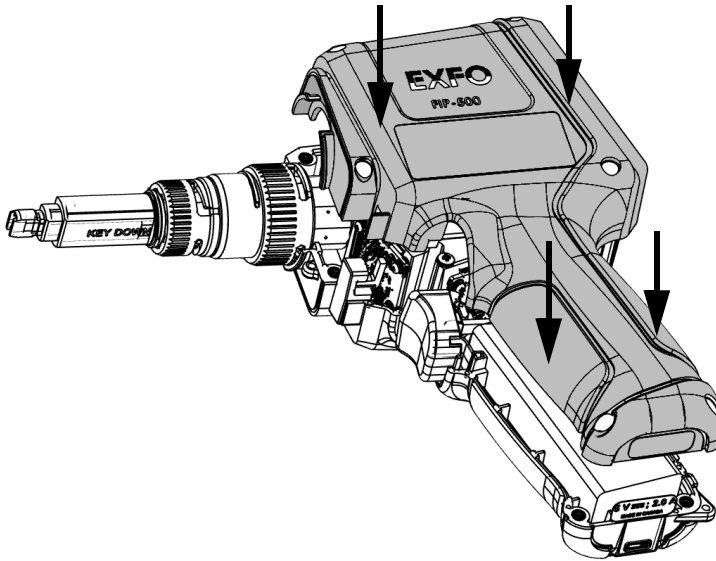

- 12.** Using a 2.5 mm hex socket screwdriver, turn the screws (6) clockwise until they are tightened.

This will secure the side panel into place.



IMPORTANT

To allow the unit to take into account the new battery, reset the battery information as explained hereafter.

- 13.** Reset the battery information as follows:
 - 13a.** Connect the unit to a power outlet using the USB power adapter.
 - 13b.** Turn on your unit.

13c. From the main menu, tap **Settings**.

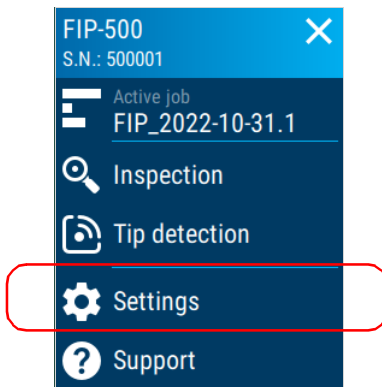

13d. Scroll down to the **Unit settings** section.

13e. Tap **Reset options**.

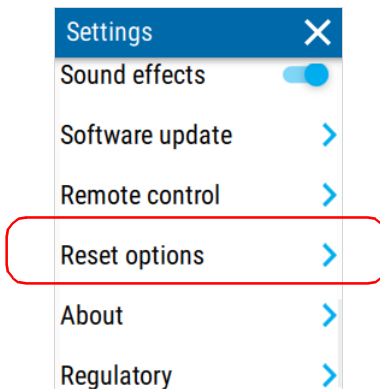

Maintenance

Replacing the Battery

13f. Tap **Reset battery info**.

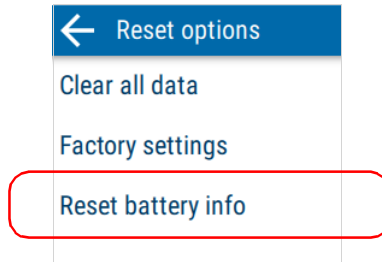

13g. Select the entry corresponding to the type of the new battery (indicated on the battery), and then tap **RESET**.

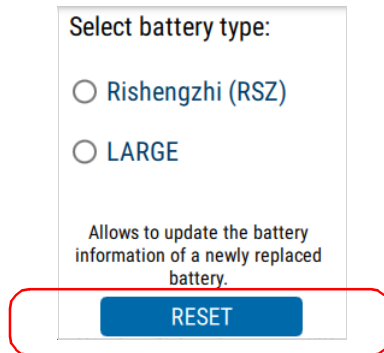

13h. Tap  twice to return to the **Settings** menu.

The new information is taken into account immediately.



IMPORTANT

- ▶ If the battery LED turns to red when you turn on the unit, simply connect the unit to a power outlet and let the new battery charge for a few minutes.
- ▶ It could take a few charge/discharge cycles before the battery LED indicator and the on-screen battery status icon reflect the actual power level of the new battery.

Updating Software With a Wi-Fi Connection

Note: *You need a unit with wireless capabilities and a smart device equipped with the EXFO Exchange application to be able to configure a wireless network, connect your unit to it, and then receive the available updates.*

Your unit's application has been preinstalled and configured at the factory. However, you may have to update it when new versions become available.

Your unit allows you to check for updates, download these updates and install them directly.

Note: *Your unit must have access to an Internet connection (via Wi-Fi) to be able to download updates and install them.*

Note: *EXFO may have provided you with a server ID. If this is the case, follow the instructions below on how to apply this information to your unit.*



IMPORTANT

For a trouble-free upgrade, ensure that you connect your unit to a power outlet and that your unit remains on during all the process.

To update software:

1. Connect your unit to an external power source with the provided USB power adapter.
2. If it is not already done, turn on your unit.
3. Ensure that your unit has access to the Internet (see *Working With a Wireless Network* on page 108).

Maintenance

Updating Software With a Wi-Fi Connection

4. From the main menu, tap **Settings**.

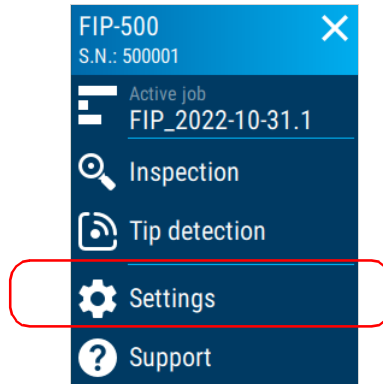

5. Scroll down to the **Unit settings** section.
6. Tap **Software update**.

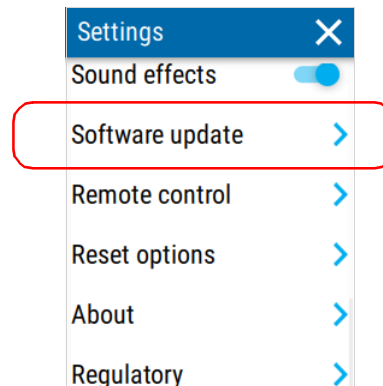

7. If an update is available and you choose to install it, you will be prompted to restart your unit once the installation process is complete. To check if the correct software version was installed, see *Viewing System Information* on page 159.

Clearing All Data

You can clear all test data stored on your unit.

Note: *This operation does not affect any of the settings you have already configured.*



IMPORTANT

Once the clearing data process is complete, all test data stored is deleted and your unit creates a default job with 1000 test points (FIP-000 to FIP-999).

Prior to clearing all data, you may want to share the captures with EXFO for troubleshooting if your unit has wireless capabilities. For more information, see *Sharing Information With the Technical Support Group With a Wi-Fi Connection* on page 157.

To clear all data:

1. From the main menu, tap **Settings**.

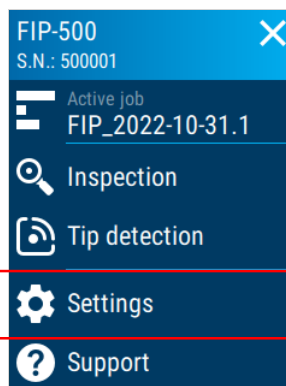

2. Scroll down to the **Unit settings** section.

Maintenance

Recycling and Disposal

3. Tap **Reset options**.

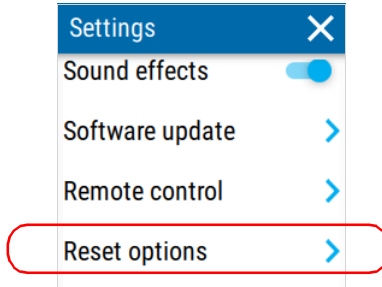

4. Tap **Clear all data**.

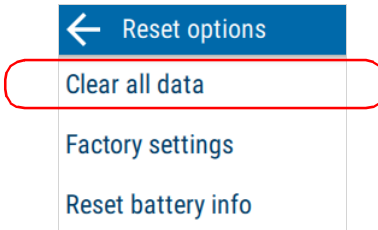

5. A confirmation message is displayed warning you that this operation cannot be undone. Tap **Delete** to confirm.

Recycling and Disposal



This symbol on the product means that you should recycle or dispose of your product (including electric and electronic accessories) properly, in accordance with local regulations. Do not dispose of it in ordinary garbage receptacles.

For complete recycling/disposal information, visit the EXFO Web site at www.exfo.com/recycle.

9 Troubleshooting

Solving Common Problems

| Problem | Possible Cause | Solution |
|----------------------------|--|---|
| My unit does not start. | The battery is completely discharged (if the battery level allows it, the battery LED will remain red for about 5 seconds when you try to turn on the unit). | Connect the unit to an external power source to recharge the battery. If the battery is no longer charging properly, you may need to replace it with a new one (see <i>Replacing the Battery</i> on page 136). |
| | The system has encountered a problem. | Press the on/off button for at least ten seconds to force a hardware reset on the unit. ^a |
| | Some files essential to the normal operation of the unit have been corrupted. | Press the on/off button for at least ten seconds to force a hardware reset on the unit. ^a If the problem persists, try resetting the FIP-500 to its factory settings (see <i>Reverting to Factory Settings</i> on page 55). |
| My unit is not responding. | The system has encountered a problem. | Press the on/off button for at least ten seconds to force a hardware reset on the unit. |

Troubleshooting

Solving Common Problems

| Problem | Possible Cause | Solution |
|--|---|--|
| The battery is not recharging. | The USB power adapter is not connected properly. | <p>Make sure that the USB power adapter is connected to the unit and the AC outlet.</p> <p>In this case, the battery LED is off, and there is a battery icon with a flash symbol displayed on the screen.</p> <p>If the USB power adapter is connected properly and the problem persists, it could mean that the USB power adapter is defective. In this case, try replacing the adapter. You can purchase new USB power adapters from EXFO.</p> |
| | Ambient temperature is too high or too low. | <p>In this case, the battery LED is blue and blinks fast.</p> <p>Make sure that the temperature in the location where you recharge the battery is within the specifications.</p> |
| I have just replaced the battery and the battery LED turns to red when I turn on the unit. | The unit may take a little time to detect the level of a new battery. | <p>Connect the unit to a power outlet with the provided USB power adapter and let the battery charge for a few minutes. After a short while, the unit should turn on. However, it could take a few charge/discharge cycles before the battery LED indicator and the on-screen battery status icon reflect the actual power level of the new battery.</p> |

| Problem | Possible Cause | Solution |
|---|--|--|
| <p>On my unit that has wireless capabilities, no wireless network is displayed.</p> | <p>No network has been configured yet.</p> | <p>You must first configure the desired networks on your smart device, using in the EXFO Exchange application (see <i>Working With a Wireless Network</i> on page 108).</p> |
| <p>My unit does not connect automatically to the wireless network that I have used during my last work session.</p> | <p>There is a connection problem with the network.</p> | <ul style="list-style-type: none"> ➤ Ensure that the Wi-Fi connection is enabled on your unit (see <i>Enabling or Disabling the Wireless Communication</i> on page 105). ➤ In the case of a secured network, ensure that the password has not changed since the initial configuration of this network. If the password is no longer valid, you will have to update it using the EXFO Exchange application (see <i>Working With a Wireless Network</i> on page 108). ➤ Ensure that the network is working normally and that your unit is within the network's range. ➤ If the problem persists, restart your unit to force a new connection to the network. |

Troubleshooting

Solving Common Problems

| Problem | Possible Cause | Solution |
|---|---|--|
| My unit cannot connect to a Wi-Fi network even though I have configured all parameters correctly. | Since every network has its own specifications, there may be elements that are not compatible with your unit. | Configure a Wi-Fi hotspot on a smart device or a laptop that you will use to give your unit access a wireless network. When it is done, configure this Wi-Fi hotspot as you would with any Wi-Fi network (see <i>Configuring a Wireless Network</i> on page 110). |
| I enabled auto saving with the option Only if pass , but the unit is not automatically saving completed tests with a pass verdict. | The unit generated a diagnostic that requires your attention (flashing blue icon). | Read the diagnostic by tapping the blue flashing icon. Tap the save icon in the header to save your test. |
| I enabled auto navigation with the option Only if pass , but the unit is not automatically navigating to the next test point once a test is saved with a pass verdict. | The unit generated a diagnostic that requires your attention (flashing blue icon). | Read the diagnostic by tapping the blue flashing icon. Tap the right arrow in the header to navigate to the next test point. |

- a. Forcing a hardware reset on the unit will not delete any of the data or settings that were already stored. However, the last capture or modifications made to the settings may be lost.

Restoring Your Unit to Normal Operation

If you ever encounter major problems with your unit (for example, the unit does not behave the way it used to), you can revert it to its initial state (as it was at time of purchase).



CAUTION

- Once the recovery operation is started, it cannot be cancelled. All data and custom configurations stored on your unit will be permanently lost.
- Follow the procedure below carefully and connect your unit to a power outlet using the provided USB power adapter when you are instructed to do so.

To restore your unit to normal operation:

1. Ensure that your unit is completely off (not in sleep mode). If necessary, turn off your unit by pressing the on/off button for about three seconds. A shutdown animation will be displayed on the screen.
2. Connect your unit to a power outlet using the provided USB power adapter. This will ensure that your unit remains powered on during the whole recovery operation.
3. Press and hold the trigger.
4. While you keep the trigger down, press the on/off button until the unit beeps once. Release the on/off button, but not the trigger.
5. Keep the trigger down until the **Recovery** page is displayed, then release the trigger.
6. Read the instructions, and if you choose to perform the recovery operation, tap **FACTORY RESET**.

Troubleshooting

Restoring Your Unit to Normal Operation

7. Read the instructions, and then confirm the operation by tapping **FACTORY RESET**. Wait for the operation to complete.



CAUTION

DO NOT TURN OFF your unit while the recovery operation is underway. Doing so may damage your unit. Damaged units will need to be sent back to EXFO for repair.

8. A message will inform you when the operation is complete. Tap **RESTART**.
9. Once your unit has restarted, read and accept the EXFO license agreement, set the date and time, and read safety instructions as you did when you first received your unit (see *Configuring Your Unit at First Startup* on page 17).
10. If desired, perform a software upgrade to ensure that your unit is up to date. For units with wireless capabilities, see *Updating Software With a Wi-Fi Connection* on page 145.

You are now ready to work with your unit.

Accessing the Online Documentation

You can access the user guide at all times from your smart device by scanning the QR code displayed on your unit.

Note: *The user guide is also available from the EXFO Web site (www.exfo.com) for download in PDF format.*

To access the user guide with the QR code:

1. From the main menu, tap **Support**.

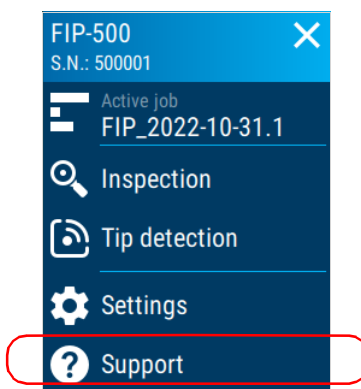

2. Use a smart device to scan the QR code and access the user guide.

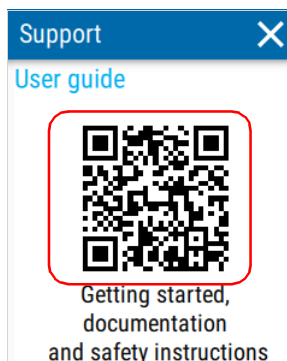

Troubleshooting

Contacting the Technical Support Group

Contacting the Technical Support Group

To obtain after-sales service or technical support for this product, contact EXFO at one of the following numbers. The Technical Support Group is available to take your calls from Monday to Friday, 8:00 a.m. to 7:00 p.m. (Eastern Time in North America).

Technical Support Group

400 Godin Avenue
Quebec (Quebec) G1M 2K2
CANADA

1 866 683-0155 (USA and Canada)
Tel.: 1 418 683-5498
Fax: 1 418 683-9224
support@exfo.com

For detailed information about technical support, and for a list of other worldwide locations, visit the EXFO Web site at www.exfo.com.

If you have comments or suggestions about this user documentation, you can send them to customer.feedback.manual@exfo.com.

To accelerate the process, please have information such as the name and the serial number (see the product identification label), as well as a description of your problem, close at hand.

Sharing Information With the Technical Support Group With a Wi-Fi Connection

After contacting EXFO for support, you may need to share captures with the technical support group for further investigation.

To accelerate the process, please have information such as the serial number of your unit as well as the approximative date and time when the captures were taken, close at hand.

Your unit must have wireless capabilities and access a Wi-Fi connection to be able to share captures. If you have not configured any Wi-Fi network yet, see *Working With a Wireless Network* on page 108.

Note: *To be able to send captures to the technical support group, you must read and accept the privacy and security policies.*

Note: *The unit stores the detailed information of the 50 most recent captures.*

Troubleshooting

Sharing Information With the Technical Support Group With a Wi-Fi Connection

To share information with the technical support group with a Wi-Fi connection:

1. From the main menu, tap **Support**.

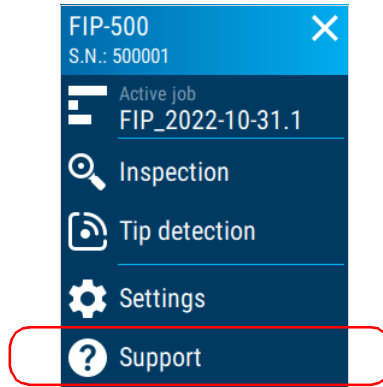

2. Tap **Share captures with EXFO**.

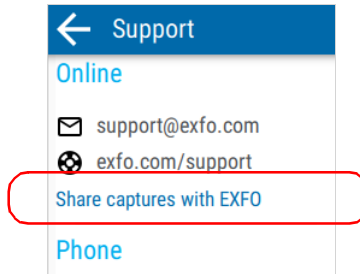

Note: If the **Share captures with EXFO** link is not available (dimmed), it means that all the captures have been transferred to the support server already.

3. When the application prompts you, read the information and tap the **SHARE** button to authorize the transfer.

A confirmation message is displayed as soon as the transfer is complete.

Viewing System Information

You can easily access important information such as the model of your unit, the serial number as well as the software and hardware versions, directly from your unit. You can also view the end-user license agreement and open source license agreements. If your unit has wireless capabilities, you can also view the Wi-Fi address.

To view the system information:

1. From the main menu, tap **Settings**.

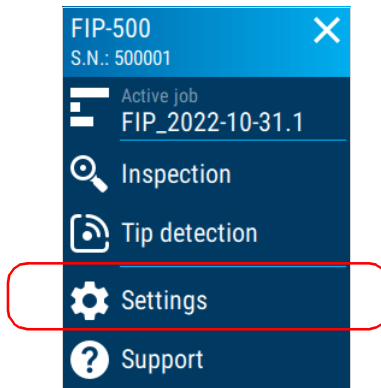

2. Scroll down to the **Unit settings** section.

Troubleshooting

Viewing System Information

3. Tap About.

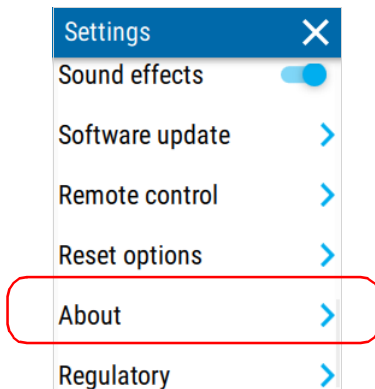

The information about your unit is displayed on the screen.

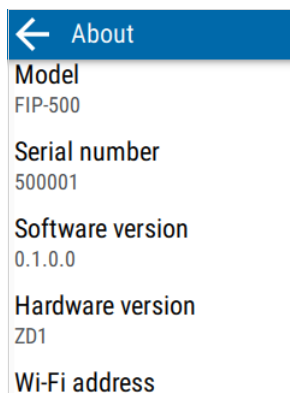

To view the end-user license agreement:

1. From the main menu, tap **Support**.

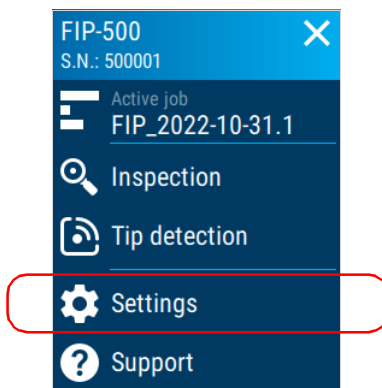

2. Scroll down to the **Unit settings** section.
3. Tap **About**.

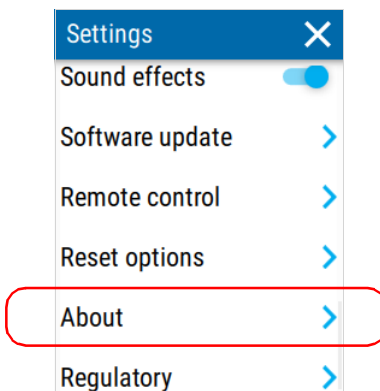

Troubleshooting

Viewing System Information

4. Scroll down to the bottom of the screen. Tap **License agreement**.

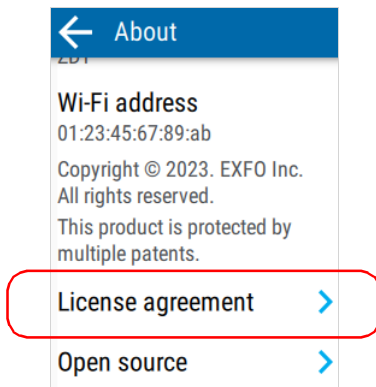

5. Use a smart device to scan the QR code and access the end-user license agreement.

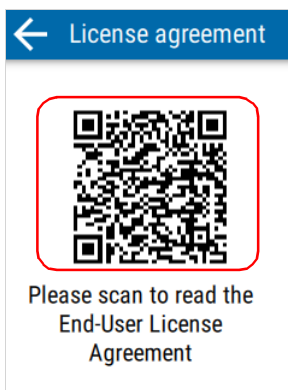

To view the open source license agreements:

1. From the main menu, tap **Support**.

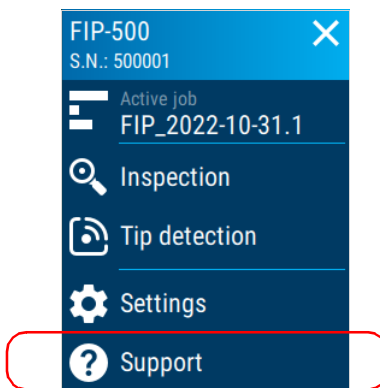

2. Scroll down to the **Unit settings** section.
3. Tap **About**.

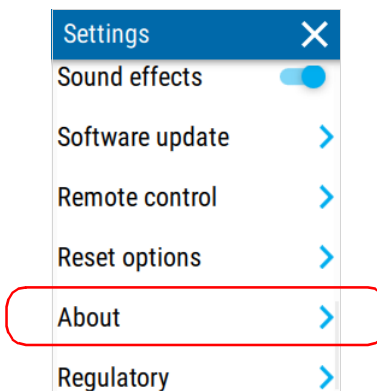

Troubleshooting

Viewing System Information

4. Scroll down to the bottom of the screen. Tap **Open source**.

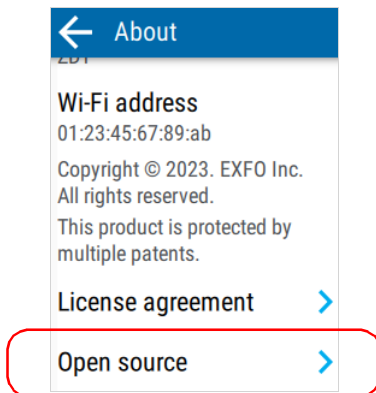

5. The different open source license agreements are listed. Tap the  icon to view information regarding the GPL written offer.

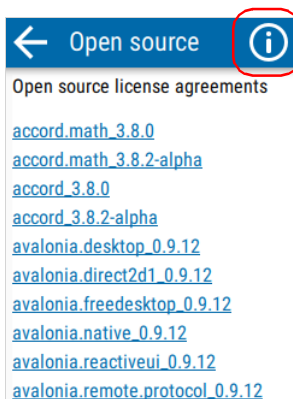

Viewing Contact Information

You can find the contact information directly from your unit if ever you need to reach EXFO.

To retrieve the contact information:

1. From the main menu, tap **Support**.

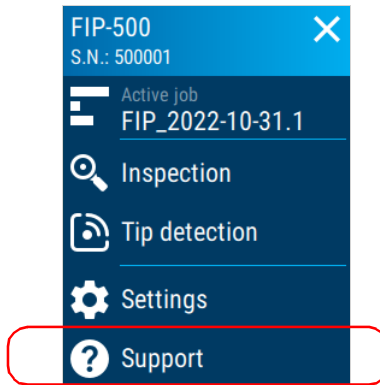

2. Scroll down to the **Online** and **Phone** contact information sections.
The information you want to view is displayed on the screen.

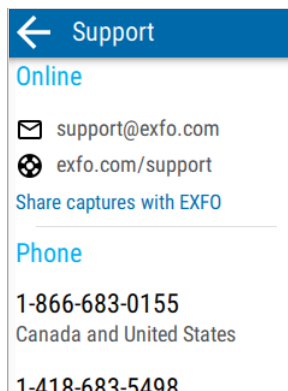

Transportation

Maintain a temperature range within specifications when transporting the unit. Transportation damage can occur from improper handling. The following steps are recommended to minimize the possibility of damage:

- Pack the unit in its original packing material when shipping.
- Avoid high humidity or large temperature fluctuations.
- Keep the unit out of direct sunlight.
- Avoid unnecessary shocks and vibrations.



IMPORTANT

To prevent the unit from turning on unexpectedly, always turn it off (shutdown) before transporting it.

10 Warranty

General Information

EXFO Inc. (EXFO) warrants this equipment against defects in material and workmanship for a period of one year from the date of original shipment. EXFO also warrants that this equipment will meet applicable specifications under normal use.

During the warranty period, EXFO will, at its discretion, repair, replace, or issue credit for any defective product, as well as verify and adjust the product free of charge should the equipment need to be repaired or if the original calibration is erroneous. If the equipment is sent back for verification of calibration during the warranty period and found to meet all published specifications, EXFO will charge standard calibration fees.



IMPORTANT

The warranty can become null and void if:

- unit has been tampered with, repaired, or worked upon by unauthorized individuals or non-EXFO personnel.
- warranty sticker has been removed.
- case screws, other than those specified in this guide, have been removed.
- case has been opened, other than as explained in this guide.
- unit serial number has been altered, erased, or removed.
- unit has been misused, neglected, or damaged by accident.

THIS WARRANTY IS IN LIEU OF ALL OTHER WARRANTIES EXPRESSED, IMPLIED, OR STATUTORY, INCLUDING, BUT NOT LIMITED TO, THE IMPLIED WARRANTIES OF MERCHANTABILITY AND FITNESS FOR A PARTICULAR PURPOSE. IN NO EVENT SHALL EXFO BE LIABLE FOR SPECIAL, INCIDENTAL, OR CONSEQUENTIAL DAMAGES.

Warranty

Gray Market and Gray Market Products

Gray Market and Gray Market Products

Gray market is a market where products are traded through distribution channels that are legal but remain unofficial, unauthorized, or unintended by the original manufacturer. Intermediaries using such channels to distribute products are considered to be part of the gray market (hereafter unauthorized intermediary).

EXFO considers that a product originates from the gray market (hereafter gray market product) in the following situations:

- A product is sold by an unauthorized intermediary.
- A product is designed and destined for a particular market and sold on a second market.
- A product is resold, despite being reported lost or stolen.

When products are purchased on the gray market, rather than through an authorized EXFO distribution channel, EXFO is unable to guarantee the source and quality of those products nor the local safety regulations and certifications (CE, UL, etc.).

EXFO will not honor warranty, install, maintain, repair, calibrate, provide technical support nor make any support contracts available for gray market products.

For complete information, refer to EXFO's policy regarding gray market products at www.exfo.com/en/how-to-buy/sales-terms-conditions/gray-market/

Liability

EXFO shall not be liable for damages resulting from the use of the product, nor shall be responsible for any failure in the performance of other items to which the product is connected or the operation of any system of which the product may be a part.

EXFO shall not be liable for damages resulting from improper usage or unauthorized modification of the product, its accompanying accessories and software.

Exclusions

EXFO reserves the right to make changes in the design or construction of any of its products at any time without incurring obligation to make any changes whatsoever on units purchased. Accessories, including but not limited to fuses, pilot lamps, batteries and universal interfaces (EUI) used with EXFO products are not covered by this warranty.

This warranty excludes failure resulting from: improper use or installation, normal wear and tear, accident, abuse, neglect, fire, water, lightning or other acts of nature, causes external to the product or other factors beyond the control of EXFO.



IMPORTANT

In the case of products equipped with optical connectors, EXFO will charge a fee for replacing connectors that were damaged due to misuse or bad cleaning.

Certification

EXFO certifies that this equipment met its published specifications at the time of shipment from the factory.

Service and Repairs

EXFO commits to providing product service and repair for five years following the date of purchase.

To send any equipment for service or repair:

1. Call one of EXFO's authorized service centers (see *EXFO Service Centers Worldwide* on page 171). Support personnel will determine if the equipment requires service, repair, or calibration.
2. If equipment must be returned to EXFO or an authorized service center, support personnel will issue a Return Merchandise Authorization (RMA) number and provide an address for return.
3. If possible, back up your data before sending the unit for repair.
4. Pack the equipment in its original shipping material. Be sure to include a statement or report fully detailing the defect and the conditions under which it was observed.
5. Return the equipment, prepaid, to the address given to you by support personnel. Be sure to write the RMA number on the shipping slip. *EXFO will refuse and return any package that does not bear an RMA number.*

Note: *A test setup fee will apply to any returned unit that, after test, is found to meet the applicable specifications.*

After repair, the equipment will be returned with a repair report. If the equipment is not under warranty, you will be invoiced for the cost appearing on this report. EXFO will pay return-to-customer shipping costs for equipment under warranty. Shipping insurance is at your expense.

Routine recalibration is not included in any of the warranty plans. Since calibrations/verifications are not covered by the basic or extended warranties, you may elect to purchase FlexCare Calibration/Verification Packages for a definite period of time. Contact an authorized service center (see *EXFO Service Centers Worldwide* on page 171).

EXFO Service Centers Worldwide

If your product requires servicing, contact your nearest authorized service center.

EXFO Headquarters Service Center

400 Godin Avenue
Quebec (Quebec) G1M 2K2
CANADA

1 866 683-0155 (USA and Canada)
Tel.: 1 418 683-5498
Fax: 1 418 683-9224
support@exfo.com

EXFO Europe Service Center

Winchester House, School Lane
Chandlers Ford, Hampshire S053 4DG
ENGLAND

Tel.: +44 2380 246800
Fax: +44 2380 246801
support.europe@exfo.com

EXFO Telecom Equipment (Shenzhen) Ltd.

3rd Floor, Building C,
FuNing Hi-Tech Industrial Park, No. 71-3,
Xintian Avenue,
Fuhai, Bao'An District,
Shenzhen, China, 518103

Tel: +86 (755) 2955 3100
Fax: +86 (755) 2955 3101
support.asia@exfo.com

To view EXFO's network of partner-operated Certified Service Centers nearest you, please consult EXFO's corporate website for the complete list of service partners:

<http://www.exfo.com/support/services/instrument-services/exfo-service-centers>.

Index

A

AC requirements 13, 14
 accessing online help 155
 active jobs, selecting 65
 adapter 12, 133
 adjusting
 brightness..... 35
 date and time 49
 after-sales service 156
 analysis zones..... 97
 applications, installing 145
 auto navigation, configuring..... 45
 auto save, configuring 43
 autofocus 85
 automatic connection to network 112

B

backlight, setting 35
 battery
 level 19, 133, 144, 150, 159
 maintenance recommendations .. 131, 133
 purchasing new 132
 recharging 3, 133, 135
 replacing or removing 136, 137
 resetting information..... 142
 status icons..... 6, 133, 144, 150, 159
 status LED..... 2, 4, 15, 133, 144, 150, 159
 type allowed 7, 136
 blinking LED 4
 blue
 circle..... 97
 LED 4
 Bluetooth
 closing connection..... 100
 connectivity 1
 establishing connection 100, 101
 frequency band data xi, xii, xiv
 status..... 19, 100, 102

boot, first 17
 brightness
 adjusting..... 35
 icon..... 36
 button, on/off..... 2, 4, 15, 134, 137

C

capacitors 12
 captures
 saving 93
 taking 19
 viewing 19, 91
 caution
 of personal hazard 8
 of product hazard 8
 changing
 battery 136, 137
 date and time 49
 optical head 27
 SmarTip..... 21
 charge
 icon..... 133, 144
 status of the battery 133, 144, 150, 159
 charger 12, 133
 charging battery 3
 cleaning
 fiber ends..... 31
 front panel 119
 lenses 120
 touchscreen 130
 clearing all data 147
 closing a connection..... 100
 colors, LEDs 4
 configured networks 108, 110, 114
 configuring
 auto navigation..... 45
 auto save 43
 automatic connection 112

Index

brightness..... 35
date and time..... 49
delay before sleep..... 51
unit..... 17
Wi-Fi communication..... 105
wireless network..... 108, 114
connecting
to wireless network 108, 112, 114
via Bluetooth 100, 101
connector types, selecting..... 73
connectors
auto inspection mode..... 83
duplex-fiber, inspecting 83
live inspection mode..... 83
multi-fiber, inspecting 83
single-fiber, inspecting 83
contact information 165
control center..... 20
conventions, safety 8
current, electrical 14
customer service..... 170

D

dark environments 98
date and time, adjusting 49
deactivating Wi-Fi or Bluetooth..... 105
decimal separator..... 17
default values..... 55, 142, 153
disconnecting from Bluetooth..... 100
displaying overlay..... 19, 97
documentation 155

E

enabling wireless communication 105
end-face analysis..... 42
equipment returns 170
establishing a connection
via Bluetooth 100, 101
with a wireless network..... 112
EXFO Exchange application..... 99
external power supply..... 12, 133

F

factory settings..... 55, 142, 153
favorite networks 108, 110, 114
fiber ends, cleaning 31
fiber type, selecting 19, 80
first startup 17
flashlight 19, 98
frequency, Bluetooth and Wi-Fi xi, xii, xiv
front panel, cleaning 119

G

green circle..... 97

H

help, online 155
hiding overlay..... 19, 97
high temperature 33
hour, setting..... 49

I

icon
battery status..... 6, 133, 144, 150, 159
Bluetooth status 100, 102
brightness..... 36
Wi-Fi status 109, 110
identification label..... 156
images, viewing..... 91
indoor use 12
input current 14
inserting battery..... 136, 137
inspection
images 91
screen 19
inspection mode
auto 36, 83
eco 36
live 36, 83
selecting 36

-
- installing
 - EXFO Exchange application 99
 - software 145
 - integrated light 98
 - interface types, selecting 73
 - internal temperature 7, 33
 - IPv4 wireless routers, characteristics 108
- J**
- jobs
 - deleting 69
 - selecting active 65
 - synchronizing 71, 72
 - understanding 63
- L**
- label, identification 156
 - language, selecting 47
 - LED
 - battery status 2, 15, 133, 144, 150, 159
 - indicators 4
 - license agreement 161
 - Li-ion battery 7, 133, 136
 - list of configured networks 108, 110, 114
 - live inspection mode 85, 86, 88
- M**
- main
 - features 1
 - screen 19
 - maintenance
 - battery 131, 133
 - front panel 119
 - general information 119
 - screen 130
 - manual focus 86
 - manual, user 155
 - maximum input current 14
- N**
- network
 - failure 112
 - removing 114
 - wireless 108, 110, 114
- O**
- obtaining batteries 132
 - off LED 4
 - on/off button 2, 4, 15, 134, 137
 - online help 155
 - open source license agreement 163
 - optical head, changing 27
 - overlay, displaying/hiding 19, 97
- P**
- pass/fail criteria
 - selecting 39
 - status 19
 - port USB 3
 - power
 - adapter 135
 - bank 135
 - button 2, 4, 15, 134, 137
 - management 51
 - see *also* battery
 - see *also* USB power adapter
 - sources 14
 - supply 12, 133
 - preferred networks 108, 110, 114
 - product
 - identification label 156
 - main features 1
 - specifications 8
 - purchasing new batteries 132
- Q**
- QR code 17, 155

Index

R

recharging the battery 133, 135
recovery operation 153
red
 circle 97
 LED 4, 150, 159
regional and language settings 17
regulatory information vi, vii, x
remote control 57
removing battery 136, 137
repairing unit 12
replacement batteries 132
replacing battery 136, 137
resetting battery info 142
REST API 57
return merchandise authorization (RMA) .. 170
reverting unit to initial state 153

S

safety
 caution 8
 conventions 8
 warning 8
saved
 networks 108, 110, 114
 tests, navigating 19, 95
secured network icon 111
selecting
 active job 65
 connector types 73
 fiber type 80
 interface types 73
 language 47
 pass/fail criteria 39
separator, decimal value 17
service and repairs 170
service centers 171
setting
 automatic connection 112
 brightness 19, 35
 date and time 49

 reset 55, 142, 153
 sleep mode 51
 software update 145
 wireless communication 105
 wireless network 108, 114
shipping to EXFO 170
shutting down 16
signal strength, Wi-Fi 109, 110, 111
sleep mode 16, 51
SmarTip, changing 21
software, installing and upgrading 145
sound effects 53
specifications, product 8
status
 Bluetooth 19, 100, 102
 Wi-Fi 19, 109, 110
stopping wireless communication 105
storage requirements 119
strength of the signal 109, 110, 111
symbols, safety 8
system information 159

T

technical specifications 8
technical support 156
temperature for storage 119
temperature management 33
title bar 19, 109, 110
touchscreen
 cleaning 130
 features 1
 location on unit 3
transportation requirements 119, 166
troubleshooting common problems 149
turning on/off
 unit 15, 16
 Wi-Fi or Bluetooth 105

| U | |
|--------------------------------------|---------------|
| understanding inspection screen..... | 19 |
| unit | |
| first configuration..... | 17 |
| repairing..... | 12 |
| restoring..... | 153 |
| unexpected shutdown..... | 33 |
| ventilation..... | 13 |
| updating applications..... | 145 |
| USB | |
| connection..... | 57 |
| port..... | 3 |
| power adapter..... | 135 |
| power bank..... | 135 |
| user guide..... | 155 |
| V | |
| ventilation..... | 13 |
| viewing | |
| analysis zones..... | 97 |
| captures..... | 19, 89, 91 |
| job properties..... | 67 |
| W | |
| warranty | |
| certification..... | 169 |
| exclusions..... | 169 |
| general..... | 167 |
| liability..... | 169 |
| null and void..... | 167 |
| Wi-Fi | |
| address..... | 159 |
| connectivity..... | 1, 57 |
| establishing connection..... | 108, 114 |
| frequency band data..... | xi, xii, xiv |
| status..... | 19, 109, 110 |
| window, main..... | 19 |
| wireless | |
| IPv4 routers characteristics..... | 108 |
| networks..... | 108, 110, 114 |
| wizard, configuration..... | 17 |

CHINESE REGULATION ON RESTRICTION OF HAZARDOUS SUBSTANCES (RoHS)
中国关于有害物质限制的规定

NAMES AND CONTENTS OF THE TOXIC OR HAZARDOUS SUBSTANCES OR ELEMENTS
CONTAINED IN THIS EXFO PRODUCT
包含在本 EXFO 产品中的有毒有害物质或元素的名称及含量

| Part Name 部件名称 | Lead 铅 (Pb) | Mercury 汞 (Hg) | Cadmium 镉 (Cd) | Hexavalent Chromium 六价铬 (Cr(VI)) | Polybrominated biphenyls 多溴联苯 (PBB) | Polybrominated diphenyl ethers 多溴二苯醚 (PBDE) |
|--|-------------------|----------------------|----------------------|---|--|--|
| Enclosure 外壳 | O | O | O | O | O | O |
| Electronic and electrical sub-assembly 电子和电气组件 | X | O | X | O | X | X |
| Optical sub-assembly ^a 光学组件 ^a | X | O | O | O | O | O |
| Mechanical sub-assembly ^a 机械组件 ^a | O | O | O | O | O | O |

Note:

注:

This table is prepared in accordance with the provisions of SJ/T 11364.

本表依据 SJ/T 11364 的规定编制。

O: Indicates that said hazardous substance contained in all of the homogeneous materials for this part is below the limit requirement of GB/T 26572.

O: 表示该有害物质在该部件所有均质材料中的含量均在 GB/T 26572 标准规定的限量要求以下。

X: indicates that said hazardous substance contained in at least one of the homogeneous materials used for this part is above the limit requirement of GB/T 26572. Due to the limitations in current technologies, parts with the "X" mark cannot eliminate hazardous substances.

X: 表示该有害物质至少在该部件的某一均质材料中的含量超出 GB/T 26572 标准规定的限量要求。



标记 "X" 的部件, 皆因全球技术发展水平限制而无法实现有害物质的替代。

a. If applicable.

如果适用。

MARKING REQUIREMENTS

标注要求

| Product 产品 | Environmental protection use period (years) 环境保护使用期限 (年) | Logo 标志 |
|--------------------------------|---|---|
| This EXFO product 本 EXFO 产品 | 10 |  |
| Battery ^a 电池 | 5 |  |

a. If applicable.
如果适用。

P/N: 7.0.0.1

www.EXFO.com · info@EXFO.com

CORPORATE HEADQUARTERS 400 Godin Avenue

Quebec (Quebec) G1M 2K2 CANADA
Tel.: 1 418 683-0211 · Fax: 1 418 683-2170

TOLL-FREE (USA and Canada)

1 800 663-3936

© 2023 EXFO Inc. All rights reserved.
Printed in Canada (2023-05)

