FTB-500



Copyright © 2009–2014 EXFO Inc. All rights reserved. No part of this publication may be reproduced, stored in a retrieval system or transmitted in any form, be it electronically, mechanically, or by any other means such as photocopying, recording or otherwise, without the prior written permission of EXFO Inc. (EXFO).

Information provided by EXFO is believed to be accurate and reliable. However, no responsibility is assumed by EXFO for its use nor for any infringements of patents or other rights of third parties that may result from its use. No license is granted by implication or otherwise under any patent rights of EXFO.

EXFO's Commerce And Government Entities (CAGE) code under the North Atlantic Treaty Organization (NATO) is 0L8C3.

The information contained in this publication is subject to change without notice.

Trademarks

EXFO's trademarks have been identified as such. However, the presence or absence of such identification does not affect the legal status of any trademark.

Units of Measurement

Units of measurement in this publication conform to SI standards and practices.

Version number: 7.0.1

End-User License Agreement

You have acquired a device ("DEVICE") that includes software licensed by EXFO Inc. (EXFO) from an affiliate of Microsoft Corporation ("MS"). Those installed software products of MS origin, as well as associated media, printed materials, and "online" or electronic documentation ("SOFTWARE") are protected by international intellectual property laws and treaties. Manufacturer, MS and its suppliers (including Microsoft Corporation) own the title, copyright, and other intellectual property rights in the SOFTWARE. The SOFTWARE is licensed, not sold. All rights reserved.

This EULA is valid and grants the end-user rights ONLY if the SOFTWARE is genuine and a genuine Certificate of Authenticity for the SOFTWARE is included. For more information on identifying whether your software is genuine, please see <http://www.microsoft.com/piracy/howtotell>.

IF YOU DO NOT AGREE TO THIS END USER LICENSE AGREEMENT ("EULA"), DO NOT USE THE DEVICE OR COPY THE SOFTWARE. INSTEAD, PROMPTLY CONTACT EXFO FOR INSTRUCTIONS ON RETURN OF THE UNUSED DEVICE(S) FOR A REFUND. **ANY USE OF THE SOFTWARE, INCLUDING BUT NOT LIMITED TO USE ON THE DEVICE, WILL CONSTITUTE YOUR AGREEMENT TO THIS EULA (OR RATIFICATION OF ANY PREVIOUS CONSENT).**

GRANT OF SOFTWARE LICENSE. This EULA grants you the following license:

- You may use the SOFTWARE only on the DEVICE.
- **Restricted Functionality.** You are licensed to use the SOFTWARE to provide only the limited functionality (specific tasks or processes) for which the DEVICE has been designed and marketed by EXFO. This license specifically prohibits any other use of the software programs or functions, or inclusion of additional software programs or functions that do not directly support the limited functionality on the DEVICE. Notwithstanding the foregoing, you may install or enable on a DEVICE, systems utilities, resource management or similar software solely for the purpose of administration, performance enhancement and/or preventive maintenance of the DEVICE.
- If you use the DEVICE to access or utilize the services or functionality of Microsoft Windows Server products (such as Microsoft Windows Server 2003), or use the DEVICE to permit workstation or computing devices to access or utilize the services or functionality of Microsoft Windows Server products, you may be required to obtain a Client Access License for the DEVICE and/or each such workstation or computing device. Please refer to the end user license agreement for your Microsoft Windows Server product for additional information.
- **NOT FAULT TOLERANT.** THE SOFTWARE IS NOT FAULT TOLERANT. EXFO HAS INDEPENDENTLY DETERMINED HOW TO USE THE SOFTWARE IN THE DEVICE, AND MS HAS RELIED UPON EXFO TO CONDUCT SUFFICIENT TESTING TO DETERMINE THAT THE SOFTWARE IS SUITABLE FOR SUCH USE.
- **NO WARRANTIES FOR THE SOFTWARE.** THE SOFTWARE is provided "AS IS" and with all faults. THE ENTIRE RISK AS TO SATISFACTORY QUALITY, PERFORMANCE, ACCURACY, AND EFFORT (INCLUDING LACK OF NEGLIGENCE) IS WITH YOU. ALSO, THERE IS NO WARRANTY AGAINST INTERFERENCE WITH YOUR ENJOYMENT OF THE SOFTWARE OR AGAINST INFRINGEMENT. IF YOU HAVE RECEIVED ANY WARRANTIES REGARDING THE DEVICE OR THE SOFTWARE, THOSE WARRANTIES DO NOT ORIGINATE FROM, AND ARE NOT BINDING ON, MS.
- **No Liability for Certain Damages. EXCEPT AS PROHIBITED BY LAW, MS SHALL HAVE NO LIABILITY FOR ANY INDIRECT, SPECIAL, CONSEQUENTIAL OR INCIDENTAL DAMAGES ARISING FROM OR IN CONNECTION WITH THE USE OR PERFORMANCE OF THE SOFTWARE. THIS LIMITATION SHALL APPLY EVEN IF ANY REMEDY FAILS OF ITS ESSENTIAL PURPOSE. IN NO EVENT SHALL MS BE LIABLE FOR ANY AMOUNT IN EXCESS OF U.S. TWO HUNDRED FIFTY DOLLARS (U.S.\$250.00).**
- **Restricted Uses.** The SOFTWARE is not designed or intended for use or resale in hazardous environments requiring fail-safe performance, such as in the operation of nuclear facilities, aircraft navigation or communication systems, air traffic control, or other devices or systems in which a malfunction of the SOFTWARE would result in foreseeable risk of injury or death to the operator of the device or system, or to others.
- **Limitations on Reverse Engineering, Decompilation, and Disassembly.** You may not reverse engineer, decompile, or disassemble the SOFTWARE, except and only to the extent that such activity is expressly permitted by applicable law notwithstanding this limitation.
- **SOFTWARE as a Component of the DEVICE - Transfer.** This license may not be shared, transferred to or used concurrently on different computers. The SOFTWARE is licensed with the DEVICE as a single integrated product and may only be used with the DEVICE. If the SOFTWARE is not accompanied by a DEVICE, you may not use the SOFTWARE. You may permanently transfer all of your rights under this EULA only as part of a permanent sale or transfer of the DEVICE, provided you retain no copies of the SOFTWARE. If the SOFTWARE is an upgrade, any transfer must also include all prior versions of the SOFTWARE. This transfer must also include the Certificate of Authenticity label. The transfer may not be an indirect transfer, such as a consignment. Prior to the transfer, the end user receiving the SOFTWARE must agree to all the EULA terms.
- **Consent to Use of Data.** You agree that MS, Microsoft Corporation and their affiliates may collect and use technical information gathered in any manner as part of product support services related to the SOFTWARE. MS, Microsoft Corporation and their affiliates may use this information solely to improve their products or to provide customized services or technologies to you. MS, Microsoft Corporation and their affiliates may disclose this information to others, but not in a form that personally identifies you.

-
- **Internet Gaming/Update Features.** If the SOFTWARE provides, and you choose to utilize, the Internet gaming or update features within the SOFTWARE, it is necessary to use certain computer system, hardware, and software information to implement the features. By using these features, you explicitly authorize MS, Microsoft Corporation and/or their designated agent to use this information solely to improve their products or to provide customized services or technologies to you. MS or Microsoft Corporation may disclose this information to others, but not in a form that personally identifies you.
 - **Internet-Based Services Components.** The SOFTWARE may contain components that enable and facilitate the use of certain Internet-based services. You acknowledge and agree that MS, Microsoft Corporation or their affiliates may automatically check the version of the SOFTWARE and/or its components that you are utilizing and may provide upgrades or supplements to the SOFTWARE that may be automatically downloaded to your DEVICE. Microsoft Corporation or their affiliates do not use these features to collect any information that will be used to identify you or contact you. For more information about these features, please see the privacy statement at <http://go.microsoft.com/fwlink/?LinkId=25243>.
 - **Links to Third Party Sites.** You may link to third party sites through the use of the SOFTWARE. The third party sites are not under the control of MS or Microsoft Corporation, and MS or Microsoft are not responsible for the contents of any third party sites, any links contained in third party sites, or any changes or updates to third party sites. MS or Microsoft Corporation is not responsible for webcasting or any other form of transmission received from any third party sites. MS or Microsoft Corporation are providing these links to third party sites to you only as a convenience, and the inclusion of any link does not imply an endorsement by MS or Microsoft Corporation of the third party site.
 - **Notice Regarding Security.** To help protect against breaches of security and malicious software, periodically back up your data and system information, use security features such as firewalls, and install and use security updates.
 - **No Rental/Commercial Hosting.** You may not rent, lease, lend or provide commercial hosting services with the SOFTWARE to others.
 - **Separation of Components.** The SOFTWARE is licensed as a single product. Its component parts may not be separated for use on more than one computer.
 - **Additional Software/Services.** This EULA applies to updates, supplements, add-on components, product support services, or Internet-based services components ("Supplemental Components"), of the SOFTWARE that you may obtain from EXFO, MS, Microsoft Corporation or their subsidiaries after the date you obtain your initial copy of the SOFTWARE, unless you accept updated terms or another agreement governs. If other terms are not provided along with such Supplemental Components and the Supplemental Components are provided to you by MS, Microsoft Corporation or their subsidiaries then you will be licensed by such entity under the same terms and conditions of this EULA, except that (i) MS, Microsoft Corporation or their subsidiaries providing the Supplemental Components will be the licensor with respect to such Supplemental Components in lieu of the "COMPANY" for the purposes of the EULA, and (ii) TO THE MAXIMUM EXTENT PERMITTED BY APPLICABLE LAW, THE SUPPLEMENTAL COMPONENTS AND ANY (IF ANY) SUPPORT SERVICES RELATED TO THE SUPPLEMENTAL COMPONENTS ARE PROVIDED AS IS AND WITH ALL FAULTS. ALL OTHER DISCLAIMERS, LIMITATION OF DAMAGES, AND SPECIAL PROVISIONS PROVIDED BELOW AND/OR OTHERWISE WITH THE SOFTWARE SHALL APPLY TO SUCH SUPPLEMENTAL COMPONENTS. MS, Microsoft Corporation or their subsidiaries reserve the right to discontinue any Internet-based services provided to you or made available to you through the use of the SOFTWARE.
 - **Recovery Media.** If SOFTWARE is provided by EXFO on separate media and labeled "Recovery Media" you may use the Recovery Media solely to restore or reinstall the SOFTWARE originally installed on the DEVICE.
 - **Backup Copy.** You may make one (1) backup copy of the SOFTWARE. You may use this backup copy solely for your archival purposes and to reinstall the SOFTWARE on the DEVICE. Except as expressly provided in this EULA or by local law, you may not otherwise make copies of the SOFTWARE, including the printed materials accompanying the SOFTWARE. You may not loan, rent, lend or otherwise transfer the backup copy to another user.
 - **End User Proof of License.** If you acquired the SOFTWARE on a DEVICE, or on a compact disc or other media, a genuine Microsoft "Proof of License"/Certificate of Authenticity label with a genuine copy of the SOFTWARE identifies a licensed copy of the SOFTWARE. To be valid, the label must be affixed to the DEVICE, or appear on [COMPANY'S] software packaging. If you receive the label separately other than from EXFO, it is invalid. You should keep the label on the DEVICE or packaging to prove that you are licensed to use the SOFTWARE.
 - **Product Support.** Product support for the SOFTWARE is not provided by MS, Microsoft Corporation, or their affiliates or subsidiaries. For product support, please refer to EXFO support number provided in the documentation for the DEVICE. Should you have any questions concerning this EULA, or if you desire to contact EXFO for any other reason, please refer to the address provided in the documentation for the DEVICE.
 - **Termination.** Without prejudice to any other rights, EXFO may terminate this EULA if you fail to comply with the terms and conditions of this EULA. In such event, you must destroy all copies of the SOFTWARE and all of its component parts.
 - **EXPORT RESTRICTIONS.** You acknowledge that SOFTWARE is subject to U.S. and European Union export jurisdiction. You agree to comply with all applicable international and national laws that apply to the SOFTWARE, including the U.S. Export Administration Regulations, as well as end-user, end-use and destination restrictions issued by U.S. and other governments. For additional information see <http://www.microsoft.com/exporting/>.

Contents

Certification Information	x
1 Introducing the FTB-500	1
Main Features	2
LED Panel Description	8
Function Buttons Description	9
Hard-Drive Structure	10
Automatic Fan Speed Management	10
Conventions	11
2 Safety Information	13
Other Safety Symbols on Your Unit	14
Laser Safety Information	15
Electrical Safety Information	16
3 Getting Started with Your FTB-500	21
Inserting and Removing Test Modules	21
Turning On the FTB-500	28
Turning Off the FTB-500	30
Grounding Your FTB-500	34
Securing your FTB-500 Using the Kensington Lock	35
Installing or Upgrading the Applications	36
Accessing and Exiting ToolBox	39
Starting Module Applications	40
Installing EXFO LabVIEW Drivers	41
Activating Software Options	42
Installing Third-Party Software on Your FTB-500	47
Protecting your Unit with an Antivirus Software	47

4	Setting Up Your FTB-500	49
	Positioning Your Unit	49
	Installing a Monitor	50
	Calibrating the Touchscreen	51
	Adjusting the Monitor Settings	53
	Changing the Backlight Level	54
	Installing a Hardware Keyboard	55
	Using the On-Screen (Virtual) Keyboard	56
	Using the Module On-Screen (Virtual) Keyboard	56
	Customizing the On-Screen Keyboard	58
	Right-Clicking with the Touchscreen	59
	Installing a Pointing Device	60
	Installing a Headset or Speakers	61
	Installing a Microphone	62
	Installing a Printer	63
	Installing an Express Card	64
	Automating Application Startup	65
	Selecting the FIP Startup Application	67
	Selecting the Language of Operation	69
	Adjusting the Date, Time and Time Zone	77
	Configuring the Power Management Options	80
	Setting ToolBox Options	86
	Setting Communication Parameters	87
5	Working with Your Unit	89
	Accessing Platform-Related Tools from ToolBox	89
	Accessing Other Tools	90
	Printing Documents	91
	Viewing PDF Files	94
	Taking Screen Captures	95
	Browsing the Web	96
	Accessing the Internet with a 3G USB Modem Key	97
	Retrieving the GPS Location of Your Unit	102

6	Using the Optional Built-In Power Meter and VFL	107
	Accessing the Built-In Power Meter	108
	Nulling Offsets	110
	Setting Thresholds and Correction Factors	111
	Setting Reference Values on Your Power Meter	115
	Measuring Power or Loss	116
	Opening Results Files	119
	Clearing Measurements from the Display	121
	Adding Information to Your Results	122
	Printing Results Reports	123
	Identifying Fiber Faults Visually with the VFL	125
7	Inspecting Fibers with a Probe	127
8	Managing Data	131
	Transferring Data via Bluetooth	132
	Connecting to a Wireless Network	140
	Using the USB to RS-232 Adapter	145
	Connecting to a VPN from Your Unit	151
	Using Your Unit as an FTP Server	153
9	Accessing Your Unit Remotely	155
	Working with Remote Desktop	156
	Working With TightVNC	167
	Adding Exceptions to the Firewall	173
10	Preparing for Automation	175
	Linking Units with the Ethernet Port	177
	Linking Units with the Serial Port	178
	Getting Optimum Performance from Your FTB-500	179
	Changing Communication Settings	181
	Configuring DCOM Access to Your Unit	185
	Preparing to Control Modules with a Dedicated Application	208

11 Using FTB Products in an Automated Test Environment	213
Managing the States of Your FTB-500	214
Standard Status Data Structure	216
SCPI Command Structure	220
Consulting Data Types	223
Writing Remote Control Code	224
Error Message Format	226
Working with EXFO COM Objects	227
Working with EXFO LabVIEW Drivers	228
Using the EXFO Getting Started Applications	230
Building and Using Custom VIs	235
Monitoring Remote Commands	241
12 Maintenance	245
Cleaning Detector Ports	246
Cleaning VFL-Type Connectors	247
Cleaning the Touchscreen	248
Battery Maintenance Recommendations	249
Inserting and Removing Batteries	250
Verifying Battery Status	252
Recalibrating the Batteries	254
Enabling Automatic Windows Updates	256
Replacing Fuses (Eight-Slot Model Only)	259
Recalibrating the Unit	260
Recycling and Disposal (Applies to European Union Only)	261
13 Troubleshooting	263
Solving Common Problems	263
LED Indicator Color Codes	270
Restoring Your Unit to Normal Operation	272
Accessing Online Help	282
Contacting the Technical Support Group	284
Viewing System Information	285
Transportation	288
14 Warranty	289
General Information	289
Liability	290
Exclusions	291
Certification	291
Service and Repairs	292
EXFO Service Centers Worldwide	293

A	Technical Specifications	295
B	Data Types	297
	Applicable Data Types for Input—IEEE 488.2	298
	Applicable Data Types for Output —IEEE 488.2	307
	Applicable Data Types for Input—SCPI	317
	Special Numeric Values Received on Output	318
C	IEEE 488.2 and Specific Command Reference	319
	IEEE 488.2 Commands—Quick Reference	319
	IEEE 488.2 Required Commands	320
	Specific Commands—Quick Reference	340
	Specific Commands	341
D	SCPI-Based Errors	359
E	COM Properties and Events	375
	ActiveX (COM/DCOM)—Quick Reference	376
	Properties	377
	Events	384

Certification Information

North America Regulatory Statement

This unit was certified by an agency approved in both Canada and the United States of America. It has been evaluated according to applicable North American approved standards for product safety for use in Canada and the United States.

Electronic test and measurement equipment is exempt from FCC part 15, subpart B compliance in the United States of America and from ICES-003 compliance in Canada. However, EXFO Inc. makes reasonable efforts to ensure compliance to the applicable standards.

The limits set by these standards are designed to provide reasonable protection against harmful interference when the equipment is operated in a commercial environment. This equipment generates, uses, and can radiate radio frequency energy and, if not installed and used in accordance with the user guide, may cause harmful interference to radio communications. Operation of this equipment in a residential area is likely to cause harmful interference in which case the user will be required to correct the interference at his own expense.

Modifications not expressly approved by the manufacturer could void the user's authority to operate the equipment.

European Community Declaration of Conformity

An electronic version of the declaration of conformity for your product is available on our website at www.exfo.com. Refer to the product's page on the Web site for details.

1 **Introducing the FTB-500**

Today's network technology is more complex than ever. Thousands of components have to work in harmony and deployment specialists are responsible for tuning entire systems for optimal network performance and for ensuring records updates. In addition, fiber counts are skyrocketing. DWDM is well entrenched in long-haul applications and is moving into metro. You know that you need more efficiency.

You will find it with the FTB-500. Benefit from advanced test operations in outside plant installation, maintenance, and troubleshooting. The FTB-500 streamlines field-based test and measurement operations into a single, powerful, revolutionary package. Welcome to multi-tasking in the field.

Note: *In this documentation, the words “tap” and “double-tap” (related to the use of a touchscreen) replace the words “click” and “double-click”.*

Introducing the FTB-500

Main Features

Main Features

Front

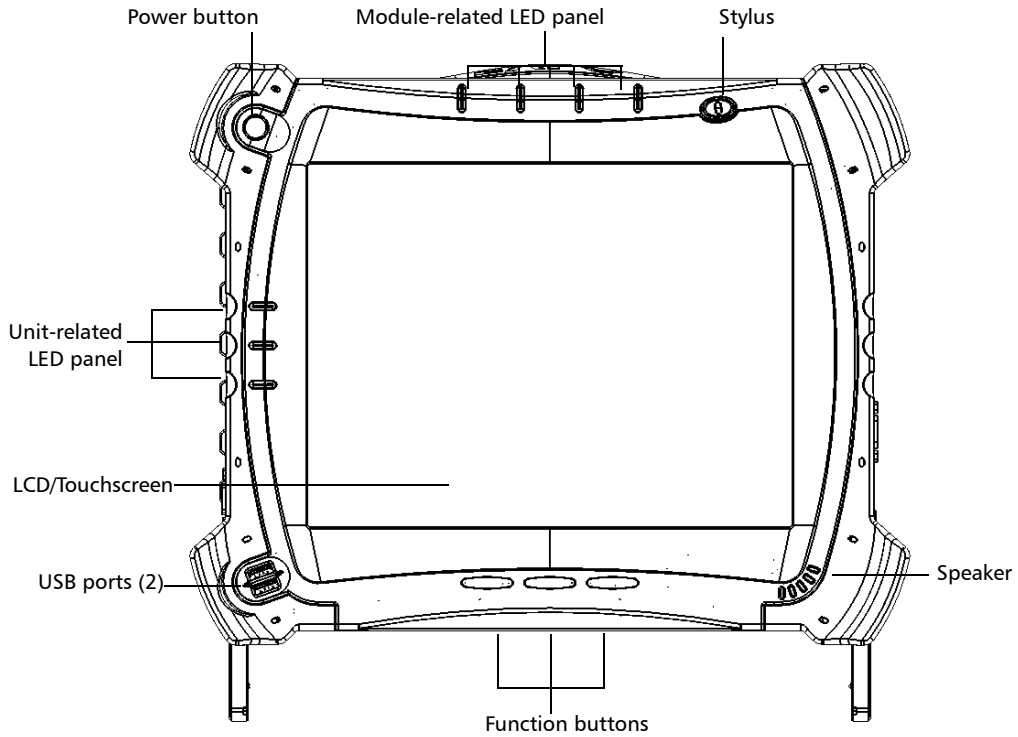

**Right side
(four-slot model)**

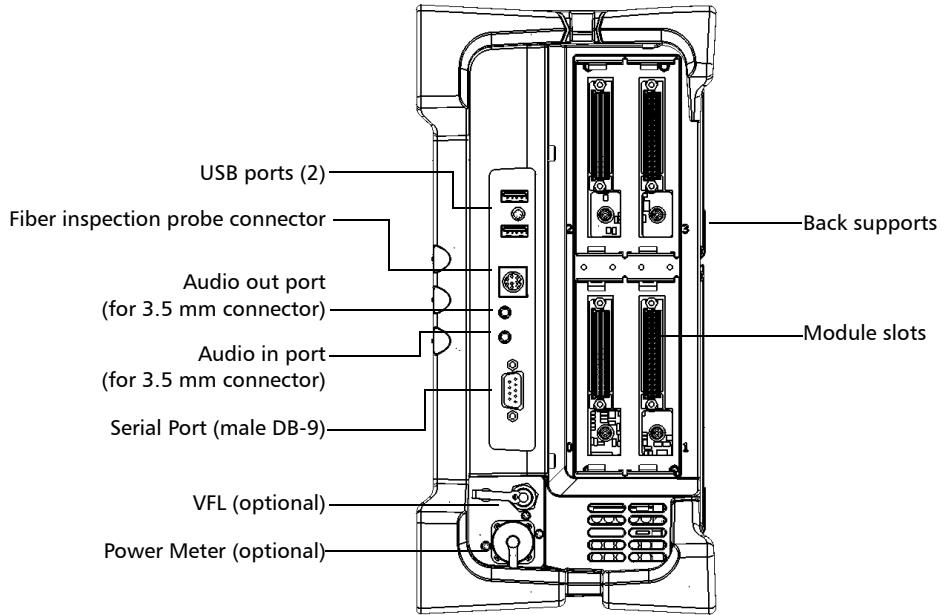

Introducing the FTB-500

Main Features

Right side (eight-slot model)

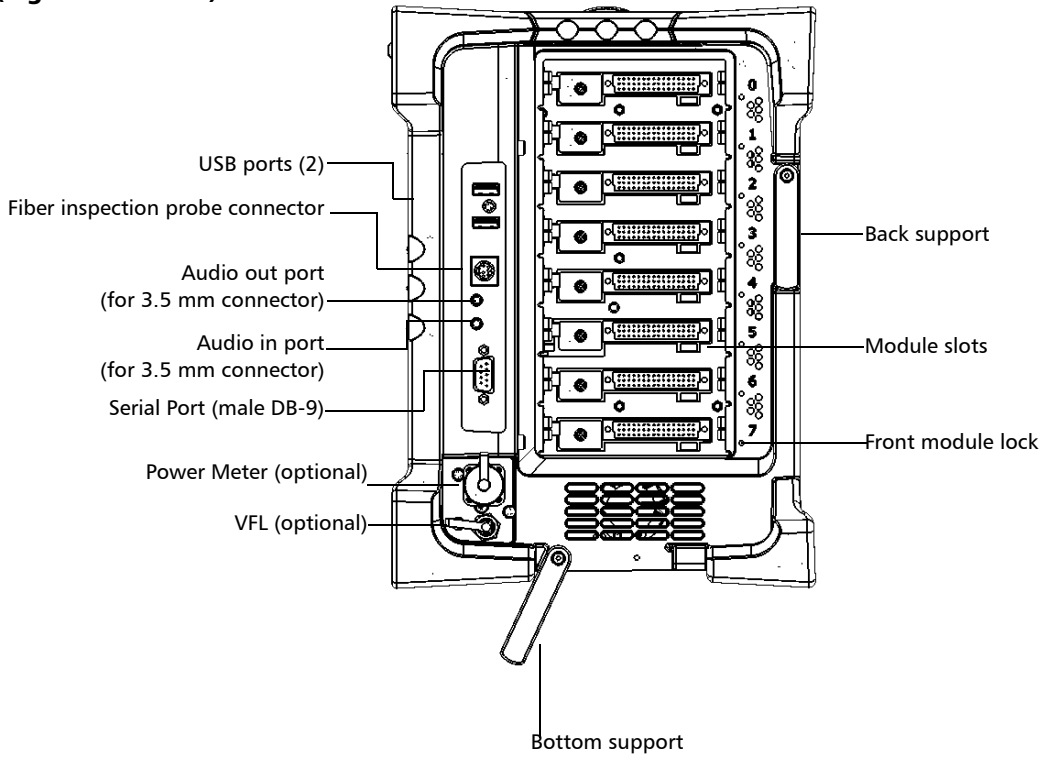

Left side

(Four-slot model)

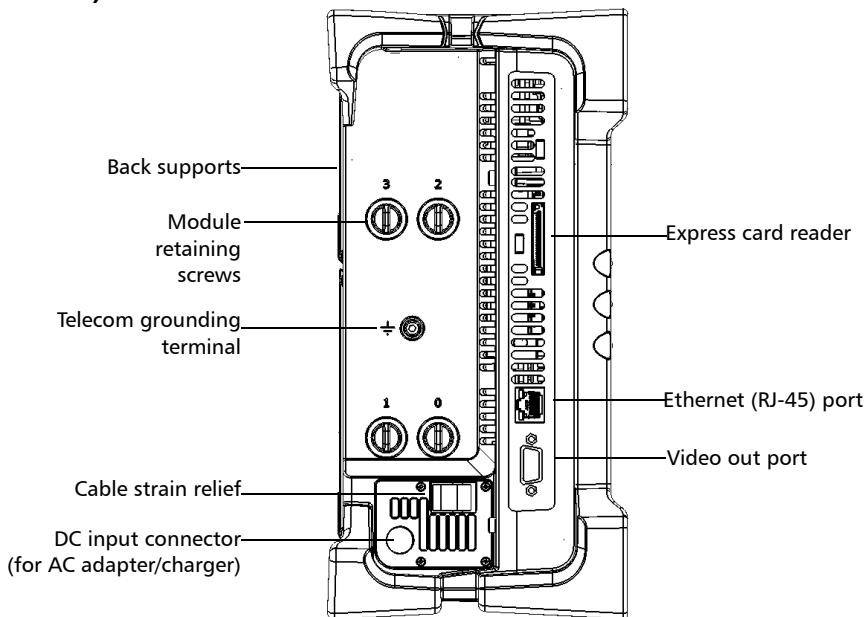

Introducing the FTB-500

Main Features

Left side (Eight-slot model)

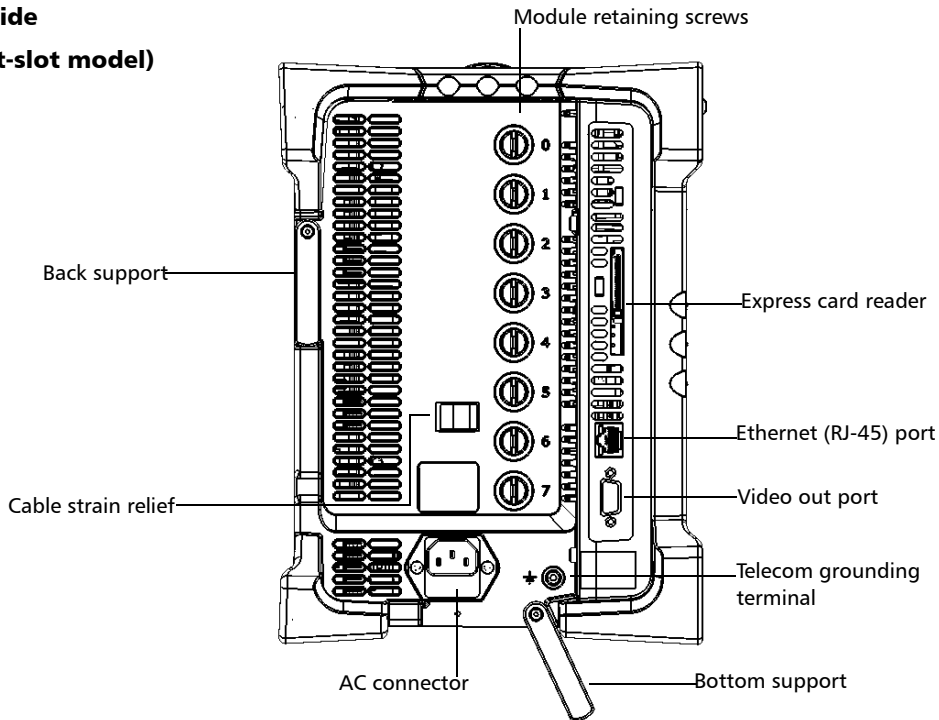

The FTB-500 runs Microsoft Windows XP Professional for Embedded Systems, and the ToolBox software provides you with a graphical, user-friendly interface for your testing applications.

The interface is easy to access, whether you are using the touchscreen or a mouse and a keyboard.

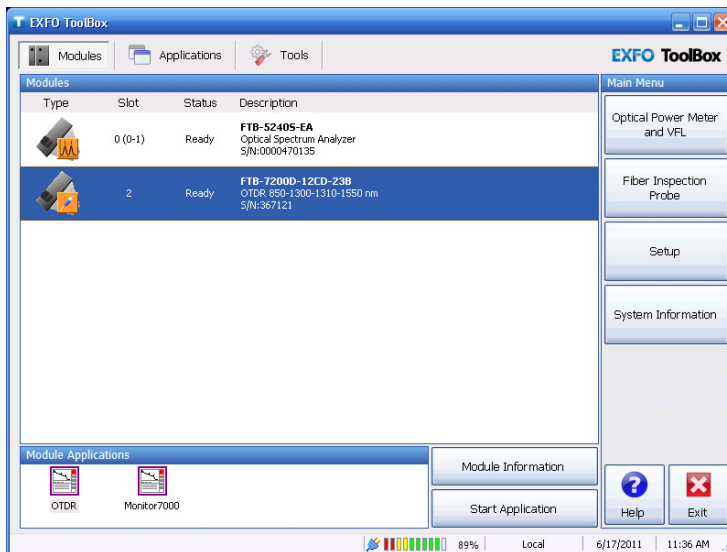

ToolBox brings multitasking to field testing. You can perform different tests and work on tests results all at the same time, switching between applications simply by touching a button.







The FTB-500 supports local control (via the ToolBox software) and remote control (through RS-232 or Ethernet TCP/IP—using SCPI commands or the provided LabVIEW drivers).

Introducing the FTB-500

LED Panel Description



LED Panel Description

The LED panel on the front of the unit provides you with the status of the FTB-500.

LED	Definition
	Power status (on, off or standby)
	Battery status
	Hard disk read or write operations
	Laser indicator
	Alarms for module applications
	Pass/Fail status for module applications
	Remote control activated

Function Buttons Description

The FTB-500 is equipped with function buttons that give you access to features at all times. Below, you will find a table of the function buttons available and an overview of their purpose.

Button	Purpose
	<p><i>Program Switcher:</i> To switch among running applications. It is the equivalent of pressing the Alt-TAB key combination on a keyboard.</p> <p>In emergency system tools mode, this button is used to access the mode, then switch between the available options.</p>
	<p><i>Backlight:</i> To set the display brightness level. For more information, see <i>Changing the Backlight Level</i> on page 54.</p>
<p>LOCAL</p>	<p><i>Local:</i> When you are working in remote control mode, to return to local control and settings. In emergency system tools mode, this button acts as the Enter key on a keyboard.</p>

Hard-Drive Structure

Your FTB-500 uses several hard-drive partitions for specific purposes.

Partition	Contents
C	Operating system, EXFO applications
D	User/EXFO data, EXFO application configurations
E	Recovery utilities, FTB-500 backup (Windows Image)



CAUTION

Even if you are using another location to save your data, **NEVER** delete any of the default folders on any of the drives. Deleting folders such as the D:\ToolBox folder would prevent you from operating ToolBox and require you to contact EXFO's technical support to have your platform function properly again.

Automatic Fan Speed Management

The FTB-500 will determine the most appropriate fan speed, depending on the power requirements and the type of modules you are using.



IMPORTANT

Fan speed is always determined to cool down the most heat-generating modules.

If the temperature keeps rising and reaches the limit: your FTB-500 will turn off to protect both the modules and the platform itself.



CAUTION

Make sure to use protective covers over empty slots in your four-slot model to avoid overheating.

Conventions

Before using the product described in this guide, you should understand the following conventions:



WARNING

Indicates a potentially hazardous situation which, if not avoided, could result in *death or serious injury*. Do not proceed unless you understand and meet the required conditions.



CAUTION

Indicates a potentially hazardous situation which, if not avoided, may result in *minor or moderate injury*. Do not proceed unless you understand and meet the required conditions.



CAUTION

Indicates a potentially hazardous situation which, if not avoided, may result in *component damage*. Do not proceed unless you understand and meet the required conditions.



IMPORTANT

Refers to information about this product you should not overlook.

2 **Safety Information**



WARNING

Do not install or terminate fibers while a light source is active. Never look directly into a live fiber and ensure that your eyes are protected at all times.



WARNING

The use of controls, adjustments and procedures, namely for operation and maintenance, other than those specified herein may result in hazardous radiation exposure or impair the protection provided by this unit.



IMPORTANT

When you see the following symbol on your unit , make sure that you refer to the instructions provided in your user documentation. Ensure that you understand and meet the required conditions before using your product.



IMPORTANT

Other safety instructions relevant for your product are located throughout this documentation, depending on the action to perform. Make sure to read them carefully when they apply to your situation.



CAUTION









When the laser safety light is flashing, at least one module is emitting an optical signal. Please check all modules, as it might not be the one you are currently using.

Safety Information

Other Safety Symbols on Your Unit

Other Safety Symbols on Your Unit

One or more of the following symbols may also appear on your unit.

Symbol	Meaning
	Direct current
	Alternating current
	Both direct and alternating current
	The unit is equipped with an earth (ground) terminal.
	The unit is equipped with a protective conductor terminal.
	The unit is equipped with a frame or chassis terminal.
	On (Power)
	Off (Power)

Laser Safety Information

Units with Built-In VFL

Your instrument is a Class 3R laser product in compliance with standards IEC 60825-1: 2007 and 21 CFR 1040.10, except for deviations pursuant to Laser Notice No. 50, dated June 24, 2007. Laser radiation is emitted at the output port. It is potentially harmful in direct intrabeam viewing.

The following label(s) indicate that the product contains a Class 3R source:

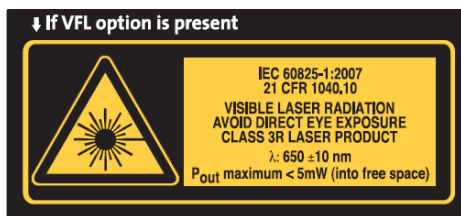

Affixed to back panel of unit.

The modules that you use with your unit may have different laser classes. Refer to the user guide or the online help of the different modules for the exact information.

Units without Built-In VFL

If your unit is not equipped with a VFL, the laser class of your unit depends on the modules that you use. Refer to the user guide or the online help of the different modules for the exact information.

Safety Information

Electrical Safety Information

Electrical Safety Information

The four-slot model uses an external AC/DC adapter connected to an international safety standard three-wire power cable.

The eight-slot model uses an international safety standard three-wire power cable. This cable serves as a ground when connected to an appropriate AC power outlet.

Note: *If you need to ensure that the unit is completely turned off, disconnect the power cable and remove the batteries.*



WARNING

- ▶ Insert the power cable plug into a power outlet with a protective ground contact. Do not use an extension cord without a protective conductor.
- ▶ Before turning on the unit, connect all grounding terminals, extension cords and devices to a protective ground via a ground socket. Any interruption of the protective grounding is a potential shock hazard and may cause personal injury. Whenever the ground protection is impaired, do not use the unit and secure it against any accidental operation.
- ▶ Do not tamper with the protective ground terminal.

The color coding used in the electric cable depends on the cable. New plugs should meet the local safety requirements and include:

- adequate load-carrying capacity
- ground connection
- cable clamp



WARNING

- Use the external power supply indoors only.
- Position the unit so that the air can circulate freely around it.
- Operation of any electrical instrument around flammable gases or fumes constitutes a major safety hazard.
- To avoid electrical shock, do not operate the unit if any part of the outer surface (covers, panels, etc.) is damaged.
- Only authorized personnel should carry out adjustments, maintenance or repair of opened units under voltage. A person qualified in first aid must also be present. Do not replace any components while power cable and battery are connected.
- (Eight-slot model only) Use only fuses with the required rated current and specified type (F6.3A L, 5 mm x 20 mm (0.197 in x 0.787 in), fast-acting, low-breaking capacity, 250 V). Do not use repaired fuses or short-circuited fuse holders.
- Unless otherwise specified, all interfaces are intended for connection to Safety Extra Low Voltage (SELV) circuits only.
- Capacitors inside the unit may be charged even if the unit has been disconnected from its electrical supply.

Safety Information

Electrical Safety Information



WARNING

- Use only the listed and certified AC adapter/charger provided by EXFO with your unit (four-slot model). It provides reinforced insulation between primary and secondary, and is suitably rated for the country where the unit is sold.
- Use only accessories (such as the batteries, and fiber inspection probe) designed for your unit and approved by EXFO. For a complete list of accessories available for your unit, refer to its technical specifications.
- When you use the unit outdoors, ensure that it is protected from liquids, dust, direct sunlight, precipitation, and full wind pressure.

Equipment Ratings	
Temperature	
➤ Operation	<ul style="list-style-type: none">➤ unit powered by batteries: 0 °C to 50 °C^a (32 °F to 122 °F) (total max. of 50 W for modules in four-slot model) (total max. of 85 W for modules in eight-slot model)➤ unit connected to AC power:<ul style="list-style-type: none">➤ 0 °C to 40 °C (32 °F to 104 °F) (total max. of 100 W for modules in four-slot model)➤ 0 °C to 50 °C (32 °F to 122 °F) (total max. of 200 W for modules in eight-slot model)
➤ Storage	➤ unit: -40 °C to 70 °C (-40 °F to 158 °F)
Relative humidity ^b	<ul style="list-style-type: none">➤ unit: ≤ 95 % non-condensing➤ AC adapter: 10 % to 80 % non-condensing

Equipment Ratings	
Maximum operation altitude	<ul style="list-style-type: none"> ➤ 2000 m (6562 ft) (unit connected to external power supply) ➤ 5000 m (16405 ft) (unit operated from battery)
Pollution degree	<ul style="list-style-type: none"> ➤ 2 (unit connected to external power supply) ➤ 3 (unit operated from batteries)^c
Overvoltage category	<ul style="list-style-type: none"> ➤ unit: I ➤ AC adapter: II
Measurement category	Not rated for measurement categories II, III, or IV
Input power ^d	<ul style="list-style-type: none"> ➤ unit (four slots): --- 24 V; 8 A ➤ AC adapter (four slots): ~ 100 - 240 V; 50/60 Hz; 4.8 A ➤ unit (eight slots): ~ 100 - 240 V; 50/60 Hz; 4.8 A

- a. With some modules, the maximum operation temperature is 40 °C (104 °F).
- b. Measured in 0 °C to 31 °C (32 °F to 87.8 °F) range, decreasing linearly to 50 % at 40 °C (104 °F).
- c. Equipment must be normally protected against exposure to direct sunlight, precipitation and full wind pressure.
- d. Not exceeding ± 10 % of the nominal voltage.

Safety Information

Electrical Safety Information



CAUTION

Use of voltages higher than those indicated on the label affixed to your unit may damage the unit.



IMPORTANT

The operation and storage temperatures of some modules may differ from the temperatures specified for your platform. In this case, always ensure that you comply with the most restrictive conditions (either module or platform).

3 Getting Started with Your FTB-500

Inserting and Removing Test Modules



CAUTION

Never insert or remove a module while the FTB-500 is turned on. This will result in immediate and irreparable damage to both the module and unit.



CAUTION

To avoid damaging your unit, use it only with modules approved by EXFO.



WARNING

When the laser safety LED () is flashing on the FTB-500, at least one of your modules is emitting an optical signal. Please check all modules, as it might not be the one you are currently using.

To insert a module into the FTB-500:

1. Exit ToolBox and turn off your unit.
2. Position the FTB-500 so that its right panel is facing you.
3. Take the module and place it so that the connector pins are at the back, as explained and shown below.



CAUTION

Inserting a module upside down could result in permanent damage to the module, as the connector pins might be bent.

Getting Started with Your FTB-500

Inserting and Removing Test Modules

- (4-slot model) identification sticker must be on left side and retaining screw hole *under* connector pins.

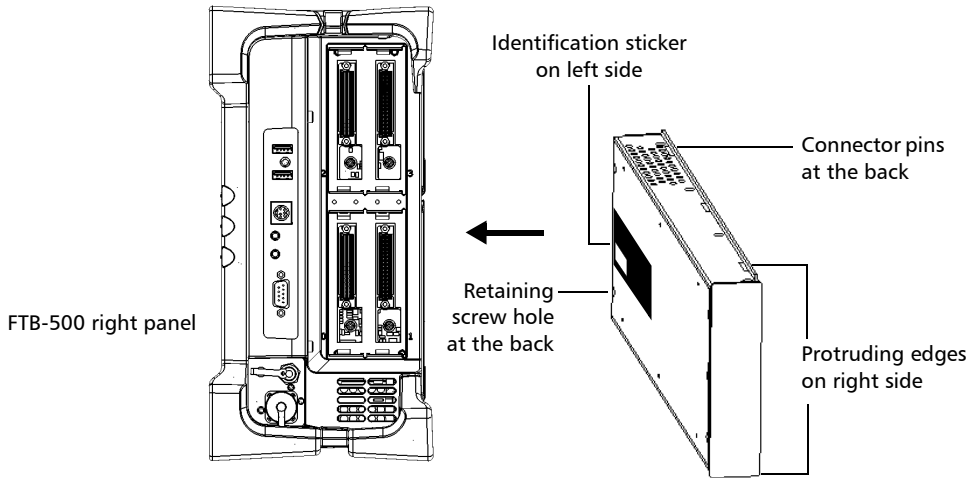

- (eight-slot model) identification sticker must be facing up and connector pins at the right of the retaining screw hole.

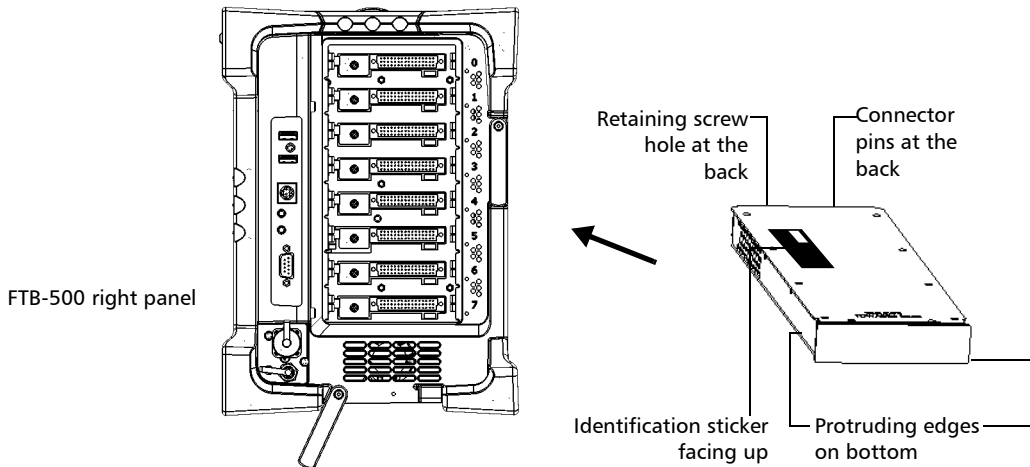

Note: *If you are using larger or heavier modules, place them near the bottom of the unit as much as possible.*

- 4.** Insert the protruding edges of the module into the grooves of the receptacle's module slot.
- 5.** Push the module all the way to the back of the slot, until the retaining screw makes contact with the receptacle casing.
- 6.** Place the FTB-500 so that its left panel is facing you.

Getting Started with Your FTB-500

Inserting and Removing Test Modules

7. While applying slight pressure to the module, turn the retaining screw clockwise until it is tightened.

This will secure the module into its “seated” position.

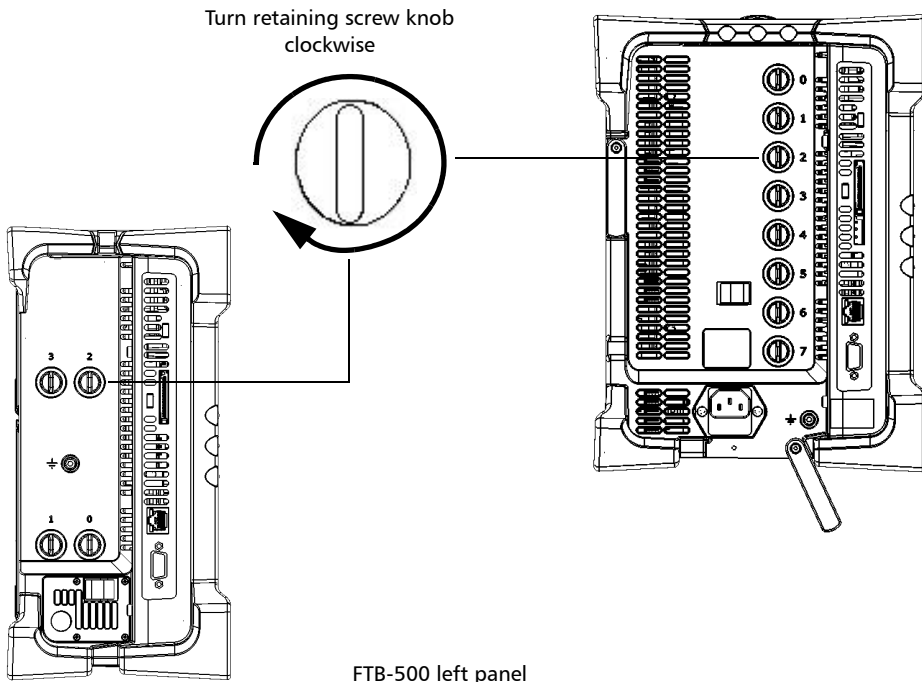

Getting Started with Your FTB-500

Inserting and Removing Test Modules

8. If you are using a larger or heavier module, use a front module lock to hold them securely in place. Simply place the retaining part against the module, then screw in the holding pin.

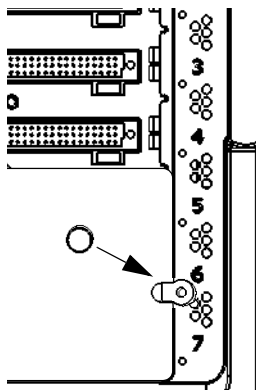

When you turn on the unit, the startup sequence will automatically detect the module.

Getting Started with Your FTB-500

Inserting and Removing Test Modules

To remove a module from the FTB-500:

1. Exit ToolBox and turn off your unit.
2. Position the FTB-500 so that the left panel is facing you.
3. Turn the retaining screw counterclockwise until it stops.

The module will be slowly released from the slot.

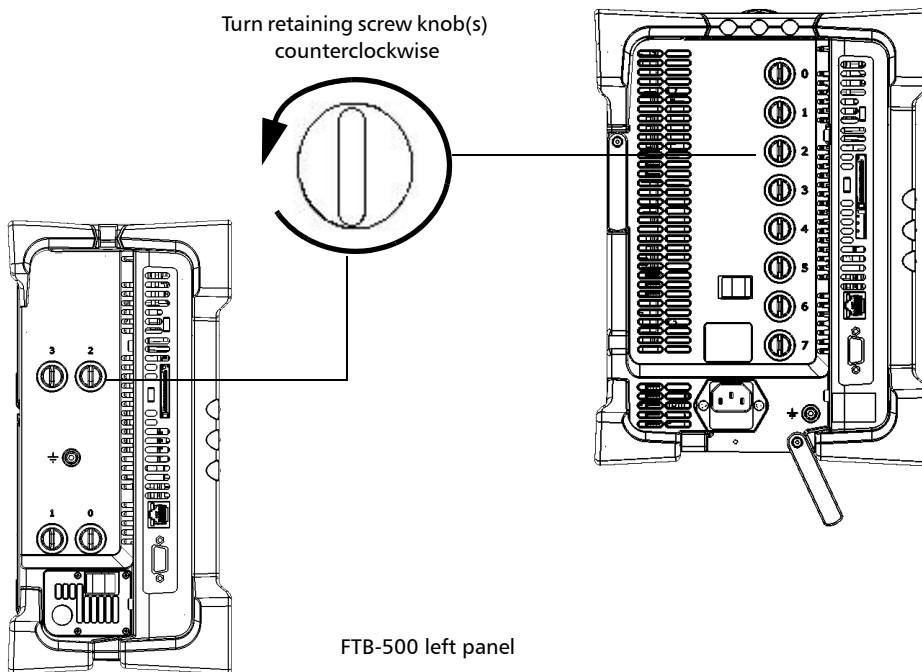

4. Place the FTB-500 so that the right panel is facing you.

Getting Started with Your FTB-500

Inserting and Removing Test Modules

5. Hold the module by its sides or by the handle (*NOT by the connector*) and pull it out.

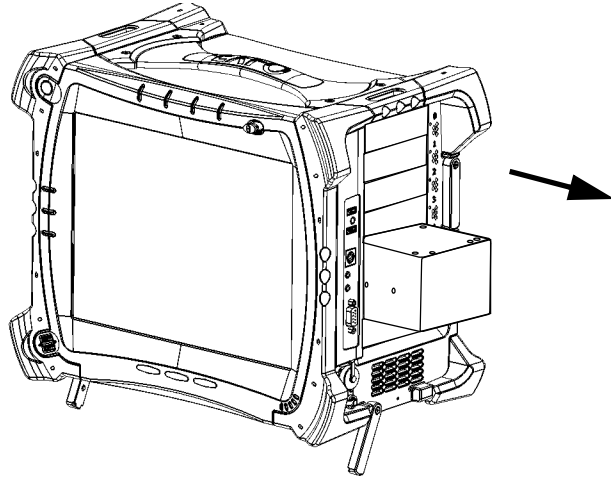

6. Cover empty slots with the supplied protective covers.



CAUTION

Failure to reinstall protective covers over empty slots will result in ventilation problems.

Getting Started with Your FTB-500

Turning On the FTB-500

Turning On the FTB-500

To turn on the FTB-500:

Hold down the On/Off button on the front panel.

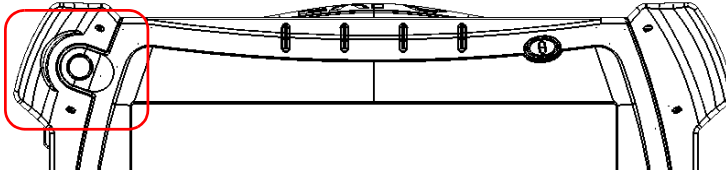

The unit beeps, the startup screen briefly appears and the unit starts.

Each time you start a new ToolBox session, the **Modules** window appears. This window will reflect the modules you are using.

Use this window to start single-module applications. The applications will change depending on the modules you have in your FTB-500.

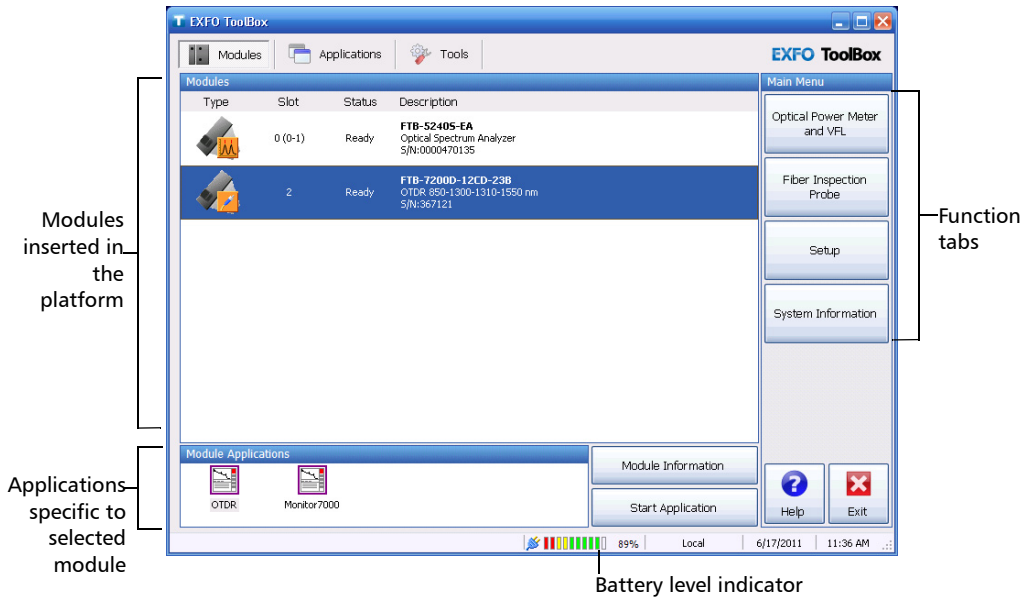

Modules inserted in the platform

Applications specific to selected module

Function tabs

Battery level indicator

Note: The slot numbers are 0-3 for the four-slot model and 0-7 for the eight-slot model. The slots are identified on both sides of the unit.

Turning Off the FTB-500

There are several ways to turn off the unit, including the following:

- *Standby*: keeps the unit's status information in memory (RAM). The next time you turn your unit on, you will quickly return to your work environment (running applications will still be running). This mode will take more battery power while the unit is off.
- *Hibernation*: saves the unit's status information that was in memory (RAM) to a special file on the disk. The next time you turn your unit on, this file will be used to ensure that you return to your work environment (running applications will still be running). The unit will take longer to start up than in *Standby* mode, but it requires less battery power when the unit is off. You can configure your unit to switch automatically from *Standby* to *Hibernation* mode after the specified delay.
- *Shutdown*: completely cuts power to the test modules and platform; the unit will perform a complete restart routine the next time you use it. You should perform a shutdown if you do not intend to use your unit for a week or more.

After a shutdown, the unit will start in Toolbox or in the application you defined as the startup application.

Note: *Should the unit ever stop responding, you can force a hardware reset by pressing and holding down the power button for more than 10 seconds.*

By default, your unit will display the standard shutdown window from which you can select the desired shutdown mode. However, you can configure your unit to perform a different action when the power button is pressed.

You can also configure your unit to automatically restart when AC power comes back after the unit has turned off (emergency shutdown, standby, or hibernation modes) when battery level is too low.

To turn off the unit:

1. Press and hold the On/Off button.

OR

On the Windows taskbar, tap **Start**.

This will display the standard shutdown window, from which you have a choice of actions or shutdown modes.

2. Select **Shutdown**.

To define the behavior of the power button:

1. From the main window, select the **Tools** tab.

2. Tap **Control Panel**.

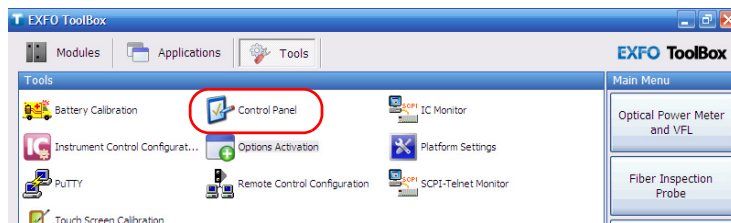

3. Tap **Power Options**.

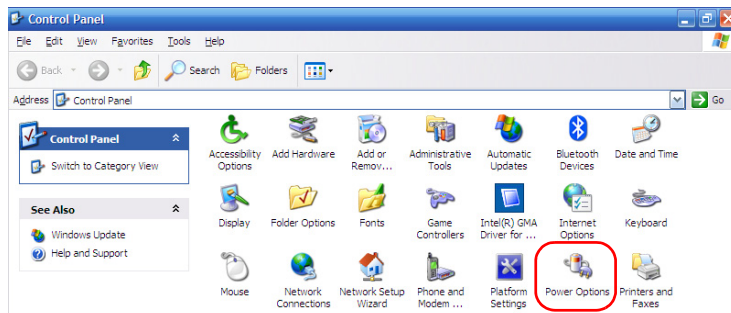

Getting Started with Your FTB-500

Turning Off the FTB-500

4. Select the **Advanced** tab.

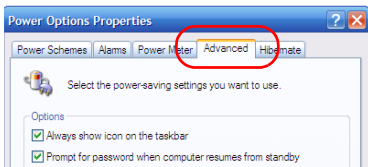

5. From the **When I press the power button on my computer** list, select the desired behavior (**Ask me what to do** option is selected by default).

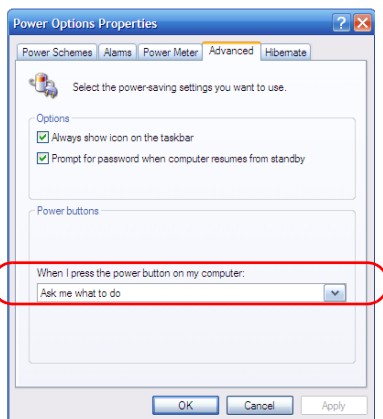

6. Tap **Apply** to confirm the changes, and then **OK** to return to **Control Panel**.

To configure your unit to automatically restart after AC power comes back:

1. From the main window, select the **Tools** tab.
2. Tap **Platform Settings**.

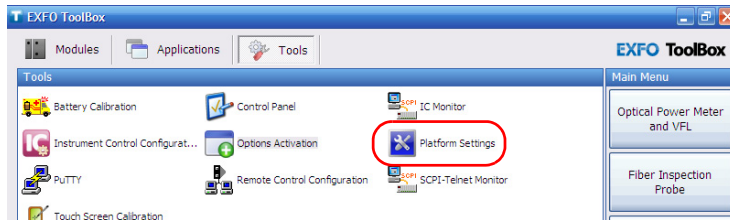

3. Select the **Power on the unit when AC outlet is connected or after power outage** box to enable the corresponding option.

OR

Clear the box if you prefer that your unit does not restart automatically after AC power comes back.

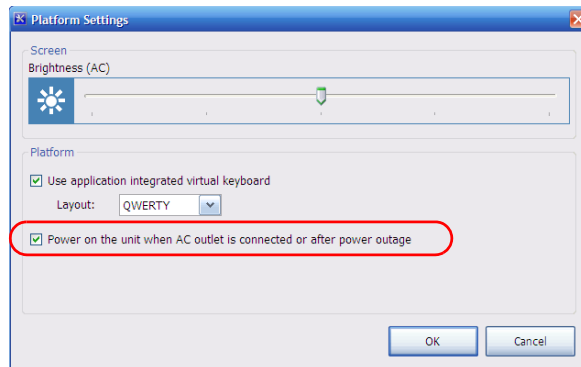

4. Tap **OK** to confirm the changes and return to the **Tools** tab.

Getting Started with Your FTB-500

Grounding Your FTB-500

Grounding Your FTB-500

When you perform an outside plant test with modules such as the FTB-8100 or the FTB-8110, you have to ground your FTB-500 because it can be exposed to overvoltages from the telecommunication network.

Note: To ground your unit, you need a grounding wire (18AWG minimum) with a U shape terminal.



WARNING

Not grounding your unit may cause serious injuries to communication network staff or other users.

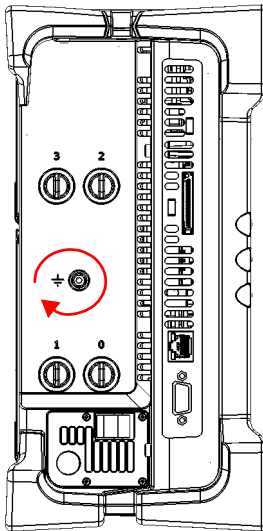

Four-slot model

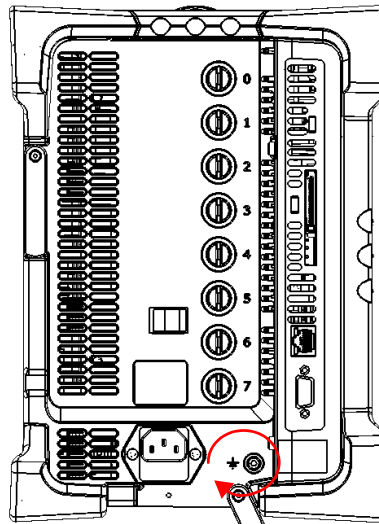

Eight-slot model

To ground your FTB-500:

1. Place the U shape terminal under the grounding stud's screw head.
2. Screw the grounding stud tight.

Securing your FTB-500 Using the Kensington Lock

Your FTB-500 is equipped with a Kensington lock to help you prevent theft.

To secure your unit:

Connect your lock to the security slot located at the back of your unit.

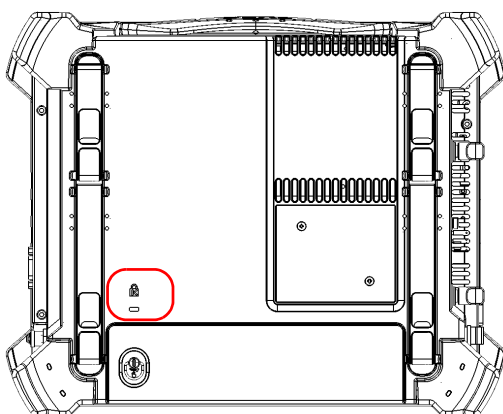

Four-slot model

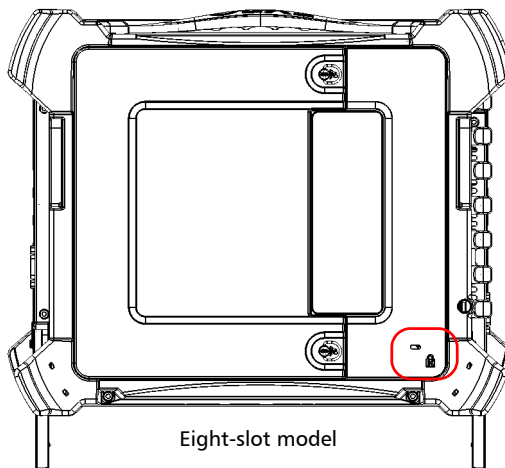

Eight-slot model

Installing or Upgrading the Applications

All the necessary applications have been preinstalled and configured at the factory. However, you may have to upgrade some applications when new versions become available or to reinstall them.

Note: *All of your product packs have been placed on the D drive for reinstallation purposes if necessary.*

Note: *Only administrator-level users can install software under Windows XP.*

Each time you purchase a new module, it could be a good idea to verify that the most recent Update Manager application is installed on your unit.

When updates are available for an application, you will need to download them from Internet, either directly on your unit or on a computer. The update files must be copied to the location that has been specified for the deployment packages in Update Manager.



IMPORTANT

If you ever need to reinstall Update Manager on your unit, ensure that:

- The installation files for Update Manager remain on your unit. Otherwise, it will not be possible to install new versions of this application later.
- You choose the folder containing the Update Manager installation files carefully. If you move or rename this folder, you will have to manually browse for the modified folder when you want to install new versions of this application.

For the installation or upgrade, you will need:

- an FTB-500 unit
- a computer equipped with a USB port; Windows must be installed on the computer
- a USB memory key

Note: *The computer and USB key are only necessary if you do not wish to download the files directly on your unit.*

Note: *For more information on the installation, refer to the Update Manager online help.*

To update or reinstall Update Manager:

1. If necessary, retrieve the desired installation files from the Internet.

If you do not intend to download files directly on your unit, connect a USB memory key to one of the USB ports of the computer and copy the installation files to this USB key.
2. If it is not already done, turn on your unit.
3. Exit Toolbox and the modules' applications.
4. If you want to install Update Manager using the USB key, disconnect it from the computer and connect it to one of the USB ports of your unit.
5. On your unit, create a folder on the Windows desktop.
6. Copy the installation files (from the USB key) to the newly created folder.
7. From the newly created folder, tap the *Setup.exe* file to start the installation.
8. Follow the on-screen instructions.
9. When the installation is complete, simply disconnect the USB memory key.

Getting Started with Your FTB-500

Installing or Upgrading the Applications

To install or upgrade the applications:

- 1.** If necessary, retrieve the desired installation files from the Internet.

If you do not intend to download files directly on your unit, connect a USB memory key to one of the USB ports of the computer and copy the installation files to this USB key.
- 2.** If it is not already done, turn on your unit.
- 3.** Exit Toolbox and the modules' applications.
- 4.** If you want to install or update applications using the USB key, disconnect it from the computer and connect it to one of the USB ports of your unit.
- 5.** Copy the installation files (from the USB key) to the folder containing the update and installation packages on your unit. By default, Update Manager will search for files at the root of the USB key. For more information, refer to the Update Manager online help.
- 6.** On your unit, from Windows desktop, tap the **Update Manager** icon to start the corresponding application. For more information on how to install or upgrade applications, refer to the Update Manager online help.
- 7.** When the installation is complete, simply disconnect the USB memory key.

Accessing and Exiting ToolBox

Your FTB-500 comes out of the factory set to start automatically with ToolBox.

However, you might need to work with Windows, and can even set the system to start with Windows instead of ToolBox, as explained in *Automating Application Startup* on page 65.

To access ToolBox when in the Windows environment:

Double-tap the  icon on your desktop.

OR

In the **Start** menu, select **Programs > EXFO > ToolBox**.

To exit ToolBox:

Tap  .

Starting Module Applications

Your modules can be configured and controlled from their dedicated applications in Toolbox.

To start a module application:

1. From the **Modules** tab, select the module to use.

It will turn blue to indicate that it is highlighted.

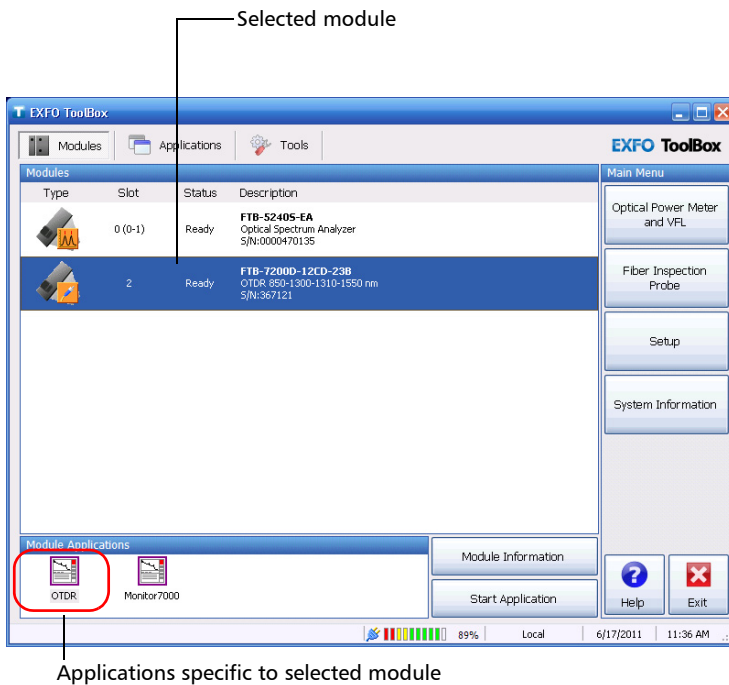

2. Under **Module Applications**, select an application, and then tap **Start Application**.

Installing EXFO LabVIEW Drivers

Before being able to work with EXFO LabVIEW drivers, you must install the following elements on your computer or on your FTB-500:

- National Instruments LabVIEW software and the corresponding patches.
- EXFO LabVIEW drivers (including demo applications to help you get started with the drivers).

For more information, see *Working with EXFO LabVIEW Drivers* on page 228

Note: Only administrator-level users can install software under Windows XP.

To install the LabVIEW software:

Follow the instructions provided with your LabVIEW installation CD.

To install the EXFO LabVIEW drivers:

1. Insert the installation CD in the CD-ROM drive.
2. Start the installation process as follows:
 - 2a. On the Windows taskbar, click **Start** and select **Run**.
 - 2b. In the **Open** box, locate *Labview Drivers\setup.exe* on the storage device where the drivers are located.
 - 2c. Click **OK** to start the InstallShield Wizard and follow the on-screen instructions.

For easier use, the drivers will be installed in LabVIEW's default instrument library folder:

C:\Program Files\National Instruments\LabVIEW 6\instr.lib\EXFO.

Activating Software Options

The software options purchased at the same time as your unit have been activated for you already. However, if you purchase options afterwards, you will have to activate them yourself.



IMPORTANT

If you want to activate software options for *modules of the FTB-81xx Series or the FTB-85xx Series*, refer to the user guide of your product for the specific activation instructions.

In all other cases, you can follow the instructions presented in this section.

Before being able to activate options, you need to contact EXFO with the following information:

- Purchase order number of the newly purchased options
- Module or platform serial number (depending on whether the software options were purchased for a module or the platform)
- Customer's name
- Customer's company name
- Customer's phone number
- Customer's e-mail address
- Module or platform on which the option will be installed

You will receive a single key (.key) file with which you will be able to unlock all the new options that you have purchased.

To activate the options for your unit:

- 1.** Connect a USB memory key to one of the USB ports of your computer.
- 2.** Copy the key file to the USB memory key.
- 3.** Disconnect the USB key from the computer and connect it to your unit.
- 4.** Select the **Tools** tab, then **Options Activation**.

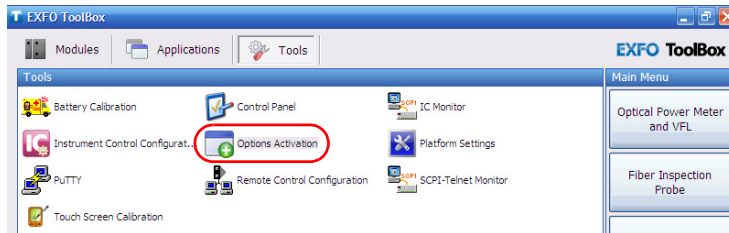

Getting Started with Your FTB-500

Activating Software Options

5. In the **Platform Options** tab, use the **Browse** button to locate the key file that you want to use.

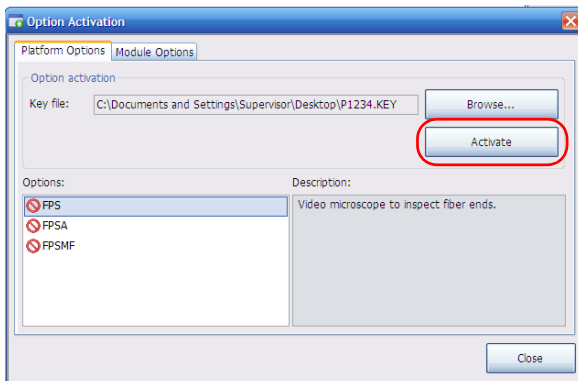

6. Press **Activate**.

The option indicator will turn into a green check mark to confirm that the option is now active.

7. Press **OK** to close the **Option Activation** window.

Note: At this point, if you have used a USB key to copy your key file, you can remove it as it is not required to use your new options.

To activate software options for your module:

1. Connect a USB memory key to one of the USB ports of your computer.
2. Copy the key file to the USB memory key.
3. Disconnect the USB key from the computer and connect it to your unit.
4. Select the **Tools** tab, then **Options Activation**.

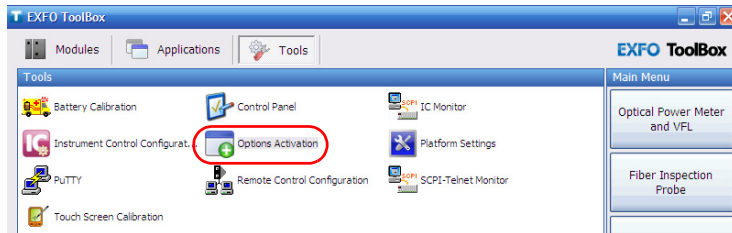

Getting Started with Your FTB-500

Activating Software Options

5. In the **Module Options** tab, use the **Browse** button to locate the key file that you want to use.

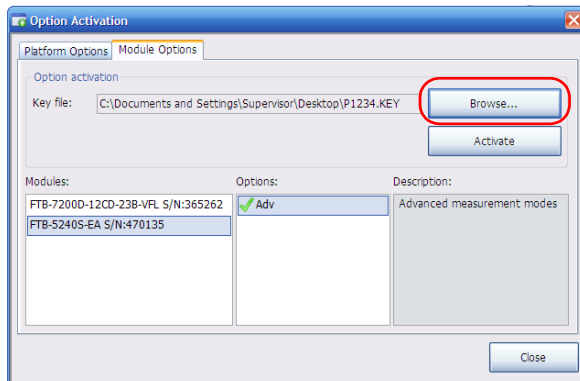

6. Press **Activate**.

The option indicator will turn into a green check mark to confirm that the option is now active.

Note: You can see the supported options for the module in the **Options** list.

7. Press **OK** to close the **Option Activation** window.

Note: At this point, if you have used a USB key to copy your key file, you can remove it as it is not required to use your new options.

Installing Third-Party Software on Your FTB-500

Since your FTB-500 is equipped as a conventional laptop computer would be, you can install third-party software on it, provided that it is compatible with Microsoft Windows XP Professional. However, EXFO does not provide any support for the installation, use or troubleshooting of such third-party software. Should you need help, refer to the corresponding third-party software documentation or technical support.

Protecting your Unit with an Antivirus Software

Since each customer has different security standards and rules for their computers and test systems, EXFO does not provide an antivirus on the FTB-500. In this manner, you can apply your own standards and antivirus strategy once you receive your unit, as you can install third-party software on it, as you could on any standard laptop computer.

4 Setting Up Your FTB-500

Positioning Your Unit

You can change the orientation of your unit with the bottom or back supports.

To position the unit using the supports:

Pull out the support pair that will provide you with the best viewing angle according to your situation.

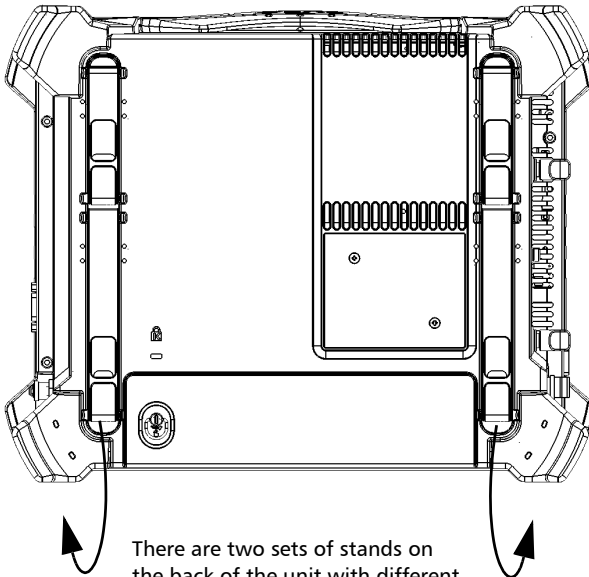

There are two sets of stands on the back of the unit with different lengths. Select the one that provides you with the best angle.

Four-slot model

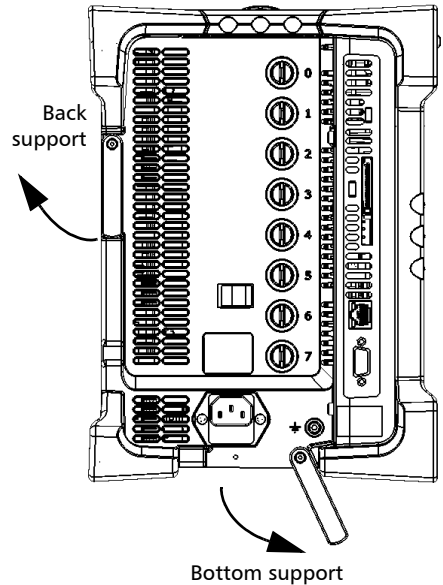

Eight-slot model



IMPORTANT

The supports should always be used in order to ensure that the unit is stable during your tests and will not fall down to cause damage to the test components or injure you.

Setting Up Your FTB-500

Installing a Monitor

Installing a Monitor

Although the FTB-500 is equipped with a top-of-the line LCD, you might want to use an external monitor. The monitor must support the SVGA format.

Note: Use the Windows Control Panel to configure the display settings of your external monitor.

To install a monitor:

Connect the external monitor to the Video Out port, located on the left side of the unit.

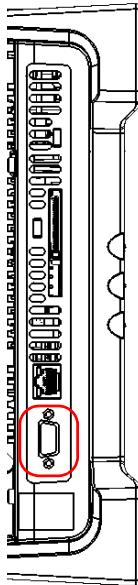

Calibrating the Touchscreen

The touchscreen simplifies and accelerates testing procedures by providing immediate access to commands. It detects the position of your finger or any other blunt pointing device, activating a command, function, or button. The FTB-500 comes equipped with a stylus located in the top right side of the unit.

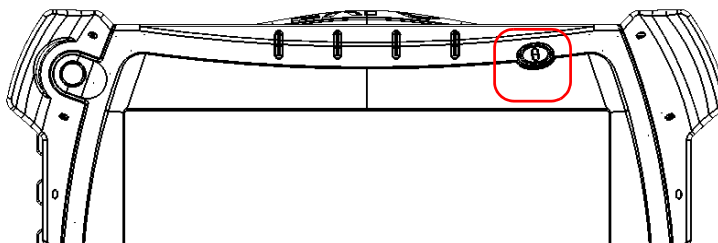

When you receive your FTB-500, it will have been calibrated. However, if you are used to work at a certain angle that could change the location of the pointing device versus what the sensor detects, or if you feel that the screen does not behave as you want, you can calibrate it again.

Note: *If you are having trouble accessing the touchscreen calibration feature because the touchscreen is not behaving as expected, use a USB mouse. See [Installing a Pointing Device](#) on page 60 for details.*

Note: *To better see what is on the screen, you can also change the brightness of the screen backlight, as explained in [Changing the Backlight Level](#) on page 54.*



IMPORTANT

As it is the case for any computer, you can change the screen resolution in the Windows Control Panel. However, be aware that this will affect the performance and accuracy of the touchscreen. The optimized resolution for using your touchscreen is of 800 x 600.

Setting Up Your FTB-500

Calibrating the Touchscreen

To calibrate the touchscreen:

1. Select the **Tools** tab.

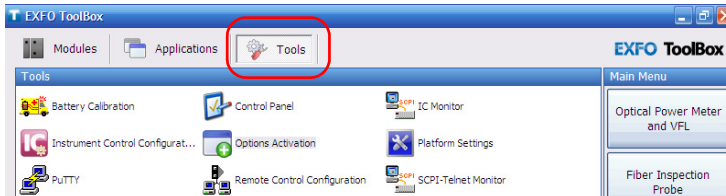

2. Select **Touch Screen Calibration**.

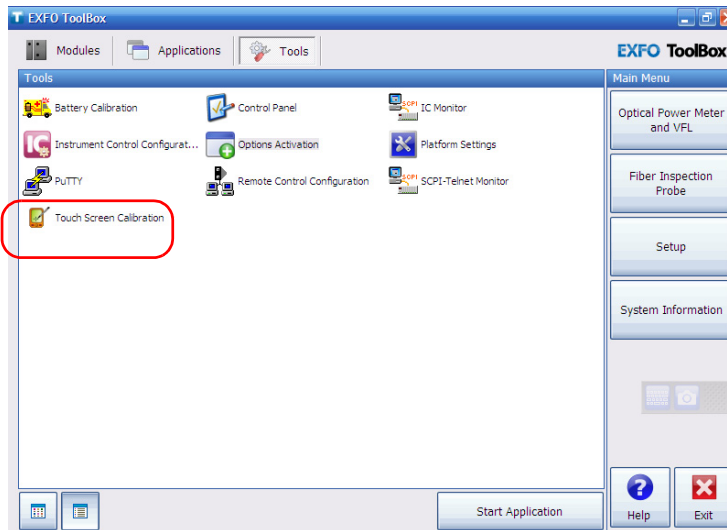

3. Follow the instruction on-screen to proceed with the calibration procedure.

Note: *If you do not touch the screen within a set period of time, the calibration procedure is aborted and you are returned to ToolBox.*

4. Once the calibration is complete, this window disappears and you are returned to ToolBox.

Adjusting the Monitor Settings

Different work environments call for different monitor settings which can be set according to your needs.

To adjust the monitor settings:

1. Select the **Tools** tab, then **Platform Settings**.

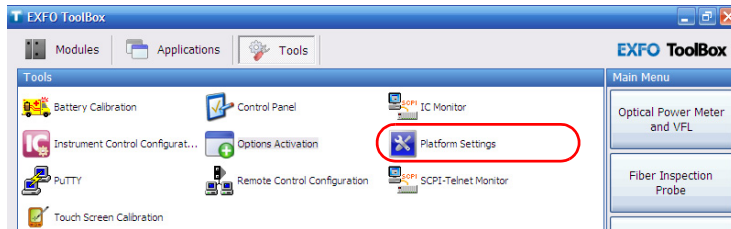

2. Adjust the brightness settings as needed.

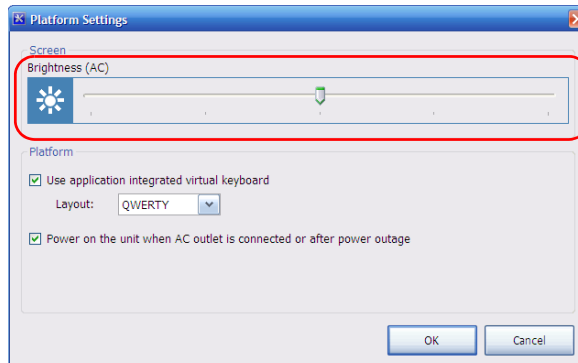

3. Tap **OK** exit the window.

Setting Up Your FTB-500

Changing the Backlight Level

Changing the Backlight Level

The backlight has five different brightness levels.

To change the backlight level:

Press the backlight button repeatedly to switch between the available levels.

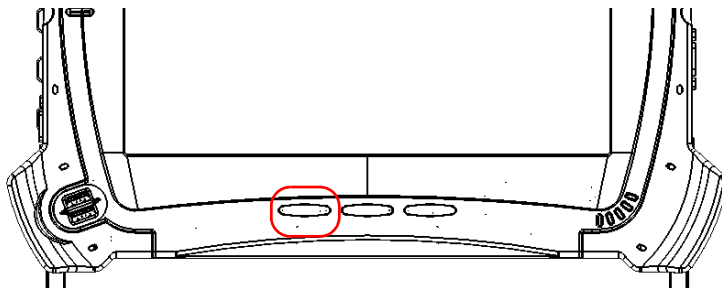

Note: *For better autonomy, select a lower backlight level which uses less battery power.*

Installing a Hardware Keyboard

When you are required to enter alphanumeric data, an on-screen keyboard will be displayed. However, you can also use a hardware keyboard.

To install an external keyboard on your FTB-500:

Connect the keyboard to a USB port, located on the right side or on the front of the unit.

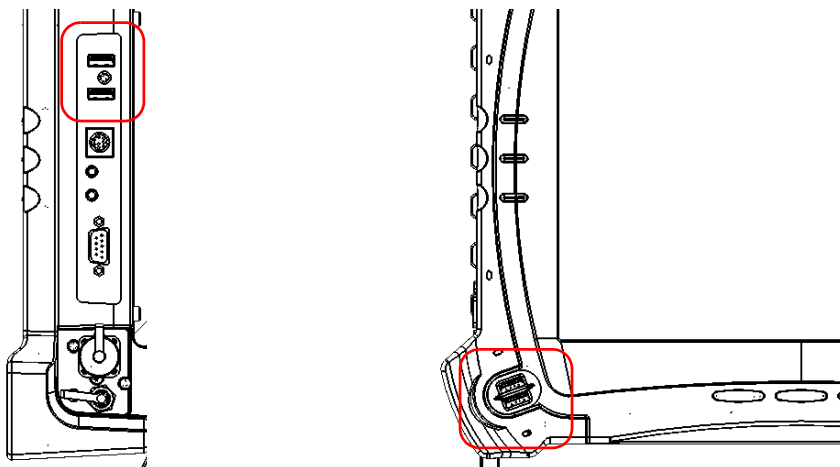

Note: *It is not necessary to turn off the FTB-500 before connecting the keyboard. The software will automatically detect its presence.*

Although your external keyboard is automatically recognized and immediately usable, you might not benefit from all its special features unless you install the proprietary driver that usually comes with it. To install the proprietary driver, refer to the user guide that comes with your unit. Of course, the keyboard that comes as an option with your FTB-500 is fully functional.

Using the On-Screen (Virtual) Keyboard

Your unit is equipped with an on-screen keyboard that supports multilingual features. This keyboard functions according to the keyboard settings of Windows. It works with all applications on your unit.

However, if you prefer, you can enable an on-screen keyboard that has been specially designed for the module applications (when the applications support it). For more information on how to enable this keyboard, see *Using the Module On-Screen (Virtual) Keyboard* on page 56.

To use the unit on-screen keyboard:

1. Select the location where you want to enter text.
2. Tap the virtual keyboard icon on the lower-right part of the screen (over the clock).



3. Enter the data as required.
4. Exit the location when you are done entering data.

Using the Module On-Screen (Virtual) Keyboard

Instead of the unit on-screen keyboard, you can also use the virtual keyboard that originally came with your modules. That keyboard can be in either QWERTY, AZERTY or ABCDEF format.

To install a hardware keyboard, see *Installing a Hardware Keyboard* on page 55.

To activate the module on-screen keyboard:

1. Select the **Tools** tab, then **Platform Settings**.

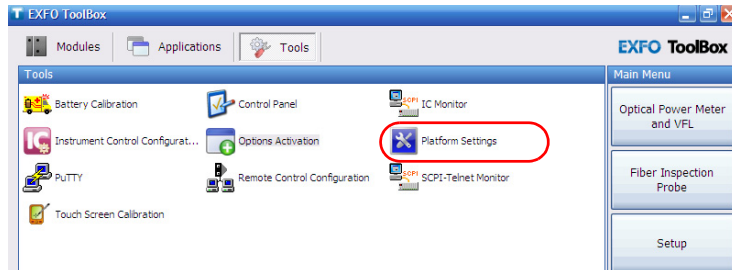

2. Select **Use application integrated virtual keyboard**, then select a layout, either **AZERTY**, **QWERTY** or **ABCDEF**.

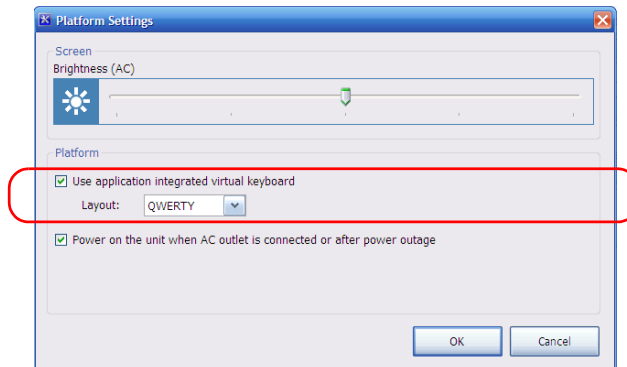

3. Tap **OK** to confirm your selection, or **Cancel** to exit the window.

Note: To use the keyboard once it is activated, simply type in the data you want and tap either **OK** or **Return** to enter it. Tap **Cancel** to return to your application without typing anything. When you are in an application that uses the module virtual keyboard, you can activate it simply by selecting the box in which you want to enter data.

Customizing the On-Screen Keyboard

You can customize the appearance and behavior of the (unit) on-screen keyboard. For more information on the various parameters that you can set, refer to the on-screen keyboard online help.

For information on how to switch from one of the available languages to another, see *Selecting the Language of Operation* on page 69.

To customize the appearance and behavior of the on-screen keyboard:

1. Minimize the Toolbox window.
2. On the Windows taskbar, tap **Start**, then select **All Programs > Touch-It Virtual Keyboard > Setup**.
3. Configure the keyboard according to your needs.

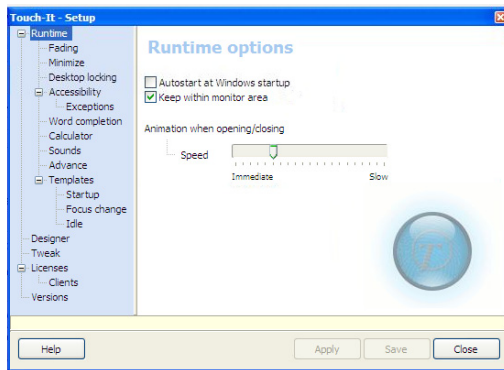

Note: You can access the online help related to the keyboard options by tapping the **Help** button.

4. When you have finished, tap **Close**.

Right-Clicking with the Touchscreen

If you are used to work with a mouse, you may find it useful to be able to perform a right-click on your touchscreen.

To right-click with the touchscreen:

From the location where you want to right-click, using the stylus or any blunt pointing device, press the screen for a few seconds until the shortcut menu appears.

If you want to hide the shortcut menu without performing any action, simply tap anywhere outside the menu.

Setting Up Your FTB-500

Installing a Pointing Device

Installing a Pointing Device

A touchscreen offers many advantages when working in applications that have been specially designed for it (such as the EXFO test applications).

However, for applications such as spreadsheets, word processors, etc., a touchscreen might not be the most efficient pointing device. The FTB-500 was designed so that you can add external pointing devices (mouse, trackball, etc.).

To install a USB pointing device on your FTB-500:

Connect the pointing device to a USB port, located on the right side or on the front of the unit.

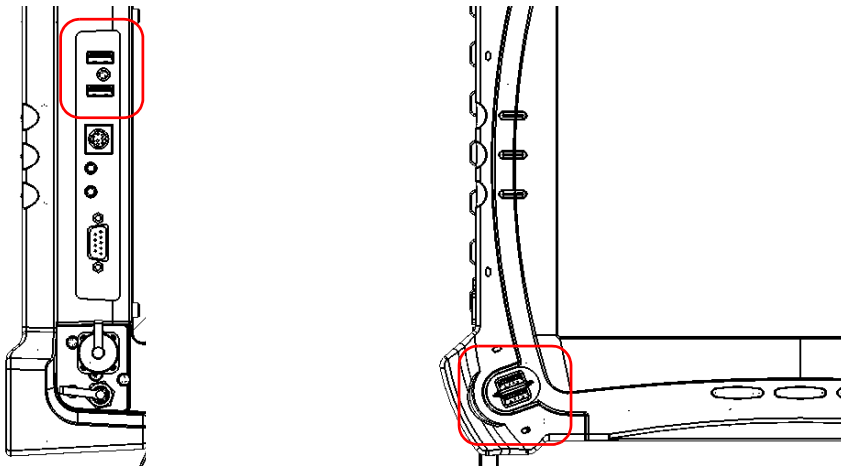

Although your external pointing device is automatically recognized and immediately usable, you might not benefit from all its special features unless you install the proprietary driver that usually comes with it.

To install the proprietary driver, refer to the user guide that comes with your device.

Note: *It is not necessary to turn off the FTB-500 before connecting a USB pointing device. The software will automatically detect it.*

Installing a Headset or Speakers

The FTB-500 comes with an internal speaker for audible feedback, but there are times when you might want to use more powerful speakers. Other types of environment may warrant the use of a headset instead of the external speaker. You can use any commercially available headset or speakers having a 3.5 mm connector.

To connect a headset or speakers to your FTB-500:

Connect the external speakers or the desired headset in the Audio Out port located on the right side of the unit.

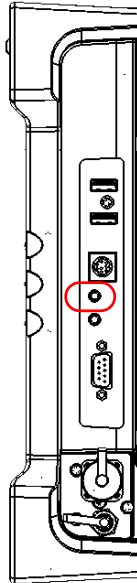

Setting Up Your FTB-500

Installing a Microphone

Installing a Microphone

On top of being a multitasking test platform, the FTB-500 is a portable multimedia computer. From the Windows environment, it can use off-the-shelf third party applications that require a microphone. With these applications, you can use an external microphone. You can use any commercially available microphone having a 3.5 mm connector.

To use an external microphone:

Simply connect it to the Audio In port, located on the right side of the unit.

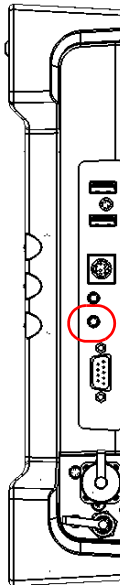

Installing a Printer

If you need to print reports directly from your FTB-500, you can install an external printer.

To install a USB printer on your FTB-500:

1. Follow the printer's manufacturer instructions regarding the installation of required drivers or software.

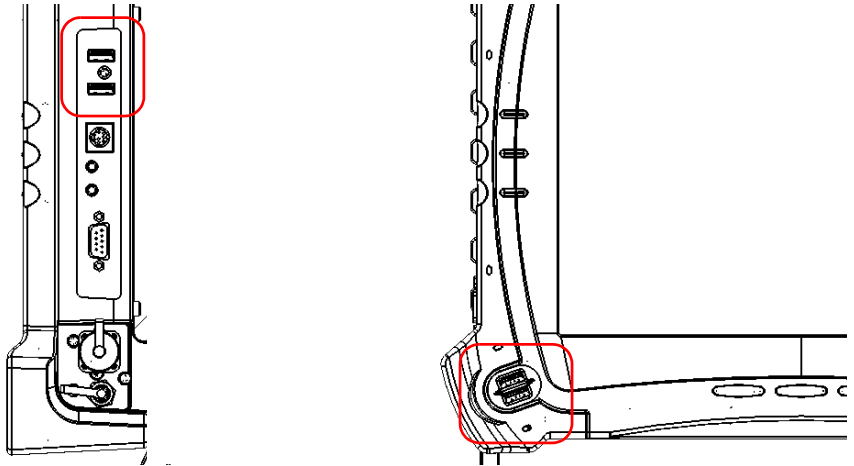

2. Connect the printer to a USB port, located on the right side or on the front of the unit.

Automating Application Startup

You can have selected applications automatically start upon starting the FTB-500 up. This saves you time, as you do not need to ensure that they are already running before starting your tests.

To set some applications to start automatically at startup:

1. From the main window, tap **Setup**.

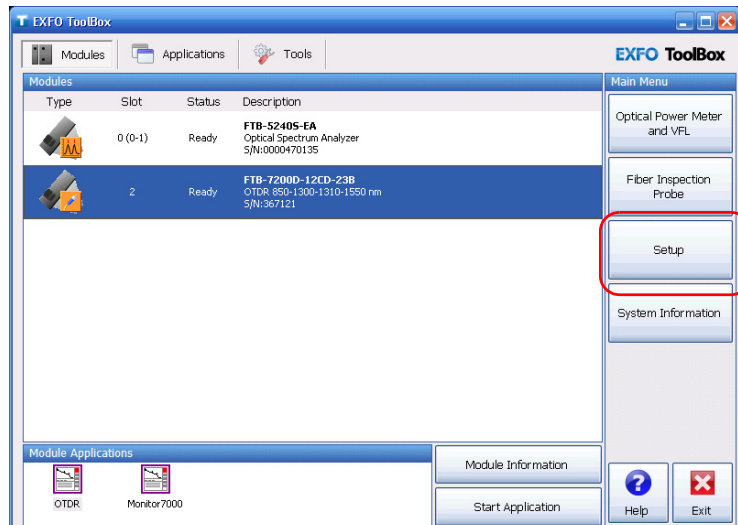

Setting Up Your FTB-500

Automating Application Startup

2. Select the **Application Startup** tab.

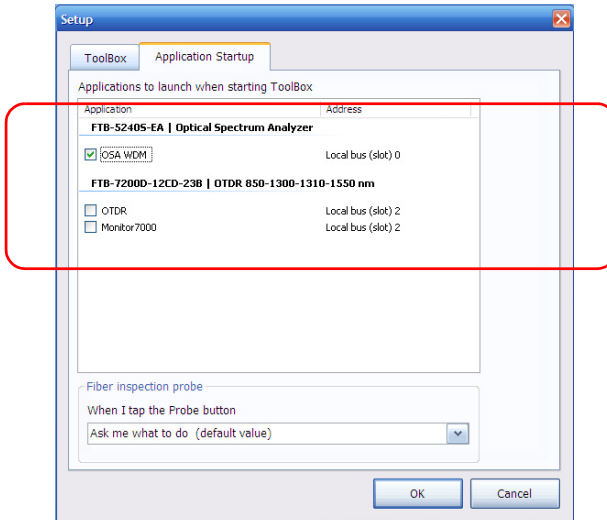

3. Select the items you want to start at startup by checking the corresponding boxes.
4. Tap **OK** to use the new settings. Tap **Cancel** to exit without using the new settings.

Note: *The new settings will only apply the next time you start your unit.*

Selecting the FIP Startup Application

Your unit supports both the fiber inspection probes (FIP) of the FIP-400 and FIP-400B series. By default, the unit prompts you to select the application corresponding to the FIP with which you want to work (FIP-400 or FIP-400B). If you prefer, you can configure the unit to always start your favorite application directly instead.

To select the FIP startup application:

1. From the main window, tap **Setup**.

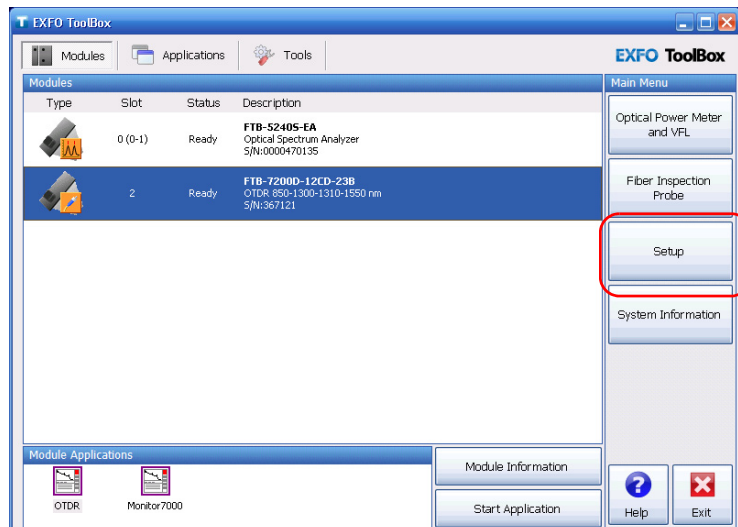

Setting Up Your FTB-500

Selecting the FIP Startup Application

2. Select the **Application Startup** tab.

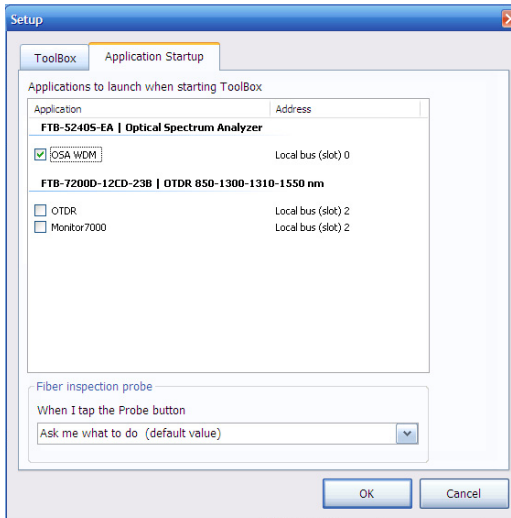

3. From the **When I tap the Probe button** list, select the desired behavior. If you want to be prompted each time to confirm the application to use, select the **Ask me what to do** option.

Note: *If the list is not available, it means that the ConnectorMax2 application is not installed on your unit. In this case, the ConnectorMax application will start automatically, enabling you to work with the probes of the FIP-400 series. If you also wish to work with probes of the FIP-400B series, you will need to install the most recent ConnectorMax kit.*

4. Tap **OK** to use the new settings. Tap **Cancel** to exit without using the new settings.

Your changes are automatically saved.

Selecting the Language of Operation

Note: *Only administrator-level users can modify the language of operation.*

You may display the user interface in one of the available languages.

When you change the interface language, the corresponding keyboard is not automatically added to the list of available keyboards. You must add the desired keyboard separately if you want to enter text in a specific language (both on-screen or “real” keyboards). Once the keyboards are added, you can switch easily from one input language to another.



IMPORTANT

The keyboards that you add will not be available from the logon window.

To avoid problems, when you define or modify passwords, EXFO recommends that you always use the keyboard corresponding to the language of the unit at time of purchase. Otherwise, you might not be able to log on to your user account (unsupported characters, different keyboard layout, etc.)

Values are kept in memory even when you turn the unit off.

Setting Up Your FTB-500

Selecting the Language of Operation

To select a new interface language:

1. From the main window, select the **Tools** tab.
2. Tap **Control Panel**.

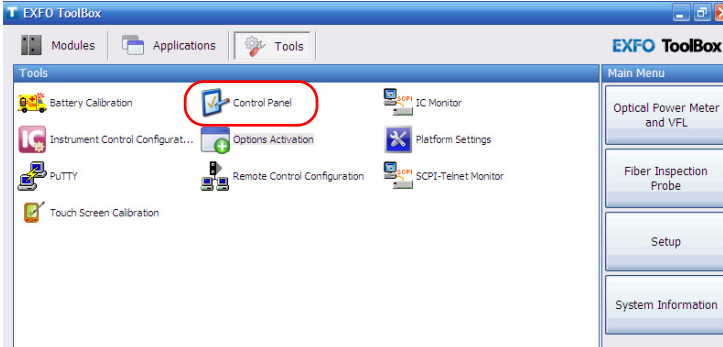

3. Tap **Regional and Language Options**.

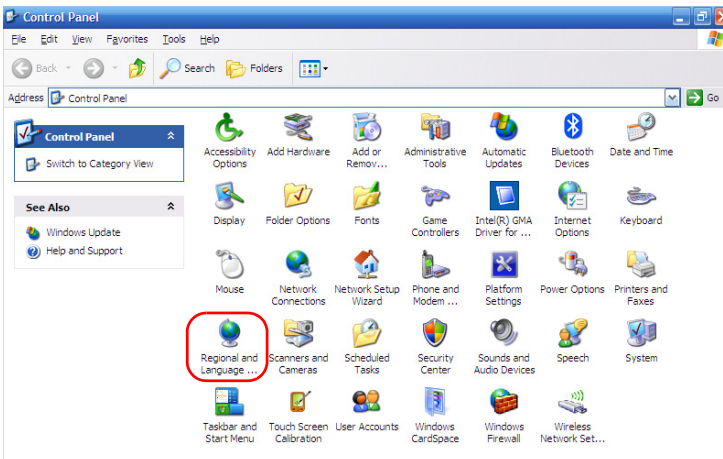

4. Select the Languages tab.

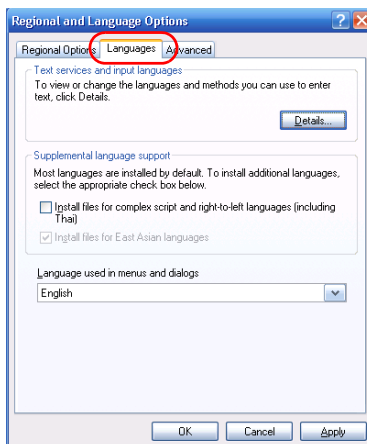

5. From the Language used in menus and dialogs list, select the desired language.

6. To ensure that all applications are displayed correctly, configure the language for non-Unicode programs as follows:

6a. Select the Advanced tab.

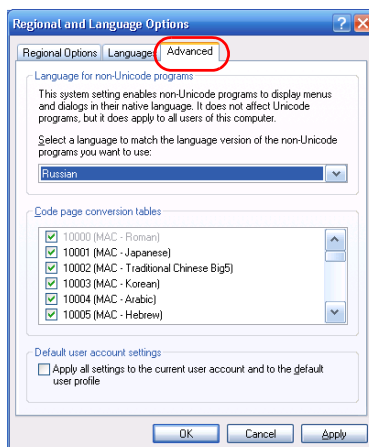

Setting Up Your FTB-500

Selecting the Language of Operation

- 6b.** Under **Language for non-Unicode programs**, select the desired language.

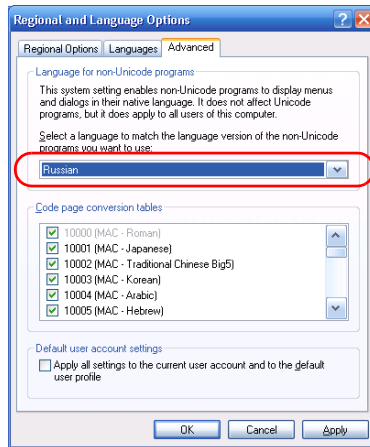

- 7.** Press **Apply** to confirm the changes. When the application displays a message indicating that the new language will be effective at next logon, tap **OK**.
- 8.** Tap **OK** to return to the **Control Panel** window.

To add new input languages:

1. From the main window, select the **Tools** tab.
2. Tap **Control Panel**.

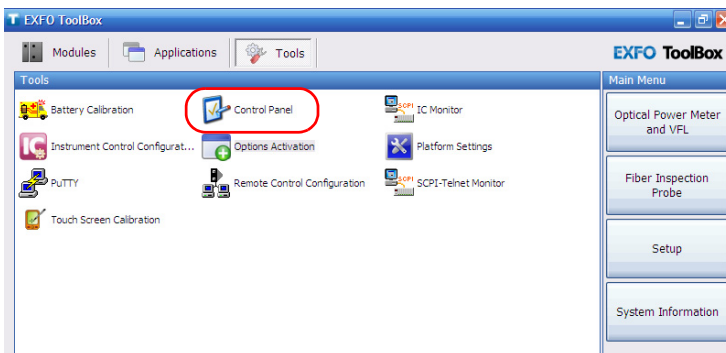

3. Tap **Regional and Language Options**.

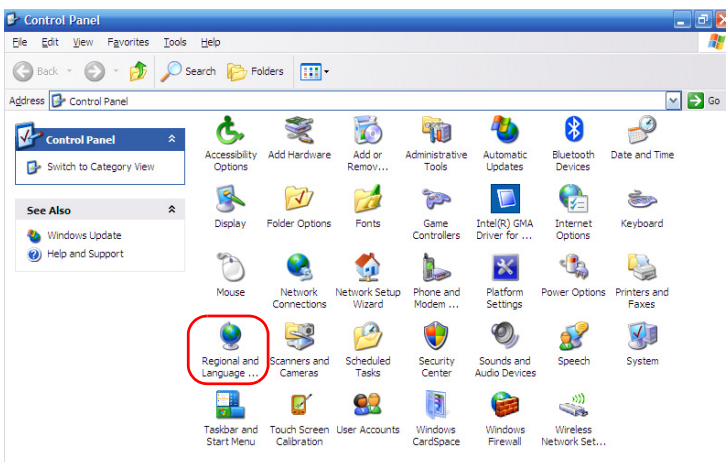

Setting Up Your FTB-500

Selecting the Language of Operation

4. Select the **Languages** tab.

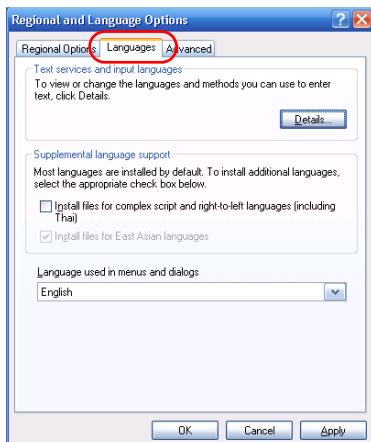

5. Under **Text services and input languages**, tap **Details**.

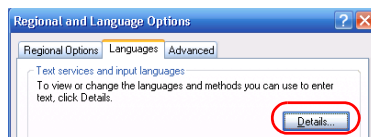

- Under **Installed services**, tap **Add**.

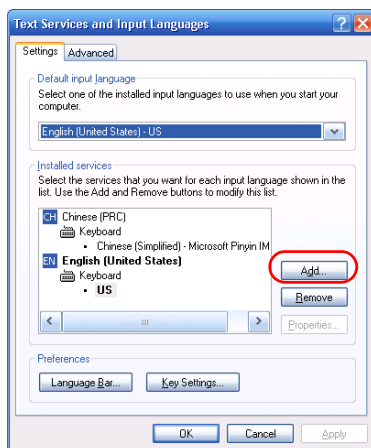

- From the **Input language** list, select the desired language.

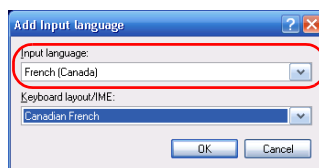



- If necessary, from the **Keyboard layout/IME** list, select the desired option.
- Tap **OK** to confirm.
- Repeat steps 6 to 9 for all the languages that you want to add.
- Tap **Apply** to confirm the changes, and then **OK** to return to the **Control Panel** window.

The added keyboards will be available at your next logon. You will then be able to switch from one input language to another.

Setting Up Your FTB-500

Selecting the Language of Operation

To switch from one of the available input languages to another:

1. Tap  to display the on-screen keyboard.
2. From the on-screen keyboard, tap  to display the list of available input languages.
3. From the list of languages, select the desired one.

You are now ready to start entering text in the selected input language.

Note: *Modifying the input language does not modify the language of the interface.*

Adjusting the Date, Time and Time Zone

Note: Only administrator-level users can adjust the date, time and time zone.

The current date and time are displayed at the bottom of the main window. When saving results, the unit also saves the corresponding date and time.

Note: Modifying date and time settings will affect some of the Windows XP settings.

To adjust the date and time:

1. From the main window, select the **Tools** tab.
2. Tap **Control Panel**.

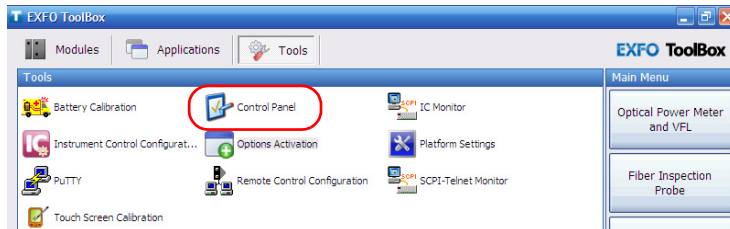

Setting Up Your FTB-500

Adjusting the Date, Time and Time Zone

3. Tap **Date and Time**.

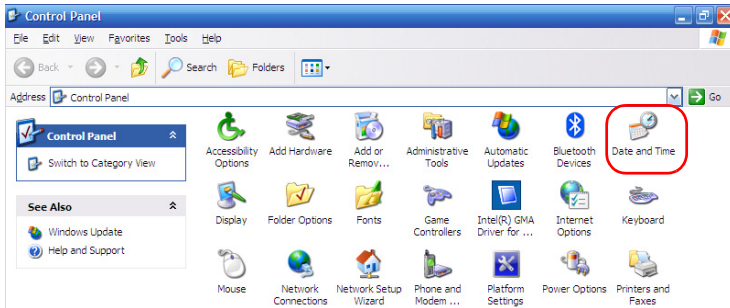

4. Select the **Date & Time** tab.

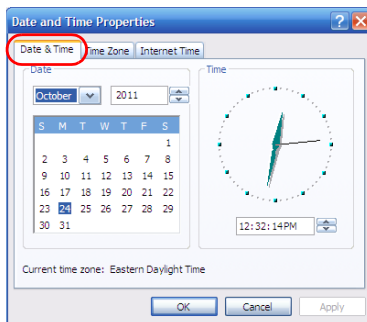

5. Modify the settings according to your needs.

6. Tap **Apply** to confirm the changes, and then **OK** to return to the **Control Panel** window.

To change the time zone:

1. From the main window, select the **Tools** tab.
2. Tap **Control Panel**.

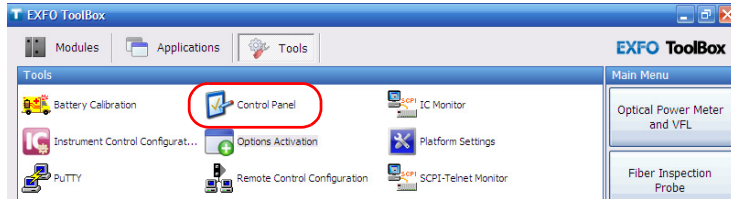

3. Tap **Date and Time**.

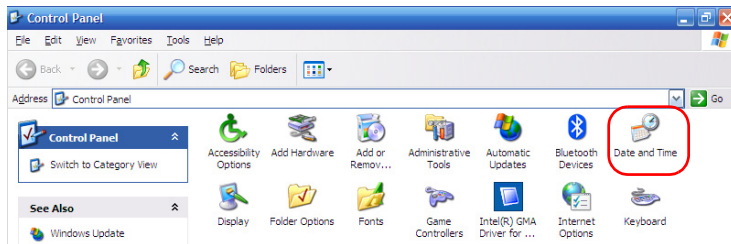

4. Select the **Time Zone** tab.

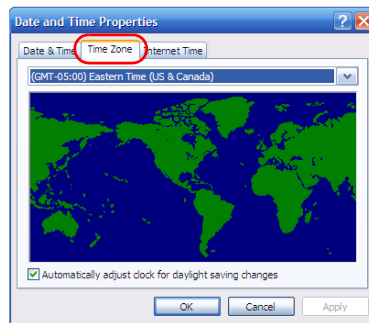

5. Modify the settings according to your needs.
6. Tap **Apply** to confirm the changes, and then **OK** to return to the **Control Panel** window.

Configuring the Power Management Options

Note: Only administrator-level users can configure the power management options. These options can only be modified for administrator-level accounts.

To get the optimum performance out of your FTB-500, your unit comes with predefined sets of parameters (schemes) to manage power.

When you do not use the unit for a while, the display and hard disks may be turned off to save power. You can also configure the unit to go into standby or hibernation mode after the specified duration has expired (see *Turning Off the FTB-500* on page 30).

For all of these actions, you can set idle durations for AC adapter/charger and battery operation. The values that you set are kept in memory even when you turn the unit off.

Note: When the backlight is turned off, the unit operation is not interrupted. Press any key or touch anywhere on the screen to return to normal operation.

The table below indicates the default values that are included in each of the predefined power schemes.

Power Scheme	Action	When AC is connected	Running on batteries
Portable/Laptop (selected by default)	Turn off monitor	Never	Never
	Turn off hard disks	Never	After 10 minutes
	System standby	Never	Never
	System hibernates	Never	Never

Power Scheme	Action	When AC is connected	Running on batteries
Standard	Turn off monitor	Never	After 5 minutes
	Turn off hard disks	Never	After 10 minutes
	System standby	Never	After 15 minutes
	System hibernates	Never	After 30 minutes
Always On	Turn off monitor	Never	Never
	Turn off hard disks	Never	Never
	System standby	Never	Never
	System hibernates	Never	Never
Max Battery	Turn off monitor	After 15 minutes	After 5 minutes
	Turn off hard disks	Never	After 10 minutes
	System standby	After 30 minutes	After 15 minutes
	System hibernates	After 45 minutes	After 30 minutes

You can either modify one of the existing power schemes or create one (based on an existing power scheme).



WARNING

Your unit has been designed to manage power as well as battery alarms automatically. Never modify the parameters that appear on the Alarms tab. Doing so WILL prevent the unit from working properly.

Setting Up Your FTB-500

Configuring the Power Management Options

To select a power scheme:

1. From the main window, select the **Tools** tab.
2. Tap **Control Panel**.

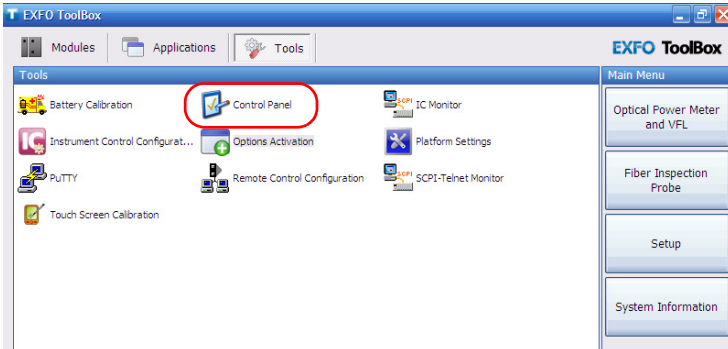

3. Tap **Power Options**.

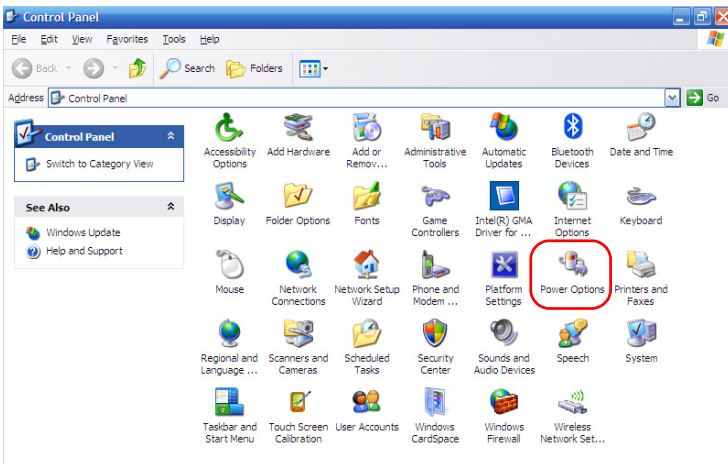

4. From the **Power Schemes** list, select the desired predefined set of parameters.

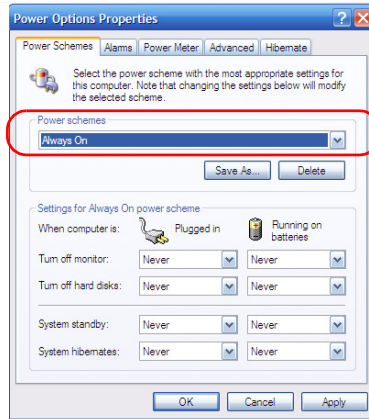

5. Tap **Apply** to confirm the changes, and then **OK** to return to the **Control Panel** window.

Setting Up Your FTB-500

Configuring the Power Management Options

To modify a power scheme:

1. From the main window, select the **Tools** tab.
2. Tap **Control Panel**.

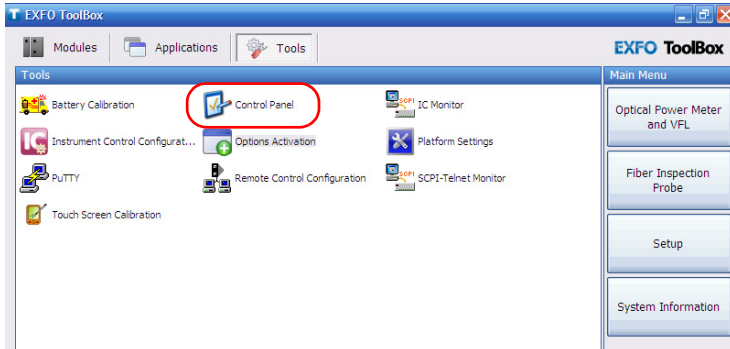

3. Tap **Power Options**.

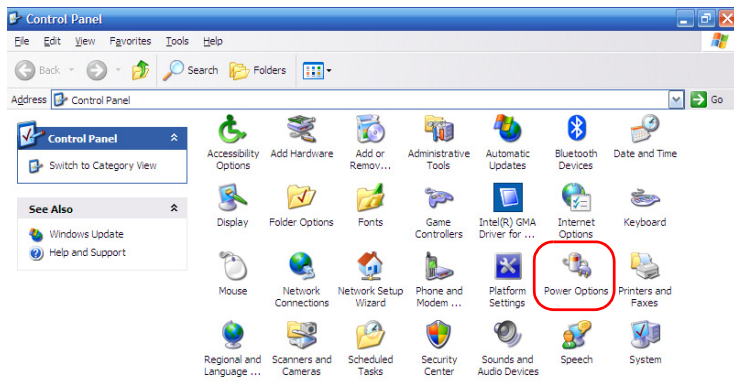

4. From the **Power Schemes** list, select the predefined set of parameters that you want to modify or on which you want to base your new scheme.
5. Modify the parameters to your needs.

6. Tap **Save As**.

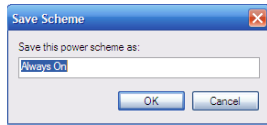

- If you want to modify the existing power scheme, keep the name as is, and then tap **OK**.

OR

- If you prefer to create a new power scheme, enter a new name, and then tap **OK**.

7. Tap **Apply** to confirm the changes, and then **OK** to return to the **Control Panel** window.

Setting Up Your FTB-500

Setting Toolbox Options

You can specify how Toolbox behaves when the application is started, minimized or closed.

To set the Toolbox options:

1. From the main window, tap **Setup**.

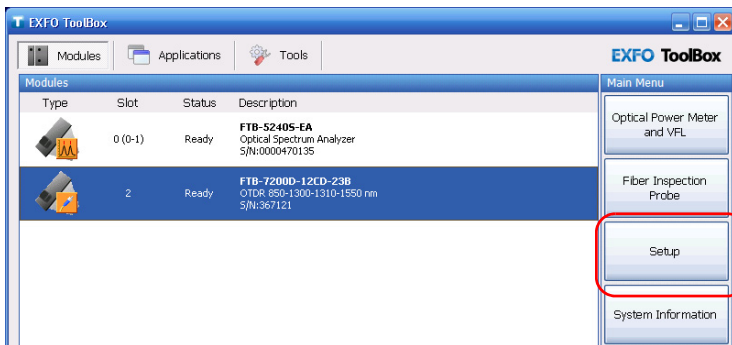

2. Select the **ToolBox** tab.

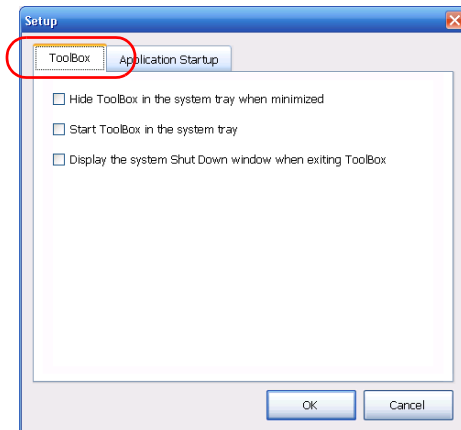

3. Select one or more option that corresponds to your needs:
 - ▶ **Hide ToolBox in the system tray when minimized:** If this option is selected, the ToolBox icon appears in the system tray (where the clock is located) when you minimize the window.
 - ▶ **Start ToolBox in the system tray:** If this option is selected, ToolBox is automatically started, then minimized to the system tray.
 - ▶ **Display the system shutdown dialog when exiting ToolBox:** If this option is selected, the standard system Shut Down window appears to let you shut down the unit directly instead of closing the ToolBox application, then shutting down the unit from Windows. For more information on the different ways to turn off your unit, see *Turning Off the FTB-500* on page 30.

Setting Communication Parameters

For information on how to configure your FTB-500 for remote control, see *Preparing for Automation* on page 175.

5 Working with Your Unit

Accessing Platform-Related Tools from ToolBox

Tools for your platform include remote control settings, battery management, Windows Control Panel, and platform-specific settings.

You can display the list of applications either in Tiles or List mode, depending on your preference.

To access the platform tools:

1. Select the **Tools** tab.

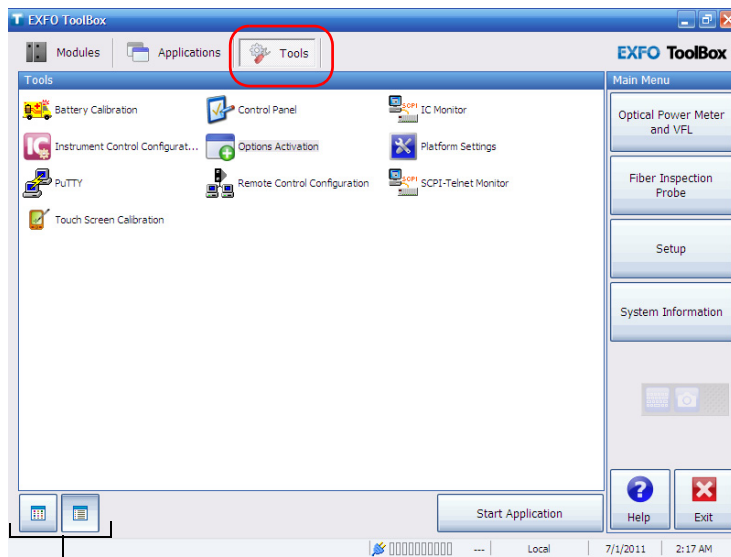

To switch between the display modes

2. Select the desired tool.
3. Tap **Start Application**.

For more information on each tool, see the corresponding sections.

Accessing Other Tools

Your unit comes with various tools that can help you better analyze or manage your data.

You have also access to free tools such as Wireshark to help you troubleshoot networks. For more information, refer to the online help provided with these tools.

You can display the list of applications either in Tiles or List mode, depending on your preference.

To access the applications:

1. Tap the **Applications** tab.

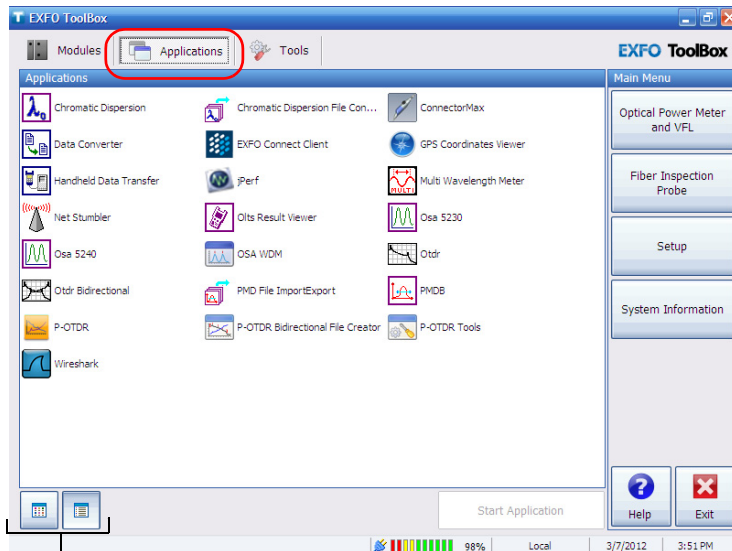

To switch between the display modes

2. Select the application that you want to start.
3. Tap **Start Application**.

Printing Documents

You can print documents and images directly from your unit by using either the PDFCreator (for PDF files) or an external printer (for printing on paper).

You can view the PDF files from your unit, using the SumatraPDF reader. For more information, see *Viewing PDF Files* on page 94.

To print on an external printer, you must connect the printer to your unit and install the required software and drivers provided by the manufacturer of the printer (see *Installing a Printer* on page 63).

If you need more flexibility and a greater choice of report types, using a USB memory key, you can also transfer result files to a computer onto which applications such as EXFO FastReporter2 are installed.

Note: *Some applications may not offer print functions.*

Working with Your Unit

Printing Documents

To print documents:

1. Open a Web browser as follows:
 - 1a. Minimize the ToolBox window.
 - 1b. On the Windows taskbar, tap **Start**, then tap **Internet Explorer** to open the browser.
2. Select the document that you want to print as follows:
 - 2a. From the menu, select **File > Open**.
 - 2b. Tap **Browse** to locate the file that you want to open.

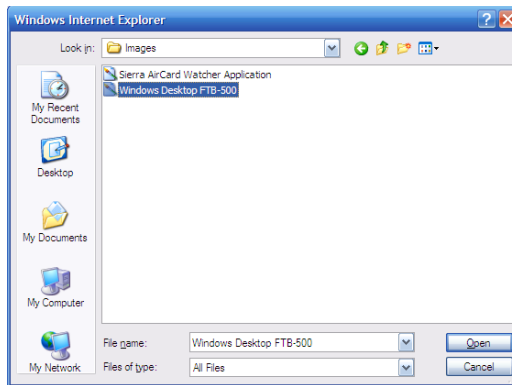



- 2c. Tap **Open** to load the file in Internet Explorer.
 - 2d. Tap **OK** to confirm.
3. From the menu, select **File > Print**.
4. From the **General** tab, select the desired printer (PDFCreator by default).
5. If necessary, tap **Preferences** to adjust the parameters to your needs.

Note: *If you selected an external printer, you can save the whole set of preferences for future use with the **Save As** button.*

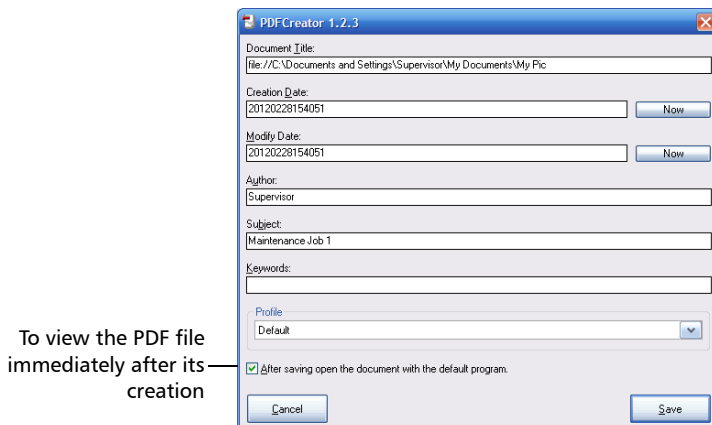
6. Tap **Print** to start the printing process.
7. If you selected PDFCreator, proceed as follows:
 - 7a. Enter the desired information.



- 7b. Tap **Save**.
- 7c. Specify a location and a file name and tap **Save**.
If you have selected the option to view the PDF file after its creation, the SumatraPDF reader will display the new file.
- 7d. If necessary, tap  to close the SumatraPDF window.
8. Tap  to close Internet Explorer and return to Windows desktop.

Viewing PDF Files

You can view PDF files directly from your unit using the SumatraPDF reader. For more information on the available features for this reader, refer to the SumatraPDF online help.



CAUTION

DO NOT update the SumatraPDF reader. Otherwise, you will lose the custom version prepared by EXFO for your unit. The application may no longer function properly. If you updated the SumatraPDF reader by mistake, see *Solving Common Problems* on page 263.

To view PDF files:

1. Minimize the ToolBox window.
2. From Windows, open Windows Explorer.
3. Browse through the folders to find the desired PDF file.
4. Tap the file.
5. The file opens automatically in the SumatraPDF application.

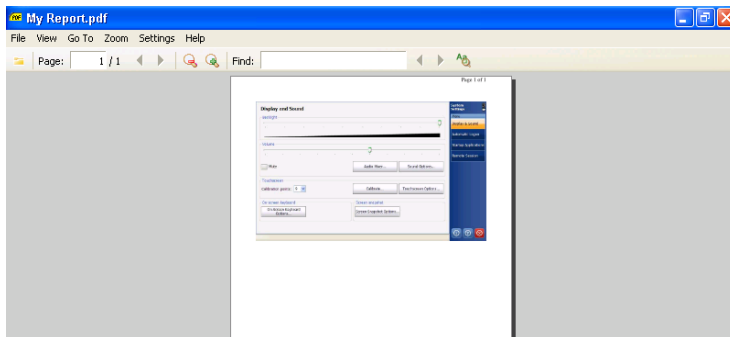

Note: You can access the online help directly from the **Help** menu of the SumatraPDF application. You will need a connection to the Internet to view the online help.

Taking Screen Captures

You can take captures of what is displayed on your screen, directly from your unit. This could be useful for troubleshooting when you need another person to have a look at a specific configuration or problem. You could also use this tool for training purposes. If you want to capture images of the fibers that you examine with the fiber inspection probe, you can use the capture feature of the probe instead.

To take screen captures:

1. From the floating toolbar, tap the  button to send the image to the clipboard.
2. Minimize the Toolbox window.
3. On the Windows taskbar, tap **Start**, then select **All Programs > Accessories > Paint**.
4. Paste the image, and then save it.
5. Close Paint, and then return to TooBox.

Browsing the Web

You can browse the Web directly from your unit, provided that you have access to an Internet connection.

For more information on how to connect to the Internet using a 3G USB modem key, see *Accessing the Internet with a 3G USB Modem Key* on page 97.

To browse the Web:

- 1.** Open a Web browser as follows:
 - 1a.** Minimize the ToolBox window.
 - 1b.** On the Windows desktop, tap the **Internet Explorer** icon to open the browser.
- 2.** Enter the desired Web address in the address bar and tap the  button (located at the right of the address bar) to start browsing.
- 3.** Close the window to return to Windows desktop.

Accessing the Internet with a 3G USB Modem Key

Note: *Only administrator-level users can install software under Windows XP. However, when the installation is complete, all users will have the possibility to access the Internet with a USB modem key.*

You can connect an optional 3G USB modem key to your unit to have a wireless access to the Internet.

When you receive your modem key, it contains no Subscriber Identity Module (SIM) card. This means that you will need to:

- Purchase a compatible and unlocked SIM card from a provider offering 3G services. If you need more information on the 3G coverage in your area, contact your regional sales representative.
- Have the card activated (you must subscribe to a package of mobile services).
- Insert the card in the modem key.

The very first time you connect a USB modem key to your unit, the AirCard Watcher application will be installed automatically on your unit. You will use this application to establish a connection with the mobile network whenever you want to work with your USB modem key. You only need to install this application once.

Working with Your Unit

Accessing the Internet with a 3G USB Modem Key



IMPORTANT

- Only the Sierra Wireless 319U keys provided by EXFO are supported on your unit.
- Before using the USB modem key for the first time, you must install the most recent System Upgrade and Platform kits for your unit. To do this, you will need a standard USB memory key and a computer with an Internet access. You can also retrieve the kits directly from your unit, but you will need an Internet access (other than the one that would be provided by the 3G USB modem key).

To upgrade your unit to the latest System Upgrade and Platform components:

1. If necessary, turn on your unit.
2. Retrieve the latest System Upgrade and Platform kits:
 - 2a. From your computer or your unit, open a Web browser and go to www.exfo.com.
 - 2b. Log on to your My EXFO account.
 - 2c. Under FTB-500, find the System Upgrade and Platform kits. If you need information on how to download the kits, refer to the Readme files provided with the kits.

3. Install the retrieved kits on your unit:
 - 3a. Install the System Upgrade. For more information, refer to the installation procedure provided with the kit.
 - 3b. Once the installation of the System Upgrade is complete, install the Platform kit on your unit. For more information, refer to the Readme file provided with the kit.

Note: *At this point, if you have used a USB memory key to transfer the installation files to your unit, you can remove it.*

You are now ready to install the AirCard Watcher application as explained hereafter.



IMPORTANT

Always turn your unit on *before* connecting the USB modem key to it. Otherwise, the USB modem may not be detected properly.

To install the AirCard Watcher application on your unit:

1. If necessary, turn on your unit and wait for the startup sequence to complete.
2. If necessary, insert the SIM card into the USB modem key. For more information, refer to the documentation that came with your modem key.
3. Connect the USB modem key to one of the USB ports of your unit.
The installation of the AirCard Watcher application will start automatically.

Working with Your Unit

Accessing the Internet with a 3G USB Modem Key

4. Follow the on-screen instructions.

You will know that the installation is complete when the AirCard Watcher application starts.



5. Close the AirCard Watcher application.
6. Disconnect the USB modem key from your unit.
7. Reconnect the USB modem key to your unit so that it can be detected properly.

All users are now ready to start working with the USB modem key as explained hereafter.



IMPORTANT

Always turn your unit on *before* connecting the USB modem key to it. Otherwise, the USB modem may not be detected properly.

To work with a 3G USB modem key:

1. If necessary, turn on your unit and wait for the startup sequence to complete.
2. If necessary, insert the SIM card into the USB modem key. For more information, refer to the documentation that came with your modem key.
3. If necessary, connect the USB modem key to one of the USB ports of your unit.

4. From the Windows desktop, tap the AirCard Watcher icon to start the application.
5. Once the AirCard Watcher application starts, tap **Connect** to establish a connection with the mobile network.

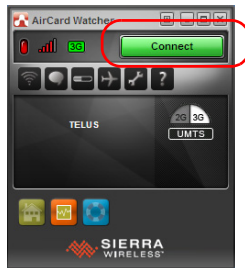

As soon as the connection is established, you are ready to browse the Web.

Note: *If you want to customize the behavior and appearance of the AirCard Watcher application, refer to the online help provided with the application (available by tapping ? from the toolbar).*

Note: *The application will display a warning message if no SIM card has been inserted in the USB modem key.*

Note: *Depending on the package that you have purchased with your service provider and the type of network, you may have to set specific parameters. If you are not sure on how to proceed or need more information about the configuration, see with your service provider.*

6. When you have finished working, tap **Disconnect** from the AirCard Watcher application, and then remove the USB modem key from your unit.

Retrieving the GPS Location of Your Unit

With the optional GPS USB key and the provided GPS utility, you can retrieve the last known latitude and longitude coordinates of your unit.

In addition to viewing the GPS information on-screen, you can copy it to the Clipboard in two formats: a text string or a URL link. The text string contains the GPS coordinates as well as a date and time stamp. Once the information is in the Clipboard, you can paste it to any document or test report (in editable sections). If your unit is connected to the Internet, you can even directly paste the URL link to a Web browser to locate your unit on a map.



IMPORTANT

- ▶ Only the Canmore GT-730F(L) keys provided by EXFO are supported on your unit.
- ▶ Before using the GPS USB key for the first time, you must install the most recent System Upgrade and Platform kits for your unit. To do this, you will need a standard USB memory key and a computer with an Internet access. You can also retrieve the kits directly from your unit, but you will need an Internet access.

Note: *Only administrator-level users can install software under Windows XP.*

To upgrade your unit to the latest System Upgrade and Platform components:

1. If necessary, turn on your unit.
2. Retrieve the latest System Upgrade and Platform kits:
 - 2a. From your computer or your unit, open a Web browser and go to www.exfo.com.
 - 2b. Log on to your My EXFO account.
 - 2c. Under FTB-500, find the System Upgrade and Platform kits. If you need information on how to download the kits, refer to the Readme files provided with the kits.
3. Install the retrieved kits on your unit:
 - 3a. Install the System Upgrade. For more information, refer to the installation procedure provided with the kit.
 - 3b. Once the installation of the System Upgrade is complete, install the Platform kit on your unit. For more information, refer to the Readme file provided with the kit.

All users are now ready to start working with the GPS USB key as explained hereafter.

Note: *At this point, if you have used a USB memory key to transfer the installation files to your unit, you can remove it.*

Working with Your Unit

Retrieving the GPS Location of Your Unit



IMPORTANT

Always turn your unit on *before* connecting the GPS USB key to it. Otherwise, the GPS key may not be detected properly.

To retrieve the GPS location of your unit:

1. If necessary, turn on your unit and wait for the startup sequence to complete.
2. Ensure that the GPS USB key is connected to your unit.
3. From Toolbox, select the **Applications** tab, then tap **GPS Coordinates Viewer**.

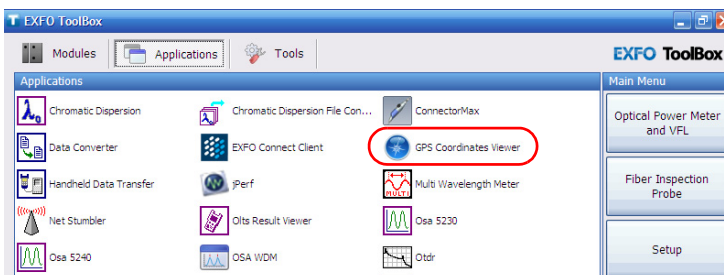

The GPS coordinates are displayed.

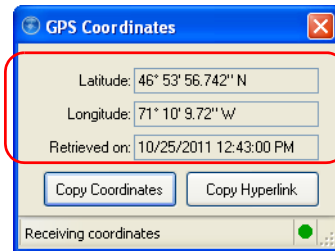

Note: *As this is the case with any other GPS device, you may have to wait a few minutes to get a valid GPS signal.*

- Tap **Copy Coordinates** to send the displayed information to the Clipboard as a text string.
- Tap **Copy Hyperlink** to send the displayed information to the Clipboard as a URL link.
- 4. When your work is finished, tap  to close the utility.

6 *Using the Optional Built-In Power Meter and VFL*

The FTB-500 can be equipped with an optical power meter to measure absolute power (dBm or W) or insertion loss (dB). The power meter can detect modulated signals (1 kHz, 2 kHz, and 270 Hz).

The FTB-500 can also include a visual fault locator (VFL) to inspect or identify fibers.



IMPORTANT

If you intend to take measurements with a very low power level, make sure that your testing conditions are optimal to ensure the best results (for example, do not use the VFL, make sure that the other modules in your platform are not performing measurements and that their internal parts are not moving, etc.).

Using the Optional Built-In Power Meter and VFL

Accessing the Built-In Power Meter

Accessing the Built-In Power Meter

To access the built-in power meter:

From Toolbox, tap **Optical Power Meter and VFL**.

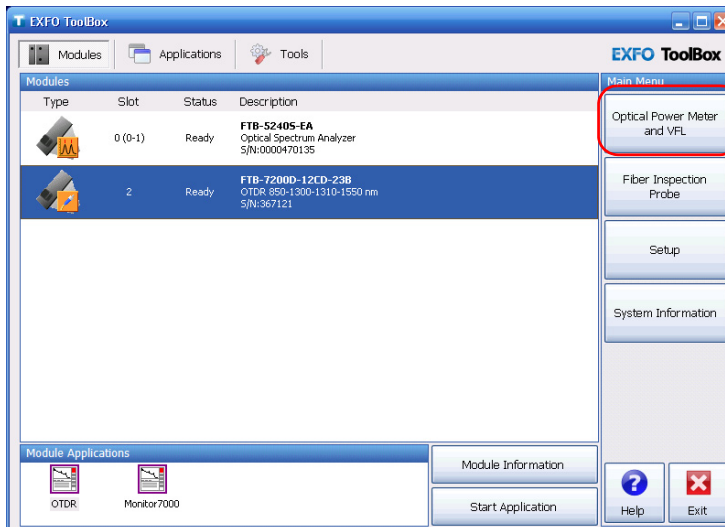

Note: *Some buttons are not displayed when you first access the Power Meter application, but will be displayed after you tap **Add** for the first time or after you open a file.*

Using the Optional Built-In Power Meter and VFL

Accessing the Built-In Power Meter

Below is a description of the Power Meter buttons and functions.

The screenshot shows the 'Optical Power Meter and VFL [Internal]' software window. The interface is divided into several sections:

- Power Meter Section:** Displays 'Wavelength: 1310 nm', 'Reference: -61 dBm', and a large red reading of '11.40 dB'. Below this is the label 'Insertion Loss'. A red 'X' icon is present in the top right of this section.
- VFL Section:** Displays a red laser pointer icon with two arrows pointing right. A label 'VFL' is above it.
- Selector Section:** Includes a 'Wavelength:' dropdown menu set to '1310' and a 'Unit:' dropdown menu set to 'dB'.
- Power Result Section:** Contains an 'Add' button.
- VFL Control Section:** Contains a button labeled 'ON/Blink/OFF'.
- Reference and Nulling Section:** Contains 'Reference' and 'Offset Nulling' buttons.
- Right Panel:** Contains buttons for 'Open', 'Save', 'Close', 'Setup', 'Print', 'About', and 'Exit'.
- Status Bar:** Shows 'Ready', a battery icon at 93%, 'Local', the date '6/17/2011', and the time '9:40 AM'.

Callouts from the text provide the following descriptions:

- Measured power or loss** (points to the 11.40 dB reading)
- Fail values appear in red (when option is selected.)** (points to the red 'X' icon)
- Pass/Fail status icon (displayed only when option is selected.)** (points to the red laser pointer icon)
- Selected wavelength** (points to the 1310 nm value)
- Reference value (when in reference mode)** (points to the -61 dBm value)
- To switch between available power meter wavelengths** (points to the Wavelength dropdown)
- To switch between dB, dBm and W as measurement units** (points to the Unit dropdown)
- To access reference mode** (points to the Reference button)
- To perform an offset nulling** (points to the Offset Nulling button)
- To store a reading to the Measurements window** (points to the Add button)
- To activate VFL and changes VFL mode** (points to the ON/Blink/OFF button)

Nulling Offsets

Temperature and humidity variations affect the performance of electronic circuits and optical detectors, which can offset measurement results. To compensate for this offset, the unit is equipped with an offset nulling function.

Your unit has been designed *not to require offset nulling* under normal operation, but you should perform it whenever environmental conditions change significantly or when measuring very low power values.



IMPORTANT

Light must not reach the detector when nulling offsets. Always use an EUI or protective screw cap. Do not use a soft rubber cover.

To perform an offset nulling:

1. Tighten the protective cap on the power meter port.
2. From the **Instrument View** tab, tap **Offset Nulling**.

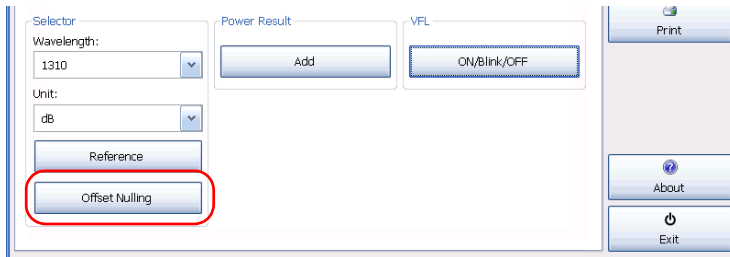

The nulling process takes approximately 5 seconds.

Setting Thresholds and Correction Factors

You can define thresholds to specify acceptable power or loss values for each wavelength. Thresholds are usually supplied by system manufacturers and depend on the system deployed.

A power measurement (in dBm) will be considered as “Fail” when its value is lower than the defined absolute power threshold.

A loss measurement (in dB) will be considered as “Fail” when its value is greater than the insertion loss threshold.

When the measurement status is “Pass”:

- The value is displayed in black and the  symbol appears next to it, both in the **Instrument View** tab and on the **Measurements** list.
- In reports, the value is displayed in black and the *Status* column shows a check mark.

When the measurement status is “Fail”:

- The value is displayed in red and the  symbol appears next to it, both in the **Instrument View** tab and on the **Measurements** list.
- In reports, the value is displayed in black and the *Status* column shows an X.

You must select the pass/fail status feature for the application to take into account the defined thresholds and display the appropriate status icons. By default, this feature is not selected.

Using the Optional Built-In Power Meter and VFL

Setting Thresholds and Correction Factors

You may apply a correction factor (CF) to measured power to compensate for inaccuracies or drifts. You should change the CF after performing an offset nulling.

$$\text{Power}_{\text{corrected}} = \text{Power}_{\text{measured}} \times \text{CF}$$

where:

$\text{Power}_{\text{corrected}}$ = the corrected power value

$\text{Power}_{\text{measured}}$ = the measured power value

CF = the correction factor

For each favorite wavelength, the CF is set to 1.00 at the factory (even if the unit indicates “----”), but allowed values range between 0.85 and 1.15.

Note: *Some other products express the CF in dB, so the CF would be added to measured power.*



IMPORTANT

If you revert to factory settings, you will erase all your thresholds and correction factors. The pass/fail status feature will be disabled automatically.

To set thresholds or correction factors:

1. On the button bar, tap **Setup**.
2. From the **Thresholds** list, select the wavelength for which you want to set a threshold or a correction factor.

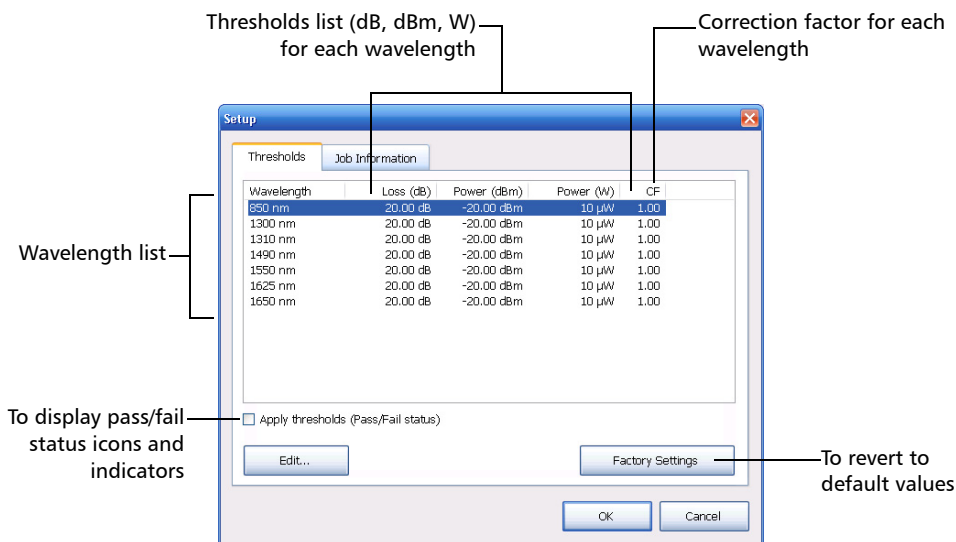

3. If desired, select **Apply thresholds (Pass/Fail status)** if you want the application to identify the pass and fail values using visual clues, and activate the pass/fail LED on your unit.

Using the Optional Built-In Power Meter and VFL

Setting Thresholds and Correction Factors

4. Tap **Edit**.



5. Modify the thresholds or correction factor for the selected wavelength.

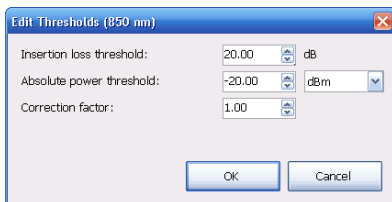

6. Tap **OK** to close the dialog box and confirm the new values, then tap **OK** to exit the window.

Setting Reference Values on Your Power Meter

In Reference mode, your unit displays the loss created by the fiber under test only, since it subtracts a reference value from the measured power.

You can set a different reference value for each wavelength. A reference value remains in memory until a new one is stored at the same wavelength.

To set reference values to use in Reference mode:

1. Check your fibers and clean them properly.
2. Using the proper adapter and test jumpers, connect a light source to your power meter.
3. From the **Instrument View** tab, select the wavelength in the list. Activate the source at the same wavelength.

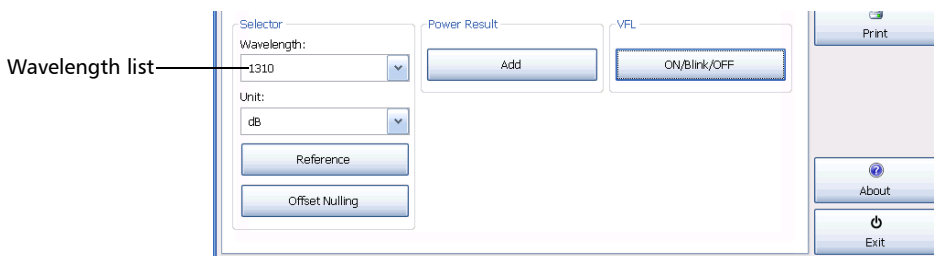

4. Tap **Reference** to save the current power value as the new reference. It will appear on the upper-right corner of the data display.

Measuring Power or Loss

Measuring absolute power or link (insertion) loss is done the same way, except for the referencing step. You can take power or loss measurements and save them for further analysis.

To perform power or loss measurements:

- 1.** If necessary, perform an offset nulling (see *Nulling Offsets* on page 110).
- 2.** Check your fibers and clean them properly.
- 3.** For loss measurements, reference your power meter to a light source (see *Setting Reference Values on Your Power Meter* on page 115), then deactivate the light source.
- 4.** If you have used a single reference patchcord, disconnect it *from the power meter port only*, then attach a second reference patchcord to the power meter.

OR

If you have used two reference patchcords, disconnect both of them at the bulkhead.

5. Using bulkhead adapters or the system patch panels, connect a fiber under test to reference patchcord attached to the light source and power meter.
6. From the **Instrument View** tab, use the list to select a wavelength. Activate the source at the same wavelength.

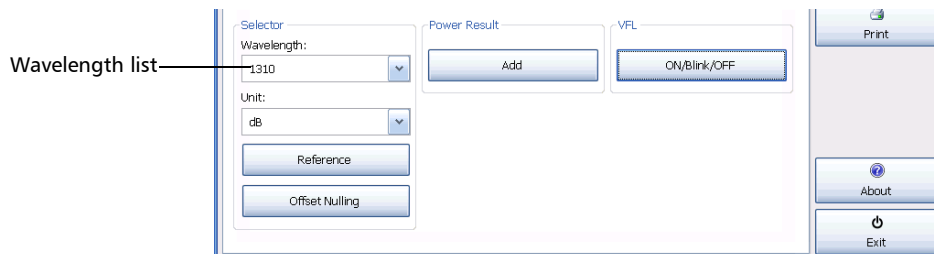

7. Tap **Add** to transfer the displayed values to the **Measurements** list.
8. Repeat the procedure for other wavelengths.
9. Once your work is complete, tap **Save**.



IMPORTANT

If you specify a name that already exists, the original file will be overwritten and only the new file will be available.

Using the Optional Built-In Power Meter and VFL

Measuring Power or Loss

To view and edit power or loss measurements:

1. Select the **Measurements** tab. All your measurements are displayed in the order they were performed.
2. Tap **Rename** to rename the fiber, tap **Delete** to remove the selected value from the list.

Wavelength at which power or loss was measured

Loss measurement (in dB) or power measurement (in dBm)

Reference power (in dBm); appears only when measuring loss (in dB).

Fiber name

Measurement not acceptable according to defined threshold

Average power or loss measured per wavelength

P/F	Fiber	Wavelength	Measurement	Reference
✓	001	1310 nm	-0.53 dB	-60.83 dBm
✓	002	1310 nm	-0.52 dB	-60.83 dBm
✓	003	1310 nm	-0.44 dB	-60.83 dBm
✓	004	1310 nm	-0.35 dB	-60.83 dBm
✓	005	1310 nm	-0.30 dB	-60.83 dBm
✗	006	1310 nm	4.77 dB	-60.83 dBm
✗	007	1310 nm	4.66 dB	-60.83 dBm

Open

Save

Close

Setup

Print

Wavelength: 1310 nm, Average: 1.04 dB

Rename

Delete

Clear All

About

Exit

Ready 93% Local 6/17/2011 9:38 AM

To change the fiber name

To delete the selected row from the table

3. Once your work is complete, tap **Save**.

Note: If you tap **Add** while using another measurement unit, you will have to save previous values first.

Opening Results Files

You can open results files that are stored on your unit or on a USB memory key. If you need more flexibility and a greater choice of report types, you can also transfer results files to a computer onto which applications such as EXFO FastReporter2 are installed.

To open results files:

1. From the button bar, tap **Open**.
2. If necessary, change the location from which the file should be opened.

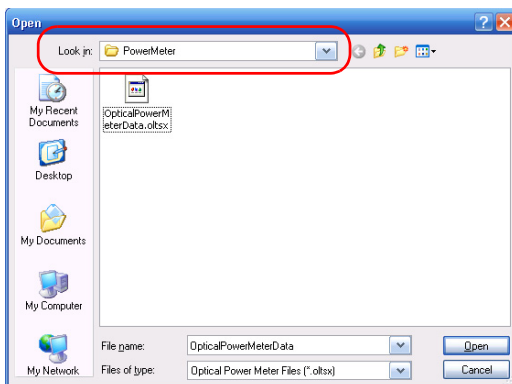

Using the Optional Built-In Power Meter and VFL

Opening Results Files

3. From the given list of files, select the file to open.

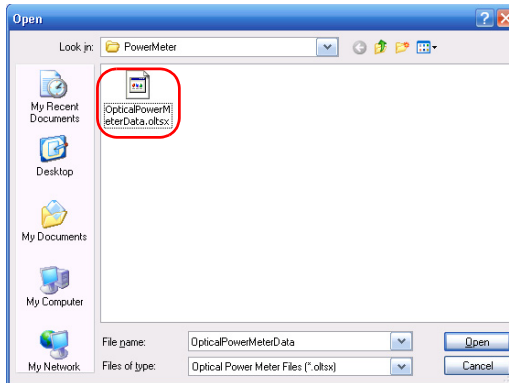

4. Confirm with **Open**.

If you have already performed power measurements, but not saved them, the application will prompt you to save your work. You must either save or discard the unsaved measurements before being able to open a file.

5. To view the reopened file, go to the **Measurements** tab. The power or loss measurements are displayed on the results list.

Clearing Measurements from the Display

When measurements do not meet your requirements, you can clear the display and start over.

Note: *Clearing measurements from the display does not delete them from the disk (if they were saved previously).*

To clear power measurements:

1. From the button bar, tap **Close**.

OR

From the **Measurements** tab, tap **Clear All**.

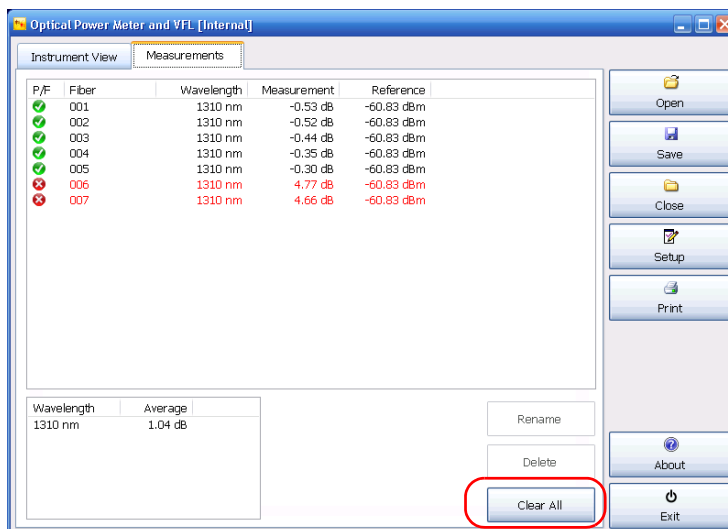

If you have not saved the measurements already, the application will prompt you to save your work.

2. Select **Yes** to save the file.

Adding Information to Your Results

A report is available to keep notes on the measurements, the location of the tested fiber, the type of job performed, and general comments. This information will be saved, along with your measurements, in the power meter results file. When you open the results files with applications such as EXFO FastReporter2 (installed on a computer), all the information that you entered will be available.

To speed up information entry, once you have provided the required data, the contents is kept in memory. This information will be used for all new results.

To add information to your results:

1. From the button bar, tap **Setup**, and then select the **Job Information** tab.
2. Enter information in the appropriate boxes.

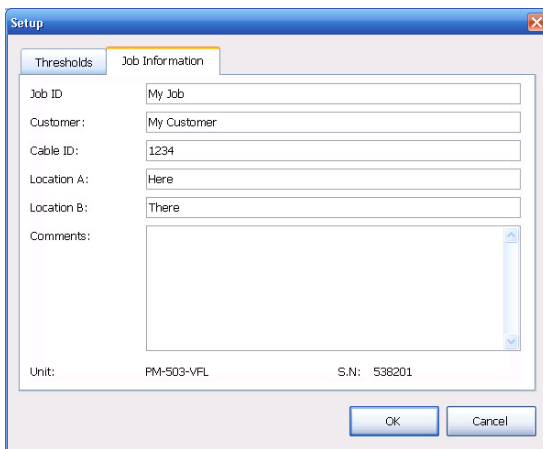

The screenshot shows a 'Setup' dialog box with two tabs: 'Thresholds' and 'Job Information'. The 'Job Information' tab is active. It contains several input fields: 'Job ID' (My Job), 'Customer:' (My Customer), 'Cable ID:' (1234), 'Location A:' (Here), and 'Location B:' (There). Below these is a 'Comments:' text area. At the bottom, it displays 'Unit: PM-503-VFL' and 'S.N: 538201'. There are 'OK' and 'Cancel' buttons at the bottom right.

3. Tap **OK** to confirm.

The information that you have entered will be copied to all the new files (and reports) that you will create.

Printing Results Reports

You can print reports directly from your unit if you connect a printer to it.

You can modify the information related to customer, cable and job (see *Adding Information to Your Results* on page 122).

The following table shows the items that are included in each type of report:

Sections appearing on the report	Summarized report	Detailed report
Job Information: job ID, customer name, cable ID, location A and B, unit model and serial numbers, as well as test date and time.	X	X
Comments	---	X
Measurements: pass/fail status (only shown if this option is selected; see <i>Setting Thresholds and Correction Factors</i> on page 111.), fiber ID, wavelength, measurement, and reference values (if applicable).	X	X
Statistics: wavelength and associated average loss or power measurement.	---	X

Using the Optional Built-In Power Meter and VFL

Printing Results Reports

To print a power measurement report:

1. Connect a printer to your FTB-500. For more information, see *Installing a Printer* on page 63.
2. From the button bar, tap **Print**.
3. Select the desired report format.

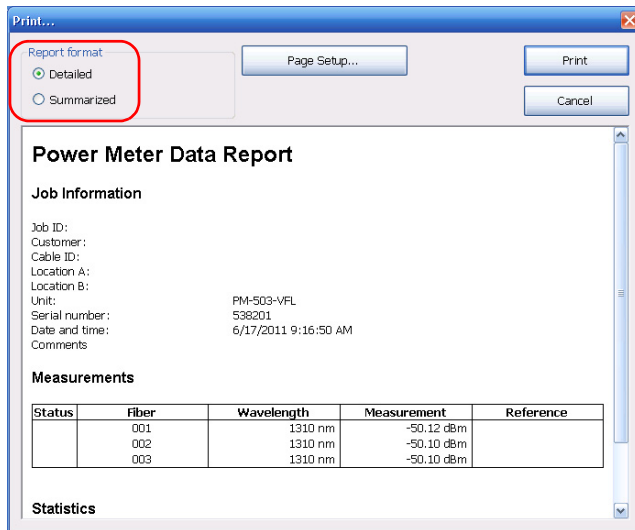

4. If needed, tap **Page Setup** to adjust settings related to page layout, paper size, and printer.
5. Tap **Print**. You will automatically return to the power meter main window.

Identifying Fiber Faults Visually with the VFL

The visual fault locator (VFL) helps you identify bends, faulty connectors, splices and other causes of signal loss. It can also help the person at the other end of the link to identify the fiber under test, which could be particularly useful when working with cables containing many fibers.

From its dedicated port, the VFL emits a red signal which becomes visible at the location of a fault on the fiber. This signal can be continuous (CW, the default) or blinking (1 Hz).



WARNING

When the VFL is active, the VFL port emits visible laser radiation. Avoid exposure and do not stare directly into the beam. Protect any unused port with a cap.

Using the Optional Built-In Power Meter and VFL

Identifying Fiber Faults Visually with the VFL

To activate the VFL and inspect a fiber:

1. Clean the connectors properly.
2. Connect the fiber under test to the VFL port.
3. If necessary, from Toolbox, on the **Main Menu**, tap **Optical Power Meter and VFL**.
4. Select the **Instrument View** tab.
5. Tap **ON/Blink/OFF** to change the VFL state.

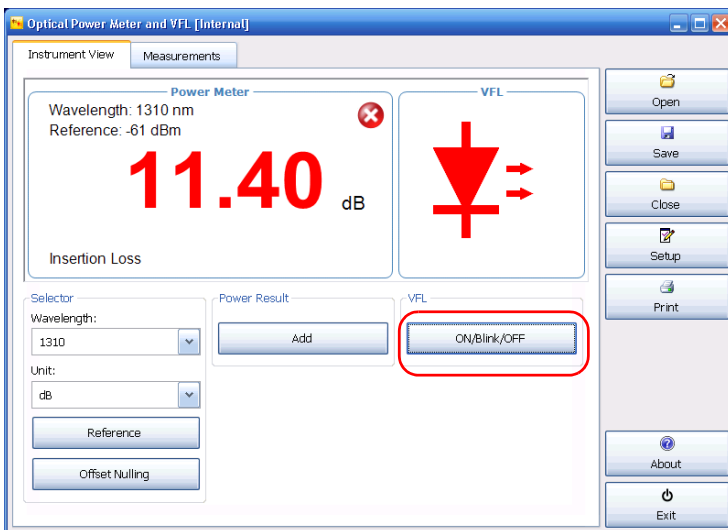

6. Without looking directly into the beam, examine the fiber. If the fiber is defective, you will see light coming through its rubber jacket or on the side of the ferrule.

7 *Inspecting Fibers with a Probe*

The fiber inspection probe (FIP) is used to find dirty or damaged connectors by displaying an enlarged view of the connector surface. You can connect a probe to your unit to view fiber ends.

Your unit supports both the probes of the FIP-400 and FIP-400B series.

Fiber inspections are made using the ConnectorMax (FIP-400) or the ConnectorMax2 (FIP-400B) application, depending on the probe that you use. By default, you will be prompted to select the application with which you want to work. If you prefer, you can configure the unit to always start your favorite application directly instead (see *Selecting the FIP Startup Application* on page 67).

For more information on how to work with the probe, refer to the ConnectorMax or ConnectorMax2 online help.

Inspecting Fibers with a Probe

To inspect fibers with a probe:

1. Connect the probe to your unit.

For a probe of the FIP-400 series, connect it to the probe port on the right panel of the unit.



IMPORTANT

For a probe of the FIP-400B series, connect it to the USB port that is closest to the bottom, on the front panel of the unit. Otherwise, the probe will not be detected properly.

Front panel

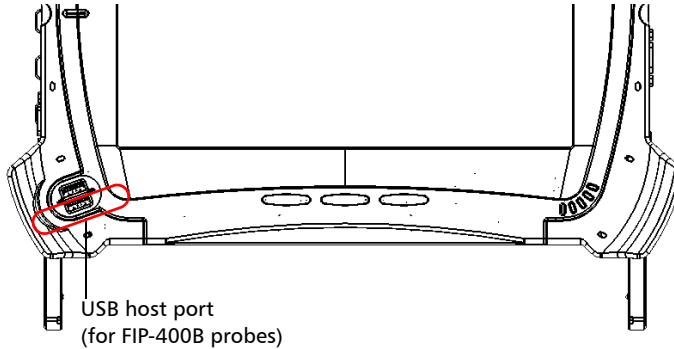

Right panel

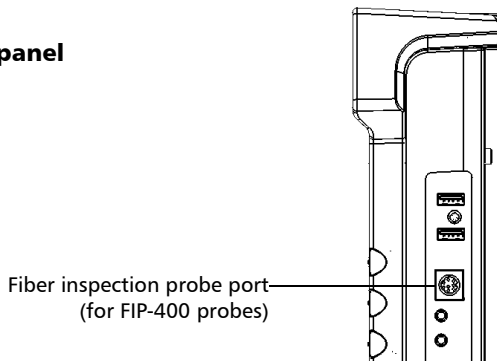

2. From the **Main Menu**, tap **Probe**.

3. If the unit prompts you to select an application, tap the button corresponding to the probe that you want to use to start the corresponding application.

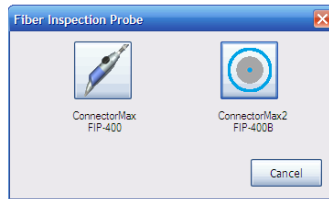

Note: *If you have not updated the ConnectorMax product lately, the ConnectorMax2 application may not be installed on your unit. In this case, you will not be presented with a choice of applications. The ConnectorMax application will start automatically, enabling you to work with the probes of the FIP-400 series. If you also wish to be able to work with probes of the FIP-400B series, you will need to install the most recent ConnectorMax kit.*

Note: *You can access the online help by tapping the  button from the ConnectorMax or ConnectorMax2 application.*

8 ***Managing Data***

You can copy, move, rename, delete files and folders directly on your unit.

You can transfer files from your unit to a USB memory key, an Express card, or a computer. You can also transfer data from a storage device or a computer to your unit.

Your unit is equipped with the following ports and devices for data transfer:

- Four USB 2.0 ports to connect
 - a memory key
 - a USB to RS-232 adapter (see *Using the USB to RS-232 Adapter* on page 145.)
 - a Bluetooth device (optional) to transfer data via Bluetooth.
- an Express card reader to connect
 - a memory card
 - a Wi-Fi card (optional) to connect to a wireless network
- an Ethernet port to connect to a network (for transfer via VNC or Remote Desktop - see *Accessing Your Unit Remotely* on page 155)

Transferring Data via Bluetooth

With the optional Bluetooth device, you can transfer data between your unit and a computer using the Bluetooth technology.

Note: *The computer that you use must run Windows XP SP3 or later; otherwise, there could be problems during data transfer. The computer must also be equipped with a Bluetooth device and be configured properly.*

Note: *To save power when your unit is running on batteries, you may wish to disconnect the Bluetooth device when you do not use it.*

Note: *If you prefer to use devices such as BlackBerry smartphones instead of a computer for data transfer, you must ensure that they are Bluetooth-compatible and configured properly. Some devices only allow data transfer between devices of the same make. In this case, you will need to use another type of device or a standard computer to transfer data from your FTB-500 unit.*

Your unit must be located within a 9-meter area from your computer (limitation of the Bluetooth technology).

If you need to transfer large files (more than 1 Gb), use a USB key, or connect to a Wi-Fi or an Ethernet network.



IMPORTANT

Depending on the operating system that your computer is running (or on the smartphone that you are using), it is possible that only data transfer secured with a passkey be allowed.

Since your unit cannot receive data secured with passkeys, in such a case, data transfer would only be possible *from your unit to the computer (or smartphone)*.

The procedure presented hereafter explains how to transfer data from your unit to a computer. Data transfer from the computer to your unit is similar, except that data will be sent using the Bluetooth Transfer Wizard of the computer (*Send a file* option) and received by the unit (*Receive a file* option).

Managing Data

Transferring Data via Bluetooth

To transfer data via Bluetooth:

1. Configure your unit as follows:
 - 1a. Connect the Bluetooth device to one of the USB ports of your unit.
 - 1b. From the main window, select the **Tools** tab.
 - 1c. Tap **Control Panel**.

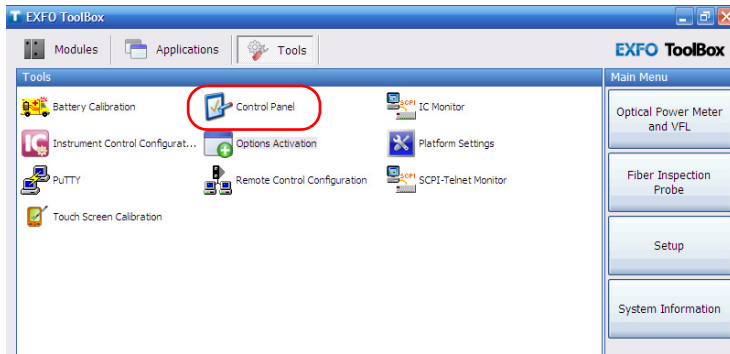

- 1d. Tap **Bluetooth Devices**.

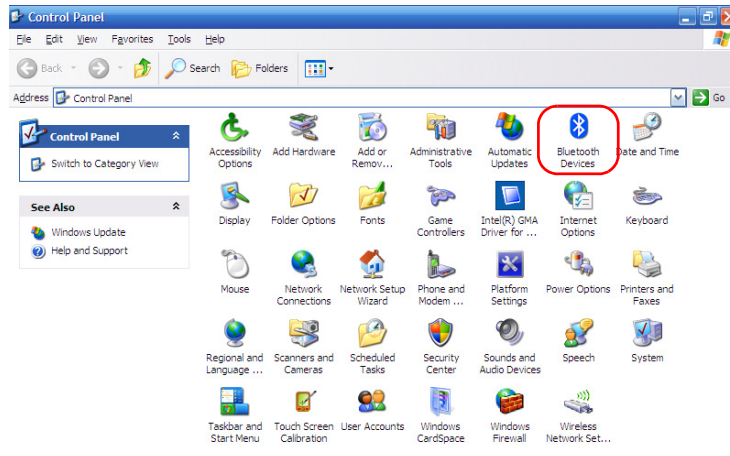

- 1e.** From the **Options** tab, under **Discovery**, select the **Turn discovery on** check box.

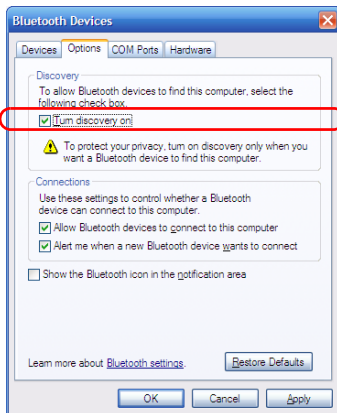

- 1f.** Ensure that the **Allow Bluetooth devices to connect to this computer** check box is selected.
- 1g.** Tap **OK** to confirm.

Managing Data

Transferring Data via Bluetooth

2. Configure the computer as follows:
 - 2a. Connect another Bluetooth device to one of the USB ports of your computer.
 - 2b. On the computer, from **Control Panel**, double-click **Bluetooth Devices**.
 - 2c. From the **Options** tab, under **Discovery**, select the **Turn discovery on** check box.
 - 2d. Ensure that the **Allow Bluetooth devices to connect to this computer** check box is selected.
 - 2e. Tap **OK** to confirm.
3. On the computer, click the Bluetooth icon (located on the taskbar) and select **Receive a file**.
4. On your unit, from the Windows taskbar, tap **Start > All Programs > Accessories > Communications > Bluetooth File Transfer Wizard**.
5. From the **Welcome** window, tap **Next**.
6. Select **Send a file** and tap **Next**.

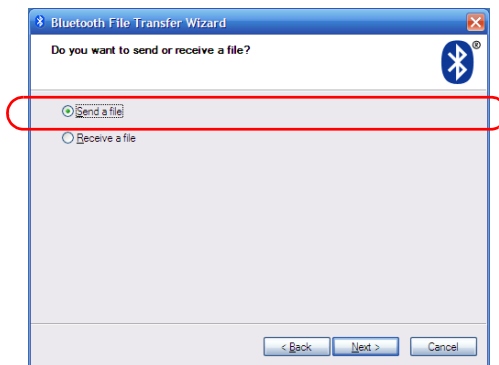

7. Select the computer to which you want to transfer data as follows:

7a. Tap **Browse**.

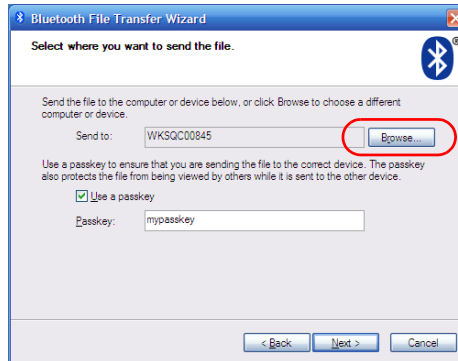

7b. Select the desired computer, and then tap **OK** to confirm.

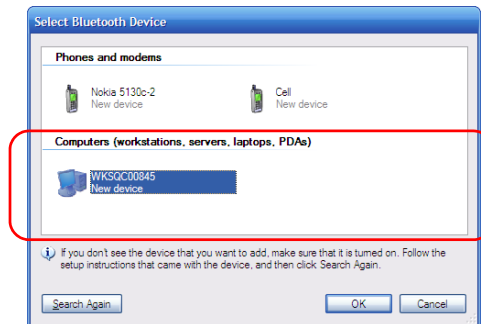

Managing Data

Transferring Data via Bluetooth

8. If you want to use a passkey, select the corresponding check box and enter the passkey.

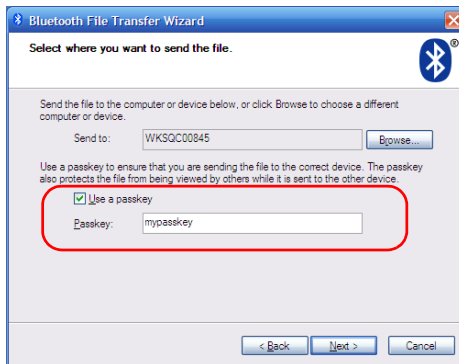

When you have finished, tap **Next**.

9. Tap **Browse** to select the file that you want to send to the computer.

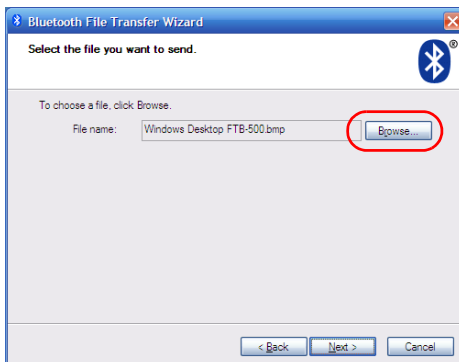

10. Select the file, tap **Open** to confirm, and then **Next**.

- 11.** On the computer, when the application prompts you, allow the connection and enter the passkey if necessary.

Note: *Once you have established a secured connection using a passkey, this passkey is kept in memory both on your unit and on the computer until you remove this connection (**Control Panel** > **Bluetooth Devices** > **Devices**) or change the passkey.*

- 12.** On the computer, click **Finish**.
- 13.** From the Bluetooth File Transfer Wizard on your computer, if necessary, modify the name of the received file and the storage location. Click **Next** to save the file. Click **Finish** to close the wizard.
- 14.** On your unit, tap **Finish** to close the Bluetooth File Transfer Wizard.

Connecting to a Wireless Network

With the optional Wi-Fi card (or a USB wireless adapter of your choice), you can connect to a wireless network and benefit from all resources that are available on this network. You can transfer data exactly as you would do from an Ethernet network.

Note: *To save power when your unit is running on batteries, you may wish to remove the Wi-Fi card when you do not use it.*

To connect to a wireless network:

1. Insert the Wi-Fi card into the express card reader located on the left panel of your unit.

Note: *If you use a Wi-Fi card (or a Wi-Fi USB key) other than the one purchased from EXFO, Windows may not detect your device properly. In this case, you will have to install the drivers that are specific to your device (usually provided on a CD). Contact your IT department for assistance.*

2. If it is not already done, share all the required folders both on your unit and on your computer. If you are not sure on how to proceed, see with your network administrator.

3. If it is not already done, configure the firewall as follows:

3a. From the main window, select the **Tools** tab.

3b. Tap **Control Panel**.

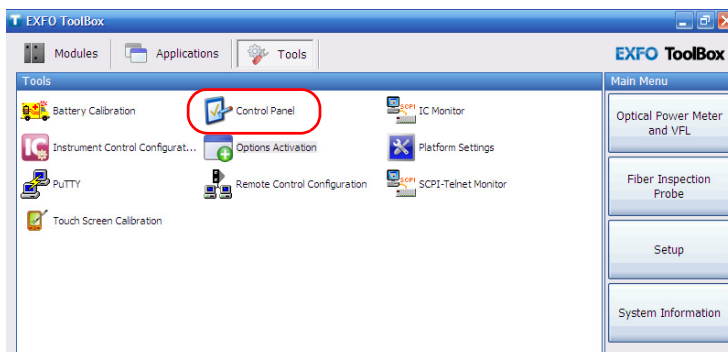

3c. Tap **Windows Firewall**.

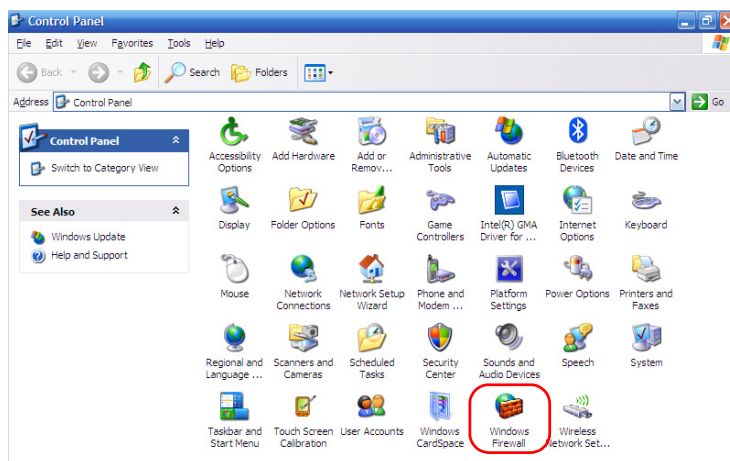

3d. Select the **Exceptions** tab.

Managing Data

Connecting to a Wireless Network

- 3e. Ensure that the **File and Printer Sharing** item is selected.

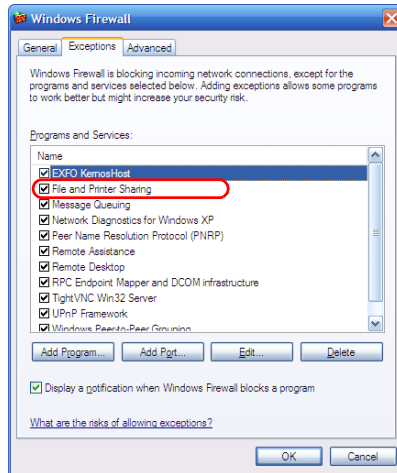

- 3f. Tap **OK** to confirm.

4. Tap **Network Connections**.

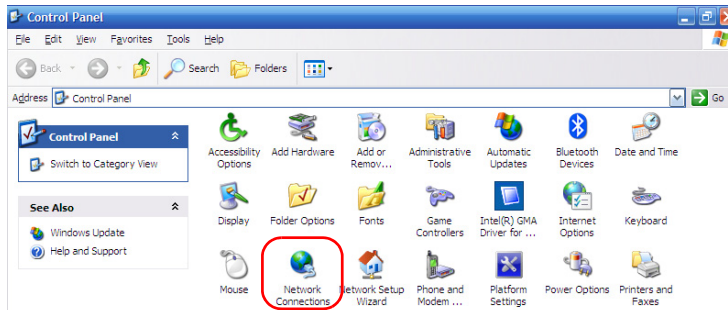

5. Double-tap **Wireless Network Connection**.

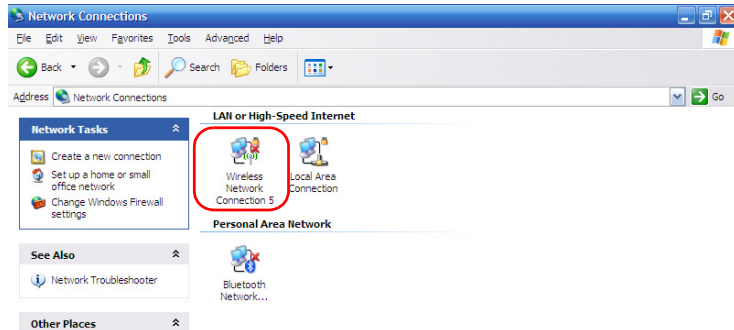

6. If your unit is already connected to a wireless network, tap **View Wireless Networks** to display the list of wireless networks.

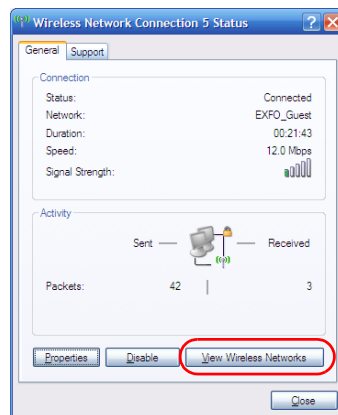

Managing Data

Connecting to a Wireless Network

7. From the **Wireless Network Connection** window, select the wireless network to which you want to connect.

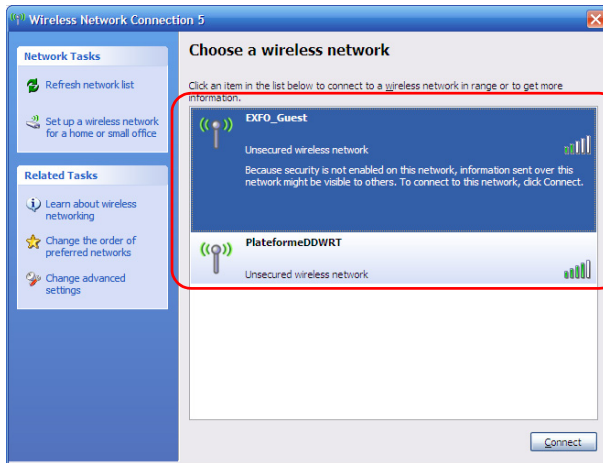

8. Tap **Connect**.
9. If the network is protected by a network key (password) enter it in the corresponding boxes and tap **Connect**.

Note: *Since all networks are different, you may also need to configure other parameters before being able to transfer data via Wi-Fi. For information on the configuration specific to your network, see with your network administrator.*

As soon as the connection is established, you can start working with the selected wireless network. When you have finished, from the **Wireless Network Connection** window, tap **Disconnect** to stop communication with the wireless network.

Using the USB to RS-232 Adapter

If you want to transfer data between your unit and a device that is only equipped with RS-232 (serial) ports, you have to use a USB/RS-232 adapter. You can use any USB/RS-232 adapter that you like.

Once the adapter has been detected, the unit assigns it a COM port number. This COM port number is kept in memory even when you turn the unit off. This means that next time you connect the same adapter to any of the USB ports, the unit will recognize the adapter and identify it with the saved COM port number.

Note: *For some adapters, the port values do not begin at COM 1. You may want to verify the actual port number.*

The communication between your unit and the device is established using the PuTTY application.

Managing Data

Using the USB to RS-232 Adapter

To use the USB/RS-232 adapter:

1. Turn on both the unit and the serial device.
2. Connect as shown. You can connect the USB end of the adapter to any of the USB ports.

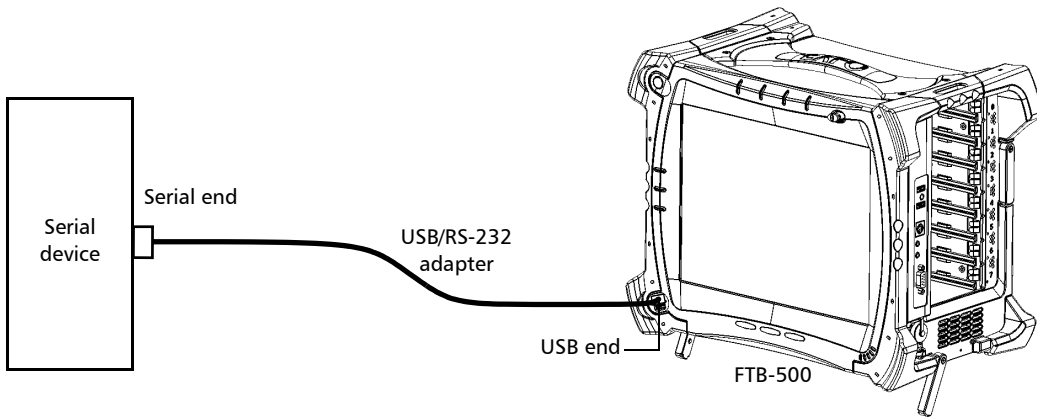

Note: *If the device that you want to use is a computer (not equipped with USB ports) you may want to use a null-modem serial cable as an “extension cable” between the device and the USB/RS-232 adapter.*

The adapter will be detected automatically on your unit.

3. From your unit, retrieve the COM port of the adapter as follows:

3a. From the main window, select the **Tools** tab.

3b. Tap **Control Panel**.

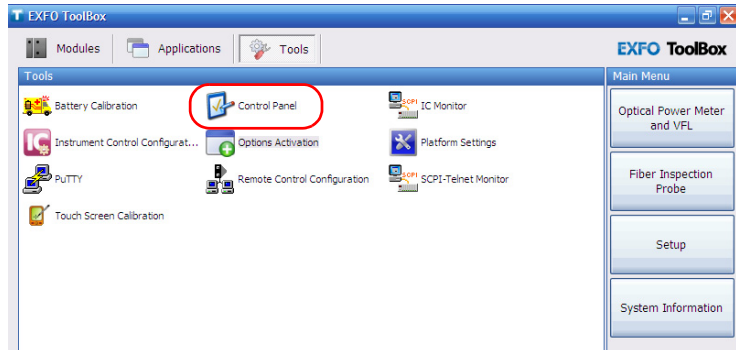

3c. Tap **System**.

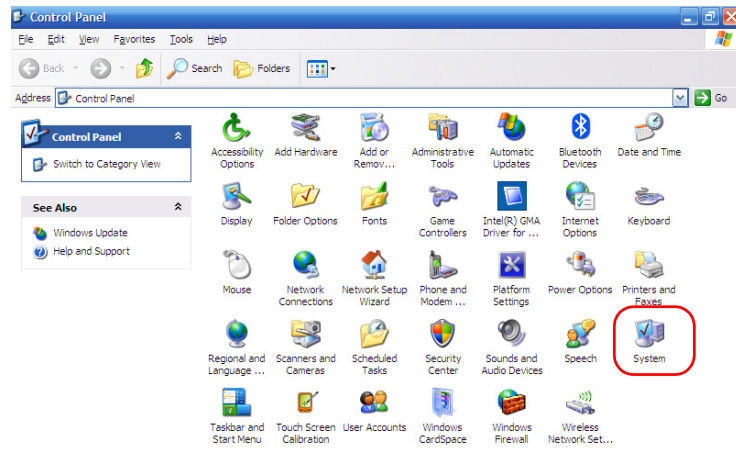

Managing Data

Using the USB to RS-232 Adapter

- 3d.** From System Properties, select the **Hardware** tab, then tap **Device Manager**.

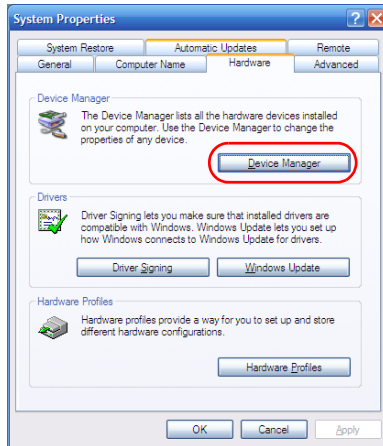

- 3e.** Expand the **Ports (COM & LPT)** list to retrieve the COM port number that has been assigned to the adapter (identified as *USB Serial Port*) and write it down.

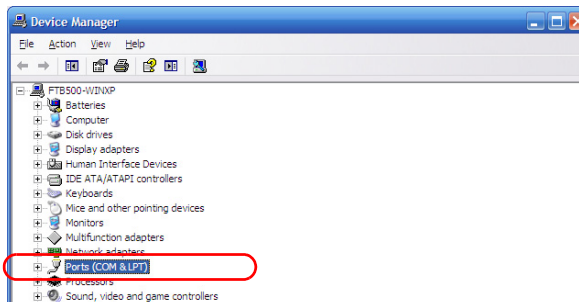

- 3f.** Close the *Device Manager*.

4. From your unit, configure the communication parameters as follows:
 - 4a. From the main window, select the **Tools** tab, then tap **PuTTY**.
 - 4b. Configure the parameters.

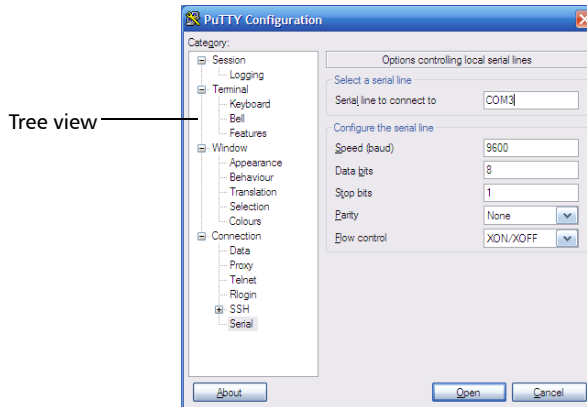

- From the tree view, select **Connection** > **Serial** and set the parameters as needed. Ensure that the COM port that you specify corresponds to the one that you wrote down at step 3e.
 - If you want to view the characters that you type on screen, from the tree view, select **Terminal**. Under **Local echo**, set the value to **Force on**.
 - From the tree view, select **Session**. Select **Serial**. The COM port number and the speed should correspond to those that you have previously entered.
- 4c. Tap **Open**. The unit is now ready to receive or send data.

Managing Data

Using the USB to RS-232 Adapter

5. From the device, set the communications parameters.



IMPORTANT

To be able to establish a communication between the unit and the device, you must set the following parameters to the same values as those defined on your unit:

- Speed
- Data bits
- Stop bit
- Parity
- Flow control

Note: *The COM port number that you set on your device will probably differ from the one that you used on your unit.*

6. From the device, establish communication with the unit using your favorite communication tool (PuTTY, HyperTerminal, etc.).

Connecting to a VPN from Your Unit

Note: *Only administrator-level users can install software under Windows XP. However, when the installation is complete, all users have the possibility to connect to a VPN from the unit.*

You can connect to a Virtual Private Network (VPN) from your unit if you install one of the supported VPN clients (applications). Such clients allow you to connect to the VPN of your company from anywhere in the world and have access to network resources as if your unit was connected locally to the network. This could be useful if you need to transfer data to a centralized folder on the company's private network, for example.

To establish the communication between the VPN client and the VPN server, you can use either a 3G USB modem key (see *Accessing the Internet with a 3G USB Modem Key* on page 97) or a standard Ethernet connection.

Note: *Since all networks are different, the parameters that you need to configure before being able to connect to the VPN may vary. For information on the configuration specific to your network, see with your network administrator.*

If you ever need to change to another VPN client or remove it, use the Add/Remove Programs utility from Windows.

Managing Data

Connecting to a VPN from Your Unit



IMPORTANT

EXFO does not recommend to install more than one VPN client on a single FTB-500 unit.



IMPORTANT

To avoid communication problems between the VPN client and the VPN server, ensure that the date set on your unit corresponds to the current date.

To install a VPN client on your unit:

1. If the date on your unit does not correspond to the current date, modify it (see *Adjusting the Date, Time and Time Zone* on page 77).
2. Start the installation of the VPN client using the files and settings provided by your network administrator.
3. Follow the on-screen instructions.

Once the installation is complete, all users will now be able to connect to a VPN from the unit.

To connect to a VPN from your unit:

Start the VPN client and follow the on-screen instructions.

If you are not sure about the information that you should provide, see with your network administrator.

Using Your Unit as an FTP Server

If you want your unit to act as an FTP server, you can use the Internet Information Services (IIS) Manager. If you need information on the IIS Manager or on how to transfer files via an FTP server, refer to Windows online help.

To access the IIS Manager:

1. From the main window, select the **Tools** tab.
2. Tap **Control Panel**.

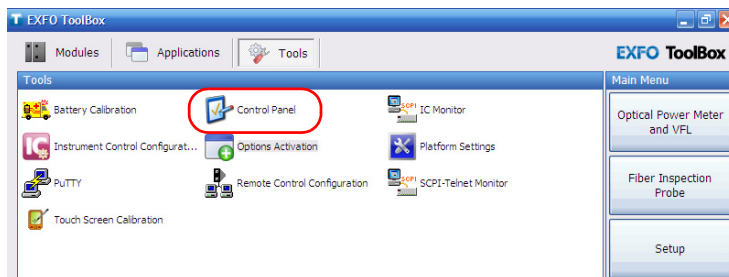

3. Tap **Administrative Tools**.

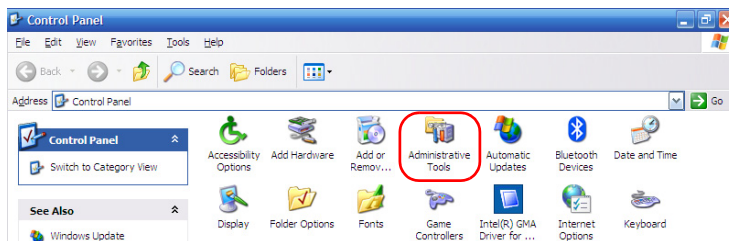

4. Tap **Internet Information Services**.

You are now ready to start working with the IIS Manager.

9 Accessing Your Unit Remotely

You can access your unit remotely from a computer using either the Remote Desktop Connection or TightVNC Client applications.

This could be particularly useful if you do not intend to perform automation tasks on your platform. If you prefer to perform automation tasks on your platform and modules, see *Preparing for Automation* on page 175, *Using FTB Products in an Automated Test Environment* on page 213, or *Preparing to Control Modules with a Dedicated Application* on page 208.

The table below presents the differences between the two applications.

Characteristic	Remote Desktop Connection	TightVNC Client
Type of connection	Direct between the unit and the computer; only one user can be connected to the unit at a time. Usually, the connection is made with the user name of the person currently logged on the unit. Otherwise, this person will be automatically disconnected.	Not exclusive; several users can be connected to the unit at the same time (sharing the same session).
Windows user rights	Taken into account.	Not taken into account.
Password-protected	Yes; mandatory. The user name and password are the same as those used to connect to the unit. By default, all the accounts with administrator rights can use Remote Desktop Connection. If you want accounts with limited rights to be able to use Remote Desktop as well, you must specifically grant them access.	Yes; mandatory. The password is defined on the TightVNC Server, the first time you start the server. This password is not related to the one used to connect to the unit. By default, all people that use TightVNC Client will enter the same password (as defined on the server). Each user to whom you provide the password will be able to connect to the unit via TightVNC.

Working with Remote Desktop

By default, the remote access to your unit with Remote Desktop is not enabled. However, once you enable it, all the accounts with administrator rights can use Remote Desktop. If you want accounts with limited rights to be able to use it as well, you must specifically grant them access.

You can also configure the unit to prevent users from accessing it remotely.

Accessing Your Unit with Remote Desktop

To be able to connect to the unit using Remote Desktop, you must:

- Allow the remote access to your unit (only necessary the first time that you access your unit with Remote Desktop).
- Know the IP address of the unit and provide it in the connection settings on the computer.
- Use an account that is secured by a password. Remote Desktop will not allow any connection with empty passwords.
- Enter the appropriate user name when Remote Desktop application prompts you. Usually, this user name must correspond to the user name of the person currently logged on the unit. Otherwise, you will disconnect the person that was already connected.

To allow the remote access to your unit with Remote Desktop:

1. From the main window, select the **Tools** tab.
2. Tap **Control Panel**.

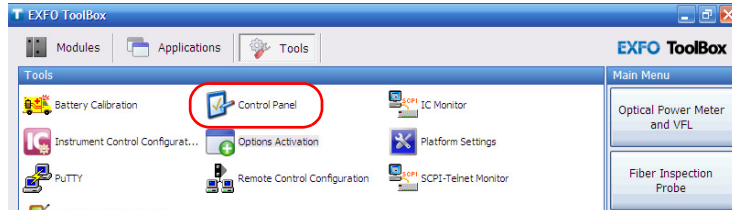

3. Tap **System**.

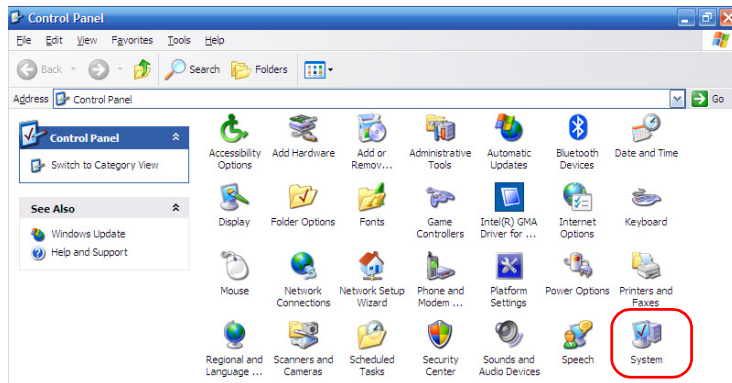

4. From the **System Properties** dialog box, tap the **Remote** tab.

Accessing Your Unit Remotely

Working with Remote Desktop

5. Under **Remote Desktop**, select **Allow users to connect remotely to this computer**.

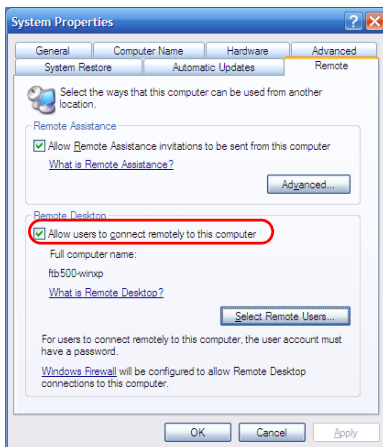

6. Tap **OK** to confirm the changes and return to Control Panel.
7. Close the **Control Panel** window.

To access your unit remotely with Remote Desktop:

1. Connect both the computer and your unit to the same network and make sure they can “see” each other as network restrictions might prevent them from communicating.
 - If you want to use an Ethernet network, connect an RJ-45 (network) cable to the unit’s RJ-45 (Ethernet) port located on its left side.
 - If you want to use a wireless network, see *Connecting to a Wireless Network* on page 140.
 - You could also create a Private Area Network with your Bluetooth device (see with your network administrator).
2. Turn on both the computer and the unit.
3. On your unit, in Toolbox, go to **Main Menu**. Select **System Information > Platform**.
4. Write down the IP address, and then close the window.

Note: *It may take a few seconds before you see the IP address on the list.*

5. From the computer, on the taskbar, click **Start**, then select **All Programs > Accessories > Remote Desktop Connection**.

Accessing Your Unit Remotely

Working with Remote Desktop

6. In the **Connecting to Remote Desktop** window, in the **Computer** list, type the IP address of the unit that you wrote down at step 4.

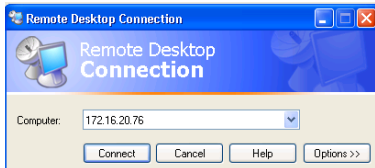

7. Click **Connect**.
8. When the application prompts you, enter your user name and password.



9. Click **OK** to open the session.

Allowing Users with Limited Accounts to Use Remote Desktop

By default, only the accounts with administrator rights can use Remote Desktop. However, you can assign extra user rights to accounts with limited rights so that they can also use Remote Desktop.

To allow a user with limited accounts to use Remote Desktop:

1. From the main window, select the **Tools** tab.
2. Tap **Control Panel**.

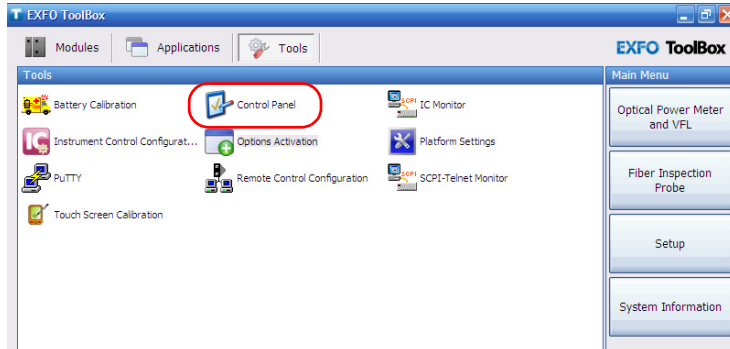

3. Tap **System**.

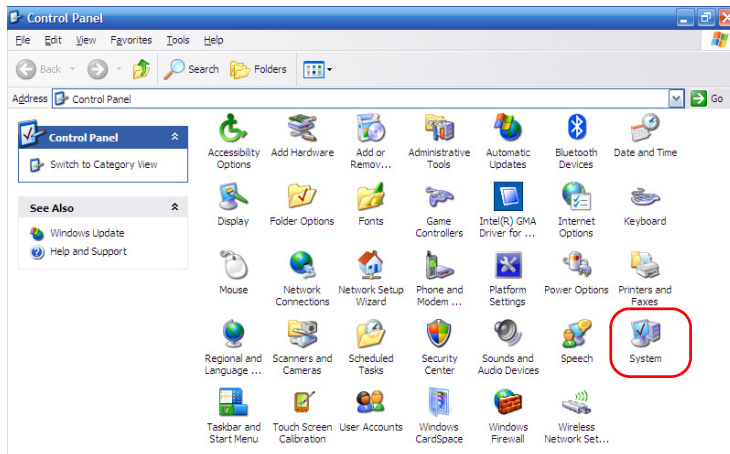

4. From the **System Properties** dialog box, tap the **Remote** tab.

Accessing Your Unit Remotely

Working with Remote Desktop

5. Under **Remote Desktop**, select **Allow users to connect remotely to this computer**.

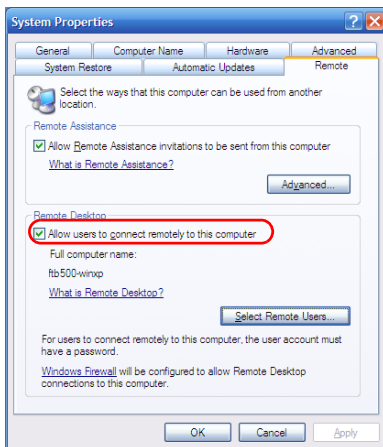

6. Tap **Select Remote Users**.

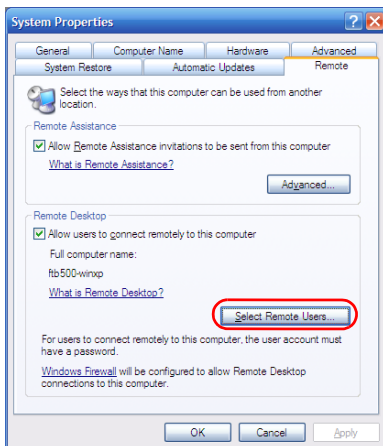

7. From the **Remote Desktop Users** dialog box, tap **Add**.

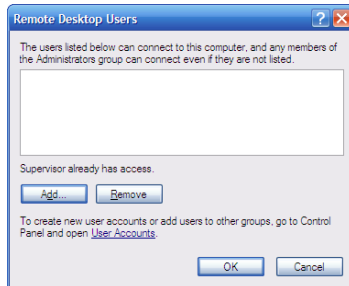

8. From the **Select Users** dialog box, tap **Advanced**.

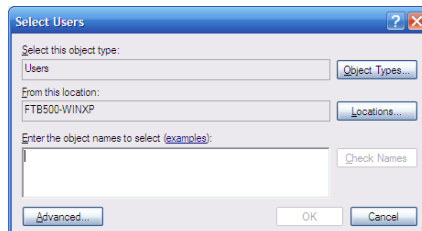

Accessing Your Unit Remotely

Working with Remote Desktop

9. Tap **Find Now** to let the system find and display the list of users.

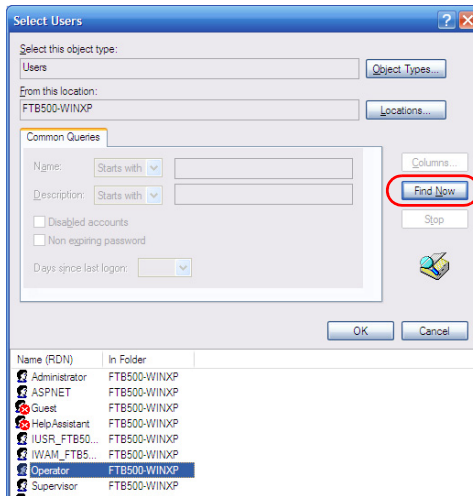

10. Select the user to which you want to grant access rights, and then tap **OK**.
11. From the list of users, select the user that you have just added, and then tap **OK**.

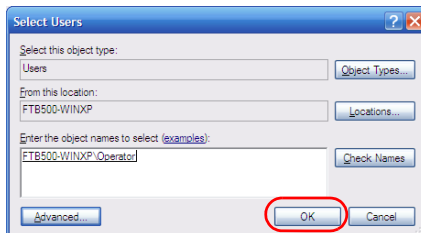

12. Repeat steps 9 to 11 with all the users to which you want to grant access rights.
13. From the **Remote Desktop Users** dialog box, tap **OK**.
14. From the **System Properties** dialog box, tap **OK** to confirm the changes and return to Control Panel.

Preventing Users from Connecting with Remote Desktop

You can also configure the unit to prevent users to access it using Remote Desktop. However, all users having administrator user rights will be able to modify this setting at any time.

To prevent users from connecting to the unit using Remote Desktop:

1. From the main window, select the **Tools** tab.
2. Tap **Control Panel**.

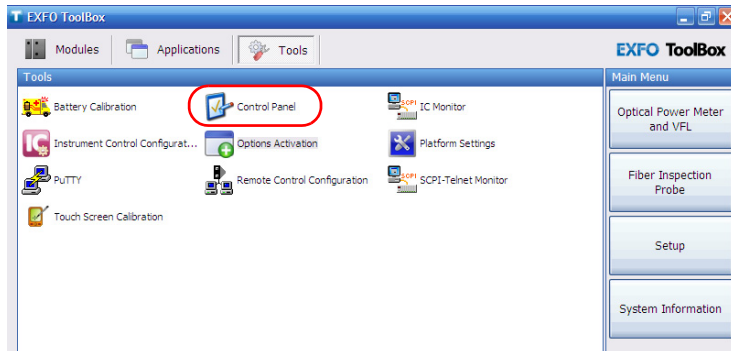

Accessing Your Unit Remotely

Working with Remote Desktop

3. Tap **System**.

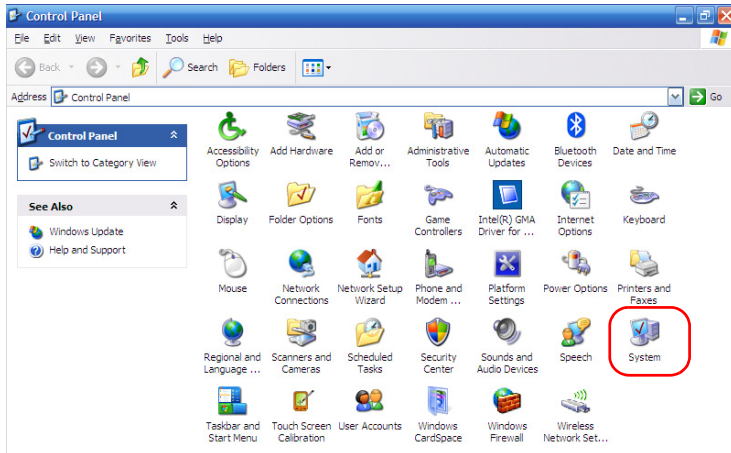

4. From the **System Properties** dialog box, tap the **Remote** tab.

5. Under **Remote Desktop**, clear the **Allow users to connect remotely to this computer** check box.

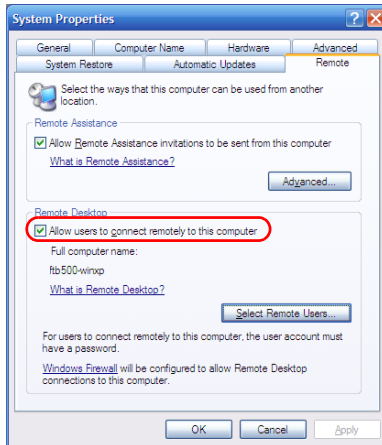

6. From the **System Properties** dialog box, tap **OK** to confirm the changes and return to Control Panel.

Working With TightVNC

The control of your unit with TightVNC requires the TightVNC Server (already installed on your unit) and the TightVNC Client Viewer (that you must install on your computer).

The first time you start the TightVNC Server on your unit, the application will prompt you to define passwords. Once these passwords are defined, you are now ready to connect to your unit using the TightVNC Client (on your computer).



CAUTION

Be very careful if you use TightVNC to transfer files between a computer and your unit (TightVNC Server).

- *Transfer from a computer to your unit:* If the transfer is interrupted, all files on your unit having the same name as those on the computer **WILL BE DELETED**. However, the files on the computer will remain available.
- *Transfer from your unit to a computer:* If the transfer is interrupted, all files on the computer having the same name as those on your unit **WILL BE DELETED**. However, the files on your unit will remain available.

To be able to connect to the unit using TightVNC, you must:

- Know the IP address of the unit and provide it in the connection settings on the computer.
- Know the password (same for all users by default).

This section provides you with the basic information to control your unit with TightVNC. For more information, refer to the TightVNC online help.

Configuring the TightVNC Server

The TightVNC Server is already installed on your unit. You must configure passwords before establishing a connection between a computer and your unit.

To configure the TightVNC Server:

1. On the Windows taskbar, tap **Start**, and then select **All Programs**.
2. Select **TightVNC**, and then **Launch TightVNC Server**.
3. If the **Current User Properties** window is not displayed automatically, from the Windows taskbar, tap **Start >All Programs >TightVNC > Show User Settings**.
4. Select the **Server** tab.
5. Under **Incoming connections**, select **Accept socket connections**.

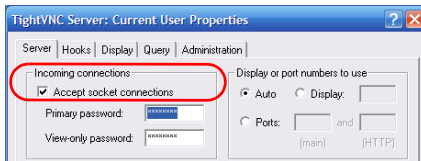

6. In the **Primary password** and **View-only password** boxes, type the desired passwords.

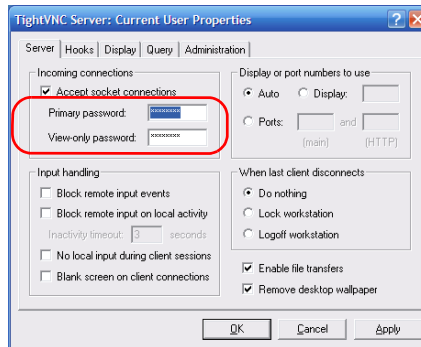

Note: *The two passwords are independent of each other. They do not have to be identical.*

7. Tap **Apply**, and then **OK**.

Installing the TightVNC Viewer on a Client Computer

If the TightVNC Viewer is not already installed on your computer, you can install it with the DVD that came with your FTB-500.

To install the TightVNC Viewer on your computer:

- 1.** Insert the installation DVD into the CD/DVD drive of your computer.
- 2.** From the DVD **Main Menu**, click **Explore this DVD**.
- 3.** Open the **Utilities** folder, and then copy the **VNC Client** folder.
- 4.** Paste the **VNC Client** folder to a location of your choice on your computer.

You are now ready to start working with the TightVNC Viewer.

Note: *If you want to access the TightVNC Viewer without having to install it on your computer, you can start it from the DVD (**Main Menu** > **Utilities** > **VNC Client**)*

Connecting to Your Unit with TightVNC

Once the TightVNC Viewer is installed on your computer, you are ready to access your unit remotely.

To connect to your unit with TightVNC:

1. Connect both the computer and your unit to the same network and make sure they can “see” each other as network restrictions might prevent them from communicating.
 - If you want to use an Ethernet network, connect an RJ-45 (network) cable to the unit’s RJ-45 port located on its left side.
 - If you want to use a wireless network, see *Connecting to a Wireless Network* on page 140.
 - You can also create a Private Area Network with your Bluetooth device (see *Transferring Data via Bluetooth* on page 132).
2. Turn on both the computer and the unit.
3. On your unit, in Toolbox, go to **Main Menu**. Select **System Information > Platform**.
4. Write down the IP address, and then close the window.

Note: *It may take a few seconds before you see the IP address on the list.*

Accessing Your Unit Remotely

Working With TightVNC

5. On the Windows taskbar, tap **Start**, and then select **All Programs**.
6. Select **TightVNC**, and then **Launch TightVNC Server**.
7. From your computer, double-click the TightVNC Viewer shortcut on your desktop.
8. In the **VNC Server** list, type the IP address of your unit that you wrote down at step 4.

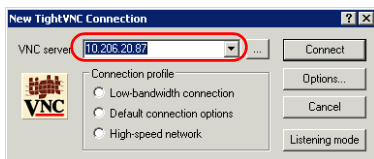

9. Click **Connect**.

Adding Exceptions to the Firewall

Note: Only administrator-level users can add exceptions to the firewall.

Your unit is protected by the Microsoft firewall to prevent unauthorized access when it is connected to a network or to the Internet. The firewall has been preconfigured so that all the applications that come with your unit work properly. However, you can allow other applications to access the network or the Internet by adding exceptions.

If you are not sure about how to configure the firewall, see with your network administrator.

To add exceptions to the firewall:

1. From the main window, select the **Tools** tab.
2. Tap **Control Panel**.

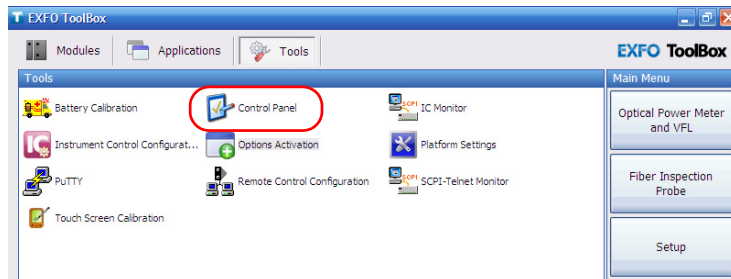

Accessing Your Unit Remotely

Adding Exceptions to the Firewall

3. Tap Windows Firewall.

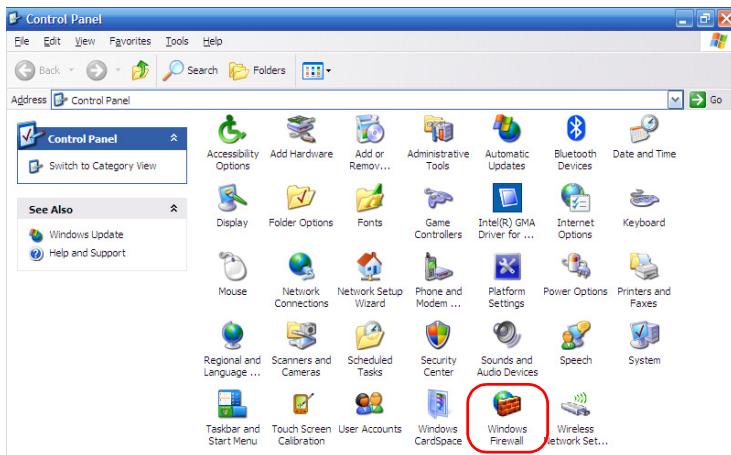

4. Select the Exceptions tab.

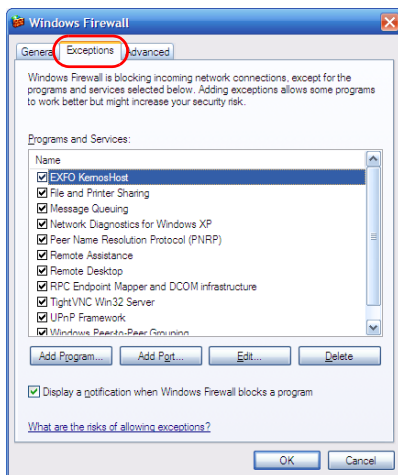

5. Tap Add Program to add any application that you need.

6. When you have finished, tap OK to confirm the changes and return to the Control Panel window.

10 Preparing for Automation

The FTB-500 was designed to meet the requirements of automation and to facilitate its integration with your test environment.

EXFO supplies commands that follow the guidelines determined by the SCPI consortium and LabVIEW drivers for many instruments. EXFO also supplies COM properties and events allowing you to build your own application. The instruments can be controlled either locally or remotely via the following technologies:

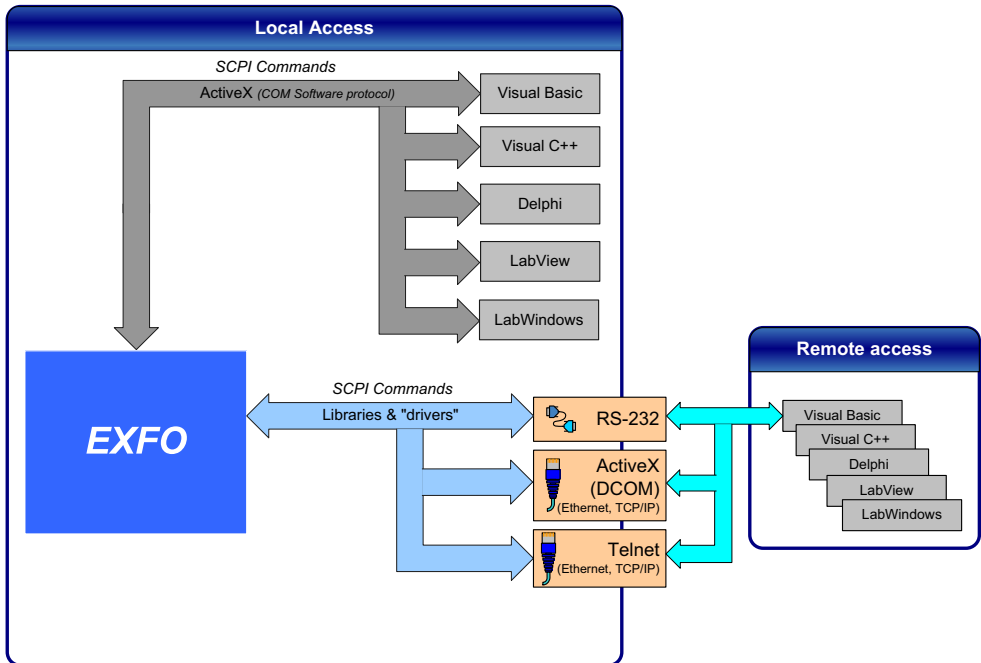

Preparing for Automation

The choice of a technology will depend on your particular needs.

Control	Technology	Characteristics
Local	ActiveX (COM)	<ul style="list-style-type: none">▶ Allows you to develop an application that will run locally on the FTB-500 within Windows XP▶ Best approach when speed is your top priority (no physical connection that slows down the process)▶ Supported by most development software▶ Lower cost
Remote	ActiveX (DCOM) (Ethernet, TCP/IP)	<ul style="list-style-type: none">▶ Allows the sharing of network resources▶ Allows you to develop computer-based applications to directly communicate with the FTB-500
Remote	RS-232	<ul style="list-style-type: none">▶ Null-modem cable required to establish connection between the computer and the FTB-500▶ For increased speed and performance, run the application locally on the FTB-500 through ActiveX instead of using RS-232
Remote	Telnet (Ethernet, TCP/IP)	<ul style="list-style-type: none">▶ FTB-500 can be directly connected to a Local Area Network (LAN) or Wide Area Network (WAN) via its 10/100/1000 Base-T interface▶ Allows the sharing of network resources▶ Allows you to develop computer-based applications very easily to directly communicate with the FTB-500

For more information on programming aspects, see the section on using your product in an automated test environment.

Linking Units with the Ethernet Port

Your FTB-500 is equipped with an Ethernet port (10/100 000)to send and receive data.Refer to the Windows documentation for information about Ethernet port settings and possibilities.

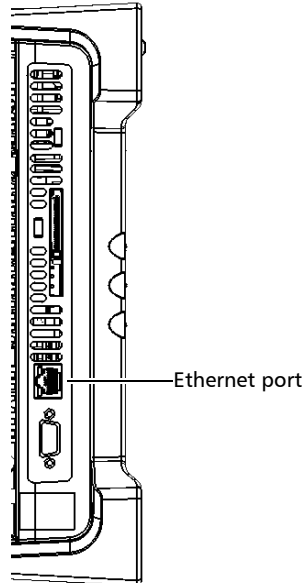

Preparing for Automation

Linking Units with the Serial Port

Linking Units with the Serial Port

Your FTB-500 is equipped with a serial (RS-232) port to send and receive data. Refer to the Microsoft Windows documentation for information about serial port settings and possibilities.

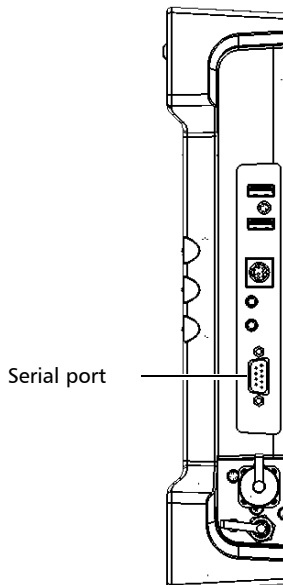

Getting Optimum Performance from Your FTB-500

Several factors influence the data transfer rate of an FTB-500. The information presented hereafter will help you get the best transfer rate possible.

- *Output unit (RS-232, ActiveX and TCP/IP):* The FTB-500 can return results in
 - linear units (for example, watts)
 - log units (for example, dBm)

Since internal units are linear, you will get optimal performance by using linear units for output (no need for an internal conversion to log).

Note: *You must make the choice of output unit for each instrument offering such a feature. Refer to the user guide of each optical instrument for a list of available commands and queries.*

Preparing for Automation

Getting Optimum Performance from Your FTB-500

- *Output format (RS-232, ActiveX and TCP/IP):* The FTB-500 provides the following output formats for measurement results:
 - ASCII
 - PACKed

Generally, the PACKed format allows to pass three to four times more information than the ASCII format for the same transfer rate. Often, the PACKed format is also more efficient since it reduces the FTB-500 CPU work load (no need for an internal conversion to ASCII format).

Note: *The PACKed format will only be applied to <DEFINITE LENGTH ARBITRARY BLOCK RESPONSE DATA> and <INDEFINITE LENGTH ARBITRARY BLOCK RESPONSE DATA>.*

Note: *The choice of data format cannot be made directly via the ToolBox software.*

For more information on how to set the output format and data types, see *:FORMat[:DATA]*(IEEE 488.2 and specific commands appendix), *Read* and *ReadBinary* (COM properties and events appendix), and the data types appendix.

Changing Communication Settings

Communication settings cannot be modified without turning on your FTB-500 and starting ToolBox

To change communication settings:

1. Select the **Tools** tab, then **Instrument Control Configuration**.

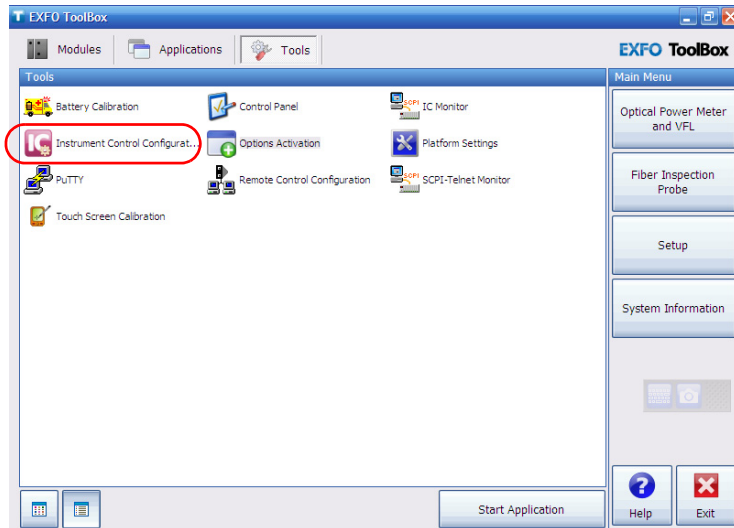

Preparing for Automation

Changing Communication Settings

- Under **Platform Startup**, determine whether your module applications will be started locally or remotely by clicking the corresponding option.
 - If **Local** mode is selected, you will not be able to send remote commands to your FTB-500.
 - If **Remote** mode is selected, all modules in your FTB-500 will be initialized upon startup so you are ready to send remote commands.

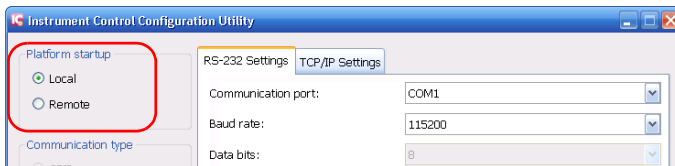

If you selected **Local** mode, you can go directly to step 5.

- Under **Communication Type**, select **ActiveX**, **RS-232**, or **TCP/IP**.

For more information on the choice of a particular type, see the table on page 176.

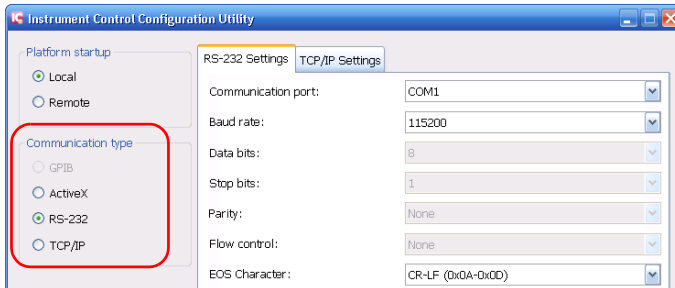

Note: If the selected communication type does not match the protocol that will actually be used, an error message is displayed when attempting to control the instruments.

4. According to the communication type you have selected, customize the corresponding parameters as shown below.

➤ For RS-232

Serial port—used to connect the RS-232 cable.
The only available value is COM1.

Determines the speed at which data is sent between the FTB-500 and a computer, in bits per second (b/s).

End-of-string (EOS) character—used to indicate the end of a data string (when sending or receiving data).

RS-232 Settings	TCP/IP Settings
Communication port:	COM1
Baud rate:	115200
Data bits:	8
Stop bits:	1
Parity:	None
Flow control:	None
EOS Character:	CR-LF (0x0A-0x0D)

➤ For TCP/IP

TCP/IP port 5024—used to connect over Telnet.

RS-232 Settings	TCP/IP Settings
Port:	SCPI-Telnet (Port 5024)

For information on communicating with TCP/IP over Telnet, see the section pertaining to communication through TCP/IP over Telnet.

5. Click **Apply** to confirm your changes.

Preparing for Automation

Changing Communication Settings

To revert to default general settings:

1. Click the **Restore Default Settings** button.

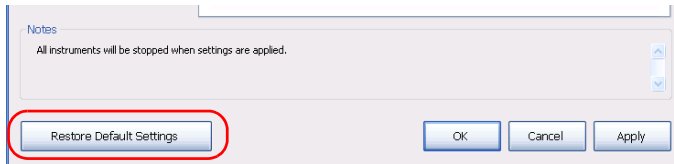

2. Click **Apply** to confirm your changes.

To revert to default RS-232 settings:

1. Click the **Default RS-232 Settings** button.

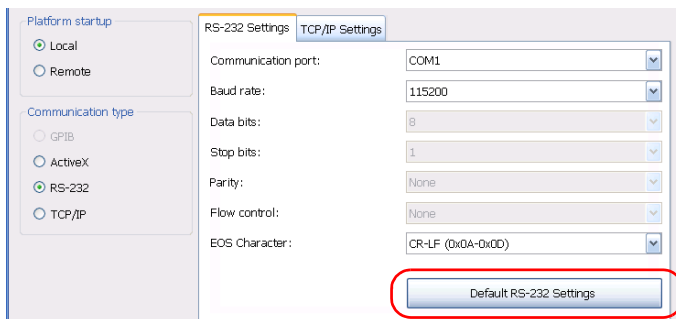

2. Click **Apply** to confirm your changes.

Configuring DCOM Access to Your Unit

DCOM technology allows to control devices and optical instruments via Ethernet. The EXFO IcSCPIAccess Class component provided with your FTB-500 acts as a communication link between a client application and EXFO's Instrument Control.

DCOM ensures communication between the client application and Instrument Control via your local network. Since each network has its own configuration, you need to be familiar with network security, users, groups, domain management, etc. Basic programming skills are also required to work with DCOM. For more information, you can refer to the Microsoft MSDN Help feature, which provides exhaustive technical documentation on all DCOM issues.

The example presented in the following pages illustrates how to make the EXFO IcSCPIAccess Class component available to all users of a local network under Windows XP. The example provided below is for guidance only; it may not work properly with all networks and interfaces may slightly differ depending on the operating system used.

To enable DCOM access to your FTB-500, you must:

- set the general security parameters
- customize the specific security parameters
- register callback events.

Preparing for Automation

Configuring DCOM Access to Your Unit

Setting the General Security Parameters

Note: To run *DCOMCNFG.EXE*, you need administrator access rights.

To set the general security parameters:

1. On the Windows taskbar, click **Start** and select **Run**.
2. In the **Open** box, type *DCOMCNFG.EXE* and click **OK**.
3. In the **Component Services** dialog box, go to **Console Root > Component Services > Computers**.

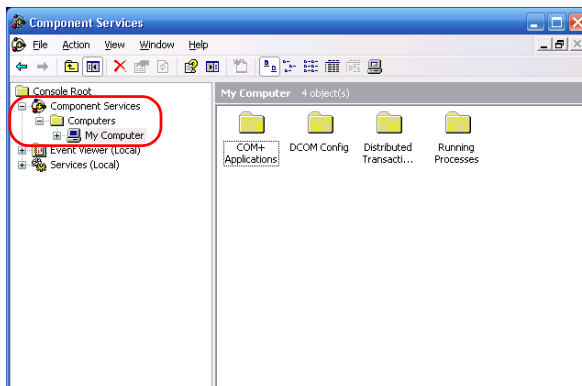

4. In the **Computers** dialog box, right-click **My Computer**, and then select **Properties**.

5. In the **My Computer Properties** dialog box, click the **COM Security** tab.

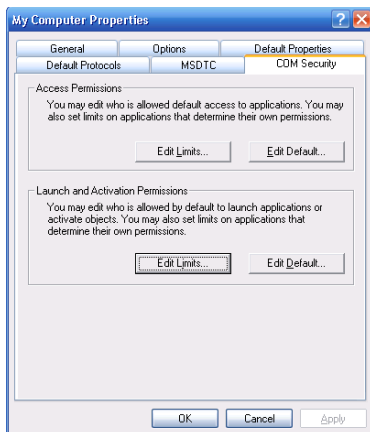

6. Under **Access Permissions**, click **Edit Limits**.

Preparing for Automation

Configuring DCOM Access to Your Unit

7. In the **Access Permission** dialog box, ensure that the **Distributed COM Users** group appears in the **Group or user names** list.

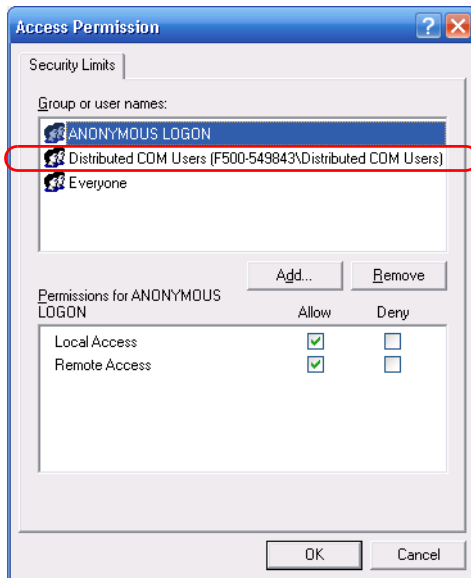

You can now allow users to access general DCOM services on your FTB-500. You can either:

- Add a user to the **Distributed COM Users** group (refer to Microsoft help).
- OR
- Add a user explicitly under both, **Access Permission** and **Launch Permission** tabs (see procedure below).

Note: *If you add a user explicitly, ensure to give remote access rights to the new user.*

To add a user explicitly:

- 1.** In the **My Computer Properties** dialog box, click the **COM Security** tab.
- 2.** Under **Access Permissions**, click **Edit Limits**.
- 3.** In the **Access Permission** dialog box, click **Add**.

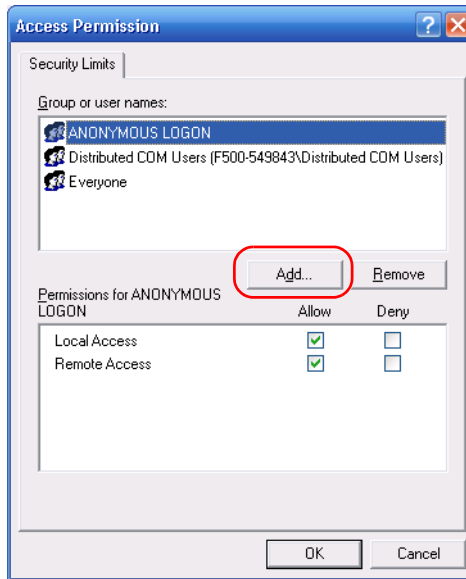

Preparing for Automation

Configuring DCOM Access to Your Unit

4. In the **Select Users or Groups** dialog box, under **Enter the object names to select**, type the name of the user to whom you want to give access rights.

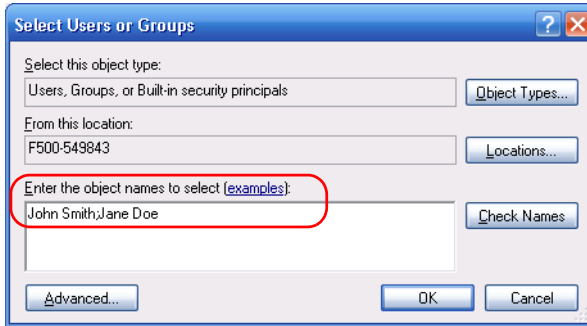

5. Click **OK**.

6. Confirm the newly added user has remote access permission as follows:
 - 6a. In the **Access Permission** dialog box, select the name of the new user.

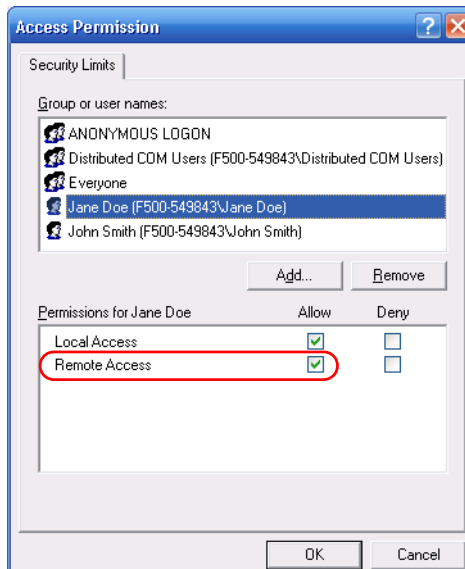

- 6b. Under **Permissions for** (new user), ensure **Allow** is selected for **Remote Access**.
 - 6c. Click **OK**.
7. In the **My Computer Properties** dialog box, click the **COM Security** tab.
8. Under **Access Permissions**, click **Edit Limits**.

Preparing for Automation

Configuring DCOM Access to Your Unit

9. In the **Launch Permission** dialog box, click **Add**.

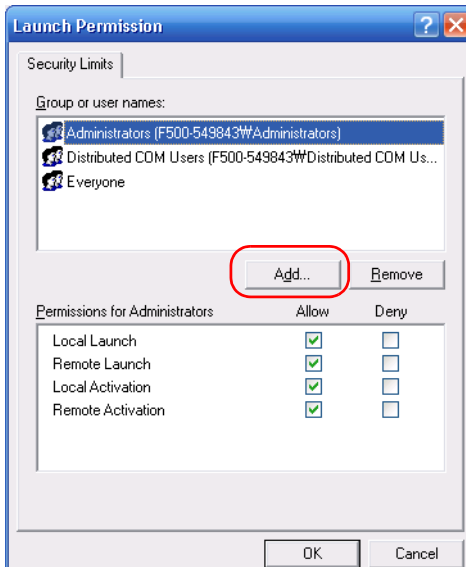

10. In the **Select Users or Groups** dialog box, under **Enter the object names to select**, type the name of the user to whom you want to give start and activation access rights.

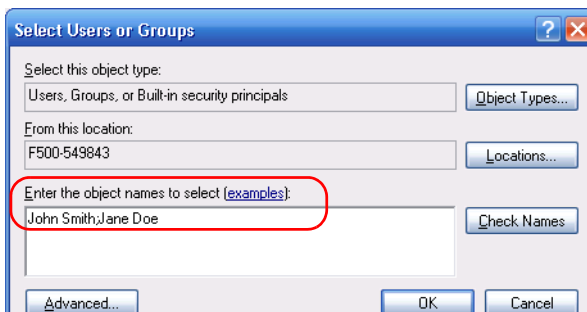

11. Click **OK**.

12. Confirm the newly added user has **Remote Launch and Activation** permission as follows:

12a. In the **Launch Permission** dialog box, select the name of the new user.

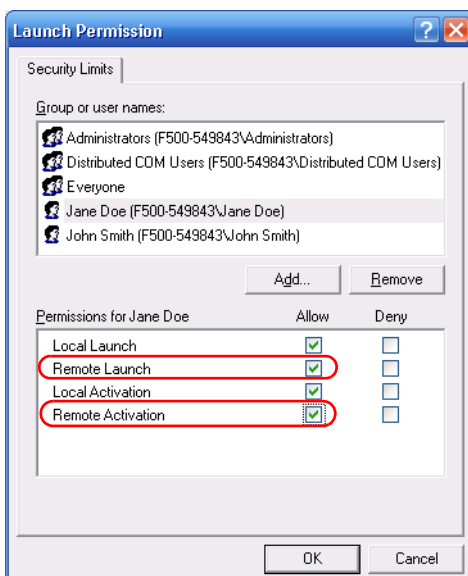

12b. Under **Permissions for** (new user), ensure **Allow** is selected for both **Remote Launch** and **Remote Activation**.

12c. Click **OK**.

Customizing the Specific Security Parameters

Once you have defined the general security parameters, you can define the specific security parameters.

To customize the specific security parameters:

1. From the **Component Services** dialog box, select: *Console Root > Component Services > Computers > My Computer > DCOM Config* to show the contents of the **DCOM Config** folder.

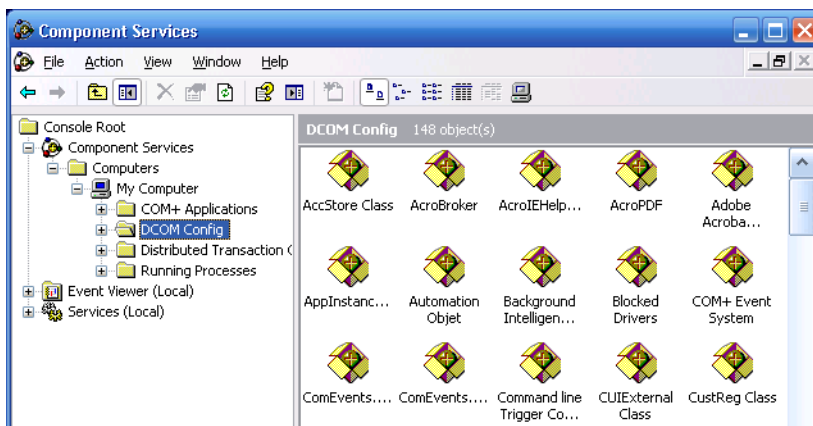

2. From **DCOM Config**, right-click **EXFO KernosHost**, and select **Properties**.
3. Click the **General** tab.

4. In the **Authentication Level** list, select **Default**.

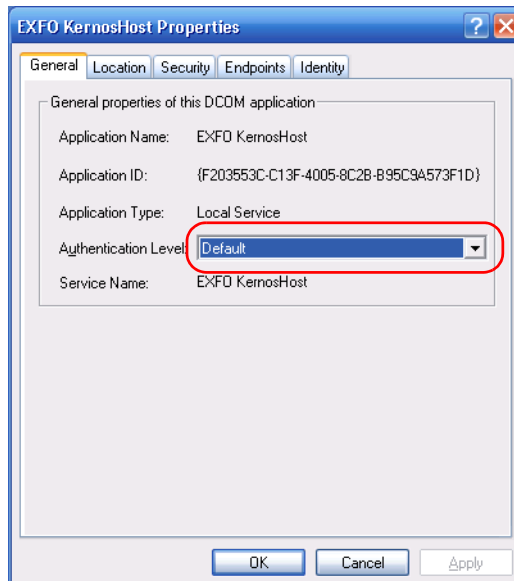

Preparing for Automation

Configuring DCOM Access to Your Unit

5. In the **EXFO KernosHost Properties** dialog box, click the **Security** tab.
6. Under **Launch and Activation Permissions**, select **Customize**, and then click **Edit** to edit the list of allowed users.

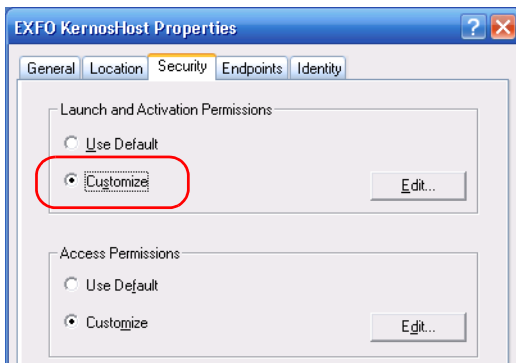

IMPORTANT

Customizing access rights sets both remote AND local permissions. As a result, you will have to specify every user who must have local access to the system (see *Setting the General Security Parameters* on page 186).

If you do not specify local access rights, no user will be able to access EXFO KernosHost and, therefore, no user will be able to start ToolBox.

7. In the **Launch Permission** dialog box, click **Add**.

8. In the **Select Users or Groups** dialog box, under **Enter the object names to select**, type the name of the user to whom you want to give start and activation permissions for remote access.

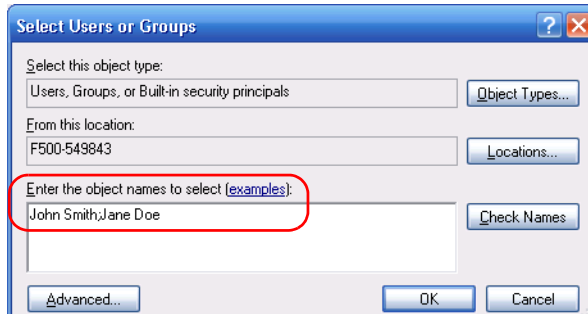

9. Click **OK**.

Preparing for Automation

Configuring DCOM Access to Your Unit

- 10.** In the **Launch Permission** dialog box, select a user.
- 11.** To allow this user to start and activate the FTB-500 remotely, select **Allow** for all four permission choices.
- 12.** Repeat steps 10 and 11 for each newly added user.

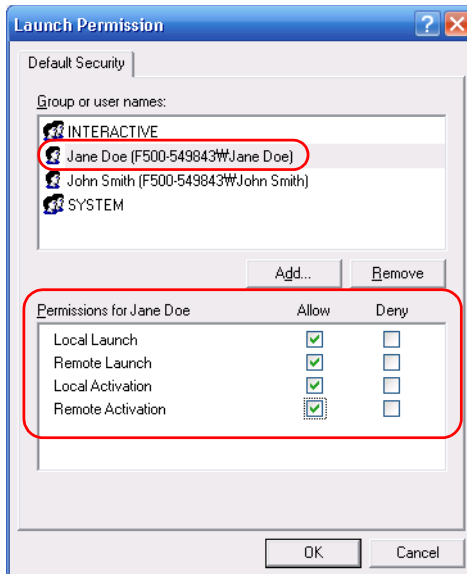

- 13.** Click **OK**.

14. In the **EXFO KernosHost Properties** dialog box, click the **Security** tab.
15. Under **Access Permissions**, select **Customize**, and click **Edit** to edit the list of allowed users.

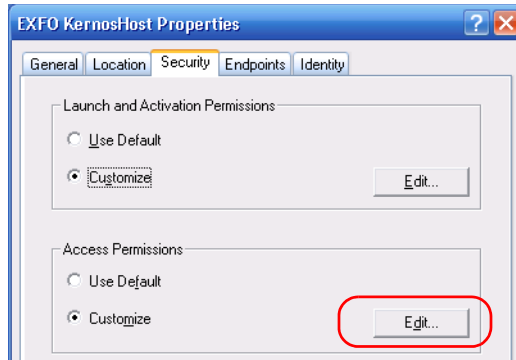

IMPORTANT

Customizing access rights sets both remote AND local permissions. As a result, you will have to specify every user who must have local access to the system (see *Setting the General Security Parameters* on page 186).

If you do not specify local access rights, no user will be able to access EXFO KernosHost and, therefore, no user will be able to start ToolBox.

16. In the **Access Permission** dialog box, click **Add**.

Preparing for Automation

Configuring DCOM Access to Your Unit

17. In the **Select Users or Groups** dialog box, under **Enter the object names to select**, type the name of the user to whom you want to give access permissions for remote access.

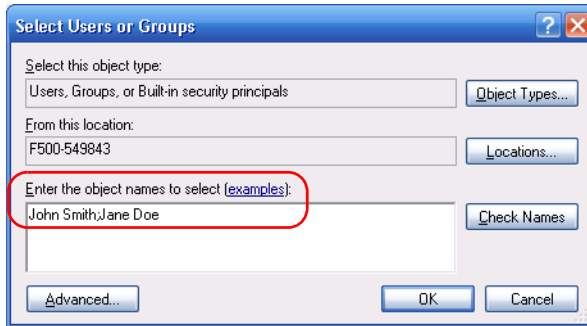

18. Click **OK**.
19. In the **Access Permission** dialog box, select a user.
20. To allow this user to access the FTB-500 remotely, select **Allow** for both permission choices.

21. Repeat steps 19 and 20 for each newly added user.

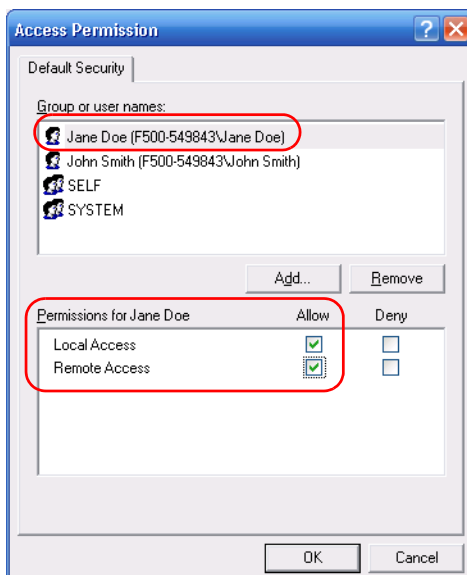

Note: *You can also deny connection permission for specific users.*

22. Click **OK** to close the **Access Permission** dialog box.

23. Click **OK** to close the **EXFO KernosHost Properties** dialog box.

24. Restart your FTB-500.

The EXFO IcsCIAccess Class component, located on your FTB-500, can now be accessed with DCOM.

Note: *To run DCOMCNFG.EXE, you need Administrator access rights.*

Preparing for Automation

Configuring DCOM Access to Your Unit

Enabling DCOM on Client Computer

If you want to subscribe to EXFO IcSCPIAccess Class component events, you need to set security parameters on the client computer.

To enable DCOM on the client computer:

- 1.** Start **Windows**, on the taskbar, click **Start** and select **Run**.
- 2.** In the **Open** box, type “DCOMCNFG.EXE” and click **OK**.
- 3.** Click **OK** to open the **Component Services** dialog box.

4. In the **Component Services** dialog box, select: *Console Root*>
Component Services> *Computers*> to show available computers.

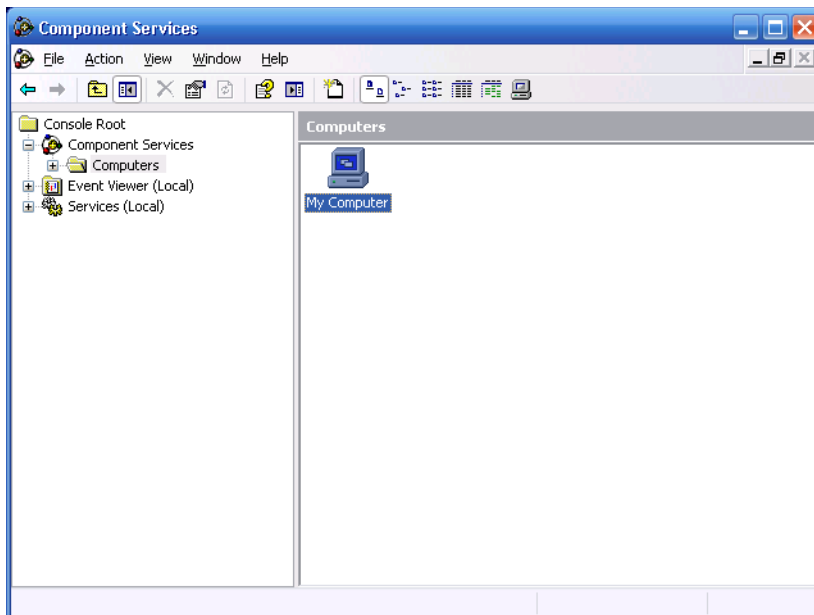

Preparing for Automation

Configuring DCOM Access to Your Unit

5. Right-click **My Computer**, and then select **Properties**.
6. In the **My Computer Properties** dialog box, click the **Default Properties** tab.
7. Select **Enable Distributed COM on this computer**.

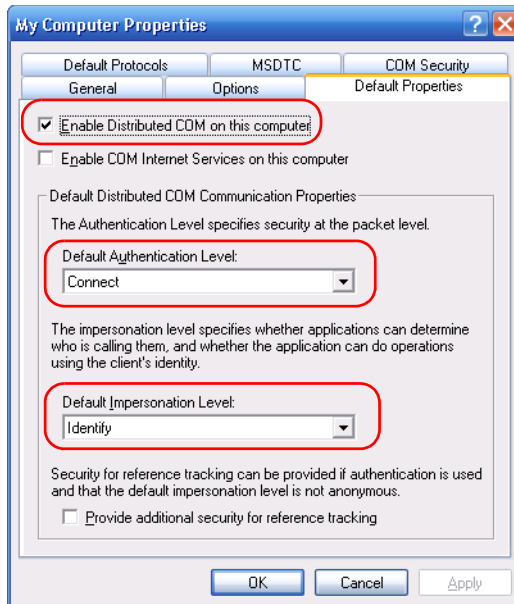

8. Under **Default Distributed COM Communication Properties**, in the **Default Authentication Level** list, select **Connect**.
9. In the **Default Impersonation Level** list, select **Identify**.
10. Click **OK**.

- 11.** Click the **COM Security** tab and, under **Access Permissions**, click **Edit Limits**.

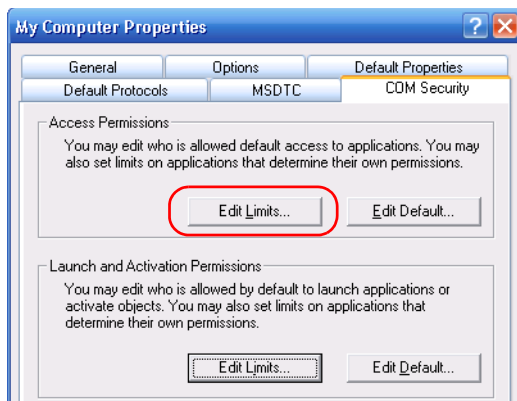

- 12.** In the Access Permission dialog box, ensure that, for **ANONYMOUS LOGON**, local and remote accesses are allowed.

If **ANONYMOUS LOGON** is not listed under **Group or user names**, click **Add** to add it.

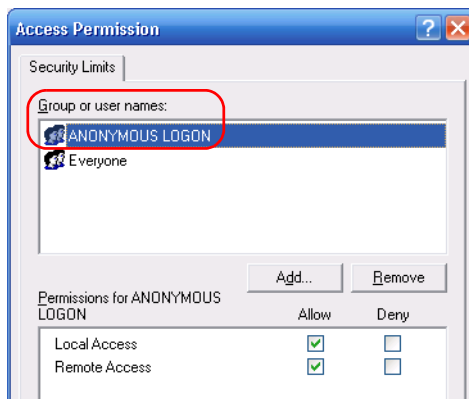

For more information on enabling events with DCOM, refer to *AppId Key* in MSDN Documentation.

Disabling DCOM Access to Your FTB-500

If you no longer want client computers to access your FTB-500 using DCOM, you can disable this access.

To disable DCOM access to your FTB-500:

1. Start **Windows**, on the taskbar, click **Start** and select **Run**.
2. In the **Open** box, type “DCOMCNFG.EXE” and click **OK**.
3. In the **Component Services** dialog box, select: *Console Root > Component Services > Computers > My Computer > DCOM Config* to show the contents of the **DCOM Config** dialog box.

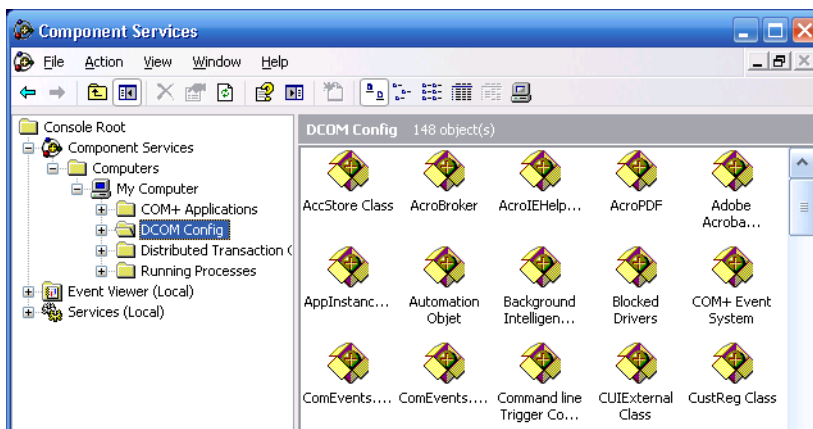

4. In the **DCOM Config** dialog box, right-click **EXFO KernosHost**, and select **Properties**.

5. In the **EXFO KernosHost Properties** dialog box, click the **Security** tab.
6. Under **Launch and Activation Permissions** and **Access Permissions**, select **Use Default**.

This ensures the EXFO IcSCPIAccess Class component uses the default lists instead of the customized lists.

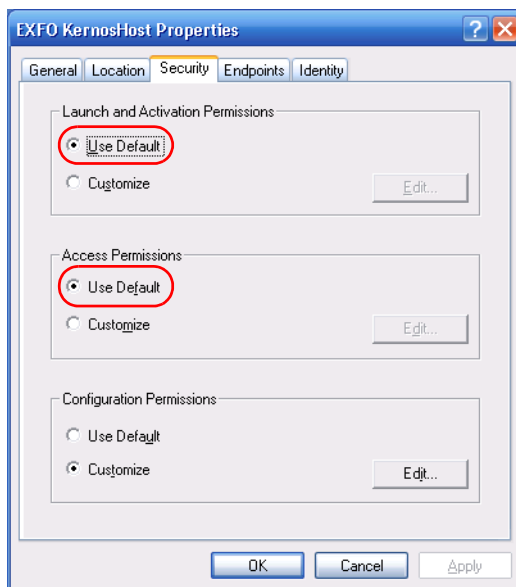

7. Click **OK**.
8. Restart your FTB-500.

The EXFO IcSCPIAccess Class component, located on your FTB-500, *cannot* be accessed with DCOM.

Preparing to Control Modules with a Dedicated Application

Some modules come with a dedicated application designed to control them remotely from a computer. The main characteristic of this application is that it lets another user control the module exactly as if he had it close at hand.

To control the module remotely, you must configure it on the unit containing the module, including a description that can help you identify it. The user controlling the module from a computer must install the dedicated application (for more information on the installation, refer to the application documentation).

- The module can be controlled both remotely and locally at the same time.
- You will have to configure your remote control again in the following cases:
 - you inserted the module in another slot
 - you applied changes on applications while the module is not inserted in its slot.

Note: *Some modules do not support the remote control.*



IMPORTANT

If there is a network failure or a problem with your remotely-controlled module, you can shut down the latter without closing all the other applications. The local and remote module session will then be closed.

Preparing for Automation

Preparing to Control Modules with a Dedicated Application

To activate or deactivate remote control:

1. Select the **Tools** tab.

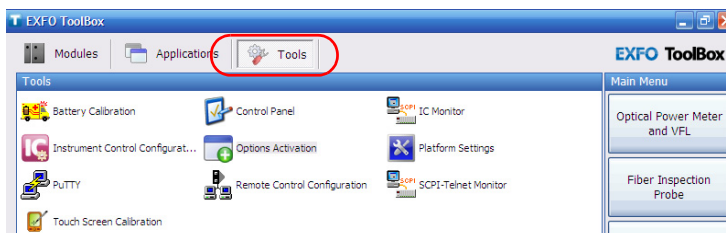

2. Select **Remote Control Configuration**.

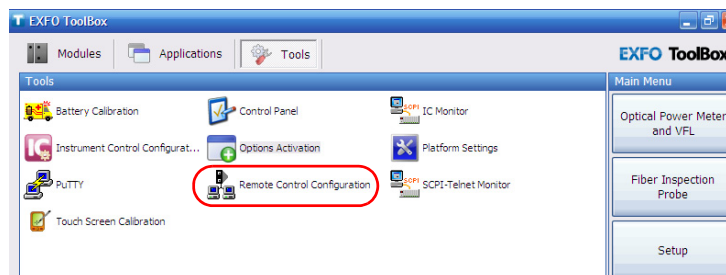

Preparing for Automation

Preparing to Control Modules with a Dedicated Application

3. From the **Remote Control Configuration** window you will see all the inserted modules. Select the module you want to have a remote access on.

Note: *Modules for which remote control is not supported are identified as unrecognized.*

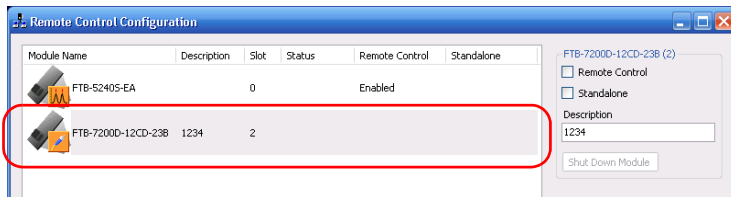

4. Set the parameters:
 - Select **Remote Control** to let another user control the module from a computer.
 - Select **Standalone** to leave the module active even if all users close their dedicated applications.

5. Under **Description**, type a relevant description (test interface ID, for example).

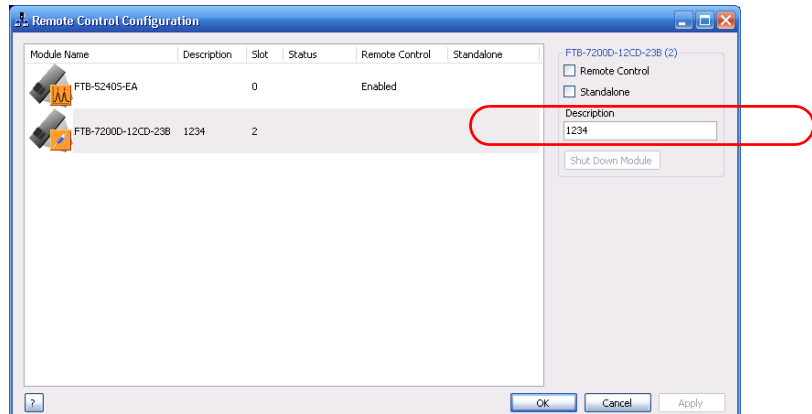

Note: You can enter up to 10 characters. The description corresponds to the test interface ID or any other relevant description.

6. Press **Apply** to enter your changes or **OK** to apply your changes and close the window.

Note: This information will be updated the next time you start the module application and appear in the title bar if the module application allows it. Refer to the corresponding module documentation for more details.

To shut down the remotely-controlled module:

Press **Shut Down Module**.

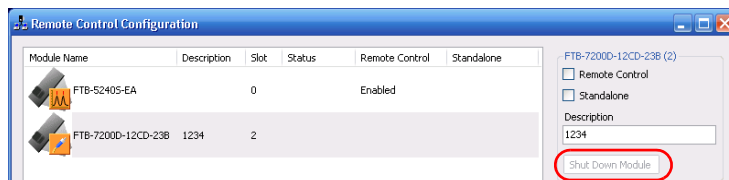

11 *Using FTB Products in an Automated Test Environment*

EXFO supplies commands that follow the guidelines determined by the SCPI consortium and LabVIEW drivers for all available instruments. EXFO also supplies COM properties and events allowing you to build your own application.

Your application can be developed using LabVIEW, Visual C++, Delphi.NET, Visual Basic or any other language that runs under Windows XP.

The present chapter gives you information to help you use the provided commands, drivers, and COM properties and events to remotely control your instruments.

If you need information on how to prepare your FTB-500 for remote control, see the corresponding section in this documentation.

Managing the States of Your FTB-500

Your FTB-500 can be in one of the following states:

State	Characteristics
Local	<ul style="list-style-type: none">▶ Front-panel keys of the FTB-500 unit and peripherals are all functional▶ Default state at unit turn on
Remote	<ul style="list-style-type: none">▶ Front-panel keys of the FTB-500 unit and peripherals are <i>not</i> functional except for the LOCAL key and the power switch
Local with lockout	<ul style="list-style-type: none">▶ Return to Local mode only possible via commands sent from the system controller▶ Pressing the front-panel LOCAL key causes an URQ message (see <i>Standard Status Data Structure</i> on page 216)
Remote with lockout	<ul style="list-style-type: none">▶ Front-panel keys of the FTB-500 unit and peripherals are <i>not</i> functional except for the power switch▶ Return to Local mode only possible via commands sent from the system controller▶ Pressing the front-panel LOCAL key causes an URQ message (see <i>Standard Status Data Structure</i> on page 216)

Note: *The current state is displayed in the ToolBox status bar.*

The following diagram shows the possible transitions between the different states.

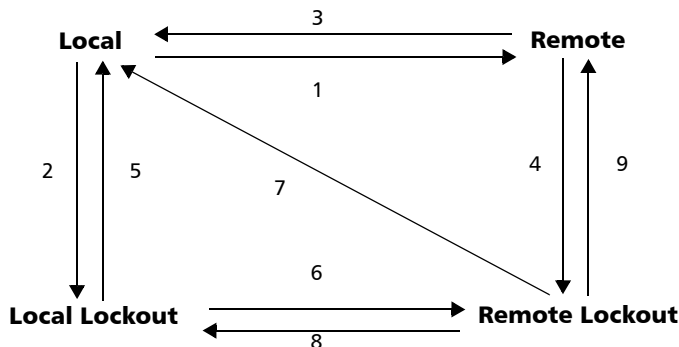

No.	Possible in ActiveX by setting:
1	The <i>RemoteState</i> property to True.
2	The <i>LockoutState</i> property to True.
3	The <i>RemoteState</i> property to False.
4	The <i>LockoutState</i> property to True.
5	The <i>LockoutState</i> property to False.
6	The <i>RemoteState</i> property to True.
7	-----
8	The <i>RemoteState</i> property to False.
9	The <i>LockoutState</i> property to False.

Note: See the appendix on COM properties and events for more information.

Note: You can also return to local state by turning the device off and on again. However, this operation will cause the controller to lose control of the system (no more local lockout state). All settings made on the device by the controller will be lost (reset of device configuration when turning on).

Standard Status Data Structure

Each device that is physically connected to the remote bus has four status registers with a structure complying with the IEEE 488.2 standard. These registers allow the controller to monitor events and get useful information on the status of the devices it controls.

- Standard Event Status Register (ESR)
- Standard Event Status Enable Register (ESE)
- Status Byte Register (STB)
- Service Request Enable Register (SRE)

ESR and ESE

The standard event status register and status enable register information is presented in the following table.

Bits	Mnemonics	Bit Value
7	Power On (PON)	128
6	User Request (URQ)	64
5	Command Error (CME)	32
4	Execution Error (EXE)	16
3	Device-Dependent Error (DDE)	8
2	Query Error (QYE)	4
1	Not Used (N.U.)	0
0	Operation Complete (OPC)	1

The following table presents a summary of the possible operations on ESR and ESE registers.

Register	Read	Write	Clear
ESR	Use *ESR?.	Impossible to write.	<ul style="list-style-type: none"> ▶ Use *CLS. ▶ Read the register.
ESE	Use *ESE?.	Use *ESE.	Use *ESE with a value equal to 0.

STB and SRE

The status byte register and service request enable register information is presented in the following table.

Bits	Mnemonics	Bit Value
7	Not Used (N.U.)	0
6	Master Summary Status (MSS)/ Service Request (RQS)	64
5	Event Summary Bit (ESB)	32
4	Message Available (MAV)	16
3	Not Used (N.U.)	0
2	Error Available (EAV)	4
1	Not Used (N.U.)	0
0	Not Used (N.U.)	0

Using FTB Products in an Automated Test Environment

Standard Status Data Structure

The following table presents a summary of the possible operations on STB and SRE registers.

Register	Read	Write	Clear
STB	<ul style="list-style-type: none">▶ Use *STB?.▶ Use serial poll (GPIB bus sequence that allows retrieval of the value without interrupting the current process).	Impossible to write; the register content is only modified when the Event registers or Queues are modified.	Use *CLS before sending a query (to clear the Event registers and Queues and by the same token clear the STB register).
SRE	Use *SRE?.	Use *SRE with a value equal to 0 to disable the register or with a value equal to 1 to enable it.	<ul style="list-style-type: none">▶ Use *SRE with a value equal to 0.▶ At startup, the register is set to 0.

The diagram displayed on the next page is a useful aid in understanding the general commands and how a service request (SRQ) is generated.

Using a service request, a device notifies the controller that an event requiring special attention occurred. The controller will then find which device generated a SRQ (its RQS bit is set) and the causes of it.

Using FTB Products in an Automated Test Environment

Standard Status Data Structure

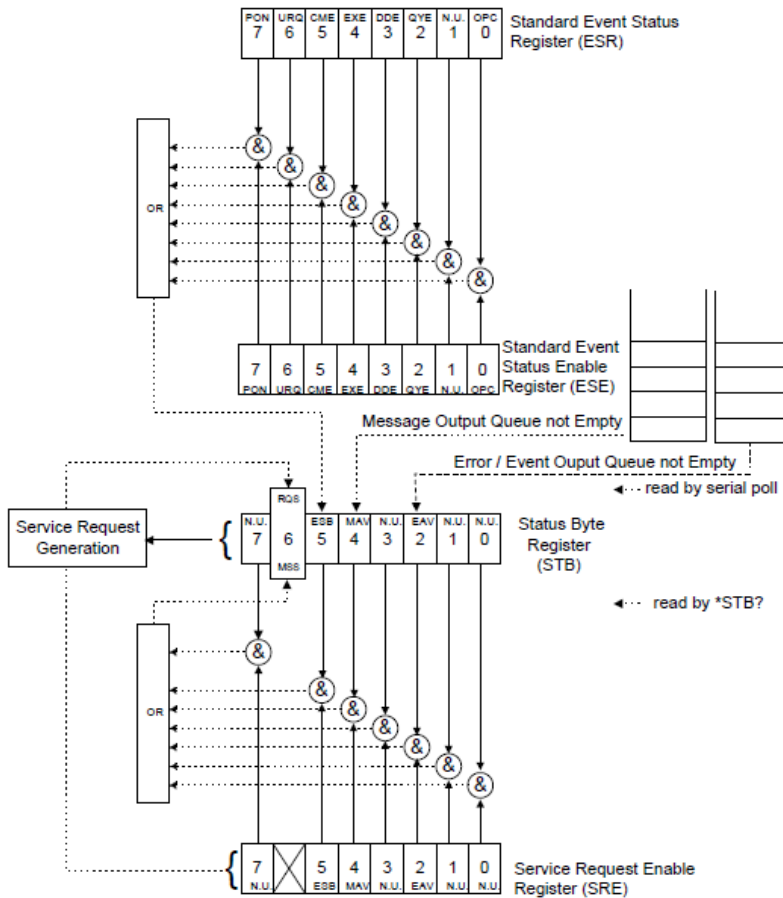

SCPI Command Structure

The information presented in this section provides an overview of GPIB programming. If you need detailed information, refer to:

- The International Institute of Electrical and Electronics Engineers. *IEEE Standard 488.2-1992, IEEE Standard Codes, Formats, Protocols and Common Commands For Use with ANSI/IEEE Std. 488.1-1987*. New York, 1992.
- *Standard Commands for Programmable Instruments (SCPI). Volume 1: Syntax and Style*. Vers. 1999.0 May, U.S.A, 1999.

The provided commands follow the guidelines determined by the Standard Commands for Programmable Instruments (SCPI) consortium. A *program message* consists of one or more commands (and/or queries) with their appropriate parameters.

For example, a program message could contain a command used to activate or deactivate a source. The corresponding command syntax would be:

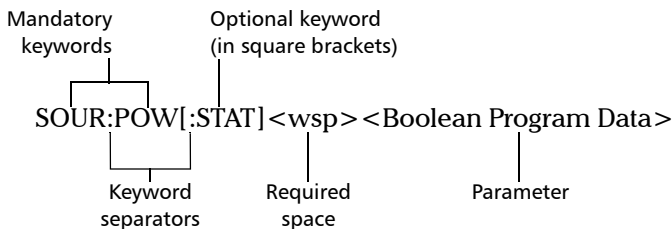

When sending a message containing the previous command, you would actually type: `SOUR:POW ON`.

The following table shows elements that are commonly used in the commands or queries syntax.

Item	Meaning
[]	Enclose optional keywords or parameters. <i>Do not include square brackets in your program message.</i>
[1..n]	Indicates that the instrument provides multiple capabilities and that you have to specify which one you want to use. If you omit the value, the command will take effect on the first capability. Multiple capabilities can be found at any branch of the command tree (root, intermediate node or terminal node). Example: If the command is :SENSe[1..n]:CORRection:COLLect:ZERO and you want it to take effect on the second SENSE (sensor) capability of the instrument, you may send this: :SENSe2:CORRection:COLLect:ZERO. <i>Do not include square brackets in your program message; simply enter the number.</i>
<wsp>	Indicates that a space is required (“wsp” stands for “white space”). Corresponds to ASCII character codes (0 to 9 and 11 to 32, in decimal). <i>Do not include “<wsp>” in your program message; simply type a space.</i>
<digit>	Element used in the construction of various numeric data types. Can take any value between 0 and 9 inclusively (corresponds to ASCII character codes 48 to 57, in decimal).

Using FTB Products in an Automated Test Environment

SCPI Command Structure

Item	Meaning
<mnemonic>	<p>Element used in the construction of certain data types and program messages.</p> <div style="text-align: center;"> </div> <p>In the diagram above,</p> <ul style="list-style-type: none"> ➤ “<Upper/lower case alpha>” corresponds to ASCII character codes (65 to 90 and 97 to 122, in decimal). ➤ “_” corresponds to an underscore character (code 95, in decimal).
< >	<p>Text appearing between angled brackets specifies the command parameter to be sent or the response you will receive from an instrument.</p> <p><i>Do not include angled brackets in your program message.</i></p>
	<p>Indicates that one, and only one, value must be selected from the available choices.</p> <p>Example: If the list is 0 1, you can only select 0 or 1.</p> <p><i>Do not include the pipe character in your program message.</i></p>
{ }	<p>Indicate that the enclosed parameters can appear 0 to n times when the command is used.</p> <p><i>Do not include braces in your program message.</i></p>
:	<p>Mandatory to separate keywords. Can be omitted at the beginning of a program message. For example, you can use either :SYST:ERR or SYST:ERR.</p>

Item	Meaning
;	<ul style="list-style-type: none"> ➤ Mandatory to separate the different commands of a program message when more than one command is sent at a time. In this case, it is called <i><PROGRAM MESSAGE UNIT SEPARATOR></i>. ➤ Also used to separate responses when multiple queries were sent in a single program message. In this case, it is called <i><RESPONSE MESSAGE UNIT SEPARATOR></i>.
,	<ul style="list-style-type: none"> ➤ Mandatory to separate parameters in a command or a query. In this case, it is called <i><PROGRAM DATA SEPARATOR></i>. ➤ Also used to separate the various responses from a query. In this case, it is called <i><RESPONSE DATA SEPARATOR></i>.

There are also several conventions regarding command syntax:

- Spelling errors will cancel the command or query.
- Commands and queries are not case-sensitive. You can type your program messages using either lower-case or upper-case letters.
- The command or query can be written using only the three- or four-letter shortcuts, only full words, or a combination of both.

The example below shows the long and the short forms of a same query.

:SYSTem:ERRor?		Long form
:SYST:ERR?	}	Short form (small words represented by the capital letters of the long form)
:syst:err?		

Consulting Data Types

If you need information about data types used in EXFO's documentation, see the appendix on data types.

Writing Remote Control Code

Complex measurement programs may be written using any programming environment that supports GPIB communication. GPIB development kits are available for most of the popular commercial programming languages.

The FTB-500 offers many commands permitting complete remote control of all the FTB components. These commands adhere to the SCPI standard.

You can find all the commands and queries supported by the FTB-500 unit in the *IEEE 488.2 and Specific Commands* appendix. For information on commands specific to particular instruments, refer to the instrument's user guide.

When you write code, you must follow these rules on message reception and transmission:

- The controller must have sent a complete message to the instrument (including the message terminator) before retrieving a response.
- The controller must retrieve all the responses from previous queries (including the response terminator) before sending a new message to an instrument.
- The controller must not try to retrieve a response from an instrument if the corresponding query has not been previously sent to the instrument.
- You must pay special attention to queries that return an indefinite ASCII response. To avoid any confusion, the IEEE 488.2 standard requires that this data type be immediately followed by a response termination character. For this reason, when working with compound queries, you must ensure that a query sending an indefinite ASCII response is the last query of the series.
- Be careful when sending program messages containing multiple queries that return large amounts of data. Since the controller can only retrieve data when the instrument has finished processing the queries, it could result in problems ranging from a saturation of the output queue to the complete blocking of the whole system.

Error Message Format

System and device-specific errors are managed by the FTB-500. The generic format for error messages is illustrated in the following figure.

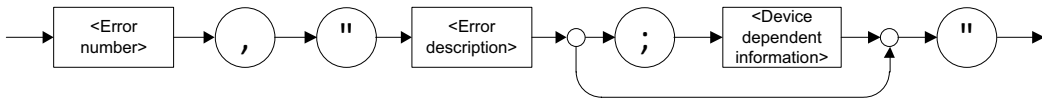

As shown in the above figure, the message contains three parts:

- error number
- error description
- device-dependent information

Error messages ending in a negative number are SCPI-based errors.

Working with EXFO COM Objects

The *ToolBox* CD offers you a demo application to show how to communicate with your FTB-500 using COM technology via the provided IcSCPIAccess interface.

The source files can be found on the CD under:

F:\examples\ScpiActiveX

where *F* corresponds to the CD-ROM drive (the CD-ROM drive letter may differ from one computer to another).

This application has been designed with Visual Basic and, therefore, must be compiled using Visual Basic 6.0, Service Pack 5.

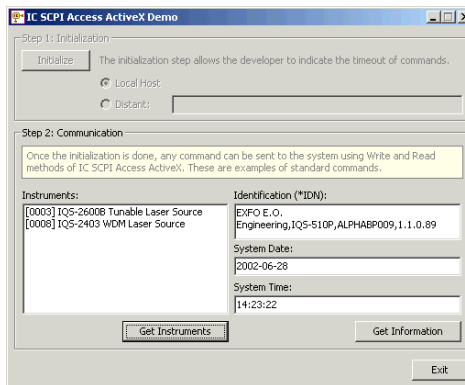

With this demo application, you can control your FTB-500 either in local (COM technology) or remote (DCOM technology) mode.

If you want to work in remote mode, see the section on configuring DCOM access for your unit in this user guide.

Working with EXFO LabVIEW Drivers

EXFO provides you with custom drivers that you can use to program commands for your inspection instruments.



IMPORTANT

You need to be familiar with the LabVIEW environment and programming methods to work with EXFO drivers.

Regardless of whether you work with the provided Getting Started applications or your own VIs (using EXFO drivers), the steps remain the same.

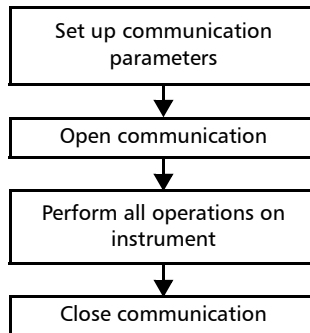

Before configuring the communication parameters via LabVIEW (provided applications or new VI), you must configure the FTB-500 for remote control. For more information, see the section on preparing your unit for automation in this user guide.



IMPORTANT

Ensure that the communication type that you will set in LabVIEW matches the one selected for the FTB-500.

Using FTB Products in an Automated Test Environment

Working with EXFO LabVIEW Drivers

The following table presents the possible settings for communication parameters. These parameters must be set from LabVIEW for each instrument.

Parameter	Active X (local)	Active X (remote)	RS-232 (remote)
Communication type	ActiveX	ActiveX	RS232
VISA resource name	N/A	N/A	Select the serial port from the list
FTB slot number	Concatenation of the FTB-500 unit number (0) and the instrument's slot number	Concatenation of the FTB-500 unit number (0) and the instrument's slot number.	Concatenation of the FTB-500 unit number (0) and the instrument's slot number.
Machine name	localhost	Ethernet address, that is IP address or machine name of your FTB-500	N/A

Note: *When you are working with platform or IEEE 488.2 commands, you can leave the slot number at its current value.*

Using the EXFO Getting Started Applications

Once the LabVIEW drivers are installed, the Getting Started demo applications are available to demonstrate the following:

- How to open and close the communication link between the remote computer and the device.
- Some of the available functions (by loading the necessary *.vi* files).

All the *.vi* files related to an instrument are presented in the same folder. By default, they can be found under:

C:\Program Files\EXFO\LabVIEW Getting Started\Getting Started xxxx
(where xxxx corresponds to the instrument code).

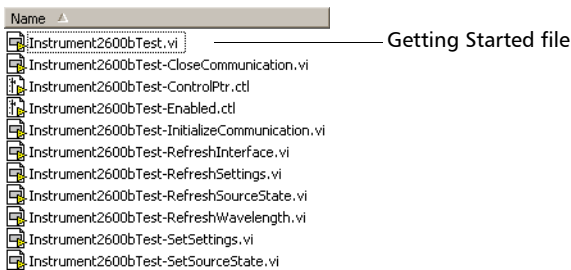

All Getting Started filenames follow this pattern: *InstrumentxxxxTest.vi*
(where xxxx corresponds to the product code).

You can also directly start a demo application this way:

From the Windows task bar, click the **Start** button, then point to **All Programs > EXFO > LabVIEW Getting Started Applications**, and click **Getting Started xxxx** (where xxxx corresponds to the product code).

Each Getting Started application offers a user interface (called Front Panel and a design view (called Block Diagram).

Using FTB Products in an Automated Test Environment

Using the EXFO Getting Started Applications

On the Front Panel, you can set communication parameters between the FTB-500 and the current instrument. It also offers various controls and buttons to use the instrument easily. In fact, the application performs the necessary calls to the instrument's drivers so it is transparent to the user.

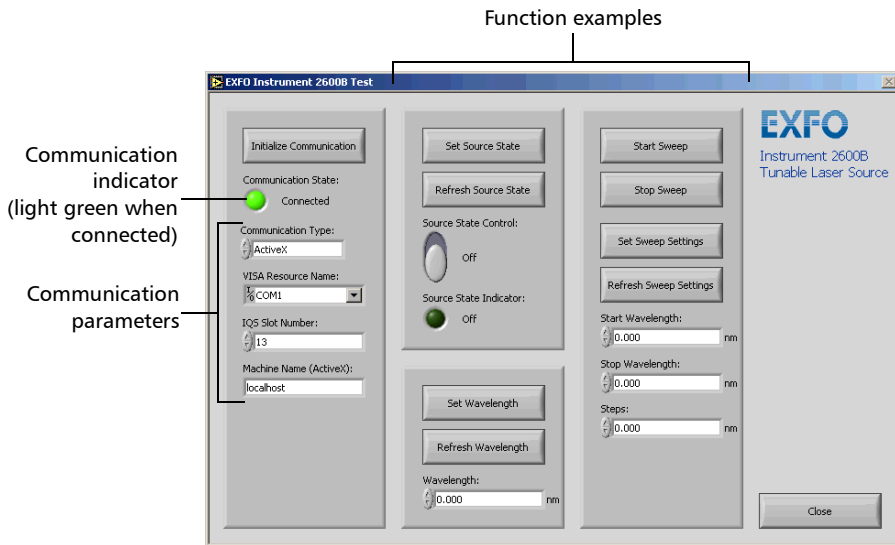

The application state (called State Machine) changes whenever an action is performed on the instrument. If you toggle to Block Diagram view, you can see the list of possible states. The application is always in one of the predefined states.

Using FTB Products in an Automated Test Environment

Using the EXFO Getting Started Applications

The following figure illustrates the State Machine after the user has clicked on the button allowing you to set the source state (from the Front Panel). When the State Machine changes to “SetSourceState”, the application calls “Instrument2600bTest_SetSourceState.vi”, which, in turn, calls the “SourcePowerState_GSet.vi” sub VI that will perform the appropriate action on the instrument.

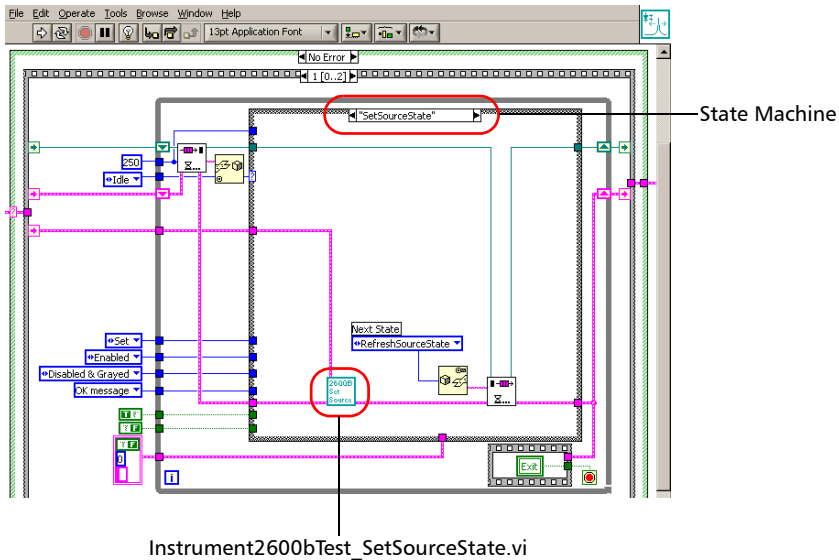

Using FTB Products in an Automated Test Environment

Using the EXFO Getting Started Applications

The detail of this sub VI gives precious information on how to call an instrument driver VI.

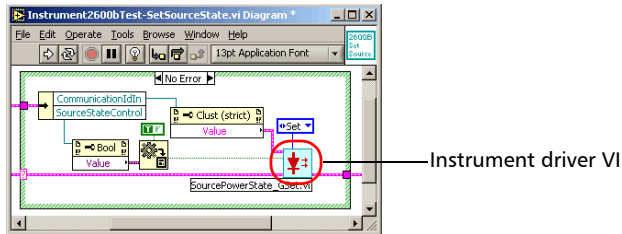

To use a Getting Started application:

1. Turn on the FTB-500, start ToolBox, and ensure that all the remote-control parameters are set correctly.
2. Open the desired Getting Started application and run it from LabVIEW.
3. From the application's Front Panel, set the communication parameters.
For information on communication parameters, see *Working with EXFO LabVIEW Drivers* on page 228.
4. Once the parameters are configured, click **Initialize Communication**.

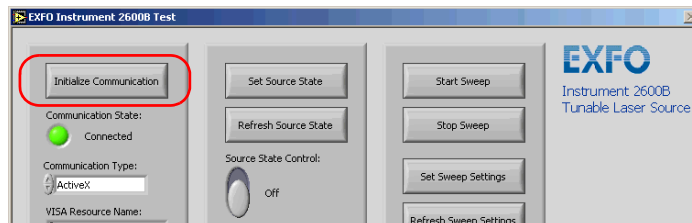

5. Using the provided buttons and controls, perform the desired actions.

Using FTB Products in an Automated Test Environment

Using the EXFO Getting Started Applications

- When you are finished, select **Close** to end the communication.

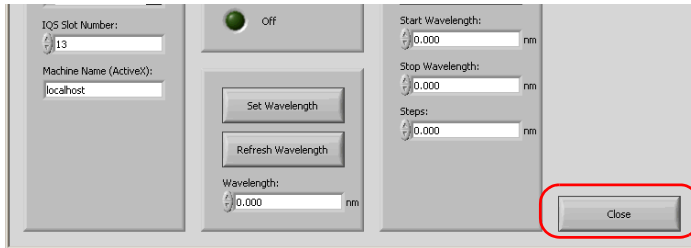

- Close LabVIEW.



IMPORTANT

To avoid losing the original version of the Getting Started applications, do not save changes when prompted by LabVIEW.

Building and Using Custom VIs

EXFO LabVIEW drivers have been designed to let you control the various instruments according to your needs, by building your own VIs in LabVIEW.

You can access EXFO drivers

- directly from
C:\Program Files\National Instruments\LabVIEW 6\instr.lib\EXFO
- from the LabVIEW function palettes

Each icon of the EXFO palette corresponds to a set of drivers that allow you to either

- communicate with EXFO instruments that support remote control
- open and close communication links with instruments
- send IEEE 488.2 (common) commands
- send platform commands (specific to FTB-500)

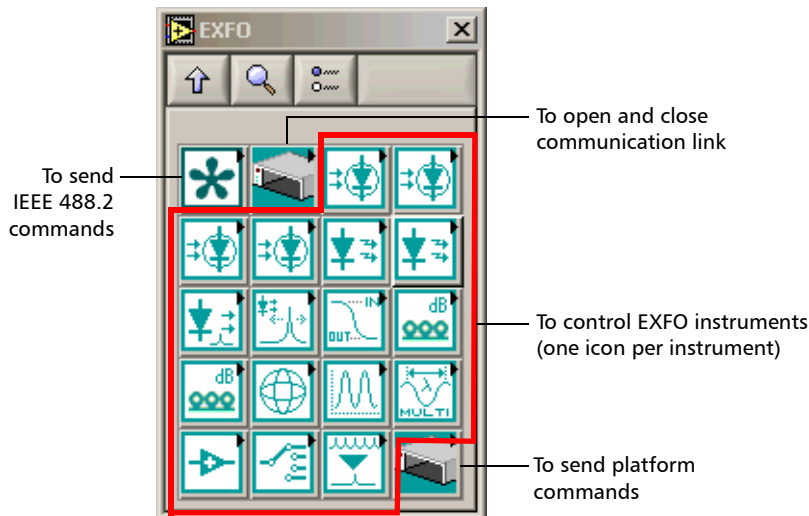

Using FTB Products in an Automated Test Environment

Building and Using Custom VIs

When you click an icon in the EXFO palette, the corresponding sub-palette opens, giving you access to the different functions.

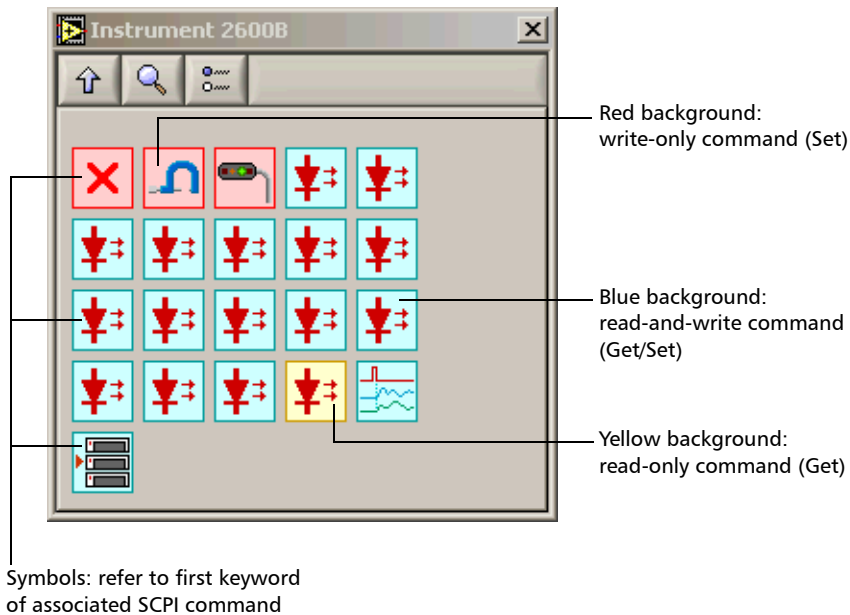

Note: *The procedure provided hereafter is for guidance only. The actual procedure may vary depending on the type of product you are using.*

To build a custom VI:

1. Start LabVIEW and create a new VI.
2. Open the **EXFO** palette.
 - 2a. From LabVIEW, open the Diagram Block view.
 - 2b. Display the **Functions** palette and select **Instrument I/O**.

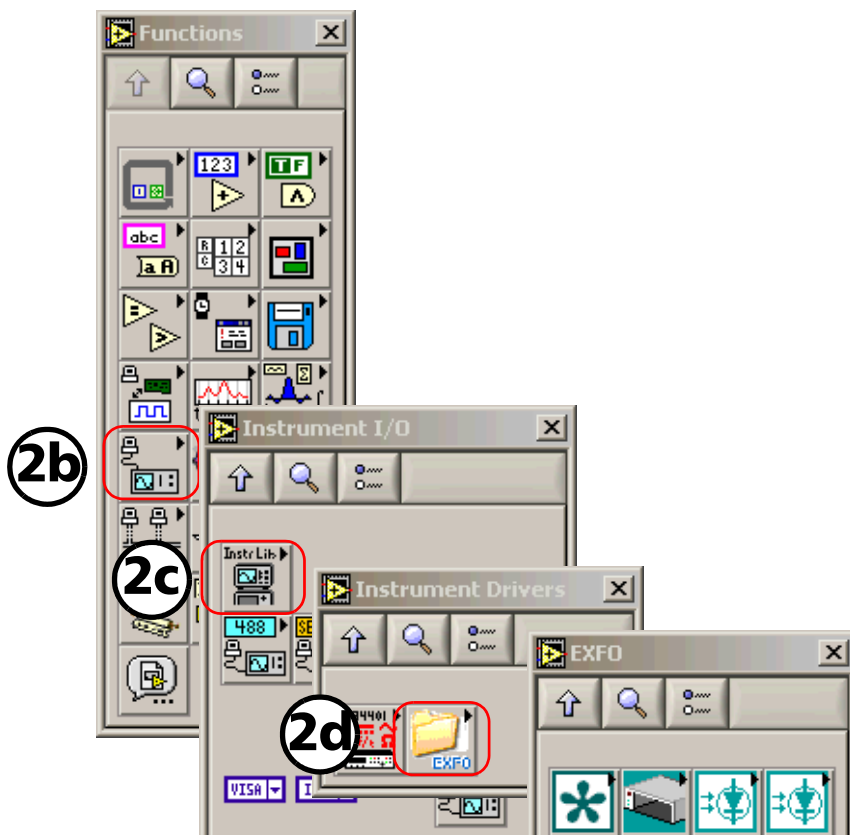

Using FTB Products in an Automated Test Environment

Building and Using Custom VIs

- 2c.** From the **Instrument I/O** palette, select **Instrument Drivers**.
- 2d.** From the **Instrument Drivers** palette, select **EXFO**.
- 3.** Select **EXFO IQS Base**.
- 4.** From the **EXFO IQS Base** palette, select *EXIQSBASE_OpenComm.vi* and add it to your new VI.

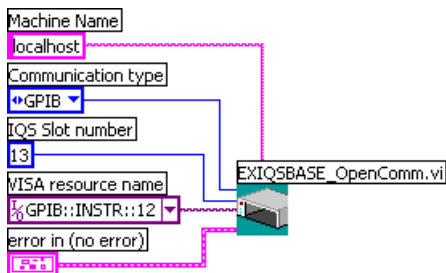

- 5.** Set the communication parameters. For information on communication parameters, see *Working with EXFO LabVIEW Drivers* on page 228.
- 6.** From the EXFO palette, select the desired instrument.
- 7.** From the instrument's palette, select the function you need and add the corresponding driver to your VI.

8. Set the required parameters and connect the instrument *Communication ID in* parameter to the *Communication ID out* parameter from EXIQSBASE_OpenComm.vi.

The example below shows how to configure the SourcePowerState_GSet.vi to turn on the tunable lasersource. In this example, *Set* was chosen and the *PowerState* parameter was set to *True*.

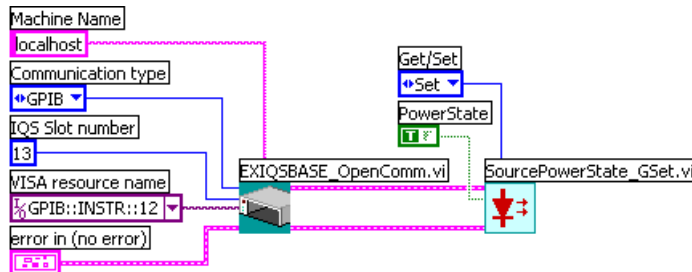

9. Repeat steps 7 and 8 for each of the functions you want to use.

However, you have to link *Communication ID in* of the new driver to *Communication ID out* of the preceding driver.

Note: *If you want to use platform or IEEE 488.2 commands, add the desired driver to your VI and configure its parameters exactly as you would do with any instrument function.*

Using FTB Products in an Automated Test Environment

Building and Using Custom VIs

10. When you are finished, add *EXIQSBASE_CloseComm.vi* to your VI.

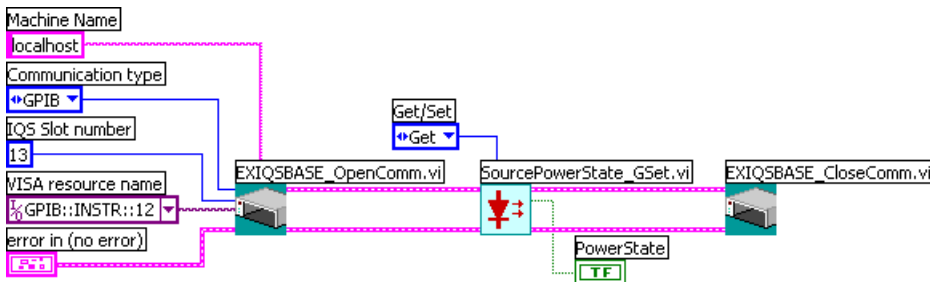

Connect the *Communication ID out* parameter of the last function to the *Communication ID in* parameter of *EXIQSBASE_CloseComm.vi*.

Note: You only have to open communication once at the beginning, and close it when all of the desired functions will have been added.

11. Save your work.

To use your new VI:

1. Turn on the FTB-500, start ToolBox, and ensure that all the remote-control parameters are set correctly.
2. From LabVIEW, run the VI.

Monitoring Remote Commands

ToolBox allows you to monitor remote commands sent to your units, if desired.

To monitor remote commands:

1. Select the **Tools** tab.
2. Depending on which type of communication protocol you are using, select **IC Monitor** or **SCPI Telnet Monitor**.

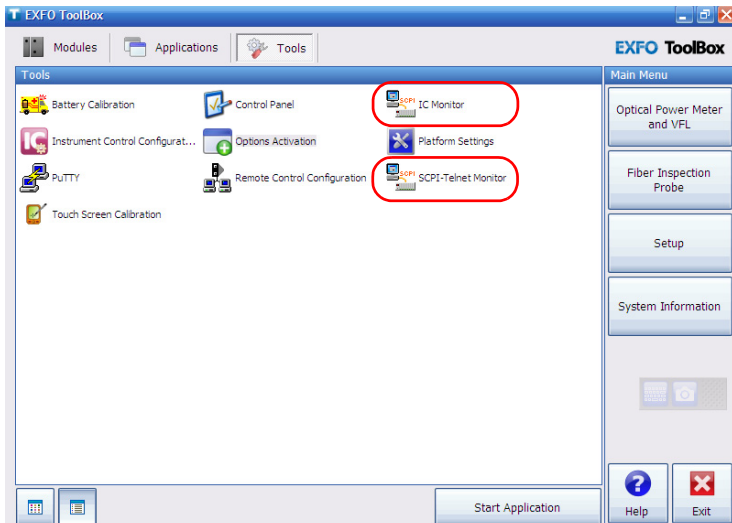

Using FTB Products in an Automated Test Environment

Monitoring Remote Commands

- 3. Do one of the following:
 - If monitoring using ActiveX or RS-232, click **Connect to IC**.

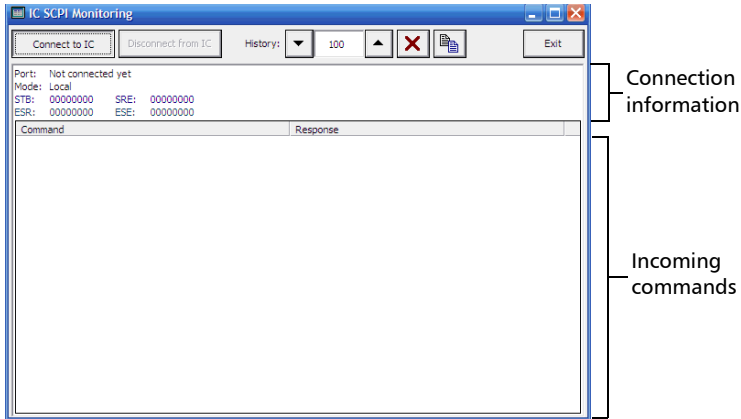

You are automatically connected to the monitoring system. The **Disconnect from IC** button becomes available for you when you are ready to disconnect.

Once connected, your current connection information will appear in the upper part of the window, and the commands will appear as a list in the lower part of the window.

With the **History** parameter, you determine how many commands you want to keep in the list. You can change the number by using the arrow buttons on each side of the list.

To clear the history, click .

To view the list in any word processor, click  to copy it to the clipboard, and then paste it in your document. You can use any program, as the list is copied in text format.

To exit the monitoring utility, click **Exit**.

For more information, see the section on using your unit in an automated test environment.

Using FTB Products in an Automated Test Environment

Monitoring Remote Commands

- If monitoring using TCP/IP, which provides sending SCPI commands over TCP/IP through Telnet from the EXFO Instrument Control, you are automatically connected to the monitoring system.

Note: Port 5024 is designated for sending SCPI commands in the Telnet protocol.

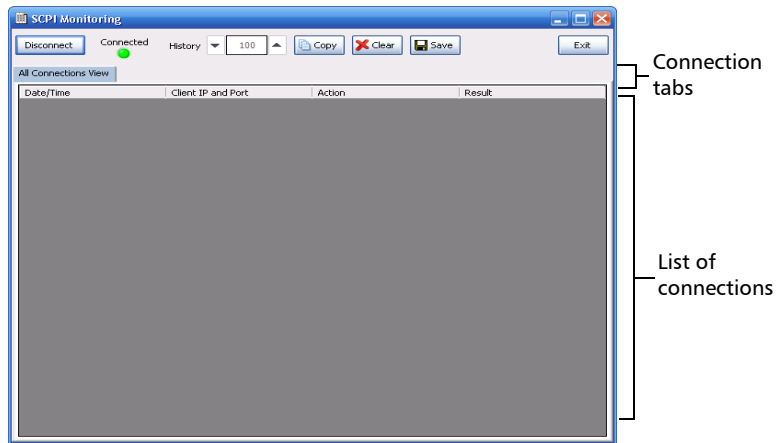

Once connected, your current connection information will appear in the **All Connections View** tab, and the commands will appear as a list in the lower part of the window.

The **Disconnect** button becomes available for you to click when you are ready to disconnect.

Using FTB Products in an Automated Test Environment

Monitoring Remote Commands

Connection information is also displayed in a separate tab, identified by its IP address, from where you can monitor the commands and other actions sent through TCP/IP over Telnet, as well as the results.

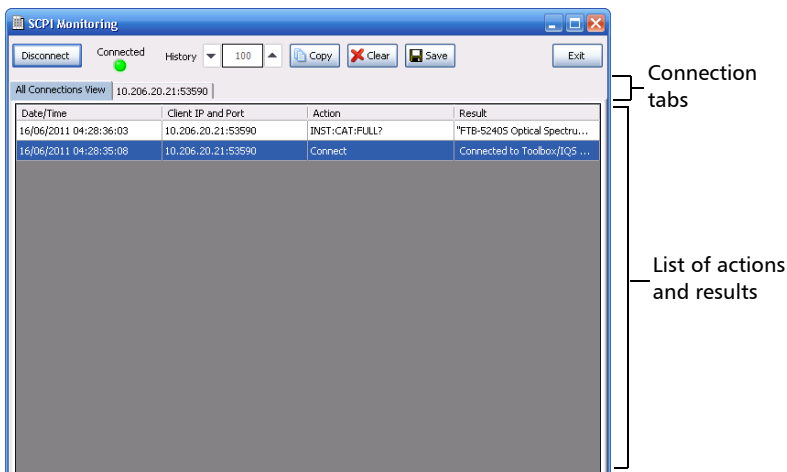

With the **History** parameter, you determine how many commands you want to keep in the list. You can increase or decrease the number by using the arrow buttons on each side of the list.

To clear the history, click **Clear**.

To view the list in any word processor, click **Copy** to copy it to the clipboard, and then paste it in your document. You can use any program, as the list is copied in text format.

To save the list as a file, click **Save**.

To exit the monitoring utility, click **Exit**.

For more information, refer to the user documentation about communication through TCP/IP over Telnet.

12 *Maintenance*

To help ensure long, trouble-free operation:

- Always inspect fiber-optic connectors before using them and clean them if necessary.
- Keep the unit free of dust.
- Clean the unit casing and front panel with a cloth slightly dampened with water.
- Store unit at room temperature in a clean and dry area. Keep the unit out of direct sunlight.
- Avoid high humidity or significant temperature fluctuations.
- Avoid unnecessary shocks and vibrations.
- If any liquids are spilled on or into the unit, turn off the power immediately, disconnect from any external power source, remove the batteries and let the unit dry completely.



WARNING

The use of controls, adjustments and procedures, namely for operation and maintenance, other than those specified herein may result in hazardous radiation exposure or impair the protection provided by this unit.

Cleaning Detector Ports

Regular cleaning of detectors will help maintain measurement accuracy.



IMPORTANT

Always cover detectors with protective caps when unit is not in use.

To clean detector ports:

1. Remove the protective cap and adapter (FOA) from the detector.
2. If the detector is dusty, blow dry with compressed air.
3. Being careful not to touch the soft end of the swab, moisten a cleaning tip with *only one drop* of isopropyl alcohol.



IMPORTANT

Alcohol may leave traces if used abundantly. Do not use bottles that distribute too much alcohol at a time.

4. While applying light pressure (to avoid breaking the detector window), gently rotate the cleaning tip on the detector window.
5. Repeat step 4 with a dry cleaning tip or blow dry with compressed air.
6. Discard the cleaning tips after one use.

Cleaning VFL-Type Connectors

VFL-type connectors are fixed on your unit and can be cleaned using a mechanical cleaner.



WARNING

Verifying the surface of the connector with a fiber-optic microscope **WHILE THE UNIT IS ACTIVE WILL result in permanent eye damage.**

To clean a connector using a mechanical cleaner:

- 1.** Insert the mechanical into the optical adapter, and push the outer shell into the cleaner.

Note: *The cleaner makes a clicking sound to indicate that the cleaning is done.*

- 2.** Verify connector surface with a portable fiber-optic microscope (for example, EXFO's FOMS) or fiber inspection probe (for example, EXFO's FIP).

Maintenance

Cleaning the Touchscreen

Cleaning the Touchscreen

Clean the touchscreen with a soft, non-abrasive cloth, such as one used for cleaning reading glasses, dampened with water.



CAUTION

Using anything else than water can damage the special coating used for units equipped with an outdoor-enhanced screen (S2 option).

When not using your unit, EXFO recommends using the screen protector that came with it.

Battery Maintenance Recommendations



IMPORTANT

Fully charge batteries before using the unit for the first time. New batteries are fully charged after approximately 4 hours or when the  LED stops flashing.

- To ensure that batteries function or charge properly, keep them in temperatures between 10 °C and 40 °C (50 °F and 104 °F). Store below 50 °C (122 °F).
- Leave the unit plugged in when not in use.
- Do not leave a battery discharged for several days.
- Remove the batteries if the unit will not be used for more than two weeks.
- After 300 cycles (approximately 18 months of use), replace the batteries with new ones to maintain optimal operation conditions. Otherwise, the operating time might be reduced.
- Li-Ion batteries that are not used for a long period of time (over three months) will not be damaged, but might need to be recalibrated.



WARNING

Do not throw batteries into fire or water and do not short-circuit the battery electrical contacts. Do not disassemble.

Inserting and Removing Batteries

The FTB-500 can be powered either by batteries or from an appropriate power outlet when used with the provided power supply.



CAUTION

Your unit uses smart lithium-ion (Li-Ion) batteries with built-in protection that have been especially designed for EXFO. For this reason, you can only replace them with batteries of the same type and model.

The use of other batteries may damage your unit and compromise your safety.

For more information on the available power sources for your unit, as well as their characteristics, see *Technical Specifications* on page 295.

Note: *Whenever batteries are inserted or removed, the FTB-500 will beep.*

Before you go out in the field, make sure you install batteries in the unit unless you have an adequate and reliable power source.



IMPORTANT

To avoid losing test data that you have not saved, make sure at least one battery is always present in the unit if it is not under alternating current (AC).



IMPORTANT

When changing batteries, make sure that the unit is off or that the AC power is connected.

To replace the batteries in the unit:

1. Place the FTB-500 with the screen facing down.

2. Open the battery compartment located on the back panel of the unit by undoing the retaining screw (two retaining screws on the eight-slot model), then pulling the battery compartment door away.

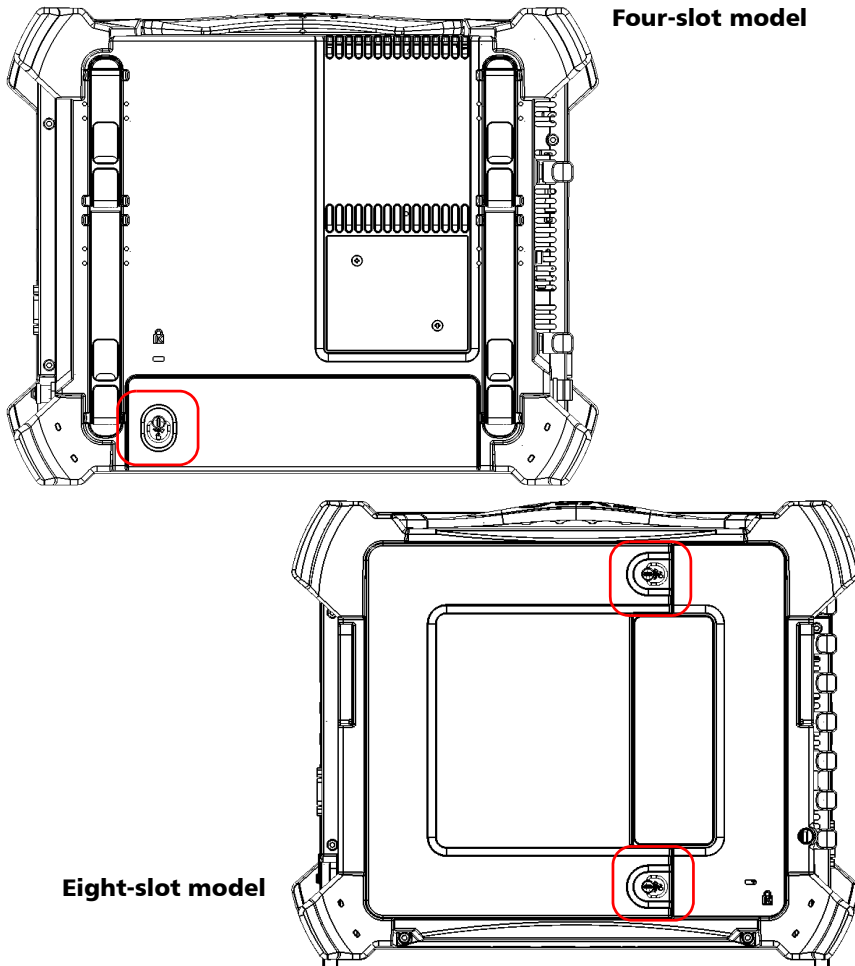

3. Pull out one of the batteries using the tab.

Maintenance

Verifying Battery Status

- Slide the new battery in, using the image below as a guide. It will not go in completely if inserted incorrectly.

Four-slot model



Eight-slot model

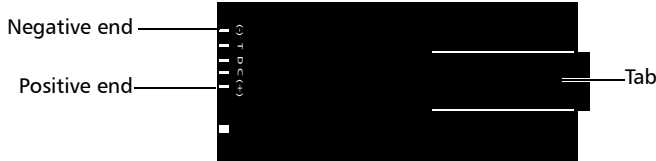

- Repeat steps 3 and 4 with the other battery (two remaining batteries for the eight-slot model).
- Close the battery compartment and tighten the retaining screw back into position (two retaining screws on the eight-slot model).

Verifying Battery Status

The battery gauge located at the bottom of your screen indicates how much power you have left.

If you are using the FTB-500's batteries, the gauge will show a battery icon.



If you are using alternating current (AC), the gauge will show an electric plug icon.



Tapping the icon will detail how much power is left for each battery in your unit. Should the batteries require a recalibration, you will be notified in the battery status window.

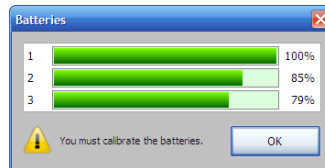

IMPORTANT

Your FTB-500 was set at the factory to warn you about low battery charge level (when it reaches about 10 %), and to shut down automatically when the batteries are at a very low charge level (less than 5 %).

However, if you are using modules that are more demanding energy-wise, your unit will shut down automatically before it reaches 5 %. The charge level that triggers the automatic shutdown depends on the power required by the modules.

If you are using such modules often, you can set your unit through the Windows Control Panel to increase the value at which you will be warned of the low battery level and when the unit will shut down automatically. For more information about power management in Windows, refer to the corresponding online documentation.

Recalibrating the Batteries

Depending on the way the unit is used, after a while, the charge status icon may no longer correspond to the actual power level of the batteries (for example, the battery LED is green and not blinking, which normally indicates that the batteries are fully charged, yet the battery gauge indicates that they are only charged at 85 % of their capacity). A complete calibration cycle will be necessary.

You can perform a recalibration with the battery calibration utility:

- The utility will charge the battery until it is full.
- It will then discharge the battery completely.
- You will have to let the battery recharge completely.

The whole calibration process can take several hours. You can stop the process at any time, but the battery will still need calibration and could be empty.

To recalibrate the batteries:

1. Select the **Tools** tab, then **Battery Calibration**.

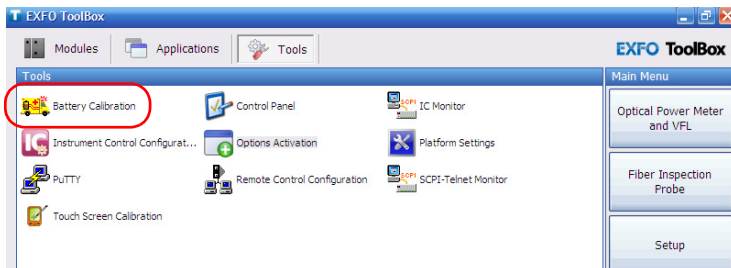

IMPORTANT

During the calibration process, the unit will turn off. Do not restart the platform while the battery LED indicator is cycling through its green-red-yellow sequence. This will cancel the calibration process.

2. Connect your unit to a power outlet using the provided AC adapter/charger or power supply.
3. Tap the **Start Calibration** button (the **Stop Calibration** button will become available).

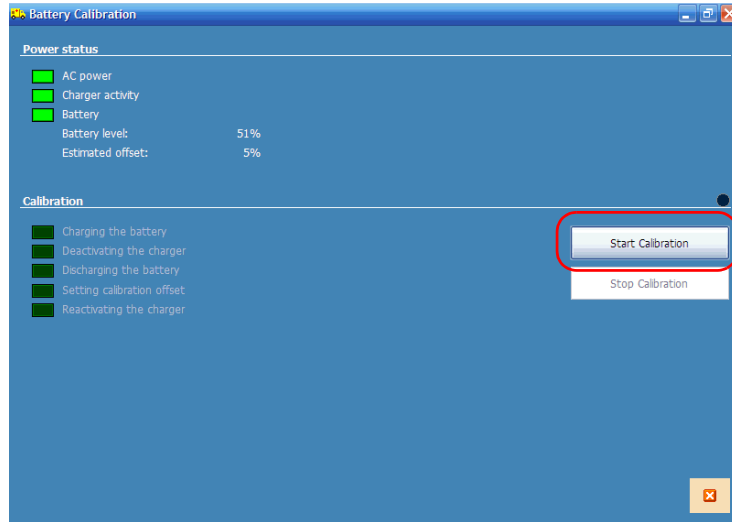

When a calibration step is underway, the on-screen LED preceding the step name appears in yellow. When a step is complete, the LED turns to green.

Once calibration is complete, the **Start Calibration** button becomes available again.

Enabling Automatic Windows Updates

You can configure your unit to automatically search and install Windows updates to ensure that you benefit from the latest versions of the Windows applications. Your unit will need an Internet access for the updates.

Only the applications from Microsoft will be updated with the automatic Windows update feature. If you want to update EXFO applications, see *Installing or Upgrading the Applications* on page 36. The third-party applications will need to be updated manually.



CAUTION

DO NOT update the SumatraPDF reader (see *Viewing PDF Files* on page 94). Otherwise, you will lose the custom version prepared by EXFO for your unit. The application may no longer function properly. If you updated the SumatraPDF reader by mistake, see *Solving Common Problems* on page 263.



IMPORTANT

Before enabling the automatic Windows updates, ensure that you install the most recent System Upgrade kit for your unit. To do this, you will need a standard USB memory key and a computer with an Internet access. You can also retrieve the kits directly from your unit, provided that you have an Internet access.

To enable the automatic updates for Windows applications:

1. From the main window, select the **Tools** tab.
2. Tap **Control Panel**.

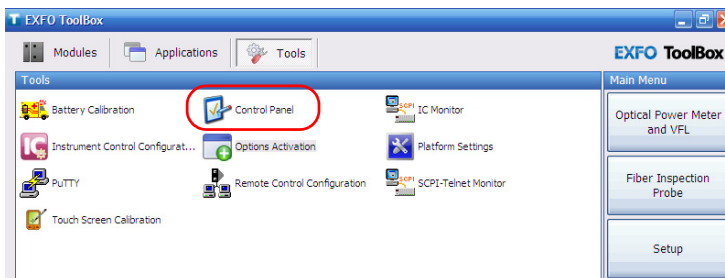

3. Tap **Automatic Updates**.

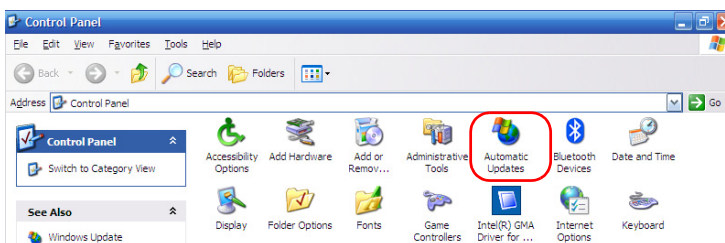

Maintenance

Enabling Automatic Windows Updates

4. Select the update option that better suits your need.

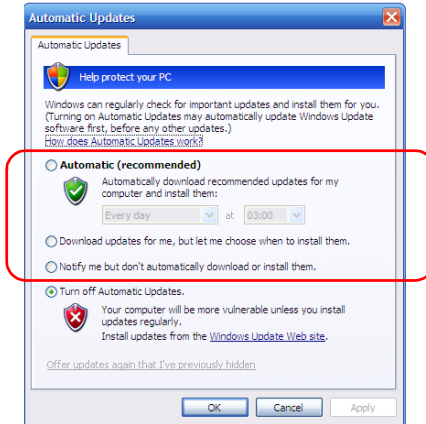

5. Tap **Apply** to confirm the changes, and then **OK** to return to the **Control Panel** window.

Replacing Fuses (Eight-Slot Model Only)

The unit contains two F6.3A L type fuses (5 mm x 20 mm (0.197 in x 0.787 in), fast-acting, low-breaking capacity, 250 V). The fuse holder is located on the left panel of the unit, just below the power inlet.



WARNING

Both neutral and live wires are energized. If a fuse is blown, make sure that no part of the unit remain energized when changing it.

To replace a fuse:

1. Turn off the unit and unplug the power cord.
2. Using a flat-head screwdriver as a lever, pull the fuse holder out of the unit.

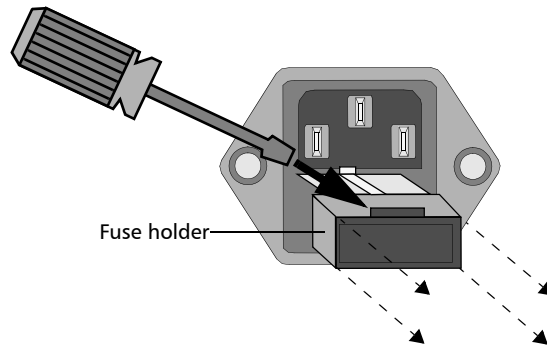

3. Check and replace the fuses, if necessary.
4. Insert the new fuse into the fuse holder.

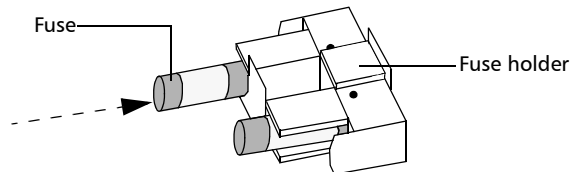

Maintenance

Recalibrating the Unit

5. Make sure the fuses are placed firmly in the holder prior to reinsertion.
6. Firmly push the fuse holder into place.

Recalibrating the Unit

EXFO manufacturing and service center calibrations are based on the ISO/IEC 17025 standard (*General Requirements for the Competence of Testing and Calibration Laboratories*). This standard states that calibration documents must not contain a calibration interval and that the user is responsible for determining the re-calibration date according to the actual use of the instrument.

The validity of specifications depends on operating conditions. For example, the calibration validity period can be longer or shorter depending on the intensity of use, environmental conditions and unit maintenance, as well as the specific requirements for your application. All of these elements must be taken into consideration when determining the appropriate calibration interval of this particular EXFO unit.

Under normal use, the recommended interval for your FTB-500 is: one year.

For newly delivered units, EXFO has determined that the storage of this product for up to six months between calibration and shipment does not affect its performance (EXFO Policy PL-03).

To help you with calibration follow-up, EXFO provides a special calibration label that complies with the ISO/IEC 17025 standard and indicates the unit calibration date and provides space to indicate the due date. Unless you have already established a specific calibration interval based on your own empirical data and requirements, EXFO would recommend that the next calibration date be established according to the following equation:

Next calibration date = Date of first usage (if less than six months after the calibration date) + Recommended calibration period (one year)

To ensure that your unit conforms to the published specifications, calibration may be carried out at an EXFO service center or, depending on the product, at one of EXFO's certified service centers. Calibrations at EXFO are performed using standards traceable to national metrology institutes.

Note: *You may have purchased a FlexCare plan that covers calibrations. See the Service and Repairs section of this user documentation for more information on how to contact the service centers and to see if your plan qualifies.*

Recycling and Disposal (Applies to European Union Only)

For complete recycling/disposal information as per European Directive WEEE 2012/19/UE, visit the EXFO Web site at www.exfo.com/recycle.

13 Troubleshooting

Solving Common Problems

Before calling EXFO's technical support, you may want to consider the following solutions to problems that could occur.

Problem	Possible Cause	Solution
My FTB-500 does not start.	<ul style="list-style-type: none">➤ It is not connected to a power source.➤ Batteries are completely discharged.➤ Windows startup files have been corrupted.➤ The system has encountered a problem.	<ul style="list-style-type: none">➤ Ensure that the power cord or power supply is connected to both the FTB-500 and the power inlet.➤ Change or recharge the batteries.➤ Contact EXFO.➤ Press the On/Off button for ten seconds to reboot the system.
The screen remains black even if the FTB-500 is turned on.	The display parameters are not correctly set.	<ul style="list-style-type: none">➤ If no external monitor is connected, press the backlight level button.➤ If an external monitor is connected, verify the brightness settings in ToolBox.
My FTB-500 is not responding.	The system has encountered a problem.	Press the On/Off button for fifteen seconds to reboot the system.

Troubleshooting

Solving Common Problems

Problem	Possible Cause	Solution
The USB device I have just installed is not working.	<ul style="list-style-type: none">➤ There might have been a problem during installation.➤ You do not have the proper driver for this device.	<ul style="list-style-type: none">➤ Disconnect, then reconnect the device.➤ Turn off the FTB-500, then turn it on again.➤ Ensure that you have the right driver (can be provided with the device itself).
The FTB-500 does not recognize a test module.	<ul style="list-style-type: none">➤ Module application is not installed.➤ Defective module.	<ul style="list-style-type: none">➤ Install the corresponding application using the Update Manager application.➤ If the FTB-500 recognizes other modules, the faulty module could be defective. Return it to EXFO for repairs.
Express cards are not recognized at insertion.	You might not have the latest Express card driver.	Install the most recent Express card driver available for your card.

Problem	Possible Cause	Solution
The 3G USB modem key is connected, but you are not able to access the Internet.	➤ There is no SIM card in the USB modem key.	Insert the SIM card into the USB modem key. For complete instructions, refer to the documentation that came with your modem key.
	➤ The FTB-500 unit is not up to date.	Ensure that the latest System Upgrade and Platform kits are installed on your unit before connecting your USB modem key. For more information, see <i>Accessing the Internet with a 3G USB Modem Key</i> on page 97.
	➤ The USB modem key is not detected properly.	Disconnect the modem key from your unit, and try connecting it again. If the modem key is still not detected, try connecting it to another USB port.
	➤ The SIM card has not been activated or there is a problem with service package that you purchased. ➤ There is a problem with the mobile network.	Contact your provider of mobile services.

Troubleshooting

Solving Common Problems

Problem	Possible Cause	Solution
<p>(...continued) The 3G USB modem key is connected, but you are not able to access the Internet.</p>	<p>➤ A problem occurred during the installation of the AirCard Watcher application.</p>	<ul style="list-style-type: none">➤ From ToolBox, select the Tools tab, then tap Control Panel.➤ Tap System, and then select the Hardware tab.➤ Tap the Device Manager button.➤ If the 3G USB modem key appears as an “Unknown Device”, remove the Sierra AirCard Watcher application with Add/Remove Programs, and then restart your unit.➤ Return to the Device Manager.➤ Select the USB modem key from the list of devices.➤ From the Action menu, select Update Driver and let Windows search for the driver. <p>Once the installation is complete, the USB modem key should be working properly.</p>

Problem	Possible Cause	Solution
<p>The GPS USB key is not detected.</p>	---	<p>Disconnect the GPS key from your unit, and try connecting it again.</p> <p>If the GPS key is still not detected, try connecting it to another USB port.</p>
<p>The SumatraPDF reader has been updated by mistake.</p> <p>OR</p> <p>The language that you have selected for the SumatraPDF reader is no longer available.</p> <p>OR</p> <p>The SumatraPDF reader is no longer working properly.</p>	---	<p>Restore your unit. To do so, see <i>Restoring Your Unit to Normal Operation</i> on page 272.</p>
<p>Batteries are not recharging.</p>	<ul style="list-style-type: none"> ➤ Ambient temperature is too high or too low. ➤ The AC adapter is not connected properly. 	<ul style="list-style-type: none"> ➤ Make sure that the temperature in the location where you recharge the batteries is within the specifications ➤ Make sure that the AC power cord is connected to the unit and the wall inlet.

Troubleshooting

Solving Common Problems

Problem	Possible Cause	Solution
Battery indicator shows only a fraction of the power is left, but the batteries are fully charged. (You are able to operate your unit, but the software automatically blocks when it reaches its set power threshold).	Battery needs to be recalibrated or changed.	<ul style="list-style-type: none">➤ Use the battery calibration process explained in Equation on page 254.➤ Change the batteries.
When I start the probe application, an error message warns me that the probe application is not installed on my unit.	The fiber inspection probe application is no longer installed on FTB-500 units by default.	Install the fiber inspection probe application (ConnectorMax) using Update Manager. For more information on how to install products, refer to the Update Manager online help. For more information on how to use the ConnectorMax application, refer to the corresponding online help.
When I start the probe application (ConnectorMax), the probe is no longer detected. OR No image is displayed in the probe application.	There may be a problem with the probe's driver.	Install the latest System Upgrade kit on your unit, then try again.

Problem	Possible Cause	Solution
My module does not seem to fit all the way inside the platform and I cannot lock it in place using the retaining screw.	You are using an older module with a rubber O ring directly behind the faceplate.	Remove the O ring simply by pulling it away from the module. The O ring will be permanently removed, but this does not affect the way your module will perform. Your module also remains fully functional on the other EXFO platforms

LED Indicator Color Codes

The LED indicators can convey different message depending on their colors and state.

LED	Color and Status	Message
Power	<ul style="list-style-type: none">▶ Green▶ Green, blinking	<ul style="list-style-type: none">▶ Unit on.▶ Unit in Standby mode.
Battery (external power connected)	<ul style="list-style-type: none">▶ Green▶ Green, blinking▶ Yellow, blinking	<ul style="list-style-type: none">▶ Fully charged▶ Charging <p>▶ Module using or could be using more power than what is available from batteries. Do not disconnect AC power while this module is in use.</p> <p>A blinking yellow LED takes precedence over a blinking green one, so when AC power is connected, even if the LED is blinking yellow, batteries are probably charging (depending on conditions).</p>

LED	Color and Status	Message
Battery (external power not connected)	<ul style="list-style-type: none"> ➤ Not lit ➤ Yellow ➤ Yellow, blinking ➤ Red 	<ul style="list-style-type: none"> ➤ Above LOW charge level ➤ LOW charge level ➤ Module and platform could be using more power than what is available from the batteries at any time. Connect AC power as soon as possible. ➤ Battery error
Laser	<ul style="list-style-type: none"> ➤ Red, blinking 	<ul style="list-style-type: none"> ➤ One or more laser sources are on.
Alarm	Varied	<ul style="list-style-type: none"> ➤ Each application using the Alarm LED provides its alarm level to the platform when needed (Red/Yellow/Green/OFF). ➤ If more than one application uses the alarm LED, the LED is displayed using the color of the most severe alarm with red as the most severe, followed by yellow and finally green. ➤ If more than one application uses the alarm LED, the LED is blinking.
Remote Control	Green	<ul style="list-style-type: none"> ➤ Unit is controlled remotely.

Restoring Your Unit to Normal Operation

Your FTB-500 is set to start using the standard Windows startup sequence. However, you can also use the emergency system tools feature if you need to:

- check the disk integrity
- back up some files directly onto a USB storage device for recovery purposes
- revert your unit to its initial state (as it was when you purchased it) or restore it with a specific Windows image (WIM) that could have been provided to you by EXFO customer service, for example.



CAUTION

- Before starting the recovery operation, connect your unit to a power outlet using the provided AC adapter/charger.
- **DO NOT TURN OFF** your unit while the recovery operation is underway. Doing so may severely damage your unit. Damaged units will need to be sent back to EXFO for repair.



IMPORTANT

Restoring the system partition will format the unit's C drive and replace what is currently installed on your unit with the image you choose. This operation cannot be undone or stopped once it is started.

If you have installed other products that are not included in your image file, you will have to reinstall them afterwards.



To avoid losing the data that is stored on the D drive, you may want to back it up before restoring the system partition. Otherwise, all your files will be lost.

Note: *You may find useful to connect a keyboard and a mouse to your unit before using the emergency system tools.*

Troubleshooting

Restoring Your Unit to Normal Operation

To restore the system partition:

1. Turn on the FTB-500.
2. While the system is displaying the boot menu (3 seconds), press .
OR
Press any key on the keyboard (if you have connected one).
3. Press  to select the emergency system tools operation mode, then LOCAL to confirm your choice.

Note: *The touchscreen becomes effective at this point.*

- From the main window, select **Restore system partition from an image**, then tap **Next**.

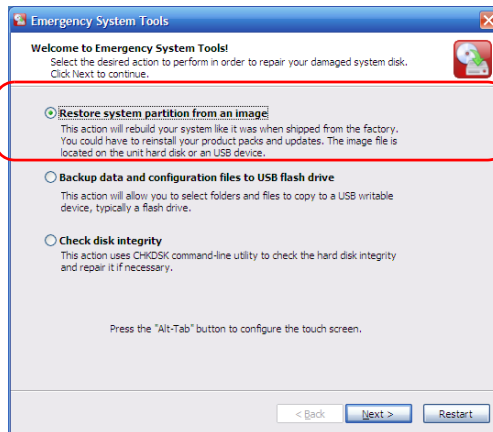

- Select which image (.wim file) you want to use. An image file is available on the E drive. However, you can use an image file that you have on a USB storage device. Use the **Browse** button to locate the image file that you want to use.

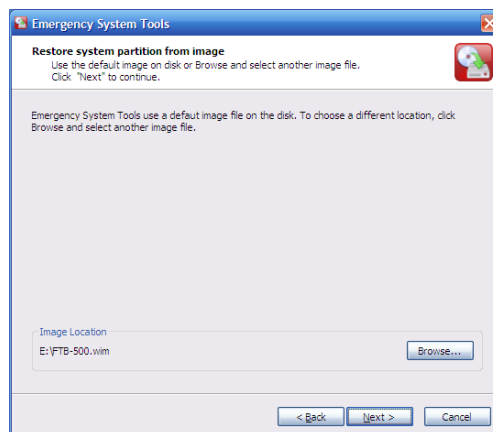

Troubleshooting

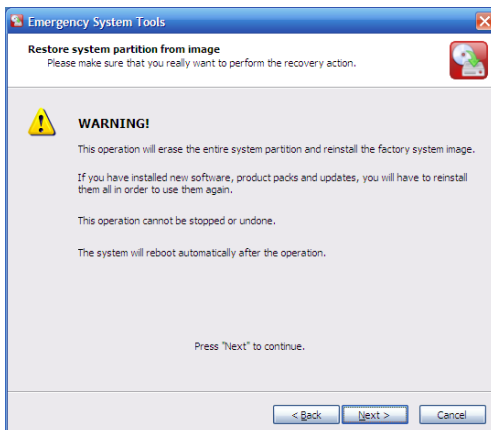

Restoring Your Unit to Normal Operation

6. Tap **Next** to proceed to the next step.



7. Tap **Next** to start the restoration process. The unit will restart upon completion of the process.

To retrieve data from the D drive:

1. Turn on the FTB-500.
2. While the system is displaying the boot menu (3 seconds), press .
OR
Press any key on the keyboard (if you have connected one).
3. Press  to select the emergency system tools operation mode, then LOCAL to confirm your choice.

Note: *The touchscreen becomes effective at this point.*

4. From the main window, select **Backup data and configuration files to USB flash drive**, then tap **Next**.

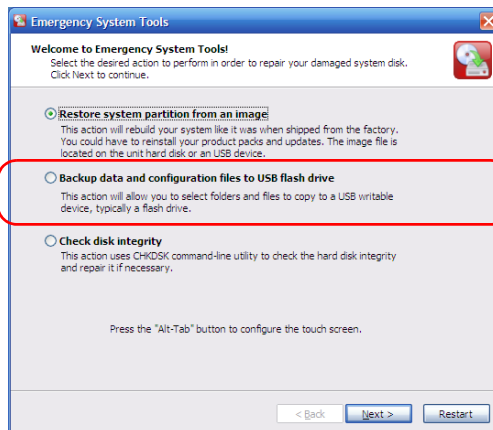

Troubleshooting

Restoring Your Unit to Normal Operation

5. Select the files to back up.

A green check mark indicates a selection of the entire folder (subfolders and files). A shaded check box indicates that not all of the files of subfolders are selected.

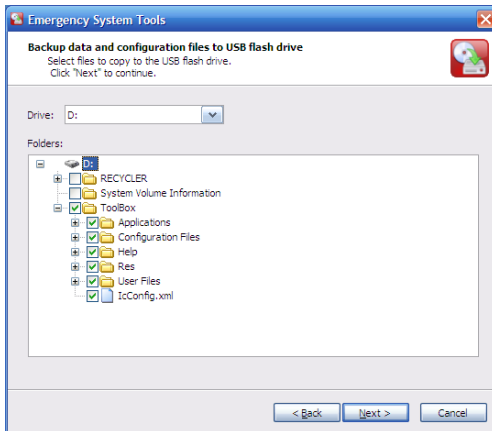

6. If the USB device you want to use is not connected to the unit, connect it now so that the system can find it. Tap **Next**.

7. Select the USB device onto which you want to save the data from the list of available devices.

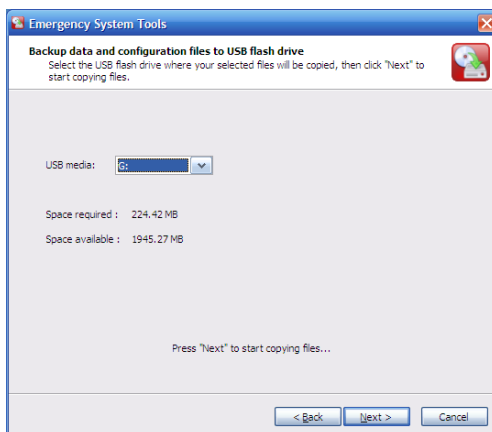

Note: *If you have forgotten to connect the USB device at this point and that it does not show up in the list, tap **Back**, connect the device, then tap **Next** to return to this window.*

8. Tap **Next** to start the file copy process.



A progress bar indicates which files are being copied. If you tap **Cancel** while the transfer is in progress, any file that was copied onto the USB device will still be on the USB device.

9. Once the transfer is complete, tap **Cancel** to return to the main window.

Troubleshooting

Restoring Your Unit to Normal Operation

To verify disk integrity:

1. Turn on the FTB-500.
2. While the system is displaying the boot menu (3 seconds), press .
OR
Press any key on the keyboard (if you have connected one).
3. Press  to select the emergency system tools operation mode, then LOCAL to confirm your choice.

Note: *The touchscreen becomes effective at this point.*

4. From the main window, select **Check disk integrity**, then tap **Next**.

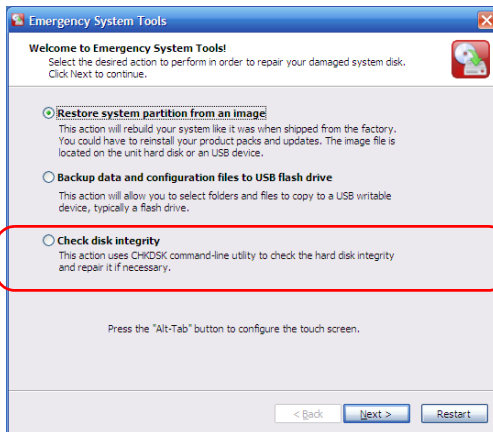

5. Tap Next to start the disk analysis.

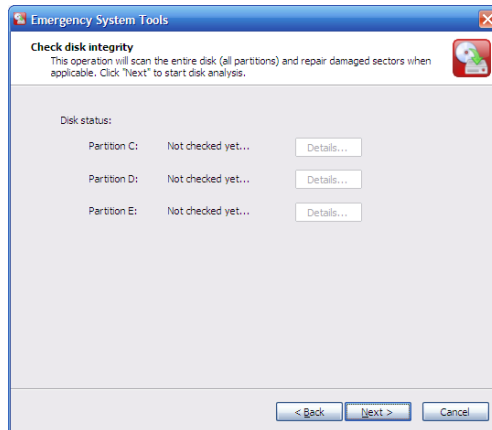

Once the analysis is complete, you can view a report on each drive by tapping **Details**.

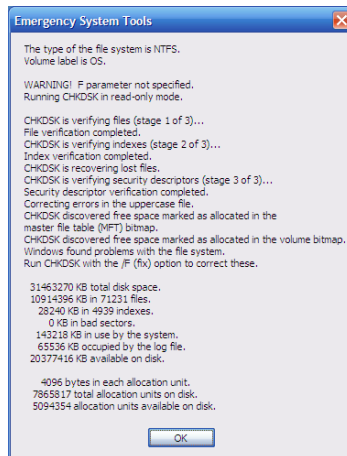

6. Tap OK once you have finished.

7. To exit the integrity analysis tool, tap Cancel to return to the main window.

Accessing Online Help

You can either access the online help for the platform itself, or obtain more information about the modules currently in the unit. Each module also has its own online help accessed independently.

Accessing the Platform Online Help

The platform online help is conveniently available from the Main Menu.

To open the online help file:

From the **Main Menu**, tap **Help**.

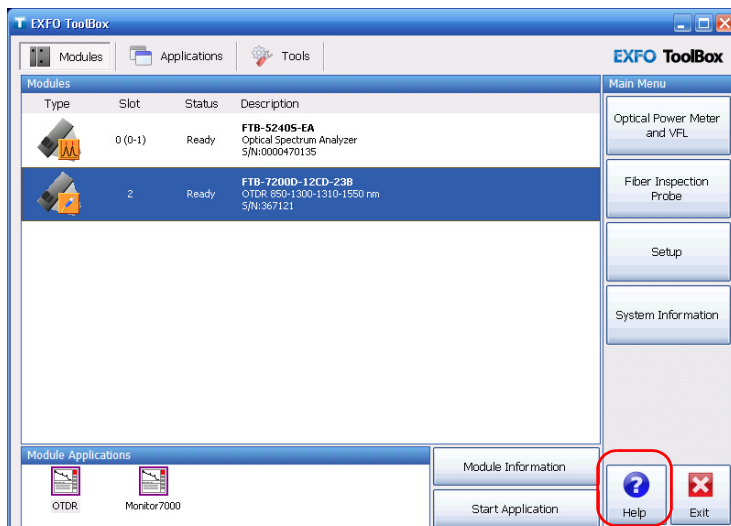

Viewing Information about the Modules

You can obtain more information on the modules that are currently inserted in your unit.

For information on how to start an application, see *Starting Module Applications* on page 40.

To use the Module Information feature:

1. From the **Modules** tab, select the module for which you want more information. The corresponding **Module Applications** section will appear.

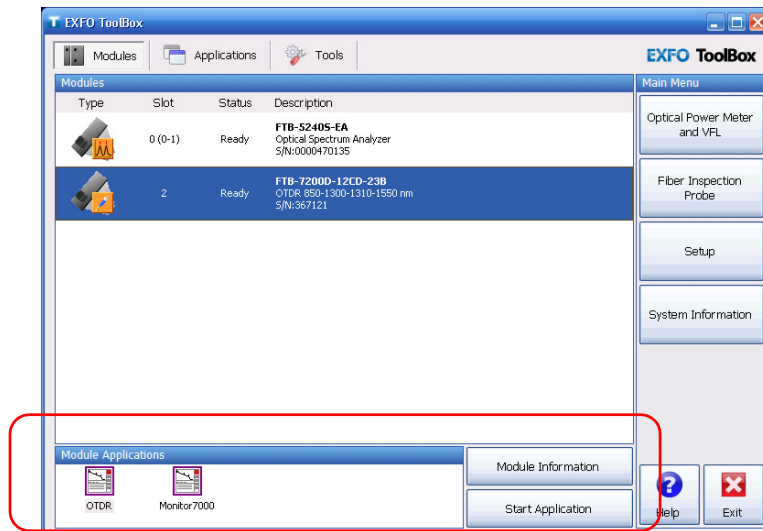

2. Tap **Module Information**.

A pop-up window containing more information on the module appears.

3. When you have finished reading the information, simply close the window.

Troubleshooting

Contacting the Technical Support Group

Contacting the Technical Support Group

To obtain after-sales service or technical support for this product, contact EXFO at one of the following numbers. The Technical Support Group is available to take your calls from Monday to Friday, 8:00 a.m. to 7:00 p.m. (Eastern Time in North America).

Technical Support Group

400 Godin Avenue
Quebec (Quebec) G1M 2K2
CANADA

1 866 683-0155 (USA and Canada)
Tel.: 1 418 683-5498
Fax: 1 418 683-9224
support@exfo.com

For detailed information about technical support, and for a list of other worldwide locations, visit the EXFO Web site at www.exfo.com.

If you have comments or suggestions about this user documentation, you can send them to customer.feedback.manual@exfo.com.

To accelerate the process, please have information such as the name and the serial number (see the product identification label), as well as a description of your problem, close at hand.

Viewing System Information

The **System Information** function tab contains important information on your unit. Should you need to contact the technical support group, this is the location where you can find information they may require to help you, such as version numbers for kits and components.

Consulting the About Tab

The **About** tab contains information on how to contact EXFO should you need to do so.

To access the About tab:

1. Tap the **System Information** function tab.

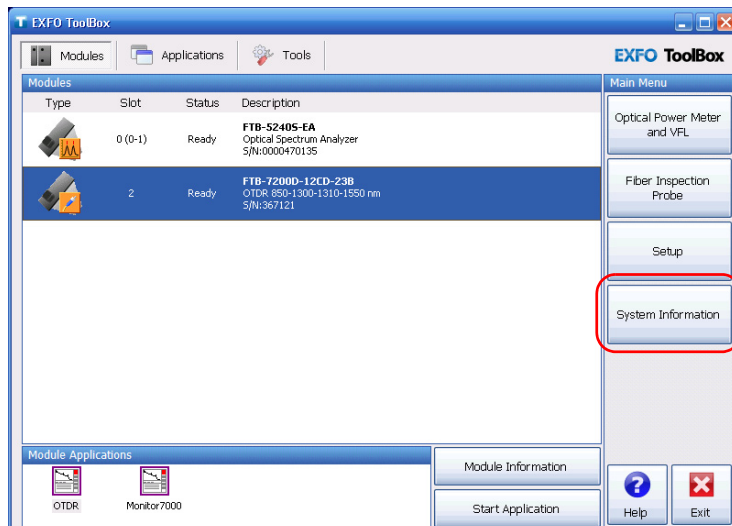

Troubleshooting

Viewing System Information

2. Select the **About** tab to view information on your unit.



Viewing Platform-Related Information

You might need information specific to the platform, such as component versions, when calling EXFO's technical support team.

To access the Platform tab:

1. Tap the **System Information** function tab.

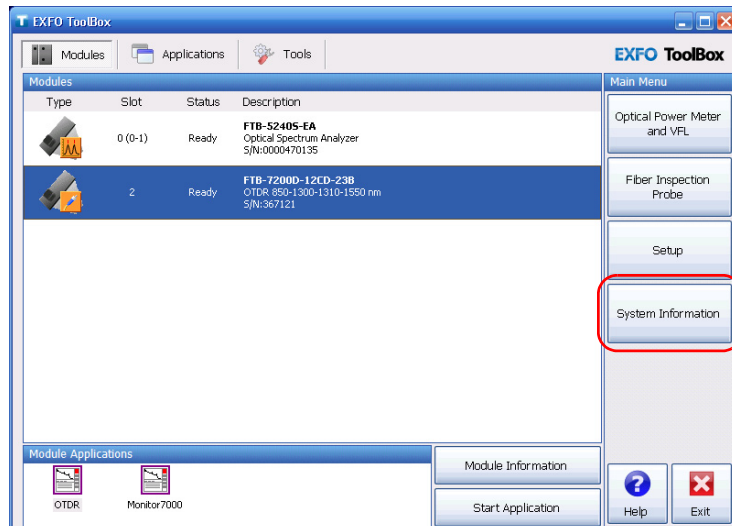

2. Select the **Platform** tab.

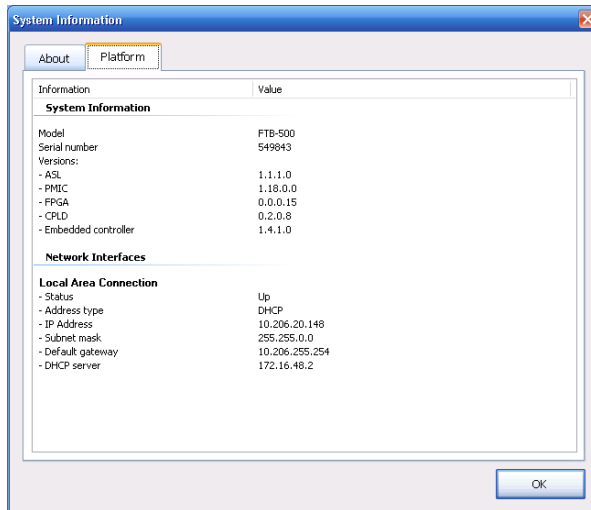

Transportation

Maintain a temperature range within specifications when transporting the unit. Transportation damage can occur from improper handling. The following steps are recommended to minimize the possibility of damage:

- Pack the unit in its original packing material when shipping.
- Avoid high humidity or large temperature fluctuations.
- Keep the unit out of direct sunlight.
- Avoid unnecessary shocks and vibrations.

14 Warranty

General Information

EXFO Inc. (EXFO) warrants this equipment against defects in material and workmanship for a period of one year from the date of original shipment. EXFO also warrants that this equipment will meet applicable specifications under normal use.

During the warranty period, EXFO will, at its discretion, repair, replace, or issue credit for any defective product, as well as verify and adjust the product free of charge should the equipment need to be repaired or if the original calibration is erroneous. If the equipment is sent back for verification of calibration during the warranty period and found to meet all published specifications, EXFO will charge standard calibration fees.



IMPORTANT

The warranty can become null and void if:

- unit has been tampered with, repaired, or worked upon by unauthorized individuals or non-EXFO personnel.
- warranty sticker has been removed.
- case screws, other than those specified in this guide, have been removed.
- case has been opened, other than as explained in this guide.
- unit serial number has been altered, erased, or removed.
- unit has been misused, neglected, or damaged by accident.

THIS WARRANTY IS IN LIEU OF ALL OTHER WARRANTIES EXPRESSED, IMPLIED, OR STATUTORY, INCLUDING, BUT NOT LIMITED TO, THE IMPLIED WARRANTIES OF MERCHANTABILITY AND FITNESS FOR A PARTICULAR PURPOSE. IN NO EVENT SHALL EXFO BE LIABLE FOR SPECIAL, INCIDENTAL, OR CONSEQUENTIAL DAMAGES.

Warranty

Liability

Liability

EXFO shall not be liable for damages resulting from the use of the product, nor shall be responsible for any failure in the performance of other items to which the product is connected or the operation of any system of which the product may be a part.

EXFO shall not be liable for damages resulting from improper usage or unauthorized modification of the product, its accompanying accessories and software.

Exclusions

EXFO reserves the right to make changes in the design or construction of any of its products at any time without incurring obligation to make any changes whatsoever on units purchased. Accessories, including but not limited to fuses, pilot lamps, batteries and universal interfaces (EUI) used with EXFO products are not covered by this warranty.

This warranty excludes failure resulting from: improper use or installation, normal wear and tear, accident, abuse, neglect, fire, water, lightning or other acts of nature, causes external to the product or other factors beyond the control of EXFO.



IMPORTANT

In the case of products equipped with optical connectors, EXFO will charge a fee for replacing connectors that were damaged due to misuse or bad cleaning.

Certification

EXFO certifies that this equipment met its published specifications at the time of shipment from the factory.

Service and Repairs

EXFO commits to providing product service and repair for five years following the date of purchase.

To send any equipment for service or repair:

1. Call one of EXFO's authorized service centers (see *EXFO Service Centers Worldwide* on page 293). Support personnel will determine if the equipment requires service, repair, or calibration.
2. If equipment must be returned to EXFO or an authorized service center, support personnel will issue a Return Merchandise Authorization (RMA) number and provide an address for return.
3. If possible, back up your data before sending the unit for repair.
4. Pack the equipment in its original shipping material. Be sure to include a statement or report fully detailing the defect and the conditions under which it was observed.
5. Return the equipment, prepaid, to the address given to you by support personnel. Be sure to write the RMA number on the shipping slip. *EXFO will refuse and return any package that does not bear an RMA number.*

Note: *A test setup fee will apply to any returned unit that, after test, is found to meet the applicable specifications.*

After repair, the equipment will be returned with a repair report. If the equipment is not under warranty, you will be invoiced for the cost appearing on this report. EXFO will pay return-to-customer shipping costs for equipment under warranty. Shipping insurance is at your expense.

Routine recalibration is not included in any of the warranty plans. Since calibrations/verifications are not covered by the basic or extended warranties, you may elect to purchase FlexCare Calibration/Verification Packages for a definite period of time. Contact an authorized service center (see *EXFO Service Centers Worldwide* on page 293).

EXFO Service Centers Worldwide

If your product requires servicing, contact your nearest authorized service center.

EXFO Headquarters Service Center

400 Godin Avenue
Quebec (Quebec) G1M 2K2
CANADA

1 866 683-0155 (USA and Canada)
Tel.: 1 418 683-5498
Fax: 1 418 683-9224
support@exfo.com

EXFO Europe Service Center

Winchester House, School Lane
Chandlers Ford, Hampshire S053 4DG
ENGLAND

Tel.: +44 2380 246800
Fax: +44 2380 246801
support.europe@exfo.com

EXFO Telecom Equipment (Shenzhen) Ltd.

3rd Floor, Building 10,
Yu Sheng Industrial Park (Gu Shu
Crossing), No. 467,
National Highway 107,
Xixiang, Bao An District,
Shenzhen, China, 518126

Tel: +86 (755) 2955 3100
Fax: +86 (755) 2955 3101
support.asia@exfo.com

A *Technical Specifications*



IMPORTANT

The following technical specifications can change without notice. The information presented in this section is provided as a reference only. To obtain this product's most recent technical specifications, visit the EXFO Web site at www.exfo.com.

SPECIFICATIONS^a

Central processing unit (CPU)	Intel Core 2 Duo
Display	Touchscreen, color TFT, 800 x 600 TFT, 307 mm (12.1 in)
Interfaces	Ethernet port Fiber probe port ExpressCard port 34 mm format Serial RS-232 port Monitor port Four USB 2.0 ports Standard PC Mic in and Speaker out ports (3.5 mm)
Storage	Internal 80 GB hard drive minimum with G-shock protection Flash USB drive (1 GB, 2 GB and 8 GB optional) ExpressCard memory card (16 GB and up, optional) External USB read/write DVD drive (optional)
Batteries ^b	Eight-slot configuration: three rechargeable Li-ion, smart batteries (total of 207 W•h) Four-slot configuration: two rechargeable Li-ion, smart batteries (total of 138 W•h)
Power supply	100–240 VAC, 50/60 Hz

GENERAL SPECIFICATIONS

Temperature operating storage ^c	0 °C to 50 °C (32 °F to 122 °F) –40 °C to 70 °C (–40 °F to 158°F)
Relative humidity	0 % to 95 % (non-condensing)
Size (H x W x D)	Eight-slot configuration: 366 mm x 296 mm x 216 mm (11 11/16 in x 14 7/16 in x 8 1/2 in) Four-slot configuration: 366 mm x 296 mm x 146 mm (11 11/16 in x 14 7/16 in x 5 3/4 in)
Weight ^d	Eight-slot configuration: 10.9 kg (24 lb) Four-slot configuration: 8.5 kg (18.7 lb)

CE compliance, CSA, EU WEEE, China RoHS

ACCESSORIES

GP-10-047B	Semi-rigid carrying case with wheels and handle (four-slot platform)	GP-2091	USB keyboard (USB port)
GP-10-056B	Semi-rigid carrying case with wheels and handle (eight-slot platform)	GP-2092	USB memory stick (8 GB)
GP-10-075	Universal hard carrying case (eight-slot platform)	GP-2093	ExpressCard Wi-Fi
GP-10-078	Universal hard carrying case (four-slot platform)	GP-2095	Headset
GP-302	USB mouse	GP-2096	USB A-A for master-to-master communication
GP-2016	RJ-45 LAN cable (10 ft)	GP-2100	DVD ±R writable 8x external USB 2.0
GP-2028	Computer security cable kit	GP-2101	Cable RS232 straight F-M
GP-2086	Bluetooth USB Adapter	GP-2112	3G Universal USB Dongle
GP-2090	Extra Li-ion smart battery	GP-2113	GPS USB Dongle

Technical Specifications

PM-500 BUILT-IN POWER METER SPECIFICATIONS (OPTIONAL) ^a

Calibrated wavelengths (nm)	850, 1300, 1310, 1490, 1550, 1625, 1650
Power range (dBm)	10 to -86
Uncertainty (%) ^a	±5 % ± 3 pW (up to 5 dBm)
Display resolution (dB)	0.01 = max to -76 dBm 0.1 = -76 dBm to -86 dBm
Automatic offset nulling range ^f	Max power to -63 dBm
Tone detection (Hz)	270/1000/2000

Notes

- All specifications valid at 23 °C (73 °F).
- Standard recharge time is 4 h. Recharge temperature: 0 °C to 45 °C (32 °F to 113 °F).
- Not including internal batteries. Battery storage temperatures: -20 °C to 60 °C (-4 °F to 140 °F) for shipping, and -20 °C to 45 °C (-4 °F to 113 °F) for long-term storage.
- Platform with batteries (three for the eight-slot configuration, and two for the four-slot configuration) and without modules.
- At 23 °C ± 1 °C, at 1550 nm and with an FC connector. With modules in idle mode. Battery-operated.
- For ±0.05 dB, from 18 °C to 28 °C.

VISUAL FAULT LOCATOR (VFL) (OPTIONAL)

Laser, 650 nm ± 10 nm

CW

Typical P_{out} in 62.5/125 μm: 2 dBm (1.6 mW)

B Data Types

The following section provides an overview of the most common data types that may appear in EXFO's documentation on commands and queries. The information is supplied for guidance only.

For more detailed information, please refer to IEEE 488.2 and SCPI standards.

Data types are divided into two groups: <PROGRAM DATA> for the types that are used when you want to send messages to a device and <RESPONSE DATA> for the types that are used when a device sends responses to the controller.

The data types are presented in graphics often referred to as "railroad diagrams". The following example illustrates how to interpret such diagrams.

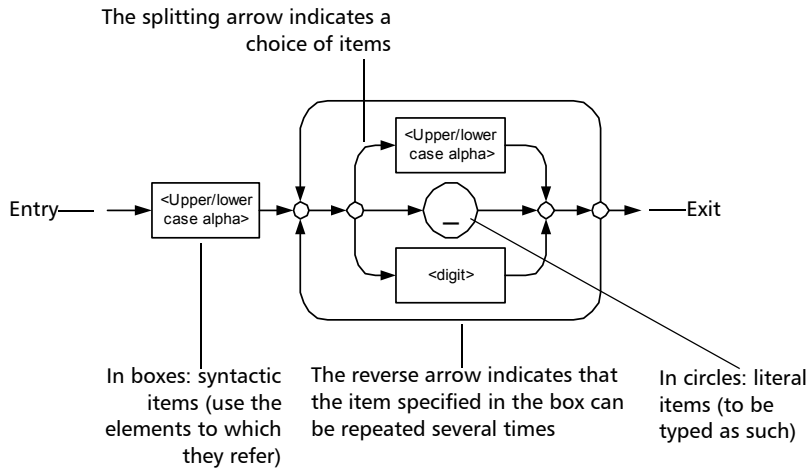

Data Types

Applicable Data Types for Input—IEEE 488.2

Applicable Data Types for Input—IEEE 488.2

- <PROGRAM MESSAGE TERMINATOR>

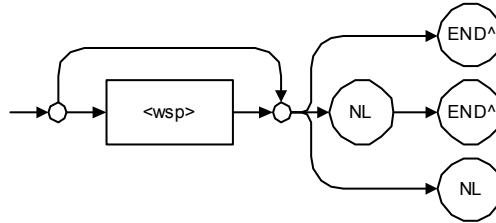

In the diagram above,

- “NL” corresponds to ASCII character code 10, in decimal (0A in binary)
- “END ^” corresponds to the last data byte of the message sent with EOI = True and ATN = False

Data Types

Applicable Data Types for Input—IEEE 488.2

➤ <NON-DECIMAL NUMERIC PROGRAM DATA>

This data type will be used for integer representation in hexadecimal (base 16), octal (base 8) or binary (base 2). The numeric representations will begin with “#H” for hexadecimal, “#Q” for octal and “#B” for binary.

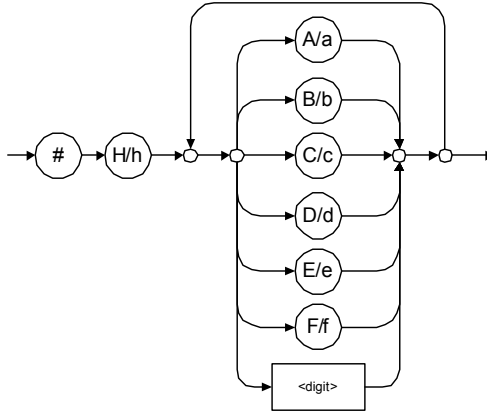

Examples: #Hf3bc015d, #h01a4, #hfe

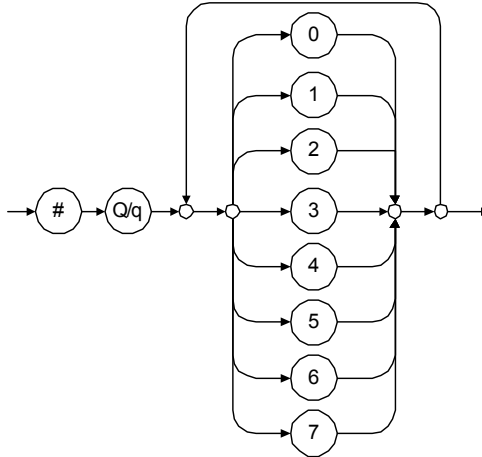

Examples: #Q1234567, #q1275, #q07

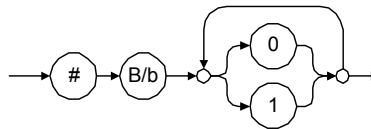

Examples: #B10010111, #b10110, #b1100

Data Types

Applicable Data Types for Input—IEEE 488.2

➤ <STRING PROGRAM DATA>

This data type will be used for strings containing 7-bit ASCII characters that have to be enclosed in either single- or double-quotes delimiters.

If a string needs to contain a character that is exactly the same as the delimiter, make sure to double the character to avoid syntax errors.

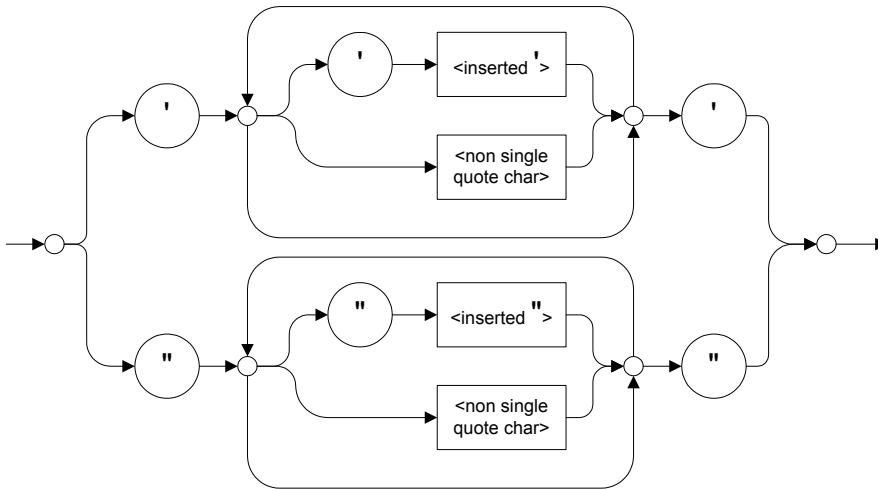

Examples: "SCPI Commands", 'SCPI Commands', "SCPI 'Commands'",
'SCPI "Commands"', "SCPI ""Commands""", 'SCPI ""Commands""'

➤ <ARBITRARY BLOCK PROGRAM DATA>

This data type is used to send blocks of arbitrary 8-bit information when you need to work with large amounts of data.

The actual length of the data that you send has the following structure:

- The first byte contains the # character.
- The byte that immediately follows contains the number of subsequent bytes that you have to check to obtain the total length.

Note: *If you use a zero as the first digit (#0), it has to be followed by a <PROGRAM MESSAGE TERMINATOR > so that the device will detect the end of the <ARBITRARY BLOCK PROGRAM DATA>. This will also force immediate termination of the message.*

For example, if you send the following data (here, values are expressed in decimal instead of binary for easier readability):

2 1 3 7 6 8 9 2 ...

The byte that immediately follows the # contains 2, which means that you would have to read the two following bytes to know the length (in bytes) of the retrieved data. The bytes indicate 1 and 3. The length will then be 13 bytes. The actual response will begin at byte number 5, in this case.

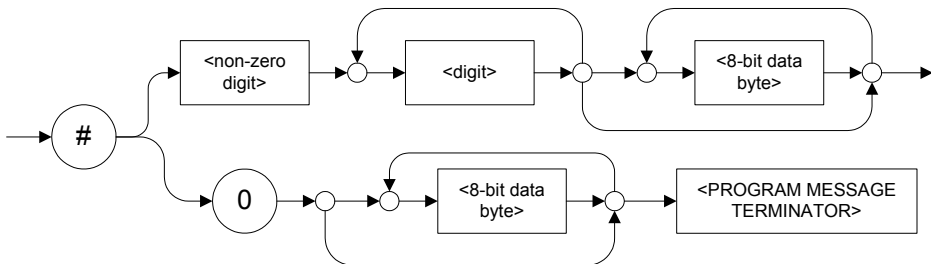

Data Types

Applicable Data Types for Input—IEEE 488.2

► <SUFFIX PROGRAM DATA>

This data type is used when units and multipliers have to be sent.

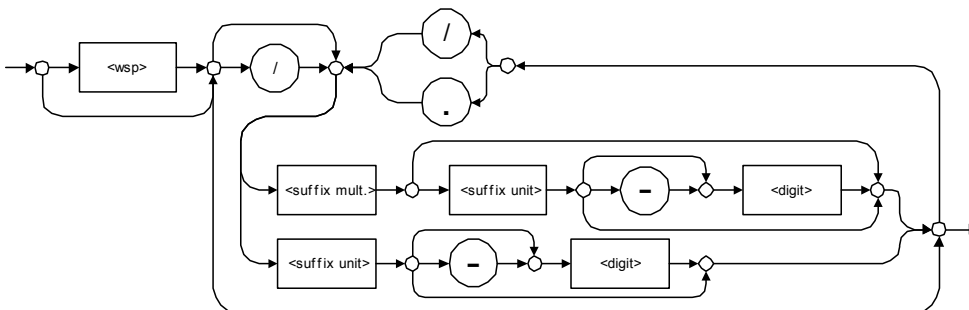

Examples: nm, kHz, km/s², uW

A relative unit (dB) can be referenced to an absolute level, as shown on the following diagram.

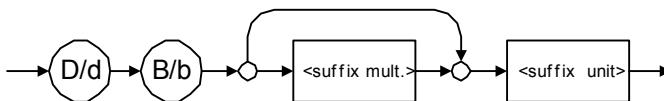

Examples: db, dbm, dBW

The following table illustrates the possible forms for <suffix mult.>:

Name	Value	Mnemonic
Exa	1E18	EX
Peta	1E15	PE
Tera	1E12	T
Giga	1E9	G
Mega	1E6	MA
Kilo	1E3	K
Milli	1E-3	M
Micro	1E-6	U
Nano	1E-9	N
Pico	1E-12	P
Femto	1E-15	F
Atto	1E-18	A

Data Types

Applicable Data Types for Input—IEEE 488.2

The table below gives the possible forms for <suffix unit> :

Reference Unit	Suffix Unit
Degrees	DEG
Radians	RAD
Amperes	A
Volts	V
Hertz	HZ
Meters	M
Watts	W
DBs ref to 1mW	DBM
Decibels	DB
Degrees Celsius	CEL
Degrees Fahrenheit	FAR
Kelvins	K
Seconds	S
Hours	HR
Minutes	MIN

Applicable Data Types for Output —IEEE 488.2

- <RESPONSE MESSAGE TERMINATOR>

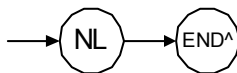

In the diagram above,

- “NL” corresponds to ASCII character code 10, in decimal (0A in binary)
- “END ^” corresponds to the last data byte of the message sent with EOI = True and ATN = False
- <CHARACTER RESPONSE DATA>

This data type will be used by a device to return short mnemonics when a <DECIMAL NUMERIC PROGRAM DATA> cannot be used. The returned information is sent in the long form and in upper case.

Examples: TRIANGLEWAVE, NCONTINUOUS

Data Types

Applicable Data Types for Output —IEEE 488.2

- <NR1 NUMERIC RESPONSE DATA> (or <NR1>)

This data type will be used by a device to return positive or negative integers.

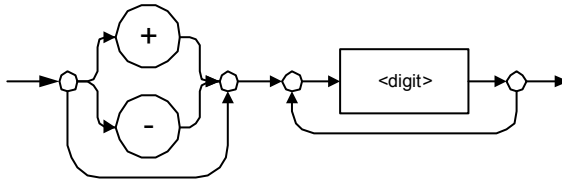

Examples: 4, -23, 90

- <NR2 NUMERIC RESPONSE DATA> (or <NR2>)

This data type will be used by a device to return positive or negative real numbers (fixed-point numbers).

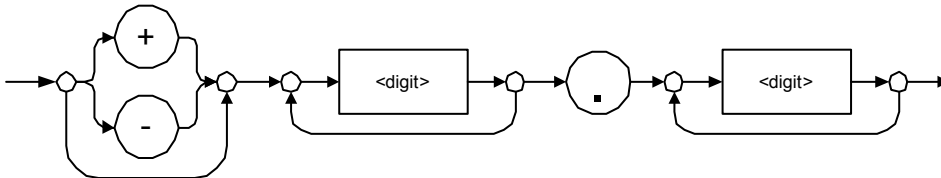

Examples: 23.45, 1.22, -4.55

► **<NR3 NUMERIC RESPONSE DATA> (or <NR3>)**

This data type will be used by a device to return positive or negative exponential numbers (floating-point numbers).

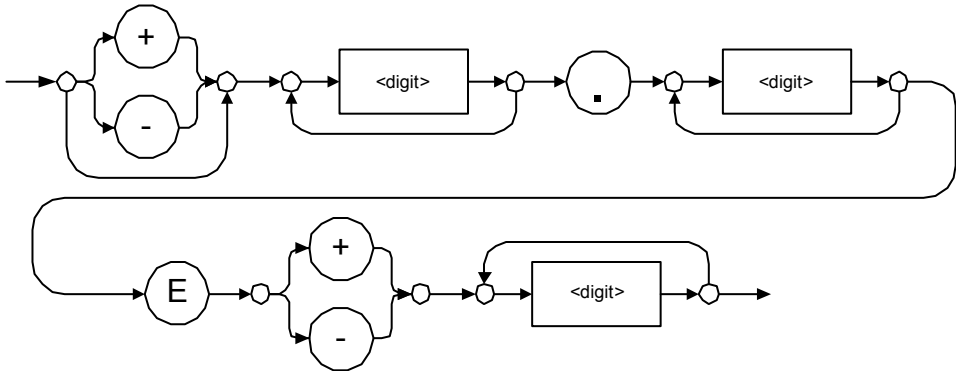

Examples: 4.3E-3, -8.9456E8, 123E-5

Data Types

Applicable Data Types for Output —IEEE 488.2

➤ **Special Numeric Values Received on Output**

In some cases, an instrument may send values indicating that an unusual event has occurred. The following tables present the possible values.

Value is	ASCII 4 bytes	PACKED 4 bytes
Under range	2143289345.000000	7FC00001
Over range	2143289346.000000	7FC00002
Invalid	2143289347.000000	7FC00003
Inactive	2143289348.000000	7FC00004

Value is	ASCII 8 bytes	PACKED 8 bytes
Under range	9221120237577961472	7FF8000020000000
Over range	9221120238114832384	7FF8000040000000
Invalid	9221120238651703296	7FF8000060000000
Inactive	9221120239188574208	7FF8000080000000

Data Types

Applicable Data Types for Output —IEEE 488.2

➤ <OCTAL NUMERIC RESPONSE DATA>

This data type will be used by a device to return integer representations in octal (base 8).

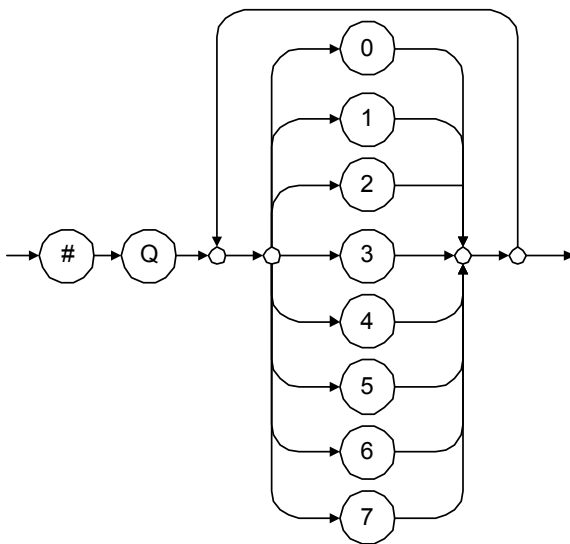

Examples: #Q753214, #Q0124, #Q0725

➤ **<BINARY NUMERIC RESPONSE DATA>**

This data type will be used by a device to return integer representations in binary (base 2).

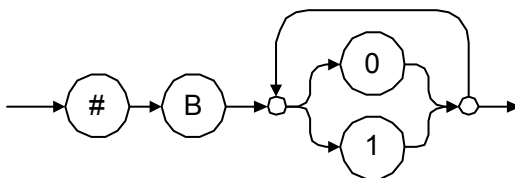

Examples: #B11011110101, #B110100, #B0100

➤ **<STRING RESPONSE DATA>**

This data type will be used by a device to return strings containing 7-bit ASCII characters and especially when text has to be displayed since even the non-printable characters are also returned.

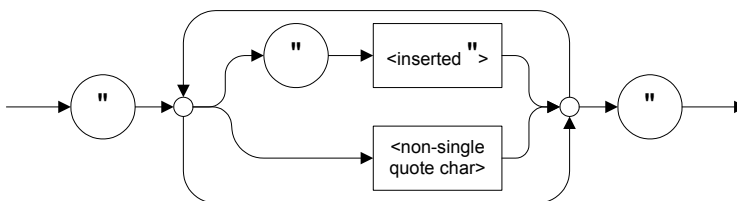

Examples: "SCPI Commands", "SCPI ""Commands""

Data Types

Applicable Data Types for Output —IEEE 488.2

➤ <DEFINITE LENGTH ARBITRARY BLOCK RESPONSE DATA>

This data type is used by a device to return blocks of 8-bit binary information with a fixed and predetermined length.

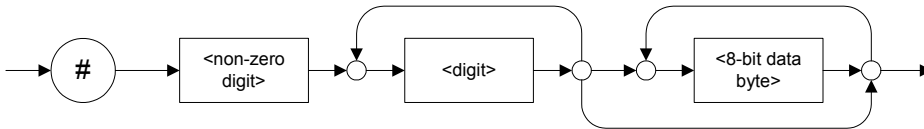

The actual length of the retrieved data has the following structure:

- The first byte contains the # character.
- The byte that immediately follows contains the number of subsequent bytes that you have to check to know the total length.

For example, if you receive this response (here, values are expressed in decimal instead of binary for easier readability):

2 1 3 7 6 8 9 2 ...

The byte that immediately follows the # contains 2, which means that you have to read the two following bytes to know the length (in bytes) of the retrieved data. The bytes indicate 1 and 3. The length will then be 13 bytes. The actual response will begin at byte number 5, in this case.

Examples: #14<DAB> <DAB> <DAB> <DAB> ,
#3004<DAB> <DAB> <DAB> <DAB>

where “<DAB>” stands for data byte

➤ **<INDEFINITE LENGTH ARBITRARY BLOCK RESPONSE DATA>**

This data type is used by a device to return blocks of 8-bit binary information when the block length was not predefined or when data has to be computed later.

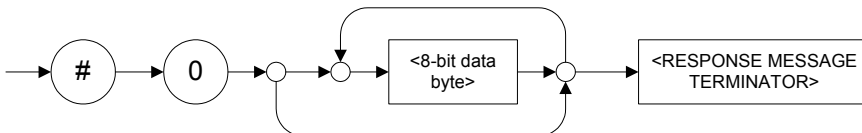

Note: *If you receive a zero as the first digit (#0), it is necessarily followed by a <RESPONSE PROGRAM MESSAGE TERMINATOR> so that you will detect the end of the <INDEFINITE LENGTH ARBITRARY BLOCK RESPONSE DATA>.*

Example: #0<DAB><DAB><DAB><DAB><terminator> where “<DAB>” stands for data byte.

Data Types

Applicable Data Types for Output —IEEE 488.2

➤ <SUFFIX RESPONSE DATA>

This data type is used by a device to return units and multipliers.

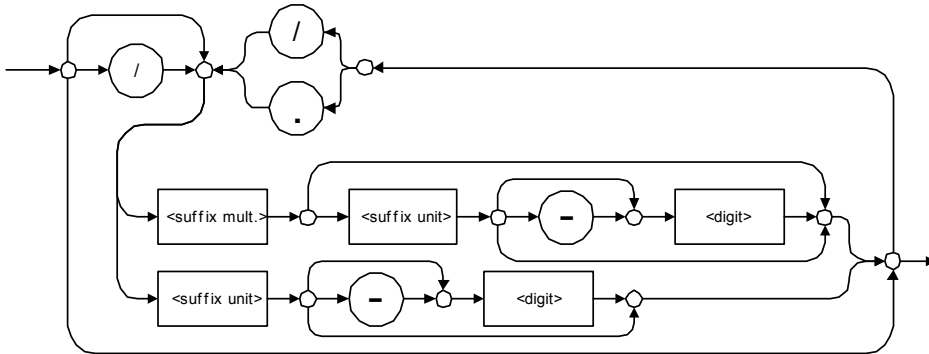

Examples: DBW, W, KHZ

➤ <ARBITRARY ASCII RESPONSE DATA>

This data type is used by a device to return information when it is impossible to use any other data type.

Example: To the *IDN? query, the device will return this response in an arbitrary ASCII bytes format:

EXFO E.O. Engineering,,125-2A55,1.0.1.97

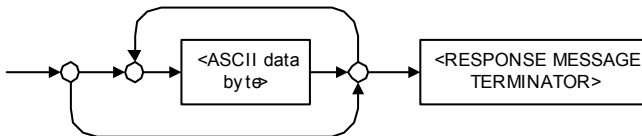

Applicable Data Types for Input—SCPI

SCPI data types include the IEEE 488.2 data types (see *Applicable Data Types for Input—IEEE 488.2* on page 298) with certain additional restrictions.

- `<numeric_value>`: abbreviated form of the decimal numeric element. It differs from the `<DECIMAL NUMERIC PROGRAM DATA>` “`<NRf>`” described in IEEE 488.2.

Several forms of `<CHARACTER PROGRAM DATA>` are defined as special forms of numbers. These are: `MINimum`, `MAXimum`, `DEFault`, `UP`, `DOWN`, `Not A Number (NAN)`, `INFinity` and `Negative INFinity (NINF)`. The following special forms are likely to be used by EXFO’s instruments in certain commands or queries:

- `DEFault`: This special `<numeric_value>` parameter forces the instrument to select a value, which is deemed to be convenient to the user.
- `MINimum` | `MAXimum`: These special `<numeric_value>` parameters refer to the instrument’s limit values. `MINimum` corresponds to the value closest to negative infinity that the function can accept. `MAXimum` corresponds to the largest value that the function can accept.
- `<Boolean Program Data>`: This form is often used as a shorthand of the `<DECIMAL NUMERIC PROGRAM DATA>` `ON` | `OFF` form.

`<Boolean Program Data>` parameters have a value of 0 or 1 and are not followed by any unit.

On input, an `<NRf>` is rounded to an integer.

A non-zero result is interpreted as 1.

`ON` and `OFF` are accepted on input for readability purposes. They correspond respectively to 1 and 0. However, on output, they appear as 1 or 0, never `ON` or `OFF`.

Data Types

Special Numeric Values Received on Output

Special Numeric Values Received on Output

It is possible that an instrument returns unusual values in certain cases. For information on these values, see Applicable Data Types for Output —IEEE 488.2 *on page 307*.

C **IEEE 488.2 and Specific Command Reference**

This chapter presents detailed information about the commands and queries supplied with your FTB-500.

IEEE 488.2 Commands–Quick Reference

The FTB-500 recognizes the required commands identified in IEEE 488.2. The table below summarizes these commands. These commands are fully explained on the following pages.

Command	Function
*CLS	Clear status command
*ESE	Standard event status enable command
*ESE?	Standard event status enable query
*ESR?	Standard event status register query
*IDN?	Identification query
*OPC	Operation complete command
*OPC?	Operation complete query
*RST	Reset command
*SRE	Service request enable command
*SRE?	Service request enable query
*STB?	Read status byte query
*TST?	Self-test query
*WAI	Wait for pending operations to be completed

IEEE 488.2 Required Commands

		*CLS
Description	The *CLS command clears the Standard Event Status Register and the Error/Event Queue.	
Syntax	*CLS	
Parameter(s)	None	

*ESE

Description

The *ESE command sets the Standard Event Status Enable Register bits, as defined in the table below. This register contains a mask value for the bits to be enabled in the Standard Event Status Register.

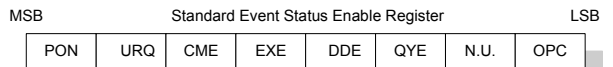

Syntax

*ESE<wsp> <RegisterValue>

Parameter(s)

RegisterValue:

The program data syntax for <RegisterValue> is defined as a <DECIMAL NUMERIC PROGRAM DATA> element.

The <RegisterValue>, expressed in base 2, represents the bit values of the Standard Event Status Enable Register.

The table below shows the contents of this register.

Bit	Weight	Meaning
PON	128	Power ON Enable
URQ	64	User ReQuest Enable
CMD	32	CoMmanD Error Enable
EXE	16	Execution Error Enable
DDE	8	Device Dependent Error Enable
QRY	4	QueRry Error Enable
N.U.	2	Not used
OPC	1	Operation Complete Enable

A value of 1 in the Enable Register enables the corresponding bit in the Status Register, a value of 0 disables the bit. The value of the <RegisterValue> shall be in the range of 0 through 255.

Example(s)

*ESE 25
where 25 = (bit EXE, bit DDE and bit OPC)

*ESE 0
clears the content of the Standard Event Status Enable register

See Also

*ESE?
*ESR?

*ESE?

Description With the *ESE? query you can determine the current contents of the Standard Event Status Enable Register. See the contents of this register below.

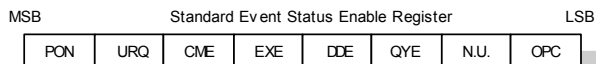

Syntax *ESE?

Parameter(s) None

Response Syntax <RegisterValue>

IEEE 488.2 and Specific Command Reference

IEEE 488.2 Required Commands

***ESE?**

Response(s)

RegisterValue:

The response data syntax for <RegisterValue> is defined as a <NR1 NUMERIC RESPONSE DATA> element.

The <RegisterValue> ranges from 0 through 255.

The <RegisterValue> value expressed in base 2 (binary) represents the bit values of the Standard Event Status Enable register. See below.

Bit	Weight	Meaning
PON	128	Power ON Enable
URQ	64	User ReQuest Enable
CMD	32	CoMmanD Error Enable
EXE	16	Execution Error Enable
DDE	8	Device Dependent Error Enable
QRY	4	QueRry Error Enable
N.U.	2	Not used
OPC	1	Operation Complete Enable

Example(s)

*ESE? returns 133
where 133 = (bit PON, bit QYE and bit OPC)

See Also

*ESE
*ESR?

*ESR?

Description With the *ESR? query you can determine the current contents of the Standard Event Status Register. Reading the Standard Event Status Register clears it. See the contents of this register below.

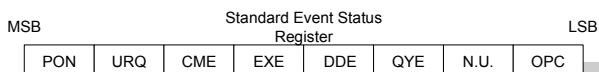

Syntax *ESR?

Parameter(s) None

Response Syntax <RegisterValue>

IEEE 488.2 and Specific Command Reference

IEEE 488.2 Required Commands

*ESR?

Response(s)

RegisterValue:

The response data syntax for <RegisterValue> is defined as a <NR1 NUMERIC RESPONSE DATA> element.

The <RegisterValue> ranges from 0 through 255.

The <RegisterValue> value expressed in base 2 (binary) represents the bit values of the Standard Event Status register. See below.

Bit	Weight	Meaning
PON	128	Power ON Enable
URQ	64	User ReQuest Enable
CMD	32	CoMmanD Error Enable
EXE	16	Execution Error Enable
DDE	8	Device Dependent Error Enable
QRY	4	QueRry Error Enable
N.U.	2	Not used
OPC	1	Operation Complete Enable

Example(s)

*ESR? returns 33
where 33 = (bit CME and bit OPC)

See Also

*ESE
*ESE?

***IDN?**

Description	The intent of the *IDN? query is for the unique identification of devices over the system interface.
Syntax	*IDN?
Parameter(s)	None
Response Syntax	<Identification>
Response(s)	<p><i>Identification:</i></p> <p>The response data syntax for <Identification> is defined as an <ARBITRARY ASCII RESPONSE DATA> element.</p>

The response syntax for the *IDN? query, <Identification> is defined as an <ARBITRARY ASCII RESPONSE DATA> element. This implies that the *IDN? query should be the last <QUERY MESSAGE UNIT> in a <TERMINATED PROGRAM MESSAGE>.

The response is organized into four fields separated by commas. The field definitions are as follows:

Field 1 (Manufacturer): EXFO Inc.
Field 2 (Model): Instrument Model

IEEE 488.2 and Specific Command Reference

IEEE 488.2 Required Commands

***IDN?**

Field 3 (Serial number): ASCII character (0 if not available)

Field 4 (Firmware level): ASCII character (0 if not available)

ASCII character 0 represents a single ASCII-encoded byte with a value of 30 (48 decimal).

The presence of data in all fields is mandatory. If either field 3 or 4 is not available, the ASCII character 0 shall be returned for that field. A field may contain any 7-bit ASCII-encoded bytes in the range of 20 through 7E (32 through 126 decimal) except commas (2C, 44 decimal) and semicolons (3B, 59 decimal).

Example(s)

*IDN? returns EXFO Inc.,
FTB-500,125-2A55,1.0.1.97

Notes

The overall length of the *IDN? response is less than or equal to 72 characters.

***OPC**

Description	The *OPC command makes synchronization between the instrument and an external controller possible. The *OPC command causes the instrument to set bit 0 (Operation Complete) in the Standard Event Status Register to the TRUE (logic 1) state when the instrument completes all pending operations. Detection of the Operation Complete message can be accomplished by continuous polling of the Standard Event Status Register using the *ESR? common query command. However, using a service request eliminates the need to poll the Standard Event Status Register thereby freeing the controller to do other useful work.
Syntax	*OPC
Parameter(s)	None
See Also	*OPC? *WAI

*OPC?

Description	The *OPC? query makes possible the synchronization between the instrument and an external controller by reading the Output Queue or by waiting for a service request on the Message Available (MAV) bit in the Status Byte Register. The *OPC? query causes the instrument to place an ASCII character, 1, into its Output Queue when the device completes all pending operations. A consequence of this action is that the MAV bit in the Status Byte Register is set to state 1.
Syntax	*OPC?
Parameter(s)	None
Response Syntax	<Acknowledge>
Response(s)	<i>Acknowledge:</i> The response data syntax for <Acknowledge> is defined as a <NR1 NUMERIC RESPONSE DATA> element. The <Acknowledge> response is a single ASCII-encoded byte corresponding to 1. The receipt of an <Acknowledge> response indicates that all pending selected device operations have been completed.
Example(s)	*OPC? returns 1
See Also	*OPC *WAI

RST*Description**

The *RST command performs a device reset. This command is the third reset level in a three-level reset strategy. The Reset command shall do the following:

- a) Sets the device-specific functions to a known state that is independent of the past-use history of the device.
- b) Forces the device into OCIS state (Operation complete Command Idle State).
- c) Forces the device into OQIS state (Operation complete Query Idle State).

The Reset command explicitly DOES NOT affect the following:

- a) The state of the Communication interface.
- b) The Output Queue.
- c) Any Event Enable Register setting, including the Standard Event Status Enable Register setting.
- d) Any Event Register setting, including the Standard Event Status Register settings.
- e) Calibration data that affects device specifications.
- f) The Service Request Enable Register setting.

Syntax

*RST

Parameter(s)

None

IEEE 488.2 and Specific Command Reference

IEEE 488.2 Required Commands

***SRE**

Description

The *SRE command sets the Service Request Enable Register bits. See the contents of this register below. This register contains a mask value to enable the bits in the Status Byte Register.

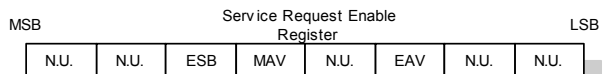

Syntax

*SRE<wsp> <RegisterValue>

Parameter(s)

RegisterValue:

The program data syntax for <RegisterValue> is defined as a <DECIMAL NUMERIC PROGRAM DATA> element.

The <RegisterValue> value ranges from 0 through 255.

The <RegisterValue>, expressed in base 2 (binary), represents the bit values of the Service Request Enable Register.

***SRE**

See the contents of this register below.

Bit	Weight	Meaning
N.U.	128	Not used
N.U.	64	Not used
ESB	32	Event Summary Bit Enable
MAV	16	Message AVailable Enable
N.U.	8	Not used
EAV	4	Error / Event AVailable Enable
N.U.	2	Not used
N.U.	1	Not used

A bit value of zero shall indicate a disabled condition.

Example(s)

*SRE 52
where 52 = (bit ESB, bit MAV and bit EAV)

See Also

*SRE?
*STB?

IEEE 488.2 and Specific Command Reference

IEEE 488.2 Required Commands

*SRE?

Description

With the *SRE? query you can determine the current contents of the Service Request Enable Register. See the contents of this register below.

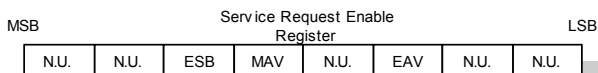

Bit	Weight	Meaning
N.U.	128	Not used
N.U.	64	Not used
ESB	32	Event Summary Bit Enable
MAV	16	Message AAvailable Enable
N.U.	8	Not used
EAV	4	Error / Event AAvailable Enable
N.U.	2	Not used
N.U.	1	Not used

Syntax

*SRE?

Parameter(s)

None

Response Syntax

<RegisterValue>

***SRE?**

Response(s)

RegisterValue:

The response data syntax for <RegisterValue> is defined as a <NR1 NUMERIC RESPONSE DATA> element.

The <RegisterValue> ranges from 0 through 255.

When converted to binary (base 2), the <RegisterValue> represents the current bit values of the Service Request Enable Register.

Example(s)

*SRE returns 32 (bit ESB)

See Also

*SRE
*STB?

STB?*Response(s)***RegisterValue:*

The response data syntax for <RegisterValue> is defined as a <NR1 NUMERIC RESPONSE DATA> element.

The <RegisterValue> ranges from 0 through 255.

The <RegisterValue> value, expressed in base 2 (binary) represents the bit values of the Status Byte Register. See the contents of this register below.

Bit	Weight	Meaning
N.U.	128	Not used
RQS/ MSS	64	ReQuest Service (read by serial polling)/MaSter Summary bit (read by *STB?)
ESB	32	Event Summary Bit Enable
MAV	16	Message AVailable Enable
N.U.	8	Not used
EAV	4	Error / Event AVailable Enable
N.U.	2	Not used
N.U.	1	Not used

Example(s)

*STB? returns 68
where 68 = (bit MSS and bit EAV)

See Also

*SRE
*SRE?

IEEE 488.2 and Specific Command Reference

IEEE 488.2 Required Commands

*TST?	
Description	The *TST? query causes an internal self-test and places a response into the Output Queue indicating whether or not the device completed the self-test without any detected errors. Upon successful completion of *TST?, the device settings is restored to their values prior to the *TST?.
Syntax	*TST?
Parameter(s)	None
Response Syntax	<Result>
Response(s)	<p><i>Result:</i></p> <p>The response data syntax for <Result> is defined as a <NR1 NUMERIC RESPONSE DATA> element.</p> <p>The <Result> value ranges from -32767 through +32767.</p> <p>A <Result> with a value of zero indicates that the self-test has been completed without errors detected. A <Result> with a value not equal to zero indicates that the self-test was not completed or was completed with errors detected.</p>
Example(s)	*TST? returns 0 (self-test was completed with success)

***WAI**

Description	The *WAI command shall prevent the device from executing any further commands or queries until the no-operation-pending flag becomes TRUE.
Syntax	*WAI
Parameter(s)	None
Example(s)	*WAI
See Also	*OPC *OPC?

Specific Commands—Quick Reference

The table below contains a summary of the FTB-500 specific commands. These commands are fully explained on the following pages.

Command						Parameter(s)
FORMat	[DATA]					ASCIi PACKed[,<Length>]
	[DATA]?					
INSTRument	CATalog?					
	CATalog	FULL?				
SYSTem	DATE					<Year>,<Month>,<Day>
	DATE?					
	ERRor	[NEXT]?				
	TIME					<Hour>,<Minute>,<Seconds>
	TIME?					
	VERSIon?					

Specific Commands

:FORMat[:DATA]

Description

The FORMat[:DATA] command selects the data format and <Length>. The <Length> parameter is optional for all data format, its meaning is dependent on the data format selected.

If PACKed type is selected, the data is transferred in a <DEFINITE BLOCK RESPONSE DATA>. The ASCii-type data is automatically identified by its syntax. Therefore, in these cases, the FORMat subsystem is only necessary to determine the output format.

At *RST, ASCii is selected as the default data format and the <Length> is set to 0.

Syntax

:FORMat[:DATA] <wsp>ASCii|PACKed[, <Length>]

Parameter(s)

► *Type:*

The program data syntax for the first parameter is defined as a <CHARACTER PROGRAM DATA> element. The allowed <CHARACTER PROGRAM DATA> elements for this parameter are: ASCii|PACKed.

:FORMat[:DATA]

In ASCii format, the numeric data is transferred to ASCii bytes in <NR1 NUMERIC RESPONSE DATA>, <NR2 NUMERIC RESPONSE DATA> or <NR3 NUMERIC RESPONSE DATA> representation, as appropriate.

In PACKed format, data is transferred to a <DEFINITE BLOCK RESPONSE DATA>, in a manner specified in the device documentation.

► *Length:*

The program data syntax for <Length> is defined as a <DECIMAL NUMERIC PROGRAM DATA> element.

When ASCii data format is selected, the optional <Length> parameter specifies the number of significant digits to be returned. A <Length> value of zero indicates that the device selects the number of significant digits to be returned. When a <Length> of zero has been specified, the FORMat[:DATA]? query returns zero as its second parameter.

When the PACKed data format is selected, the optional parameter <Length> it not used.

Example(s)

FORM ASC
FORM ASC,6
FORM:DATA PACKED

See Also

FORMat[:DATA]?

:FORMat[:DATA]?

Description	<p>The FORMat[:DATA]? query returns the data format and the <Length>.</p> <p>At *RST, ASCii is selected as the default data format and the <Length> is set to 0.</p>
Syntax	:FORMat[:DATA]?
Parameter(s)	None
Response Syntax	<Type>,<Length>
Response(s)	<p>➤ <i>Type:</i></p> <p>The response data syntax for <Type> is defined as a <CHARACTER RESPONSE DATA> element.</p> <p>The ASCII <Type> is returned when numeric data is transferred to ASCII bytes in <NR1 NUMERIC RESPONSE DATA>, <NR2 NUMERIC RESPONSE DATA> or <NR3 NUMERIC RESPONSE DATA> representation, as appropriate.</p> <p>The PACKED <Type> is returned when data is transferred to a <DEFINITE BLOCK RESPONSE DATA>, as specified in the device documentation.</p> <p>➤ <i>Length:</i></p> <p>The response data syntax for <Length> is defined as a <NR1 NUMERIC RESPONSE DATA> element.</p>

:FORMat[:DATA]?

When the data is returned in ASCII, the <Length> is the number of significant digits to be returned. A <Length> value of zero indicates that the device selects the number of significant digits to be returned.

When the data is returned in PACKED <Type>, the <Length> is not used and always returns 0.

Example(s)

FORM? returns ASCII,6

FORM? returns PACKED,0

See Also

FORMat[:DATA]?

:INSTrument:CATalog?

Description	<p>The INSTrument:CATalog? query returns a comma-separated list of <STRING RESPONSE DATA>, which contains the names of all logical instruments and groups. If no logical instruments are defined, a single null <STRING RESPONSE DATA> is returned.</p> <p>This is not affected by a *RST command.</p>
Syntax	:INSTrument:CATalog?
Parameter(s)	None
Response Syntax	<Catalog>
Response(s)	<p><i>Catalog:</i></p> <p>The response data syntax for <Catalog> is defined as a <STRING RESPONSE DATA> element.</p> <p>The list of <STRING PROGRAM DATA> contains the names of all logical instruments and groups.</p>
Example(s)	INST:CAT? returns “FTB-5240 Optical Spectrum Analyzer (1250nm-1650nm),”FTB-5240 Optical Spectrum Analyzer (1250nm-1650nm)”
See Also	INSTrument:CATalog:FULL?

:INSTrument:CATalog:FULL?

Description	<p>The INSTrument:CATalog:FULL? returns a list of <STRING RESPONSE DATA> - <NR1 NUMERIC RESPONSE DATA> pairs. The <STRING RESPONSE DATA> contains the name of the logical instrument. The immediately following <NR1 NUMERIC RESPONSE DATA> formatted number is its associated logical instrument number. All response data elements are separated by commas. If no logical instrument is defined, a null <STRING RESPONSE DATA> value followed by a zero is returned.</p> <p>This is not affected by a *RST command.</p>
Syntax	:INSTrument:CATalog:FULL?
Parameter(s)	None
Response Syntax	<Catalog>
Response(s)	<p><i>Catalog:</i></p> <p>The response data syntax for <Catalog> is defined as a <STRING RESPONSE DATA> element.</p> <p>The list of <STRING RESPONSE DATA> contains the names of all logical instruments and groups. The immediately following <NR1 NUMERIC RESPONSE DATA> formatted number is its associated logical instrument number.</p>
Example(s)	<p>INST:CAT:FULL? returns “FTB-5240 Optical Spectrum Analyzer (1250nm-1650nm)”,1,”FTB-5240 Optical Spectrum Analyzer (1250nm-1650nm)”,3</p>
See Also	INSTrument:CATalog?.

:SYSTem:DATE

Description	<p>The SYSTem:DATE command is used to set the device's internal calendar.</p> <p>This is not affected by a *RST command.</p>
Syntax	:SYSTem:DATE<wsp><Year>,<Month>,<Day> >
Parameter(s)	<p>➤ <i>Year:</i></p> <p>The program data syntax for <Year> is defined as a <DECIMAL NUMERIC PROGRAM DATA> element.</p> <p>The <Year> is rounded to the nearest integer. Its range is limited by the capability of the device. The year shall be entered as a four-digit number, including century and millennium information.</p> <p>➤ <i>Month:</i></p> <p>The program data syntax for <Month> is defined as a <DECIMAL NUMERIC PROGRAM DATA> element.</p> <p>The <Month> is rounded to the nearest integer. Its range is 1 to 12 inclusive. The number 1 corresponds to January, 2 to February, and so on.</p>

:SYSTem:DATE

➤ *Day:*

The program data syntax for <Day> is defined as a <DECIMAL NUMERIC PROGRAM DATA> element.

The <Day> is rounded to the nearest integer. It ranges from 1 to the number of days in the month from the previous parameter. This command keeps track of the number of days in each month, accounting for leap years through the range of years that it accepts.

Example(s)

SYST:DATE 2001,11,29

See Also

SYSTem:DATE?

:SYSTem:DATE?

Description	The SYSTem:DATE query returns the instrument's internal calendar. This is not affected by a *RST command.
Syntax	:SYSTem:DATE?
Parameter(s)	None
Response Syntax	<Year>,<Month>,<Day>

:SYSTem:DATE?

Response(s)

➤ *Year:*

The response data syntax for <Year> is defined as a <NR1 NUMERIC RESPONSE DATA> element.

The <Year> is a four-digit number, including century and millennium information.

➤ *Month:*

The response data syntax for <Month> is defined as a <NR1 NUMERIC RESPONSE DATA> element.

The <Month> ranges from 1 to 12, inclusively. The number 1 corresponds to January, 2 to February, and so on.

➤ *Day:*

The response data syntax for <Day> is defined as a <NR1 NUMERIC RESPONSE DATA> element.

The <Day> ranges from 1 to the number of days in the month from the previous field. This command keeps track of the number of days in each month, accounting for leap years through the range of years that it accepts.

Example(s)

SYST:DATE? returns 2001,11,29

See Also

SYSTem:DATE

:SYSTem:ERRor[:NEXT]?

Description	<p>The SYSTem:ERRor[:NEXT]? queries the error/event queue for the next item and removes it from the queue. The response message consists of two fields separated by commas <Code>,<Description[,Info]>.</p> <p>SYSTem:ERRor[:NEXT]? is a query only and, therefore, does not have an associated *RST state.</p>
Syntax	:SYSTem:ERRor[:NEXT]?
Parameter(s)	None
Response Syntax	<Code>,<Description[,Info]>
Response(s)	<p>► <i>Code:</i></p> <p>The response data syntax for <Code> is defined as a <NR1 NUMERIC RESPONSE DATA> element.</p> <p>The <Code> is a unique integer in the range [-32768, 32767]. All positive numbers are instrument-dependent. All negative numbers are reserved by the SCPI standard with certain standard error/event codes described in an appendix of this document. The zero value is also used to indicate that no error or event has occurred.</p> <p>► <i>Description[,Info]:</i></p> <p>The response data syntax for <Description[,Info]> is defined as a <STRING RESPONSE DATA> element.</p>

:SYSTem:ERRor[:NEXT]?

The <Description[,Info]> parameter of the full response is a quoted string containing a description followed by information text [,Info]. Each <Code> has a unique and fixed <Description> associated with it. The <Date> and <Time> are appended to the [,info] separated by a semi-colon using the following format:

<Date><wsp><Time> where

<Date> = Year/Month/Day

<Time> = Hour,Minute,Second (24 hour time)

The maximum length of <Description[,Info]> is 255 characters. For standard defined error/event <Codes>, the <Description> is sent exactly as indicated in the appendix of this document.

Example(s)

SYST:ERR:NEXT? returns -222,"Data out of range"
SYST:ERR:NEXT? returns -222,"Data out of range,instrument monomodule 5240, 2001/11/29 14:56:16.259"

:SYSTem:TIME

Description	<p>This device has an internal clock and implements the SYSTem:TIME command to set the clock time over the interface.</p> <p>This is not affected by a *RST command.</p>
Syntax	:SYSTem:TIME<wsp><Hour>,<Minute>,<Seconds>
Parameter(s)	<p>➤ <i>Hour:</i></p> <p>The program data syntax for <Hour> is defined as a <DECIMAL NUMERIC PROGRAM DATA> element.</p> <p>The <Hour> is always rounded to the nearest integer. It ranges from 0 to 23 inclusively. The device accepts hour information in 24-hour format.</p> <p>➤ <i>Minute:</i></p> <p>The program data syntax for <Minute> is defined as a <DECIMAL NUMERIC PROGRAM DATA> element.</p> <p>The <Minute> is always rounded to the nearest integer. It ranges from 0 to 59 inclusively.</p>

:SYSTem:TIME

➤ *Seconds:*

The program data syntax for <Seconds> is defined as a <DECIMAL NUMERIC PROGRAM DATA> element.

The <Second> is rounded to the resolution of the clock. It ranges from 0 to 60. A value of 60 is allowed since rounding may cause a number greater than 59.5 to be rounded to 60. When this element is rounded to 60 it shall be set to 0 and the minute value incremented. Any other carries shall be rippled through the date.

Example(s)

SYST:TIME 12,47,29

See Also

SYSTem:TIME?

:SYSTem:TIME?

Description	This device has an internal clock and implements the SYSTem:DATE? query to get the clock time over the interface. This is not affected by a *RST command.
Syntax	:SYSTem:TIME?
Parameter(s)	None
Response Syntax	<Hour>,<Minute>,<Second>

:SYSTem:TIME?

Response(s)

► *Hour:*

The response data syntax for <Hour> is defined as a <NR1 NUMERIC RESPONSE DATA> element.

The <Hour> ranges from 0 to 23. The instruments returns hour information in 24-hour format.

► *Minute:*

The response data syntax for <Minute> is defined as a <NR1 NUMERIC RESPONSE DATA> element.

The <Minute> ranges from 0 to 59.

► *Second:*

The response data syntax for <Second> is defined as a <NR1 NUMERIC RESPONSE DATA> element.

The <Second> ranges from 0 to 59. The resolution of the clock is the second.

Example(s)

SYST:TIME? returns 16,55,38

See Also

SYSTem:TIME

:SYSTem:VERSion?

Description	<p>The SYSTem:VERSion? query returns a value corresponding to the SCPI version number to which the device complies.</p> <p>The SYSTem:VERSion? is a query only and, therefore, does not have an associated *RST state.</p>
Syntax	:SYSTem:VERSion?
Parameter(s)	None
Response Syntax	<Version>
Response(s)	<p><i>Version:</i></p> <p>The response data syntax for <Version> is defined as a <NR2 NUMERIC RESPONSE DATA> element.</p> <p>The <Version> is shown in the form Year.Revision, where Year represents the year-version (that is 1990) and Revision represents an approved revision number for that year. If no approved revisions are claimed, then this extension is 0.</p>
Example(s)	SYSTem:VERSion? returns 1999.0 (no approved revisions are claimed)

D SCPI-Based Errors

Error Number	Description	Probable Cause
-100	“Command error”	This is the generic syntax error for devices that cannot detect more specific errors. This code indicates only that a Command Error as defined in IEEE 488.2, 11.5.1.1.4 has occurred.
-101	“Invalid character”	A syntactic element contains a character which is invalid for that type; for example, a header containing an ampersand, SETUP&. This error might be used in place of errors -114, -121, -141, and perhaps some others.
-102	“Syntax error”	An unrecognized command or data type was encountered; for example, a string was received when the device does not accept strings.
-103	“Invalid separator”	The parser was expecting a separator and encountered an illegal character; for example, the semicolon was omitted after a program message unit, *EMC 1:CH1:VOLTS 5.
-104	“Data type error”	The parser recognized a data element different than one allowed; for example, numeric or string data was expected but block data was encountered.
-105	“GET not allowed”	A Group Execute Trigger was received within a program message (see IEEE 488.2, 7.7).
-108	“Parameter not allowed”	More parameters were received than expected for the header; for example, the *EMC common command only accepts one parameter, so receiving *EMC 0,1 is not allowed.
-109	“Missing parameter”	Fewer parameters were received than required for the header; for example, the *EMC common command requires one parameter, so receiving *EMC is not allowed.

SCPI-Based Errors

Error Number	Description	Probable Cause
-110	“Command header error”	An error was detected in the header. This error message should be used when the device cannot detect the more specific errors described for errors -111 through -119.
-111	“Header separator error”	A character which is not a legal header separator was encountered while parsing the header; for example, no white space followed the header, thus *GMC"MACRO" is an error.
-112	“Program mnemonic too long”	The header contains more than twelve characters (see IEEE 488.2, 7.6.1.4.1).
-113	“Undefined header”	The header is syntactically correct, but it is undefined for this specific device; for example, *XYZ is not defined for any device.
-114	“Header suffix out of range”	The value of a numeric suffix attached to a program mnemonic (see IEEE 488.2, Syntax and Style section 6.2.5.2) makes the header invalid.
-115	“Unexpected number of parameters”	The number of parameters received does not correspond to the number of parameters expected. This is typically due to an inconsistency with the number of instruments in the selected group (see section on INSTRUMENT:DEFine:GROup).
-120	“Numeric data error”	This error, as well as errors -121 through -129, are generated when parsing a data element which appears to be numeric, including the non-decimal numeric types. This particular error message should be used if the device cannot detect a more specific error.
-121	“Invalid character in number”	An invalid character for the data type being parsed was encountered; for example, an alpha in a decimal numeric or a "9" in octal data.

Error Number	Description	Probable Cause
-123	“Exponent too large”	The magnitude of the exponent was larger than 32000 (see IEEE 488.2, 7.7.2.4.1).
-124	“Too many digits”	The mantissa of a decimal numeric data element contained more than 255 digits excluding leading zeros (see IEEE 488.2, 7.7.2.4.1).
-128	“Numeric data not allowed”	A legal numeric data element was received, but the device does not accept one in this position for the header.
-130	“Suffix error”	This error, as well as errors -131 through -139, are generated when parsing a suffix. This particular error message should be used if the device cannot detect a more specific error.
-131	“Invalid suffix”	The suffix does not follow the syntax described in IEEE 488.2, 7.7.3.2, or the suffix is inappropriate for this device.
-134	“Suffix too long”	The suffix contained more than 12 characters (see IEEE 488.2, 7.7.3.4).
-138	“Suffix not allowed”	A suffix was encountered after a numeric element which does not allow suffixes.
-140	“Character data error”	This error, as well as errors -141 through -149, are generated when parsing a character data element. This particular error message should be used if the device cannot detect a more specific error.
-141	“Invalid character data”	Either the character data element contains an invalid character or the particular element received is not valid for the header.
-144	“Character data too long”	The character data element contains more than twelve characters (see IEEE 488.2, 7.7.1.4).
-148	“Character data not allowed”	A legal character data element was encountered where prohibited by the device.

SCPI-Based Errors

Error Number	Description	Probable Cause
-150	“String data error”	This error, as well as errors -151 through -159, are generated when parsing a string data element. This particular error message should be used if the device cannot detect a more specific error.
-151	“Invalid string data”	A string data element was expected, but was invalid for some reason (see IEEE 488.2, 7.7.5.2); for example, an END message was received before the terminal quote character.
-158	“String data not allowed”	A string data element was encountered but was not allowed by the device at this point in parsing.
-160	“Block data error”	This error, as well as errors -161 through -169, are generated when parsing a block data element. This particular error message should be used if the device cannot detect a more specific error.
-161	“Invalid block data”	A block data element was expected, but was invalid for some reason (see IEEE 488.2, 7.7.6.2); for example, an END message was received before the length was satisfied.
-168	“Block data not allowed”	A legal block data element was encountered but was not allowed by the device at this point in parsing.
-170	“Expression error”	This error, as well as errors -171 through -179, are generated when parsing an expression data element. This particular error message should be used if the device cannot detect a more specific error.
-171	“Invalid expression”	The expression data element was invalid (see IEEE 488.2, 7.7.7.2); for example, unmatched parentheses or an illegal character.
-178	“Expression data not allowed”	A legal expression data was encountered but was not allowed by the device at this point in parsing.

Error Number	Description	Probable Cause
-180	"Macro error"	This error, as well as errors -181 through -189, are generated when defining a macro or executing a macro. This particular error message should be used if the device cannot detect a more specific error.
-181	"Invalid outside macro definition"	Indicates that a macro parameter placeholder ($\$(\text{number})$) was encountered outside of a macro definition.
-183	"Invalid inside macro definition"	Indicates that the program message unit sequence, sent with a *DDT or *DMC command, is syntactically invalid (see IEEE 488.2, 10.7.6.3).
-184	"Macro parameter error"	Indicates that a command inside the macro definition had the wrong number or type of parameters.
-200	"Execution error"	This is the generic syntax error for devices that cannot detect more specific errors. This code indicates only that an Execution Error as defined in IEEE 488.2, 11.5.1.1.5 has occurred.
-201	"Invalid while in local"	Indicates that a command is not executable while the device is in local due to a hard local control (see IEEE 488.2, 5.6.1.5); for example, a device with a rotary switch receives a message which would change the switches state, but the device is in local so the message can not be executed.
-202	"Settings lost due to rtl"	Indicates that a setting associated with a hard local control (see IEEE 488.2, 5.6.1.5) was lost when the device changed to LOCS from REMS or to LWLS from RWLS.
-203	"Command protected"	Indicates that a legal password-protected program command or query could not be executed because the command was disabled.

SCPI-Based Errors

Error Number	Description	Probable Cause
-210	“Trigger error”	-----
-211	“Trigger ignored”	Indicates that a GET, *TRG, or triggering signal was received and recognized by the device but was ignored because of device timing considerations; for example, the device was not ready to respond. Note: a DT0 device always ignores GET and treats *TRG as a Command Error.
-212	“Arm ignored”	Indicates that an arming signal was received and recognized by the device but was ignored.
-213	“Init ignored”	Indicates that a request for a measurement initiation was ignored as another measurement was already in progress.
-214	“Trigger deadlock”	Indicates that the trigger source for the initiation of a measurement is set to GET and subsequent measurement query is received. The measurement cannot be started until a GET is received, but the GET would cause an INTERRUPTED error.
-215	“Arm deadlock”	Indicates that the arm source for the initiation of a measurement is set to GET and subsequent measurement query is received. The measurement cannot be started until a GET is received, but the GET would cause an INTERRUPTED error.
-220	“Parameter error”	Indicates that a program data element related error occurred. This error message should be used when the device cannot detect the more specific errors described for errors -221 through -229.
-221	“Settings conflict”	Indicates that a legal program data element was parsed but could not be executed due to the current device state (see IEEE 488.2, 6.4.5.3 and 11.5.1.1.5).

Error Number	Description	Probable Cause
-222	"Data out of range"	Indicates that a legal program data element was parsed but could not be executed because the interpreted value was outside the legal range as defined by the device (see IEEE 488.2, 11.5.1.1.5).
-223	"Too much data"	Indicates that a legal program data element of block, expression, or string type was received that contained more data than the device could handle due to memory or related device-specific requirements.
-224	"Illegal parameter value"	Used where exact value, from a list of possible, was expected.
-225	"Out of memory"	The device has insufficient memory to perform the requested operation.
-226	"Lists not same length"	Attempted to use LIST structure having individual LIST's of unequal lengths.
-230	"Data corrupt or stale"	Possibly invalid data; new reading started but not completed since last access.
-231	"Data questionable"	Indicates that measurement accuracy is suspect.
-232	"Invalid format"	Indicates that a legal program data element was parsed but could not be executed because the data format or structure is inappropriate. For example when loading memory tables or when sending a SYSTem:SET parameter from an unknown instrument.

SCPI-Based Errors

Error Number	Description	Probable Cause
-233	“Invalid version”	Indicates that a legal program data element was parsed but could not be executed because the version of the data is incorrect to the device. This particular error should be used when file or block data formats are recognized by the instrument but cannot be executed for reasons of version incompatibility. For example, a not supported file version, a not supported instrument version
-240	“Hardware error”	Indicates that a legal program command or query could not be executed because of a hardware problem in the device. Definition of what constitutes a hardware problem is completely device-specific. This error message should be used when the device cannot detect the more specific errors described for errors -241 through -249.
-241	“Hardware missing”	Indicates that a legal program command or query could not be executed because of missing device hardware; for example, an option was not installed. Definition of what constitutes missing hardware is completely device-specific.
-250	“Mass storage error”	Indicates that a mass storage error occurred. This error message should be used when the device cannot detect the more specific errors described for errors -251 through -259.
-251	“Missing mass storage”	Indicates that a legal program command or query could not be executed because of missing mass storage; for example, an option that was not installed. Definition of what constitutes missing mass storage is device-specific.
-252	“Missing media”	Indicates that a legal program command or query could not be executed because of a missing media; for example, no disk. The definition of what constitutes missing media is device-specific.

Error Number	Description	Probable Cause
-253	“Corrupt media”	Indicates that a legal program command or query could not be executed because of corrupt media; for example, bad disk or wrong format. The definition of what constitutes corrupt media is device-specific.
-254	“Media full”	Indicates that a legal program command or query could not be executed because the media was full; for example, there is no room on the disk. The definition of what constitutes a full media is device-specific.
-255	“Directory full”	Indicates that a legal program command or query could not be executed because the media directory was full. The definition of what constitutes a full media directory is device-specific.
-256	“File name not found”	Indicates that a legal program command or query could not be executed because the file name on the device media was not found; for example, an attempt was made to read or copy a nonexistent file. The definition of what constitutes a file not being found is device-specific.
-257	“File name error”	Indicates that a legal program command or query could not be executed because the file name on the device media was in error; for example, an attempt was made to copy to a duplicate file name. The definition of what constitutes a file name error is device-specific.
-258	“Media protected”	Indicates that a legal program command or query could not be executed because the media was protected; for example, the write-protect tab on a disk was present. The definition of what constitutes protected media is device-specific.

SCPI-Based Errors

Error Number	Description	Probable Cause
-260	“Expression error”	[Indicates that a expression program data element related error occurred. This error message should be used when the device cannot detect the more specific errors described for errors -261 through -269.]
-261	“Math error in expression”	[Indicates that a syntactically legal expression program data element could not be executed due to a math error; for example, a divide-by-zero was attempted. The definition of math error is device-specific.]
-270	“Macro error”	[Indicates that a macro-related execution error occurred. This error message should be used when the device cannot detect the more specific errors described for errors -271 through -279.]
-271	“Macro syntax error”	[Indicates that a syntactically legal macro program data sequence, according to IEEE 488.2, 10.7.2, could not be executed due to a syntax error within the macro definition (see IEEE 488.2, 10.7.6.3).]
-272	“Macro execution error”	[Indicates that a syntactically legal macro program data sequence could not be executed due to some error in the macro definition (see IEEE 488.2, 10.7.6.3).]
-273	“Illegal macro label”	[Indicates that the macro label defined in the *DMC command was a legal string syntax, but could not be accepted by the device (see IEEE 488.2, 10.7.3 and 10.7.6.2); for example, the label was too long, the same as a common command header, or contained invalid header syntax.]
-274	“Macro parameter error”	[Indicates that the macro definition improperly used a macro parameter placeholder (see IEEE 488.2, 10.7.3).]

Error Number	Description	Probable Cause
-275	“Macro definition too long”	[Indicates that a syntactically legal macro program data sequence could not be executed because the string or block contents were too long for the device to handle (see IEEE 488.2, 10.7.6.1).]
-276	“Macro recursion error”	[Indicates that a syntactically legal macro program data sequence could not be executed because the device found it to be recursive (see IEEE 488.2, 10.7.6.6).]
-277	“Macro redefinition not allowed”	[Indicates that a syntactically legal macro label in the *DMC command could not be executed because the macro label was already defined (see IEEE 488.2, 10.7.6.4).]
-278	“Macro header not found”	[Indicates that a syntactically legal macro label in the *GMC? query could not be executed because the header was not previously defined.]
-280	“Program error”	[Indicates that a downloaded program-related execution error occurred. This error message should be used when the device cannot detect the more specific errors described for errors -281 through -289. A downloaded program is used to add algorithmic capability to a device. The syntax used in the program and the mechanism for downloading a program is device-specific.]
-281	“Cannot create program”	[Indicates that an attempt to create a program was unsuccessful. A reason for the failure might include not enough memory.]
-282	“”Illegal program name	[The name used to reference a program was invalid; for example, redefining an existing program, deleting a nonexistent program, or in general, referencing a nonexistent program.]
-283	“Illegal variable name”	[An attempt was made to reference a nonexistent variable in a program.]

SCPI-Based Errors

Error Number	Description	Probable Cause
-284	“Program currently running”	[Certain operations dealing with programs may be illegal while the program is running; for example, deleting a running program might not be possible.]
-285	“Program syntax error”	[Indicates that a syntax error appears in a downloaded program. The syntax used when parsing the downloaded program is device-specific.]
-286	“Program runtime error”	-----
-290	“Memory use error”	[Indicates that a user request has directly or indirectly caused an error related to memory or <data_handle>, this is not the same as “bad” memory.]
-291	“Out of memory”	-----
-292	“Referenced name does not exist”	-----
-293	“Referenced name already exist”	-----
-294	“Incompatible type”	[Indicates that the type or structure of a memory item is inadequate]
-300	“Device-specific error”	[This is the generic device-dependent error for devices that cannot detect more specific errors. This code indicates only that a Device-Dependent Error as defined in IEEE 488.2, 11.5.1.1.6 has occurred.]
-310	“System error”	[Indicates that some error, termed "system error" by the device, has occurred. This code is device-dependent.]
-311	“Memory error”	[Indicates some physical fault in the device's memory, such as parity error.]

Error Number	Description	Probable Cause
-312	"PUD memory lost"	[Indicates that the protected user data saved by the *PUD command has been lost.]
-313	"Calibration memory lost"	[Indicates that nonvolatile calibration data used by the *CAL? command has been lost.]
-314	"Save/Recall memory lost"	[Indicates that the nonvolatile data saved by the *SAV? command has been lost.]
-315	"Configuration memory lost"	[Indicates that nonvolatile configuration data saved by the device has been lost. The meaning of this error is device-specific.]
-320	"Storage fault"	[Indicates that the firmware detected a fault when using data storage. This error is not an indication of physical damage or failure of any mass storage element.]
-321	"Out of memory"	[An internal operation needed more memory than was available.]
-330	"Self-test failed"	-----
-340	"Calibration failed"	-----
-350	"Queue overflow"	[A specific code entered into the queue in lieu of the code that caused the error. This code indicates that there is no room in the queue and an error occurred but was not recorded.]
-360	"Communication error"	[This is the generic communication error for devices that cannot detect the more specific errors described for errors -361 through -363.]
-361	"Parity error in program message"	[Parity bit not correct when data received for example, on a serial port.]
-362	"Framing error in program message"	[A stop bit was not detected when data was received for example, on a serial port (for example, a baud rate mismatch).]

SCPI-Based Errors

Error Number	Description	Probable Cause
-363	“Input buffer overrun”	[Software or hardware input buffer on serial port overflows with data caused by improper or nonexistent pacing.]
-365	“Time out error”	[This is a generic device-dependent error.]
-400	“Query error”	[This is the generic query error for devices that cannot detect more specific errors. This code indicates only that a Query Error as defined in IEEE 488.2, 11.5.1.1.7 and 6.3 has occurred.]
-410	“Query INTERRUPTED”	[Indicates that a condition causing an INTERRUPTED Query error occurred (see IEEE 488.2, 6.3.2.3); for example, a query followed by DAB or GET before a response was completely sent.]
-420	“Query UNTERMINATED”	[Indicates that a condition causing an UNTERMINATED Query error occurred (see IEEE 488.2, 6.3.2.2); for example, the device was addressed to talk and an incomplete program message was received.]
-430	“Query DEADLOCKED”	[Indicates that a condition causing an DEADLOCKED Query error occurred (see IEEE 488.2, 6.3.1.7); for example, both input buffer and output buffer are full and the device cannot continue.]
-440	“Query UNTERMINATED after indefinite response”	[Indicates that a query was received in the same program message after an query requesting an indefinite response was executed (see IEEE 488.2, 6.5.7.5).]
-500	“Power on”	[The instrument has detected an off to on transition in its power supply.]
-600	“User request”	[The instrument has detected the activation of a user request local control.]

Error Number	Description	Probable Cause
-700	"Request control"	[The instrument requested to become the active IEEE 488.1 controller-in-charge.]
-800	"Operation complete"	[The instrument has completed all selected pending operations in accordance with the IEEE 488.2, 12.5.2 synchronization protocol.]

E **COM Properties and Events**

The FTB-500 also provides objects based on Microsoft Component Object Model (COM). COM defines a common way to access and create software components and services.

COM promotes the integration and the reuse of software components, as well as interoperability. In order to interoperate, components developed in different languages must adhere to a binary structure specified by Microsoft.

OLE and ActiveX are based on COM. Also, programming languages such as C, C++, Smalltalk, Pascal, Ada, Java, and LabVIEW can create and use COM components.

You can build your own programs using the provided properties and events via the IcSCPIAccess interface. For information on how to configure your FTB-500 for DCOM control, see *Configuring DCOM Access to Your Unit* on page 185.

ActiveX (COM/DCOM)—Quick Reference

The following diagram illustrates the different properties and events available.

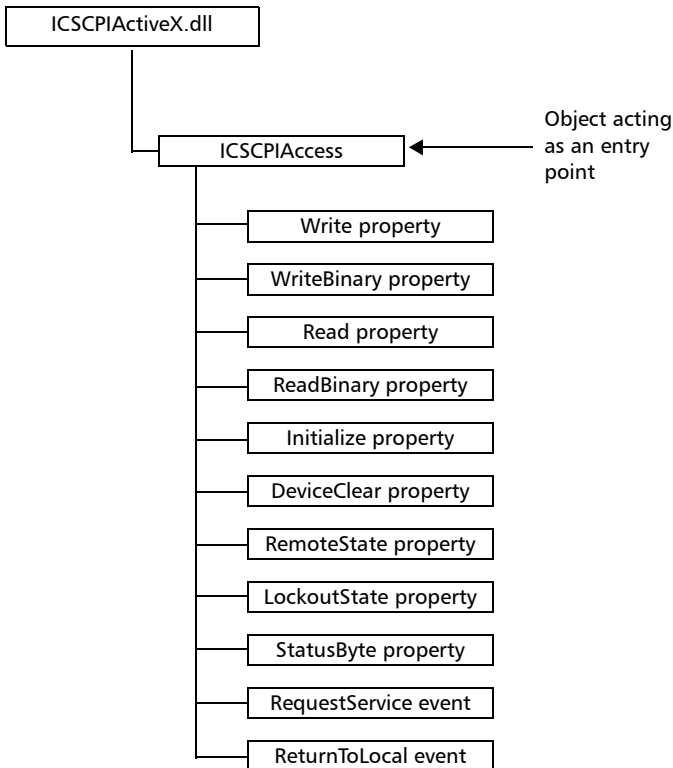

These properties and events are fully explained in the following pages.

Properties

Write

Description	With this method you can send a program message (single command or compound of commands) to the device input buffer.
Syntax	object. <i>Write</i> (<i>Message</i>)
Parameter(s)	<i>Message</i> : Required. A string value corresponding to the program message to be sent.
Possible error(s)	<i>Timeout</i> : This error will occur if the operation could not be completed within the allowed delay. For information on timeout setting, see <i>Initialize</i> on page 381.

WriteBinary

Description	With this method you can send a program message (single command or compound of commands) as an array of bytes into the device input buffer.
Syntax	<code>object.Write (BinaryArray)</code>
Parameter(s)	<i>BinaryArray</i> : Required. An array of bytes corresponding to the program message to be sent.
Notes	Use this method instead of the <i>Write</i> method if you need to send commands in binary (COM is UNICODE).
Possible error(s)	<i>Timeout</i> : This error will occur if the operation could not be completed within the allowed delay. For information on timeout setting, see <i>Initialize</i> on page 381.



IMPORTANT

Before you retrieve data with the *Read* or *ReadBinary* methods, you must specify the format in which the information must be returned. Details on how to correctly set the format can be found below.

Read

Description	With this method you can retrieve all the data from the device output queue in a UNICODE format.
Syntax	<code>object.Read</code>
Parameter(s)	None.
Response(s)	A string value (in UNICODE format).
Notes	<p>This method must be used in conjunction with the <i>Write</i> method. Always ensure that a query has been previously sent before attempting to read a response from the output queue.</p> <p>To properly set the data format, send the following command (using the <i>Write</i> method): FORM:DATA<wsp>ASCII <number_of_digits> where <number_of_digits> corresponds to the number of digits after the decimal point that you require.</p> <p>Remember that the retrieved data will have to be converted to a numeric format before you can use it in calculations, for example.</p>
Possible error(s)	<p><i>Timeout</i>: This error will occur if the allowed delay has expired before the preceding <i>Write</i> operation could send a response to the output queue. For information on timeout setting, see <i>Initialize</i> on page 381.</p> <p><i>QueryUnterminated</i>: This error will occur if the output queue is empty (for example, no query has been made previously).</p>

ReadBinary

Description	With this method you can retrieve data from the device output queue in a binary format.
Syntax	<code>object.ReadBinary</code>
Parameter(s)	None.
Response(s)	An array of bytes.
Notes	<p>This method must be used in conjunction with the <i>Write</i> method. Always ensure that a query has been previously sent before attempting to read a response from the output queue.</p> <p>To properly set the data format, send the following command (using the <i>Write</i> method): FORM:DATA<wsp>PACKED</p> <p>The retrieved data <i>does not</i> need to be converted to a numeric format before you can use it in calculations, for example.</p> <p>To help you know the actual length of the retrieved data, it has the following structure:</p> <ul style="list-style-type: none">➤ The first byte contains the # character.➤ The byte that immediately follows contains the number of subsequent bytes that you have to check to know the total length.

ReadBinary

For example, if you receive this response (here, values are expressed in decimal instead of binary for easier readability):

```
# 2 1 3 7 5 8 9 2 ...
```

The byte that immediately follows the # contains 2, which means that you have to read the two following bytes to know the length (in bytes) of the retrieved data. The bytes indicate 1 and 3. The length will then be 13 bytes. The actual response will begin at byte number 5, in this case.

Possible error(s)

Timeout: This error will occur if the allowed delay has expired before the preceding *Write* operation could send a response to the output queue. For information on timeout setting, see *Initialize* on page 381.

QueryUnterminated: This error will occur if the output queue is empty (for example, no query has been made previously).

Initialize

Description

With this method you can configure the timeout value that is, the allowed delay for Read and Write operations, in milliseconds.

Syntax

```
object.Initialize(Timeout)
```

Parameter(s)

Timeout: Required. A numeric value corresponding to the delay in milliseconds.

Notes

If the *Initialize* method is not invoked, the default value is 10 000 milliseconds.

COM Properties and Events

Properties

DeviceClear	
Description	This method performs a <i>Device Clear</i> operation as specified in the IEEE 488.1 standard.
Syntax	<code>object.DeviceClear</code>
Parameter(s)	None.

RemoteState	
Description	This property returns or sets the device's remote state.
Syntax	<code>object.RemoteState</code> (to retrieve the state) <code>object.RemoteState=State</code> (to set the state) <i>State</i> : a Boolean value corresponding to: True: Remote False: Local
Parameter(s)	None.
Response(s)	If the property is used to get the device's remote state, the property will return a Boolean value.
Access	Get/Set

LockoutState

Description	This property returns or sets the device's lockout state.
Syntax	<p>object.<i>LockoutState</i> (to retrieve the state)</p> <p>object.<i>LockoutState</i>=<i>State</i> (to set the state)</p> <p><i>State</i>: a Boolean value corresponding to:</p> <p style="padding-left: 40px;">True: Lockout</p> <p style="padding-left: 40px;">False: No lockout</p>
Parameter(s)	None.
Response(s)	If the property is used to get the device's lockout state, the property will return a Boolean value.
Access	Get/Set

StatusByte

Description	This read-only property returns the device's status byte. Refer to IEEE 488.2 standard for status byte description.
Syntax	object. <i>StatusByte</i>
Parameter(s)	None.
Response(s)	A value corresponding to the device's status byte.
Notes	This property can be used in conjunction with <i>RequestService</i> event (see <i>RequestService</i> on page 384) to find out why the device caused a Service Request (SRQ).
Access	Get

Events

RequestService	
Description	This event is triggered whenever the device causes a Service Request (SRQ).
Parameter(s)	None.
Notes	<p>It is the user's responsibility to configure the different registers (*SRE, *ESE) as stated in the IEEE 488.2 standard to receive SRQ.</p> <p>When used in conjunction with <i>StatusByte</i> property (see <i>StatusByte</i> on page 383), this event allows you to determine the cause of the SRQ.</p>

ReturnToLocal	
Description	This event is triggered when the user presses the Local button from the controller's front panel when the device is in Remote state.
Parameter(s)	None.

Index

3G USB modem, using 97

A

About tab 285

AC requirements 19, 20

accessing

 Internet with a 3G USB modem 97

 online help 282

 power meter 108

 ToolBox 39

activating on-screen keyboard 56

ActiveX

 control 176

 linking units 177

 selecting 182

adapter 18

address 285

adjusting date and time 77

after-sales service 284

alarm LED 8

Always On power scheme 80

angled brackets 222

antivirus software 47

applications

 installing 36

 module, starting 40

 modules 7

 starting, single-module 40

 ToolBox, starting 90

ASCII format 180

automatic fan speed 10

automatic Windows updates 256

automation 175

B

backlight

 button 9

 level 54

battery

 gauge 252

 inserting 250

 LED 8

 maintenance recommendations 249

 recalibrating 254

 removing 250

 status 252

 type allowed 250

braces 222

brackets

 angled 222

 square 221

brightness slider 53

browsing Web 96

buttons

 backlight 9

 local 9

 module information 283

 program switcher 9

C

calibrating the touchscreen 51

cancelling dark current effects 110

capacitors 17

caution

 of personal hazard 11

 of product hazard 11

certification information x

Index

changing	
backlight level.....	54
batteries	250
communication settings	181
date and time	77
language	69
status.....	215
charger.....	18
checking data integrity.....	280
choosing	
language	69
power management option.....	80
time zone	77
circuit performance	110
cleaning	
detector ports.....	246
front panel	245
touchscreen	248
VFL connectors	247
clearing power meter display	121
codes, error	226
colon	222
colors, LEDs	270
COM, local control	176
COM/DCOM	
demo application.....	227
events	384
properties	377
comma	223
commands	
IEEE 488.2	320
SCPI	220
specific	341
communication	
ActiveX	176
changing settings	181
default settings.....	184
Ethernet TCP/IP	175, 176
RS-232	175, 176
TCP/IP over Telnet	176
configuring power management options....	80
connecting to a VPN	151
connector cleaner	247
ConnectorMax2	127
consulting PDF files	94
contacting EXFO	285
contents of hard drive	10
control	
ActiveX.....	176
Ethernet TCP/IP	175, 176
remote	175
RS-232	176
TCP/IP over Telnet	176
controlling modules	175
conventions, programming	220, 223, 225
conventions, safety.....	11
copying commands into	
text document	242, 244
creating PDF files	91
current modules view	40
current, electrical.....	19
customer service.....	292
D	
dark current effects, eliminating.....	110
data	
integrity	280
retrieving	277
types	297
data input	
IEEE 488.2	298
SCPI.....	317
data output IEEE 488.2	
special.....	310, 318
standard	307
date and time, adjusting	77
DC connector.....	5
DCOM	
configuring computers	185
demo application.....	227
technology.....	176

description	
function buttons.....	9
LED panel.....	8
detecting module.....	25
detector port, cleaning.....	246
digit	221
disconnecting unit.....	16
documents, printing.....	91
dongle, 3G USB.....	97
drivers, LabVIEW	41
dual-boot	272
E	
electronic offsets, eliminating	110
emergency system tools	272
equipment returns	292
error messages in remote control.....	226
Ethernet TCP/IP	
control.....	175, 176
port	177
examples	
COM/DCOM.....	227
LabVIEW	230
exiting ToolBox.....	39
Explorer, Internet	96
external power supply.....	18
F	
fan speed	10
fiber	
identifying faults	125
measuring optical power	116
fiber inspection probe.....	127
FIP	127
front module lock.....	4
front panel, cleaning.....	245
function buttons description.....	9
fuse	
replacement.....	17, 259
type	259
G	
grounding stud	34
H	
hard drive	
LED	8
structure	10
hardware keyboard	55
hazard, laser radiation.....	15
headset, installing	61
help, online	282
hibernation mode.....	30
hour, setting.....	77
I	
identification label.....	284
identifying fiber faults	125
IEEE 488.2 commands	320
image, system	10
indoor use	17
inlets.....	16
input	
IEEE 488.2 data types	298
SCPI data types	317
input current	19
inserting a module	21
inserting batteries.....	250
inspecting fibers	127
installing	
headset.....	61
microphone	62
monitor.....	50
printer.....	63
software.....	36
speakers.....	61
third-party software.....	47
unit	17
VPN clients.....	151
instrument control settings	181
integrity, data.....	280

Index

interface, changing language..... 69
Internet connection..... 96, 97

K

Kensington lock..... 35
keyboard
 hardware..... 55
 on-screen..... 56
keywords, SCPI..... 222

L

label, identification 284
LabVIEW
 demo application..... 230
 installing drivers 41
 principles..... 228
LAN network..... 176
language, selecting 69
laser safety
 LED..... 8
laser safety information 15
learning COM/DCOM..... 227
LED
 indicators..... 270
 panel description..... 8
linking units
 Ethernet port..... 177
 serial port 178
list separator 222
local button..... 9
local control 176, 182
local to remote..... 215
location
 AC adapter connector..... 5, 6
 hardware buttons..... 2
 LCD touchscreen..... 2
 LED panel 2
locking unit..... 35
lockout status..... 214

M

main window, power meter 108
maintenance
 battery..... 249
 detector ports..... 246
 front panel..... 245
 general information 245
 touchscreen 248
mandatory commands 320
Max Battery power scheme 80
maximum input current..... 19
measurement, with power meter 116
mechanical connector cleaning 247
microphone, installing..... 62
mnemonic, definition 222
modifying power schemes..... 80
module
 current..... 28
 detection 25
 information button..... 283
 insertion..... 21
 lock..... 4
 removal..... 21
modules
 controlling 175
 virtual keyboard..... 56
monitor, installing 62
monitoring remote commands..... 241
mouse, see pointing device
multiple capabilities 221
multitasking with ToolBox..... 7

N

navigating the Internet..... 96
network, LAN/WAN 176

O

offset nulling 110
online applications bar 40
online help 282

-
- on-screen keyboard 56
 - opening user guides 94
 - operation language 69
 - optical detector performance 110
 - options
 - software 42
 - ToolBox 86
 - output IEEE 488.2
 - special 310, 318
 - standard 307
- P**
- PACKed format 180
 - Pass Fail status LED 8
 - PDF files
 - generating 91
 - viewing 94
 - performing
 - null measurement 110
 - optical power measurement 116
 - peripheral
 - hardware keyboard 55
 - headset 61
 - microphone 62
 - monitor 50
 - pointing device 60
 - printer 63
 - speakers 61
 - pipe character 222
 - platform commands 341
 - platform tab 287
 - platform-related tools 89
 - pointing device, installing 60
 - port
 - Ethernet 177
 - serial 178
 - power
 - cable 16
 - LED 8
 - plug 16
 - sources 19
 - supply 18
 - power management, configuring 80
 - power meter
 - accessing 108
 - buttons description 109
 - clearing the display 121
 - creating a report 122
 - measurement 116
 - printing a report 123
 - recalling results 119
 - reference values 115
 - results 118
 - setting thresholds 111
 - thresholds 111
 - power options, selecting and modifying 80
 - printer, installing 63
 - printing documents 91
 - probe 127
 - product
 - identification label 284
 - specifications 295
 - program switcher button 9
 - programmable instruments,
 - standards 175, 220
 - protective cap 246
 - purchased options 42
- R**
- radiation hazard, laser 15
 - reading PDF files 94
 - recalibrating batteries 254
 - recalling results, power meter 119
 - receiving data
 - with Ethernet port 177
 - with serial port 178

Index

reference	
mode	115
values, setting	115
zero power	110
register	
diagram	218
ESE	216
ESR	216
SRE	216
STB	216
remote control	
ActiveX (DCOM)	176, 177
configuring	182, 185
description of commands	220
error messages	226
LED	8
methods	175
monitoring	241
RS-232	175, 176, 178
status	214
TCP/IP over Telnet	176
remote to local	215
removing a module	21
removing batteries	250
repairing unit	17
replacing fuses	259
report	
creating for power meter results	122
printing	123
resolution, touchscreen	51
restoring system partition	274
retrieving data	277
return merchandise authorization (RMA) ..	292
reverting to default settings	184
right-clicking with the touchscreen	59
RS-232	
communication	175
control	176
port	178
selecting	182
rules	
programming	225
syntax	223
syntax conventions	220
S	
safety	
caution	11
conventions	11
information	15
power cable	16
warning	11
SCPI	
commands	220
data types	317
guidelines	175, 220
screen resolution	51
securing unit	35
selecting	
language	69
startup applications	65
time zone	77
semicolon	223
sending data	
with Ethernet port	177
with serial port	178
separator	222, 223
service and repairs	292
service centers	293
service request enable register (SRE)	216
setting	
date and time	77
instrument control utility	181
power thresholds (power meter)	111
reference values	115
shipping to EXFO	292

-
- shutdown modes 30
 - software
 - accessing 39
 - exiting 39
 - installing 36
 - options 42
 - upgrading 36
 - space 221
 - speakers, installing 61
 - specific commands 341
 - specifications, product 295
 - square brackets 221
 - standard event status
 - enable register (ESE) 216
 - register (ESR) 216
 - Standard power scheme 80
 - standard status data structure
 - diagram 218
 - general 216
 - standby mode 30
 - starting
 - FTB-500 28
 - module applications 40
 - other applications 90
 - ToolBox 39
 - startup, selecting applications for 65
 - status
 - local 214
 - local with lockout 214
 - remote 214
 - remote with lockout 214
 - switching 215
 - status byte register (STB) 216
 - storage requirements 245
 - structure of hard drive 10
 - stud, grounding, 34
 - SumatraPDF reader 94
 - supports for unit 49
 - surfing the Internet 96
 - symbols, safety 11
 - syntax
 - rules 220, 223
 - SCPI 220
 - symbols 221
 - system
 - emergency tools 272
 - ghost 10
 - information tab 285
 - partition, restoring 274
- T**
- TCP/IP
 - configuring parameters 183
 - control 175, 176
 - selecting 182
 - technical specifications 295
 - technical support 284
 - temperature for storage 245
 - third-party software 47
 - thresholds
 - power 111
 - setting, power meter 111
 - time zone, selecting 77
 - ToolBox
 - applications 90
 - language 69
 - options 86
 - platform-related tools 89
 - ToolBox. *see also* software
 - tools system, emergency 272
 - touchscreen
 - calibrating 51
 - cleaning 248
 - resolution 51
 - right-clicking 59
 - transportation requirements 245, 288
 - turning off unit 30
 - turning on unit 28
 - type of fuses 17
 - types, data 297

Index

U

unit	
back and bottom supports	49
disconnecting	16
installing	17
repairing	17
restoring	274
status	214
ventilation	17
updating	
applications	36
Windows applications	256
using a 3G USB modem	97

V

ventilation	17
vertical bar	222
VFL	
identifying fiber faults	125
VFL, cleaning	247
view	
current modules	40
PDF files	94
system information	285
virtual keyboard	56
virtual private network (VPN)	151

W

WAN network	176
warranty	
certification	291
exclusions	291
general	289
liability	290
null and void	289
Web browser	96
white space	221
Windows applications, updating	256
wireless connection	97

working with power meter	108
wsp	221

Z

zero-power reference	110
----------------------------	-----

NOTICE

通告

CHINESE REGULATION ON RESTRICTION OF HAZARDOUS SUBSTANCES

中国关于有害物质限制的规定

NAMES AND CONTENTS OF THE TOXIC OR HAZARDOUS SUBSTANCES OR ELEMENTS CONTAINED IN THIS EXFO PRODUCT

包含在本 EXFO 产品中的有毒有害物质或元素的名称和含量



O	Indicates that this toxic or hazardous substance contained in all of the homogeneous materials for this part is below the limit requirement in SJ/T11363-2006 表示该有毒有害物质在该部件所有均质材料中的含量均在 SJ/T11363-2006 标准规定的限量要求以下。
X	Indicates that this toxic or hazardous substance contained in at least one of the homogeneous materials used for this part is above the limit requirement in SJ/T11363-2006 表示该有毒有害物质至少在该部件的某一均质材料中的含量超出 SJ/T11363-2006 标准规定的限量要求。

Part Name 部件名称	Toxic or hazardous Substances and Elements 有毒有害物质和元素					
	Lead 铅 (Pb)	Mercury 汞 (Hg)	Cadmium 镉 (Cd)	Hexavalent Chromium 六价铬 (Cr VI)	Polybrominated biphenyls 多溴联苯 (PBB)	Polybrominated diphenyl ethers 多溴二苯醚 (PBDE)
Enclosure 外壳	O	O	O	O	O	O
Electronic and electrical sub-assembly 电子和电子组件	X	O	X	O	X	X
Optical sub-assembly ^a 光学组件 ^a	X	O	O	O	O	O
Mechanical sub-assembly ^a 机械组件 ^a	O	O	O	O	O	O

a. If applicable.
如果适用。

MARKING REQUIREMENTS

标注要求

Product 产品	Environmental protection use period (years) 环境保护使用期限 (年)	Logo 标志
This Exfo product 本 EXFO 产品	10	
Battery ^a 电池 ^a	5	

- a. If applicable.
如果适用。

P/N: 1065807

www.EXFO.com · info@exfo.com

CORPORATE HEADQUARTERS	400 Godin Avenue	Quebec (Quebec) G1M 2K2 CANADA Tel.: 1 418 683-0211 · Fax: 1 418 683-2170
EXFO AMERICA	3400 Waterview Parkway Suite 100	Richardson, TX 75080 USA Tel.: 1 972-761-927 · Fax: 1 972-761-9067
EXFO EUROPE	Winchester House, School Lane	Chandlers Ford, Hampshire S053 4DG ENGLAND Tel.: +44 2380 246 800 · Fax: +44 2380 246 801
EXFO ASIA-PACIFIC	100 Beach Road, #25-01/03 Shaw Tower	SINGAPORE 189702 Tel.: +65 6333 8241 · Fax: +65 6333 8242
EXFO CHINA	Beijing Global Trade Center, Tower C, Room 1207, 36 North Third Ring Road East, Dongcheng District	Beijing 100013 P. R. CHINA Tel.: +86 (10) 5825 7755 · Fax: +86 (10) 5825 7722
EXFO SERVICE ASSURANCE	270 Billerica Road	Chelmsford MA, 01824 USA Tel.: 1 978 367-5600 · Fax: 1 978 367-5700
EXFO FINLAND	Elektroniikkatie 2	FI-90590 Oulu, FINLAND Tel.: +358 (0) 403 010 300 · Fax: +358 (0) 8 564 5203
TOLL-FREE	(USA and Canada)	1 800 663-3936

© 2014 EXFO Inc. All rights reserved.
Printed in Canada (2014-01)



EXFO
EXPERTISE REACHING OUT