FTB-500



Copyright © 2009–2016 EXFO Inc. All rights reserved. No part of this publication may be reproduced, stored in a retrieval system or transmitted in any form, be it electronically, mechanically, or by any other means such as photocopying, recording or otherwise, without the prior written permission of EXFO Inc. (EXFO).

Information provided by EXFO is believed to be accurate and reliable. However, no responsibility is assumed by EXFO for its use nor for any infringements of patents or other rights of third parties that may result from its use. No license is granted by implication or otherwise under any patent rights of EXFO.

EXFO's Commerce And Government Entities (CAGE) code under the North Atlantic Treaty Organization (NATO) is 0L8C3.

The information contained in this publication is subject to change without notice.

Trademarks

EXFO's trademarks have been identified as such. However, the presence or absence of such identification does not affect the legal status of any trademark.

Units of Measurement

Units of measurement in this publication conform to SI standards and practices.

Version number: 9.0.1.1

Contents

Certification Information	vii
1 Introducing the FTB-500	1
Main Features	2
LED Indicators Description	8
Function Buttons Description	11
Power Sources	12
Automatic Fan Speed Management	13
Product Registration	14
Technical Specifications	14
Conventions	15
2 Safety Information	17
Other Safety Symbols on Your Unit	18
Laser Safety Information	19
Electrical Safety Information	20
3 Getting Started with Your Unit	23
Grounding Your Unit	23
Positioning Your Unit	25
Inserting and Removing Test Modules	26
Turning On Your Unit	32
Turning Off Your Unit	32
Configuring Your Unit At First Startup	38
Accessing and Exiting ToolBox	40
Starting Module Applications	41
Using the On-Screen (Virtual) Keyboard	42
Working with Windows 8.1 Pro	42
Right-Clicking with the Touchscreen	44
Installing or Upgrading the Applications	45
Installing EXFO LabVIEW Drivers	48
Activating Software Options	51
Installing Third-Party Software on Your Unit	54
Protecting your Unit with an Antivirus Software	54
Securing your Unit Using the Kensington Lock	55
Using a Keyboard, Mouse or Other USB Devices	56
Configuring an External Monitor	58

Contents

4	Setting Up Your FTB-500	61
	Adjusting Brightness	61
	Adjusting Microphone and Speaker Volume	62
	Recalibrating the Touchscreen	67
	Customizing the Right-Click Feature	71
	Enabling or Disabling the Automatic Logon	75
	Selecting the Startup Applications	79
	Configuring Network Printers	81
	Selecting the Language of Operation	83
	Setting Date and Time Formats	92
	Adjusting the Date, Time and Time Zone	94
	Configuring the Power Management Options	95
	Setting ToolBox Behavior	105
	Configuring the Internet Options	107
	Configuring Parameters via Windows Mobility Center	109
	Setting Communication Parameters	110
	Setting Other Parameters	110
5	Working with Your Unit	111
	Printing Documents	111
	Viewing PDF Files	112
	Taking Screen Captures	113
	Browsing the Web	115
	Accessing the Internet with a 3G USB Modem Key	116
	Retrieving the GPS Location of Your Unit	120
	Managing Favorites	122
	Using the Calculator	130
	Using the Text Editor	130
	Accessing Other Tools	131
6	Using the Optional Built-In Power Meter and VFL	133
7	Inspecting Fibers with a Probe	135
8	Managing Data	137
	Viewing Disk Space and Managing Files	138
	Transferring Data via Bluetooth	139
	Connecting to a Wireless Network	146
	Using the USB to RS-232 Adapter	148
	Freeing Up Disk Space with the Disk Cleanup Utility	154
	Connecting to a VPN from Your Unit	158
	Using Your Unit as an FTP Server	164

9	Accessing Your Unit Remotely	167
	Working with Remote Desktop	168
	Working With TightVNC	178
	Adding Exceptions to the Firewall	184
10	Preparing for Automation	189
	Linking Units with the Ethernet Port	191
	Linking Units with the Serial Port	192
	Getting Optimum Performance from Your Unit	193
	Changing Communication Settings	195
	Configuring DCOM Access to Your Unit	199
	Preparing to Control Modules with a Dedicated Application	222
11	Using FTB Products in an Automated Test Environment	227
	Standard Status Data Structure	228
	SCPI Command Structure	232
	Consulting Data Types	235
	Writing Remote Control Code	236
	Error Message Format	238
	Working with EXFO LabVIEW Drivers	239
	Using the EXFO Getting Started Applications	241
	Building and Using Custom VIs	246
	Monitoring Remote Commands	253
12	Maintenance	257
	Cleaning Detector Ports	258
	Cleaning VFL-Type Connectors	259
	Cleaning the Touchscreen	260
	Recharging the Batteries	261
	Replacing Batteries	264
	Viewing Battery Status	270
	Recalibrating the Batteries	272
	Installing or Removing the Power Meter and VFL	274
	Managing Windows Updates	281
	Replacing Fuses (Eight-Slot Model Only)	283
	Recycling and Disposal (Applies to European Union Only)	284

Contents

13 Troubleshooting	285
Solving Common Problems	285
Restoring Your Unit to Normal Operation	291
Accessing the Online Documentation	306
Contacting the Technical Support Group	307
Viewing System Information	308
Retrieving Network Interfaces Information	311
Transportation	314
14 Warranty	315
General Information	315
Liability	316
Exclusions	316
Certification	316
Service and Repairs	317
EXFO Service Centers Worldwide	318
A Data Types	319
Applicable Data Types for Input—IEEE 488.2	320
Applicable Data Types for Output —IEEE 488.2	329
Applicable Data Types for Input—SCPI	339
Special Numeric Values Received on Output	340
B IEEE 488.2 and Specific Command Reference	341
IEEE 488.2 Commands—Quick Reference	341
IEEE 488.2 Required Commands	342
Specific Commands—Quick Reference	362
Specific Commands	363
C SCPI-Based Errors	381
D COM Properties and Events	397
ActiveX (COM/DCOM)—Quick Reference	398
Properties	399
Events	406
E Communicating Through TCP/IP over Telnet	407
Introducing TCP/IP over Telnet	407
Features	408
Configuring Your Unit and Modules to Work With TCP/IP over Telnet	409
Executing SCPI Commands Over Telnet	415
Releasing Modules	421
Internal Commands of the TCP/IP over Telnet Protocol	422

Certification Information

North America Regulatory Statement

This unit was certified by an agency approved in both Canada and the United States of America. It has been evaluated according to applicable North American approved standards for product safety for use in Canada and the United States.

Electronic test and measurement equipment is exempt from FCC part 15, subpart B compliance in the United States of America and from ICES-003 compliance in Canada. However, EXFO Inc. makes reasonable efforts to ensure compliance to the applicable standards.

The limits set by these standards are designed to provide reasonable protection against harmful interference when the equipment is operated in a commercial environment. This equipment generates, uses, and can radiate radio frequency energy and, if not installed and used in accordance with the user guide, may cause harmful interference to radio communications. Operation of this equipment in a residential area is likely to cause harmful interference in which case the user will be required to correct the interference at his own expense.

Modifications not expressly approved by the manufacturer could void the user's authority to operate the equipment.

European Community Declaration of Conformity

Warning: This is a class A product. In a domestic environment, this product may cause radio interference in which case the user may be required to take adequate measures.

An electronic version of the declaration of conformity for your product is available on our website at www.exfo.com/library.

1 *Introducing the FTB-500*

Today's network technology is more complex than ever. Thousands of components have to work in harmony and deployment specialists are responsible for tuning entire systems for optimal network performance and for ensuring records updates. In addition, fiber counts are skyrocketing. DWDM is well entrenched in long-haul applications and is moving into metro. You know that you need more efficiency.

You will find it with the FTB-500. Benefit from advanced test operations in outside plant installation, maintenance, and troubleshooting. The FTB-500 streamlines field-based test and measurement operations into a single, powerful, revolutionary package. Welcome to multi-tasking in the field.

Introducing the FTB-500

Main Features

Main Features

Front

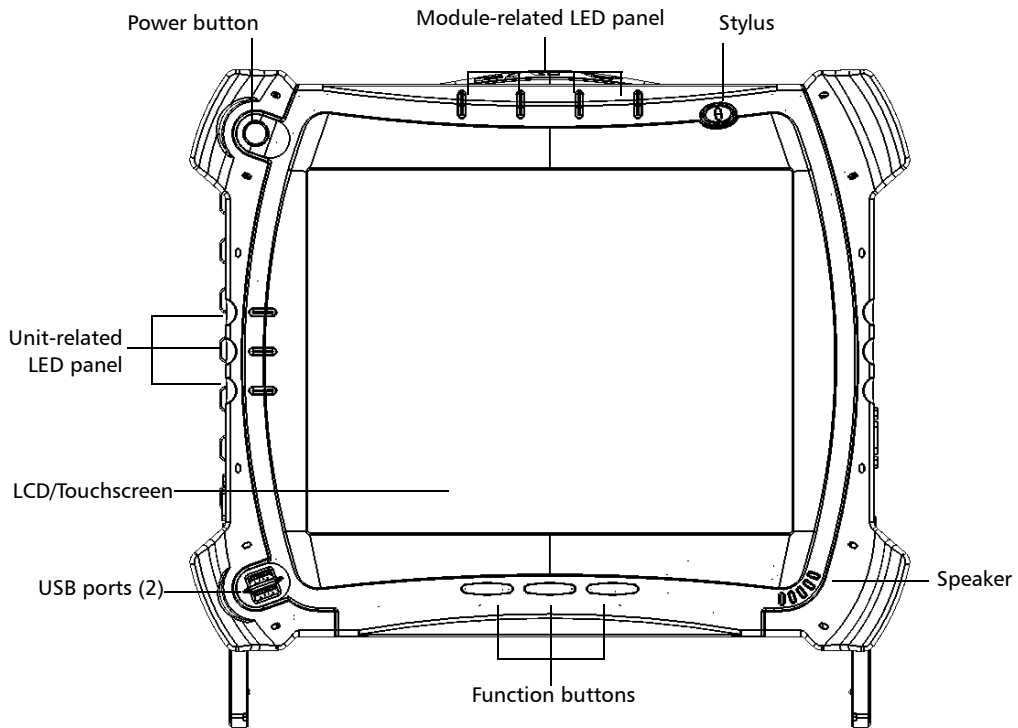

**Right side
(four-slot model)**

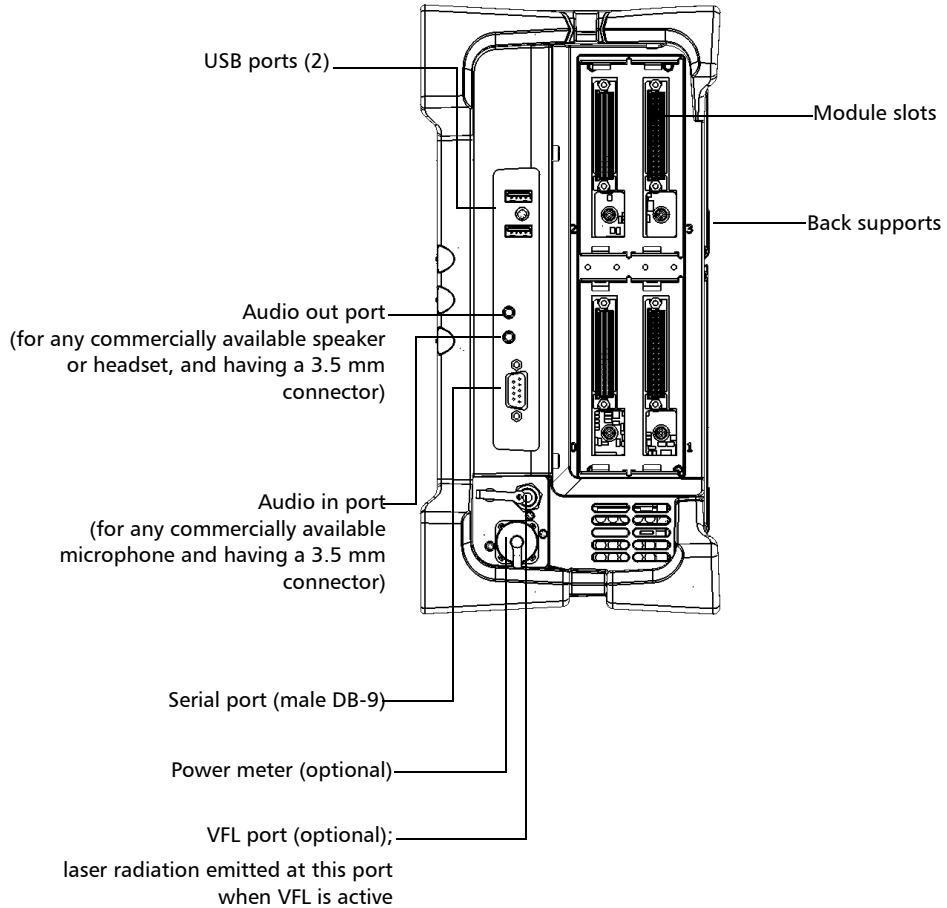

Introducing the FTB-500

Main Features

Right side (eight-slot model)

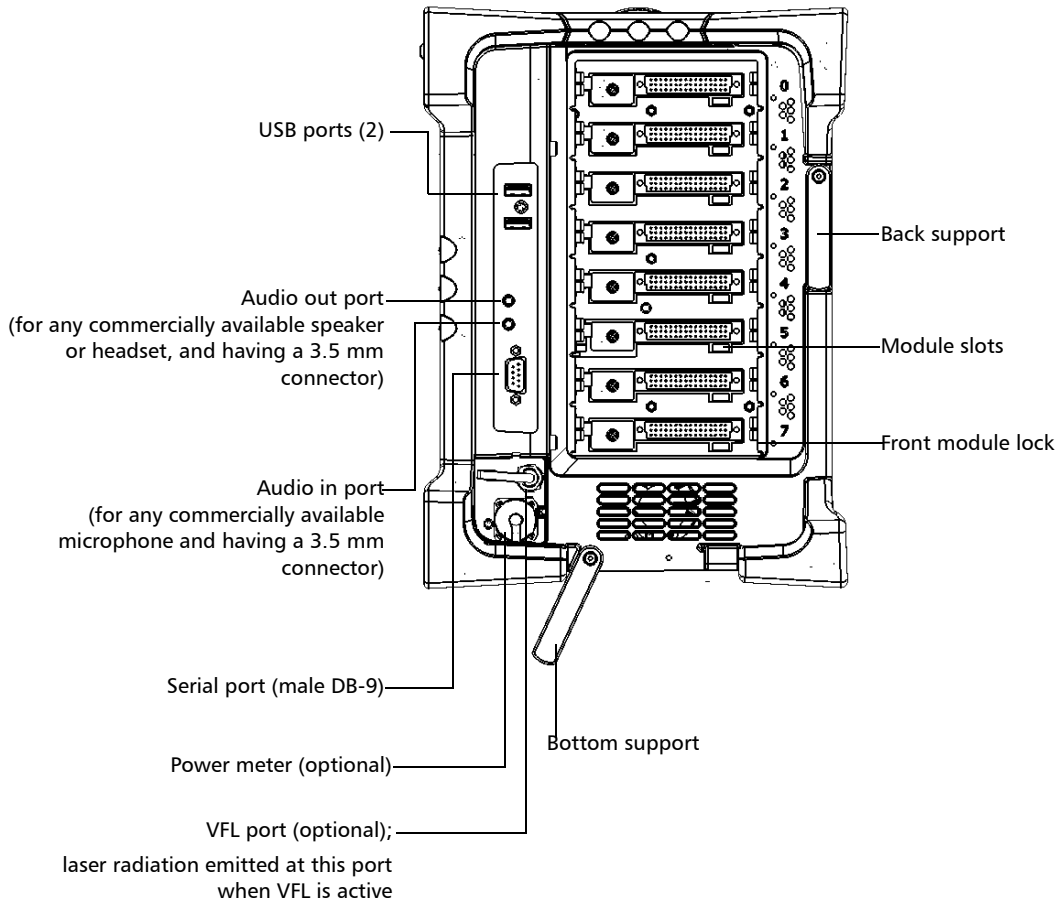

Left side

(Four-slot model)

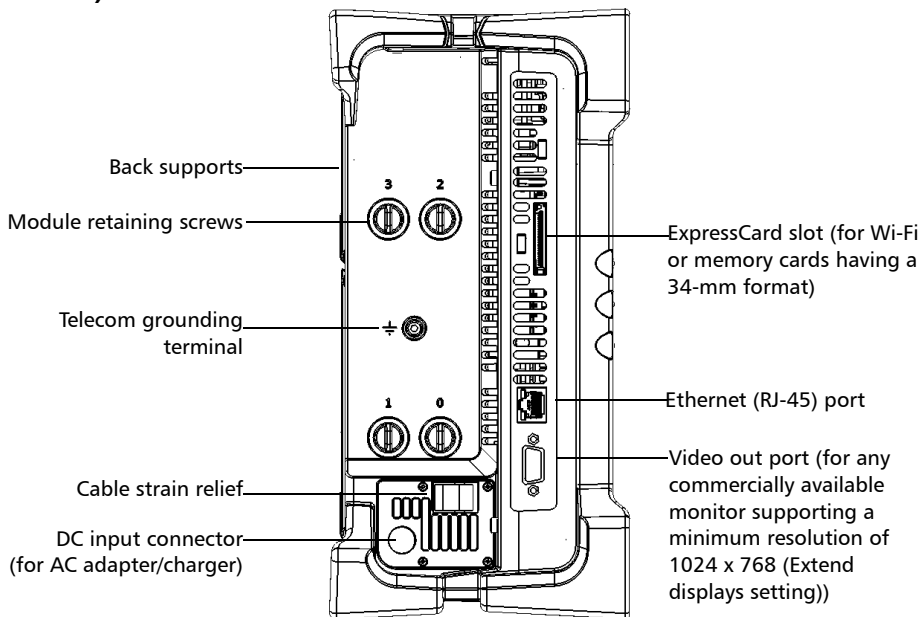

Introducing the FTB-500

Main Features

Left side (Eight-slot model)

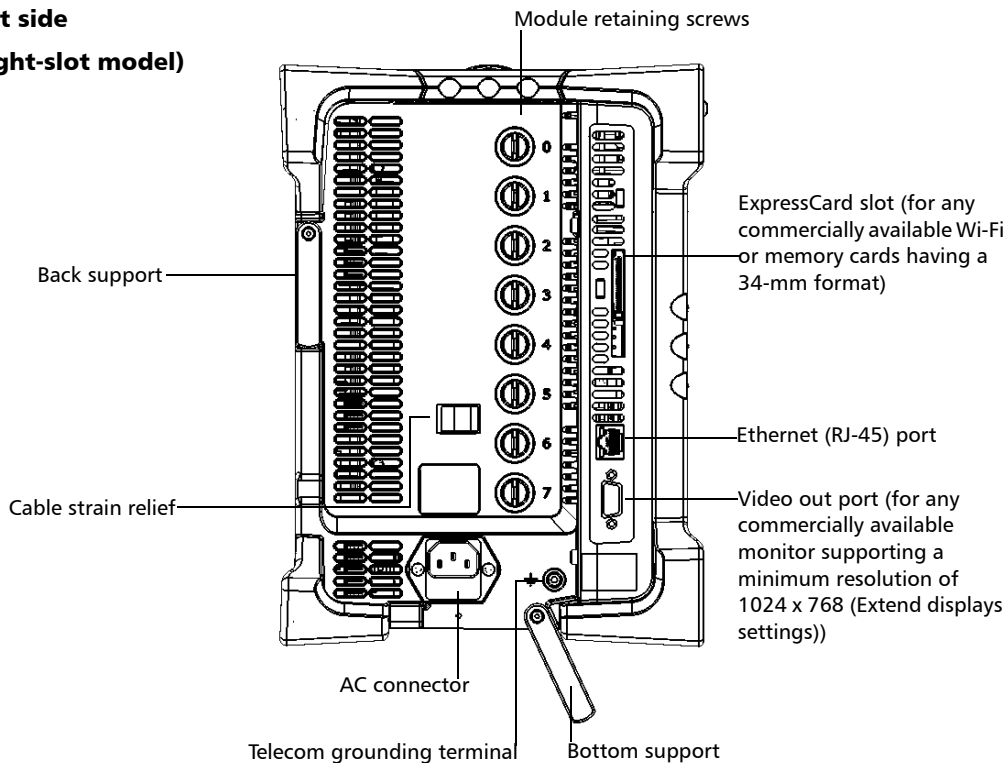

The FTB-500 runs Microsoft Windows 8.1 Pro, and the ToolBox software provides you with a graphical, user-friendly interface for your testing applications.

The interface is easy to access, whether you are using the touchscreen or a mouse and a keyboard.

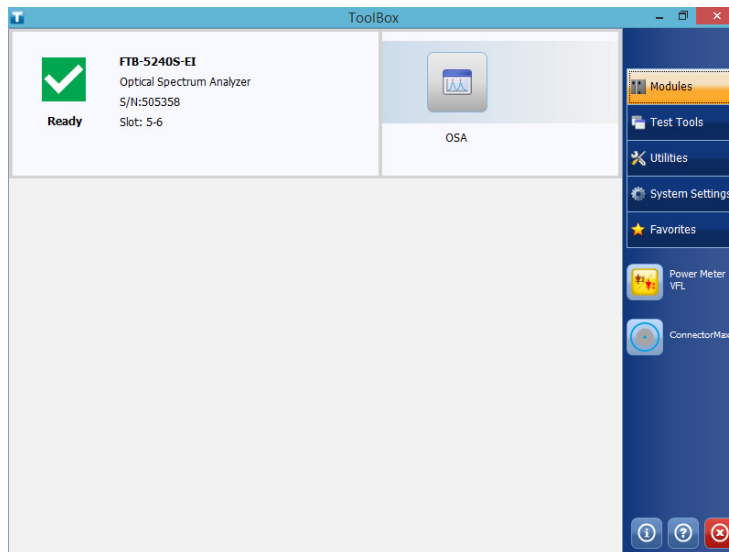

ToolBox brings multitasking to field testing. You can perform different tests and work on tests results all at the same time, switching between applications easily.

The FTB-500 supports local control (via the ToolBox software) and remote control (through RS-232 or Ethernet TCP/IP—using SCPI commands or the provided LabVIEW drivers).

Note: *LabVIEW drivers may not be available for some modules.*



Note: *In this documentation, the words “tap” and “double-tap” (related to the use of a touchscreen) replace the words “click” and “double-click”.*





Introducing the FTB-500

LED Indicators Description

LED Indicators Description

The LED panel on the front of the unit provides you with the status of the FTB-500.

LED	Status	Meaning
	Green	Unit is on.
	Green, blinking	Unit is in Sleep mode.
	Off	Unit is off or in Hibernation mode.
 (when unit is connected to an external power source)	Green	All batteries are fully charged.
	Green, blinking	At least one battery is charging.
	Yellow, blinking	No battery present in the unit. OR The unit and its modules would be using more power than what is available from batteries. Do not disconnect AC power while this module is in use. A blinking yellow LED takes precedence over a blinking green one, so when AC power is connected, even if the LED is blinking yellow, batteries are probably charging (depending on conditions).

LED	Status	Meaning
 (when unit is not connected to an external power source)	Off	The global level of the batteries is above the “low-battery threshold”.
	Yellow	The global level of batteries is low.
	Yellow, blinking	The unit and its modules would be using more power than what is available from batteries. Connect AC power as soon as possible.
	Red	Battery error. Contact EXFO.
	Lit	Hard disk read or write operations
	Red, blinking	Laser status LED. At least one module emits an optical signal.
	Off	No modules emit signal.
	Varied	<ul style="list-style-type: none"> ➤ Each application using the alarm LED provides its alarm level to the platform when needed (Red/Yellow/Green/OFF). ➤ If more than one application uses the alarm LED, the LED is displayed using the color of the most severe alarm with red as the most severe, followed by yellow and finally green. ➤ If more than one application uses the alarm LED, the LED is blinking.

Introducing the FTB-500



LED Indicators Description

LED	Status	Meaning
✓/X	Green	Result status from application currently displayed. Pass (result does not exceed the defined threshold).
	Green, blinking	Result statuses from two or more applications. Pass (no results exceed the defined threshold).
	Red	Result status from application currently displayed. Fail (result exceeds the defined threshold).
	Red, blinking	Result statuses from two or more applications. <ul style="list-style-type: none"> ➤ Fail (all results exceed the defined threshold). OR <ul style="list-style-type: none"> ➤ Mixed statuses (some are Pass and some are Fail).
	Green	Unit is controlled remotely.

Function Buttons Description

The FTB-500 is equipped with function buttons that give you access to features at all times.

The table below shows an overview of their purpose.

Button	Purpose
	To show the taskbar, from which you can switch among running applications, select a keyboard, view battery information, view the time and date, etc.
	To set the display brightness level. For more information, see <i>Adjusting Brightness</i> on page 61.
LOCAL	When you are working in remote control mode, to return to local control and settings.

Power Sources

Your unit operates with the following power sources:

- Indoor use only: AC adapter/charger (four-slot model) or standard three-wire power cord (eight-slot model) connected to standard power outlet.

When it is connected to an external power source, the unit will function even if the batteries are not present.

- Indoor and outdoor use: Lithium-ion rechargeable batteries (automatically take over if you disconnect the unit from its external power source). The number of batteries that power your unit and that come with it depends on the model that you have purchased. There are two batteries for the four-slot model, and three batteries for the eight-slot model.
 - Possible to switch from an external power source to battery power or vice versa without affecting operation.
 - The battery recharges automatically when the unit is connected to an external power source (with the AC adapter/charger or the three-wire power cord).

For more information, see *Electrical Safety Information* on page 20.

Automatic Fan Speed Management

The FTB-500 will determine the most appropriate fan speed, depending on the power requirements and the type of modules you are using.



IMPORTANT

Fan speed is always determined to cool down the most heat-generating modules.

If the temperature keeps rising and reaches the limit: your FTB-500 will turn off to protect both the modules and the platform itself.



CAUTION

Make sure to use protective covers over empty slots in your four-slot model to avoid overheating.

Product Registration

You can now register your new EXFO products either online or directly from your unit (if it is connected to the Internet), and benefit from every possible opportunity to optimize their performance. By doing so, you will always be notified of the latest software updates, key product enhancements and up-to-date support information related to your products.

To register your product directly from your unit:

1. Ensure that your unit can access the Internet.
2. From ToolBox, tap **Utilities**, and then **Product Registration**.
3. Follow the on-screen instructions.

To register your product online:

1. Open a Web browser and go to www.exfo.com.
2. Log in to your EXFO account.
3. Tap **Support**.
4. Under **Tools**, tap **Manage My Products**.
5. Tap **Register**.
6. Follow the on-screen instructions.

Technical Specifications

To obtain this product's technical specifications, visit the EXFO Web site at www.exfo.com.

Conventions

Before using the product described in this guide, you should understand the following conventions:



WARNING

Indicates a potentially hazardous situation which, if not avoided, could result in *death or serious injury*. Do not proceed unless you understand and meet the required conditions.



CAUTION

Indicates a potentially hazardous situation which, if not avoided, may result in *minor or moderate injury*. Do not proceed unless you understand and meet the required conditions.



CAUTION

Indicates a potentially hazardous situation which, if not avoided, may result in *component damage*. Do not proceed unless you understand and meet the required conditions.



IMPORTANT

Refers to information about this product you should not overlook.

2 **Safety Information**



WARNING

Do not install or terminate fibers while a light source is active. Never look directly into a live fiber and ensure that your eyes are protected at all times.



WARNING

The use of controls, adjustments and procedures, namely for operation and maintenance, other than those specified herein may result in hazardous radiation exposure or impair the protection provided by this unit.



IMPORTANT

When you see the following symbol on your unit , make sure that you refer to the instructions provided in your user documentation. Ensure that you understand and meet the required conditions before using your product.



IMPORTANT

Other safety instructions relevant for your product are located throughout this documentation, depending on the action to perform. Make sure to read them carefully when they apply to your situation.



CAUTION









When the laser safety light is flashing, at least one module is emitting an optical signal. Please check all modules, as it might not be the one you are currently using.

Safety Information

Other Safety Symbols on Your Unit

Other Safety Symbols on Your Unit

One or more of the following symbols may also appear on your unit.

Symbol	Meaning
	Direct current
	Alternating current
	The unit is equipped with an earth (ground) terminal.
	The unit is equipped with a protective conductor terminal.
	The unit is equipped with a frame or chassis terminal.
	On (Power)
	Off (Power)
 OR 	On/Off (Power)
	Fuse

Laser Safety Information

Units with a Built-In VFL

Your instrument is a Class 3R laser product in compliance with standards IEC 60825-1: 2007 and 21 CFR 1040.10, except for deviations pursuant to Laser Notice No. 50, dated June 24, 2007. Laser radiation is emitted at the output port. It is potentially harmful in direct intrabeam viewing.

The following label(s) indicate that the product contains a Class 3R source:

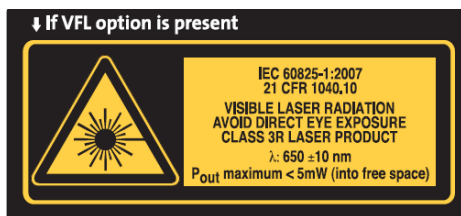

Affixed to back panel of unit.

The modules that you use with your unit may have different laser classes. Refer to the user guide or the online help of the different modules for the exact information.

Units without a Built-In VFL

If your unit is not equipped with a VFL, the laser class of your unit depends on the modules that you use. Refer to the user guide or the online help of the different modules for the exact information.

Safety Information

Electrical Safety Information

Electrical Safety Information

The four-slot model uses an external AC/DC adapter connected to an international safety standard three-wire power cable.

The eight-slot model uses an international safety standard three-wire power cable. This cable serves as a ground when connected to an appropriate AC power outlet.

Note: *If you need to ensure that the unit is completely turned off, disconnect the power cable and remove the batteries.*



WARNING

- ▶ Insert the power cable plug into a power outlet with a protective ground contact. Do not use an extension cord without a protective conductor.
- ▶ Before turning on the unit, connect all grounding terminals and extension cords to a protective ground via a ground socket. Any interruption of the protective grounding is a potential shock hazard and may cause personal injury. Whenever the ground protection is impaired, do not use the unit and secure it against any accidental operation.
- ▶ Do not tamper with the protective ground terminal.

The color coding used in the electric cable depends on the cable. New plugs should meet the local safety requirements and include:

- adequate load-carrying capacity
- ground connection
- cable clamp



WARNING

- Never connect the unit to the AC mains (with the adapter/charger, or directly with a power cord) when it is used outdoors.
- Position the unit so that the air can circulate freely around it.
- Operation of any electrical instrument around flammable gases or fumes constitutes a major safety hazard.
- To avoid electrical shock, do not operate the unit if any part of the outer surface (covers, panels, etc.) is damaged.
- Only authorized personnel should carry out adjustments, maintenance or repair of opened units under voltage. A person qualified in first aid must also be present. Do not replace any components while the power cable and batteries are connected.
- (Eight-slot model only) Use only fuses with the required rated current and specified type (F6.3A L, 5 mm x 20 mm (0.197 in x 0.787 in), fast-acting, low-breaking capacity, 250 V). Do not use repaired fuses or short-circuited fuse holders.
- Unless otherwise specified, all interfaces are intended for connection to Safety Extra Low Voltage (SELV) circuits only.
- Capacitors inside the unit may be charged even if the unit has been disconnected from its electrical supply.

Safety Information

Electrical Safety Information



WARNING

- Use only the listed and certified AC adapter/charger provided by EXFO with your unit (four-slot model). It provides reinforced insulation between primary and secondary, and is suitably rated for the country where the unit is sold.
- Use only accessories (such as the batteries, and fiber inspection probe) designed for your unit and approved by EXFO. For a complete list of accessories available for your unit, refer to its technical specifications.
- When you use the unit outdoors, ensure that it is protected from liquids, dust, direct sunlight, precipitation, and full wind pressure.



CAUTION

The use of voltages higher than those indicated on the label affixed to your unit may damage the unit.



CAUTION

The operation and storage temperatures, as well as the altitude and relative humidity values of some modules may differ from those specified for your platform. In this case, always ensure that you comply with the most restrictive conditions (either module or platform).

3 Getting Started with Your Unit

Grounding Your Unit

When you perform outside plant tests with certain modules, you may want to ground your unit because it can be exposed to overvoltages from the telecommunication network. Refer to the user documentation that comes with your modules to know if you need to ground your unit.



WARNING

- Not grounding your unit when it is recommended may cause serious injuries to communication network staff or other users.
- Ensure to ground the unit using a grounding method that complies with your local regulations. If you are not sure on how to proceed, consult a certified electrician.

Note: *To ground your unit, you need a grounding wire (18 AWG minimum) with a U-shaped terminal.*

Getting Started with Your Unit

Grounding Your Unit

To ground your unit:

1. Position the unit so that you can see its left panel.
2. Place the U-shaped terminal under the grounding stud's screw head.

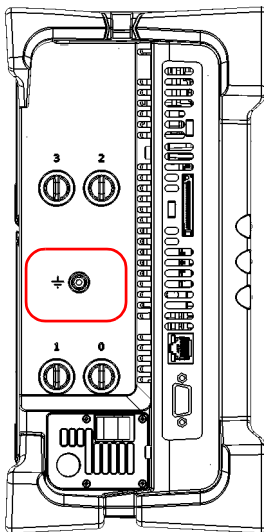

Four-slot model

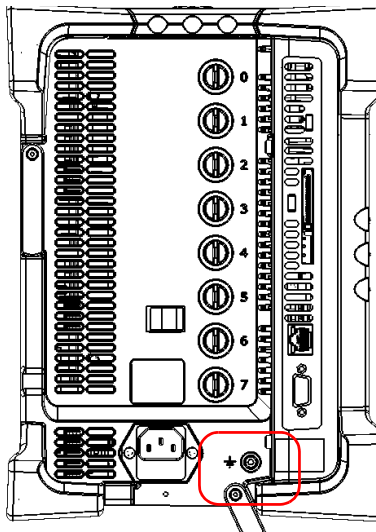

Eight-slot model

3. Turn the grounding stud clockwise to screw it tight.
 4. Ground the other end of the wire as per your local regulation.
- Your unit is now grounded properly.

Positioning Your Unit

You can change the orientation of your unit with the bottom or back supports.

To position the unit using the supports:

Pull out the support pair that will provide you with the best viewing angle according to your situation.

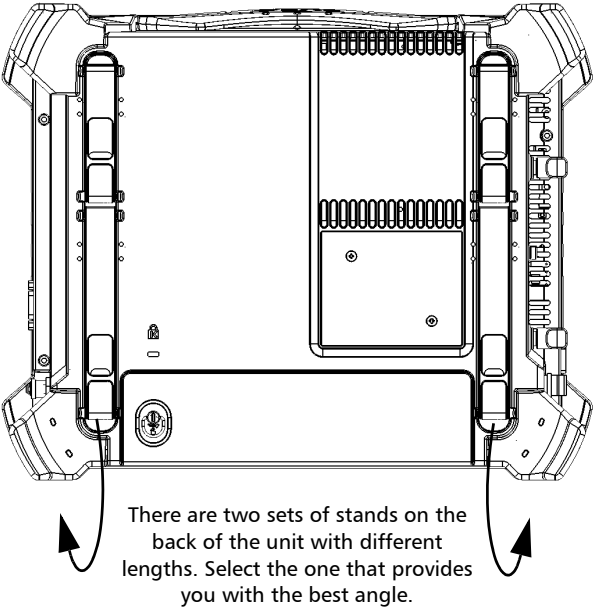

Four-slot model

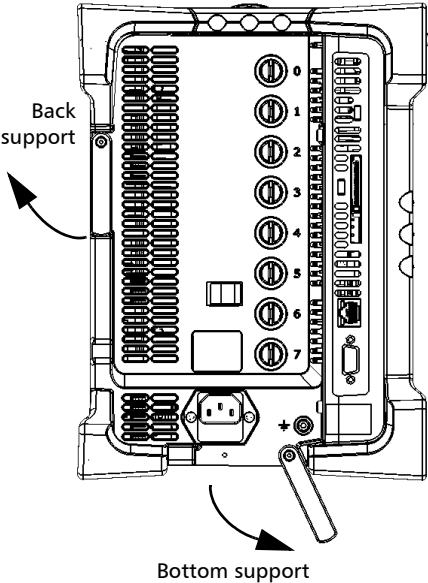

Eight-slot model



IMPORTANT

The supports should always be used in order to ensure that the unit is stable during your tests and will not fall down to cause damage to the test components or injure you.

Inserting and Removing Test Modules



CAUTION

Never insert or remove a module while the FTB-500 is turned on. This will result in immediate and irreparable damage to both the module and unit.



CAUTION

To avoid damaging your unit, use it only with modules approved by EXFO.



WARNING

When the laser safety LED () is flashing on the FTB-500, at least one of your modules is emitting an optical signal. Please check all modules, as it might not be the one you are currently using.

To insert a module into the FTB-500:

1. Exit ToolBox and turn off your unit (shut down, not hibernate or sleep).
2. Position the FTB-500 so that its right panel is facing you.
3. Take the module and place it so that the connector pins are at the back, as explained and shown below.



CAUTION

Inserting a module upside down could result in permanent damage to the module, as the connector pins might be bent.

Getting Started with Your Unit

Inserting and Removing Test Modules

- (4-slot model) identification sticker must be on left side and retaining screw hole *under* connector pins.

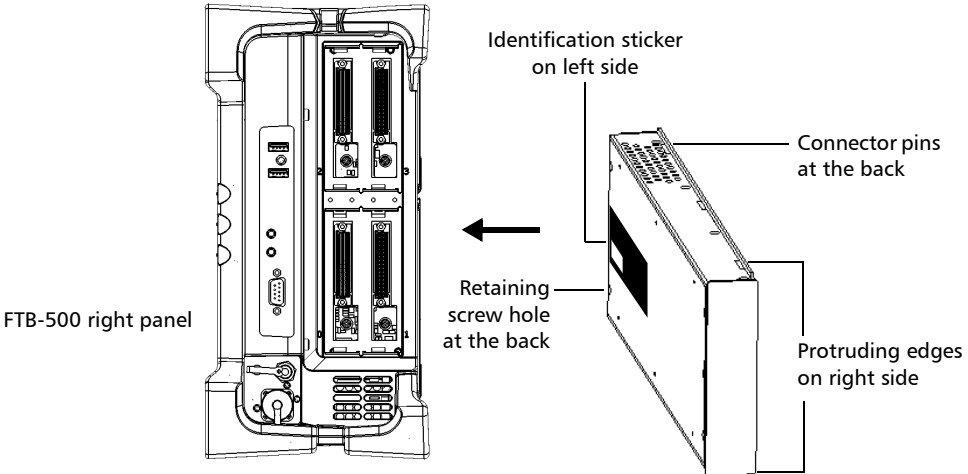

- (eight-slot model) identification sticker must be facing up and connector pins at the right of the retaining screw hole.

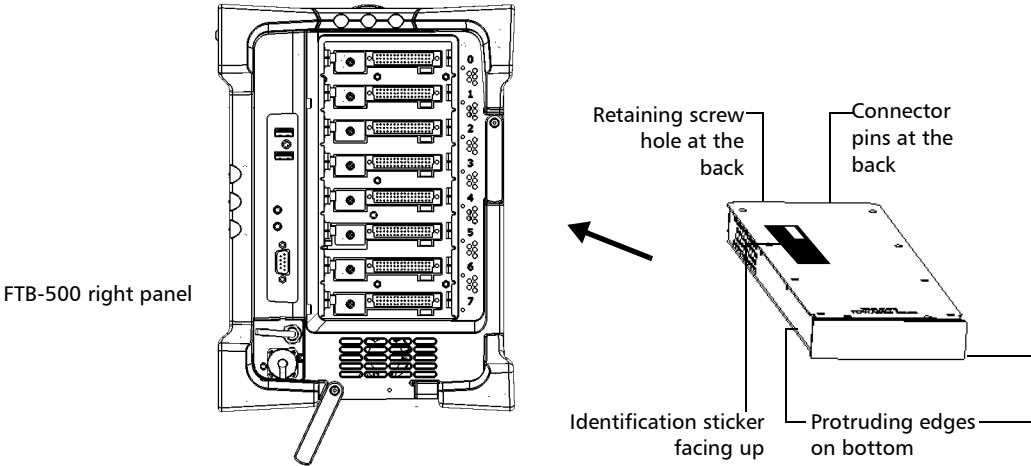

Getting Started with Your Unit

Inserting and Removing Test Modules

Note: If you are using larger or heavier modules, place them near the bottom of the unit as much as possible.

4. Insert the protruding edges of the module into the grooves of the receptacle's module slot.
5. Push the module all the way to the back of the slot, until the retaining screw makes contact with the receptacle casing.
6. Place the unit so that its left panel is facing you.
7. While applying slight pressure to the module, turn the retaining screw clockwise until it is tightened.

This will secure the module into its “seated” position.

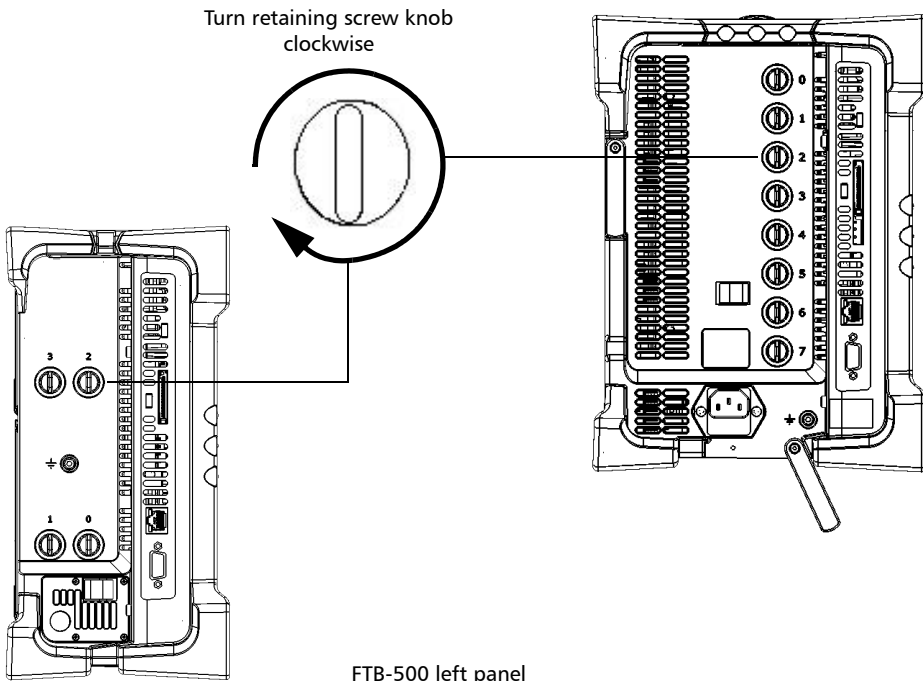

Getting Started with Your Unit

Inserting and Removing Test Modules

- 8. If you are using a larger or heavier module, use a front module lock to hold them securely in place. Simply place the retaining part against the module, then screw in the holding pin.

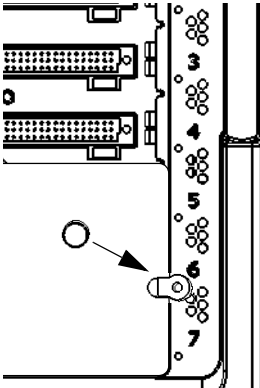

When you turn on the unit, the startup sequence will automatically detect the module.

Getting Started with Your Unit

Inserting and Removing Test Modules

To remove a module from the FTB-500:

1. Exit ToolBox and turn off your unit (shut down, not hibernate or sleep).
2. Position the unit so that the left panel is facing you.
3. Turn the retaining screw counterclockwise until it stops.

The module will be slowly released from the slot.

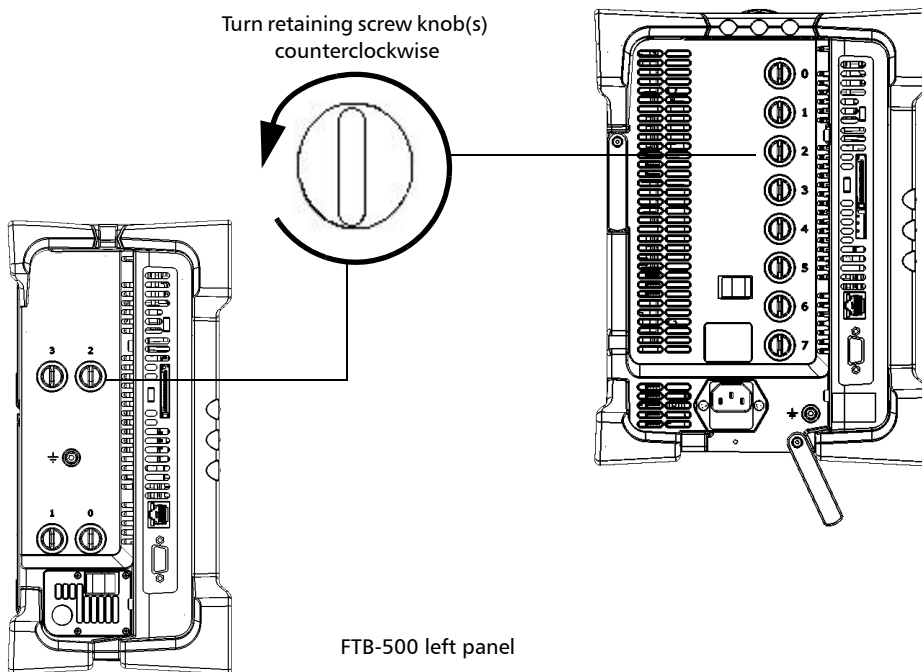

4. Place the unit so that the right panel is facing you.

- 5. Hold the module by its sides or by the handle (*NOT by the connector*) and pull it out.

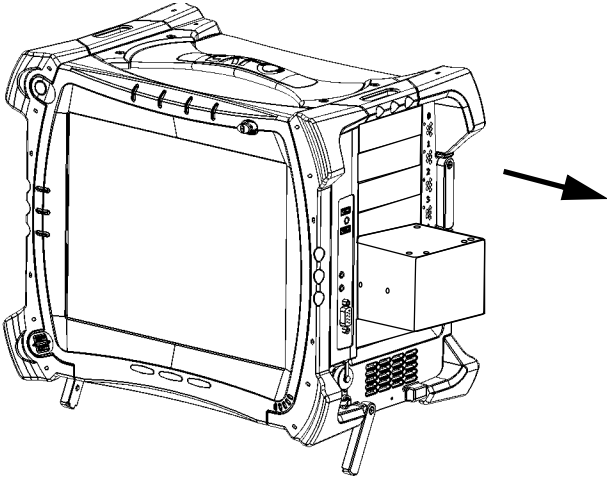

CAUTION

Pulling out a module by a connector could seriously damage both the module and connector. Always pull out a module by its casing.

- 6. Cover empty slots with the supplied protective covers.



CAUTION

Failure to reinstall protective covers over empty slots will result in ventilation problems.

Turning On Your Unit

When you turn on the unit for the very first time, a wizard for license agreements and safety instructions is displayed (see the corresponding section for more information).

Once you have accepted all the license agreements and confirmed the reading of safety instructions, the main window is displayed.

To turn on the unit:

Press the On/Off button. The unit will beep once.

Turning Off Your Unit

There are several ways to turn off the unit, including the following:

- *Sleep*: keeps the unit's status information in memory (RAM). The next time you turn your unit on, you will quickly return to your work environment (running applications will still be running). This mode will take more battery power while the unit is off.
- *Hibernation*: saves the unit's status information that was in memory (RAM) to a special file on the disk. The next time you turn your unit on, this file will be used to ensure that you return to your work environment (running applications will still be running). The unit will take longer to start up than in *Sleep* mode, but it requires less battery power when the unit is off.
- *Shutdown*: the unit will perform a complete restart routine the next time you use it. You should perform a shutdown if you do not intend to use your unit for a week or more.

After a shutdown, the unit will start in Toolbox or in the application you defined as the startup application.

Note: *Should the unit ever stop responding, you can force a hardware reset by pressing and holding down the power button for more than 10 seconds.*

By default, your unit will shut down when you press the power button. However, you can configure your unit to perform a different action when the power button is pressed.

You can also configure your unit to automatically restart when AC power comes back after the unit has turned off (power outage, emergency shutdown, sleep, or hibernation modes) when battery level is too low.



To exit the sleep mode (or hibernation mode) and resume your work:

Press the On/Off button.

To turn off the unit completely from the unit itself:

Press and hold the On/Off button a few seconds until the unit beeps once.

To turn off the unit completely from Windows:

1. If necessary, from the front panel of the unit, press the  button to show the taskbar.
2. From the lower left corner of the screen, tap the **Start** button (.
3. On the upper right corner of the screen, tap .
4. Tap **Shut down**.

Getting Started with Your Unit

Turning Off Your Unit

To define the behavior of the power button:

1. From the main window, tap the **System Settings** button.
2. Tap **Control Panel**.

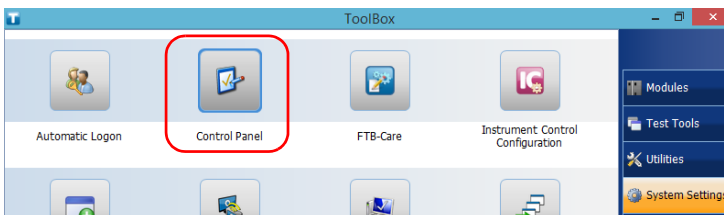

3. Tap **Hardware and Sound**.

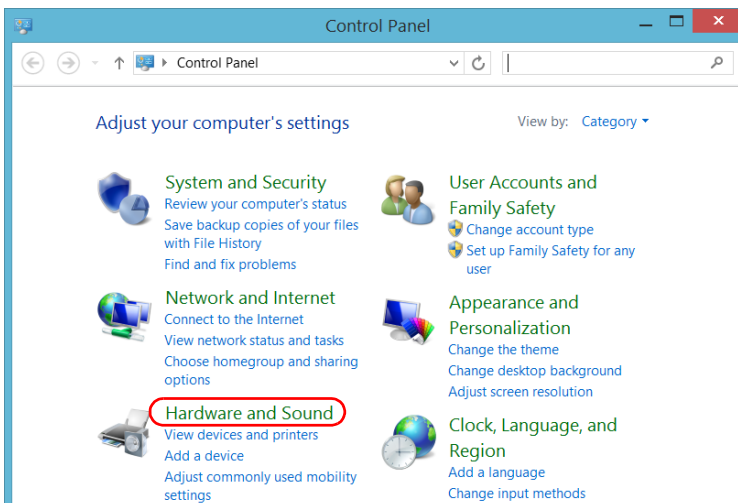

4. Under **Power Options**, tap **Change what the power buttons do**.

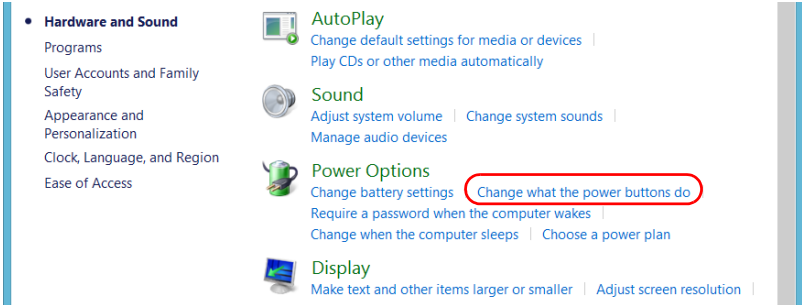

5. Tap **Changes settings that are currently unavailable**.

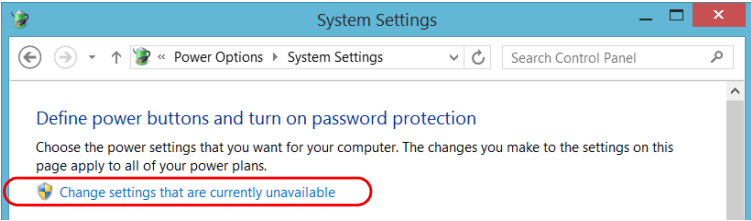

Getting Started with Your Unit

Turning Off Your Unit

- From the **When I press the power button** lists, select the desired behavior when the unit is powered by batteries, or by AC current (**Shut down** option is selected by default in both cases).

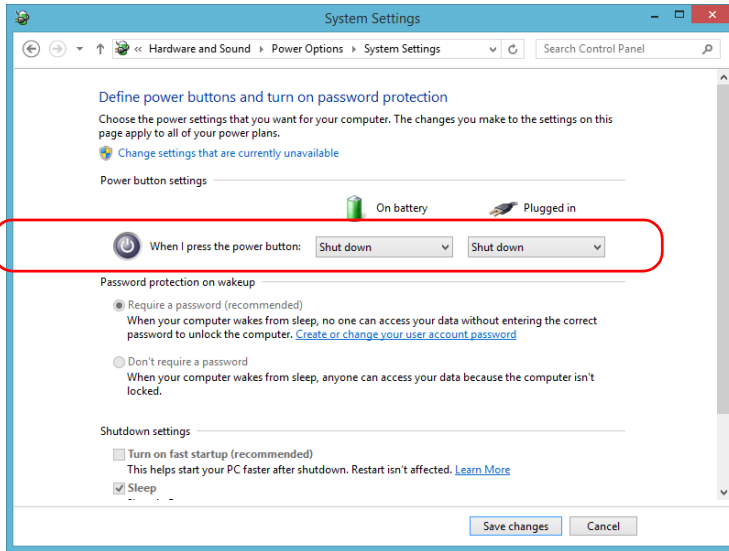

- Tap **Save changes** to confirm the changes and return to the **Power Options** window.

To configure your unit to automatically restart after AC power comes back:

- 1. From the main window, tap the **System Settings** button.
- 2. Tap **ToolBox Setup**.

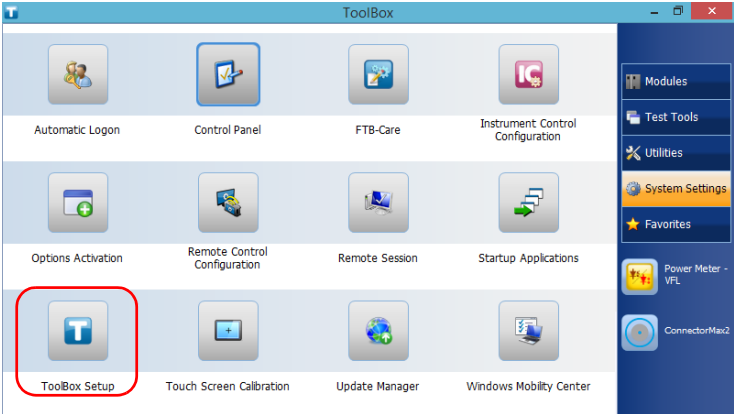

- 3. Select the **Power on the unit when AC outlet is connected or after power outage** box to enable the corresponding option.

OR

Clear the box if you prefer that your unit does not restart automatically after AC power comes back.

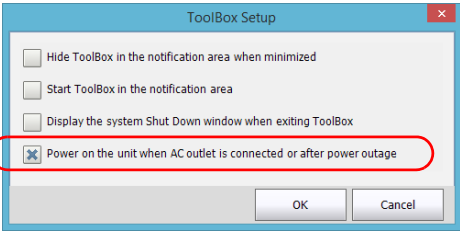

- 4. Tap **OK** to confirm the changes and return to the **System Settings** window.

Configuring Your Unit At First Startup

The first time you turn on the unit, a Windows configuration wizard is displayed, enabling you to set all the regional and language settings such as the country and operation language.



IMPORTANT

The operation language that you select at the first startup (labelled "App language") becomes the default system language, that is the language that will be available at logon.

During the configuration process, you will also be asked to read and accept the Microsoft end-user license agreement (EULA).

Once the configuration is complete in Windows, an EXFO wizard will be displayed, allowing you to read the user documentation for important safety information, and to read and accept the EULA related to your unit and instruments.

Note: *To be able to work with the unit, you must accept all the EULA (from Microsoft and EXFO), and confirm that you have read the security information.*

To configure your unit at first startup:

1. If it is not already done, turn on the unit (see *Turning Off Your Unit* on page 32).
2. When the Windows wizard is displayed, set the parameters according to your needs.
3. Read and accept the Microsoft EULA.
The configuration of Windows parameters may take several minutes.

4. When the EXFO wizard is displayed, follow the on-screen instructions.

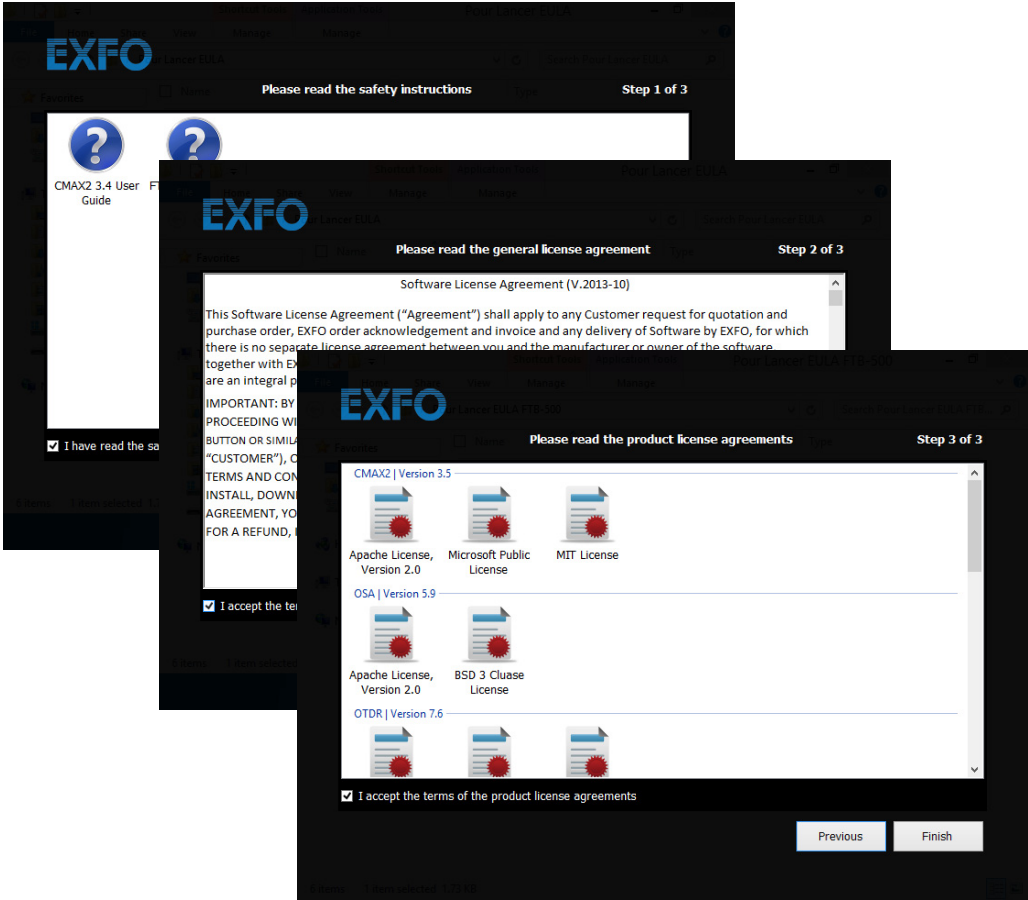

5. Tap **Finish** to close the wizard and start working.

Getting Started with Your Unit

Accessing and Exiting ToolBox

Accessing and Exiting ToolBox

By default, ToolBox is displayed automatically when you turn on the unit.

However, you can configure your unit to send ToolBox to the notification area (see *Setting ToolBox Behavior* on page 105). This could be useful, for example, if you prefer to start working in Windows. You can also configure your unit to start any of the available applications as soon as ToolBox is started (see *Selecting the Startup Applications* on page 79).

To access ToolBox from the Windows environment:

Tap the  icon on your desktop.

Note: *If ToolBox has been sent to the notification area, from this location, right-click the  icon, and then select **Restore ToolBox**.*

To exit ToolBox:

Tap .

Starting Module Applications

Your modules can be configured and controlled from their dedicated applications in Toolbox.

To start a module application:

1. If necessary, tap the **Modules** button to display the modules window.

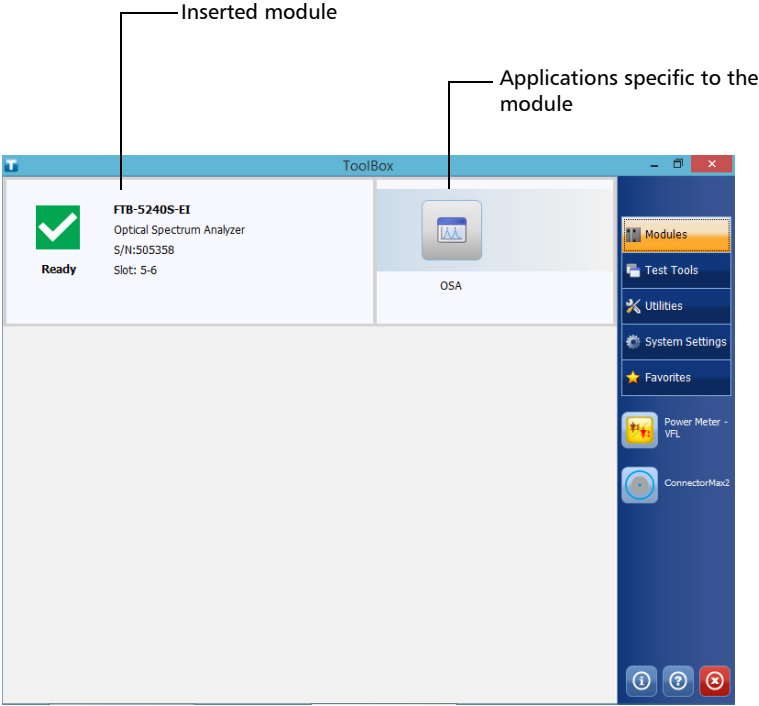

Note: The slot numbers are 0-3 for the four-slot model and 0-7 for the eight-slot model. The slots are identified on both sides of the unit.

2. On the row corresponding to the desired module, tap the icon of the application with which you want to work.

Getting Started with Your Unit

Using the On-Screen (Virtual) Keyboard

Using the On-Screen (Virtual) Keyboard

Whenever you need to enter alphanumeric data, you can use the on-screen keyboard. This keyboard supports multilingual features, and functions according to the keyboard settings set in Windows.

To use the on-screen keyboard:

1. Select the location where you want to enter text.
2. From the taskbar, tap the on-screen keyboard icon (located to the left of the clock).

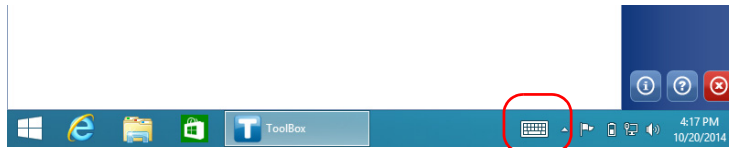

3. Enter the data as required.
4. Close the keyboard when you are done entering data.

Working with Windows 8.1 Pro

If you are not familiar with Windows 8.1 Pro, you may want to visit Microsoft Web site for tutorials as well as detailed information on the features and concepts brought by this operating system.

One of the new features is the use of touchscreen gestures to perform certain tasks. In this documentation, all the necessary gestures are explained throughout the procedures.

Note: *For an optimal accuracy with the touchscreen, use the stylus provided with your unit.*

Note: *To show the taskbar, press the  button from the front panel of the unit.*

Here is an overview of the gestures that you may use the most with your unit.

- Tap and double-tap: Equivalent of a click and double-click with a mouse.
- Swipe right: To return to the last used application. From the left edge of the screen, swipe towards the right.

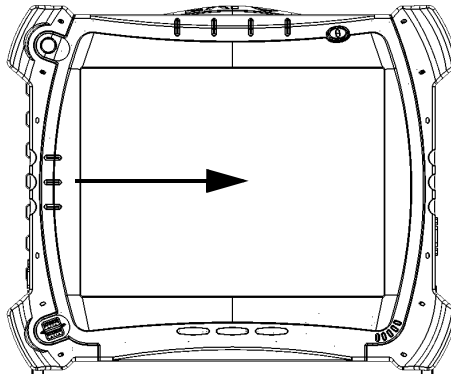

- Swipe left: To display the Charm bar, which is a special toolbar that gives you access to many tools and settings. From the right edge of the screen, swipe towards the left.

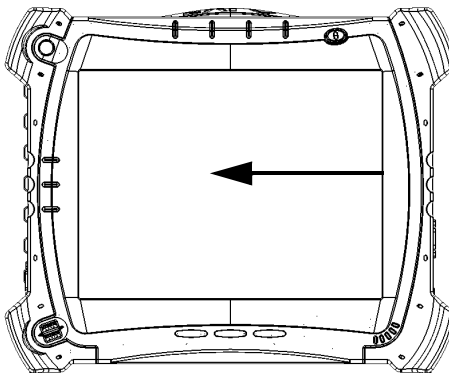

Right-Clicking with the Touchscreen

If you are used to work with a mouse, you may find it useful to be able to perform a right-click on your touchscreen.

This feature is enabled by default, but you can disable it if you prefer. You can also modify the right-click behavior. For more information, see *Customizing the Right-Click Feature* on page 71.

To right-click with the touchscreen:

From the location where you want to right-click, using the stylus or any blunt pointing device, press the screen for a few seconds until the shortcut menu appears.

If you want to hide the shortcut menu without performing any action, simply tap anywhere outside the menu.

Installing or Upgrading the Applications

All the necessary applications have been preinstalled and configured at the factory. However, you may have to upgrade some applications when new versions become available or to reinstall them.

Note: *Only administrator-level users can install software under Windows.*

Each time you purchase a new module, it could be a good idea to verify that the most recent Update Manager application is installed on your unit.

When updates are available for an application, you will need to download them from EXFO Apps, either directly on your unit or on a computer. The update files must be copied to the location that has been specified for the deployment packages in Update Manager.

For the installation or upgrade, you will need:

- your unit
- a computer equipped with a USB port; Windows must be installed on the computer
- a USB memory key

Note: *The computer and USB key are only necessary if you do not wish to download the files directly on your unit.*

Note: *For more information on the installation, refer to the Update Manager online help.*

Getting Started with Your Unit

Installing or Upgrading the Applications

To update or reinstall Update Manager:

- 1.** If necessary, retrieve the desired installation files from EXFO Apps at <http://www.exfo.com/software/exfo-apps>.

If you do not intend to download files directly on your unit, connect a USB memory key to one of the USB ports of the computer and copy the installation files to this USB key.
- 2.** If it is not already done, turn on your unit.
- 3.** Exit Toolbox and the modules' applications.
- 4.** If you want to install Update Manager using the USB key, disconnect it from the computer and connect it to one of the USB ports of your unit.
- 5.** On your unit, create a folder on the Windows desktop.
- 6.** Copy the installation files (from the USB key) to the newly created folder.
- 7.** From the newly created folder, tap the Update Manager setup file to start the installation.
- 8.** Follow the on-screen instructions.
- 9.** When the installation is complete, simply disconnect the USB memory key.

To install or upgrade the applications:

- 1.** If necessary, retrieve the desired installation files from EXFO Apps at <http://www.exfo.com/software/exfo-apps>.

If you do not intend to download files directly on your unit, connect a USB memory key to one of the USB ports of the computer and copy the installation files to this USB key.
- 2.** If it is not already done, turn on your unit.
- 3.** Exit Toolbox and the modules' applications.
- 4.** If you want to install or update applications using the USB key, disconnect it from the computer and connect it to one of the USB ports of your unit.
- 5.** Copy the installation files (from the USB key) to the folder containing the update and installation packages on your unit. By default, Update Manager will search for files in the default folder, which is C:\Users\Public\Documents\SoftwareUpdate. For more information, refer to the Update Manager online help.
- 6.** On your unit, from Windows desktop, tap the **Update Manager** icon to start the corresponding application. For more information on how to install or upgrade applications, refer to the Update Manager online help.
- 7.** When the installation is complete, simply disconnect the USB memory key.

Installing EXFO LabVIEW Drivers

Before being able to work with EXFO LabVIEW drivers, you must install the following elements on your computer or on your FTB-500:

- National Instruments LabVIEW software and the corresponding patches.
- EXFO LabVIEW drivers (including demo applications to help you get started with the drivers).

You can find the LabVIEW drivers on the National Instruments Web Site at www.ni.com.

For more information, see *Working with EXFO LabVIEW Drivers* on page 239.

Note: *Only administrator-level users can install software under Windows.*

Note: *You cannot install LabVIEW software on your unit directly from a CD. You must use a computer to transfer the required files to a USB key first.*

To install the LabVIEW software:



1. If you intend to install the LabVIEW software on your unit, transfer the required files from the LabVIEW CD to a USB key using a computer. If the CD also contains patches, retrieve them on the USB key as well.
2. From your computer, insert the LabVIEW CD in the CD-ROM drive.

OR

From your unit, connect the USB key containing the required files.

3. If necessary, start the installation process manually as follows:

3a. Open the File Explorer ( icon in the taskbar under Windows 8.1 Pro).

Note: To access the File Explorer on your unit, from the front panel, press the  button to show the taskbar. From the lower left corner of the screen, tap the **Start** button () , and then tap the **File Explorer** tile.



3b. Locate the autorun.exe file, then double-click on it to start the installation procedure and follow the on-screen instructions.

You should keep the default names and paths suggested by the installation program.

4. Once the software installation is complete, install the patches available for your LabVIEW version.

If the patches are not included on your LabVIEW CD (or USB key), you may download them from National Instruments' Web site at www.ni.com.

4a. Open the File Explorer ( icon in the taskbar under Windows 8.1 Pro).

Note: To access the File Explorer on your unit, from the front panel, press the  button to show the taskbar. From the lower left corner of the screen, tap the **Start** button () , and then tap the **File Explorer** tile.

4b. Locate the Updates\setup.exe file, then double-click on it to start the installation procedure, and follow the on-screen instructions.

Getting Started with Your Unit

Installing EXFO LabVIEW Drivers

To install the EXFO LabVIEW drivers:



- 1.** If you do not intend to download files directly on your unit, connect a USB memory key to one of the USB ports of the computer and download the drivers from the National Instruments Web site to this USB key.
- 2.** From your unit, connect the USB key containing the required files.

OR

Download the drivers from the National Instruments Web site to a folder of your choice on your unit.

- 3.** Start the installation process as follows:

3a. Open the File Explorer ( icon in the taskbar under Windows 8.1 Pro).

Note: To access the File Explorer on your unit, from the front panel, press the  button to show the taskbar. From the lower left corner of the screen, tap the **Start** button () and then tap the **File Explorer** tile.

3b. Locate the Labview Drivers\setup.exe file, then double-click on it to start the installation procedure and follow the on-screen instructions.

For easier use, the drivers will be installed in LabVIEW's default instrument library folder:

C:\Program Files\National Instruments\LabVIEW 2012\instr.lib.

Activating Software Options

The software options purchased at the same time as your unit have been activated for you already. However, if you purchase options afterwards, you will have to activate them yourself.



IMPORTANT

If you want to activate software options for *modules of the FTB-81xx Series or the FTB-85xx Series*, refer to the user guide of your product for the specific activation instructions.

In all other cases, you can follow the instructions presented in this section.

Before being able to activate options, you need to contact EXFO with the following information:

- Purchase order number of the newly purchased options
- Module or platform serial number (depending on whether the software options were purchased for a module or the platform)
- Customer's name
- Customer's company name
- Customer's phone number
- Customer's e-mail address
- Module or platform on which the option will be installed

You will receive a single key (.key) file with which you will be able to unlock all the new options that you have purchased.

Getting Started with Your Unit

Activating Software Options

To activate software options for your unit or module:

1. From the main window, tap the **System Settings** button, and then tap **Options Activation**.

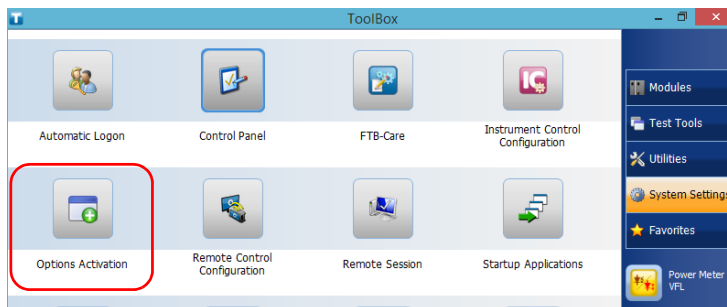

2. When the application prompts you to authorize the changes to your unit (identified as "computer"), tap **Yes**.

3. Tap the **Platform Options** tab or the **Module Options** tab, depending on the type of options that you want to activate.

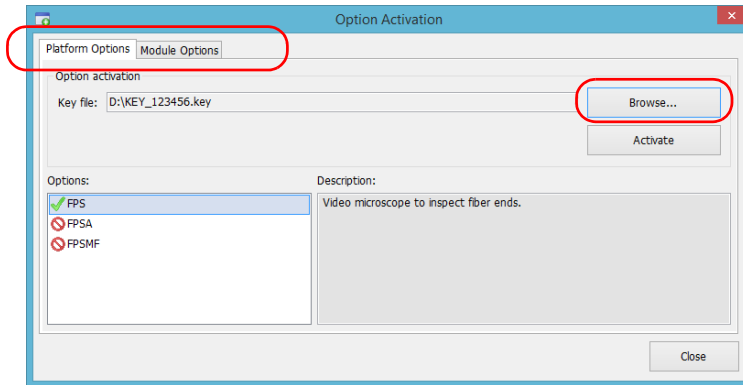

4. Use the **Browse** button to locate the key file that you want to use.
5. Tap **Activate**.

The option indicator will turn into a green check mark to confirm that the option is now active.

Note: You can see the supported options in the **Options** list.

6. Tap **OK** to close the confirmation message, and then **Close** to exit.

Note: At this point, if you have used a USB key to copy your key file, you can remove it as it is not required to use your new options.

Getting Started with Your Unit

Installing Third-Party Software on Your Unit

Installing Third-Party Software on Your Unit

Since your unit is equipped as a conventional computer would be, you can install third-party software on it, as long as it is compatible with Microsoft Windows 8.1 Pro.



IMPORTANT

EXFO does not provide any support for the installation, use or troubleshooting of third-party software. Should you need help, refer to the corresponding third-party software documentation or technical support.

Protecting your Unit with an Antivirus Software

By default, your unit is protected with the Windows Defender antivirus software. However, you can apply your own security standards and antivirus strategy.

Securing your Unit Using the Kensington Lock

Your unit is equipped with a security slot to which you can connect an optional Kensington lock (security cable) to help prevent theft.

To secure your unit:

Connect your lock to the security slot located at the back of your unit.

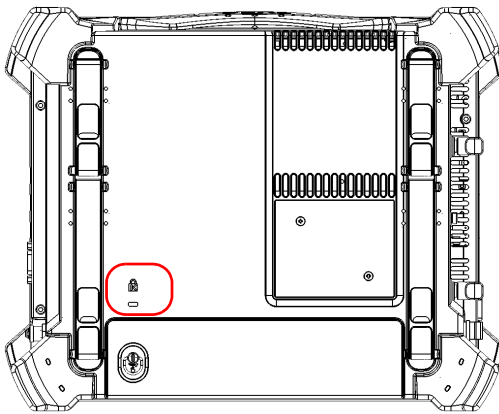

Four-slot model

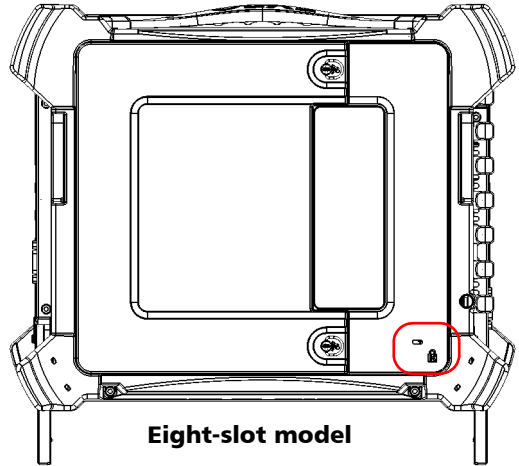

Eight-slot model

Using a Keyboard, Mouse or Other USB Devices

Your unit supports many USB devices. The table below gives an overview of the supported USB devices.

Device	Details
Memory key	For data transfer between your unit and a computer when you do not have access to a network. If you need information on how to transfer data using a memory key, see <i>Managing Data</i> on page 137.
Keyboard	When you are required to enter alphanumeric data, an on-screen (virtual) keyboard is displayed. However, if you prefer, you can use a hardware keyboard.
Mouse	If you prefer to use a mouse instead of the touchscreen, you can connect one.
Composite device	You can use composite devices, that is devices that input information to your unit using more than one mean (for example, combinations of keyboard and mouse).
Hub	This device will be particularly useful to you if you need extra USB ports.
Printer	To print documents such as reports directly from you unit. If you prefer to use a network printer, you can also configure one. For more information, see <i>Configuring Network Printers</i> on page 81.

Getting Started with Your Unit

Using a Keyboard, Mouse or Other USB Devices

Device	Details
3G USB modem key (purchased from EXFO)	To access the Internet without having to connect to a Wi-Fi or an Ethernet network. For more information, see <i>Accessing the Internet with a 3G USB Modem Key</i> on page 116.
USB to RS-232 adapter (purchased from EXFO)	To be able to transfer data between your unit and a device only equipped with RS-232 (serial) ports. For more information, see <i>Using the USB to RS-232 Adapter</i> on page 148.
GPS USB key (purchased from EXFO)	To be able to know the position of your unit (latitude and longitude coordinates). For more information, see <i>Retrieving the GPS Location of Your Unit</i> on page 120.

You can connect several devices at the same time.

To use a USB device with your unit:

Connect the USB device to any of the USB ports located on the right panel or on the front of the unit (see *Main Features* on page 2).

Note: *It is not necessary to turn off the unit before connecting the USB device. The software will automatically detect its presence.*

Your device is automatically recognized and immediately usable (provided that it uses the drivers already available on your unit).

Configuring an External Monitor

Although your unit is equipped with a touchscreen, you might want to connect an external monitor.

You can configure the external monitor in the Windows Control Panel. In Control Panel, when you select the duplicate displays feature, the resolution of the external monitor is set to 800 x 600 automatically, which corresponds to the default resolution of the touchscreen.

Although the maximum resolution of the touchscreen is 800 x 600, you can select a higher resolution for the external monitor with the extend displays feature. The smallest resolution that you will then be able to select for the external monitor is 1024 x 768.

To configure an external monitor:

1. Connect the external monitor to the Video Out port, located on the left side of the unit.

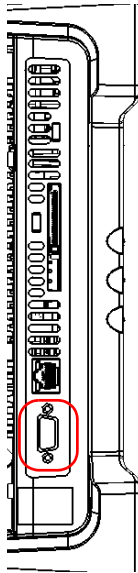

2. From the main window, tap the **System Settings** button.

3. Tap Control Panel.

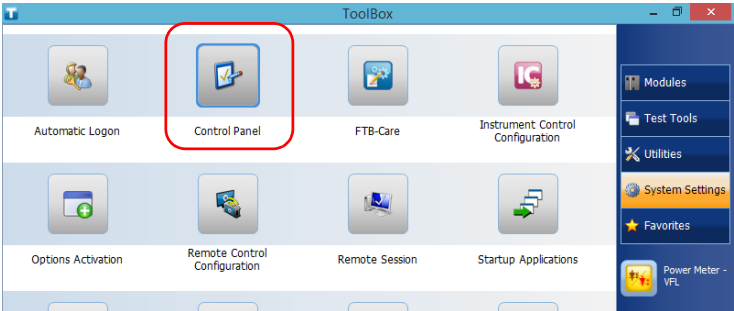

4. Tap Hardware and Sound.

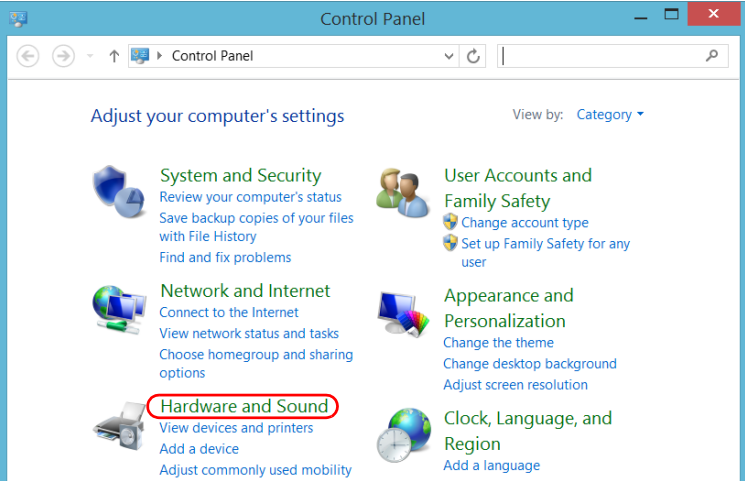

Getting Started with Your Unit

Configuring an External Monitor

5. Under **Display**, tap **Adjust screen resolution**.

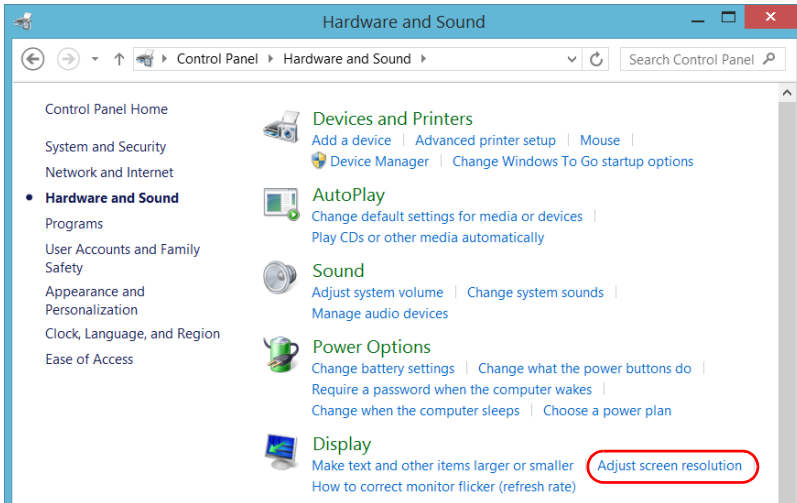

6. Set the parameters according to your needs, and then tap **OK** to confirm.

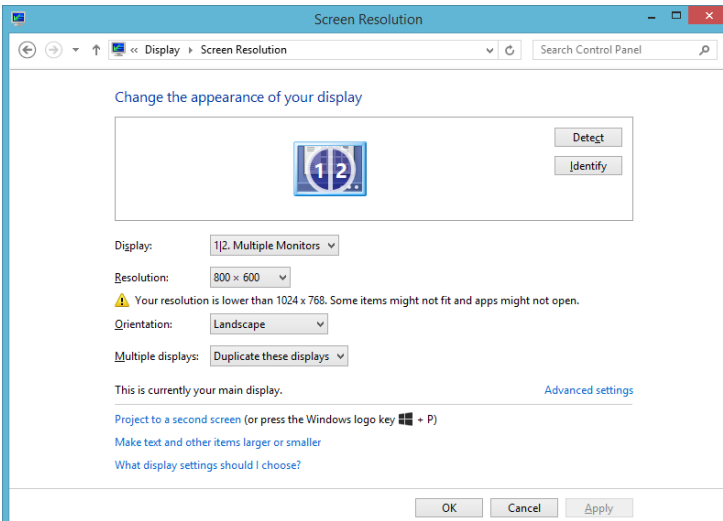

4 **Setting Up Your FTB-500**

Adjusting Brightness

You may want to adjust the screen brightness yourself to better fit your work environment or preferences. Values are kept in memory even when you turn the unit off.

If you want to set the delay after which the display is turned off to save power, see *Configuring the Power Management Options* on page 95.

To adjust the display brightness:

From the unit's front panel, press the  button repeatedly to switch between the available levels.

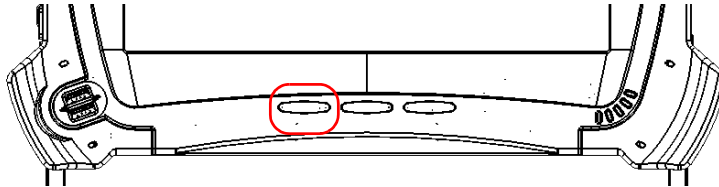

OR

1. From the right side of the screen, swipe left to display the Charm bar.
2. Tap **Settings**, and then the  icon.
3. Move the slider until the screen appearance is to your liking.

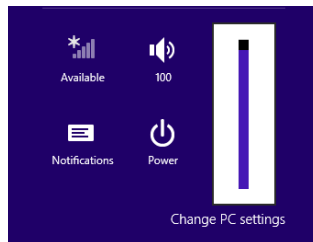

The new brightness value is taken into account immediately.

Setting Up Your FTB-500

Adjusting Microphone and Speaker Volume

Adjusting Microphone and Speaker Volume

Your unit is equipped with a built-in speaker, but you can connect an external speaker if you prefer. You can also connect a microphone or a headset to your unit.

To fit your work environment, you may adjust the microphone as well as the speaker (built-in or external) or headphones volume. Values are kept in memory even when you turn the unit off.

Note: *When you use a headset, ensure that both the microphone and headphones jacks are connected properly to the appropriate audio ports. The control of the volume for the microphone and the headphones of the headset are independent of each other.*

To adjust microphone volume:

1. Ensure that your microphone (or microphone jack if you are using a headset) is connected to the audio in port located on the right panel of the unit.

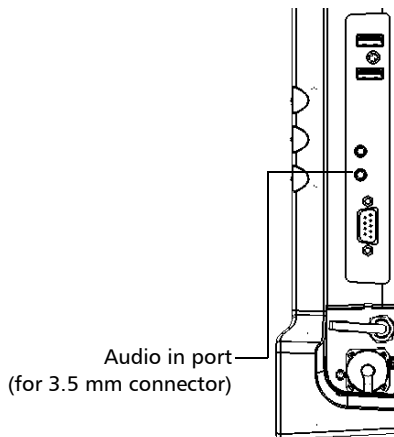

2. From the main window, tap the **System Settings** button.

3. Tap Control Panel.

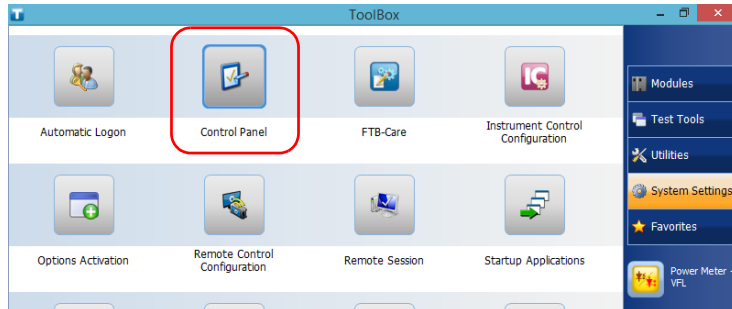

4. Tap Hardware and Sound.

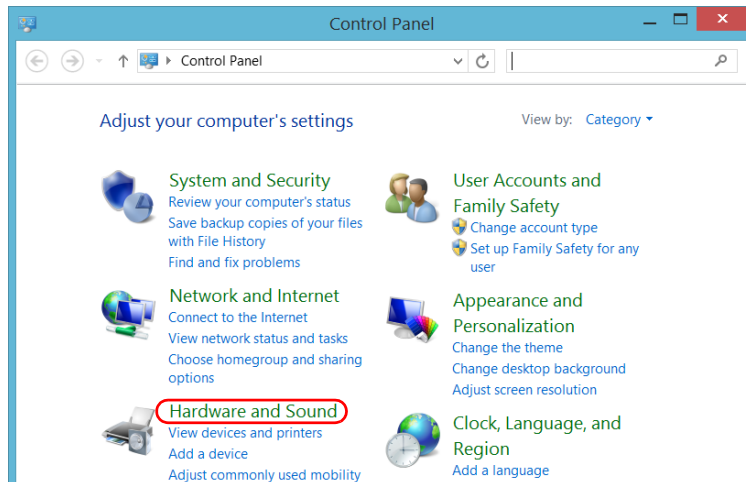

Setting Up Your FTB-500

Adjusting Microphone and Speaker Volume

5. Under **Sound**, tap **Manage audio devices**.

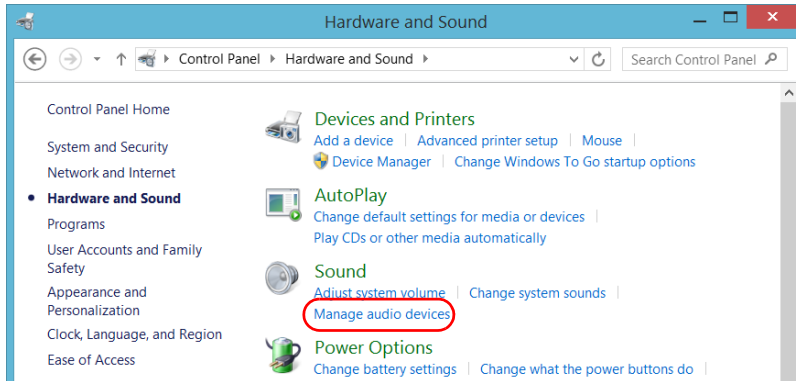

6. Select the **Recording** tab.
7. Ensure that your microphone is selected, and then tap **Properties**.

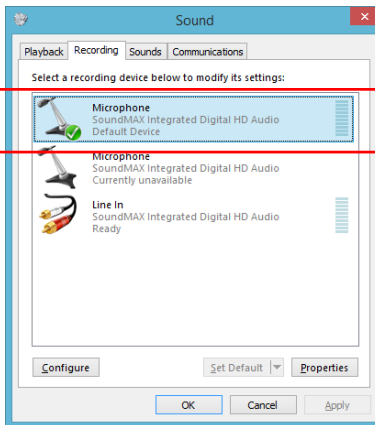

8. If you are using a headset and want to hear your voice through the headphones when you speak in the microphone, from the **Listen** tab, select the **Listen to this device** check box.

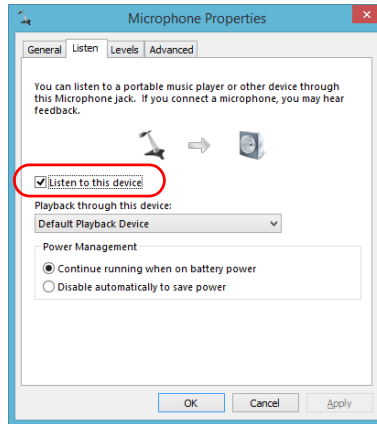

9. From the **Levels** tab, move the sliders until the settings are to your liking. If the sound coming from your microphone is too low, you may want to adjust the boost level as well.

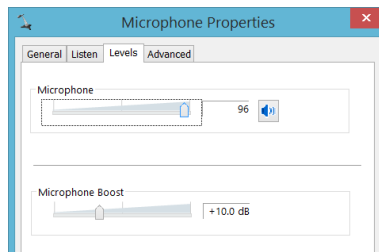

10. Tap **OK** to confirm your new settings and close the window.
11. Tap **OK** to close the window and return to Control Panel.

Setting Up Your FTB-500

Adjusting Microphone and Speaker Volume

To adjust speaker (or headphones) volume:

1. If necessary, ensure that the external speaker (or headphone jack if you are using a headset) is connected to the audio out port located on the right panel of the unit.

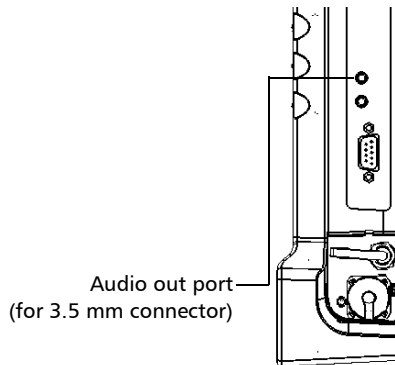

2. From the right side of the screen, swipe left to display the Charm bar.
3. Tap **Settings**, and then the  icon.
4. Move the slider until the sound level is to your liking.

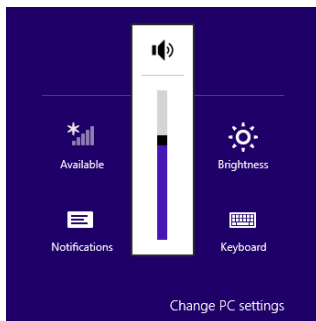

Note: You can also access the sound level slider by tapping the  icon from the taskbar.

The new value is taken into account immediately.

Recalibrating the Touchscreen

If you notice the touchscreen does not behave in the way it used to (for example, it is now difficult to select items) it probably needs a recalibration. You can perform a 4-point, 9-point (linearization), 16-point (linearization), or even a 25-point (linearization) calibration. You can perform a 25-point linearization when you need more accuracy on screen edges and corners.

You can stop the calibration process at any time, but the touchscreen will still need calibration. The parameters are taken into account only when the process is complete.

Note: *If you have trouble accessing the touchscreen calibration feature because the touchscreen is not behaving as expected, you can connect a USB mouse.*



IMPORTANT

To get the optimum performance out of your touchscreen:

- Always use the calibration tool provided with ToolBox (not the tool provided with Windows).
- Be as accurate as possible when you press the center of the targets that appear during touchscreen calibration. This will ensure a greater accuracy of the touchscreen, especially along the edges and in corners.
- Do not change the default resolution of the touchscreen (800 x 600). Doing so will affect its performance and accuracy.

Setting Up Your FTB-500

Recalibrating the Touchscreen

To recalibrate the touchscreen:

- 1.** From the main window, tap the **System Settings** button.
- 2.** Tap **Touch Screen Calibration**.

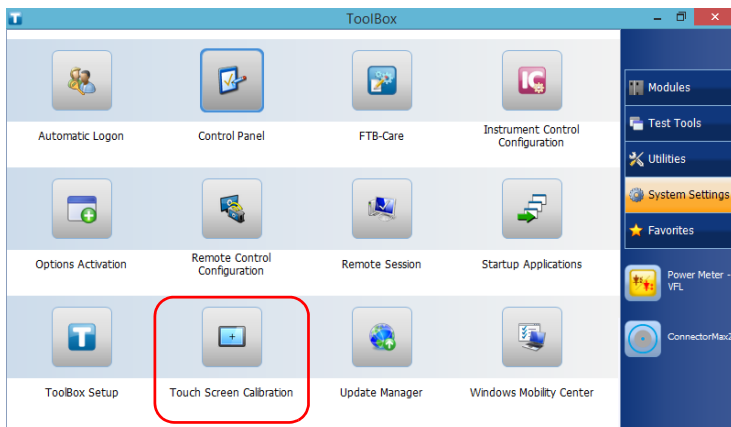

3. From the **Device** tab, select **PenMount 6000 USB**, and then tap **Configure**.

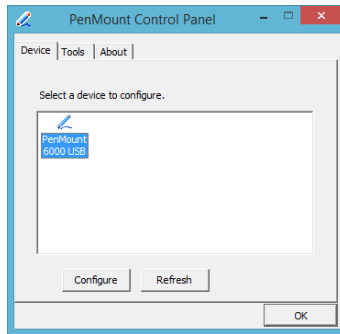

4. For a 4-point calibration, tap the **Standard Calibration** button.

OR

For a linearization, select the number of points, and then tap **Advanced Calibration**.

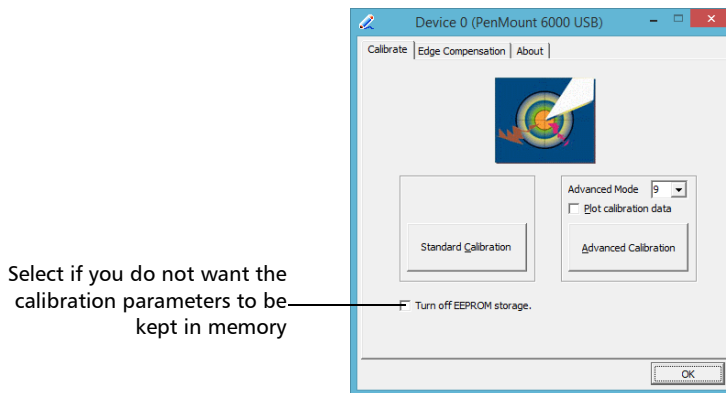

Note: For the advanced calibration, if you wish to view a grid showing the difference in linearity before and after the operation, select the **Plot calibration data** check box. The previous values are represented with navy blue lines and the new ones with black lines.

Setting Up Your FTB-500

Recalibrating the Touchscreen

- Using the stylus (or any blunt pointing device), simply press the center of the different targets that appear on the screen. Keep pressing until the application displays **Lift off to proceed** to indicate that the new parameters have been taken into account.

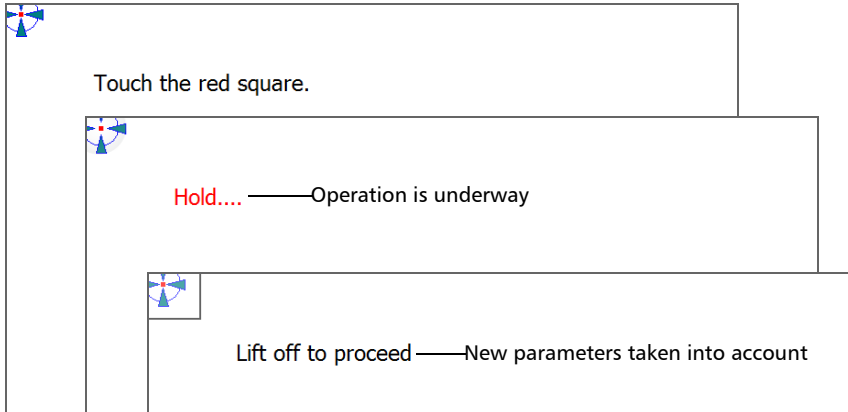

Note: *If you want to stop the calibration process, stop pressing the screen. The application will close automatically after a few seconds and you will return to the touchscreen calibration tool window.*

When the number of calibration points is reached, the application will display a message indicating that the calibration is in progress.

- When the application prompts you, press the center of a last target to complete the calibration operation. Once it is done, you return to the touchscreen calibration tool window automatically.
- Tap **OK** to close the window. Tap **OK** again to return to the **System Settings** window.

Customizing the Right-Click Feature

By default, you can perform a “press and hold” action which corresponds to right-clicking with your touchscreen (see *Right-Clicking with the Touchscreen* on page 44). However, you can disable this feature if you prefer.

You can also modify the delay before the unit considers that you are right-clicking, as well as the amount of time before displaying the shortcut menu once you have right-clicked.

To customize the right-click feature:

1. From the main window, tap the **System Settings** button.
2. Tap **Control Panel**.

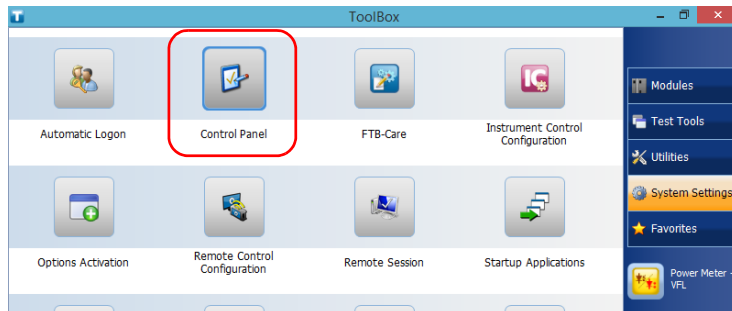

Setting Up Your FTB-500

Customizing the Right-Click Feature

3. Tap **Hardware and Sound**.

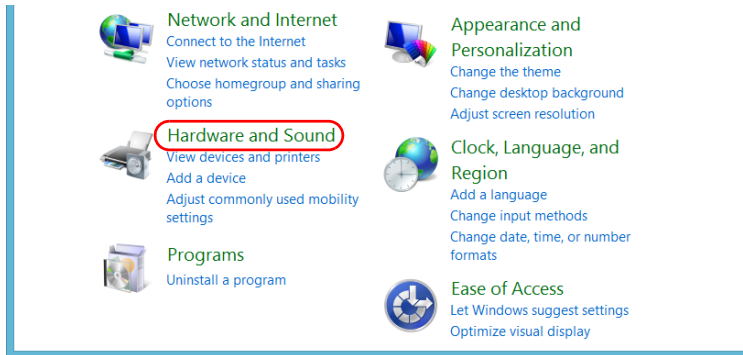

4. Tap **Pen and Touch**.

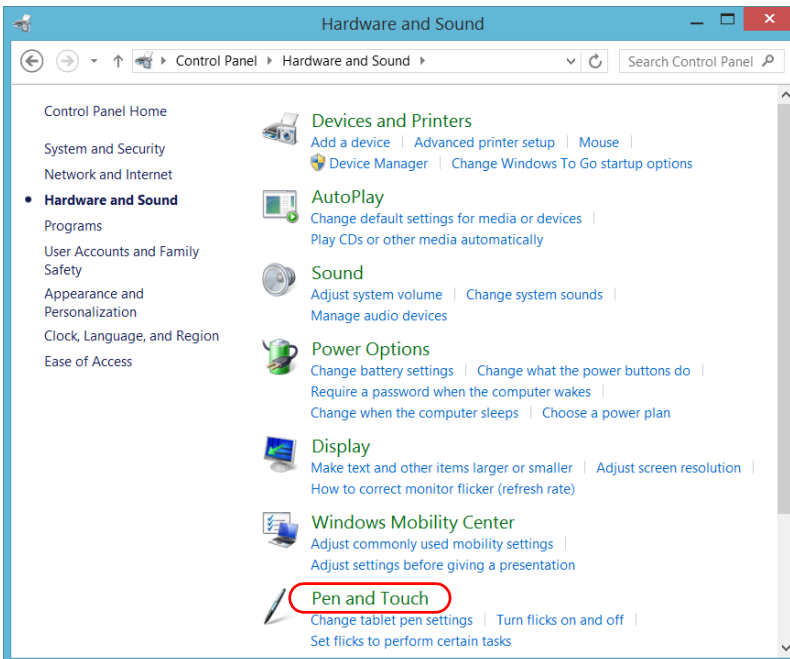

5. From the list, select **Press and hold**.

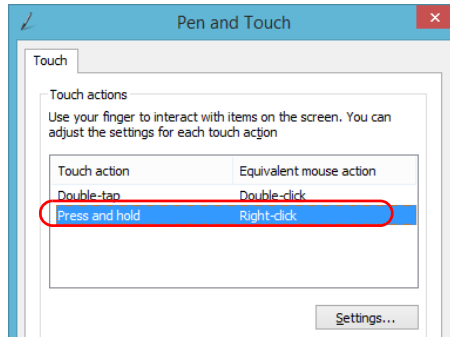

6. Tap **Settings**.
7. If you want to use the right-click feature with your unit, select the **Enable press and hold for right-clicking** check box. Clear the check box if you prefer not to use this feature.

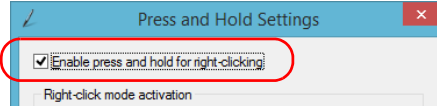

Setting Up Your FTB-500

Customizing the Right-Click Feature

8. If you want to modify the response time of the right-click, move the **Speed** or **Duration** sliders to adjust the configuration to your needs.

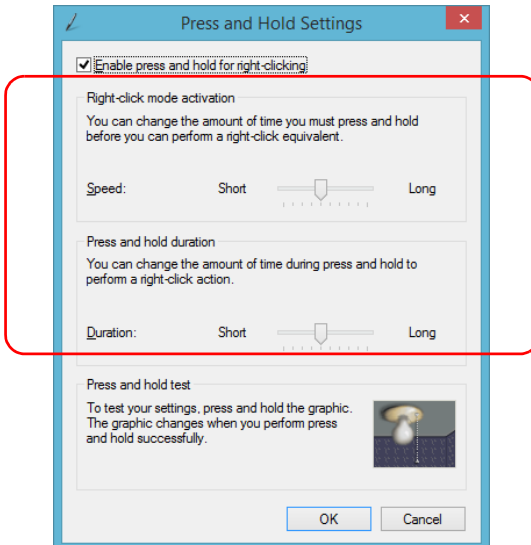

9. Tap **OK** to confirm your changes.

Enabling or Disabling the Automatic Logon

Note: *Only administrator-level users can enable or disable the automatic logon feature.*

You can configure your unit to automatically log on to Windows at startup (no need to select a user and enter a password). You can also disable this feature if you prefer to define separate user accounts with different user access rights and passwords.

Note: *For security reasons, when the unit comes back from sleep mode, the application will prompt you to select a user and enter a password (if you have defined one), even if you have enabled the automatic logon feature.*

Also for security reasons, by default, the automatic logon is not enabled. Once it is enabled, if you want to modify the password of the user account for which the automatic logon is enabled, you will have to disable the feature first, and then enable it again once the new password is defined.

If you want to modify the account used for the automatic logon, you will also have to disable the feature first, and then enable it again for the new account.



IMPORTANT

The user name and password that you specify for the automatic logon must correspond to those of an existing user account.

You can create user accounts or modify passwords from the Accounts window (Charm bar > Settings > Change PC settings > Accounts).

Setting Up Your FTB-500

Enabling or Disabling the Automatic Logon

To enable the automatic logon:

1. From the main window, tap the **System Settings** button.
2. Tap **Automatic Logon**.

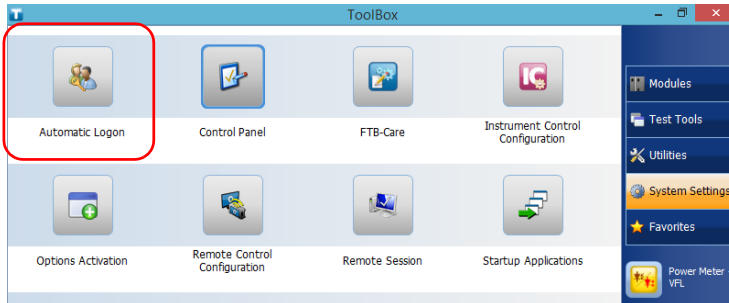

3. From the User Accounts window, clear the **Users must enter a user name and password to use this computer** check box.

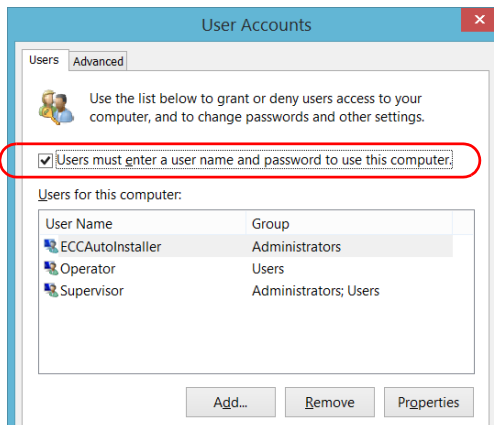

4. Tap **OK** to confirm.

5. Enter the desired user name (account) and the corresponding password.

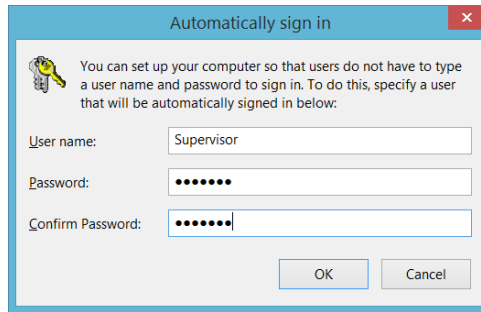

6. Tap **OK** to confirm and to return the **System Settings** window.

At next startup, you will no longer need to specify a user name and password (except if the unit comes back from sleep mode).

To disable the automatic logon:

1. From the main window, tap the **System Settings** button.
2. Tap **Automatic Logon**.

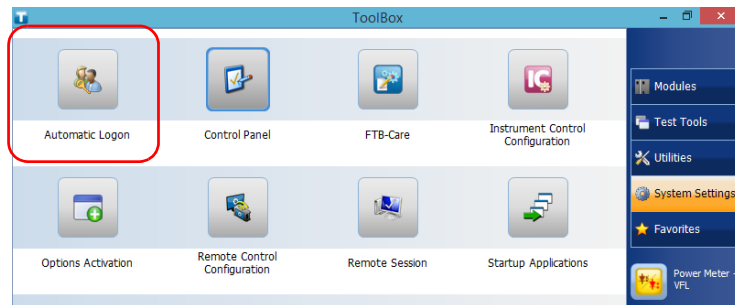

Setting Up Your FTB-500

Enabling or Disabling the Automatic Logon

- From the User Accounts window, select the **Users must enter a user name and password to use this computer** check box.

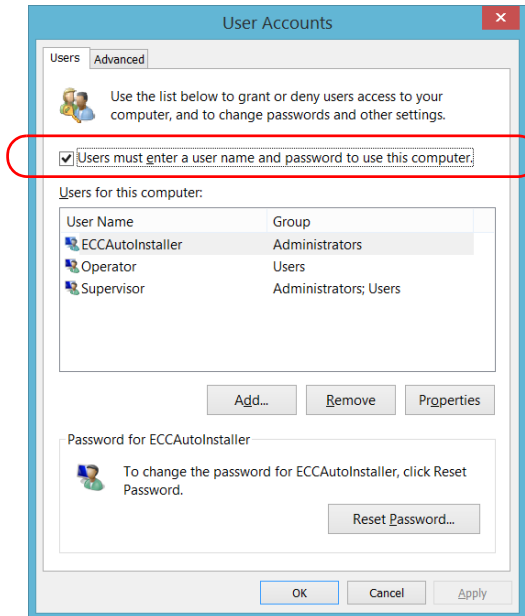

- Tap **OK** to confirm and to return the **System Settings** window.
At next startup, you will have to specify the user name and password.

Selecting the Startup Applications

The first time you start your unit, Toolbox is displayed. You can configure your unit to automatically start any of the available applications as soon as Toolbox is started. This can save you time, as you do not need to ensure that they are already running before starting your tests.

If the required module is not present in the unit, the specified applications will simply not be started. In some cases, you may have to select the applications again the next time the module is inserted into the unit.

To set applications to start automatically at Toolbox startup:

- 1.** From the main window, tap the **System Settings** button.
- 2.** Tap **Startup Applications**.

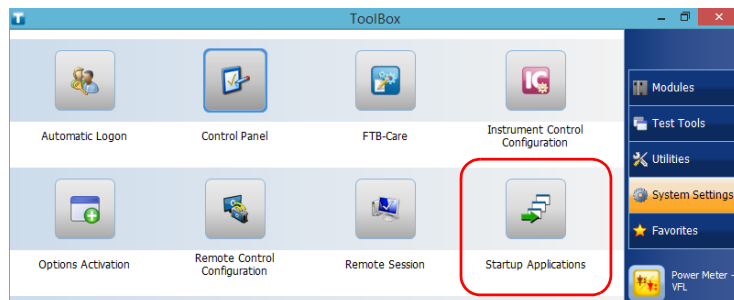

Setting Up Your FTB-500

Selecting the Startup Applications

- Under **Module Applications** or **Other Applications**, select the applications you want to start automatically by selecting the corresponding check boxes.

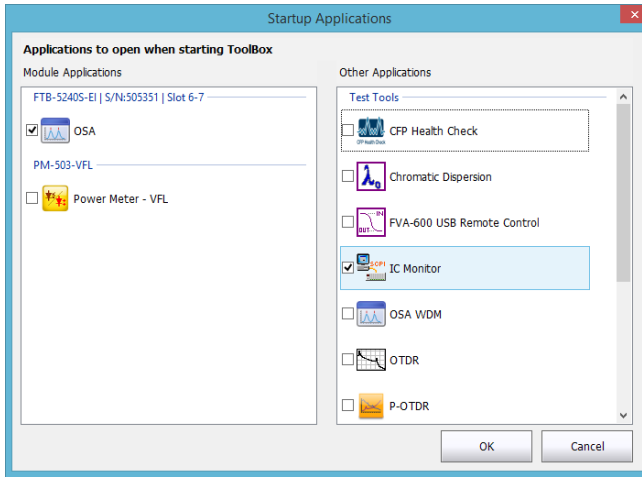

- Tap **OK** to use the new settings. Tap **Cancel** to exit without using the new settings.

Note: *The new settings will be taken into account the next time Toolbox is started.*

Configuring Network Printers

Your unit supports both (local) USB and network printers (you may have to install specific drivers on your unit).

For more information on USB printers connection, see *Using a Keyboard, Mouse or Other USB Devices* on page 56.

To print documents and images on a network printer, you must configure the printer first. You must know the IP address of the network printer that you want to configure, and ensure that your unit is connected to the same network as the printer (either wireless or Ethernet connection). Contact your network administrator for more information on your specific network configuration.

For more information on printing, see *Printing Documents* on page 111.

To configure the printer:

1. From the main window, tap the **System Settings** button.
2. Tap **Control Panel**.

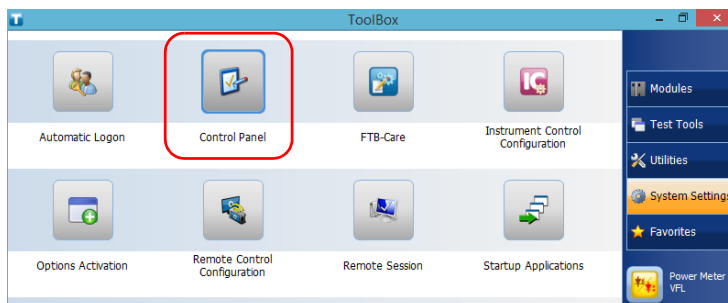

Setting Up Your FTB-500

Configuring Network Printers

3. Under **Hardware and Sound**, tap **View devices and printers**.

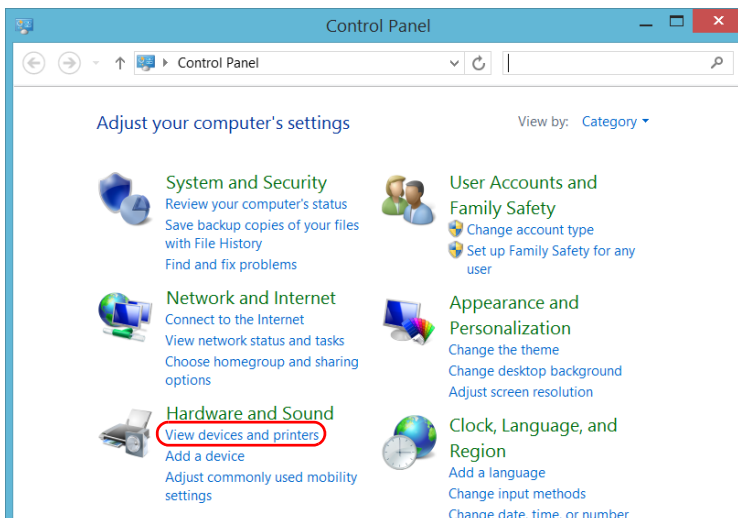

4. Tap **Add a printer**.

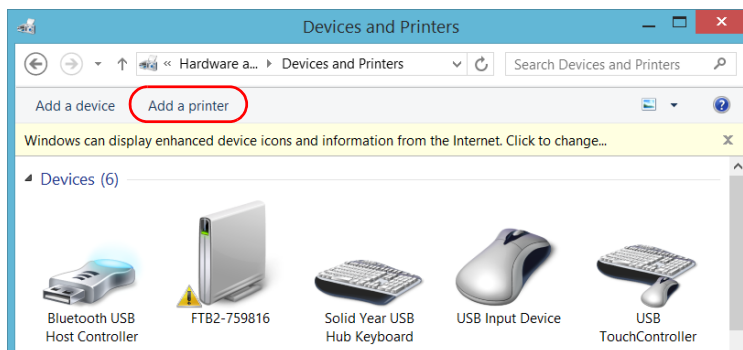

5. Follow the on-screen instructions.

Selecting the Language of Operation

You may display the user interface in one of the available languages.

The availability of the languages is function of the language group that was installed on your unit at time of purchase. It is possible to download language packs from the Microsoft Website to add extra languages if necessary.

The ToolBox application is offered in several languages. This means that if ToolBox supports the language currently selected in Windows, it will automatically be displayed in this language. If the selected language is not supported, the English version will be used.

When you change the interface language, the corresponding keyboard is automatically added to the list of available keyboards. You can then enter text in a specific language (both on-screen or “real” keyboards). Once the keyboards are added, you can switch easily from one input language to another.

Values are kept in memory even when you turn the unit off.

Setting Up Your FTB-500

Selecting the Language of Operation

To select a new interface language:

1. From the main window, tap the **System Settings** button.
2. Tap **Control Panel**.

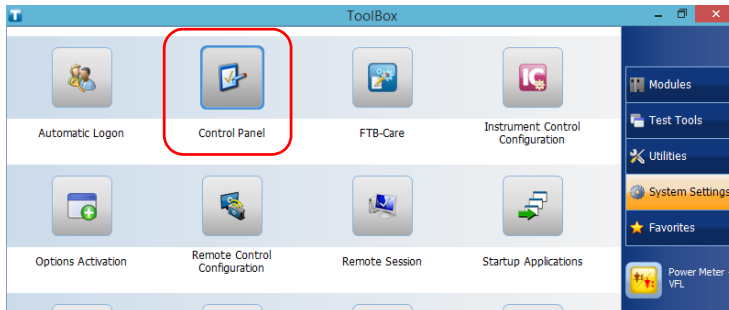

3. Under **Clock, Language, and Region**, tap **Add a language**.

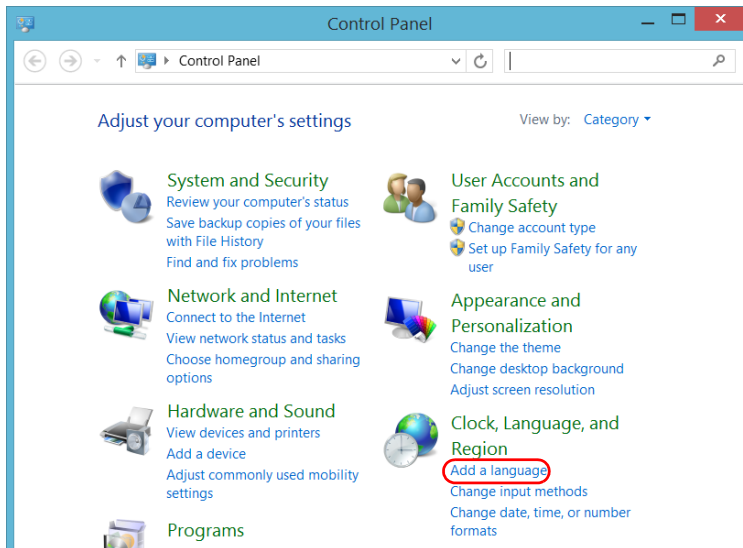

4. Select the desired language from the list.

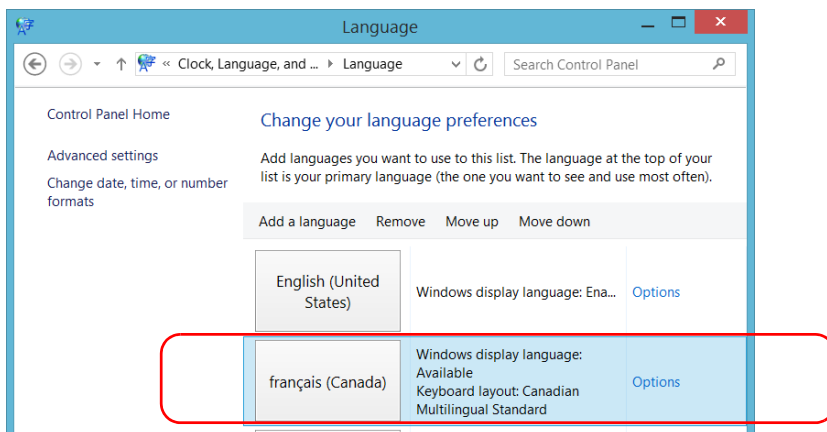

5. Tap **Options**.

Setting Up Your FTB-500

Selecting the Language of Operation

- If you want to select another keyboard layout than the one that has been added by default, proceed as follows.

6a. Under **Input method**, tap **Add an input method**.

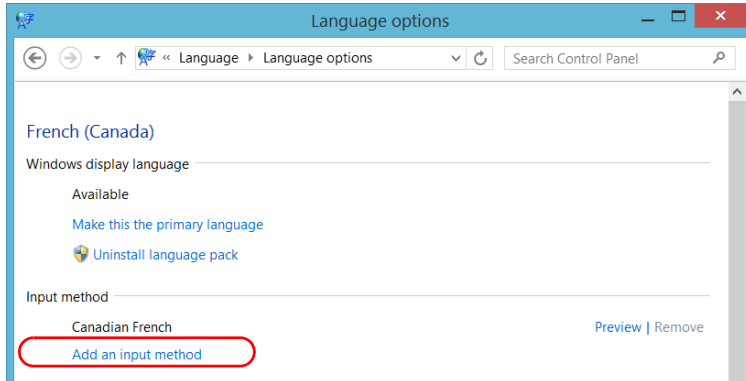

6b. Select the desired keyboard layout, and then tap **Add**.

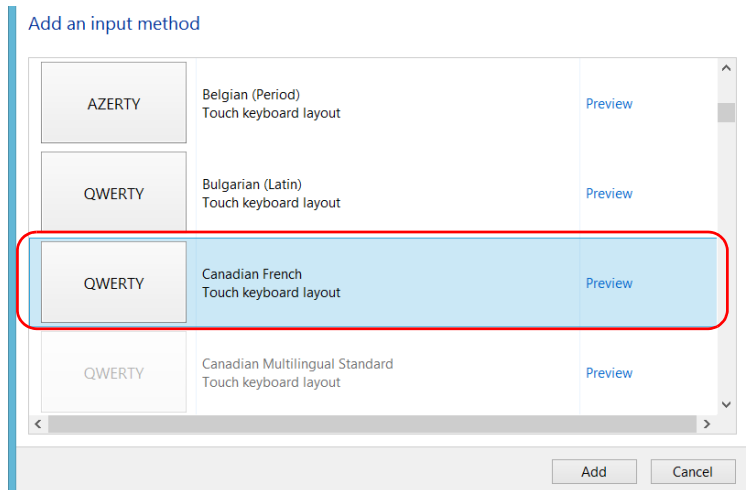

- 7. Under Windows display language, tap **Make this the primary language**.**

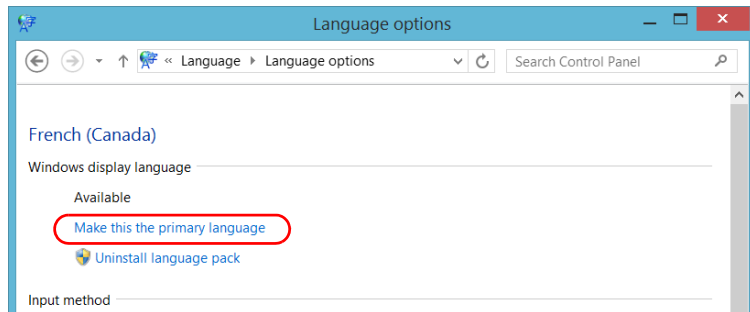

- 8. When the application prompts you to log off, tap **Log off now**.**
- 9. Once you see the lock screen, swipe it down to reveal the user accounts.**
- 10. Log to your user account.**

The new language is now selected and you are able to switch from one input language to another.

Setting Up Your FTB-500

Selecting the Language of Operation

To switch from one of the available input languages to another:

1. If necessary, from the front panel of the unit, press the  button to show the taskbar.
2. From the taskbar, tap the language code to display the list of available input languages.

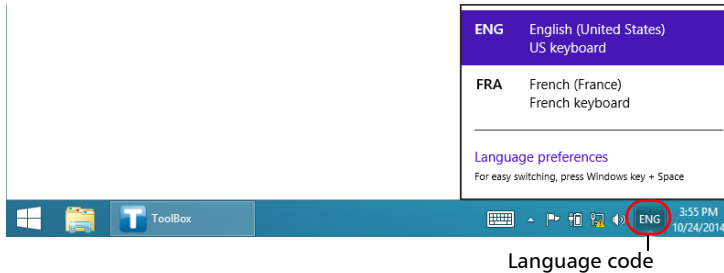

3. From the list of languages, select the desired one.

You are now ready to start entering text in the selected input language.

Note: *Modifying the input language does not modify the language of the interface.*

To download language packs:

1. Ensure that your unit has access to the Internet.
2. From the main window, tap the **System Settings** button.

3. Tap Control Panel.

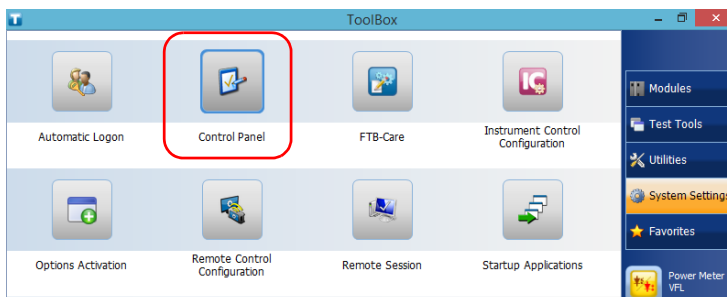

4. Under Clock, Language, and Region, tap Add a language.

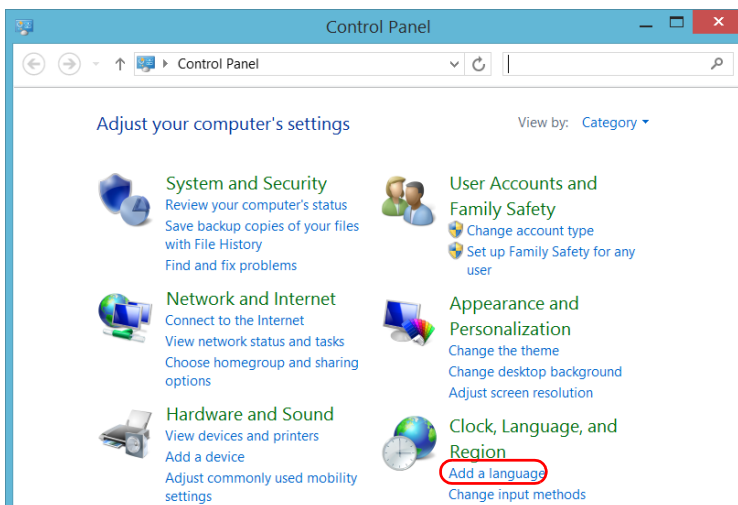

Setting Up Your FTB-500

Selecting the Language of Operation

5. Tap **Add a language**.

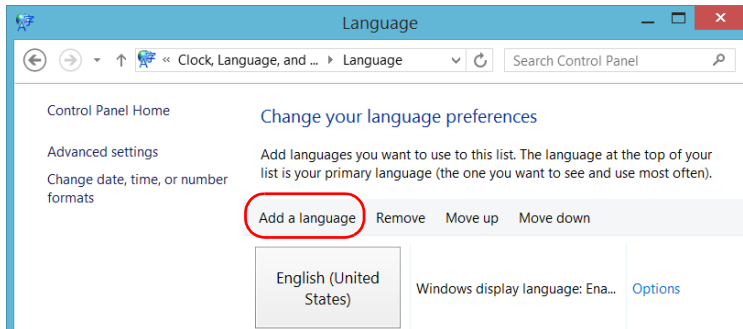

6. Browse the list of languages, and then select the one that you want to use.

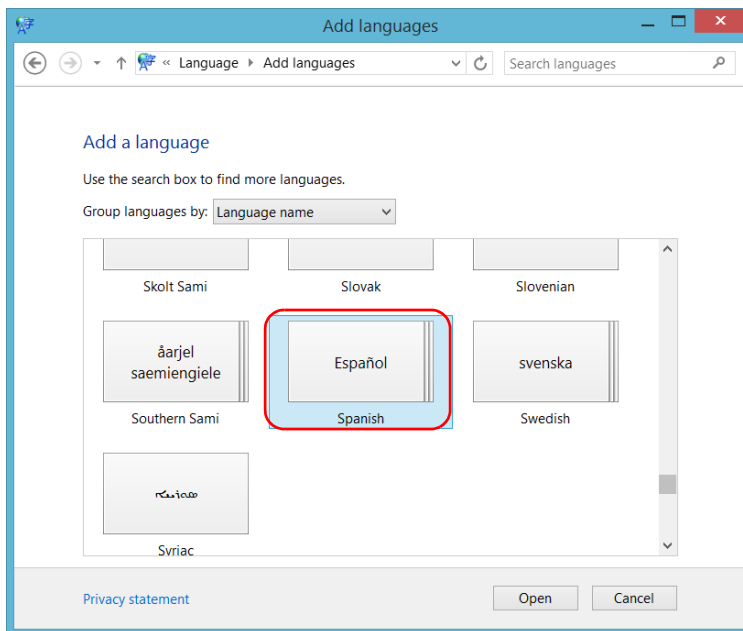

7. Tap **Open** to access the list of sub-languages.

8. Select the desired sub-language, and then tap Add.

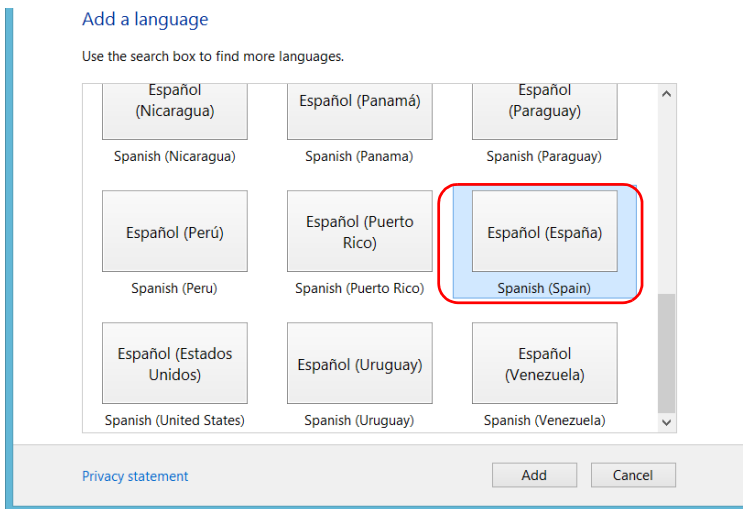

9. Select the desired language from the list.

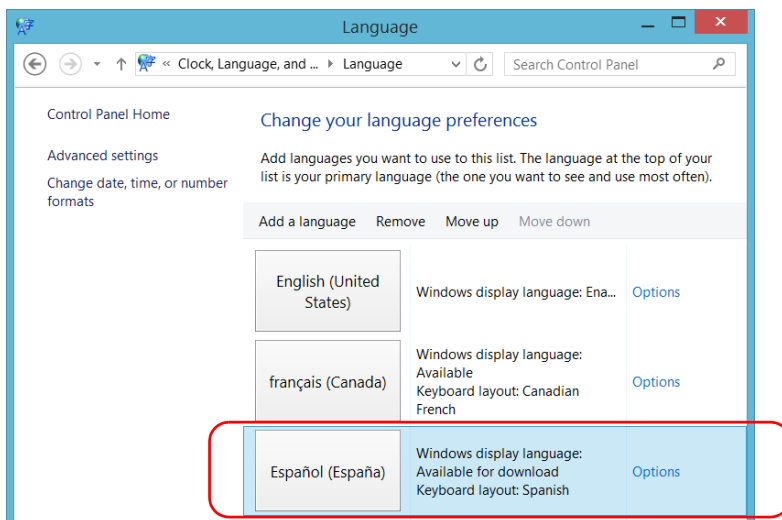

10. Tap Options.

Setting Up Your FTB-500

Setting Date and Time Formats

11. Tap Download and install language pack.

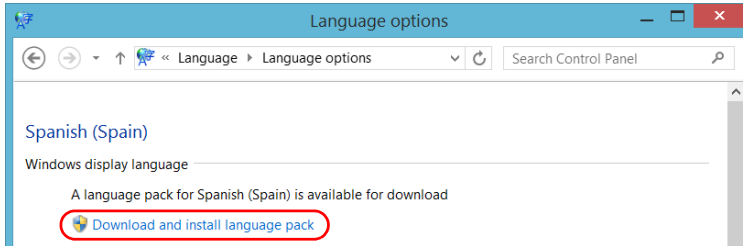

12. When the application prompts you to allow the installation, tap **Yes**. The installation may take a few minutes.

13. When the installation is complete, restart your unit.

Setting Date and Time Formats

By default, the dates (short and long) and time are displayed in the formats associated with the global language format (locale). The time can be expressed with a 12- or a 24-hour notation. You can modify the way dates and time are displayed if the default values do not suit your needs.

For information on how to adjust the date, the time, and the time zone, see *Adjusting the Date, Time and Time Zone* on page 94.

To set date and time formats:

1. From the main window, tap the **System Settings** button.
2. Tap **Control Panel**.

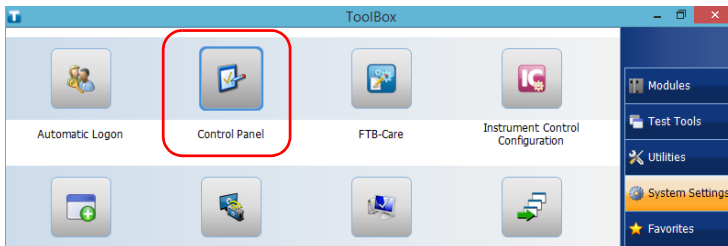

3. Under **Clock, Language, and Region**, tap **Change date, time, or number formats**.

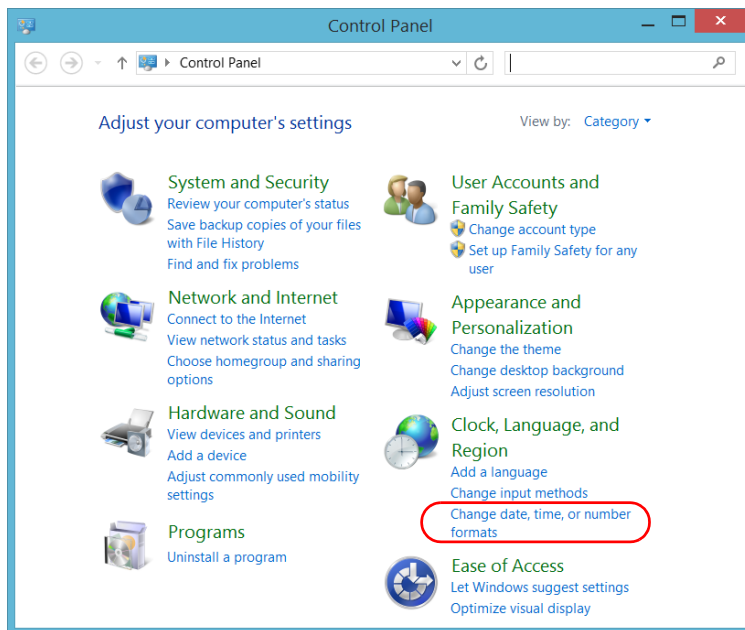

4. Refine the settings according to your needs.
5. Tap **Apply** to confirm, and then **OK** to close the window.

The new values are taken into account immediately.

Setting Up Your FTB-500

Adjusting the Date, Time and Time Zone

Adjusting the Date, Time and Time Zone

Note: Only administrator-level users can adjust the date and time. All users can modify the time zone.

The current date and time are displayed at the bottom of the main window. When saving results, the unit also saves the corresponding date and time.

For information on how to modify the format in which the date and time are displayed, see *Setting Date and Time Formats* on page 92.

To adjust the date, time or time zone:

1. From the main window, tap the date and time displayed in the lower right corner of the screen.
2. Tap **Change date and time settings**.

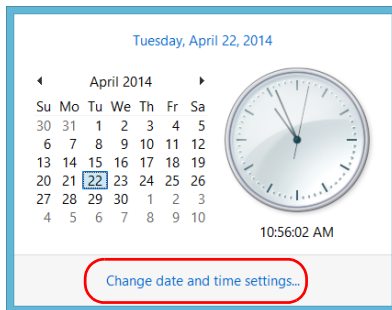

3. Modify the settings according to your needs.
4. Tap **Apply** to confirm, and then **OK** to close the window.

The new values are taken into account immediately.

Configuring the Power Management Options

To help you get the optimum performance out of your unit, it comes with predefined sets of parameters (plans) to manage power.

When you do not use the unit for a while, the display may be turned off to save power. You can also configure the unit to go into sleep mode after the specified duration has expired (see *Turning Off Your Unit* on page 32).

For all of these actions, you can set idle durations for AC adapter/charger and battery operation. The values that you set are kept in memory even when you turn the unit off.

Note: When the backlight is turned off and the  LED is lit and not blinking, the unit operation is not interrupted. Touch anywhere on the screen to return to normal operation.

The table below identifies the predefined power plans.

Power Plan	Characteristics
EXFO - Standard (selected by default)	Allows you to work without interruption (sleep, hibernation), when the unit is connected to AC power, and optimizes the energy consumption when the unit is powered by batteries.
EXFO - Always On	Allows you to work with the unit without interruption (sleep, hibernation), regardless of whether the unit is powered by AC or batteries.
EXFO - Max Battery	Optimizes the energy consumption, which could be particularly useful when you operate the unit on batteries.

Setting Up Your FTB-500

Configuring the Power Management Options

You can either modify one of the existing power plans or create one (based on an existing power plan). It is always possible to revert to factory default values for the predefined plans. You can delete custom power plans that you no longer use, but not the predefined plans.

To select a power plan:

1. From the main window, tap the **System Settings** button.
2. Tap **Control Panel**.

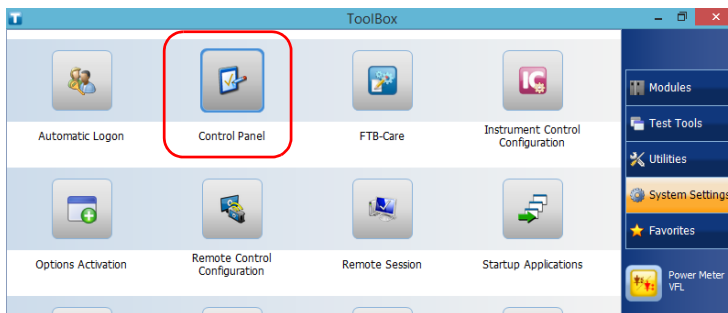

3. Tap **Hardware and Sound > Power Options**.

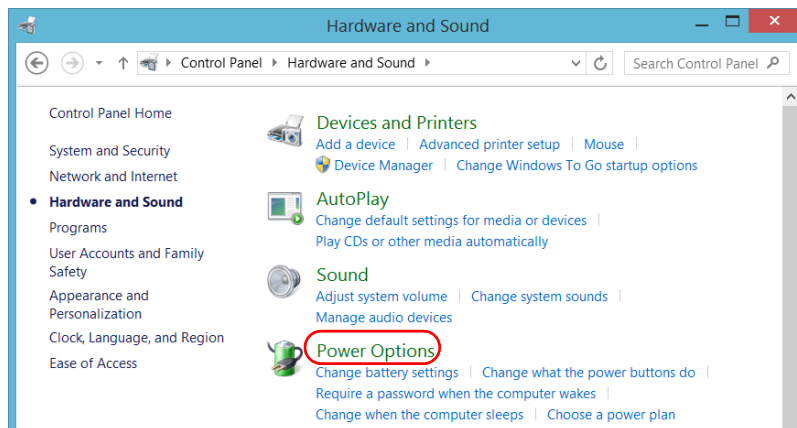

4. From the list of available power plans, select the desired set of parameters.

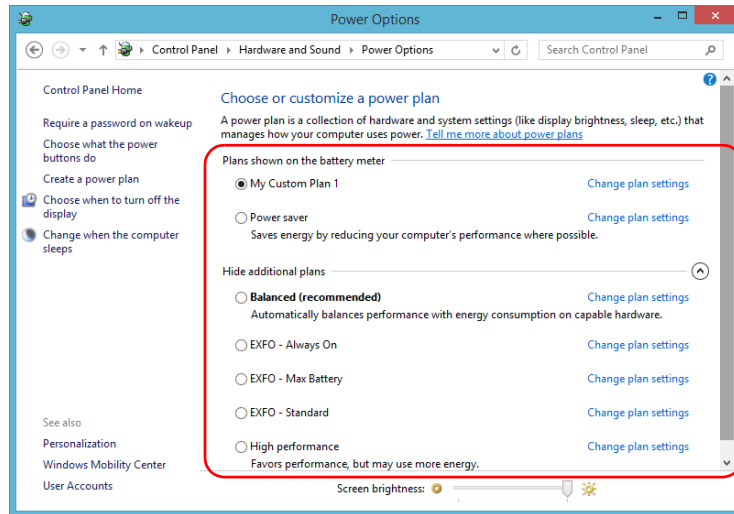

5. Close the window.

The new values are taken into account immediately.

Setting Up Your FTB-500

Configuring the Power Management Options

To create a power plan:

1. From the main window, tap the **System Settings** button.
2. Tap **Control Panel**.

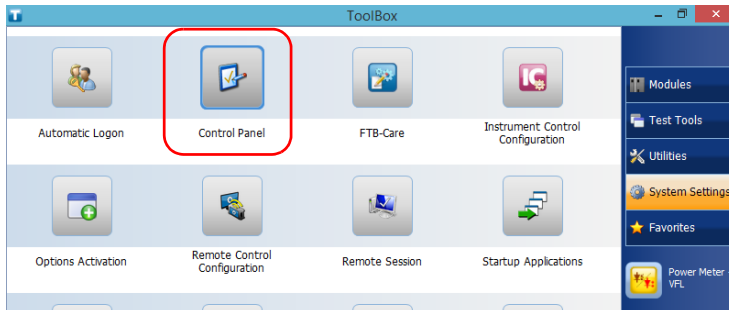

3. Tap **Hardware and Sound > Power Options**.

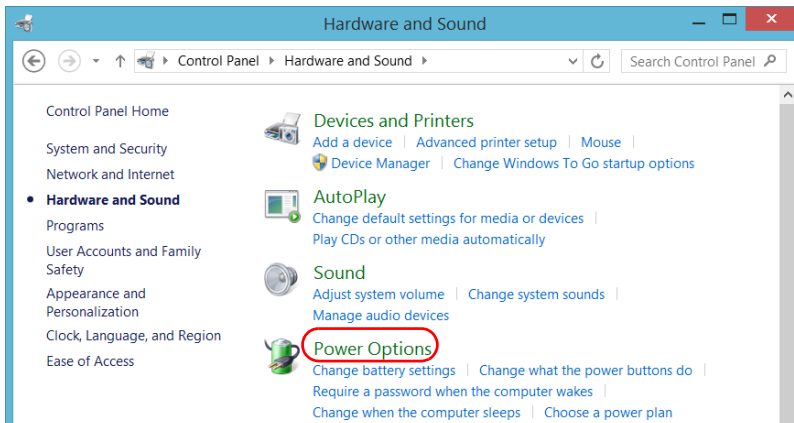

4. From the list on the left, tap **Create a power plan**.

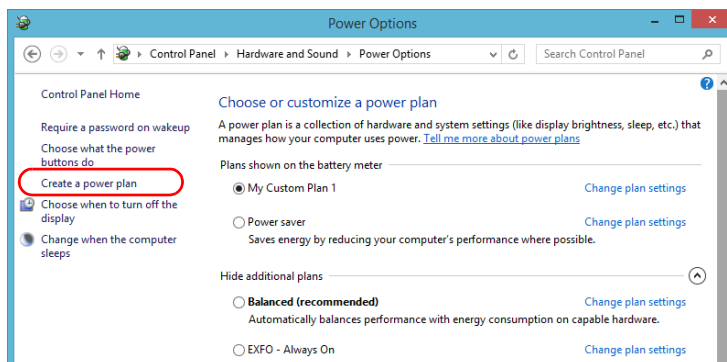

5. Select a power plan that will serve as a basis.

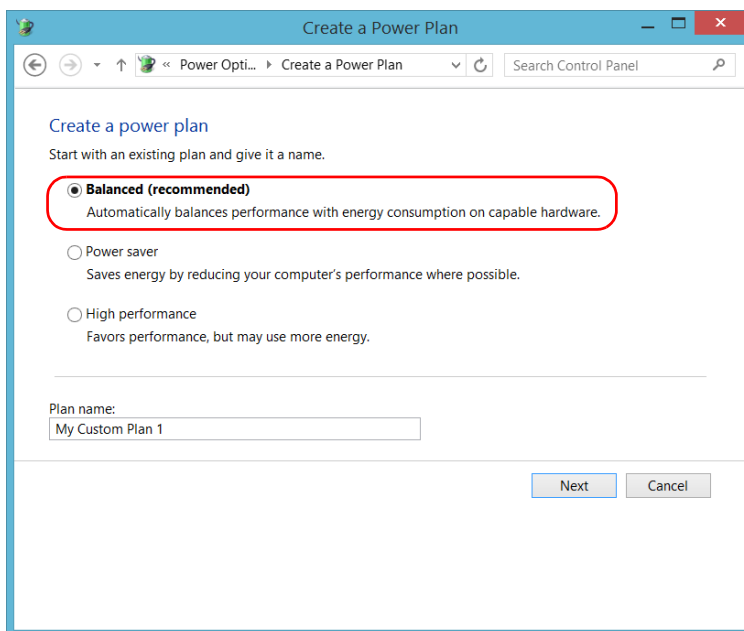

6. Enter a name, and then tap **Next**.

Setting Up Your FTB-500

Configuring the Power Management Options

7. Modify the parameters to suit your needs.

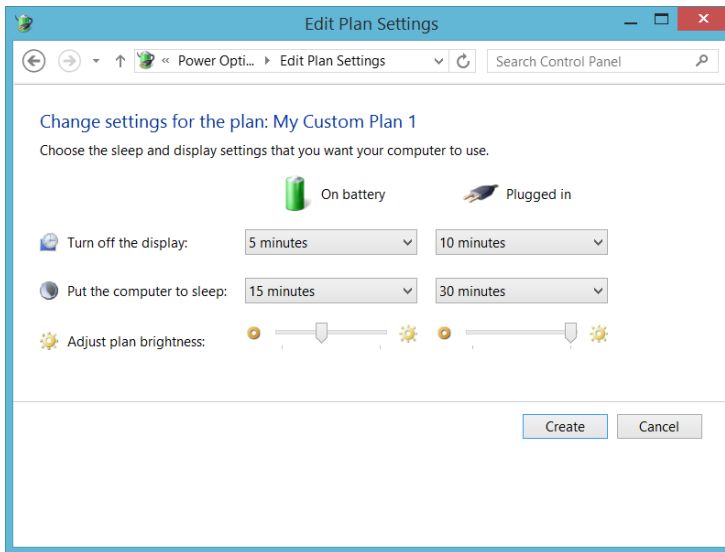

8. Tap **Create**.

To modify or delete an existing power plan:

1. From the main window, tap the **System Settings** button.
2. Tap **Control Panel**.

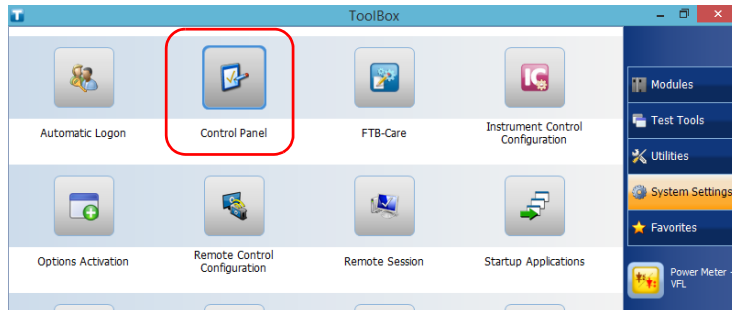

3. Tap **Hardware and Sound > Power Options**.

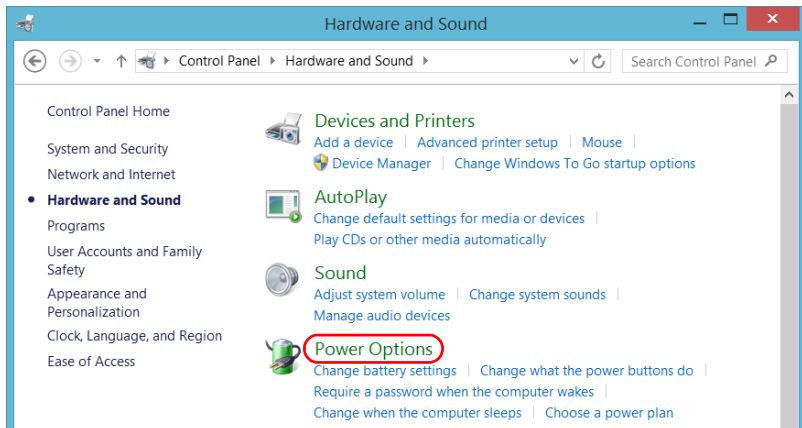

Setting Up Your FTB-500

Configuring the Power Management Options

4. From the list of available power plans, locate the set of parameters that you want to modify or delete.

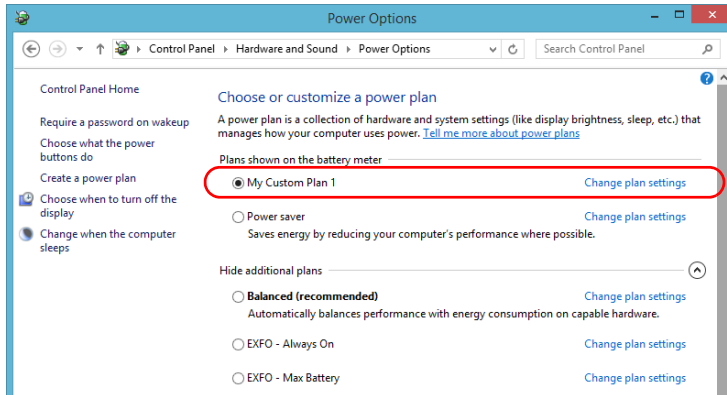

Note: *You can only delete custom power plans, not predefined ones. If the custom power plan that you want to delete is currently in use, you must select another plan first.*

5. Tap **Change plan settings** (appearing next to the power plan).

6. If you want to modify the parameters, proceed as follows:

6a. Modify the parameters to your needs.

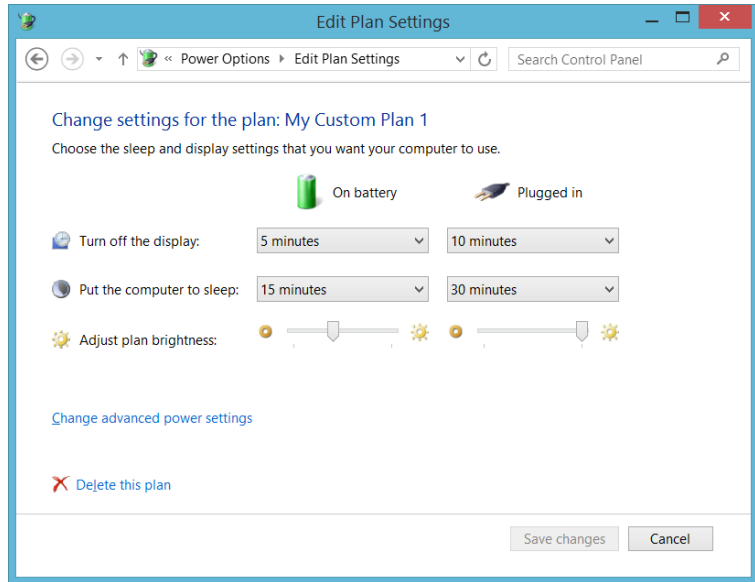

Note: *If you want to modify the Hibernate settings, tap **Change advanced power settings**.*

6b. Tap **Save changes**.

Setting Up Your FTB-500

Configuring the Power Management Options

7. If you want to delete the power plan, tap **Delete this plan**, and then confirm the deletion.

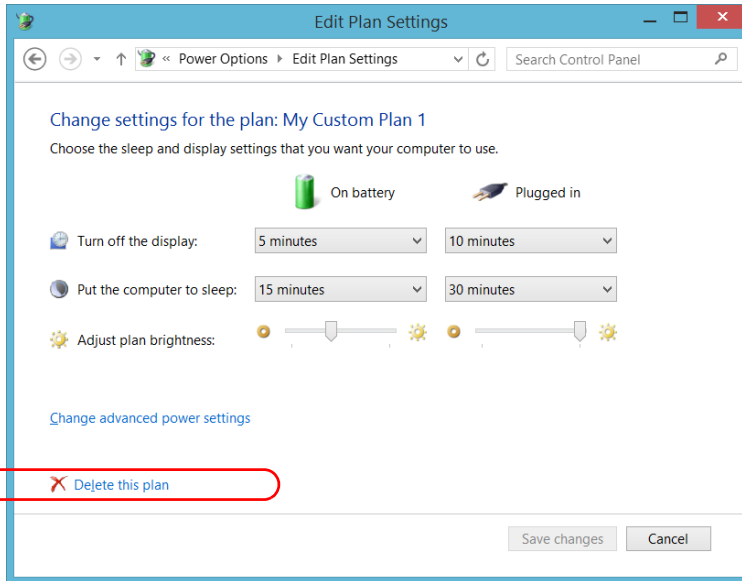

8. Close the window.

The changes are taken into account immediately.

Setting ToolBox Behavior

You can specify how ToolBox behaves when the application is started, minimized or closed.

To set the ToolBox behavior:

1. From the main window, tap the **System Settings** button.
2. Tap **ToolBox Setup**.

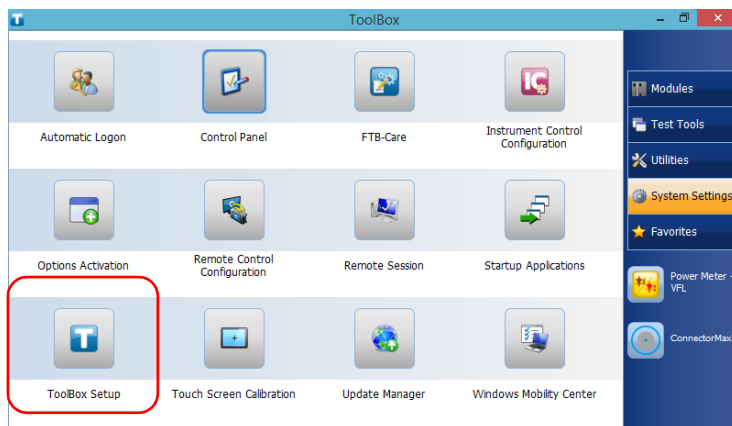

Setting Up Your FTB-500

Setting ToolBox Behavior

3. Select the items corresponding to the desired behavior.

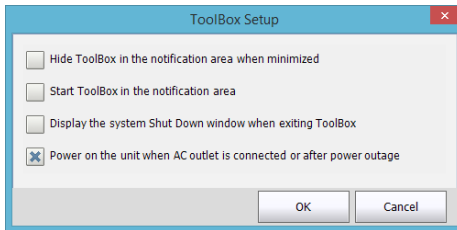

- **Hide ToolBox in the notification area when minimized:** If this option is selected, the ToolBox icon appears in the notification area (where the clock is located) when you minimize the window.
 - **Start ToolBox in the notification area:** If this option is selected, ToolBox is automatically started, then minimized to the notification area (system tray).
 - **Display the system Shut Down window when exiting ToolBox:** If this option is selected, the standard system Shut Down window appears to let you shut down the unit directly instead of closing the ToolBox application, then shutting down the unit from Windows. For more information on the different ways to turn off your unit, see *Turning Off Your Unit* on page 32.
4. Tap **OK** to confirm your settings and close the window.

Configuring the Internet Options

You can browse the Web directly from your unit, provided that you have access to an Internet connection and that the Internet options are configured properly.

If you are not sure about how you should configure your Internet access, contact your network administrator.

To configure the Internet options:

1. From the main window, tap the **System Settings** button.
2. Tap **Control Panel**.

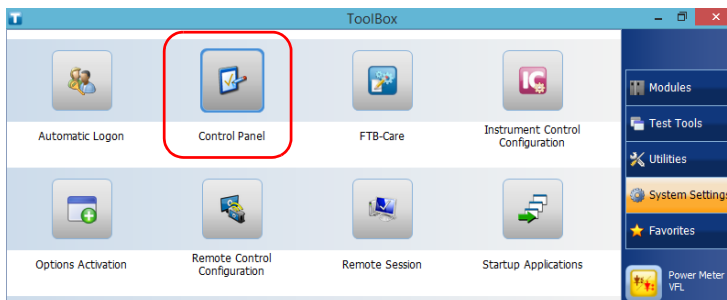

3. Tap **Network and Internet**.

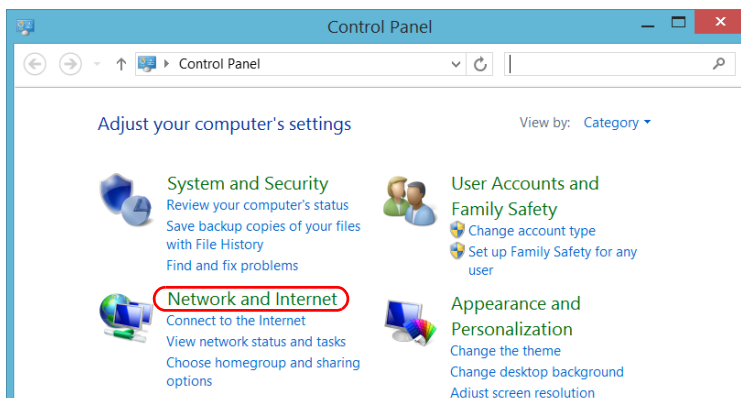

Setting Up Your FTB-500

Configuring the Internet Options

4. Tap **Internet Options**.

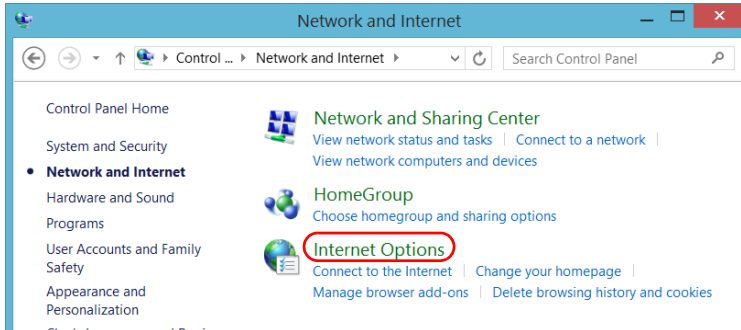

5. Go to the **Connections** tab.

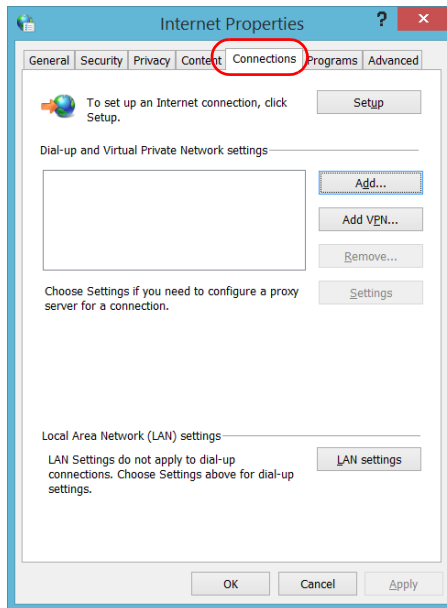

6. Modify the settings using the information provided by your network administrator.

7. Tap **OK** to return to the **Control Panel** window.

Configuring Parameters via Windows Mobility Center

For a quick access to various parameters such as the brightness, volume, or power plans, you may want to use the Windows Mobility Center.

To configure the parameters via Windows Mobility Center:

1. From the main window, tap the **System Settings** button.
2. Tap **Windows Mobility Center**.

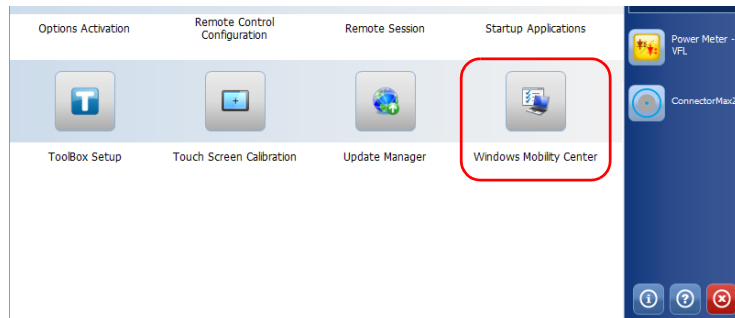

3. Set the parameters as desired.

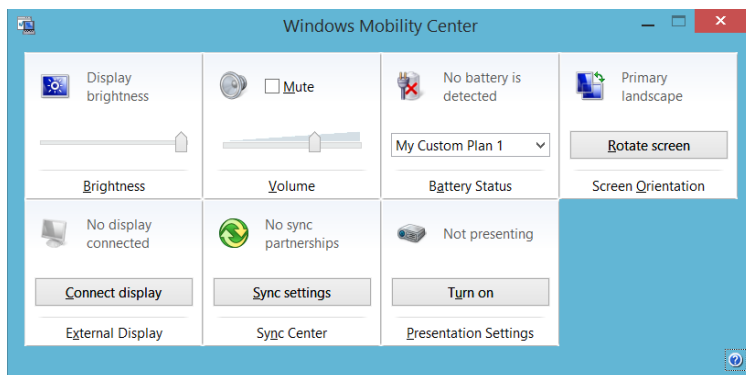

Setting Up Your FTB-500

Setting Communication Parameters

Setting Communication Parameters

For information on how to configure your unit for remote control, see *Preparing for Automation* on page 189.

Setting Other Parameters

You can also configure many other parameters via the **Control Panel** window. Refer to Microsoft Windows 8.1 Pro documentation for details.

5 Working with Your Unit

Printing Documents

You can print documents and images directly from your unit by using either the provided PDF creation tool or an external printer (for printing on paper).

You can view the PDF files from your unit, using the provided PDF reader. For more information, see *Viewing PDF Files* on page 112.

You can use a local or a network printer to print on paper.

- Local printer: You must connect the printer to your unit and install the required software and drivers provided by the manufacturer of the printer.
- Network printer: Your unit must be accessible from this network by Wi-Fi or standard Ethernet. You must also define the printer on your unit before attempting to access it (see *Configuring Network Printers* on page 81).

Note: *Some applications may not offer print functions.*

To print documents:

1. Open the document that you want to print.
2. From the application in which you have opened your file, access the print function.

Note: *In most applications, you can access the print function by the **File** menu or by a **Print** button.*

3. Select the desired printer (PDF creation tool by default).
4. If necessary, adjust the printer's parameters to your needs.
5. Tap **Print** to start the printing process, and follow the on-screen instructions.

Working with Your Unit

Viewing PDF Files

Viewing PDF Files

You can view PDF files directly from your unit using the provided PDF file viewer. For more information on the available features for this viewer, refer to the PDF viewer online help.

Note: *You may need a connection to the Internet to access the PDF viewer online help.*

Note: *You can also use any PDF viewer that you like, as long as it is compatible with Windows 8.1 Pro.*

To view PDF files:

1. From the main window, tap the **Utilities** button.
2. Tap **File Manager**.

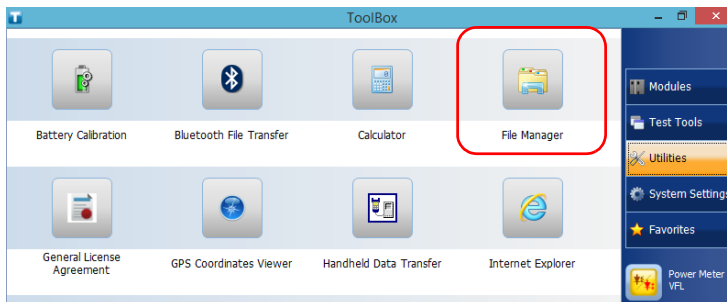

3. Browse through the folders to find the desired PDF file.
4. Tap the file.
5. The file opens automatically in the PDF viewer.

Taking Screen Captures

You can take captures of what is displayed on your screen, directly from your unit. This could be useful for troubleshooting when you need another person to have a look at a specific configuration or problem. You could also use this tool for training purposes.

If you want to capture images of the fibers that you examine with the fiber inspection probe, you can use the capture feature of the probe instead.

- The images are saved in .png format. They are sent to the following folder (in the account of the user currently logged on the unit):

This PC\Pictures\Screenshots

- The application generates file names as follows:

Screenshot (<Sequential_number>).png

where

Sequential_number corresponds to the number that is added each time you take a screen capture.

Note: *The name of the folders and of the files described above will vary according to the language that is currently selected in Windows.*

Working with Your Unit

Taking Screen Captures

To take a screen capture:

1. If necessary, from the front panel of the unit, press the  button to show the taskbar.
2. From the notification area, tap the camera icon.



3. From the shortcut menu, tap **Take a screenshot**.

The screen capture is automatically taken (a visual effect typical of a camera taking a picture indicates that the capture is complete).

Note: *If a keyboard is connected to your unit, you can also press the Windows logo key + PRINT SCREEN.*

Note: *If you tap **Exit** from the shortcut menu, you will need to log off, and then log on to be able to take screen captures again.*

Browsing the Web

You can browse the Web directly from your unit, provided that you have access to an Internet connection.

If you need to modify the Internet options, see *Configuring the Internet Options* on page 107. For more information on how to connect to the Internet using a 3G USB modem key, see *Accessing the Internet with a 3G USB Modem Key* on page 116.

To browse the Web:

1. Open a Web browser as follows:
 - 1a. From the main window, tap the **Utilities** button.
 - 1b. Tap the **Internet Explorer** icon to open the browser.
2. Enter the desired Web address in the address bar and tap the  button (located at the right of the address bar) to start browsing.

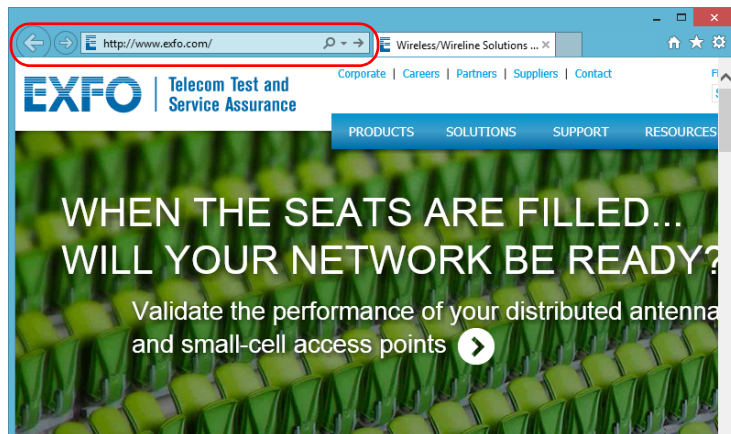

3. Close the window to return to the **Utilities** window.

Accessing the Internet with a 3G USB Modem Key

Note: *Only administrator-level users can install software. However, when the installation is complete, all users will have the possibility to access the Internet with a USB modem key.*

You can connect an optional 3G USB modem key to your unit to have a wireless access to the Internet.

When you receive your Sierra Wireless 319U modem key, it contains no Subscriber Identity Module (SIM) card. This means that you will need to:

- Purchase a compatible and unlocked SIM card from a provider offering 3G services. If you need more information on the 3G coverage in your area, contact your regional sales representative.
- Have the card activated (you must subscribe to a package of mobile services).
- Insert the card in the modem key.

The very first time you connect a USB modem key to your unit, the AirCard Watcher application will be installed automatically on your unit. You will use this application to establish a connection with the mobile network whenever you want to work with your USB modem key. You only need to install this application once.



IMPORTANT

Always turn your unit on *before* connecting the USB modem key to it. Otherwise, the USB modem may not be detected properly.

To install the AirCard Watcher application on your unit:

- 1.** If necessary, turn on your unit and wait for the startup sequence to complete.
- 2.** If necessary, insert the SIM card into the USB modem key. For more information, refer to the documentation that came with your modem key.
- 3.** Connect the USB modem key to one of the USB ports of your unit.
The installation of the AirCard Watcher application will start automatically.
- 4.** Follow the on-screen instructions.

You will know that the installation is complete when the AirCard Watcher application starts.



- 5.** Close the AirCard Watcher application.
- 6.** Disconnect the USB modem key from your unit.
- 7.** Reconnect the USB modem key to your unit so that it can be detected properly.

All users are now ready to start working with the USB modem key as explained hereafter.

Working with Your Unit

Accessing the Internet with a 3G USB Modem Key



IMPORTANT

Always turn your unit on *before* connecting the USB modem key to it. Otherwise, the USB modem may not be detected properly.

To work with a 3G USB modem key:

- 1.** If necessary, turn on your unit and wait for the startup sequence to complete.
- 2.** If necessary, insert the SIM card into the USB modem key. For more information, refer to the documentation that came with your modem key.
- 3.** If necessary, connect the USB modem key to one of the USB ports of your unit.
- 4.** From the Windows desktop, tap the AirCard Watcher icon to start the application.

5. Once the AirCard Watcher application starts, tap **Connect** to establish a connection with the mobile network.

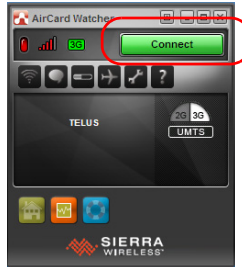

As soon as the connection is established, you are ready to browse the Web.

Note: *If you want to customize the behavior and appearance of the AirCard Watcher application, refer to the online help provided with the application (available by tapping ? from the toolbar).*

Note: *The application will display a warning message if no SIM card has been inserted in the USB modem key.*

Note: *Depending on the package that you have purchased with your service provider and the type of network, you may have to set specific parameters. If you are not sure on how to proceed or need more information about the configuration, see with your service provider.*

6. When you have finished working, tap **Disconnect** from the AirCard Watcher application, and then remove the USB modem key from your unit.

Retrieving the GPS Location of Your Unit

With the optional GPS USB key and the provided GPS utility, you can retrieve the last known latitude and longitude coordinates of your unit.

In addition to viewing the GPS information on-screen, you can copy it to the Clipboard in two formats: a text string or a URL link. The text string contains the GPS coordinates as well as a date and time stamp. Once the information is in the Clipboard, you can paste it to any document or test report (in editable sections). If your unit is connected to the Internet, you can even directly paste the URL link to a Web browser to locate your unit on a map.

Note: *Only administrator-level users can install software under Windows 8.1 Pro.*



IMPORTANT

Always turn your unit on *before* connecting the GPS USB key to it. Otherwise, the GPS key may not be detected properly.

To retrieve the GPS location of your unit:

- 1.** If necessary, turn on your unit and wait for the startup sequence to complete.
- 2.** Ensure that the GPS USB key is connected to your unit.

- From the main window, tap the **Utilities** button, then tap **GPS Coordinates Viewer**.

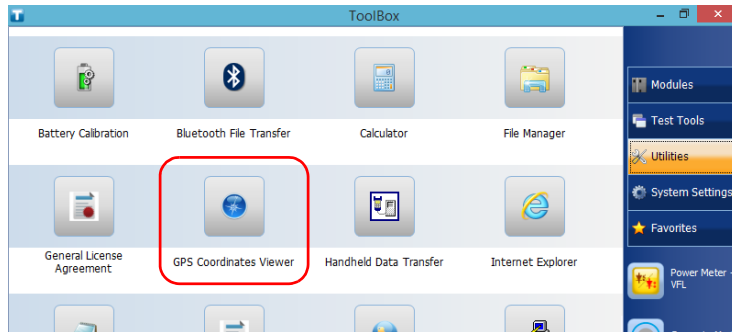

The GPS coordinates are displayed.

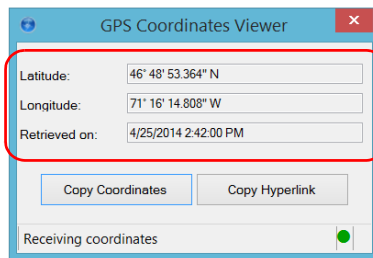

Note: As this is the case with any other GPS device, you may have to wait a few minutes to get a valid GPS signal.

- Tap **Copy Coordinates** to send the displayed information to the Clipboard as a text string.
 - Tap **Copy Hyperlink** to send the displayed information to the Clipboard as a URL link.
- When your work is finished, tap **X** to close the utility.

Managing Favorites

For a quicker access to the applications that you use most often, you may want to build your own list of favorite applications (Favorites).

You can add and remove Favorites from the list. You can also import and export lists of Favorites, which could be useful for backup and recovery purposes, or to share the same Favorites among several units or user accounts.

Note: *To have access to the same Favorites on several units, the corresponding applications must be available on all units.*

To add Favorites:

1. From the main window, tap the **Favorites** button.
2. Tap **Favorites Management**.

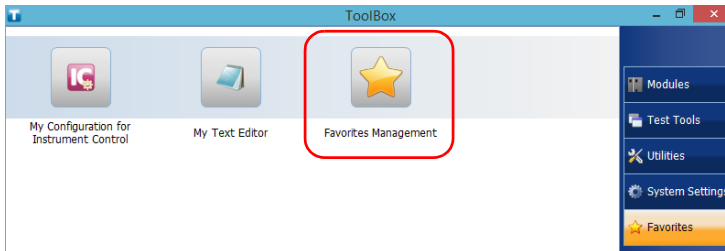

3. Tap **Add**.

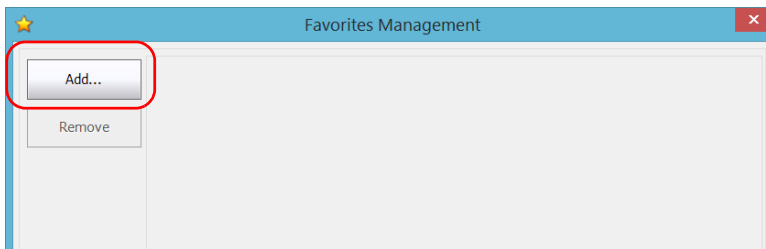

4. Tap **Browse** to locate the desired application.

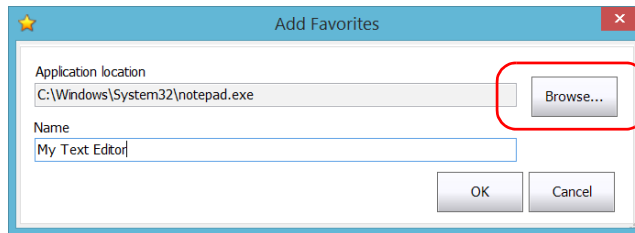

5. Type a name for the new Favorite.
6. Tap **OK** to confirm the location and name.
7. Repeat the previous steps with all the Favorites that you want to add.
8. Tap **OK** to apply the changes and close the window.

To remove Favorites:

1. From the main window, tap the **Favorites** button.
2. Tap **Favorites Management**.

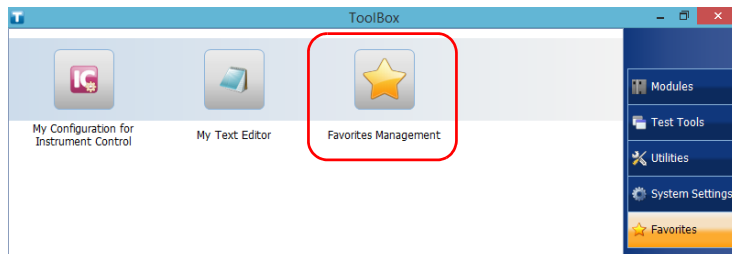

Working with Your Unit

Managing Favorites

3. Tap the icon corresponding to the Favorite that you want to remove from the list.

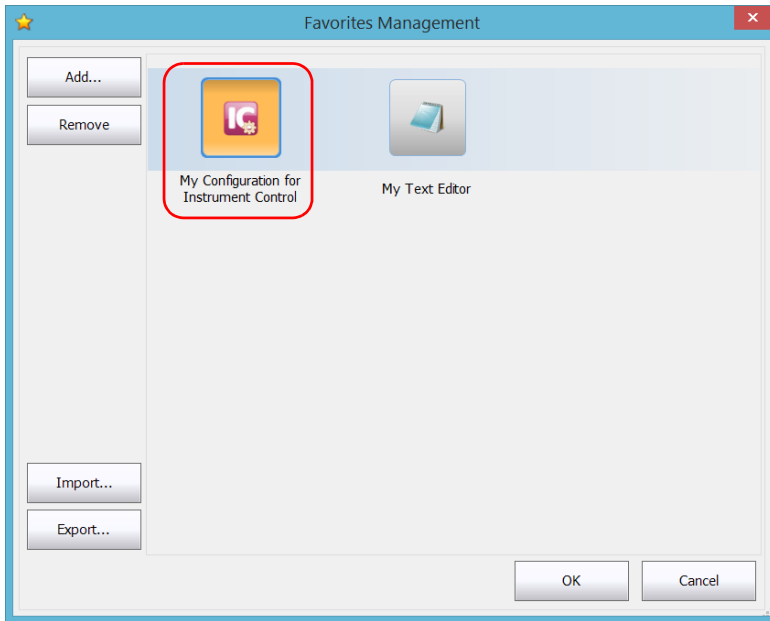

4. Tap **Remove**.

Note: *The application will not prompt you to confirm the removal of the Favorite from the list. Removing a Favorite from the list does not uninstall the application from the unit.*

5. Tap **OK** to apply the changes and close the window.

To work with Favorites:

1. From the main window, tap the **Favorites** button.
2. Tap the icon corresponding to the application that you want to use.

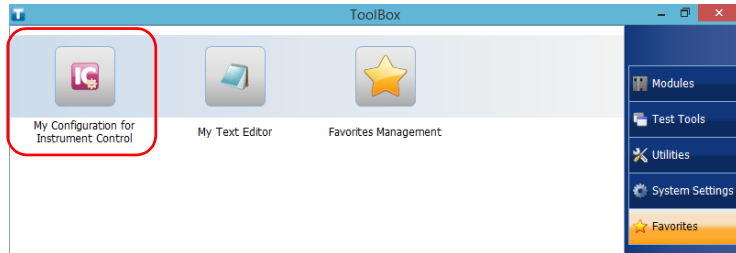

Working with Your Unit

Managing Favorites

To export the list of Favorites:

1. From the main window, tap the **Favorites** button.
2. Tap **Favorites Management**.

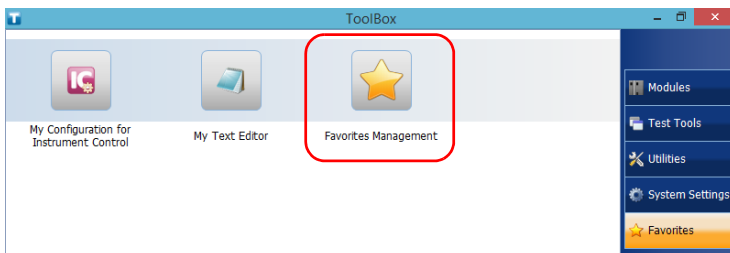

3. Tap **Export**.

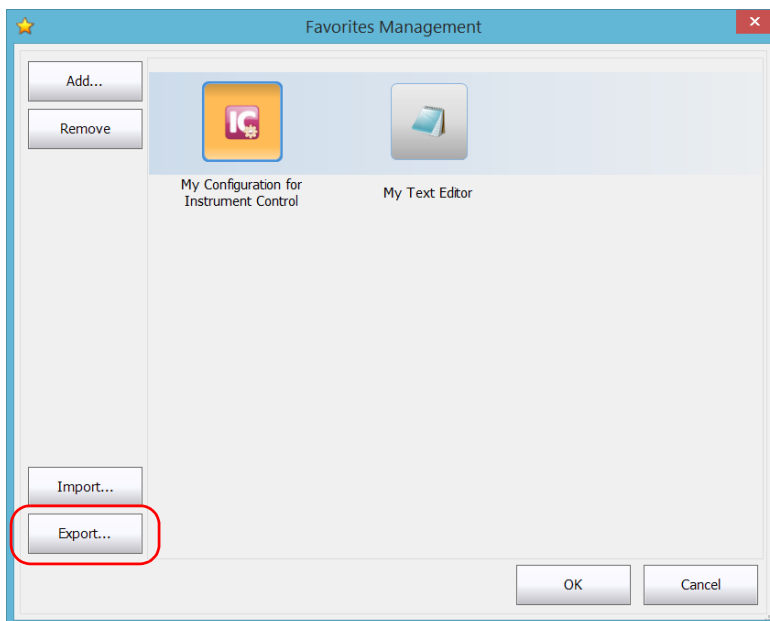

4. Select a location and type a name for the Favorites list.

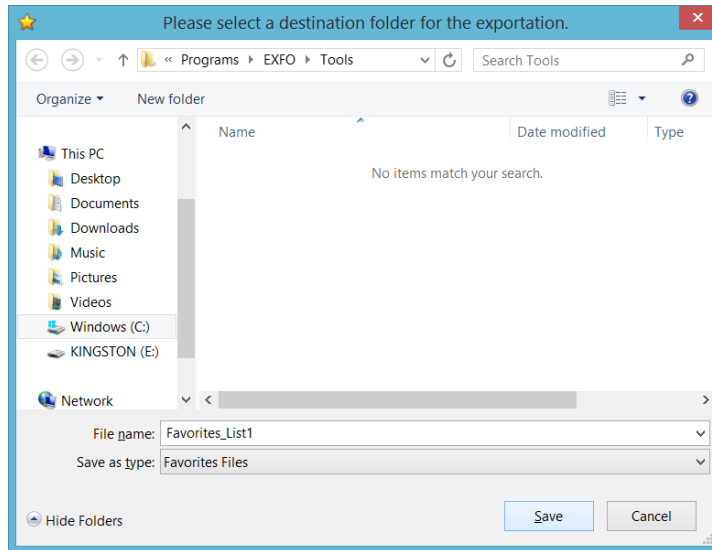

5. Tap **Save**.
6. Tap **OK** to apply the changes and close the window.

Working with Your Unit

Managing Favorites

To import a list of Favorites:

1. From the main window, tap the **Favorites** button.
2. Tap **Favorites Management**.

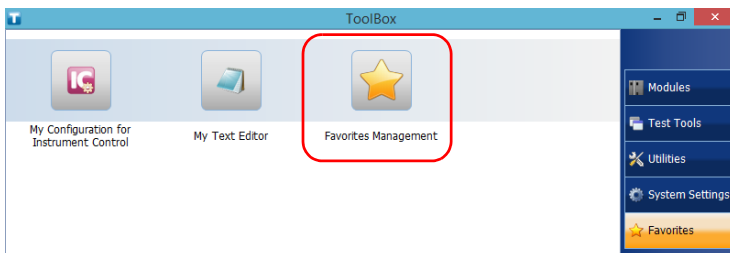

3. Tap **Import**.

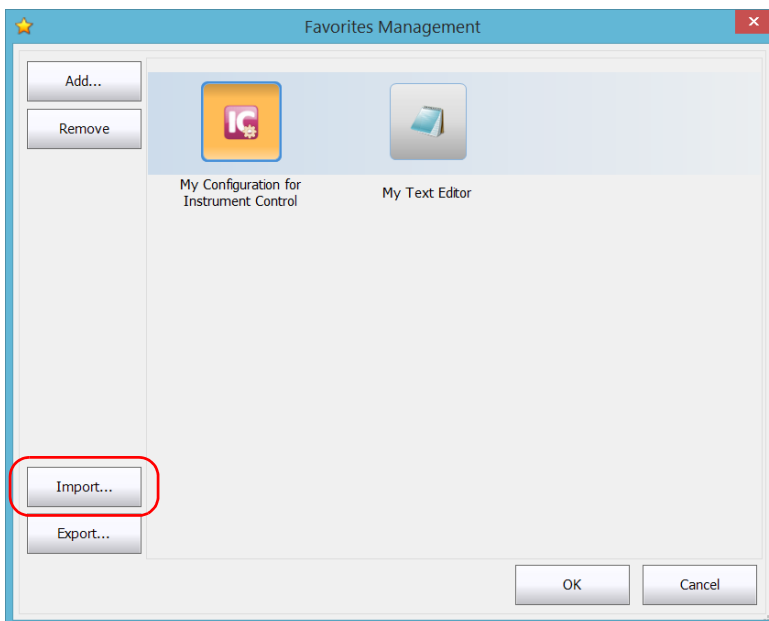

4. Select the desired Favorites list.

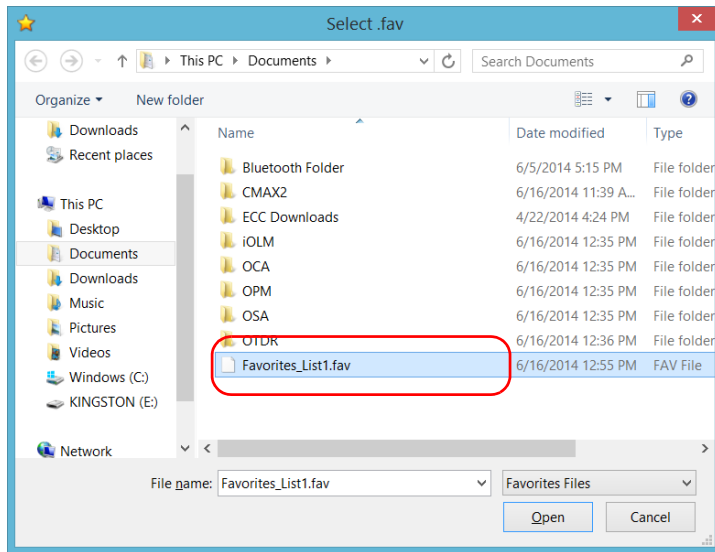

5. Tap **Open**.
6. Tap **OK** to apply the changes and close the window.

Using the Calculator

You can use Microsoft Calculator directly from your unit.

To use the Calculator:

1. From the main window, tap the **Utilities** button.
2. Tap **Calculator**.

Using the Text Editor

You can use Microsoft Notepad directly from your unit.

To use the text editor:

1. From the main window, tap the **Utilities** button.
2. Tap **Notepad**.

Accessing Other Tools

Your unit comes with various tools that can help you better analyze or manage your data.

You have also access to free tools such as Wireshark to help you troubleshoot networks. For more information, refer to the online help provided with these tools, when applicable.

To access the applications:

1. From the main window, tap the **Test Tools** button.

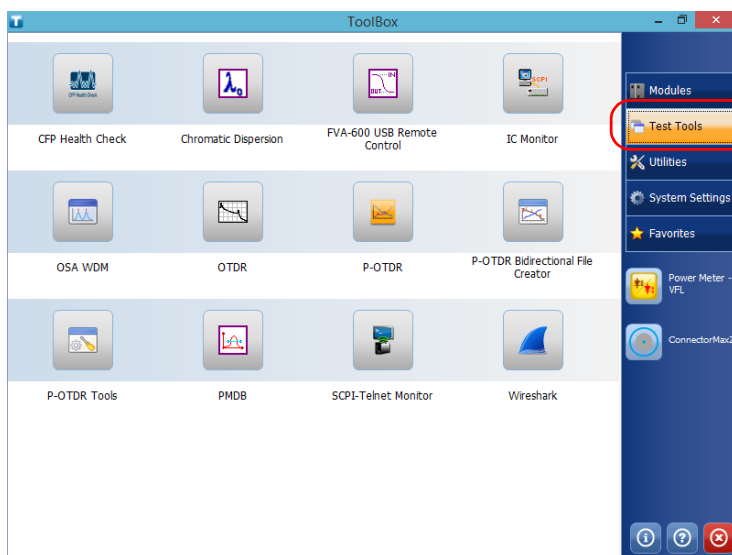

2. Tap the icon corresponding to the application that you want to start.

6 *Using the Optional Built-In Power Meter and VFL*

The FTB-500 can be equipped with an optical power meter and a visual fault locator (VFL).

With the power meter, you can measure absolute power (dBm or W) or insertion loss (dB). The power meter can detect modulated signals (1 kHz, 2 kHz, and 270 Hz). With the VFL, you can inspect or identify fibers. For more information on how to use the power meter or the VFL, refer to the power meter online help.



IMPORTANT

If you intend to take measurements with a very low power level, make sure that your testing conditions are optimal to ensure the best results (for example, do not use the VFL, make sure that the other modules in your platform are not performing measurements and that their internal parts are not moving, etc.).

Using the Optional Built-In Power Meter and VFL

To access the built-in power meter or the VFL:

From the main window, tap **Power Meter and VFL**.

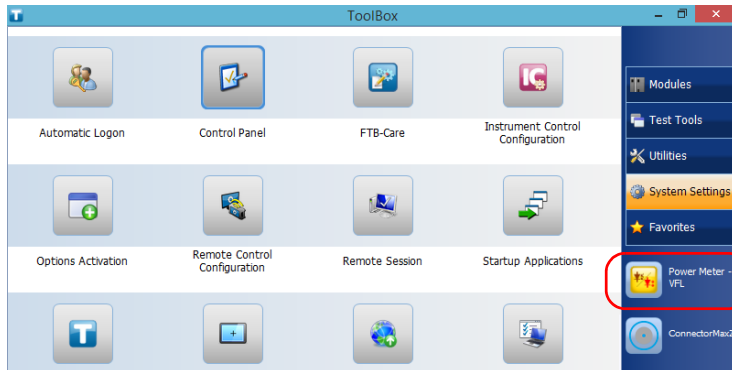

Note: You can access the online help of the power meter and the VFL by tapping the  button from the power meter application.

7 *Inspecting Fibers with a Probe*

The fiber inspection probe (FIP) is used to find dirty or damaged connectors by displaying an enlarged view of the connector surface. You can connect a probe to your unit to view fiber ends.



IMPORTANT

Only the probes of the FIP-400B series are supported on your unit.

Fiber inspections are made using the ConnectorMax2 application. For more information, refer to the ConnectorMax2 online help.

To inspect fibers with a probe:

1. Connect the probe to your unit.



IMPORTANT

Make sure that you connect the probe to the USB port that is closest to the bottom, on the front panel of the unit. Otherwise, the probe will not be detected properly.

Front panel

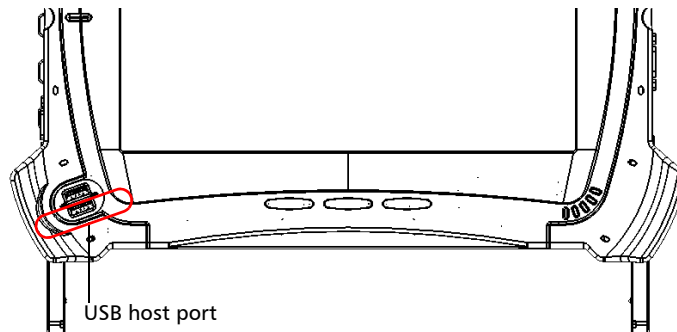

Inspecting Fibers with a Probe

2. From ToolBox, tap the **ConnectorMax2** button to open the application.

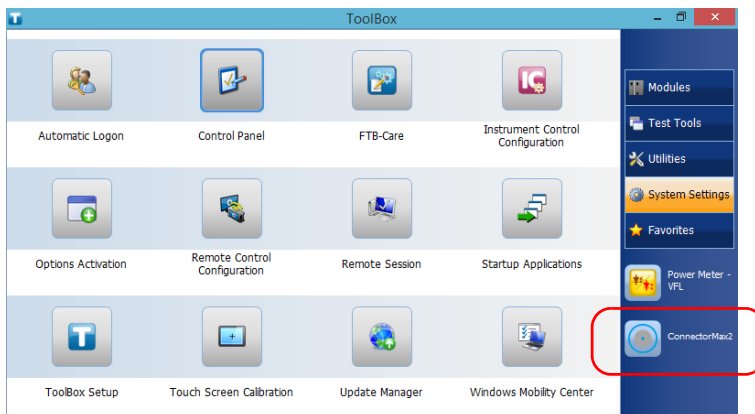

Note: You can access the online help by tapping the  button from the ConnectorMax2 application.

8 **Managing Data**

You can copy, move, rename, delete files and folders directly on your unit.

You can transfer files from your unit to a USB memory key, an ExpressCard, or a computer. You can also transfer data from a storage device or a computer to your unit.

Your unit is equipped with the following ports and devices for data transfer:

- Four USB 2.0 ports to connect
 - a memory key
 - a USB to RS-232 adapter (see *Using the USB to RS-232 Adapter* on page 148.)
 - a Bluetooth device (optional) to transfer data via the Bluetooth technology.
- an ExpressCard slot to insert
 - a memory card
 - a Wi-Fi card (optional) to connect to a wireless network
- an Ethernet port to connect to a network (for transfer via VNC or Remote Desktop - see *Accessing Your Unit Remotely* on page 167)

Managing Data

Viewing Disk Space and Managing Files

Viewing Disk Space and Managing Files

To help you manage the data that is stored on your unit, you can easily view the remaining disk space. You can also copy, move, rename, delete files and folders directly from your unit.

To view the free disk space, and manage files and folders:

1. From the main window, tap the **Utilities** button.
2. Tap **File Manager**.

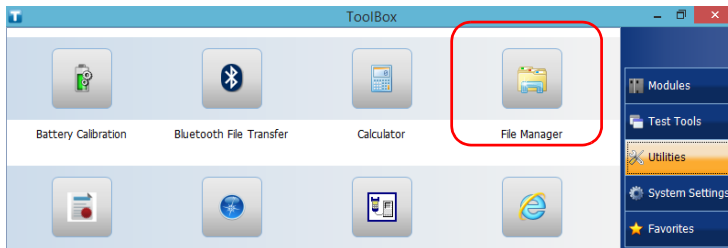

The file explorer is displayed.

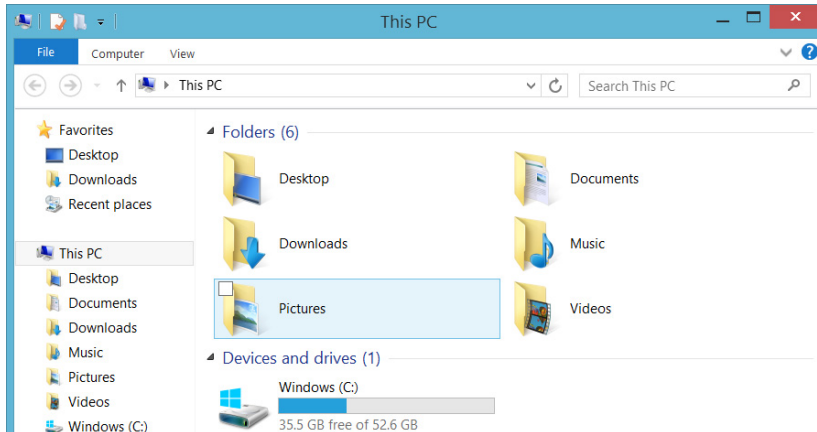

Note: The free disk space is also visible from the **Platform** tab (tap  in the lower right corner of the main window).

Transferring Data via Bluetooth

With the optional Bluetooth device, you can transfer data between your unit and a computer (or another device such as a smartphone) using the Bluetooth technology. In all cases, you must ensure that the computer or the device is compatible with the Bluetooth technology and configured properly.

Note: *Some devices that are compatible with Bluetooth technology only allow data transfer between devices of the same manufacturer. In this case, you will need to use another type of device or a standard computer to transfer data from your unit.*

Note: *To save power when your unit is running on batteries, you may wish to disconnect the Bluetooth device from your unit when you do not use it.*

Your unit must be located within a 9-meter area from your computer (limitation of the Bluetooth device).

Since transfer speed is limited for larger files (more than 1 GB), if you need to transfer such files, you may want to use a USB key, or connect to a Wi-Fi or an Ethernet network.



IMPORTANT

Depending on the operating system that your computer is running (or on the smartphone that you are using), it is possible that only data transfer secured with a passkey be allowed.

The procedure presented hereafter explains how to transfer data from your unit to a computer.

Note: *If you transfer files from a computer to your unit, they will be sent automatically to the This PC\Documents folder on your unit.*

Managing Data

Transferring Data via Bluetooth

To configure your unit and the computer for transfer:

- 1.** Configure your unit as follows:
 - 1a.** Connect the Bluetooth device to one of the USB ports of your unit.
 - 1b.** From the notification area, tap the Bluetooth icon.

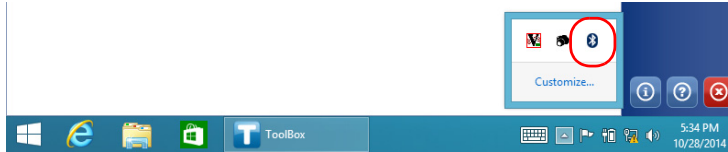

- 1c.** Tap **Open Settings**.
- 1d.** From the **Options** tab, under **Discovery**, select the **Allow Bluetooth devices to find this PC** check box.

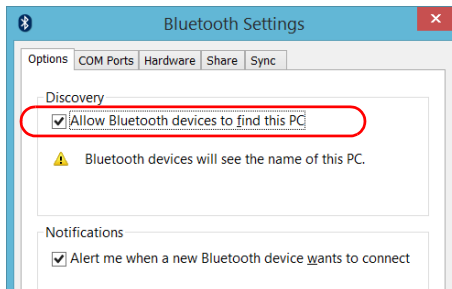

- 1e.** From the **Share** tab, ensure that the **Allow remote devices to browse, send, and receive pictures, music, and other files** check box is selected.

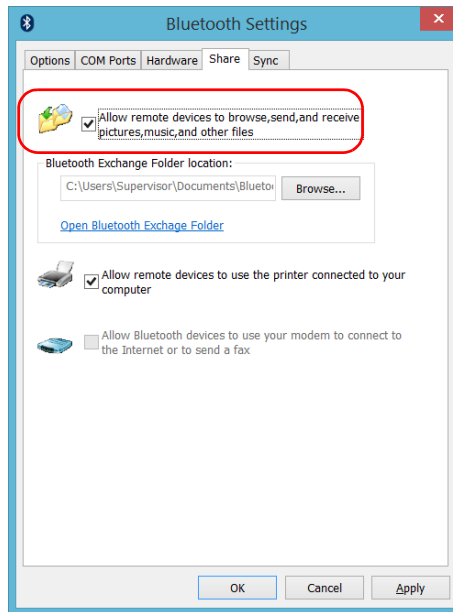

- 1f.** Tap **OK** to confirm.
- 2.** Configure the computer as follows:
 - 2a.** From the notification area, click the Bluetooth icon.
 - 2b.** Select **Open Settings**.
 - 2c.** Ensure that the option allowing Bluetooth devices to find the computer is selected.
 - 2d.** Click **OK** to confirm.

Managing Data

Transferring Data via Bluetooth

To transfer data via Bluetooth:

- 1.** Pair your computer with your unit as follows.
 - 1a.** On your unit, from the right side of the screen, swipe left to display the Charm bar.
 - 1b.** Tap **Settings** > **Change PC settings**.

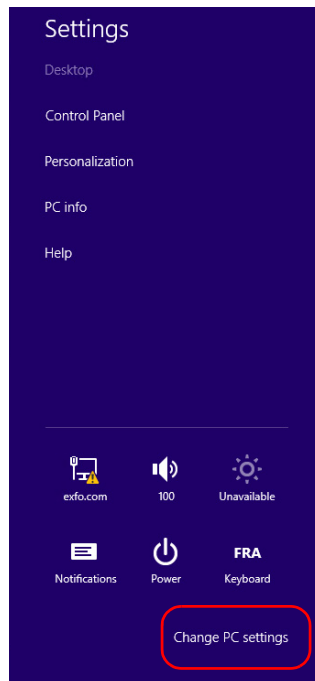

- 1c.** Tap **PC and devices**.

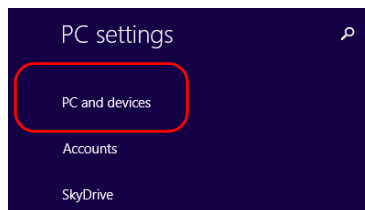

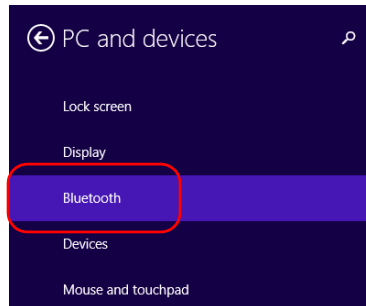
2. Tap Bluetooth.

2a. From the list of Bluetooth devices, tap the item corresponding to the computer to which you want to transfer files.

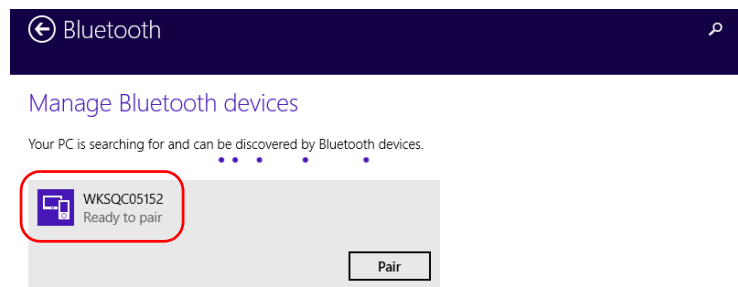
**2b. Tap Pair.**

Note: *If the computer or device that you want to select is already paired, you must remove the pairing first with the **Remove device** button.*

Note: *Depending on the computer that you are using, the application will either provide you with a passkey, or prompt you to confirm that the displayed passkey matches the passkey used on the computer.*

2c. If necessary, write down the provided passkey.

Managing Data

Transferring Data via Bluetooth

- 2d.** On the computer, when the application prompts you, click the Bluetooth icon (located on the taskbar) to display the wizard allowing you to add a Bluetooth device.
- 2e.** Follow the on-screen instructions. Enter the passkey that you wrote down earlier, or confirm the correspondence between the two passkeys.
- 3.** Transfer the files as follows.
 - 3a.** From the main window, tap the **Utilities** button.
 - 3b.** Tap **Bluetooth File Transfer**.

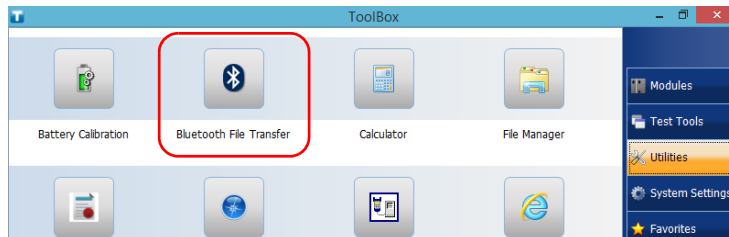

- 3c.** Select **Send files**.

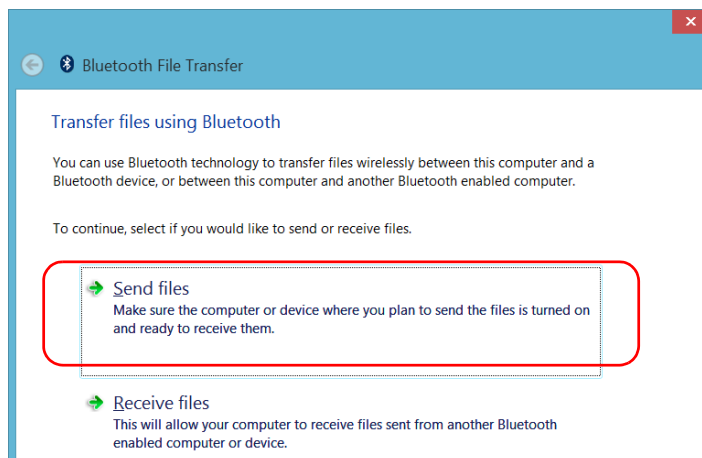

3d. Select the desired computer, and then tap **Next**.

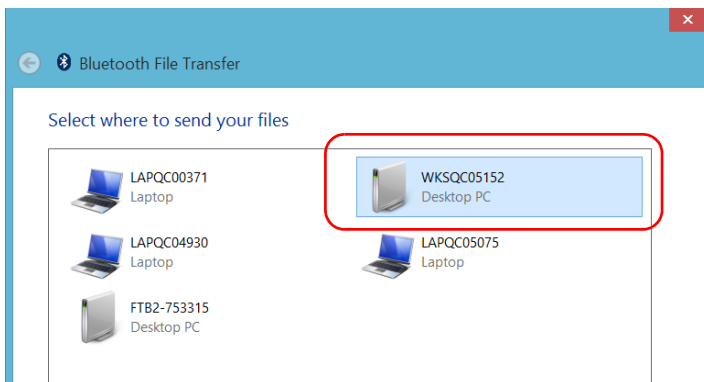

3e. Tap the **Browse** button to select the file that you want to transfer, and then tap **Next**.

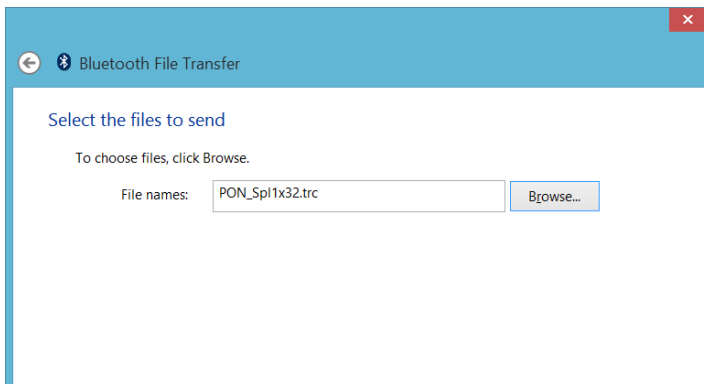

3f. Tap **Finish** when the transfer is complete.

Connecting to a Wireless Network

With the optional Wi-Fi card (or a USB wireless adapter of your choice), you can connect to a wireless network and benefit from all resources that are available on this network. You can transfer data exactly as you would do from an Ethernet network.

Note: *If you use a USB wireless adapter of your choice or a Wi-Fi card other than the one purchased from EXFO, Windows may not detect your device properly. In this case, you will have to install the drivers that are specific to your device (usually provided on a CD). Contact your IT department for assistance.*

Note: *To save power when your unit is running on batteries, you may wish to remove the Wi-Fi card (or the USB wireless adapter) when you do not use it.*

To connect to a wireless network:

1. Insert the Wi-Fi card into the ExpressCard slot located on the left panel of your unit.

OR

Connect the USB wireless adapter of your choice to one of the USB ports of your unit.

2. From the right side of the screen, swipe left to display the Charm bar.
3. Tap **Settings**, and then the  icon.



4. Tap the item corresponding to the wireless network to which you want to connect.

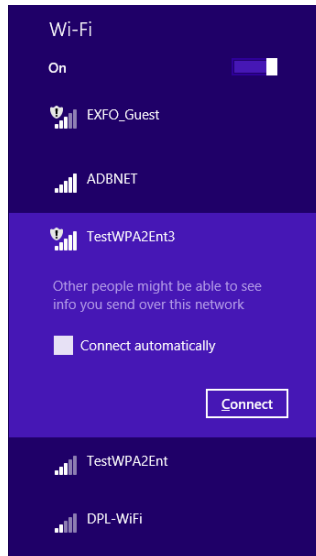

5. Tap **Connect**.
6. If the network is protected by a network security key (password) enter it in the corresponding box and tap **Next**.
7. Follow the on-screen instructions.

Note: *Since all networks are different, you may also need to configure other parameters before being able to transfer data via Wi-Fi. For information on the configuration specific to your network, contact your network administrator.*

As soon as the connection is established, you can start working with the selected wireless network. When you have finished, from the **Networks** list, tap **Disconnect** to stop communication with the wireless network.

Using the USB to RS-232 Adapter

If you want to transfer data between your unit and a device that is only equipped with RS-232 (serial) ports, you have to use a USB/RS-232 adapter (sold by EXFO).

Once the adapter has been detected, the unit assigns it a COM port number (for some adapters, values do not begin at COM 1). This COM port number is kept in memory even when you turn the unit off. This means that next time you connect the same adapter to any of the USB ports, the unit will recognize the adapter and identify it with the saved COM port number.

The communication between your unit and the device is established using the PuTTY application.

To use the USB/RS-232 adapter:

1. Turn on both the unit and the serial device.
2. Connect as shown. You can connect the USB end of the adapter to any of the USB ports.

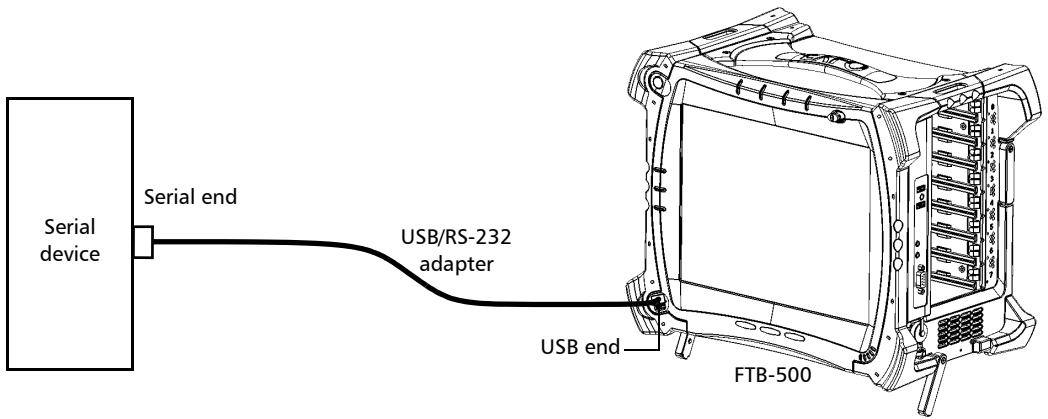

Note: *If the device that you want to use is a computer (not equipped with USB ports) you may want to use a null-modem serial cable as an “extension cable” between the device and the USB/RS-232 adapter.*

The adapter will be detected automatically on your unit.

Managing Data

Using the USB to RS-232 Adapter

3. From your unit, retrieve the COM port of the adapter as follows:

3a. From the main window, tap the **System Settings** button.

3b. Tap **Control Panel**.

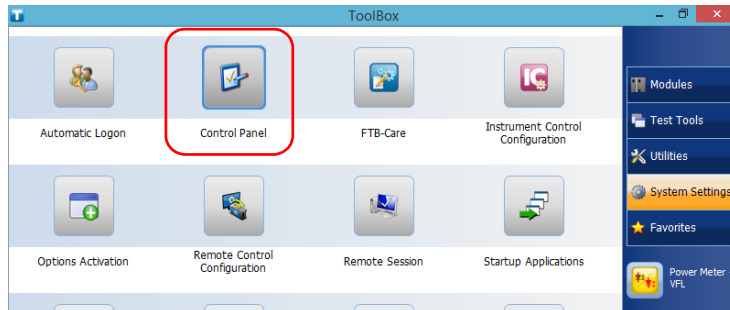

3c. Tap **Hardware and Sound**.

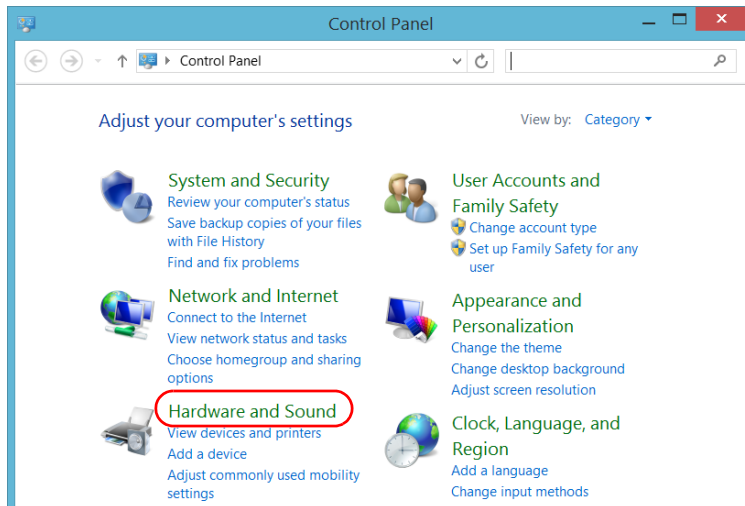

3d. Under **Devices and Printers**, tap **Device Manager**.

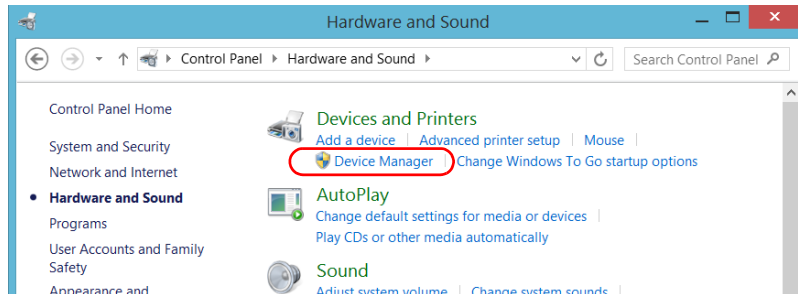

3e. Expand the **Ports (COM & LPT)** list to retrieve the COM port number that has been assigned to the adapter (identified as *USB Serial Port*) and write it down.

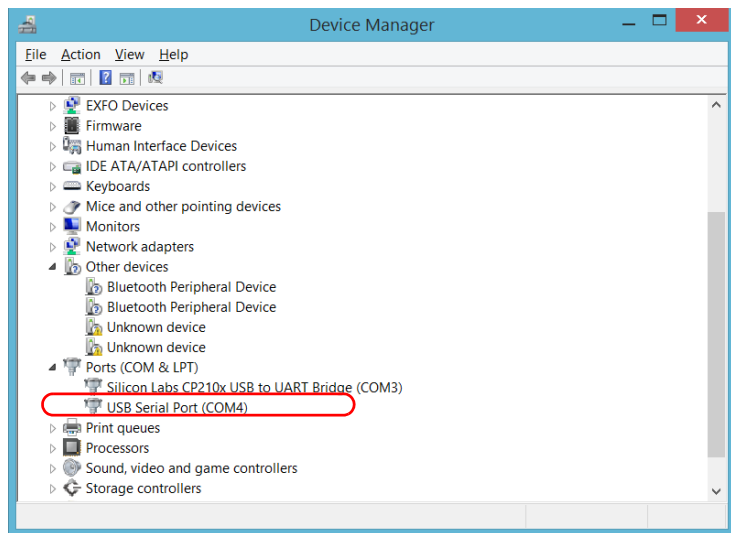

3f. Close the *Device Manager*.

Managing Data

Using the USB to RS-232 Adapter

4. From your unit, configure the communication parameters as follows:
 - 4a. From the main window, tap the **Utilities** button.
 - 4b. Tap **PuTTY**.
 - 4c. Configure the parameters.

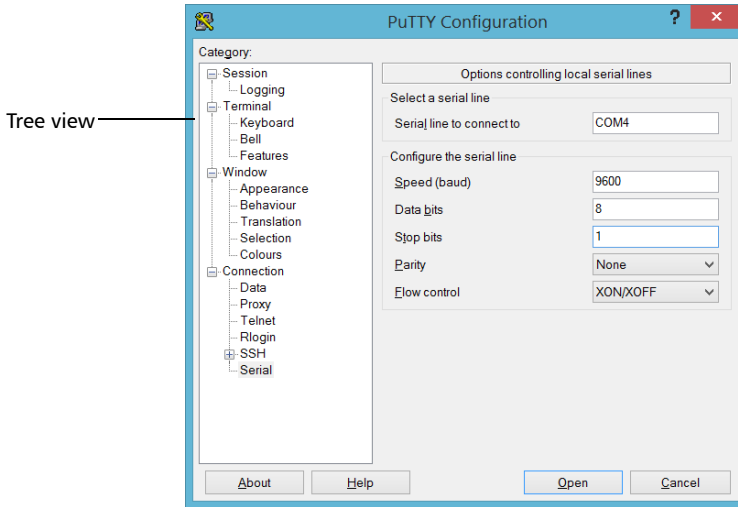

- From the tree view, select **Connection** > **Serial** and set the parameters as needed. Ensure that the COM port that you specify corresponds to the one that you wrote down at step 3e.
 - If you want to view the characters that you type on screen, from the tree view, select **Terminal**. Under **Local echo**, set the value to **Force on**.
 - From the tree view, select **Session**. Select **Serial**. The COM port number and the speed should correspond to those that you have previously entered.
- 4d. Tap **Open**. The unit is now ready to receive or send data.

5. From the device, set the communications parameters.



IMPORTANT

To be able to establish a communication between the unit and the device, you must set the following parameters to the same values as those defined on your unit:

- Speed
- Data bits
- Stop bit
- Parity
- Flow control

Note: *The COM port number that you set on your device will probably differ from the one that you used on your unit.*

6. From the device, establish communication with the unit using your favorite communication tool (PuTTY, HyperTerminal, etc.).

Freeing Up Disk Space with the Disk Cleanup Utility

If you need to free up disk space on your unit, you can use the Windows Disk Cleanup utility.

With this utility, you can clear files such as the Internet temporary files, files from the Recycle bin, or even files that you no longer need from the previous installation. The files from the previous installation are stored in the *Windows.old* folder that Windows creates automatically when you perform a refresh operation. To avoid losing data, you may want to back up files from this folder before removing it.

To free up disk space with the Disk Cleanup utility:

1. If desired, back up your data.

Note: *If you want to have a look at the content of the Windows.old folder containing files of the previous installation, go to the root of the C drive (Windows (C:)). If you do not see the Windows.old folder, it means no refresh operation has ever been performed on your unit.*

2. From the main window, tap the **System Settings** button.

3. Tap Control Panel.

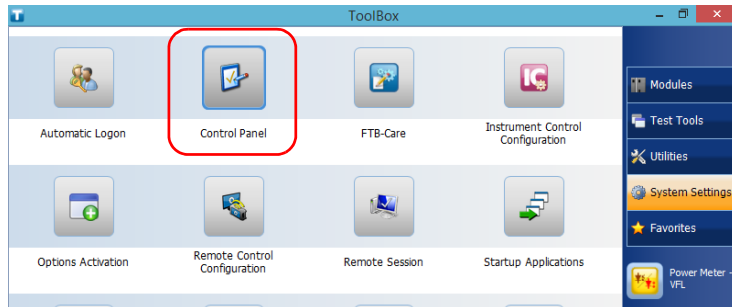

4. Tap System and Security.

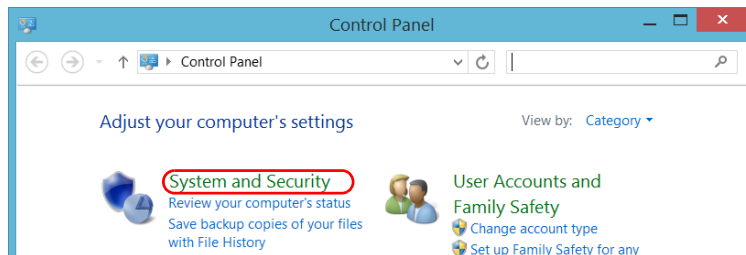

Managing Data

Freeing Up Disk Space with the Disk Cleanup Utility

5. Tap **Administrative Tools**, and then tap **Disk Cleanup**.

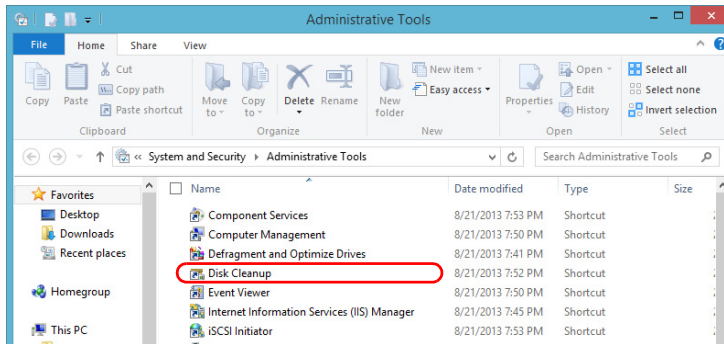

6. If you want to remove system files such as the files from the Windows.old folder, tap **Clean up system files**.

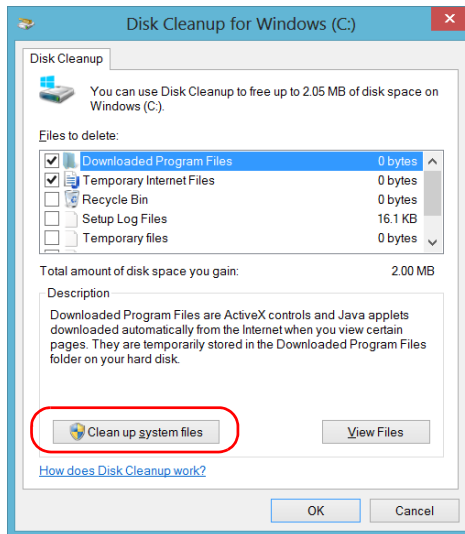

7. When the folders are displayed, select the check box corresponding to the desired item. If you want to clear the Windows.old folder, select the **Previous Windows installation(s)** check box. Ensure that all the other check boxes are cleared.

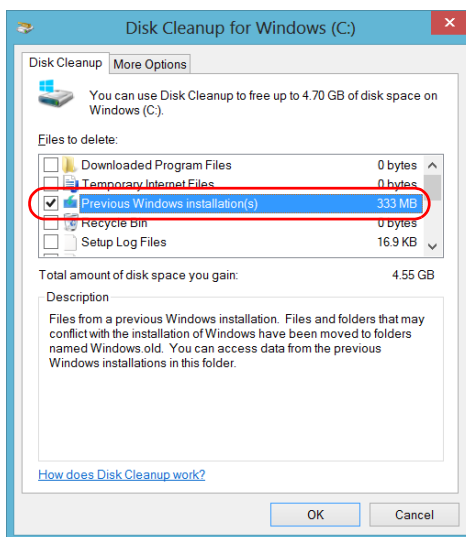

Note: *If you cannot see the **Previous Windows installation(s)** check box, this means that no refresh operation has been made on your unit yet.*

8. Tap **OK**.
9. When the application prompts you to confirm the deletion of the folder, tap **Delete Files**.

Connecting to a VPN from Your Unit

Note: *Only administrator-level users can install software under Windows. However, when the installation is complete, all users have the possibility to connect to the newly installed VPN from the unit.*

You can connect to a Virtual Private Network (VPN) from your unit if you use one of the VPN clients (applications) that are part of Windows 8.1 Pro, or provide your own compatible VPN client. Such clients allow you to connect to the VPN of your company from anywhere in the world and have access to network resources as if your unit was connected locally to the network. This could be useful if you need to transfer data to a centralized folder on the company's private network, for example.

To establish the communication between the VPN client and the VPN server, you can use either a 3G USB modem key (see *Accessing the Internet with a 3G USB Modem Key* on page 116) or a standard Ethernet connection.

Note: *Since all networks are different, the parameters that you need to configure before being able to connect to the VPN may vary. For information on the configuration specific to your network, contact your network administrator.*



IMPORTANT

EXFO does not provide any VPN clients. You must either use one of the VPN clients available directly in Windows or provide the installation files for another VPN client yourself.

EXFO will not provide any support regarding the VPN clients or connection.



IMPORTANT

To avoid communication problems between the VPN client and the VPN server, ensure that the date set on your unit corresponds to the current date.

To add a VPN connection:

1. From the right side of the screen, swipe left to display the Charm bar.
2. Tap **Settings** > **Change PC settings**.

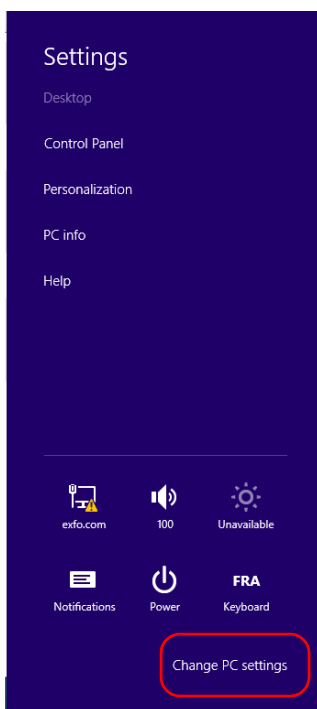

Managing Data

Connecting to a VPN from Your Unit

3. Tap **Network**.

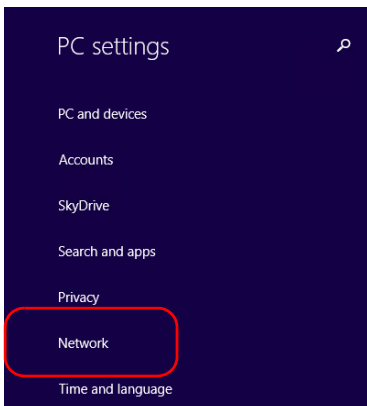

4. Tap **Connections**.

5. Tap **Add a VPN connection** and follow the on-screen instructions.



To install a VPN client on your unit:

1. If the date on your unit does not correspond to the current date, modify it (see *Adjusting the Date, Time and Time Zone* on page 94).
2. Start the installation of the VPN client using the files and settings provided by your network administrator.
3. Follow the on-screen instructions.

Once the installation is complete, all users will now be able to connect to a VPN from the unit.

To connect to a VPN from your unit:

1. From the main window, tap the **System Settings** button.
2. Tap **Control Panel**.

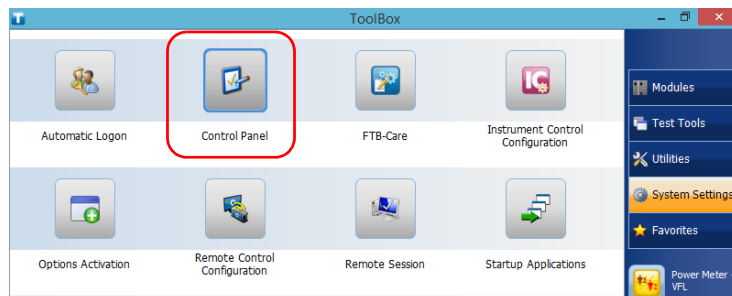

Managing Data

Connecting to a VPN from Your Unit

3. Tap Network and Internet.

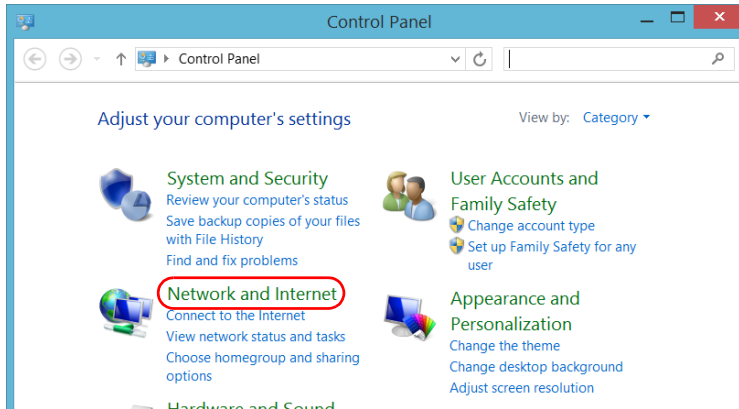

4. Under Network and Sharing Center, tap Connect to a network.

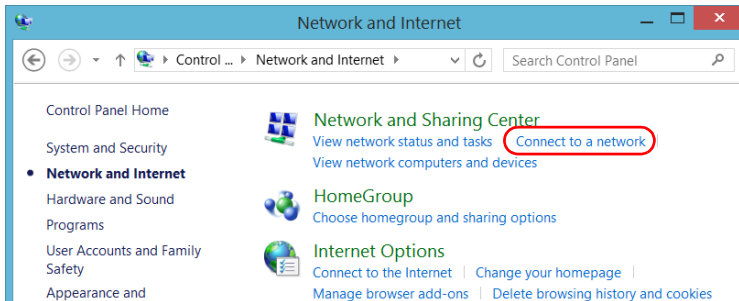

5. Under **Connections**, select the desired VPN connection.

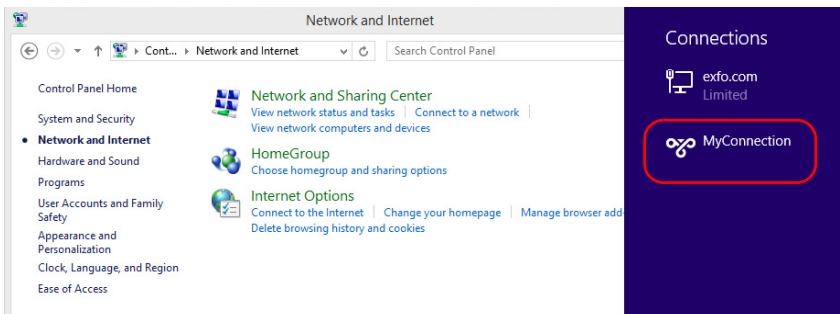

6. Follow the on-screen instructions.

If you are not sure about the information that you should provide, contact your network administrator.

Managing Data

Using Your Unit as an FTP Server

Using Your Unit as an FTP Server

If you want your unit to act as an FTP server, you can use the Internet Information Services (IIS) Manager. If you need information on the IIS Manager or on how to transfer files via an FTP server, refer to Windows online help.

To access the IIS Manager:

1. From the main window, select the **System Settings** tab.
2. Tap **Control Panel**.

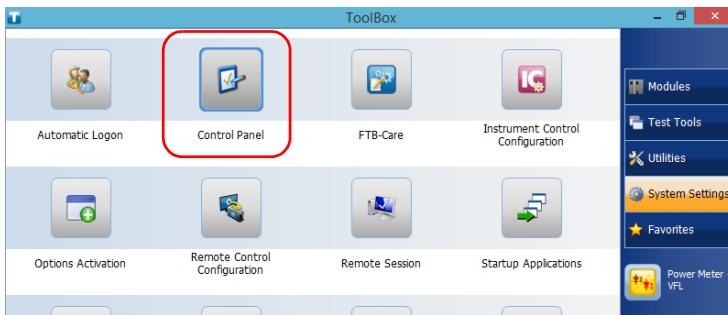

3. Tap **System and Security**.

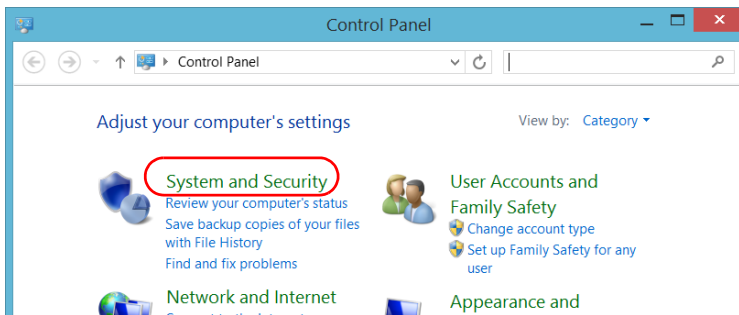

4. Tap Administrative Tools.

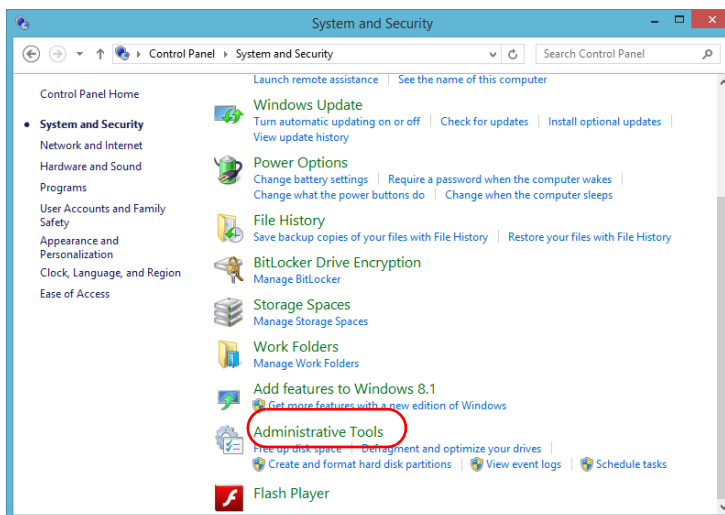

5. Select Internet Information Services (IIS) Manager.

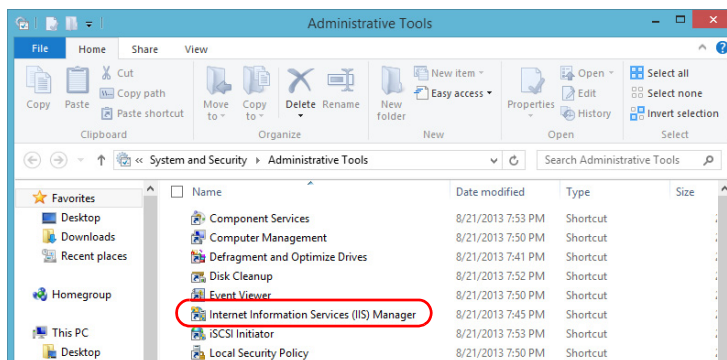

You are now ready to start working with the IIS Manager.

9 Accessing Your Unit Remotely

You can access your unit remotely from a computer using either the Remote Desktop Connection or TightVNC Client applications.

This could be particularly useful if you do not intend to perform automation tasks on your platform. If you prefer to perform automation tasks on your platform and modules, see *Preparing for Automation* on page 189, *Using FTB Products in an Automated Test Environment* on page 227, or *Preparing to Control Modules with a Dedicated Application* on page 222.

The table below presents the differences between the two applications.

Characteristic	Remote Desktop Connection	TightVNC Client
Type of connection	Direct between the unit and the computer; only one user can be connected to the unit at a time. Usually, the connection is made with the user name of the person currently logged on the unit. Otherwise, this person will be automatically disconnected.	Not exclusive; several users can be connected to the unit at the same time (sharing the same session).
Windows user rights	Taken into account.	Not taken into account.
Password-protected	Yes; mandatory. The user name and password are the same as those used to connect to the unit. By default, all the accounts with administrator rights can use Remote Desktop Connection. If you want accounts with limited rights to be able to use Remote Desktop as well, you must specifically grant them access.	Yes; mandatory. The password is defined on the TightVNC Server, the first time you start the server. This password is not related to the one used to connect to the unit. By default, all people that use TightVNC Client will enter the same password (as defined on the server). Each user to whom you provide the password will be able to connect to the unit via TightVNC.

Working with Remote Desktop

By default, the remote access to your unit with Remote Desktop is not enabled. However, once you enable it, all the accounts with administrator rights can use Remote Desktop. If you want accounts with limited rights to be able to use it as well, you must specifically grant them access.

You can also configure the unit to prevent users from accessing it remotely.

Accessing Your Unit with Remote Desktop

To be able to connect to the unit using Remote Desktop, you must:

- Allow the remote access to your unit (only necessary the first time that you access your unit with Remote Desktop).
- Know the IP address of the unit and provide it in the connection settings on the computer.

Note: *If your unit and the computer are on the same network, you can even use the computer name of your unit, which corresponds to “F500-” followed by its serial number. You can view the computer name of your unit from **System Settings > Remote Session > Computer Name**.*

- Use an account that is secured by a password. Remote Desktop will not allow any connection with empty passwords.
- Enter the appropriate user name when Remote Desktop application prompts you. Usually, this user name must correspond to the user name of the person currently logged on the unit. Otherwise, you will disconnect the person that was already connected.

To allow the remote access to your unit with Remote Desktop:

1. From the main window, tap the **System Settings** button.
2. Tap **Remote Session**.

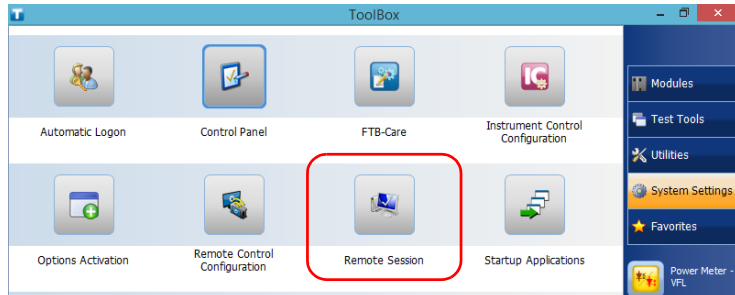

3. Under **Remote Desktop**, select **Allow remote connections to this computer**.

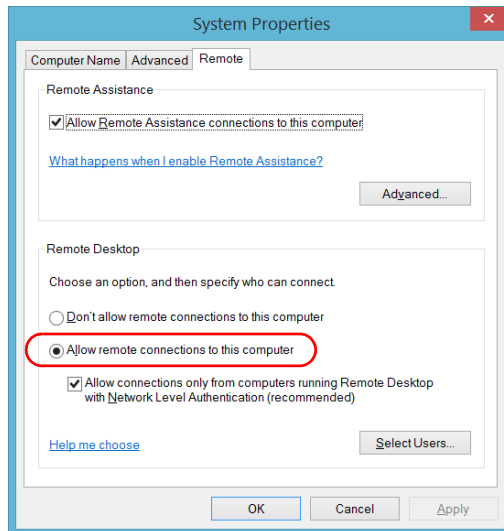

4. Tap **OK** to confirm the changes and return to the **System Settings** window.

Accessing Your Unit Remotely

Working with Remote Desktop

To access your unit remotely with Remote Desktop:

1. Connect both the computer and your unit to the same network and make sure they can “see” each other as network restrictions might prevent them from communicating.
 - If you want to use an Ethernet network, connect an RJ-45 (network) cable to the unit’s Ethernet (RJ-45) port located on its right panel.
 - If you want to use a wireless network, see *Connecting to a Wireless Network* on page 146.
 - You could also create a Private Area Network with your Bluetooth device (contact your network administrator).
2. Turn on both the computer and the unit.
3. On your unit, from Toolbox, tap the  button (located at the bottom of the button bar).
4. Select the **Platform** tab, write down the IP address, and then close the window.

Note: *It may take a few seconds before you see the IP address on the list.*

5. From the computer, open the Remote Desktop Connection window.
 - If your computer runs Windows Vista or Windows 7: On the taskbar, click **Start**, then select **All Programs > Accessories > Remote Desktop Connection**.
 - If your computer runs Windows 8: On the taskbar, point the lower left corner, and then click the **Start** screen icon. Right-click the bottom of the screen, and then click **All apps**. Under **Windows Accessories**, select **Remote Desktop Connection**.
 - If your computer runs Windows 8.1: On the taskbar, click the **Start** button () , then under **Windows Accessories**, select **Remote Desktop Connection**.

6. In the **Connecting to Remote Desktop** window, in the **Computer** list, type the IP address of the unit that you wrote down at step 4.

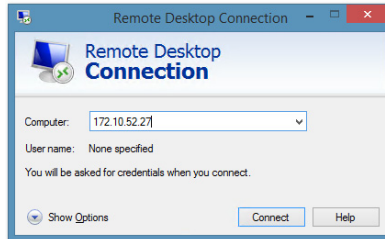

7. Click **Connect**.
8. When the application prompts you, enter your user name and password.
9. Click **OK** to open the session.

Accessing Your Unit Remotely

Working with Remote Desktop

Allowing Users with Limited Accounts to Use Remote Desktop

By default, only the accounts with administrator rights can use Remote Desktop. However, you can assign extra user rights to accounts with limited rights so that they can also use Remote Desktop.

To allow a user with limited accounts to use Remote Desktop:

1. From the main window, tap the **System Settings** button.
2. Tap **Remote Session**.

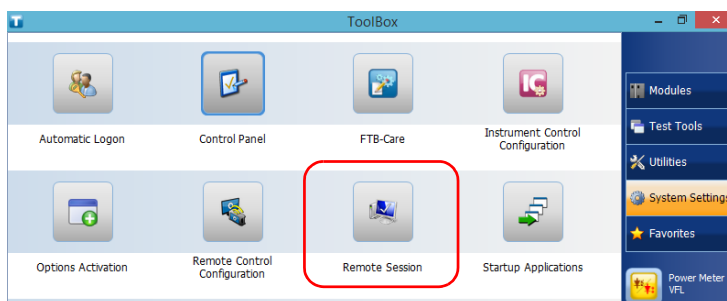

3. Under **Remote Desktop**, select **Allow remote connections to this computer**.

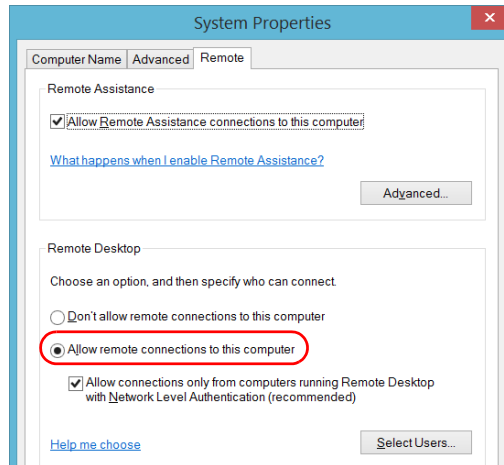

4. Tap **Select Users**.
5. From the **Remote Desktop Users** dialog box, tap **Add**.

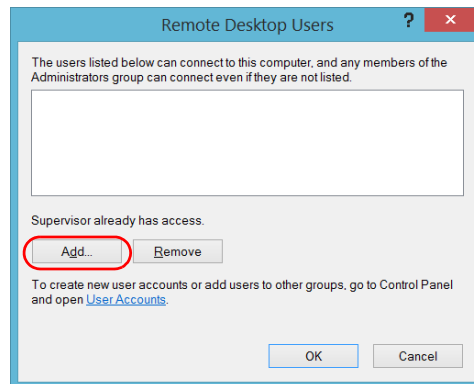

Accessing Your Unit Remotely

Working with Remote Desktop

- From the **Select Users** dialog box, tap **Advanced**.

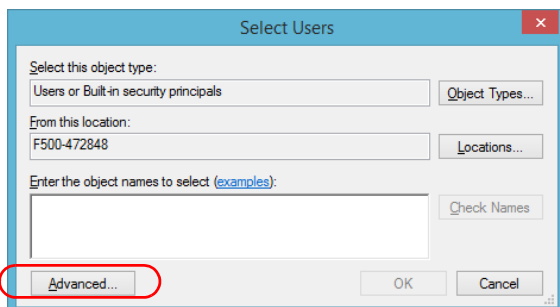

- Tap **Find Now** to let the system find and display the list of users.

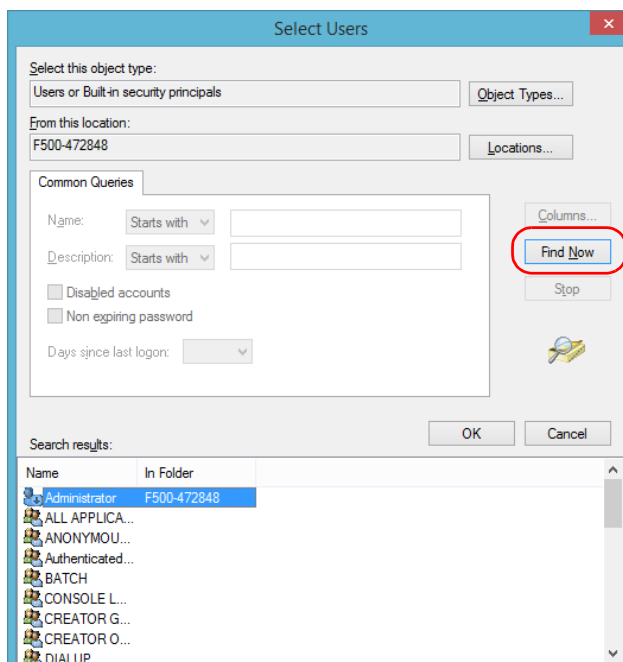

- Select the user to which you want to grant access rights, and then tap **OK**.

9. From the list of users, select the user that you have just added, and then tap **OK**.

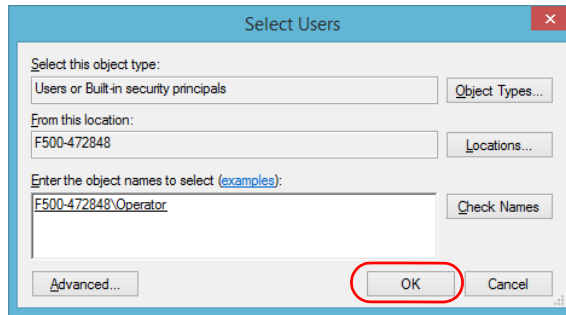

10. Repeat steps 7 to 9 with all the users to which you want to grant access rights.
11. From the **Remote Desktop Users** dialog box, tap **OK**.
12. From the **System Properties** dialog box, tap **OK** to confirm the changes and return to the **System Settings** window.

Accessing Your Unit Remotely

Working with Remote Desktop

Preventing Users from Connecting with Remote Desktop

You can also configure the unit to prevent users to access it using Remote Desktop. However, all users having administrator user rights will be able to modify this setting at any time.

To prevent users from connecting to the unit using Remote Desktop:

1. From the main window, tap the **System Settings** button.
2. Tap **Remote Session**.

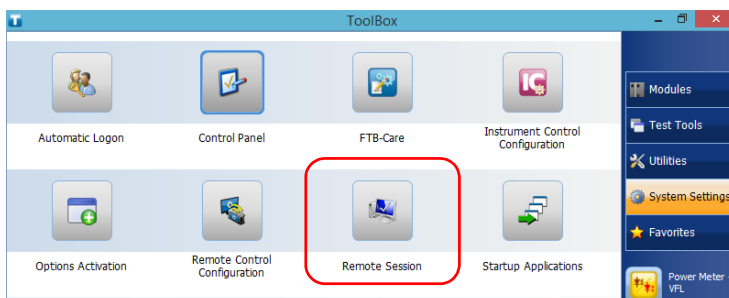

3. Under **Remote Desktop**, select **Don't allow remote connections to this computer**.

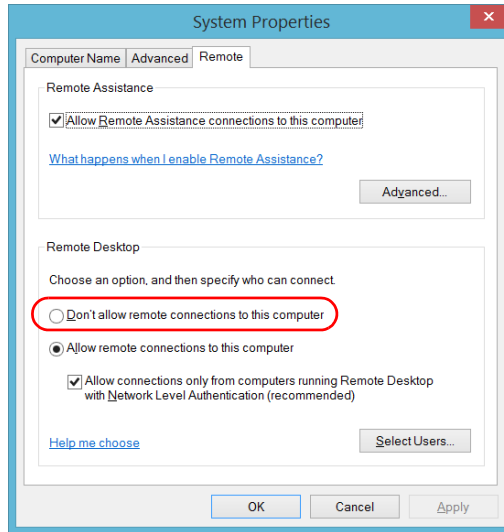

4. Tap **OK** to confirm the changes and return to the **System Settings** window.

Working With TightVNC

The control of your unit with TightVNC requires the TightVNC Server (already installed on your unit) and the TightVNC Client Viewer (that you must install on your computer).

To be able to connect to the unit using TightVNC, you must:

- Know the IP address of the unit and provide it in the connection settings on the computer.
- Know the password (same for all users by default).

This section provides you with the basic information to control your unit with TightVNC. For more information, refer to the TightVNC online help.

Configuring the TightVNC Server

The TightVNC Server is already installed on your unit. By default, the server is configured to accept secured connections only. This means that you must configure a password before establishing a connection between a computer and your unit.

However, you can modify the desired type of connection if you prefer not to be prompted for a password. You can also modify other connection settings to better suit your needs.

To configure the TightVNC Server:

1. From the notification area, tap the TightVNC icon.

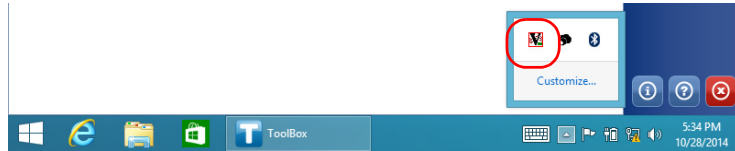

2. Select the **Server** tab.
3. Under **Incoming Viewer Connections**, ensure that **Accept incoming connections** is selected.

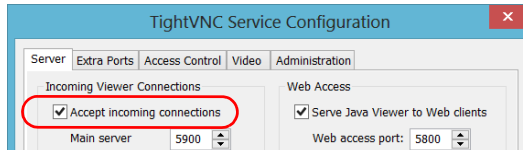

4. If you want to secure the connection with a password, select the **Require VNC authentication** check box. If you prefer not to be prompted for a password when you connect with TightVNC, clear the check box.

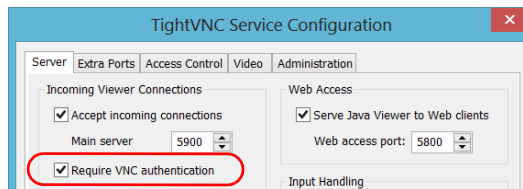

Accessing Your Unit Remotely

Working With TightVNC

5. If you prefer a connection secured with a password, proceed as follows:
 - 5a. Depending on the type of connection that you want, under **Primary password** or **View-only password**, tap the corresponding **Set** button.

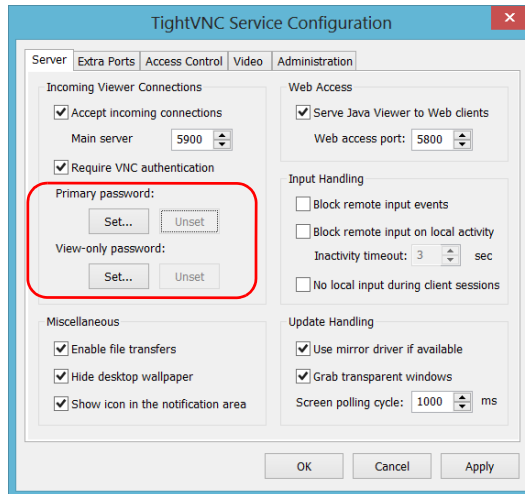

- 5b. Type the desired password, and confirm it.

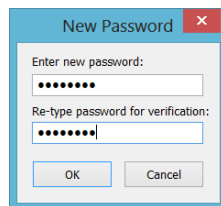

- 5c. Tap **OK** to keep the new password.

Note: *The primary and view-only passwords are independent of each other. They do not have to be identical.*

6. Tap **Apply**, and then **OK**.

Installing the TightVNC Viewer on a Client Computer

If the TightVNC Viewer is not already installed on your computer, you can download it from the Web for free.



IMPORTANT

EXFO does not provide licenses for TightVNC Viewer. Always ensure that you are entitled to install it on your computer.

To install the TightVNC Viewer on your computer:

1. Open a Web browser and go to <http://www.tightvnc.com/>.
2. Download the version of the viewer that corresponds to the operating system that your computer is running.
3. Double-click the file that you have just downloaded to start the installation.
4. Follow the on-screen instructions.

Connecting to Your Unit with TightVNC

Once the TightVNC Viewer is installed on your computer, you are ready to access your unit remotely.

To connect to your unit with TightVNC:

1. Connect both the computer and your unit to the same network and make sure they can “see” each other as network restrictions might prevent them from communicating.
 - If you want to use an Ethernet network, connect an RJ-45 (network) cable to the unit’s RJ-45 port located on its right panel.
 - If you want to use a wireless network, see *Connecting to a Wireless Network* on page 146.
 - You can also create a Private Area Network with your Bluetooth device (see *Transferring Data via Bluetooth* on page 139).
2. Turn on both the computer and the unit.
3. On your unit, ensure that ToolBox is open.
4. At the bottom of the button bar, tap .
5. Tap **Platform**.
6. Scroll down until you can see the IP address.

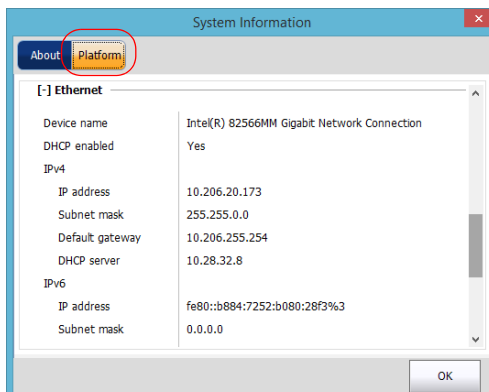

7. Write down the IP address, and then close the window.

Note: *It may take a few seconds before you see the IP address on the list.*

8. From your computer, start the TightVNC Viewer.
9. In the **Remote Host** list, type the IP address of your unit that you wrote down at step 7.

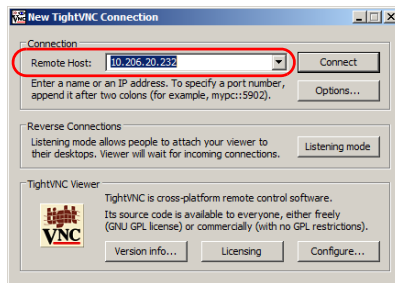

Note: *The appearance of the TightVNC Viewer window may vary depending on the version of the viewer that you have.*

10. Click **Connect**.
11. If the application prompts you for a password, enter it and click **OK** to confirm.

Accessing Your Unit Remotely

Adding Exceptions to the Firewall

Note: Only administrator-level users can add exceptions to the firewall.

Your unit is protected by the Microsoft firewall to prevent unauthorized access when it is connected to a network or to the Internet. The firewall has been preconfigured so that all the applications that come with your unit work properly. However, you can allow other applications to access the network or the Internet by adding exceptions.

If you are not sure about how to configure the firewall, contact your network administrator.

To add exceptions to the firewall:

1. From the main window, tap the **System Settings** button.
2. Tap **Control Panel**.

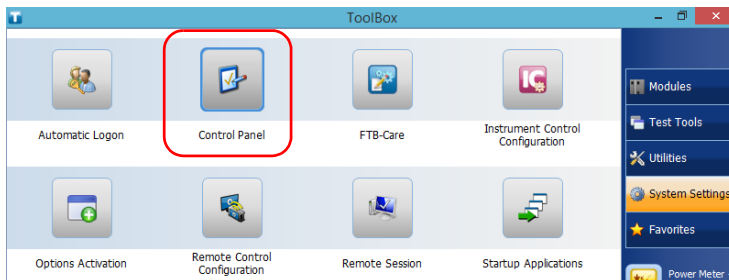

3. Tap **System and Security**.

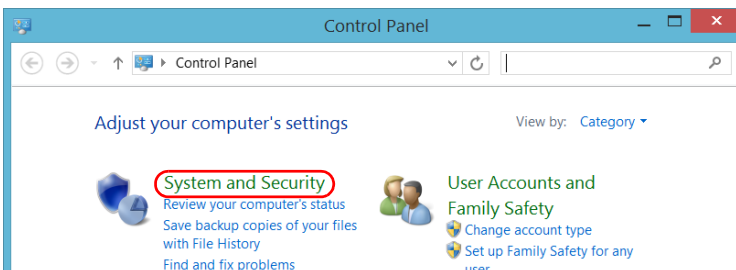

4. Under **Windows Firewall**, tap **Allow an app through Windows Firewall**.

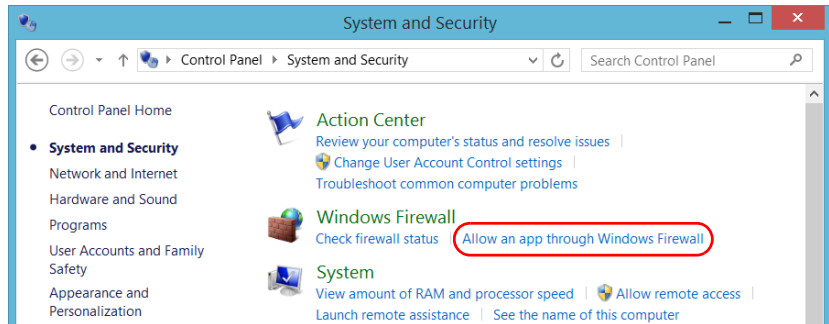

5. Tap the **Change settings** button.

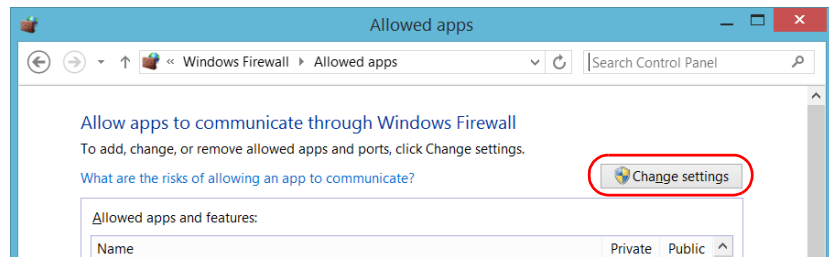

Accessing Your Unit Remotely

Adding Exceptions to the Firewall

6. Tap the **Allow another app** button.

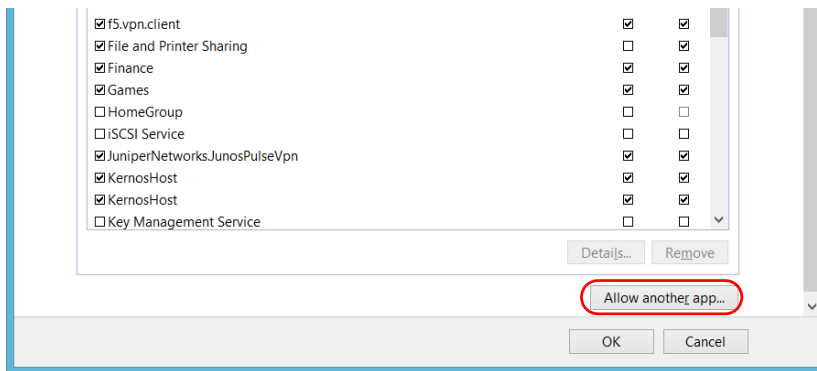

7. Select the desired application from the list, and then tap **Add**.

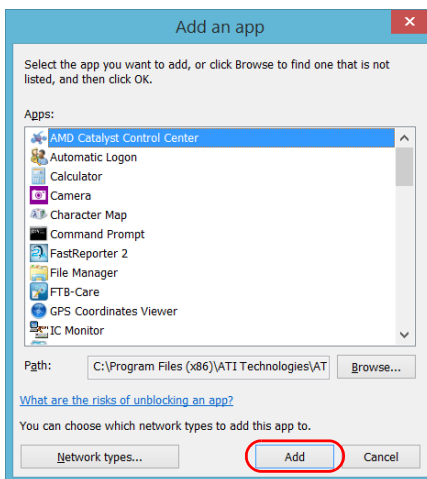

8. Ensure that the **Private** and **Public** settings of the added application suit your needs.

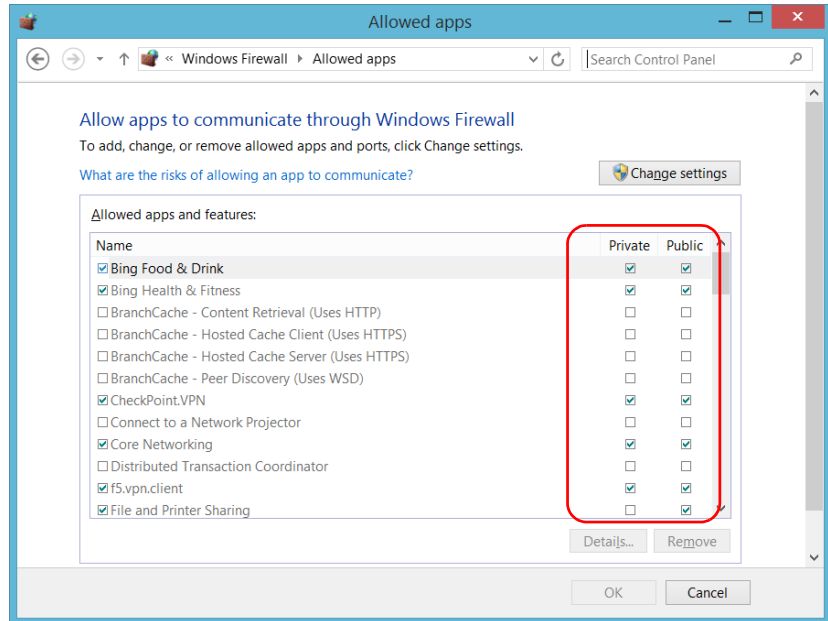

9. When you have finished, tap **OK** to confirm the changes and return to the **Control Panel** window.

10 Preparing for Automation

Your unit was designed to meet the requirements of automation and to facilitate its integration with your test environment.

EXFO supplies commands that follow the guidelines determined by the SCPI consortium and LabVIEW drivers for many instruments. EXFO also supplies COM properties and events allowing you to build your own application. The instruments can be controlled either locally or remotely via the following technologies:

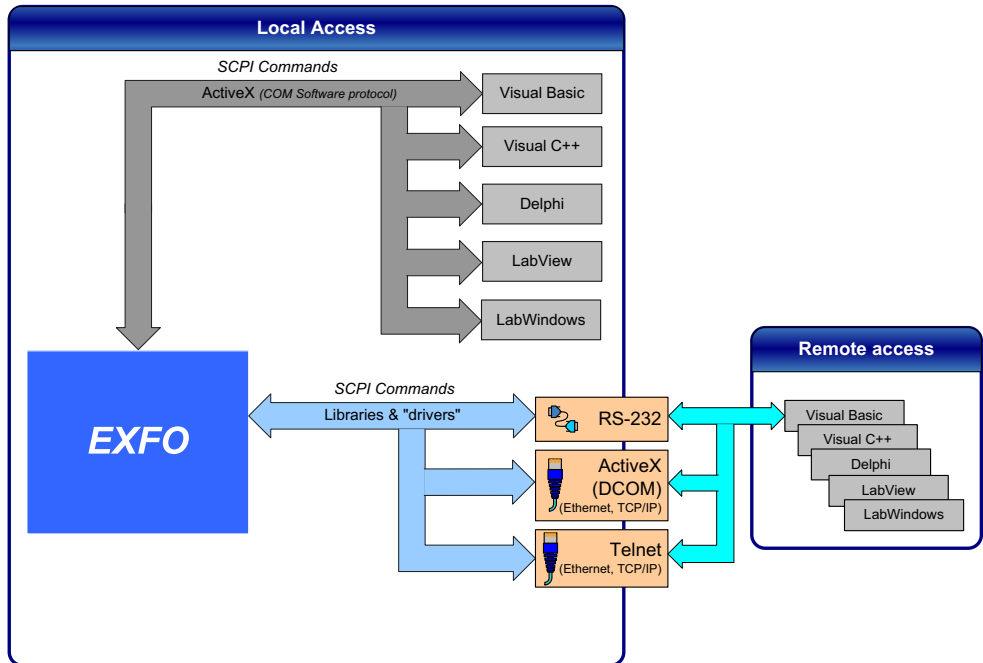

Preparing for Automation

The choice of a technology depends on your particular needs.

Control	Technology	Characteristics
Local	ActiveX (COM)	<ul style="list-style-type: none">▶ Allows you to develop an application that will run locally on your unit within Windows▶ Best approach when speed is your top priority (no physical connection that slows down the process)▶ Supported by most development software▶ Lower cost
Remote	ActiveX (DCOM) (Ethernet, TCP/IP)	<ul style="list-style-type: none">▶ Allows the sharing of network resources▶ Allows you to develop computer-based applications to directly communicate with your unit
Remote	RS-232	<ul style="list-style-type: none">▶ Null-modem cable required to establish connection between the computer and your unit▶ For increased speed and performance, run the application locally on your unit through ActiveX instead of using RS-232
Remote	Telnet (Ethernet, TCP/IP)	<ul style="list-style-type: none">▶ Your unit can be directly connected to a Local Area Network (LAN) or Wide Area Network (WAN) via its 10/100/1000 Base-T interface▶ Allows the sharing of network resources▶ Allows you to develop computer-based applications very easily to directly communicate with your unit

Note: *When the unit is remotely controlled, its front-panel keys and peripherals remain functional at all times (they are not locked).*

For more information on programming aspects, see the section on using your product in an automated test environment.

Linking Units with the Ethernet Port

Your unit is equipped with an Ethernet port (10/100/1000) to send and receive data. Refer to the Windows documentation for information about Ethernet port settings and possibilities.

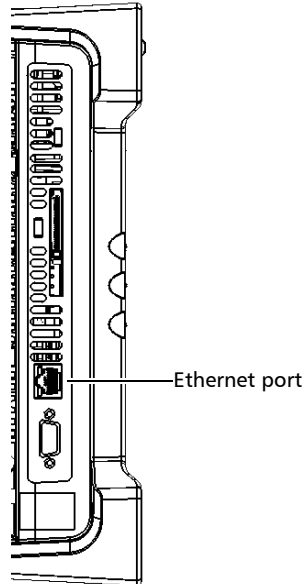

Preparing for Automation

Linking Units with the Serial Port

Linking Units with the Serial Port

Your unit is equipped with a serial (RS-232) port to send and receive data. Refer to the Microsoft Windows documentation for information about serial port settings and possibilities.

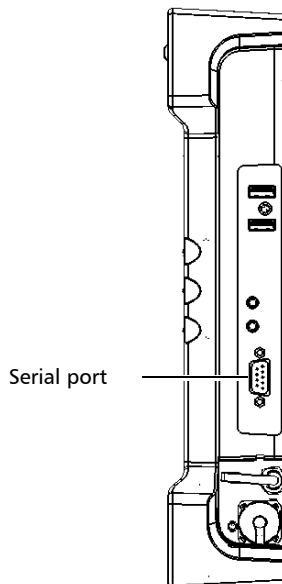

Getting Optimum Performance from Your Unit

Several factors influence the data transfer rate of your unit. The information presented hereafter will help you get the best transfer rate possible.

- *Output unit (RS-232, ActiveX and TCP/IP):* Your unit can return results in
 - linear units (for example, watts)
 - log units (for example, dBm)

Since internal units are linear, you will get optimal performance by using linear units for output (no need for an internal conversion to log).

Note: *You must make the choice of output unit for each instrument offering such a feature. Refer to the user guide of each optical instrument for a list of available commands and queries.*

Preparing for Automation

Getting Optimum Performance from Your Unit

- *Output format (RS-232, ActiveX and TCP/IP):* Your unit provides the following output formats for measurement results:
 - ASCii
 - PACKed

Generally, the PACKed format allows to pass three to four times more information than the ASCii format for the same transfer rate. Often, the PACKed format is also more efficient since it reduces your unit's CPU work load (no need for an internal conversion to ASCII format).

Note: *The PACKed format will only be applied to <DEFINITE LENGTH ARBITRARY BLOCK RESPONSE DATA> and <INDEFINITE LENGTH ARBITRARY BLOCK RESPONSE DATA>.*

Note: *The choice of data format cannot be made directly via the ToolBox software.*

For more information on how to set the output format and data types, see *:FORMat[:DATA](IEEE 488.2 and specific commands appendix)*, *Read* and *ReadBinary* (COM properties and events appendix), and the data types appendix.

Changing Communication Settings

Communication settings cannot be modified without turning on your unit and starting ToolBox.

To change communication settings:

1. Tap the **System Settings** button, then tap **Instrument Control Configuration**.

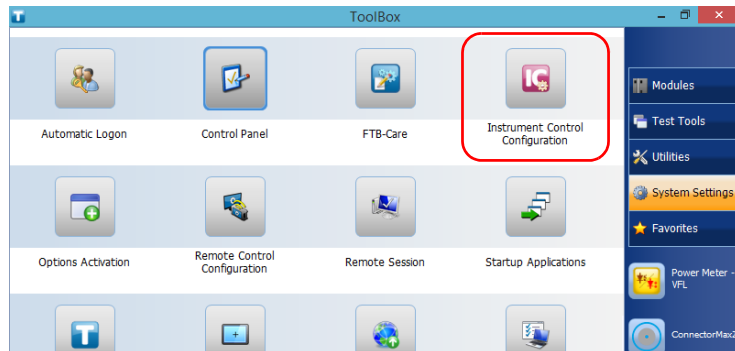

2. Tap **Change settings**, and then, when the application prompts you to authorize the changes to your unit (identified as “computer”), tap **Yes**.

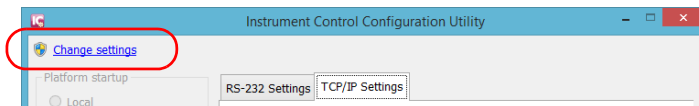

Preparing for Automation

Changing Communication Settings

- Under **Platform Startup**, determine whether your module applications will be started locally or remotely by clicking the corresponding option.
 - If **Local** mode is selected, you will not be able to send remote commands to your unit.
 - If **Remote** mode is selected, all modules in your unit will be initialized upon startup so you are ready to send remote commands.

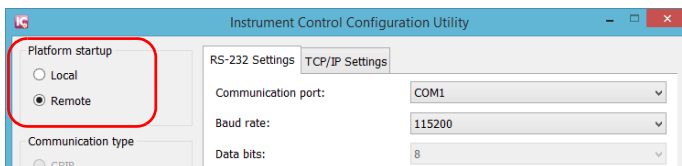

If you selected **Local** mode, you can go directly to step 6.

- Under **Communication Type**, select **ActiveX**, **RS-232**, or **TCP/IP**.

For more information on the choice of a particular type, see the table on page 190.

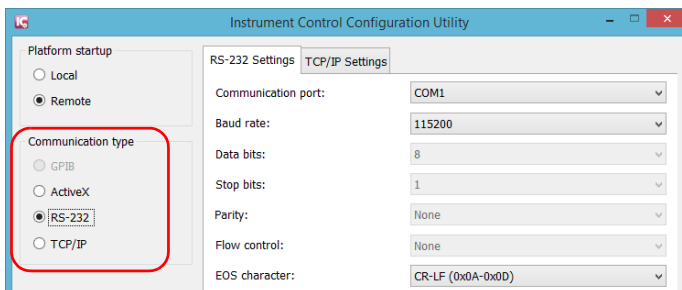

Note: If the selected communication type does not match the protocol that will actually be used, an error message is displayed when attempting to control the instruments.

5. According to the communication type you have selected, customize the corresponding parameters as shown below.

➤ For RS-232

Serial port—used to connect the RS-232 cable.
The only available value is COM1.

Determines the speed at which data is sent between the unit and a computer, in bits per second (b/s).

End-of-string (EOS) character—used to indicate the end of a data string (when sending or receiving data).

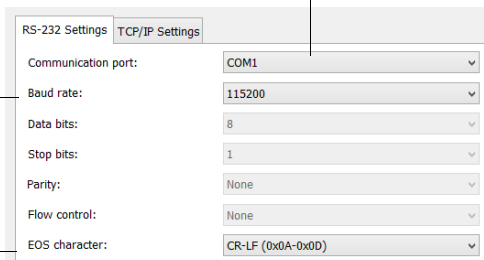

The screenshot shows a configuration window with two tabs: 'RS-232 Settings' and 'TCP/IP Settings'. The 'RS-232 Settings' tab is active. It contains several dropdown menus for configuration: 'Communication port' (set to COM1), 'Baud rate' (set to 115200), 'Data bits' (set to 8), 'Stop bits' (set to 1), 'Parity' (set to None), 'Flow control' (set to None), and 'EOS character' (set to CR-LF (0x0A-0x0D)).

➤ For TCP/IP

TCP/IP port 5024—used to connect over Telnet.



The screenshot shows a configuration window with two tabs: 'RS-232 Settings' and 'TCP/IP Settings'. The 'TCP/IP Settings' tab is active. It contains a dropdown menu for 'Port' (set to SCPI-Telnet (Port 5024)).

For information on communicating with TCP/IP over Telnet, see the section pertaining to communication through TCP/IP over Telnet.

6. Tap **Apply** to confirm your changes.

Preparing for Automation

Changing Communication Settings

To revert to default general settings:

1. Tap the **Restore Default Settings** button.

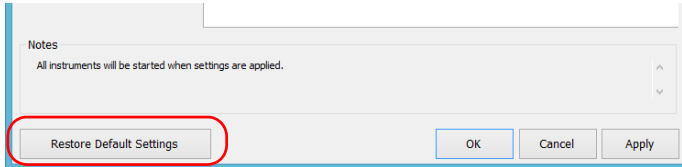

2. Tap **Apply** to confirm your changes.

To revert to default RS-232 settings:

1. Tap the **Default RS-232 Settings** button.

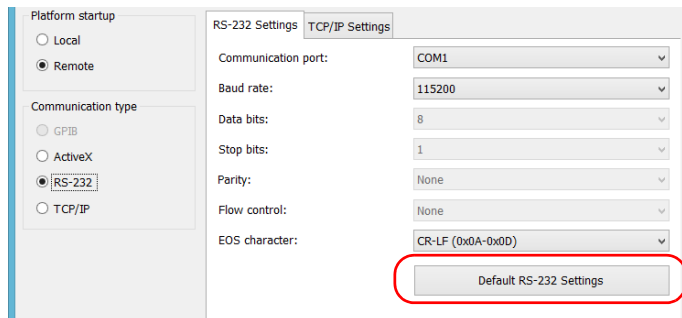

2. Tap **Apply** to confirm your changes.

Configuring DCOM Access to Your Unit

DCOM technology allows to control devices and optical instruments via Ethernet. The EXFO IcSCPIAccess Class component provided with your unit acts as a communication link between a client application and EXFO's Instrument Control. For more information, refer to the EXFO Remote Control Demo available in EXFO Apps, at <http://www.exfo.com/software/exfo-apps/exfo-remote-control-demo>.

DCOM ensures communication between the client application and Instrument Control via your local network. Since each network has its own configuration, you need to be familiar with network security, users, groups, domain management, etc. Basic programming skills are also required to work with DCOM. For more information, you can refer to the Microsoft MSDN Help feature, which provides exhaustive technical documentation on all DCOM issues.

The example presented in the following pages illustrates how to make the EXFO IcSCPIAccess Class component available to all users of a local network under Windows 8.1 Pro. The example provided below is for guidance only; it may not work properly with all networks and interfaces may slightly differ depending on the operating system used.

To enable DCOM access to your unit, you must:

- set the general security parameters
- customize the specific security parameters
- register callback events.

Preparing for Automation

Configuring DCOM Access to Your Unit

Setting the General Security Parameters

Note: To modify the security parameters, you need administrator access rights.

To set the general security parameters:

1. From the main window, tap the **System Settings** button.
2. Tap **Control Panel**.
3. Tap **System and Security > Administrative Tools**.
4. Tap **Component Services**.
5. In the **Component Services** dialog box, go to **Console Root > Component Services > Computers**.

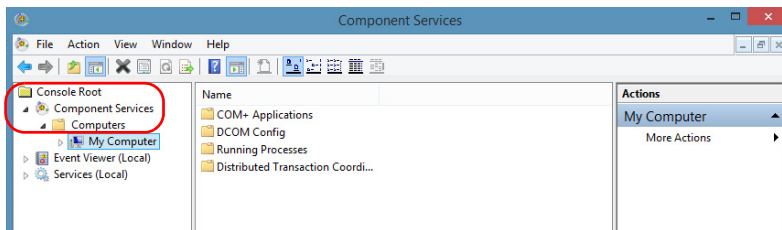

6. Right-click **My Computer**, and then select **Properties**.

7. In the **My Computer Properties** dialog box, tap the **COM Security** tab.
8. Under **Access Permissions**, tap **Edit Limits**.

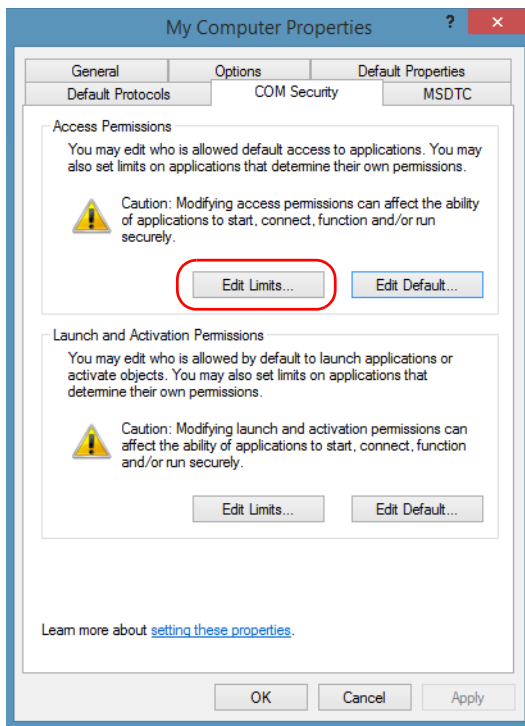

Preparing for Automation

Configuring DCOM Access to Your Unit

9. In the **Access Permission** dialog box, ensure that the **Distributed COM Users** appears in the **Group or user names** list.

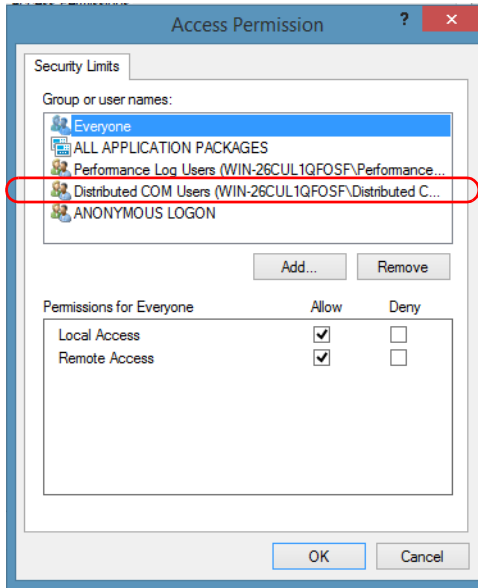

10. Tap **OK**.

11. In the **My Computer Properties** dialog box, tap the **COM Security** tab.

12. Under **Launch and Activation Permissions**, tap **Edit Limits**.

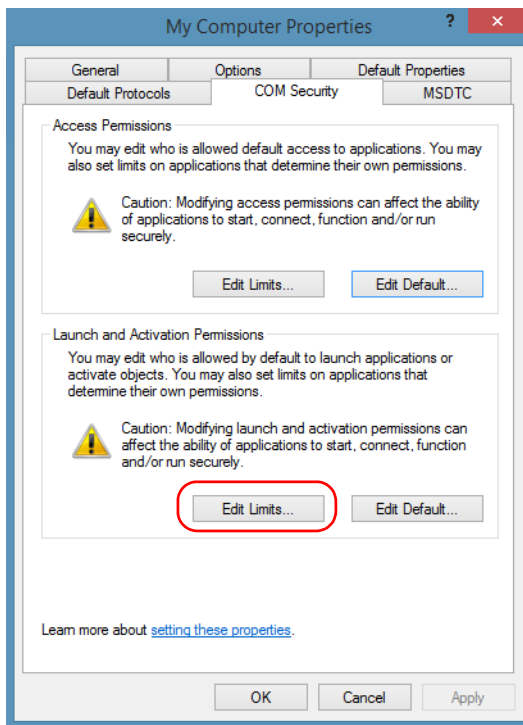

Preparing for Automation

Configuring DCOM Access to Your Unit

- 13.** In the **Access Permission** dialog box, ensure that the **Distributed COM Users** appears in the **Group or user names** list.

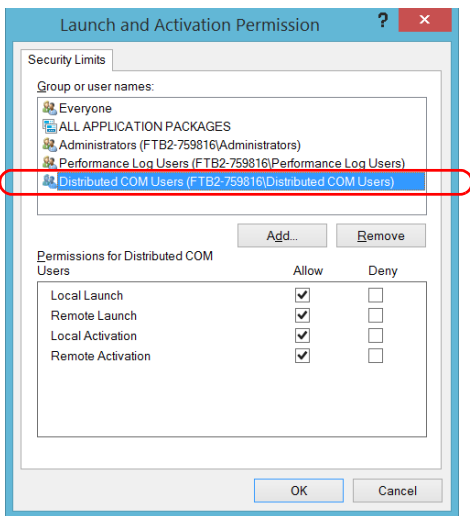

You can now allow users to access general DCOM services on your unit.
You can either:

- Add a user to the **Distributed COM Users** group (refer to Microsoft help).
- OR
- Add a user explicitly and define both, access and launch permissions (see procedure below).

Note: *If you add a user explicitly, ensure to give remote access rights to the new user.*

To add a user explicitly:

1. In the **My Computer Properties** dialog box, tap the **COM Security** tab.
2. Under **Access Permission**, tap **Edit Limits**.
3. In the **Access Permission** dialog box, tap **Add**.

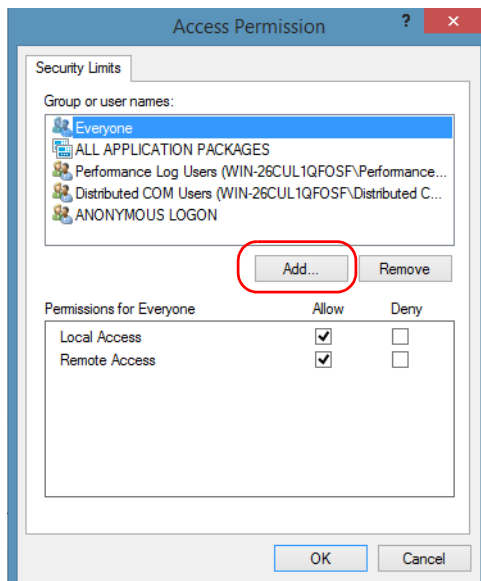

Preparing for Automation

Configuring DCOM Access to Your Unit

4. In the **Select Users or Groups** dialog box, under **Enter the object names to select**, type the name of the user to whom you want to give access rights.

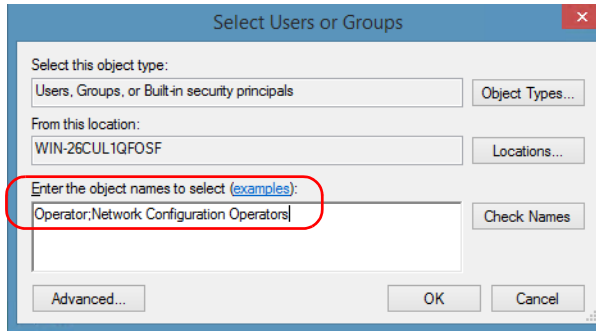

5. Tap **OK**.

6. Confirm the newly added user has remote access permission as follows:
 - 6a. In the **Access Permission** dialog box, select the name of the new user.

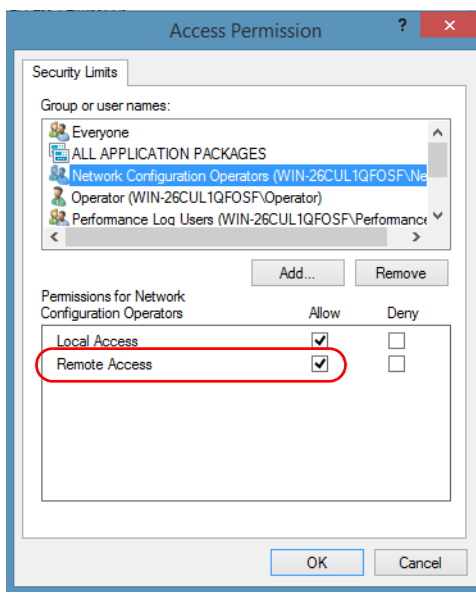

- 6b. Under **Permissions for** (new user), ensure **Allow** is selected for **Remote Access**.
 - 6c. Tap **OK**.
7. In the **My Computer Properties** dialog box, tap the **COM Security** tab.
8. Under **Launch and Activation Permissions**, tap **Edit Limits**.

Preparing for Automation

Configuring DCOM Access to Your Unit

9. In the **Launch and Activation Permission** dialog box, tap **Add**.

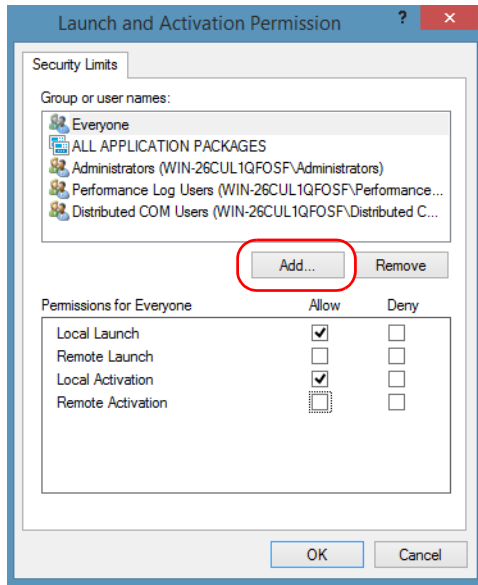

10. In the **Select Users or Groups** dialog box, under **Enter the object names to select**, type the name of the user to whom you want to give start and activation access rights.

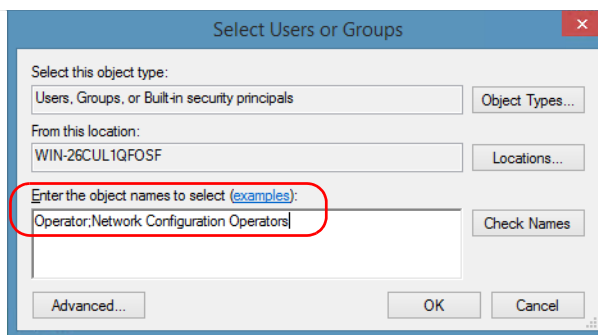

11. Tap **OK**.

12. Confirm the newly added user has **Remote Launch** and **Remote Activation** permissions as follows:

12a. In the **Launch Permission** dialog box, select the name of the new user.

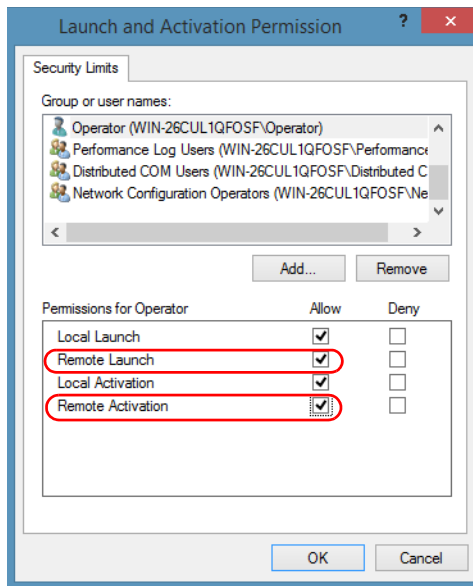

12b. Under **Permissions for** (new user), ensure **Allow** is selected for both **Remote Launch** and **Remote Activation**.

12c. Tap **OK**.

Customizing the Specific Security Parameters

Once you have defined the general security parameters, you can define the specific security parameters.



IMPORTANT

Customizing access rights sets both remote AND local permissions. As a result, you will have to specify every user who must have local access to the system (see *Setting the General Security Parameters* on page 200).

If you do not specify local access rights, no user will be able to access EXFO KernosHost and, therefore, no user will be able to start ToolBox.

To customize the specific security parameters:

1. From the **Component Services** window, select: **Console Root > Component Services > Computers > My Computer > DCOM Config** to show the contents of the **DCOM Config** folder.

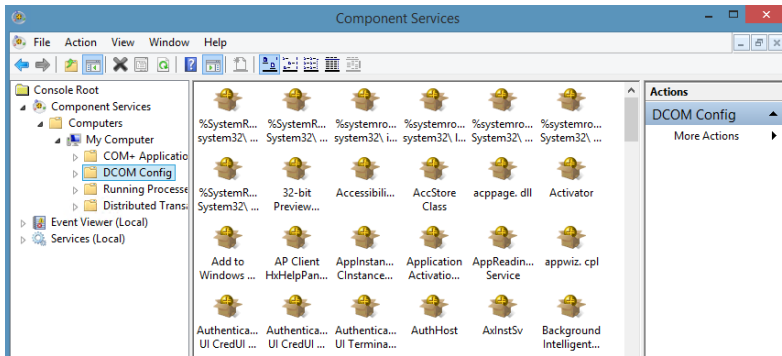

2. From **DCOM Config**, right-click **EXFO KernosHost**, and select **Properties**.

3. Tap the **General** tab.
4. In the **Authentication Level** list, select **Default**.

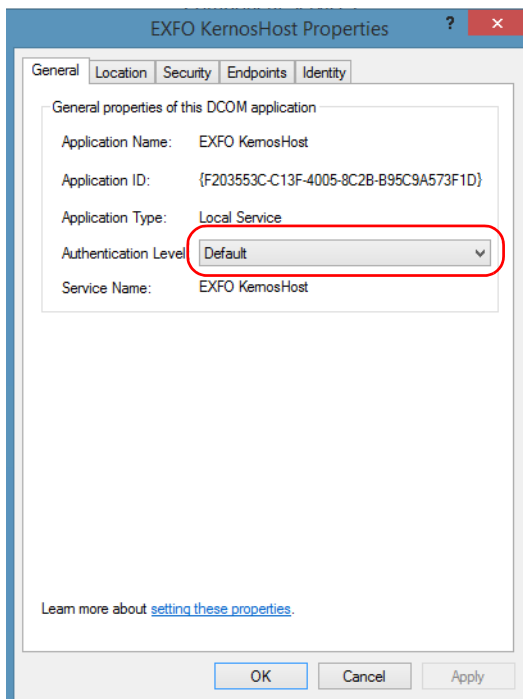

Preparing for Automation

Configuring DCOM Access to Your Unit

5. In the **EXFO KernosHost Properties** dialog box, tap the **Security** tab.
6. Under **Launch and Activation Permissions**, select **Customize**, and then click **Edit** to edit the list of allowed users.

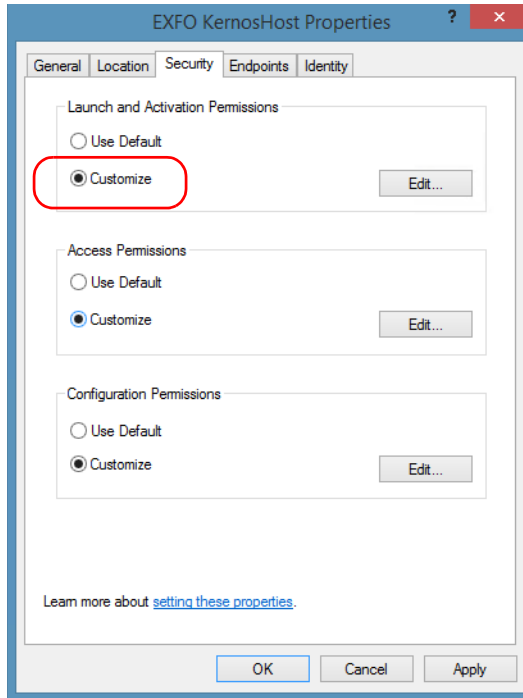

- 7.** In the **Launch and Activation Permission** dialog box, tap **Add**.

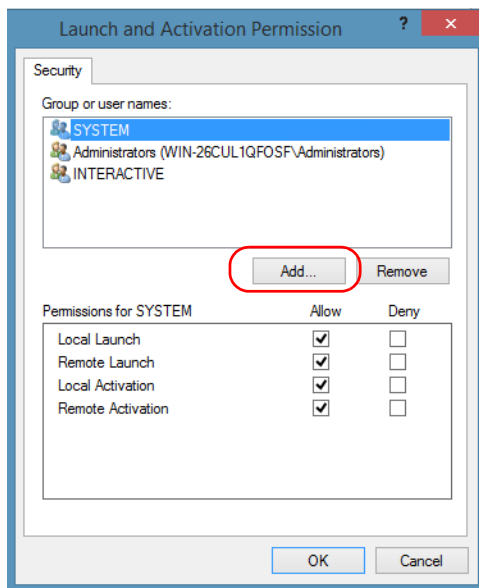

- 8.** In the **Select Users or Groups** dialog box, under **Enter the object names to select**, type the name of the user to whom you want to give start and activation permissions for remote access.

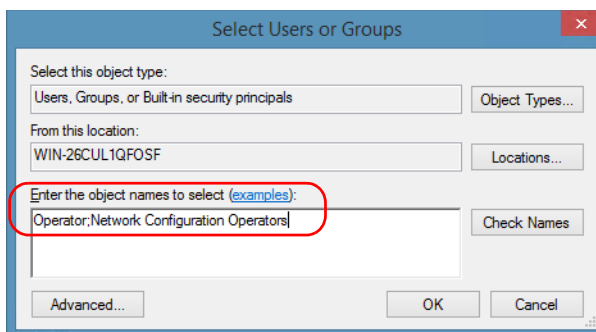

- 9.** Tap **OK**.

Preparing for Automation

Configuring DCOM Access to Your Unit

- 10.** In the **Launch and Activation Permission** dialog box, select a user.
- 11.** To allow this user to start and activate the unit remotely, select **Allow** for all four permission choices.

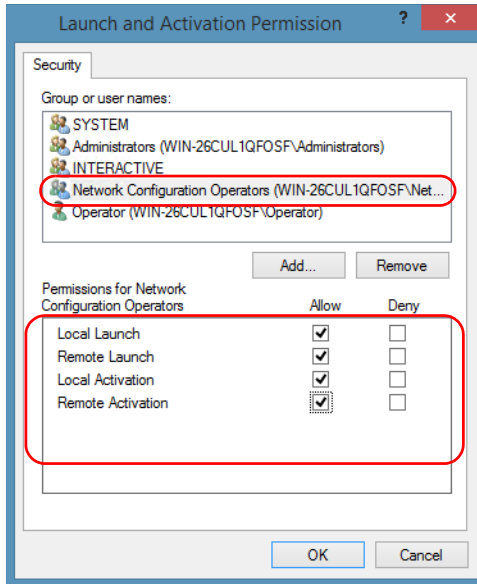

- 12.** Repeat steps 10 and 11 for each newly added user.
- 13.** Tap **OK**.

14. In the **EXFO KernosHost Properties** dialog box, tap the **Security** tab.
15. Under **Access Permissions**, select **Customize**, and tap **Edit** to edit the list of allowed users.

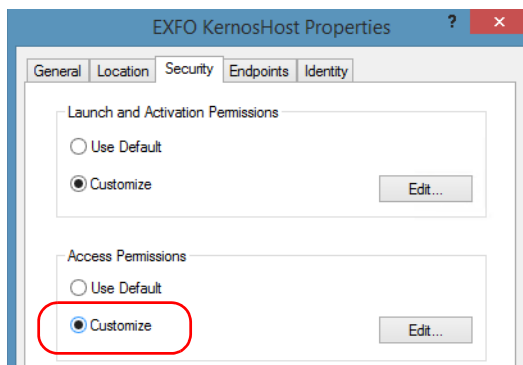

16. In the **Access Permission** dialog box, tap **Add**.
17. In the **Select Users or Groups** dialog box, under **Enter the object names to select**, type the name of the user to whom you want to give access permissions for remote access.

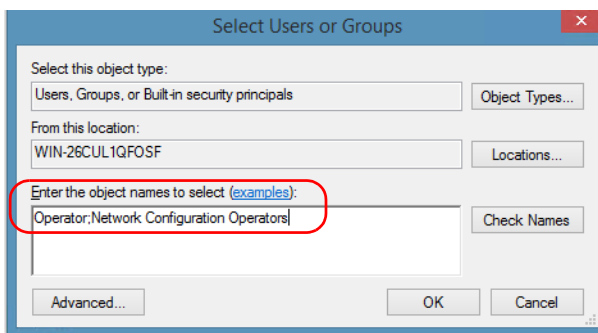

18. Tap **OK**.
19. In the **Access Permission** dialog box, select a user.

Preparing for Automation

Configuring DCOM Access to Your Unit

- 20.** To allow this user to access the unit remotely, select **Allow** for both permission choices.

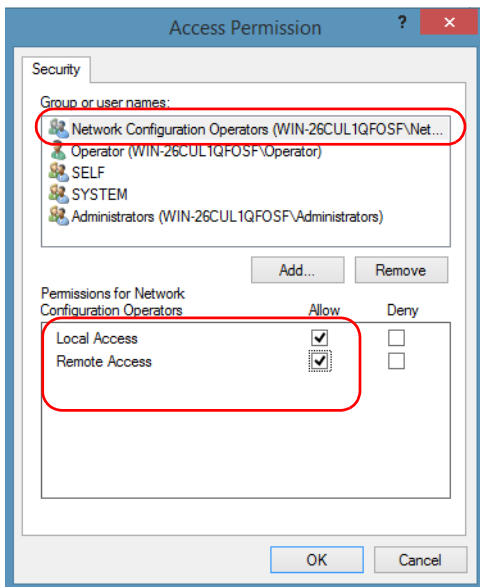

Note: You can also deny connection permission for specific users.

- 21.** Repeat steps 19 and 20 for each newly added user.
- 22.** Tap **OK** to close the **Access Permission** dialog box.
- 23.** Tap **OK** to close the **EXFO KernosHost Properties** dialog box.
- 24.** Restart your unit.

The EXFO ICSPIAccess Class component, located on your unit, can now be accessed with DCOM.

Enabling DCOM on Client Computer

Note: To run *DCOMCNFG.EXE*, you need Administrator access rights.

If you want to subscribe to EXFO IcsCPIAccess Class component events, you need to set security parameters on the client computer.

To enable DCOM on the client computer:

1. Start Windows, on the taskbar, click **Start** (Start button () under Windows 8.1 and Windows 10) and select **Run**.
2. In the **Open** box, type “DCOMCNFG.EXE” and tap **OK**.
3. In the **Component Services** dialog box, select: **Console Root > Component Services > Computers** to show available computers.

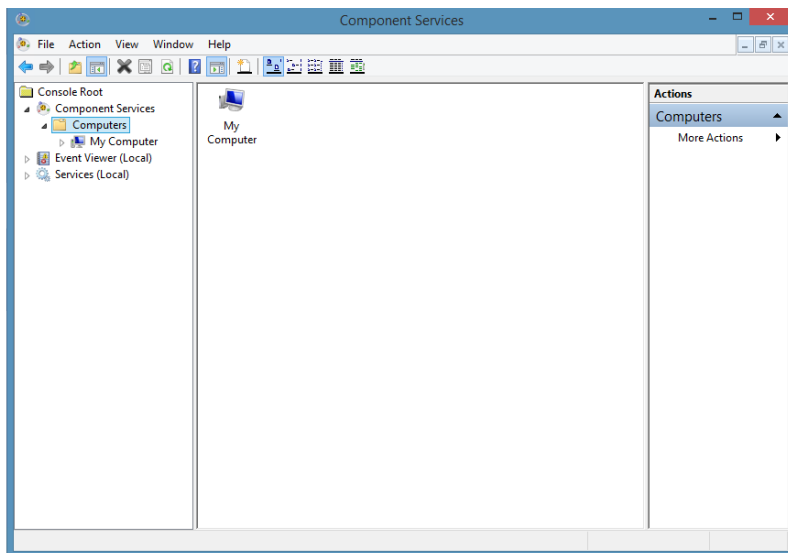

Preparing for Automation

Configuring DCOM Access to Your Unit

4. Right-click **My Computer**, and then select **Properties**.
5. In the **My Computer Properties** dialog box, tap the **Default Properties** tab.
6. Select **Enable Distributed COM on this computer**.

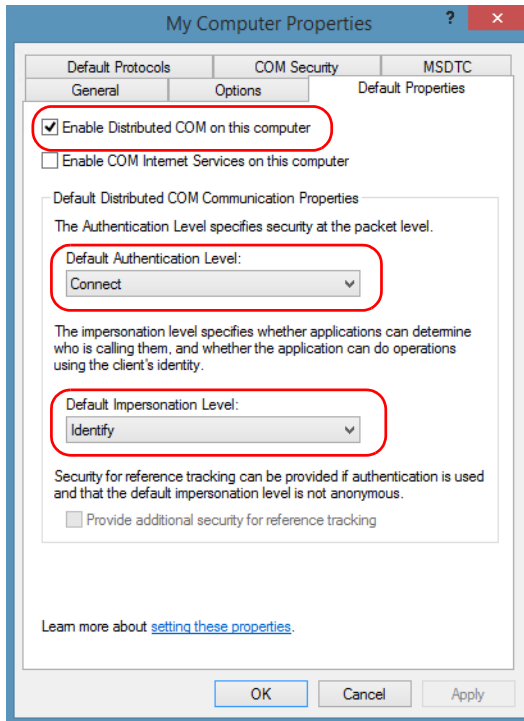

7. Under **Default Distributed COM Communication Properties**, in the **Default Authentication Level** list, select **Connect**.
8. In the **Default Impersonation Level** list, select **Identify**.
9. Tap **Apply**.

10. Tap the **COM Security** tab and, under **Access Permissions**, tap **Edit Limits**.

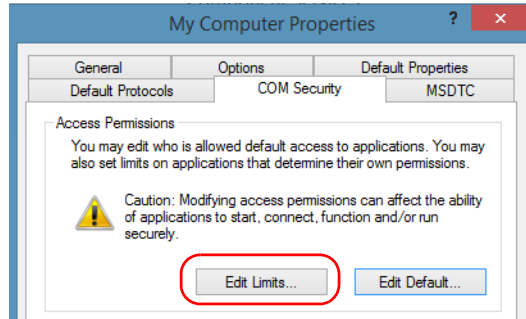

11. In the Access Permission dialog box, ensure that, for **ANONYMOUS LOGON**, local and remote accesses are allowed.
If **ANONYMOUS LOGON** is not listed under Group or user names, tap **Add** to add it.

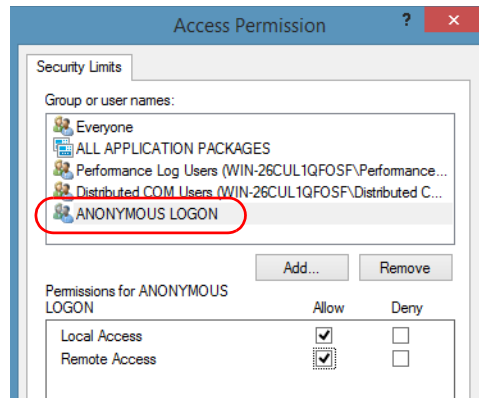

For more information on enabling events with DCOM, refer to *AppId Key* in MSDN Documentation.

Disabling DCOM Access to Your Unit

Note: To change the DCOM access to your unit, you need Administrator access rights.

If you no longer want client computers to access your unit using DCOM, you can disable this access.

To disable DCOM access to your unit:

1. From the main window, tap the **System Settings** button.
2. Tap **Control Panel**.
3. Tap **System and Security > Administrative Tools**.
4. Tap **Component Services**.
5. From the **Component Services** window, select: **Console Root > Component Services > Computers > My Computer > DCOM Config** to show the contents of the **DCOM Config** folder.

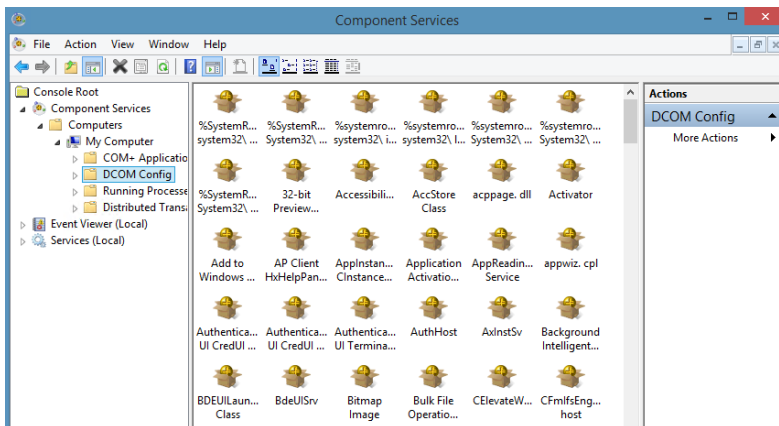

6. From **DCOM Config**, right-click **EXFO KernosHost**, and select **Properties**.

7. In the **EXFO KernosHost Properties** dialog box, tap the **Security** tab.
8. Under **Launch and Activation Permissions** and **Access Permissions**, select **Use Default**.

This ensures the EXFO IcSCPIAccess Class component uses the default lists instead of the customized lists.

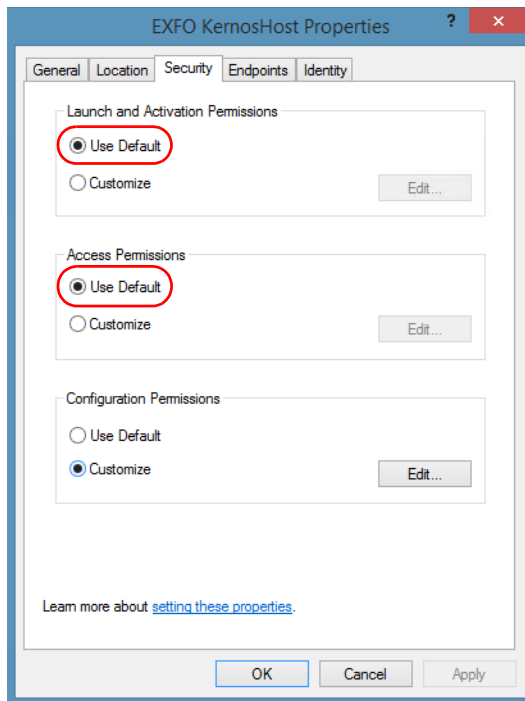

9. Tap **OK**.
10. Restart your unit.

The EXFO IcSCPIAccess Class component, located on your unit, *cannot* be accessed with DCOM.

Preparing to Control Modules with a Dedicated Application

Some modules come with a dedicated application designed to control them remotely from a computer. The main characteristic of this application is that it lets another user control the module as if it was close at hand.

To control the module remotely, you must configure it on the unit containing the module, including a description that can help you identify it. The user controlling the module from a computer must install the dedicated application (for more information on the installation, refer to the application documentation).

- The module can be controlled both remotely and locally at the same time.
- You will have to configure your remote control again in the following cases:
 - you inserted the module in another slot
 - you applied changes on applications while the module is not inserted in its slot.

Note: *Some modules do not support the remote control.*

To activate or deactivate remote control:

1. From the main window, tap the **System Settings** button.
2. Tap **Remote Control Configuration**.

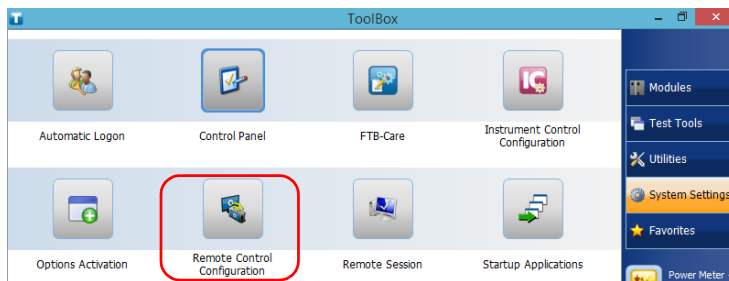

3. If necessary, tap **Change settings**, and then, when the application prompts you to authorize the changes to your unit (identified as “computer”), select **Yes**.

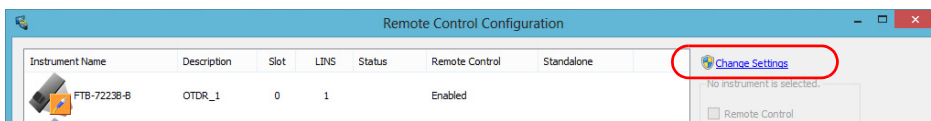

4. From the **Remote Control Configuration** window you will see all the inserted modules. Select the module for which you want to have a remote access.

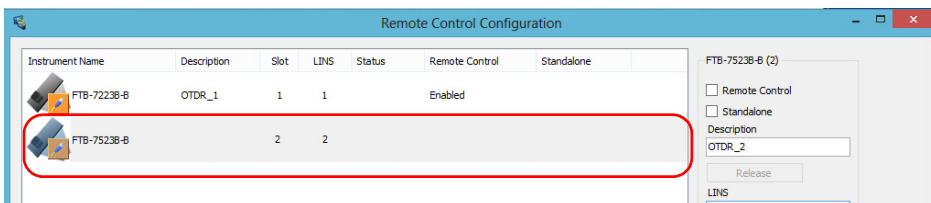

Preparing for Automation

Preparing to Control Modules with a Dedicated Application

5. Set the parameters:

- Select **Remote Control** to be able to access the module remotely (via TCP/IP over Telnet or other).
- Select **Standalone** to leave the module active even if all users close their dedicated applications.

Note: *When a standalone module is no longer used, you can simply release it. See the corresponding procedure below to know how to proceed.*

6. If desired, under **Description**, type a description that will help you identify the instrument.

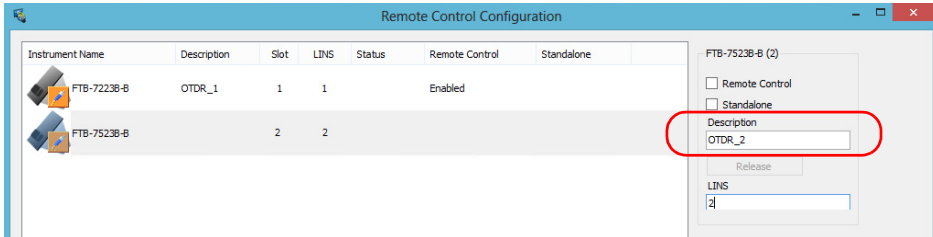

Note: *You can enter up to 10 characters. The description can correspond to the test interface ID or to any other short text of your choice.*

7. If necessary, under **LINS**, modify the logical instrument number that you will use to access the instrument remotely.

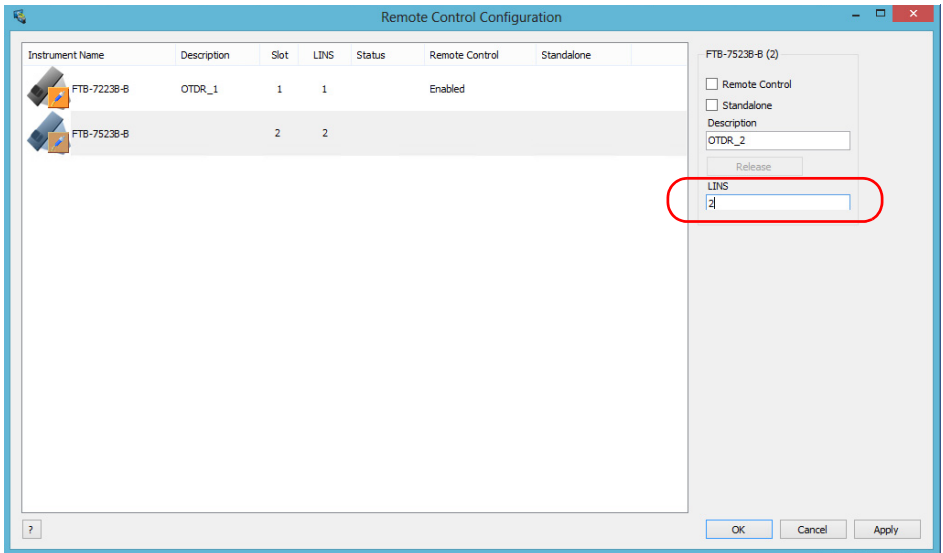

Note: If you do not see the **LINS** column, it means that you cannot modify the **LINS** value on your type of platform. Refer to the user guide of your modules for more information on the **LINS** to use.
If you can see the **LINS** column, but the column is empty, it means that the corresponding module cannot be controlled using **SCPI** commands.

8. Tap **Apply** to confirm your changes or **OK** to apply your changes and close the window.

Note: This information will be updated the next time you start the module application and will appear in the title bar if the module application allows it. Refer to the corresponding module documentation for more details.

Preparing for Automation

Preparing to Control Modules with a Dedicated Application

To release the remotely-controlled module:

Tap Release.

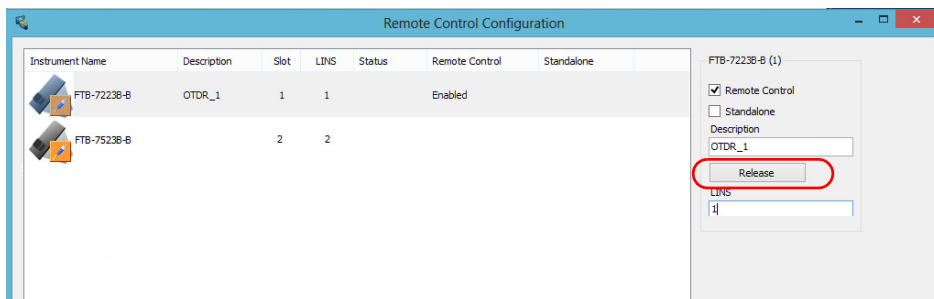

11 *Using FTB Products in an Automated Test Environment*

EXFO supplies commands that follow the guidelines determined by the SCPI consortium and LabVIEW drivers for all available instruments. EXFO also supplies COM properties and events allowing you to build your own application.

Your application can be developed using LabVIEW, Visual C++, Delphi.NET, Visual Basic or any other language that runs under Windows 8.1 Pro.

The present chapter gives you information to help you use the provided commands, drivers, as well as COM properties and events to remotely control your instruments.

If you need information on how to prepare your unit for remote control, see the corresponding section in this documentation.

Standard Status Data Structure

Each device that is physically connected to the remote bus has four status registers with a structure complying with the IEEE 488.2 standard. These registers allow the controller to monitor events and get useful information on the status of the devices it controls.

- Standard Event Status Register (ESR)
- Standard Event Status Enable Register (ESE)
- Status Byte Register (STB)
- Service Request Enable Register (SRE)

ESR and ESE

The standard event status register and status enable register information is presented in the following table.

Bits	Mnemonics	Bit Value
7	Power On (PON)	128
6	User Request (URQ)	64
5	Command Error (CME)	32
4	Execution Error (EXE)	16
3	Device-Dependent Error (DDE)	8
2	Query Error (QYE)	4
1	Not Used (N.U.)	0
0	Operation Complete (OPC)	1

The following table presents a summary of the possible operations on ESR and ESE registers.

Register	Read	Write	Clear
ESR	Use *ESR?.	Impossible to write.	<ul style="list-style-type: none"> ▶ Use *CLS. ▶ Read the register.
ESE	Use *ESE?.	Use *ESE.	Use *ESE with a value equal to 0.

STB and SRE

The status byte register and service request enable register information is presented in the following table.

Bits	Mnemonics	Bit Value
7	Not Used (N.U.)	0
6	Master Summary Status (MSS)/ Service Request (RQS)	64
5	Event Summary Bit (ESB)	32
4	Message Available (MAV)	16
3	Not Used (N.U.)	0
2	Error Available (EAV)	4
1	Not Used (N.U.)	0
0	Not Used (N.U.)	0

Using FTB Products in an Automated Test Environment

Standard Status Data Structure

The following table presents a summary of the possible operations on STB and SRE registers.

Register	Read	Write	Clear
STB	<ul style="list-style-type: none">▶ Use *STB?.▶ Use serial poll (GPIB bus sequence that allows retrieval of the value without interrupting the current process).	Impossible to write; the register content is only modified when the Event registers or Queues are modified.	Use *CLS before sending a query (to clear the Event registers and Queues and by the same token clear the STB register).
SRE	Use *SRE?.	Use *SRE with a value equal to 0 to disable the register or with a value equal to 1 to enable it.	<ul style="list-style-type: none">▶ Use *SRE with a value equal to 0.▶ At startup, the register is set to 0.

The diagram displayed on the next page is a useful aid in understanding the general commands and how a service request (SRQ) is generated.

Using a service request, a device notifies the controller that an event requiring special attention occurred. The controller will then find which device generated a SRQ (its RQS bit is set) and the causes of it.

Using FTB Products in an Automated Test Environment

Standard Status Data Structure

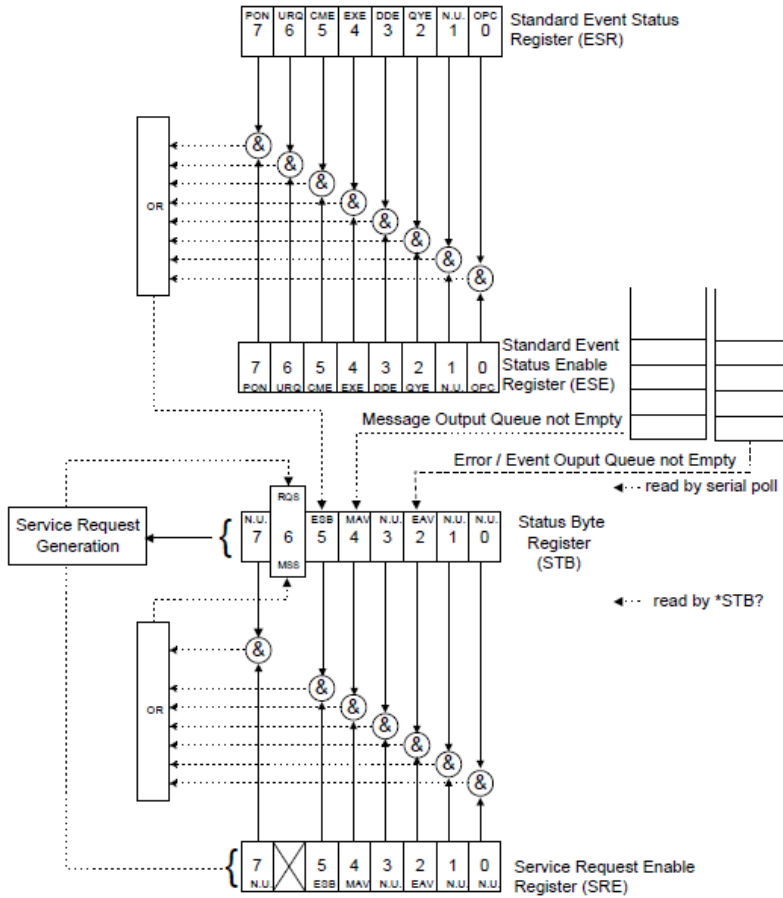

SCPI Command Structure

The information presented in this section provides an overview of SCPI programming. If you need detailed information, refer to:

- The International Institute of Electrical and Electronics Engineers. *IEEE Standard 488.2-1992, IEEE Standard Codes, Formats, Protocols and Common Commands For Use with ANSI/IEEE Std. 488.1-1987*. New York, 1992.
- *Standard Commands for Programmable Instruments (SCPI). Volume 1: Syntax and Style*. Vers. 1999.0 May, U.S.A, 1999.

The provided commands follow the guidelines determined by the Standard Commands for Programmable Instruments (SCPI) consortium. A *program message* consists of one or more commands (and/or queries) with their appropriate parameters.

For example, a program message could contain a command used to activate or deactivate a source. The corresponding command syntax would be:

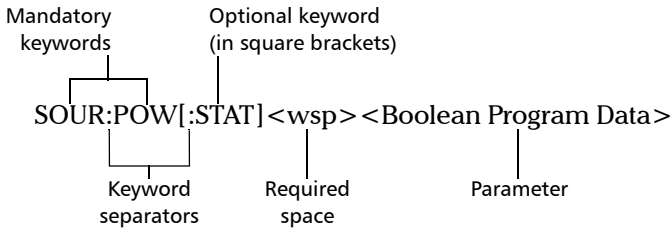

When sending a message containing the previous command, you would actually type: SOUR:POW ON.

The following table shows elements that are commonly used in the commands or queries syntax.

Item	Meaning
[]	Enclose optional keywords or parameters. <i>Do not include square brackets in your program message.</i>
[1..n]	Indicates that the instrument provides multiple capabilities and that you have to specify which one you want to use. If you omit the value, the command will take effect on the first capability. Multiple capabilities can be found at any branch of the command tree (root, intermediate node or terminal node). Example: If the command is :SENSe[1..n]:CORRection:COLLect:ZERO and you want it to take effect on the second SENSE (sensor) capability of the instrument, you may send this: :SENSe2:CORRection:COLLect:ZERO. <i>Do not include square brackets in your program message; simply enter the number.</i>
<wsp>	Indicates that a space is required (“wsp” stands for “white space”). Corresponds to ASCII character codes (0 to 9 and 11 to 32, in decimal). <i>Do not include “<wsp>” in your program message; simply type a space.</i>
<digit>	Element used in the construction of various numeric data types. Can take any value between 0 and 9 inclusively (corresponds to ASCII character codes 48 to 57, in decimal).

Using FTB Products in an Automated Test Environment

SCPI Command Structure

Item	Meaning
<mnemonic>	<p>Element used in the construction of certain data types and program messages.</p> <div data-bbox="444 354 982 574" data-label="Diagram"> </div> <p>In the diagram above,</p> <ul style="list-style-type: none"> ➤ “<Upper/lower case alpha>” corresponds to ASCII character codes (65 to 90 and 97 to 122, in decimal). ➤ “_” corresponds to an underscore character (code 95, in decimal).
< >	<p>Text appearing between angled brackets specifies the command parameter to be sent or the response you will receive from an instrument.</p> <p><i>Do not include angled brackets in your program message.</i></p>
	<p>Indicates that one, and only one, value must be selected from the available choices.</p> <p>Example: If the list is 0 1, you can only select 0 or 1.</p> <p><i>Do not include the pipe character in your program message.</i></p>
{ }	<p>Indicate that the enclosed parameters can appear 0 to n times when the command is used.</p> <p><i>Do not include braces in your program message.</i></p>
:	<p>Mandatory to separate keywords. Can be omitted at the beginning of a program message. For example, you can use either :SYST:ERR or SYST:ERR.</p>

Item	Meaning
;	<ul style="list-style-type: none"> ➤ Mandatory to separate the different commands of a program message when more than one command is sent at a time. In this case, it is called <i><PROGRAM MESSAGE UNIT SEPARATOR></i>. ➤ Also used to separate responses when multiple queries were sent in a single program message. In this case, it is called <i><RESPONSE MESSAGE UNIT SEPARATOR></i>.
,	<ul style="list-style-type: none"> ➤ Mandatory to separate parameters in a command or a query. In this case, it is called <i><PROGRAM DATA SEPARATOR></i>. ➤ Also used to separate the various responses from a query. In this case, it is called <i><RESPONSE DATA SEPARATOR></i>.

There are also several conventions regarding command syntax:

- Spelling errors will cancel the command or query.
- Commands and queries are not case-sensitive. You can type your program messages using either lower-case or upper-case letters.
- The command or query can be written using only the three- or four-letter shortcuts, only full words, or a combination of both.

The example below shows the long and the short forms of a same query.

:SYSTem:ERRor?		Long form
:SYST:ERR?	}	Short form (small words represented by the capital letters of the long form)
:syst:err?		

Consulting Data Types

If you need information about data types used in EXFO's documentation, see the appendix on data types.

Writing Remote Control Code

Your unit offers many commands permitting complete remote control of all the FTB components. These commands adhere to the SCPI standard.

You can find all the commands and queries supported by the FTB-500 unit in the *IEEE 488.2 and Specific Commands* appendix. For information on commands specific to particular instruments, refer to each instrument's user guide.

When you write code, you must follow these rules on message reception and transmission:

- The controller must have sent a complete message to the instrument (including the message terminator) before retrieving a response.
- The controller must retrieve all the responses from previous queries (including the response terminator) before sending a new message to an instrument.
- The controller must not try to retrieve a response from an instrument if the corresponding query has not been previously sent to the instrument.
- You must pay special attention to queries that return an indefinite ASCII response. To avoid any confusion, the IEEE 488.2 standard requires that this data type be immediately followed by a response termination character. For this reason, when working with compound queries, you must ensure that a query sending an indefinite ASCII response is the last query of the series.
- Be careful when sending program messages containing multiple queries that return large amounts of data. Since the controller can only retrieve data when the instrument has finished processing the queries, it could result in problems ranging from a saturation of the output queue to the complete blocking of the whole system.

Error Message Format

System and device-specific errors are managed by your unit. The generic format for error messages is illustrated in the following figure.

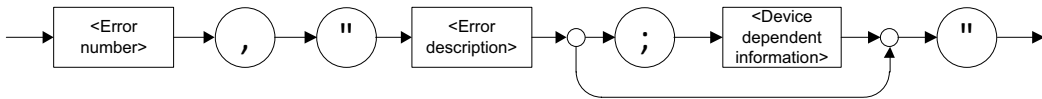

As shown in the above figure, the message contains three parts:

- error number
- error description
- device-dependent information

Error messages ending in a negative number are SCPI-based errors.

For a complete list of possible errors, see the appendix on SCPI-based errors.

If you want to work in remote mode, see the section on configuring DCOM access for your unit in this user guide.

Working with EXFO LabVIEW Drivers

EXFO provides you with custom drivers that you can use to program commands for your inspection instruments.



IMPORTANT

You need to be familiar with the LabVIEW environment and programming methods to work with EXFO drivers.

Regardless of whether you work with the provided Getting Started applications or your own VIs (using EXFO drivers), the steps remain the same.

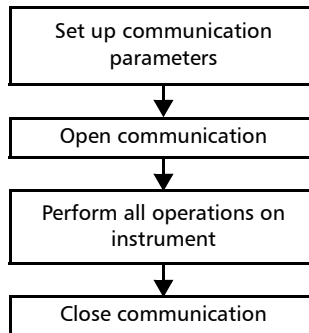

Before configuring the communication parameters via LabVIEW (provided applications or new VI), you must configure your unit for remote control. For more information, see the section on preparing your unit for automation in this user guide.



IMPORTANT

Ensure that the communication type that you will set in LabVIEW matches the one selected for your unit.

Using FTB Products in an Automated Test Environment

Working with EXFO LabVIEW Drivers

The following table presents the possible settings for communication parameters. These parameters must be set from LabVIEW for each instrument.

Parameter	Active X (local)	Active X (remote)	RS-232 (remote)
Communication type	ActiveX	ActiveX	RS232
VISA resource name	N/A	N/A	Select the serial port from the list
FTB slot number	Concatenation of the FTB-500 unit number (0) and the instrument's slot number	Concatenation of the FTB-500 unit number (0) and the instrument's slot number.	Concatenation of the FTB-500 unit number (0) and the instrument's slot number.
Machine name	localhost	Ethernet address, that is IP address or machine name of your FTB-500 unit	N/A

Note: *When you are working with platform or IEEE 488.2 commands, you can leave the slot number at its current value.*

Using the EXFO Getting Started Applications

Once the LabVIEW drivers are installed, the Getting Started demo applications are available to demonstrate the following:

- How to open and close the communication link between the remote computer and the device.
- Some of the available functions (by loading the necessary *.vi* files).

All the *.vi* files related to an instrument are presented in the same folder. By default, they are found under the location where your LabVIEW files were installed.

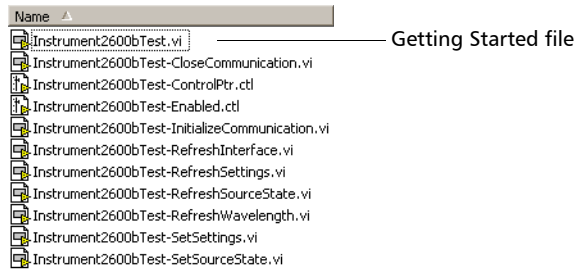

All Getting Started filenames follow this pattern: *InstrumentxxxxTest.vi* (where *xxxx* corresponds to the product code).

Each Getting Started application offers a user interface (called Front Panel) and a design view (called Block Diagram).

Note: *The look of the interface may change slightly depending on the operating system you are using.*

Using FTB Products in an Automated Test Environment

Using the EXFO Getting Started Applications

On the Front Panel, you can set communication parameters between the FTB-500 unit and the current instrument. It also offers various controls and buttons to use the instrument easily. In fact, the application performs the necessary calls to the instrument's drivers so it is transparent to the user.

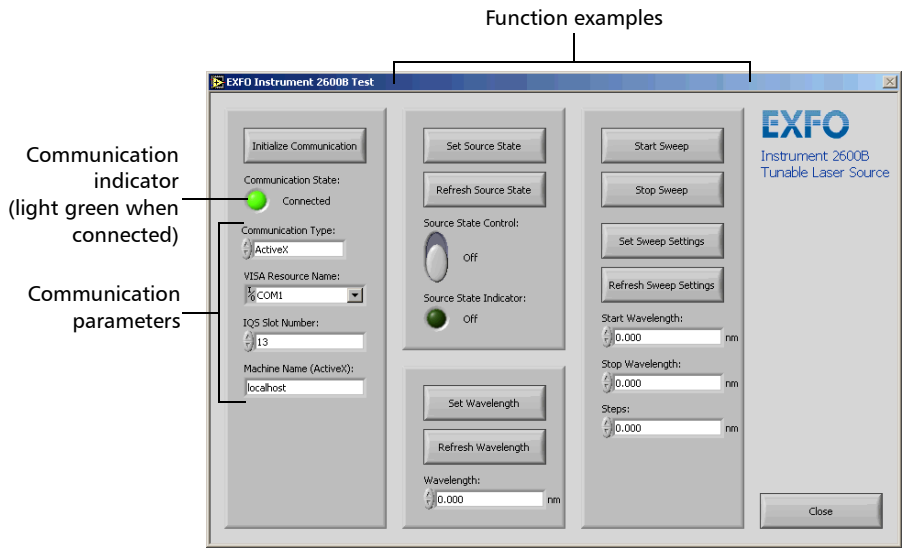

The application state (called State Machine) changes whenever an action is performed on the instrument. If you toggle to Block Diagram view, you can see the list of possible states. The application is always in one of the predefined states.

Using FTB Products in an Automated Test Environment

Using the EXFO Getting Started Applications

The following figure illustrates the State Machine after the user has clicked on the button allowing you to set the source state (from the Front Panel). When the State Machine changes to “SetSourceState”, the application calls “Instrument2600bTest_SetSourceState.vi”, which, in turn, calls the “SourcePowerState_GSet.vi” sub VI that will perform the appropriate action on the instrument.

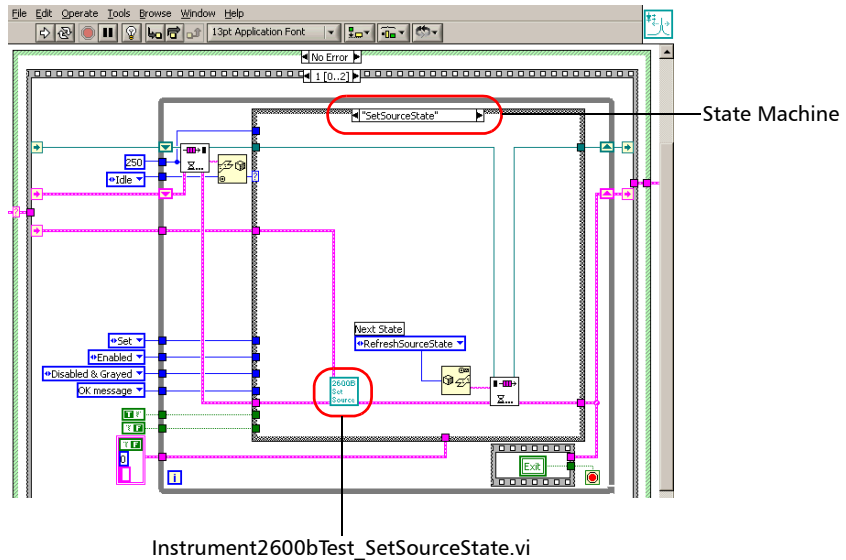

Using FTB Products in an Automated Test Environment

Using the EXFO Getting Started Applications

The detail of this sub VI gives precious information on how to call an instrument driver VI.

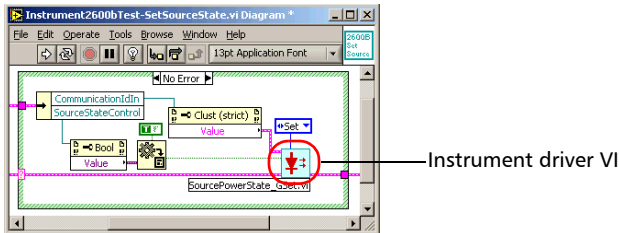

To use a Getting Started application:

1. Turn on the FTB-500 unit, start ToolBox, and ensure that all the remote-control parameters are set correctly.
2. Open the desired Getting Started application and run it from LabVIEW.
3. From the application's Front Panel, set the communication parameters.
For information on communication parameters, see *Working with EXFO LabVIEW Drivers* on page 239.
4. Once the parameters are configured, click **Initialize Communication**.

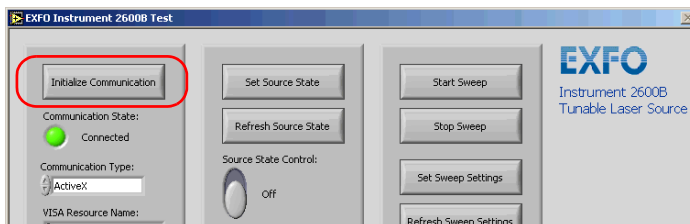

5. Using the provided buttons and controls, perform the desired actions.

6. When you are finished, select **Close** to end the communication.

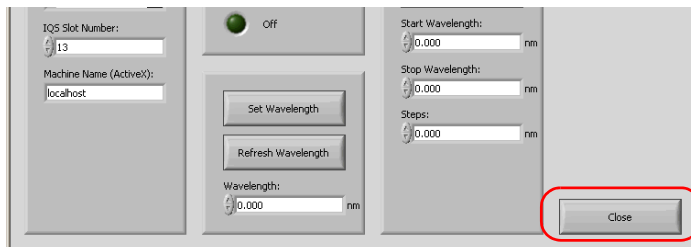

7. Close LabVIEW.



IMPORTANT

To avoid losing the original version of the Getting Started applications, do not save changes when prompted by LabVIEW.

Building and Using Custom VIs

EXFO LabVIEW drivers have been designed to let you control the various instruments according to your needs, by building your own VIs in LabVIEW.

You can access EXFO drivers

- directly from
C:\Program Files\National Instruments\LabVIEW 6\instr.lib\EXFO
- from the LabVIEW function palettes

Each icon of the EXFO palette corresponds to a set of drivers that allow you to either

- communicate with EXFO instruments that support remote control
- open and close communication links with instruments
- send IEEE 488.2 (common) commands
- send platform commands (specific to FTB-500 unit)

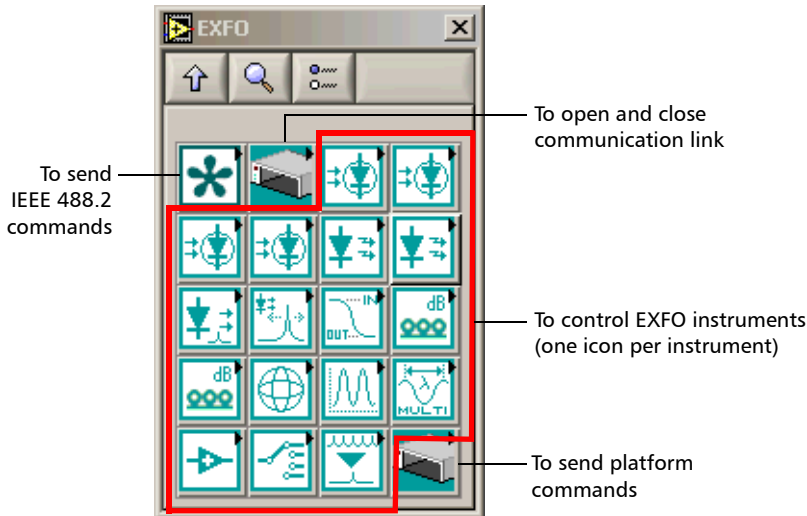

Using FTB Products in an Automated Test Environment

Building and Using Custom VIs

When you click an icon in the EXFO palette, the corresponding sub-palette opens, giving you access to the different functions.

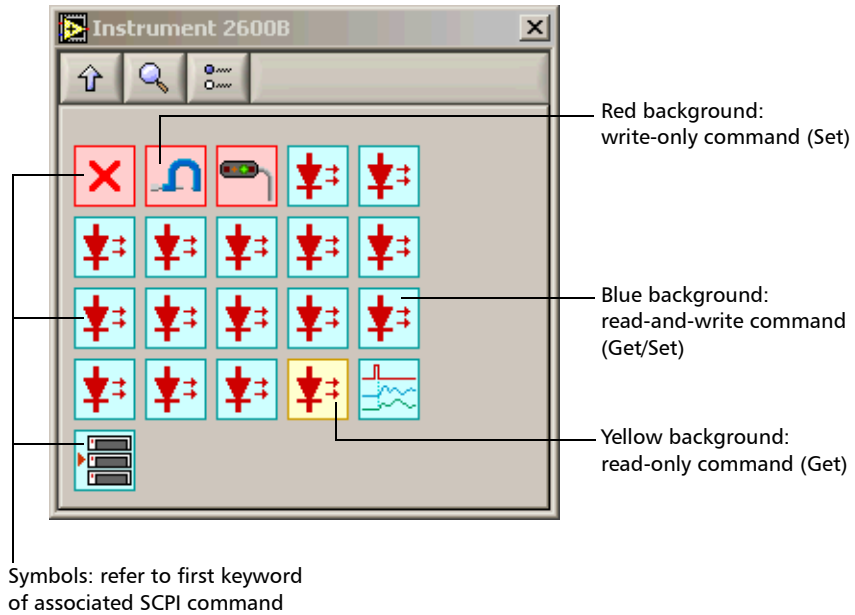

Using FTB Products in an Automated Test Environment

Building and Using Custom VIs

Note: *The procedure provided hereafter is for guidance only. The actual procedure may vary depending on the type of product you are using.*

To build a custom VI:

1. Start LabVIEW and create a new VI.
2. Open the **EXFO** palette.
 - 2a. From LabVIEW, open the Diagram Block view.
 - 2b. Display the **Functions** palette and select **Instrument I/O**.

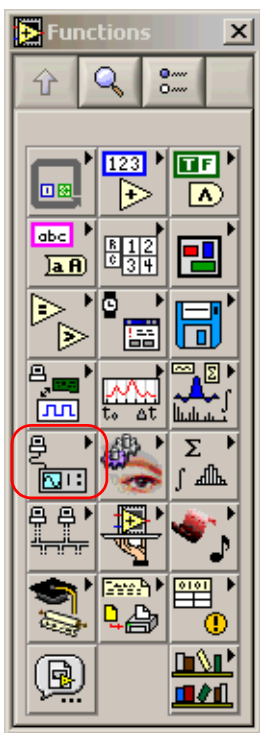

- 2c.** From the **Instrument I/O** palette, select **Instrument Drivers**.

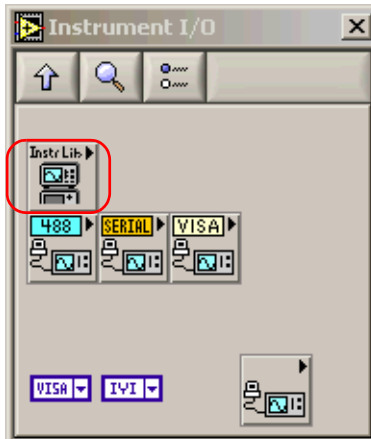

- 2d.** From the **Instrument Drivers** palette, select **EXFO**.



- 3.** Select **EXFO IQS Base**.

Using FTB Products in an Automated Test Environment

Building and Using Custom VIs

4. From the **EXFO IQS Base** palette, select *EXIQSBASE_OpenComm.vi* and add it to your new VI.

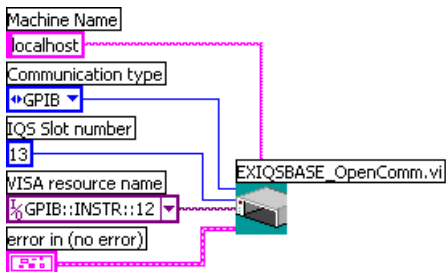

5. Set the communication parameters. For information on communication parameters, see *Working with EXFO LabVIEW Drivers* on page 239.
6. From the EXFO palette, select the desired instrument.
7. From the instrument's palette, select the function you need and add the corresponding driver to your VI.

8. Set the required parameters and connect the instrument *Communication ID in* parameter to the *Communication ID out* parameter from EXIQSBASE_OpenComm.vi.

The example below shows how to configure the SourcePowerState_GSet.vi to turn on the tunable laser source. In this example, *Set* was chosen and the *PowerState* parameter was set to *True*.

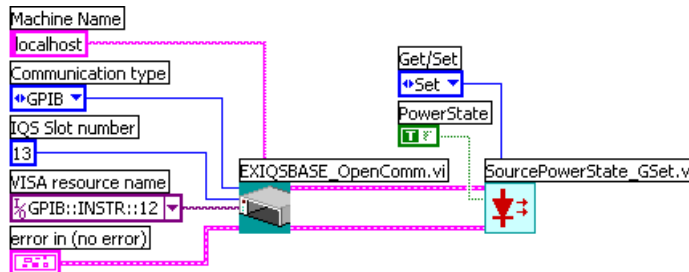

9. Repeat steps 7 and 8 for each of the functions you want to use.

However, you have to link *Communication ID in* of the new driver to *Communication ID out* of the preceding driver.

Note: *If you want to use platform or IEEE 488.2 commands, add the desired driver to your VI and configure its parameters exactly as you would do with any instrument function.*

Using FTB Products in an Automated Test Environment

Building and Using Custom VIs

10. When you are finished, add *EXIQSBASE_CloseComm.vi* to your VI.

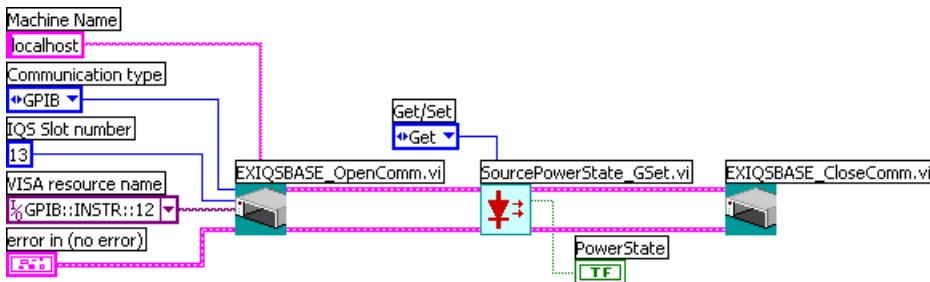

Connect the *Communication ID out* parameter of the last function to the *Communication ID in* parameter of *EXIQSBASE_CloseComm.vi*.

Note: You only have to open communication once at the beginning, and close it when all of the desired functions will have been added.

11. Save your work.

To use your new VI:

1. Turn on the FTB-500 unit, start ToolBox, and ensure that all the remote-control parameters are set correctly.
2. From LabVIEW, run the VI.

Monitoring Remote Commands

ToolBox allows you to monitor remote commands sent to your units, if desired.

To monitor remote commands:

1. From the main window, tap the **Test Tools** button.
2. Depending on which type of communication protocol you are using, select **IC Monitor** or **SCPI Telnet Monitor**.

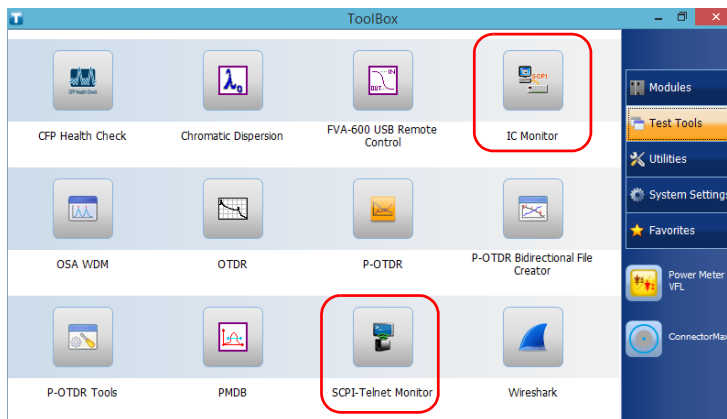

Using FTB Products in an Automated Test Environment

Monitoring Remote Commands

3. Do one of the following:

- ▶ If monitoring using ActiveX or RS-232, tap **Connect**.

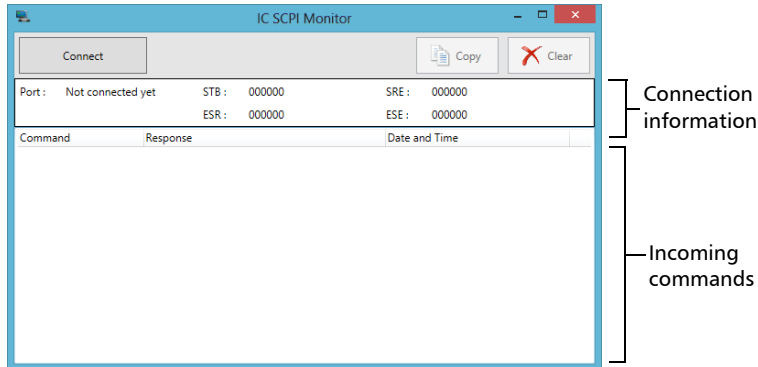

You are automatically connected to the monitoring system, and the **Connect** button changes to a **Disconnect** button, enabling you to disconnect from IC when you have finished your work.

Once connected, your current connection information will appear in the upper part of the window, and the commands will appear as a list in the lower part of the window.

To clear the history, tap **Clear**.

To view the list in any word processor, tap **Copy** to send it to the clipboard, and then paste it in your document. You can use any program, as the list is copied in text format.

To exit the monitoring utility, tap .

For more information, see the section on using your unit in an automated test environment.

Using FTB Products in an Automated Test Environment

Monitoring Remote Commands

- If monitoring using TCP/IP, which provides sending SCPI commands over TCP/IP through Telnet from the EXFO Instrument Control, you are automatically connected to the monitoring system.

Note: Port 5024 is designated for sending SCPI commands in the Telnet protocol.

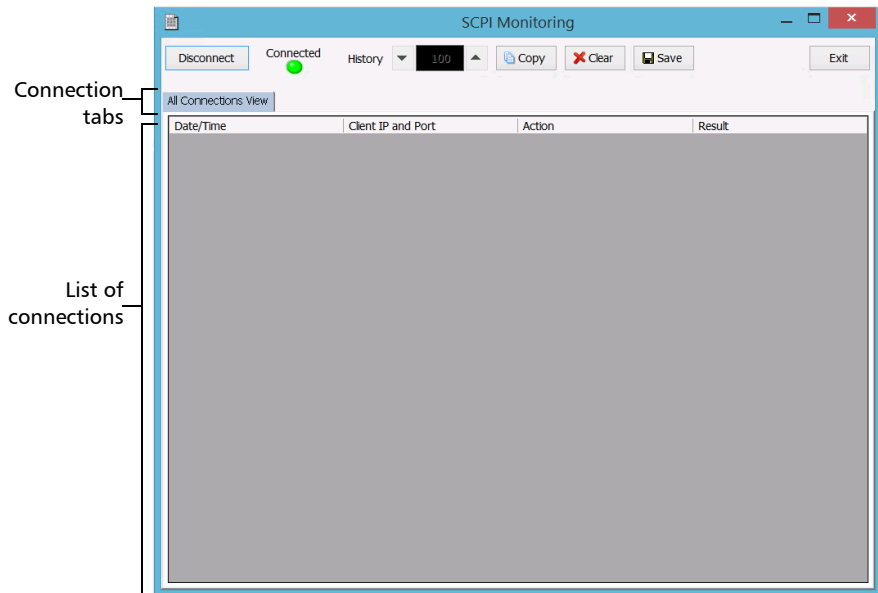

Once connected, your current connection information will appear in the **All Connections View** tab, and the commands will appear as a list in the lower part of the window.

The **Disconnect** button becomes available for you to tap when you are ready to disconnect.

Using FTB Products in an Automated Test Environment

Monitoring Remote Commands

Connection information is also displayed in a separate tab, identified by its IP address, from where you can monitor the commands and other actions sent through TCP/IP over Telnet, as well as the results.

With the **History** parameter, you determine how many commands you want to keep in the list. You can increase or decrease the number by using the arrow buttons on each side of the list.

To clear the history, tap **Clear**.

To view the list in any word processor, tap **Copy** to copy it to the clipboard, and then paste it in your document. You can use any program, as the list is copied in text format.

To save the list as a file, tap **Save**.

To exit the monitoring utility, tap **Exit**.

For more information, refer to the user documentation about communication through TCP/IP over Telnet.

12 *Maintenance*

To help ensure long, trouble-free operation:

- Always inspect fiber-optic connectors before using them and clean them if necessary.
- Keep the unit free of dust.
- Clean the unit casing and front panel with a cloth slightly dampened with water.
- Store unit at room temperature in a clean and dry area. Keep the unit out of direct sunlight.
- Avoid high humidity or significant temperature fluctuations.
- Avoid unnecessary shocks and vibrations.
- If any liquids are spilled on or into the unit, turn off the power immediately, disconnect from any external power source, remove the batteries and let the unit dry completely.



WARNING

The use of controls, adjustments and procedures, namely for operation and maintenance, other than those specified herein may result in hazardous radiation exposure or impair the protection provided by this unit.

Cleaning Detector Ports

Regular cleaning of detectors will help maintain measurement accuracy.



IMPORTANT

Always cover detectors with protective caps when unit is not in use.

To clean detector ports:

- 1.** Remove the protective cap and adapter (FOA) from the detector.
- 2.** If the detector is dusty, blow dry with compressed air.
- 3.** Being careful not to touch the soft end of the swab, moisten a cleaning tip with *only one drop* of optical-grade liquid cleaner.



IMPORTANT

Some cleaners may leave traces if used abundantly. Do not use bottles that distribute too much liquid at a time.

- 4.** While applying light pressure (to avoid breaking the detector window), gently rotate the cleaning tip on the detector window.
- 5.** Repeat step 4 with a dry cleaning tip or blow dry with compressed air.
- 6.** Discard the cleaning tips after one use.

Cleaning VFL-Type Connectors

VFL-type connectors are fixed on your unit and can be cleaned using a mechanical cleaner.



WARNING

Verifying the surface of the connector with a fiber-optic microscope WHILE THE UNIT IS ACTIVE WILL result in permanent eye damage.

To clean a connector using a mechanical cleaner:

1. Insert the cleaning tip into the optical adapter, and push the outer shell into the cleaner.

Note: *The cleaner makes a clicking sound to indicate that the cleaning is done.*

2. Verify connector surface with a fiber inspection probe (for example, EXFO's FIP).

Maintenance

Cleaning the Touchscreen

Cleaning the Touchscreen

Clean the touchscreen with a soft, non-abrasive cloth, such as one used for cleaning reading glasses, dampened with water.



CAUTION

Using anything else than water can damage the special coating used for units equipped with an outdoor-enhanced screen (S2 option).

When not using your unit, EXFO recommends using the screen protector that came with it.

Recharging the Batteries

Your unit uses smart lithium-ion (Li-Ion) batteries. The number of batteries that power your unit and that come with it depends on the model that you have purchased. There are two batteries for the four-slot model, and three batteries for the eight-slot model.

- The charge status is shown in the taskbar (at the left of the clock). Simply tap the battery icon for more information.
- The unit also indicates the charge status with the LED on its front panel (see *LED Indicators Description* on page 8).



CAUTION

- **For the four-slot units:** Only charge the batteries with the AC adapter/charger provided by EXFO with your unit.
- **For the eight-slot units:** These units can be connected to the AC power using a standard three-wire power cord.



IMPORTANT

- ▶ Batteries are not charged at the factory. You must fully charge them before using the unit for the first time. The batteries are fully charged after a few hours or when the battery LED indicator stops flashing.
- ▶ The time required to charge batteries depends on various factors such as the type of modules currently in use and the ambient temperature.
- ▶ To ensure that batteries function or charge properly, keep them in temperatures between 10 °C and 40 °C (50 °F and 104 °F). Store them below 50 °C (122 °F).
- ▶ Do not leave a battery discharged for several days.
- ▶ Depending on the way the unit is used, after a while, the charge status icon may no longer correspond to the actual power level of the battery (for example, the icon indicates that the power level is sufficient, but the unit turns off because the battery is too weak). A complete calibration cycle will be necessary (see *Recalibrating the Batteries* on page 272).
- ▶ After 300 cycles (approximately 18 months of use), you may want to replace the batteries with new ones to maintain optimal operation conditions. Otherwise, the operating time might be reduced.



IMPORTANT

- Remove the batteries if the unit will not be used for more than two weeks.
- If you need to store the batteries for an extended period of time, place them in a cool dry place, and ensure that they are charged at around 50 % of their capacity. Every three months during the storage period, verify the battery level. Recharge the batteries when necessary, so that their charge level remains around 50 % of the total capacity. This will ensure that you get the optimum performance out of the batteries.
- Li-Ion batteries that are not used for a long period of time (over three months) will not be damaged, but might need to be recalibrated.

To recharge the batteries:

Connect the unit to a power outlet using the AC adapter/charger (four-slot units) or a standard power cord (eight-slot units). The charge cycle will start and end automatically.

Maintenance

Replacing Batteries

Replacing Batteries

Your unit can be powered either by batteries or from an appropriate power outlet when used with the provided AC adapter/charger (four-slot units) or standard power cord (eight-slot units).



WARNING

Do not throw batteries into fire or water and do not short-circuit the battery electrical contacts. Do not disassemble.



CAUTION

Your unit uses smart lithium-ion (Li-Ion) batteries with built-in protection that have been especially designed for EXFO. For this reason, you can only replace them with batteries of the same type and model.

The use of other batteries may damage your unit and compromise your safety.

For more information on the available power sources for your unit, as well as their characteristics, see *Technical Specifications* on page 327.

Note: *Whenever batteries are inserted or removed, the unit will beep.*

Before you go out in the field, make sure you install batteries in the unit unless you have an adequate and reliable power source.



IMPORTANT

To avoid losing test data that you have not saved, make sure at least one battery is always present in the unit if it is not under alternating current (AC).



IMPORTANT

When changing batteries, make sure that the unit is off or that the AC power is connected.

Maintenance

Replacing Batteries

To replace the batteries in the unit:

- 1.** Open the battery compartment as follows:
 - 1a.** Position the unit so that its front panel rests on a flat surface such as a table.
 - 1b.** Lift the mobile part of the battery compartment screws and turn the screws counterclockwise until the compartment door is loose. Since they are captive screws, you cannot remove them completely.

Four-slot model

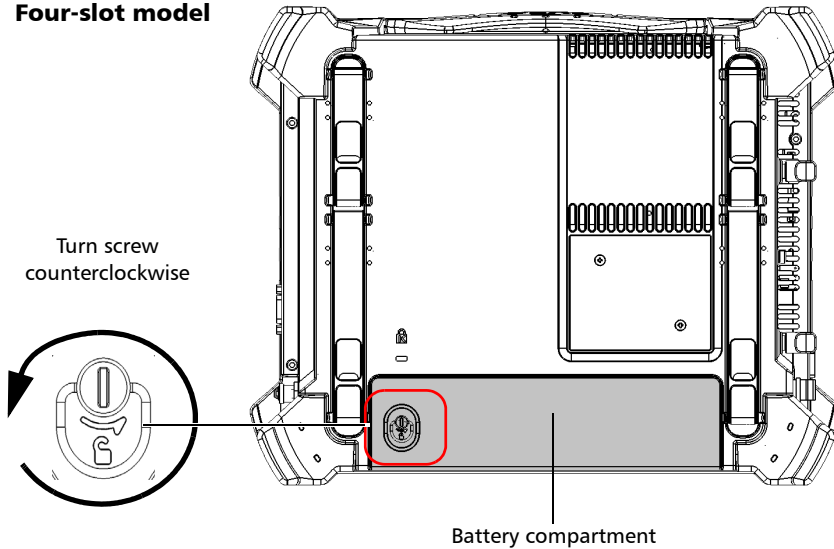

Eight-slot model

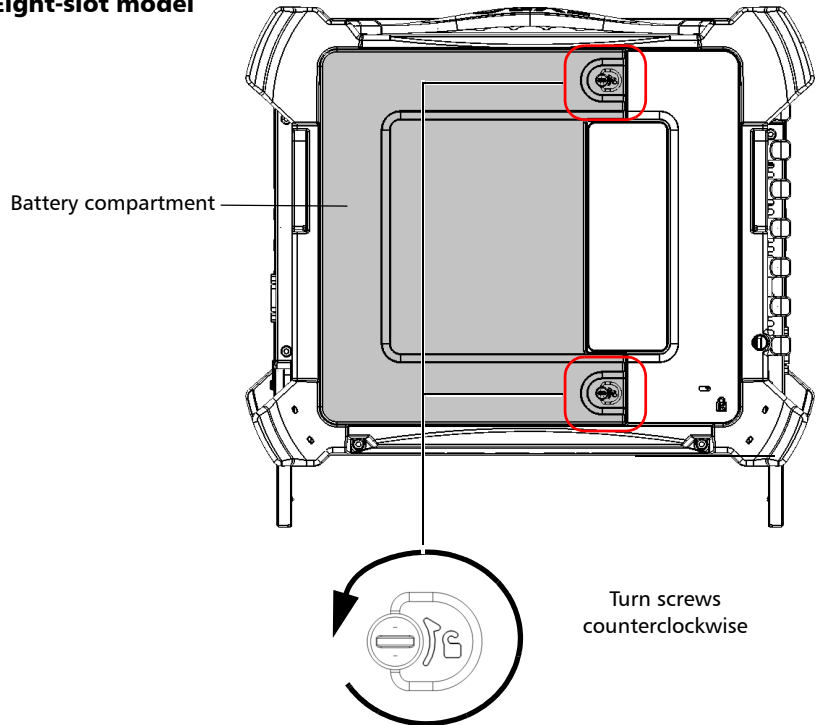

- 1c.** Remove the battery compartment door.
- 2.** Pull out one of the batteries using the tab.

Maintenance

Replacing Batteries

3. Slide the new battery in, using the images below as a guide. The battery will not go in completely if it is inserted incorrectly.

Four-slot model

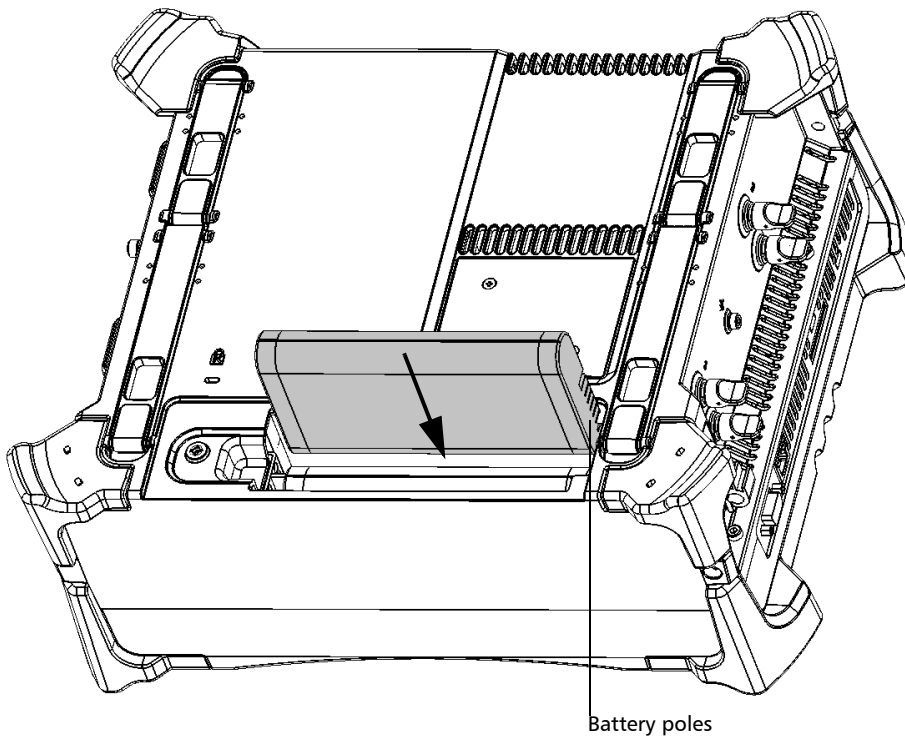

Eight-slot model

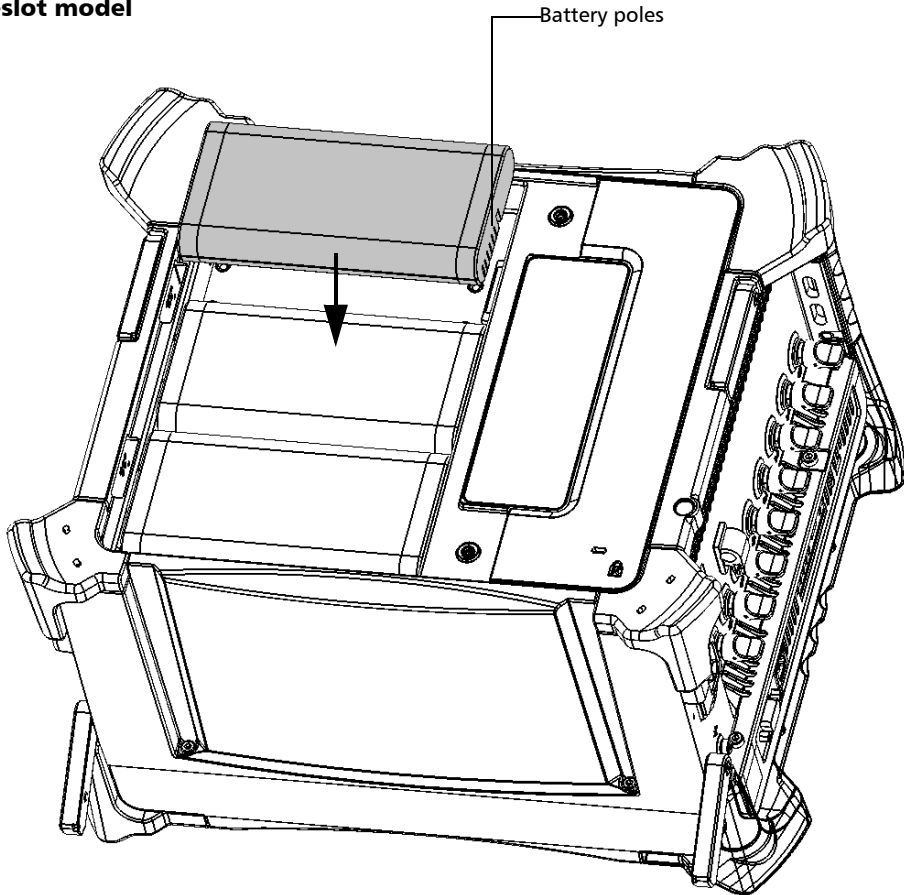

4. Repeat steps 2 and 3 with the other battery (two remaining batteries for the eight-slot model).
5. Close the battery compartment and tighten the retaining screw back into position (two retaining screws on the eight-slot model).

Maintenance

Viewing Battery Status

Viewing Battery Status

The battery icon displayed in the taskbar gives you an overview of the power source currently in use (batteries or AC power) and of how much battery power you have left. The battery level that you see on the icon corresponds to the global charge level, that is, the total power available from all the batteries present in the unit.



Unit powered by batteries; level of the batteries is shown



Unit powered by AC power; batteries are charging



Unit powered by AC power; no batteries in the unit



You can also access the global remaining time and percentage of charge, as well as the information for each battery if you wish.

To view the battery status:

1. If necessary, from the front panel of the unit, press the  button to show the taskbar.
2. If you want to view detailed information, tap the battery icon.

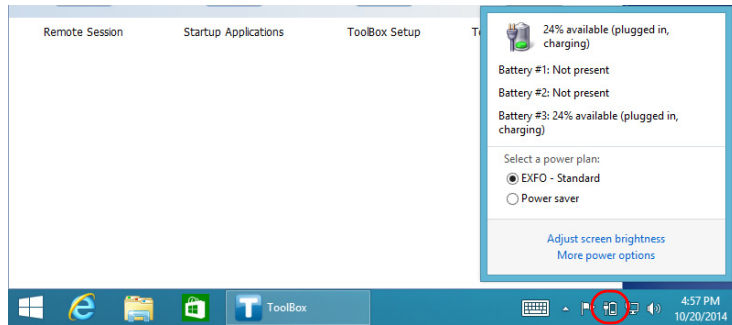

The detailed information is displayed.



IMPORTANT

Your FTB-500 was set at the factory to warn you about low battery charge level (when it reaches about 10 %), and to shut down automatically when the batteries are at a very low charge level (less than 5 %).

However, if you are using modules that are more demanding energy-wise, your unit will shut down automatically before it reaches 5 %. The charge level that triggers the automatic shutdown depends on the power required by the modules.

If you are using such modules often, you can set your unit through the Windows Control Panel to increase the value at which you will be warned of the low battery level and when the unit will shut down automatically. For more information about power management in Windows, refer to the corresponding online documentation.

Recalibrating the Batteries

Depending on the way the unit is used, after a while, the charge status icon may no longer correspond to the actual power level of the batteries (for example, the battery LED is green and not blinking, which normally indicates that the batteries are fully charged, yet the battery gauge indicates that they are only charged at 85 % of their capacity). A complete calibration cycle will be necessary.

You can perform a recalibration with the battery calibration utility:

- The utility will charge the battery until it is full.
- It will then discharge the battery completely.
- You will have to let the battery recharge completely.

The whole calibration process can take several hours. You can stop the process at any time, but the battery will still need calibration and could be empty.

If the batteries still do not have the expected autonomy after a complete calibration cycle, it probably means that they are worn out and they need to be replaced by new ones. New batteries can be purchased from EXFO.

To recalibrate the batteries:

1. From the main window, tap the **Utilities** button.
2. Tap **Battery Calibration**.

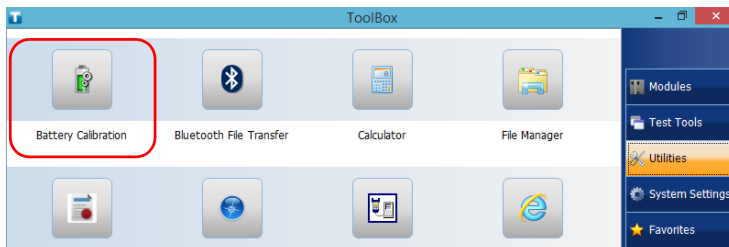



IMPORTANT

During the calibration process, the unit will turn off. Do not restart the unit while the battery LED indicator is cycling through its green-red-yellow sequence. This will cancel the calibration process.

3. Connect your unit to a power outlet using the provided AC adapter/charger or power supply.
4. Tap the **Start Calibration** button (the **Stop Calibration** button will become available).

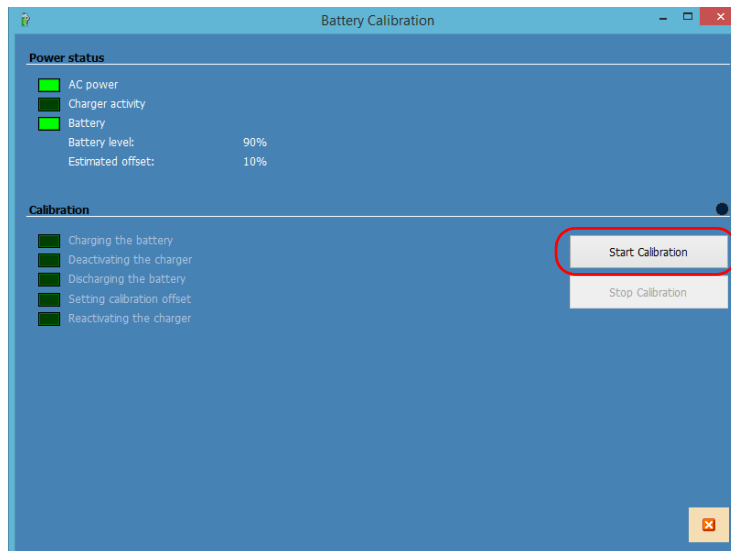

When a calibration step is underway, the on-screen LED preceding the step name appears in yellow. When a step is complete, the LED turns to green.

Once calibration is complete, the **Start Calibration** button becomes available again.

Maintenance

Installing or Removing the Power Meter and VFL

Installing or Removing the Power Meter and VFL

If your unit was not equipped with a power meter and a VFL at time of your initial purchase, you can purchase one afterwards and install it yourself.

You may also need to remove the power meter to send it to an authorized service center for recalibration.

Note: *If you prefer not to remove the power meter from your unit when a calibration is needed, you can also send the complete unit to the service center.*



WARNING

- To avoid serious injuries as well as irreparable damages both to your unit and your power meter, **ALWAYS TURN OFF YOUR UNIT** (shutdown mode, not sleep), **DISCONNECT IT FROM THE EXTERNAL POWER SOURCE**, and **REMOVE ALL BATTERIES**. For more information on the ways to turn off your unit, see *Turning Off Your Unit* on page 32.
- Be careful not to drop metal objects such as screws inside the unit. These could cause a short-circuit leading to a fire or an explosion.



CAUTION

Electrostatic discharge (ESD) damage can cause complete or intermittent equipment failures.

- Always use an ESD-preventive wrist or ankle strap when handling the power meter. Ensure that the antistatic strap makes good skin contact and that the end of its wire is grounded properly.
- Always handle the power meter by the edges of its metal faceplate (where the detector port is located).
- Never touch the circuit board.
- Keep any piece of clothing away from the power meter during the handling.
- Never touch any component inside the unit either with tools or your fingers.
- Only place the power meter on antistatic surfaces such as an antistatic mat, and quickly put power meters that need recalibration into antistatic bags.



CAUTION

Use only power meters and VFL designed for your unit and approved by EXFO.

Maintenance

Installing or Removing the Power Meter and VFL

To install a power meter:

1. Turn off your unit.
2. Disconnect the unit from its external power source and remove the batteries.
3. Put on a wrist (or an ankle) antistatic strap and ensure that the end of its wire is grounded properly.
4. Place the unit vertically so that its right panel is facing you, and then locate the protective cover that hides the power meter bay.

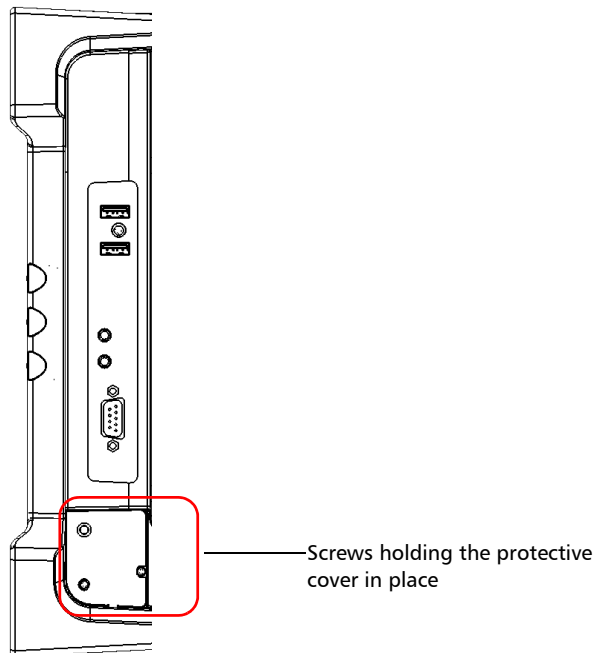

5. Using a screwdriver, remove the three screws of the protective cover.

Note: *Keep the screws close at hand because you will need them to secure the power meter in place later.*

6. Remove the protective cover.



IMPORTANT

Do not discard the protective cover. You will need it to protect the power meter bay if you ever send the power meter for recalibration.

7. By holding the power meter by its faceplate, position it so that the rounded corner is on the left.

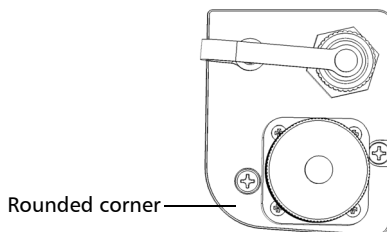

8. Carefully align the power meter with the corresponding bay.

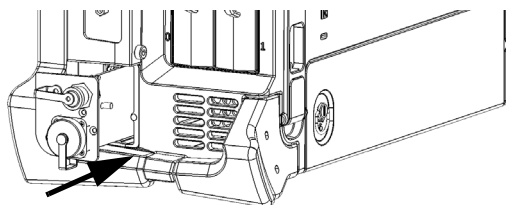

9. Gently slide the power meter into the bay until its faceplate is flush with the edge of the bay. As the power meter reaches the back of the bay, you should feel a slight resistance, indicating that it is properly connected inside the unit.

Note: *If the power meter slides all the way into the bay without any resistance, it probably means that it is not properly inserted.*

Maintenance

Installing or Removing the Power Meter and VFL

- 10.** Using a screwdriver, secure the power meter in place with the screws that you have removed at step 5, ensuring that one of the screws passes through the loop of the VFL cap to secure it in place.

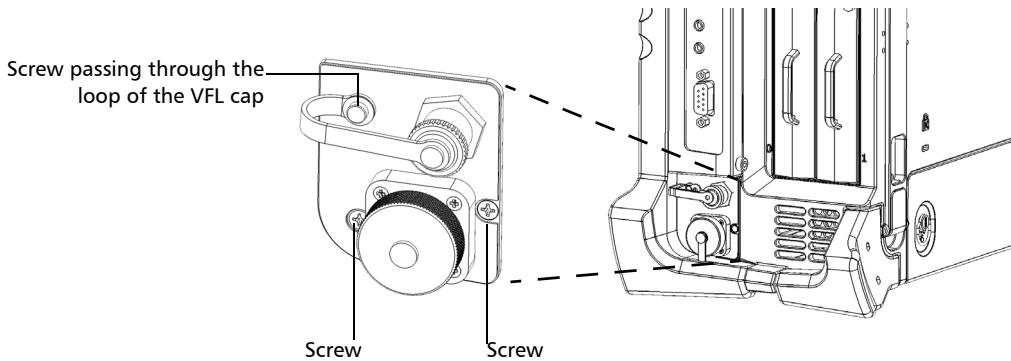

- 11.** Remove your antistatic strap.
- 12.** Connect your unit to an external power source if desired.
- 13.** If necessary, turn on your unit.
- 14.** Start the power meter application to ensure that the instrument is working properly.

Note: *If the power meter is not detected, this could mean that it is not inserted properly in the unit. In this case, repeat the installation procedure. If the problem persists, contact EXFO.*

To remove the power meter for recalibration:

1. Turn off your unit.
2. Disconnect the unit from its external power source and remove the batteries.
3. Put on a wrist (or an ankle) antistatic strap and ensure that the end of its wire is grounded properly.
4. Place the unit vertically so that its right panel is facing you, and then locate the power meter.
5. Using a screwdriver, remove the three screws of the power meter (one of the screws passes through the loop of the VFL cap).

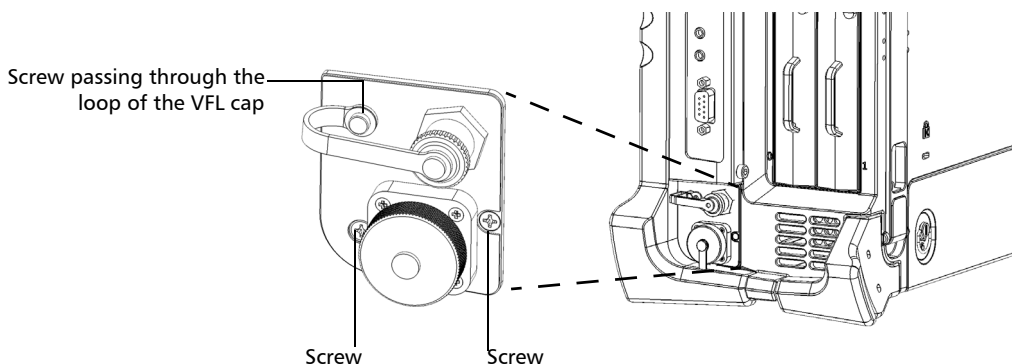

Note: *If you have a protective cover for the power meter bay, keep the screws close at hand. You will need them to secure the protective cover in place later.*



IMPORTANT

Do not discard the screws. You will need them to secure the protective cover, and the power meter in its bay when it is back from calibration.

Maintenance

Installing or Removing the Power Meter and VFL

6. By holding the power meter by its faceplate, gently pull it out of the bay completely.

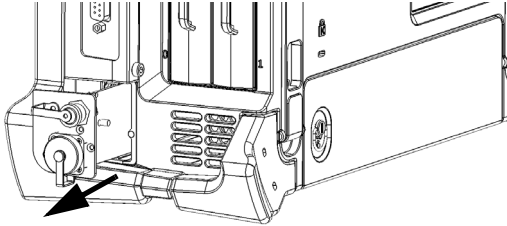

7. Place the power meter in an antistatic bag.
8. If you have a protective cover, proceed as follows:
 - 8a. Carefully place the cover over the power meter bay.
 - 8b. Using a screwdriver, secure the protective cover in place with the screws that you have removed at step 5.
9. Remove your antistatic strap.
10. Connect your unit to an external power source if desired.

Managing Windows Updates

By default, your unit is configured to check for updates, but to let you choose whether you want to download and install them or not.

However, if you prefer, you can configure your unit to automatically search and install Windows updates to ensure that you benefit from the latest versions of the Windows applications. Your unit will need an Internet access for the updates.

Only the applications from Microsoft will be updated with the automatic Windows update feature. If you want to update EXFO applications, see *Installing or Upgrading the Applications* on page 45. The third-party applications will need to be updated manually.

To manage the updates for Windows applications:

1. From the main window, tap the **System Settings** button.
2. Tap **Control Panel**.

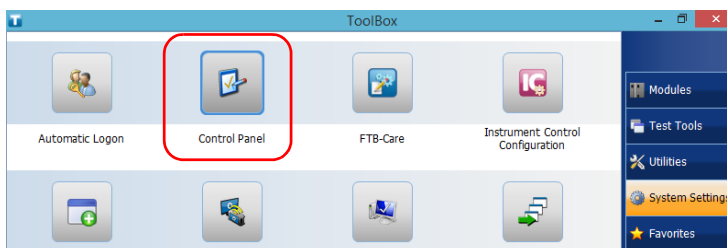

3. Tap **System and Security**.

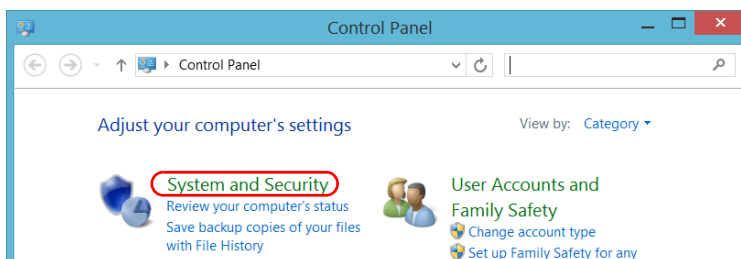

Maintenance

Managing Windows Updates

4. Under **Windows Update**, tap **Turn automatic updating on or off**.

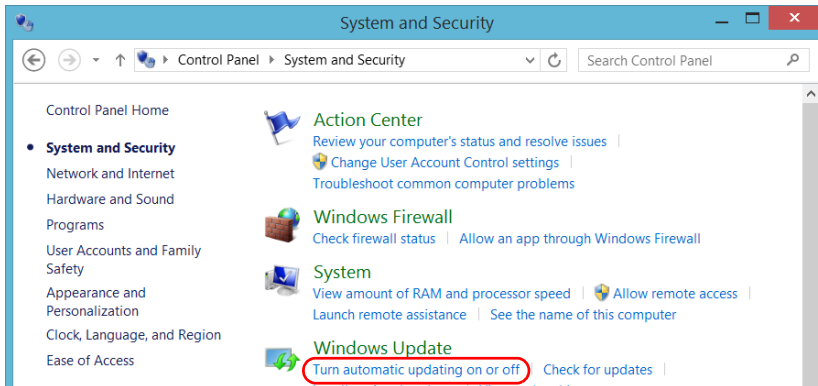

5. Select the update options that best suit your needs.

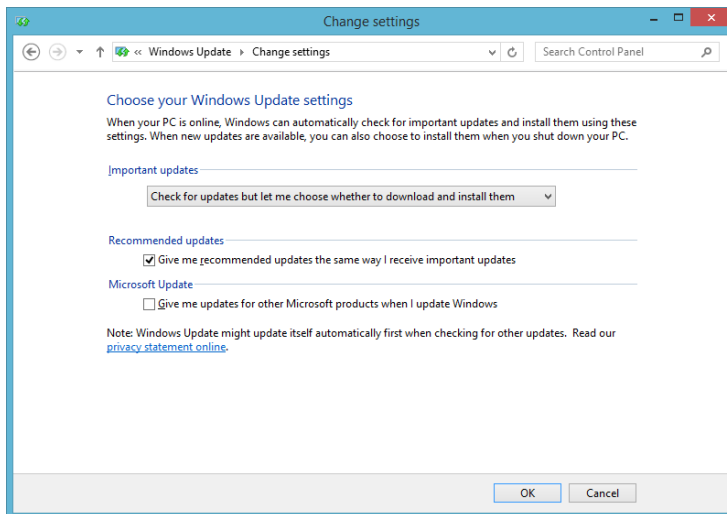

6. Tap **OK** to confirm your changes and return to Control Panel.

Replacing Fuses (Eight-Slot Model Only)

The unit contains two F6.3A L type fuses (5 mm x 20 mm (0.197 in x 0.787 in), fast-acting, low-breaking capacity, 250 V). The fuse holder is located on the left panel of the unit, just below the power inlet.



WARNING

Both neutral and live wires are energized. If a fuse is blown, make sure that no part of the unit remain energized when changing it.

To replace a fuse:

1. Turn off the unit and unplug the power cord.
2. Using a flat-head screwdriver as a lever, pull the fuse holder out of the unit.

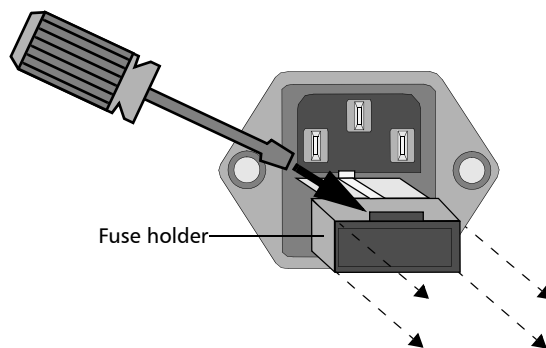

3. Check and replace the fuses, if necessary.
4. Insert the new fuse into the fuse holder.

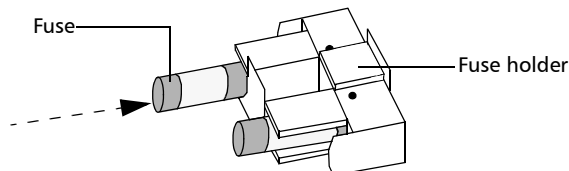

Maintenance

Recycling and Disposal (Applies to European Union Only)

5. Make sure the fuses are placed firmly in the holder prior to reinsertion.
6. Firmly push the fuse holder into place.

Recycling and Disposal (Applies to European Union Only)

For complete recycling/disposal information as per European Directive WEEE 2012/19/UE, visit the EXFO Web site at www.exfo.com/recycle.

13 *Troubleshooting*

Solving Common Problems

Before calling EXFO's technical support, you may want to consider the following solutions to problems that could occur.

Problem	Possible Cause	Solution
My unit does not start.	It is not connected to a power source.	Ensure that the power cord or the AC adapter/charger is connected to both the unit and the power outlet.
	Batteries are completely discharged.	Change or recharge the batteries.
	The system has encountered a problem.	Press the On/Off button for ten seconds to force a hardware reset on the unit.
	Windows startup files have been corrupted.	Contact EXFO.
My unit is running slower than expected.	The configuration of some of the Windows components is underway in the background.	The first few times that you start your unit, after a reset operation, or after certain updates, you may notice that the performance of your unit is not optimum. If this is the case, you may want to leave your unit idle for about an hour to give Windows the time to complete its configuration tasks.

Troubleshooting

Solving Common Problems

Problem	Possible Cause	Solution
When I try to activate Windows on my unit for the first time, a message is displayed, indicating that the product key cannot be used or is not working.	The activation of Windows was skipped during the migration process from Windows XP to Windows Pro 8.1, and the unit has kept a default product key.	<ul style="list-style-type: none">➤ From the Charm bar, select Settings > Change PC settings > Activate Windows.➤ Tap Enter key and enter the Windows product key that you received with your migration package.➤ Follow the on-screen instructions. If the problem persists, contact EXFO.
My unit is not responding.	The system has encountered a problem.	Press the On/Off button for ten seconds to force a hardware reset on the unit.
The PDF reader does not switch to the language that I have selected in Windows.	The language codes of the PDF reader may differ from those used in Windows.	Open the PDF reader and select the desired language directly.
The screen remains black even if the unit is turned on.	The display parameters are not correctly set.	<ul style="list-style-type: none">➤ If no external monitor is connected, press the backlight level button.➤ If an external monitor is connected, verify the brightness settings in Windows.

Problem	Possible Cause	Solution
<p>The screen does not keep its calibration.</p> <p>OR</p> <p>The screen is hard to calibrate properly.</p>	<p>The screen was calibrated using the tool provided with Windows instead of the tool provided with ToolBox.</p>	<ul style="list-style-type: none"> ➤ From the Control Panel, go to Hardware and Sound > Tablet PC Settings. ➤ Tap Reset. ➤ If you need to perform further adjustments to the calibration, from ToolBox, tap System Settings > Touch Screen Calibration.
<p>The USB device I have just connected is not working.</p>	<p>The device has not been detected.</p>	<p>Disconnect, then reconnect the device.</p> <p>Turn off the unit, then turn it on again.</p>
	<p>You do not have the proper driver for this device.</p>	<p>Ensure that you have the right driver (can be provided with the device itself).</p>
<p>The unit does not recognize a test module.</p>	<p>Module application is not installed.</p>	<p>Install the corresponding application using the Update Manager application.</p>
	<p>Defective module.</p>	<p>If the unit recognizes other modules, the faulty module could be defective. Return it to EXFO for repairs.</p>
	<p>Module is not supported on your unit.</p>	<p>Refer to the unit's technical specifications for the complete list of supported modules.</p>
<p>ExpressCards are not recognized at insertion.</p>	<p>You might not have the latest ExpressCard driver.</p>	<p>Install the most recent ExpressCard driver available for your card.</p>

Troubleshooting

Solving Common Problems

Problem	Possible Cause	Solution
The 3G USB modem key is connected, but I am not able to access the Internet.	There is no SIM card in the USB modem key.	Insert the SIM card into the USB modem key. For complete instructions, refer to the documentation that came with your modem key.
	The USB modem key is not detected properly.	Disconnect the modem key from your unit, and try connecting it again. If the modem key is still not detected, try connecting it to another USB port.
	The SIM card has not been activated or there is a problem with service package that you purchased.	Contact your provider of mobile services.
	There is a problem with the mobile network.	Contact your provider of mobile services.

Problem	Possible Cause	Solution
<p>(...continued) The 3G USB modem key is connected, but you are not able to access the Internet.</p>	<p>A problem occurred during the installation of the AirCard Watcher application.</p>	<ul style="list-style-type: none"> ➤ From ToolBox, select the System Settings tab, then tap Control Panel. ➤ Tap Hardware and Sound > Device Manager. ➤ If the 3G USB modem key appears as an “Unknown Device”, remove the Sierra AirCard Watcher application (Control Panel > Programs > Uninstall a program), and then restart your unit. ➤ Return to the Device Manager. ➤ Select the USB modem key form the list of devices. ➤ From the Action menu, select Update Driver Software and let Windows search for the driver. <p>Once the installation is complete, the USB modem key should be working properly.</p>

Troubleshooting

Solving Common Problems

Problem	Possible Cause	Solution
Even though my 3G USB modem key is connected and working properly, I cannot send SMS (text messages) with the Sierra AirCard Watcher application.	SMS is not supported on the FTB-500 unit.	Use another device such as a smartphone or a cell phone to send text messages.
The GPS USB key is not detected.	---	Disconnect the GPS key from your unit, and try connecting it again. If the GPS key is still not detected, try connecting it to another USB port.
Batteries are not recharging.	Ambient temperature is too high or too low.	Make sure that the temperature in the location where you recharge the batteries is within the specifications
	The AC adapter or the power cord is not connected properly.	Make sure that the AC adapter or the power cord is connected to the unit and the AC outlet.
Battery indicator shows only a fraction of the power is left, but the batteries are fully charged. (You are able to operate your unit, but the software automatically blocks when it reaches its set power threshold).	Battery needs to be recalibrated or changed.	<ul style="list-style-type: none">➤ Use the battery calibration process explained in <i>Recalibrating the Batteries</i> on page 272.➤ Batteries may be worn out. In this case, change the batteries (see <i>Replacing Batteries</i> on page 264).

Problem	Possible Cause	Solution
My module does not seem to fit all the way inside the unit and I cannot lock it in place using the retaining screw.	You are using an older module with a rubber O ring directly behind the faceplate.	Remove the O ring simply by pulling it away from the module. The O ring will be permanently removed, but this does not affect the way your module will perform. Your module also remains fully functional on the other EXFO platforms

Restoring Your Unit to Normal Operation

If you ever encounter major problems with your unit (for example, the unit does not behave the way it used to), you can revert it to a previous state. You can revert your unit either to its initial state (as it was at time of purchase), or to a specific state with a backup image (WIM file) created previously.

Note: *For current updates, use Update Manager.*

You can create your own WIM files directly from your unit and store them on a USB key for future use.



IMPORTANT

The WIM files that you create are based on the serial number of your unit. This means that the WIM files created on one unit are only valid to restore this particular unit.

Troubleshooting

Restoring Your Unit to Normal Operation

When you want to restore your unit, there are several options. The table below gives an overview of the possibilities.

Method	Description
Refresh	<ul style="list-style-type: none">➤ The unit will be reverted to its initial state.➤ All data files that were saved to the default personal folders (Documents, Pictures, etc.) will still be available once the operation is complete.➤ If you have installed products and updates since you purchased your unit, you will have to reinstall them.➤ Refer to Microsoft documentation for more information.
Reset	<ul style="list-style-type: none">➤ The unit will be reverted to its initial state.➤ All data files will be lost once the operation is complete.➤ If you have installed products and updates since you purchased your unit, you will have to reinstall them.➤ Refer to Microsoft documentation for more information.
Restore	<ul style="list-style-type: none">➤ The unit will be reverted to the state in which it was when the WIM file was created.➤ All data files will be lost once the operation is complete.➤ If you have installed products and updates since the WIM file was created, you will have to reinstall them.



CAUTION

- Before starting one of the recovery operations, connect your unit to a power outlet using the provided AC adapter/charger.
- **DO NOT TURN OFF** your unit while the recovery operation is underway. Doing so may severely damage your unit. Damaged units will need to be sent back to EXFO for repair.



IMPORTANT

- **Refresh operation:** All the data that is stored in the default personal folders will still be available once the operation is complete. However, any data stored in other folders will be lost. You may want to back up this data before refreshing your unit.
- **Reset and restore operations:** To avoid losing the data that is stored on your unit, you may want to back it up before resetting or restoring your unit. Otherwise, all your files will be lost.

To revert your unit to a previous state:

1. Ensure that your unit will remain powered on during the operation by connecting it to a power outlet using the provided AC adapter/charger.
2. If desired, back up your data.

Note: *If you want to have a look at the content of the Windows.old folder containing files of the previous installation, go to the root of the C drive (Windows (C:)). If you do not see the Windows.old folder, it means no refresh operation has ever been performed on your unit.*

3. On your unit, from the right side of the screen, swipe left to display the Charm bar.

Troubleshooting

Restoring Your Unit to Normal Operation

4. Tap **Settings > Change PC settings**.

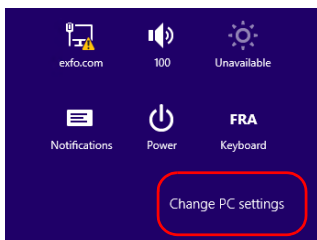

5. Scroll down the list, and then tap **Update and recovery**.

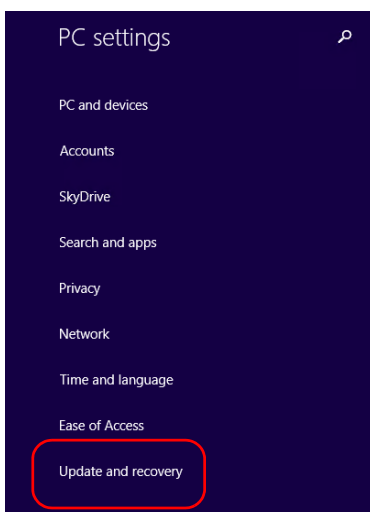

6. Tap **Recovery**.

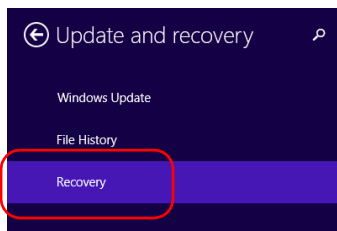

7. If you want to refresh or reset your unit, proceed as follows:

7a. Tap the **Get started** button corresponding to your choice.

To refresh your unit —

To reset your unit —

Refresh your PC without affecting your files

If your PC isn't running well, you can refresh it without losing your photos, music, videos, and other personal files.

Get started

Remove everything and reinstall Windows

If you want to recycle your PC or start over completely, you can reset it to its factory settings.

Get started

Advanced startup

Start up from a device or disc (such as a USB drive or DVD), change your PC's firmware settings, change Windows startup settings, or restore Windows from a system image. This will restart your PC.

Restart now

7b. Follow the on-screen instructions.

Troubleshooting

Restoring Your Unit to Normal Operation

8. If you want to restore your unit (with a WIM file), proceed as follows:

8a. Under **Advanced Startup**, tap **Restart now**.

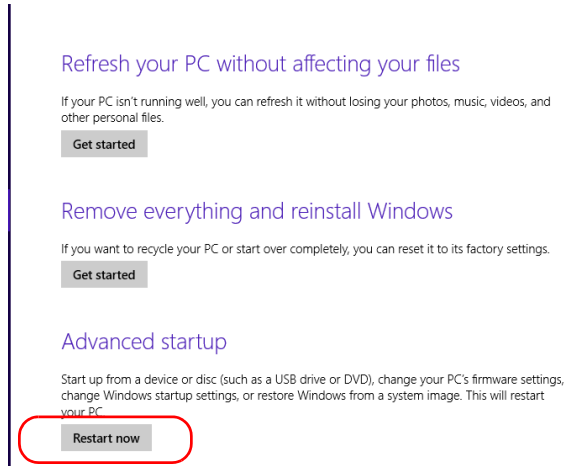

8b. Under **Choose an option**, tap **Troubleshoot**.

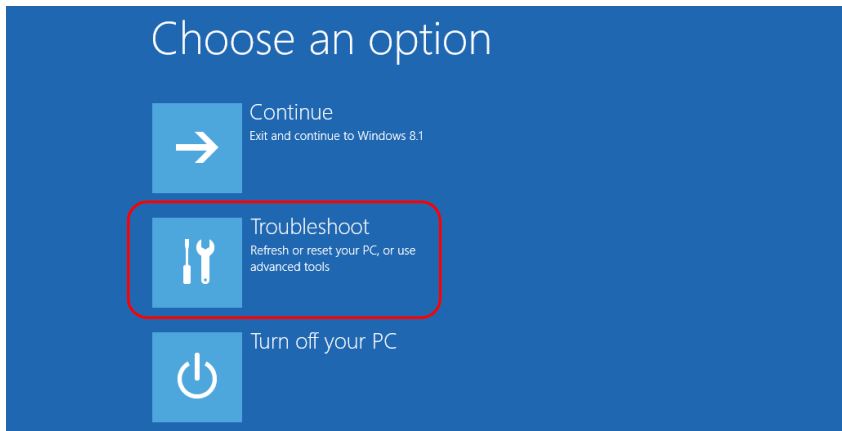

9. Tap **Platform Imaging Utility** to display the corresponding application.

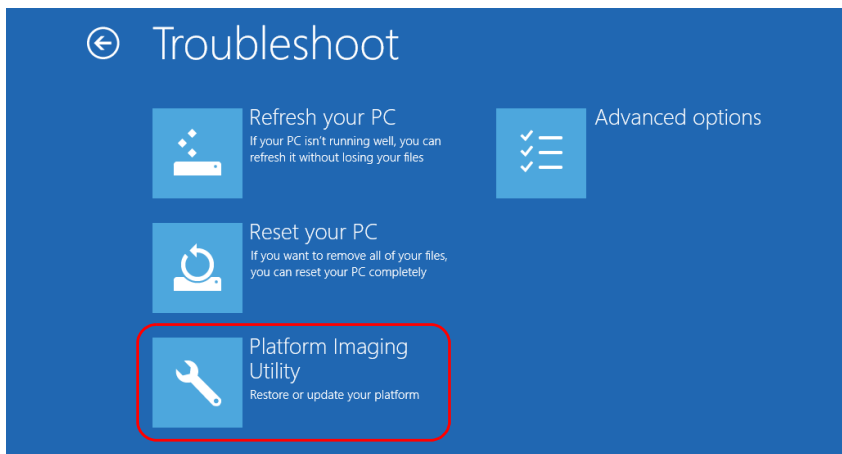

- 9a. Connect the USB key with the desired WIM file to your unit.
- 9b. From the Platform Servicing and Imaging Utility wizard, select **Restore unit from a WIM file**, and then tap **Next**.

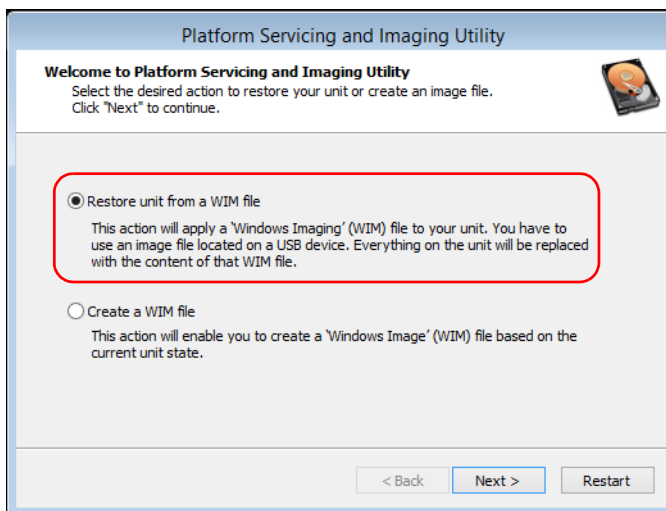

Troubleshooting

Restoring Your Unit to Normal Operation

9c. Tap **Browse**.

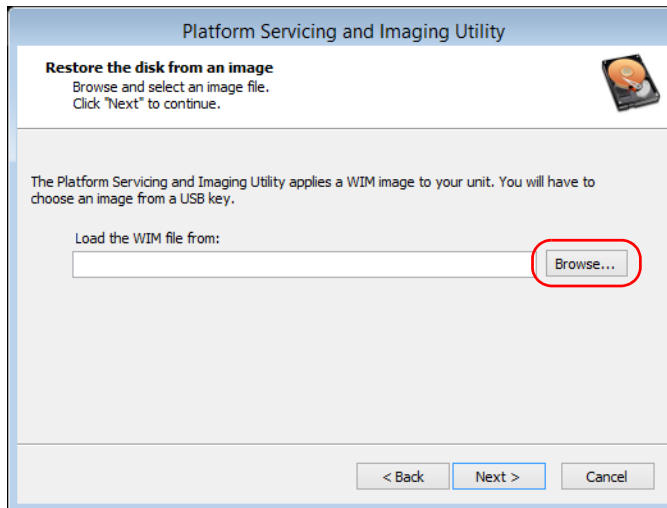

9d. Locate the USB key, and then double-tap its identifier to access the contents.

9e. Select the desired WIM file.

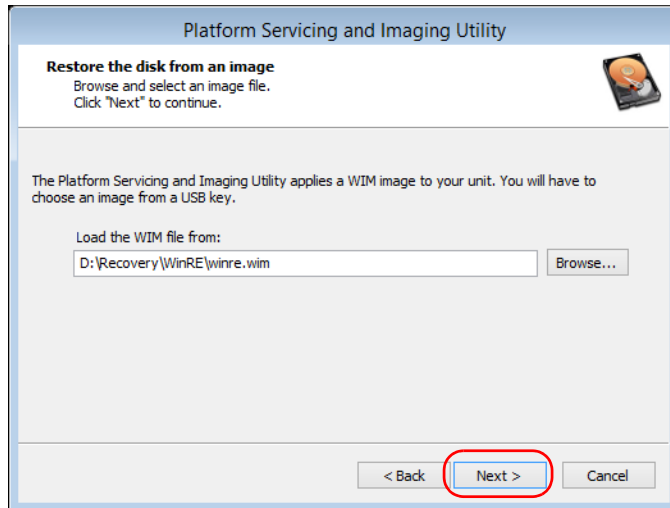
9f. Tap **Next**.

- 9g.** Read the warning, and then tap **Start** to restore the unit with the selected image.
- 9h.** When the operation is complete and the application prompts you, disconnect the USB key, and then tap **OK**.

The unit will restart.

**IMPORTANT**

The creation of a WIM file implies a compression of the files that are currently installed on your unit. The size of the files after compression cannot be estimated beforehand.

For this reason, the application **WILL NOT PROMPT YOU AT THE BEGINNING** of the operation if the storage capacity (or the file system) of your USB key is not appropriate.

To avoid problems, always use a USB key with an NTFS file system, and a minimum of 16 GB of free disk space.

Troubleshooting

Restoring Your Unit to Normal Operation

To create a WIM file for your unit:

1. On your unit, from the right side of the screen, swipe left to display the Charm bar.
2. Tap **Settings > Change PC settings**.

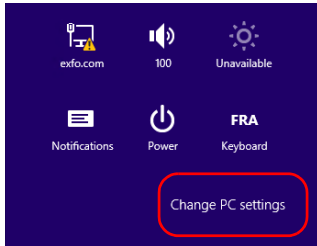

3. Tap **Update and recovery**.

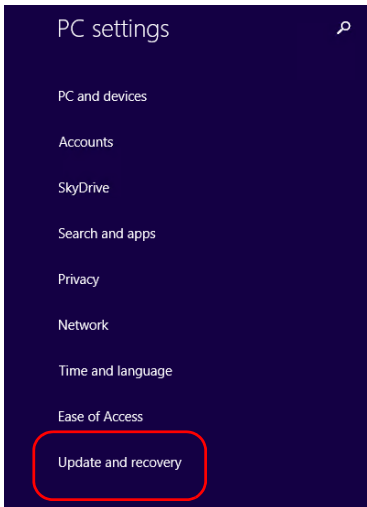

4. Tap **Recovery**.

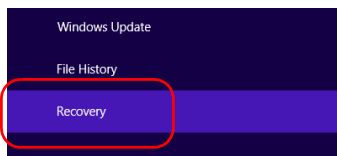

5. Under **Advanced Startup**, tap **Restart now**.

Refresh your PC without affecting your files

If your PC isn't running well, you can refresh it without losing your photos, music, videos, and other personal files.

Get started

Remove everything and reinstall Windows

If you want to recycle your PC or start over completely, you can reset it to its factory settings.

Get started

Advanced startup

Start up from a device or disc (such as a USB drive or DVD), change your PC's firmware settings, change Windows startup settings, or restore Windows from a system image. This will restart your PC.

Restart now

Troubleshooting

Restoring Your Unit to Normal Operation

- Under **Choose an option**, tap **Troubleshoot**.

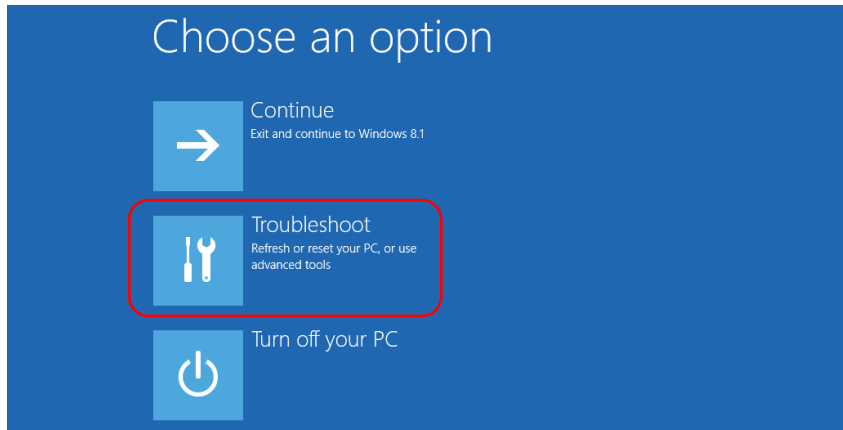

- Tap **Platform Imaging Utility** to display the corresponding application.

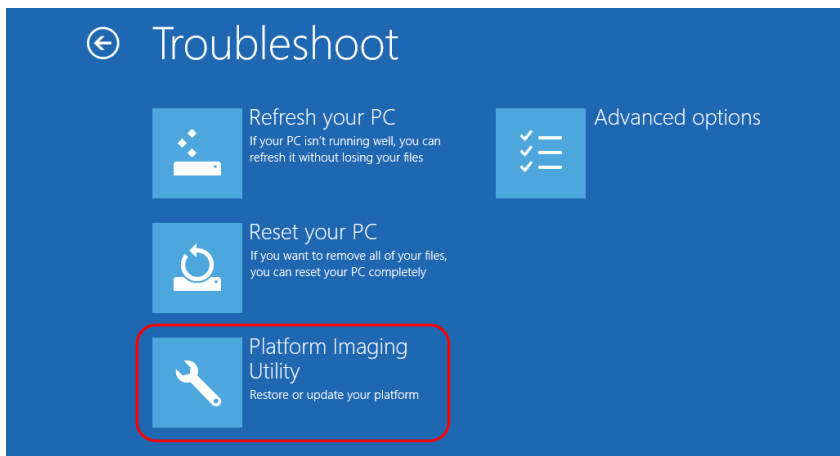

- Connect a USB key to your unit.

- From the Platform Servicing and Imaging Utility wizard, select **Create a WIM file**, and then tap **Next**.

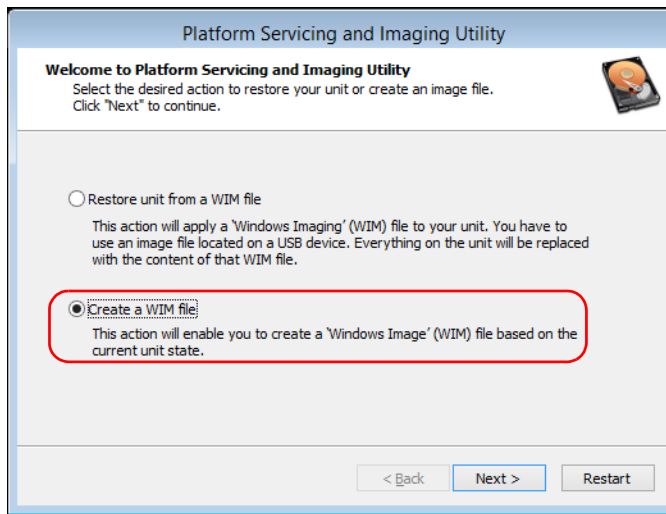

- Tap **Browse**.

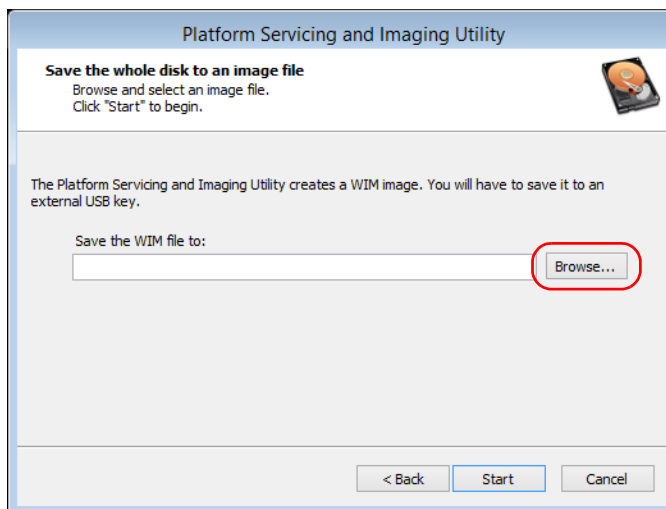

Troubleshooting

Restoring Your Unit to Normal Operation

- 11.** Locate the USB key, and then double-tap its identifier to access the contents.
- 12.** Select the desired folder.
- 13.** Enter a file name, and then tap **Save**.
- 14.** Tap **Start**.

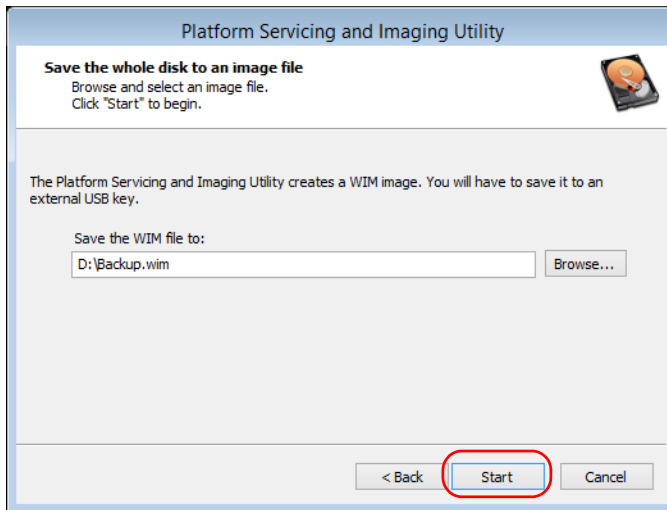

Note: *The time required to create the image varies with the configuration of your unit.*

- 15.** When the operation is complete and the application prompts you, tap **OK**.
- 16.** Disconnect the USB key.

17. Tap **Cancel** to return to the Welcome window of the utility.

18. Tap **Restart**.

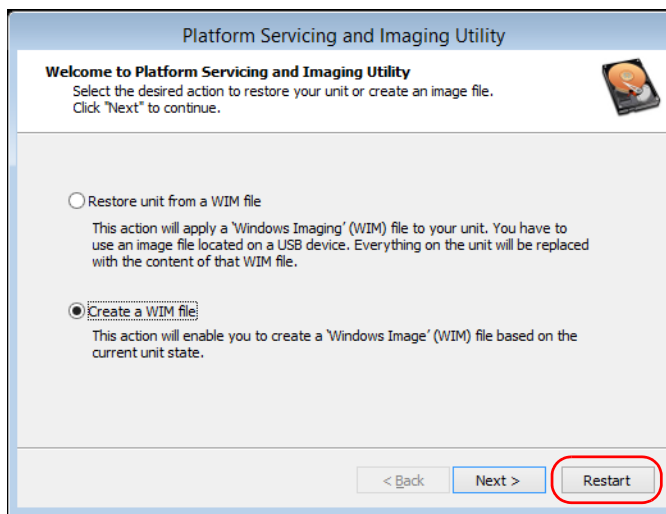

The WIM file is ready for future use.

Troubleshooting

Accessing the Online Documentation

Accessing the Online Documentation

You can access the user documentation as well as the license agreements at all times from your unit.

There are two formats of user documentation provided on your unit: online help and complete user guides (for products having safety instructions). When you open user documentation in PDF format from ToolBox (or the configuration wizard), the files are displayed automatically in the provided PDF viewer.

Note: *The user guides of all products are available from the My EXFO section of the EXFO Web site (www.exfo.com) for download in PDF format.*

To view the online help:

From ToolBox or an instrument application, tap  (or the equivalent).

To view the documentation in PDF format:

1. From the main window, tap the **Utilities** button.
2. Tap the icon corresponding to the type of document that you want to view.

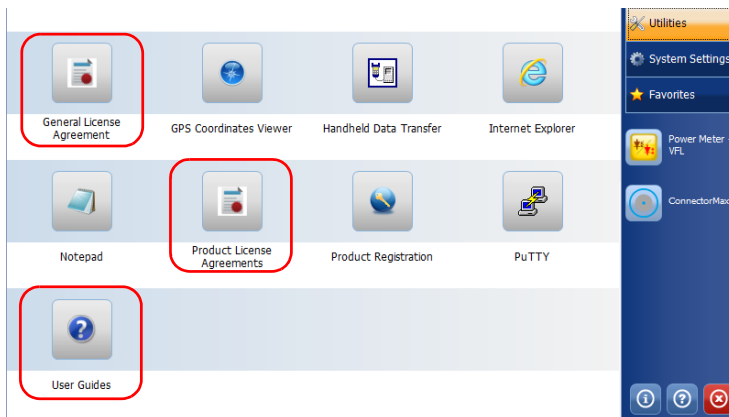

3. If necessary, double-tap the desired document to open it.

Contacting the Technical Support Group

To obtain after-sales service or technical support for this product, contact EXFO at one of the following numbers. The Technical Support Group is available to take your calls from Monday to Friday, 8:00 a.m. to 7:00 p.m. (Eastern Time in North America).

Technical Support Group

400 Godin Avenue
Quebec (Quebec) G1M 2K2
CANADA

1 866 683-0155 (USA and Canada)
Tel.: 1 418 683-5498
Fax: 1 418 683-9224
support@exfo.com

For detailed information about technical support, and for a list of other worldwide locations, visit the EXFO Web site at www.exfo.com.

If you have comments or suggestions about this user documentation, you can send them to customer.feedback.manual@exfo.com.

To accelerate the process, please have information such as the name and the serial number (see the product identification label), as well as a description of your problem, close at hand.

Viewing System Information

You can easily access important information such as the serial number, version numbers for ToolBox and hardware components, or network interfaces information directly from your unit. You can also find the contact information if you ever need to reach EXFO.

Retrieving the Serial Number of Your Unit

The serial number of your unit is easily accessible from ToolBox.

Note: *You can also view the serial number on the label affixed to the back of your unit.*

To retrieve the serial number of your unit:

1. In the lower right corner of the main window, tap .
2. Tap the **Platform** tab.

The serial number is displayed.

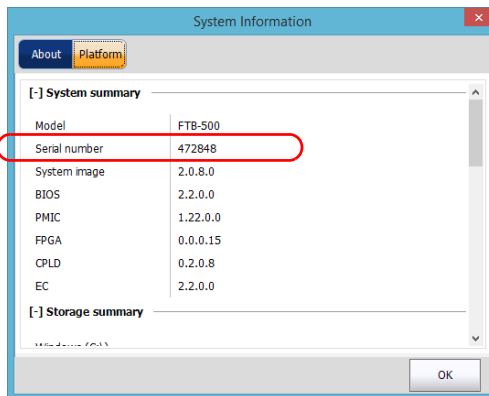

Note: *The serial numbers of your modules are visible from the **Modules** window.*

Retrieving the Component Versions

You can view the version of ToolBox as well as those of the system image and hardware components that are installed on your unit.

To retrieve the ToolBox version:

1. In the lower right corner of the main window, tap .
2. Tap the **About** tab.

The version number is displayed.



Troubleshooting

Viewing System Information

To retrieve the version numbers of the system image and hardware components:

1. In the lower right corner of the main window, tap .
2. Tap the **Platform** tab.

The version numbers are displayed.

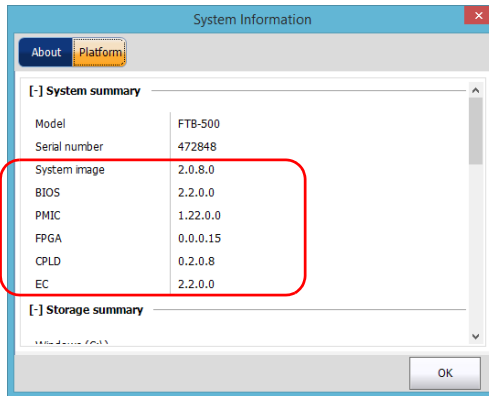

Retrieving Network Interfaces Information

You can view the information related to the network interfaces (adapters) such as the status of the interfaces, the IP address, etc.

To retrieve network interfaces information for Ethernet and Bluetooth:

1. In the lower right corner of the main window, tap .
2. Tap the **Platform** tab.

The information is displayed (one section per network interface).

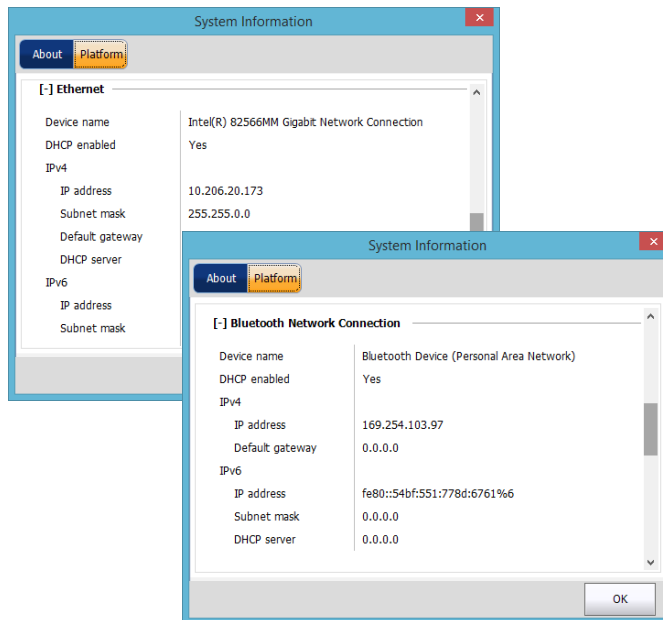

Troubleshooting

Retrieving Network Interfaces Information

To retrieve network interfaces information for Wi-Fi:

1. From the main window, tap the **System Settings** button.
2. Tap **Control Panel**.

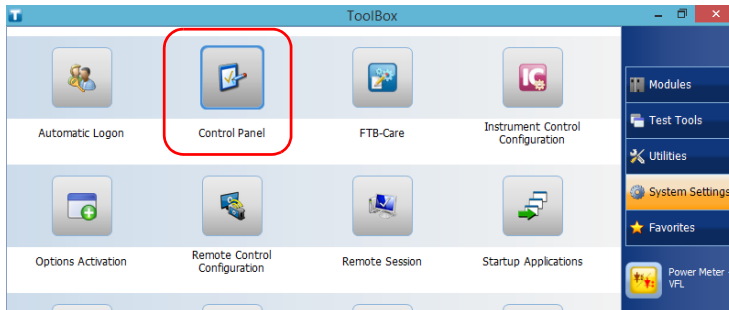

3. Under **Network and Internet**, tap **View network status and tasks**.

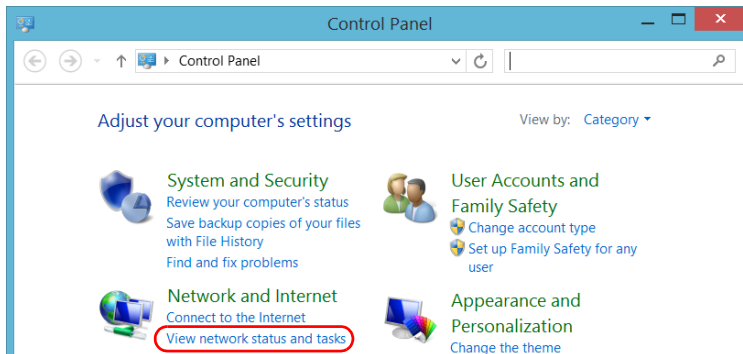

4. Tap the link corresponding to the Wi-Fi network.

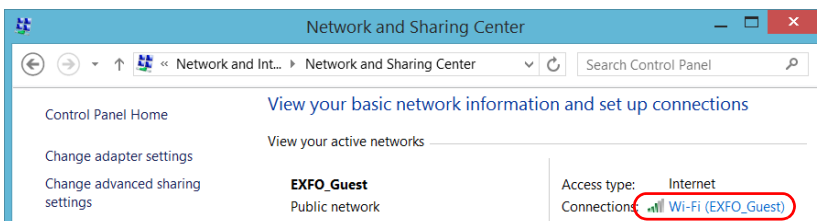

- From the **Wi-Fi Status** window, tap **Details**.

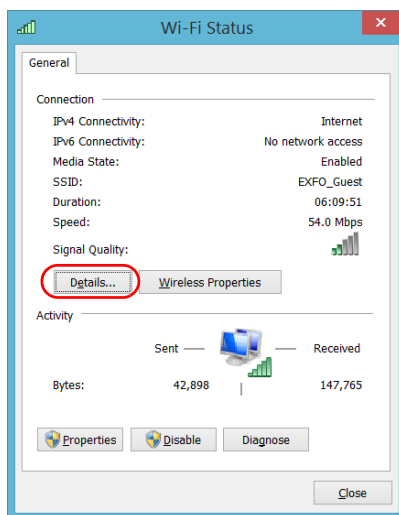

- When your work is done, close the window.

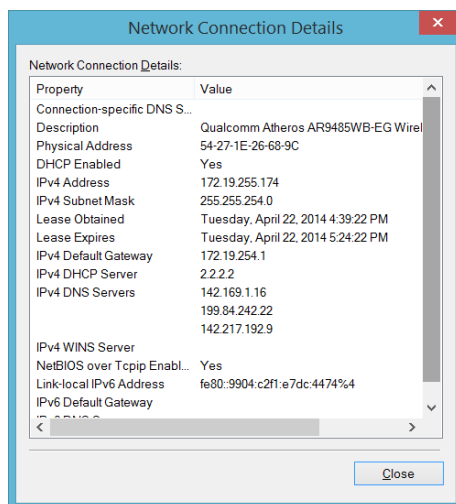

- Close all other windows to return to ToolBox.

Troubleshooting

Transportation

Retrieving the Contact Information

All the information necessary to contact EXFO is available from your unit.

To retrieve the contact information:

1. In the lower right corner of the main window, tap .
2. Tap the **About** tab.

The contact information is displayed.



Transportation

Maintain a temperature range within specifications when transporting the unit. Transportation damage can occur from improper handling. The following steps are recommended to minimize the possibility of damage:

- Pack the unit in its original packing material when shipping.
- Avoid high humidity or large temperature fluctuations.
- Keep the unit out of direct sunlight.
- Avoid unnecessary shocks and vibrations.

14 Warranty

General Information

EXFO Inc. (EXFO) warrants this equipment against defects in material and workmanship for a period of one year from the date of original shipment. EXFO also warrants that this equipment will meet applicable specifications under normal use.

During the warranty period, EXFO will, at its discretion, repair, replace, or issue credit for any defective product, as well as verify and adjust the product free of charge should the equipment need to be repaired or if the original calibration is erroneous. If the equipment is sent back for verification of calibration during the warranty period and found to meet all published specifications, EXFO will charge standard calibration fees.



IMPORTANT

The warranty can become null and void if:

- unit has been tampered with, repaired, or worked upon by unauthorized individuals or non-EXFO personnel.
- warranty sticker has been removed.
- case screws, other than those specified in this guide, have been removed.
- case has been opened, other than as explained in this guide.
- unit serial number has been altered, erased, or removed.
- unit has been misused, neglected, or damaged by accident.

THIS WARRANTY IS IN LIEU OF ALL OTHER WARRANTIES EXPRESSED, IMPLIED, OR STATUTORY, INCLUDING, BUT NOT LIMITED TO, THE IMPLIED WARRANTIES OF MERCHANTABILITY AND FITNESS FOR A PARTICULAR PURPOSE. IN NO EVENT SHALL EXFO BE LIABLE FOR SPECIAL, INCIDENTAL, OR CONSEQUENTIAL DAMAGES.

Warranty

Liability

Liability

EXFO shall not be liable for damages resulting from the use of the product, nor shall be responsible for any failure in the performance of other items to which the product is connected or the operation of any system of which the product may be a part.

EXFO shall not be liable for damages resulting from improper usage or unauthorized modification of the product, its accompanying accessories and software.

Exclusions

EXFO reserves the right to make changes in the design or construction of any of its products at any time without incurring obligation to make any changes whatsoever on units purchased. Accessories, including but not limited to fuses, pilot lamps, batteries and universal interfaces (EUI) used with EXFO products are not covered by this warranty.

This warranty excludes failure resulting from: improper use or installation, normal wear and tear, accident, abuse, neglect, fire, water, lightning or other acts of nature, causes external to the product or other factors beyond the control of EXFO.



IMPORTANT

In the case of products equipped with optical connectors, EXFO will charge a fee for replacing connectors that were damaged due to misuse or bad cleaning.

Certification

EXFO certifies that this equipment met its published specifications at the time of shipment from the factory.

Service and Repairs

EXFO commits to providing product service and repair for five years following the date of purchase.

To send any equipment for service or repair:

- 1.** Call one of EXFO's authorized service centers (see *EXFO Service Centers Worldwide* on page 318). Support personnel will determine if the equipment requires service, repair, or calibration.
- 2.** If equipment must be returned to EXFO or an authorized service center, support personnel will issue a Return Merchandise Authorization (RMA) number and provide an address for return.
- 3.** If possible, back up your data before sending the unit for repair.
- 4.** Pack the equipment in its original shipping material. Be sure to include a statement or report fully detailing the defect and the conditions under which it was observed.
- 5.** Return the equipment, prepaid, to the address given to you by support personnel. Be sure to write the RMA number on the shipping slip. *EXFO will refuse and return any package that does not bear an RMA number.*

Note: *A test setup fee will apply to any returned unit that, after test, is found to meet the applicable specifications.*

After repair, the equipment will be returned with a repair report. If the equipment is not under warranty, you will be invoiced for the cost appearing on this report. EXFO will pay return-to-customer shipping costs for equipment under warranty. Shipping insurance is at your expense.

Routine recalibration is not included in any of the warranty plans. Since calibrations/verifications are not covered by the basic or extended warranties, you may elect to purchase FlexCare Calibration/Verification Packages for a definite period of time. Contact an authorized service center (see *EXFO Service Centers Worldwide* on page 318).

Warranty

EXFO Service Centers Worldwide

EXFO Service Centers Worldwide

If your product requires servicing, contact your nearest authorized service center.

EXFO Headquarters Service Center

400 Godin Avenue
Quebec (Quebec) G1M 2K2
CANADA

1 866 683-0155 (USA and Canada)
Tel.: 1 418 683-5498
Fax: 1 418 683-9224
support@exfo.com

EXFO Europe Service Center

Winchester House, School Lane
Chandlers Ford, Hampshire S053 4DG
ENGLAND

Tel.: +44 2380 246800
Fax: +44 2380 246801
support.europe@exfo.com

EXFO Telecom Equipment (Shenzhen) Ltd.

3rd Floor, Building C,
FuNing Hi-Tech Industrial Park, No. 71-3,
Xintian Avenue,
Fuyong, Bao'An District,
Shenzhen, China, 518103

Tel: +86 (755) 2955 3100
Fax: +86 (755) 2955 3101
support.asia@exfo.com

To view EXFO's network of partner-operated Certified Service Centers nearest you, please consult EXFO's corporate website for the complete list of service partners:

<http://www.exfo.com/support/services/instrument-services/exfo-service-centers>.

A Data Types

The following section provides an overview of the most common data types that may appear in EXFO's documentation on commands and queries. The information is supplied for guidance only.

For more detailed information, please refer to IEEE 488.2 and SCPI standards.

Data types are divided into two groups: <PROGRAM DATA> for the types that are used when you want to send messages to a device and <RESPONSE DATA> for the types that are used when a device sends responses to the controller.

The data types are presented in graphics often referred to as "railroad diagrams". The following example illustrates how to interpret such diagrams.

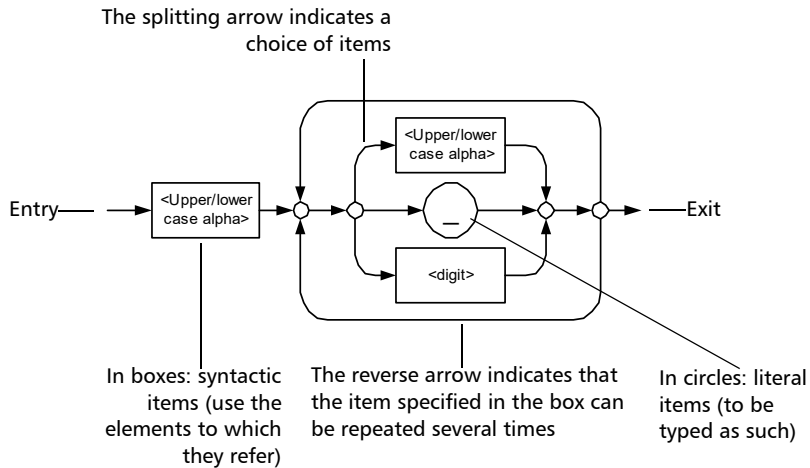

Data Types

Applicable Data Types for Input—IEEE 488.2

Applicable Data Types for Input—IEEE 488.2

- <PROGRAM MESSAGE TERMINATOR>

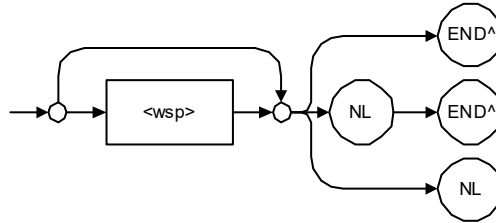

In the diagram above,

- “NL” corresponds to ASCII character code 10, in decimal (0A in binary)
- “END ^” corresponds to the last data byte of the message sent with EOI = True and ATN = False

➤ **<CHARACTER PROGRAM DATA>**

This data type will be used to send short mnemonics when a *<DECIMAL NUMERIC PROGRAM DATA>* cannot be used.

Examples: TRIANGLEWAVE, NCONTINUOUS

➤ **<DECIMAL NUMERIC PROGRAM DATA>** (or **<NRf>**)

This data type includes **<NR1>**, **<NR2>** and **<NR3>** data types. It will be used for decimal fractions with or without an exponent. Instruments will adapt the values they receive to fit their degree of precision. For example, if an instrument has a precision of two digits after the decimal point and the incoming value is 12.048, this value will be rounded off to 12.05.

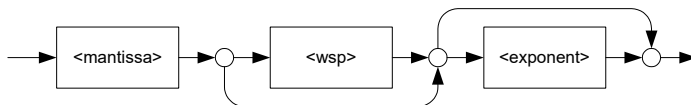

The second diagram below illustrates the **<mantissa>** syntax.

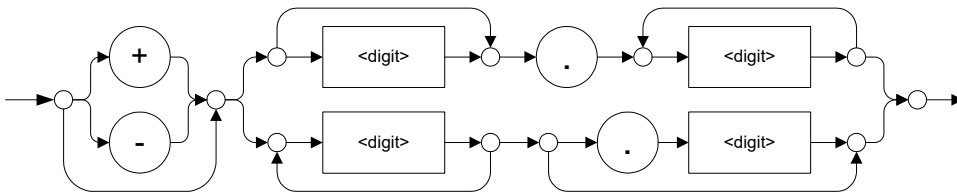

The third diagram illustrates the **<exponent>** syntax.

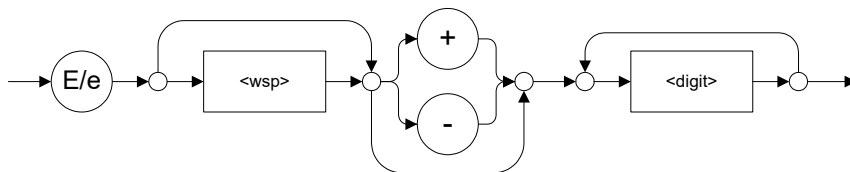

Examples: +2.0 e5, -.56E+4, 6.5e-10

Data Types

Applicable Data Types for Input—IEEE 488.2

➤ <NON-DECIMAL NUMERIC PROGRAM DATA>

This data type will be used for integer representation in hexadecimal (base 16), octal (base 8) or binary (base 2). The numeric representations will begin with “#H” for hexadecimal, “#Q” for octal and “#B” for binary.

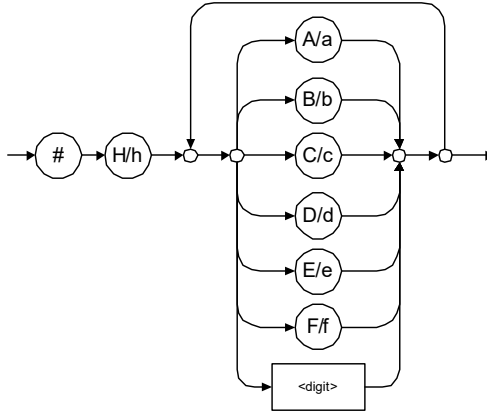

Examples: #Hf3bc015d, #h01a4, #hfe

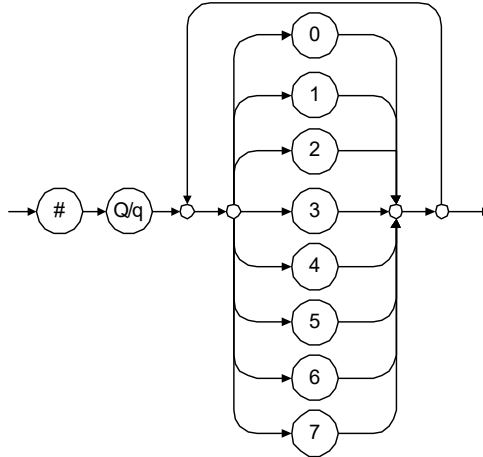

Examples: #Q1234567, #q1275, #q07

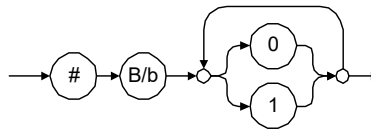

Examples: #B10010111, #b10110, #b1100

Data Types

Applicable Data Types for Input—IEEE 488.2

➤ <STRING PROGRAM DATA>

This data type will be used for strings containing 7-bit ASCII characters that have to be enclosed in either single- or double-quotes delimiters.

If a string needs to contain a character that is exactly the same as the delimiter, make sure to double the character to avoid syntax errors.

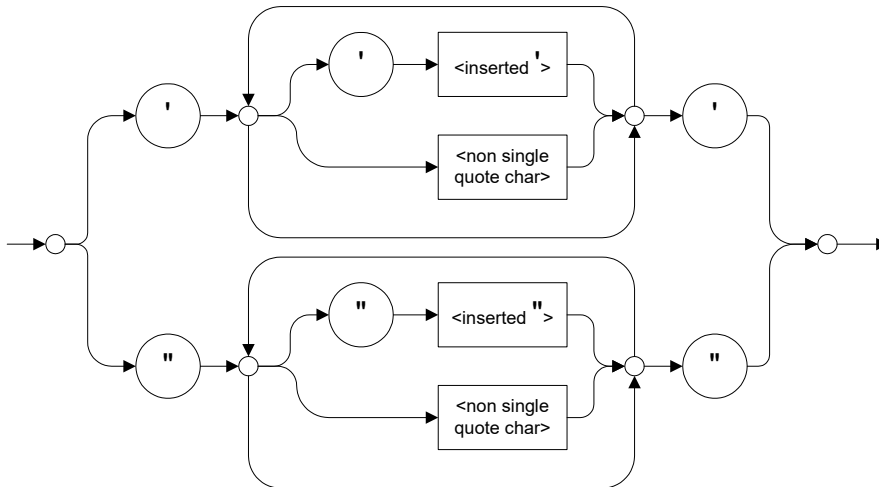

Examples: "SCPI Commands", 'SCPI Commands', "SCPI 'Commands'",
'SCPI "Commands"', "SCPI ""Commands""", 'SCPI '''Commands'''

➤ <ARBITRARY BLOCK PROGRAM DATA>

This data type is used to send blocks of arbitrary 8-bit information when you need to work with large amounts of data.

The actual length of the data that you send has the following structure:

- The first byte contains the # character.
- The byte that immediately follows contains the number of subsequent bytes that you have to check to obtain the total length.

Note: *If you use a zero as the first digit (#0), it has to be followed by a <PROGRAM MESSAGE TERMINATOR > so that the device will detect the end of the <ARBITRARY BLOCK PROGRAM DATA>. This will also force immediate termination of the message.*

For example, if you send the following data (here, values are expressed in decimal instead of binary for easier readability):

2 1 3 7 6 8 9 2 ...

The byte that immediately follows the # contains 2, which means that you would have to read the two following bytes to know the length (in bytes) of the retrieved data. The bytes indicate 1 and 3. The length will then be 13 bytes. The actual response will begin at byte number 5, in this case.

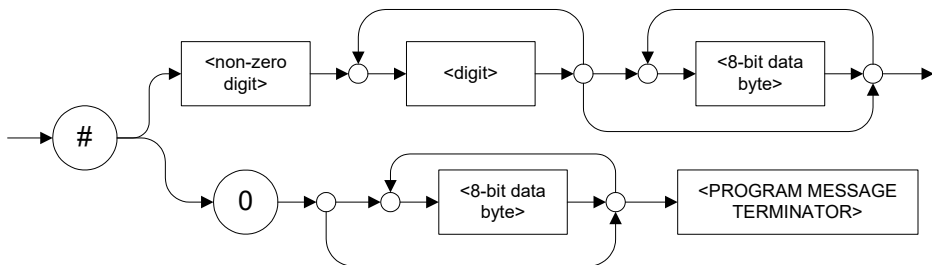

Data Types

Applicable Data Types for Input—IEEE 488.2

► <SUFFIX PROGRAM DATA>

This data type is used when units and multipliers have to be sent.

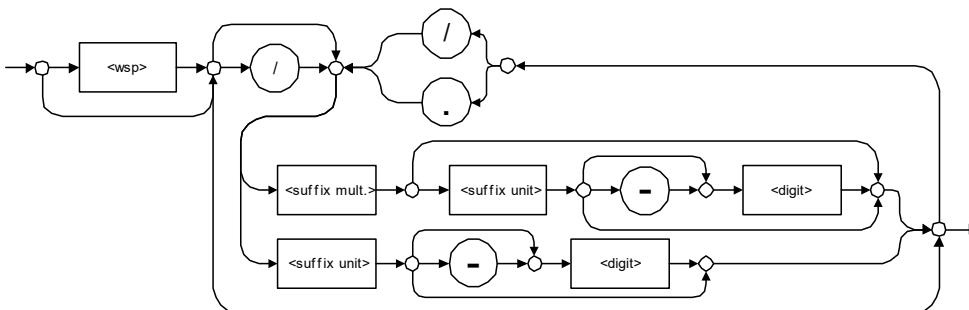

Examples: nm, kHz, km/s², uW

A relative unit (dB) can be referenced to an absolute level, as shown on the following diagram.

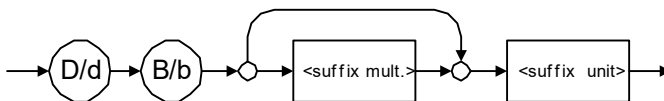

Examples: db, dbm, dBW

The following table illustrates the possible forms for <suffix mult.>:

Name	Value	Mnemonic
Exa	1E18	EX
Peta	1E15	PE
Tera	1E12	T
Giga	1E9	G
Mega	1E6	MA
Kilo	1E3	K
Milli	1E-3	M
Micro	1E-6	U
Nano	1E-9	N
Pico	1E-12	P
Femto	1E-15	F
Atto	1E-18	A

Data Types

Applicable Data Types for Input—IEEE 488.2

The table below gives the possible forms for <suffix unit> :

Reference Unit	Suffix Unit
Degrees	DEG
Radians	RAD
Amperes	A
Volts	V
Hertz	HZ
Meters	M
Watts	W
DBs ref to 1mW	DBM
Decibels	DB
Degrees Celsius	CEL
Degrees Fahrenheit	FAR
Kelvins	K
Seconds	S
Hours	HR
Minutes	MIN

Applicable Data Types for Output —IEEE 488.2

- <RESPONSE MESSAGE TERMINATOR>

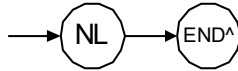

In the diagram above,

- “NL” corresponds to ASCII character code 10, in decimal (0A in binary)
- “END ^” corresponds to the last data byte of the message sent with EOI = True and ATN = False
- <CHARACTER RESPONSE DATA>

This data type will be used by a device to return short mnemonics when a <DECIMAL NUMERIC PROGRAM DATA> cannot be used. The returned information is sent in the long form and in upper case.

Examples: TRIANGLEWAVE, NCONTINUOUS

Data Types

Applicable Data Types for Output —IEEE 488.2

- <NR1 NUMERIC RESPONSE DATA> (or <NR1>)

This data type will be used by a device to return positive or negative integers.

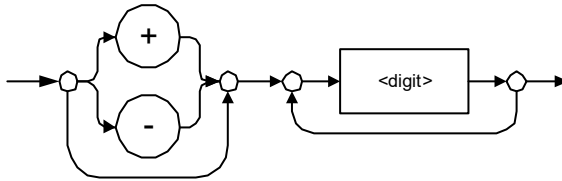

Examples: 4, -23, 90

- <NR2 NUMERIC RESPONSE DATA> (or <NR2>)

This data type will be used by a device to return positive or negative real numbers (fixed-point numbers).

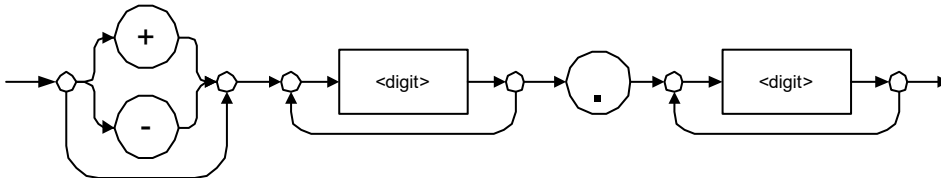

Examples: 23.45, 1.22, -4.55

➤ **<NR3 NUMERIC RESPONSE DATA> (or <NR3>)**

This data type will be used by a device to return positive or negative exponential numbers (floating-point numbers).

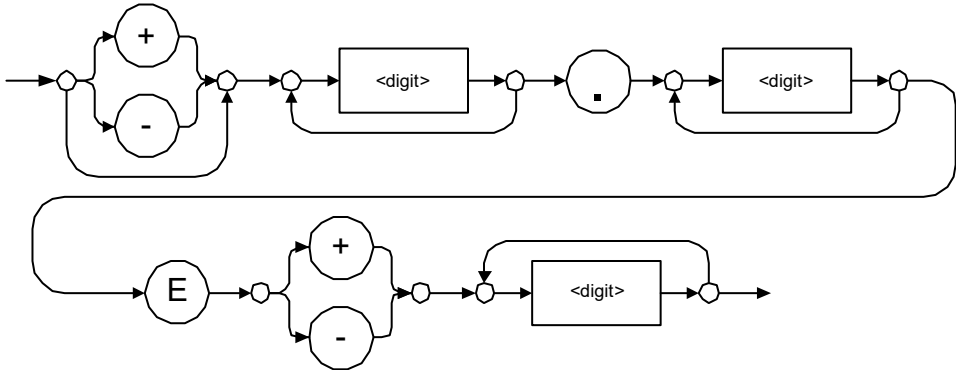

Examples: 4.3E-3, -8.9456E8, 123E-5

Data Types

Applicable Data Types for Output —IEEE 488.2

➤ **Special Numeric Values Received on Output**

In some cases, an instrument may send values indicating that an unusual event has occurred. The following tables present the possible values.

Value is	ASCII 4 bytes	PACKED 4 bytes
Under range	2143289345.000000	7FC00001
Over range	2143289346.000000	7FC00002
Invalid	2143289347.000000	7FC00003
Inactive	2143289348.000000	7FC00004

Value is	ASCII 8 bytes	PACKED 8 bytes
Under range	9221120237577961472	7FF8000020000000
Over range	9221120238114832384	7FF8000040000000
Invalid	9221120238651703296	7FF8000060000000
Inactive	9221120239188574208	7FF8000080000000

➤ <HEXADECIMAL NUMERIC RESPONSE DATA>

This data type will be used by a device to return integer representations in hexadecimal (base 16).

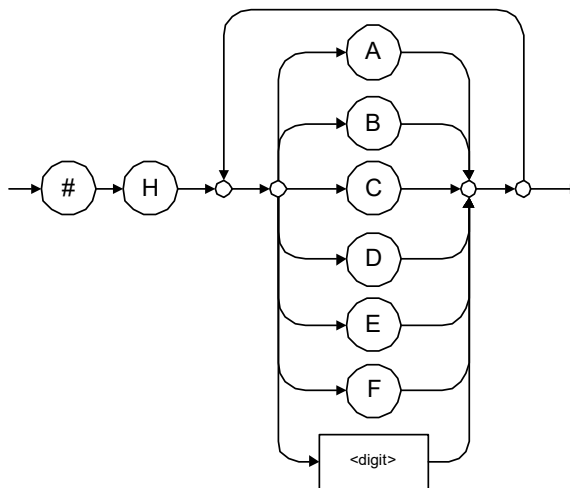

Examples: #HA3C5, #H0123C, #H010F

Data Types

Applicable Data Types for Output —IEEE 488.2

➤ <OCTAL NUMERIC RESPONSE DATA>

This data type will be used by a device to return integer representations in octal (base 8).

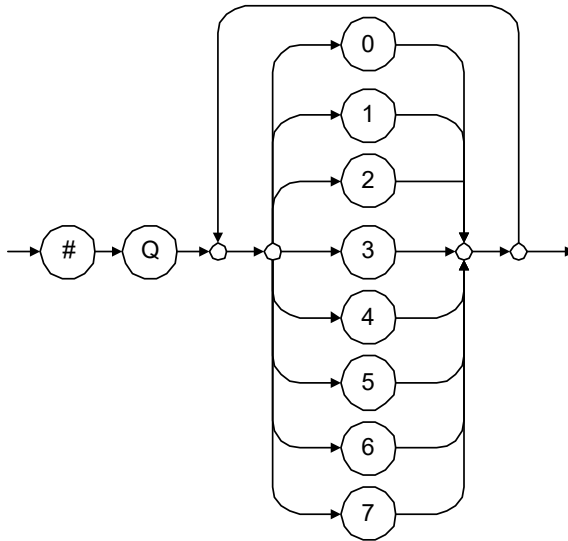

Examples: #Q753214, #Q0124, #Q0725

➤ **<BINARY NUMERIC RESPONSE DATA>**

This data type will be used by a device to return integer representations in binary (base 2).

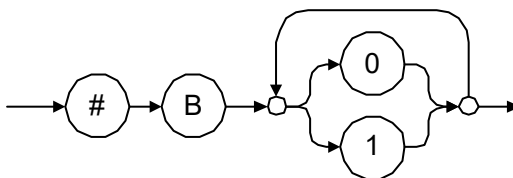

Examples: #B11011110101, #B110100, #B0100

➤ **<STRING RESPONSE DATA>**

This data type will be used by a device to return strings containing 7-bit ASCII characters and especially when text has to be displayed since even the non-printable characters are also returned.

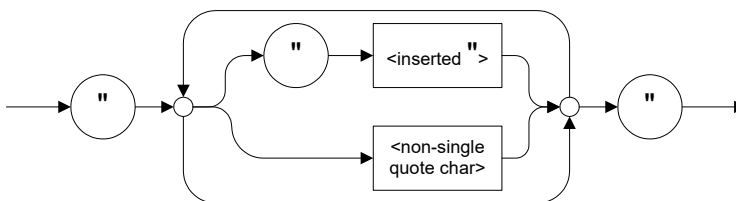

Examples: "SCPI Commands", "SCPI ""Commands""

Data Types

Applicable Data Types for Output —IEEE 488.2

➤ <DEFINITE LENGTH ARBITRARY BLOCK RESPONSE DATA>

This data type is used by a device to return blocks of 8-bit binary information with a fixed and predetermined length.

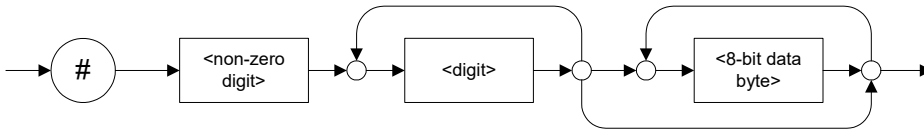

The actual length of the retrieved data has the following structure:

- The first byte contains the # character.
- The byte that immediately follows contains the number of subsequent bytes that you have to check to know the total length.

For example, if you receive this response (here, values are expressed in decimal instead of binary for easier readability):

2 1 3 7 6 8 9 2 ...

The byte that immediately follows the # contains 2, which means that you have to read the two following bytes to know the length (in bytes) of the retrieved data. The bytes indicate 1 and 3. The length will then be 13 bytes. The actual response will begin at byte number 5, in this case.

Examples: #14<DAB> <DAB> <DAB> <DAB> ,

#3004<DAB> <DAB> <DAB> <DAB>

where “<DAB>” stands for data byte

➤ **<INDEFINITE LENGTH ARBITRARY BLOCK RESPONSE DATA>**

This data type is used by a device to return blocks of 8-bit binary information when the block length was not predefined or when data has to be computed later.

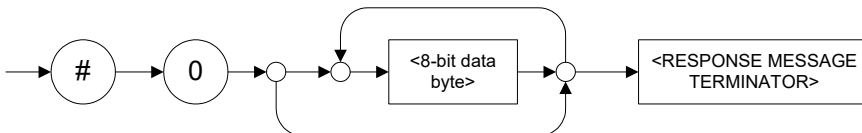

Note: *If you receive a zero as the first digit (#0), it is necessarily followed by a <RESPONSE PROGRAM MESSAGE TERMINATOR> so that you will detect the end of the <INDEFINITE LENGTH ARBITRARY BLOCK RESPONSE DATA>.*

Example: #0<DAB><DAB><DAB><DAB><terminator> where “<DAB>” stands for data byte.

Data Types

Applicable Data Types for Output —IEEE 488.2

➤ <SUFFIX RESPONSE DATA>

This data type is used by a device to return units and multipliers.

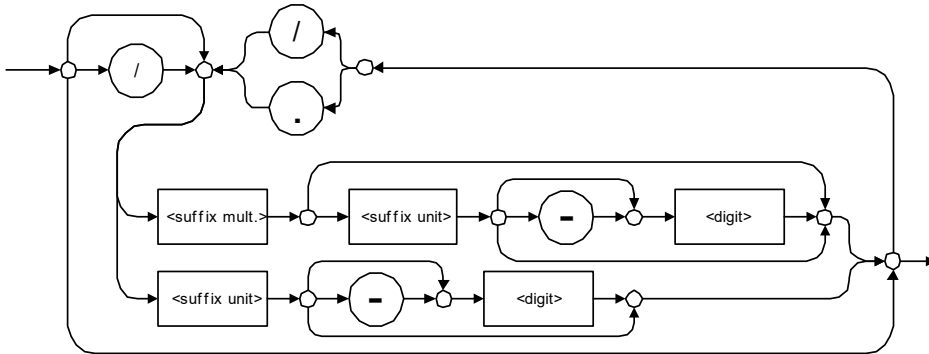

Examples: DBW, W, KHZ

➤ <ARBITRARY ASCII RESPONSE DATA>

This data type is used by a device to return information when it is impossible to use any other data type.

Example: To the *IDN? query, the device will return this response in an arbitrary ASCII bytes format:

EXFO E.O. Engineering,,125-2A55,1.0.1.97

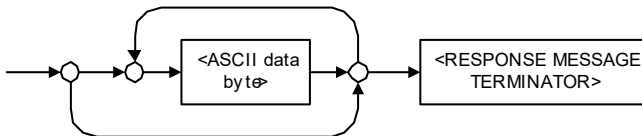

Applicable Data Types for Input—SCPI

SCPI data types include the IEEE 488.2 data types (see *Applicable Data Types for Input—IEEE 488.2* on page 320) with certain additional restrictions.

- `<numeric_value>`: abbreviated form of the decimal numeric element. It differs from the `<DECIMAL NUMERIC PROGRAM DATA>` “`<NRf>`” described in IEEE 488.2.

Several forms of `<CHARACTER PROGRAM DATA>` are defined as special forms of numbers. These are: `MINimum`, `MAXimum`, `DEFault`, `UP`, `DOWN`, `Not A Number (NAN)`, `INFinity` and `Negative INFinity (NINF)`. The following special forms are likely to be used by EXFO’s instruments in certain commands or queries:

- `DEFault`: This special `<numeric_value>` parameter forces the instrument to select a value, which is deemed to be convenient to the user.
- `MINimum` | `MAXimum`: These special `<numeric_value>` parameters refer to the instrument’s limit values. `MINimum` corresponds to the value closest to negative infinity that the function can accept. `MAXimum` corresponds to the largest value that the function can accept.
- `<Boolean Program Data>`: This form is often used as a shorthand of the `<DECIMAL NUMERIC PROGRAM DATA>ON|OFF` form.

`<Boolean Program Data>` parameters have a value of 0 or 1 and are not followed by any unit.

On input, an `<NRf>` is rounded to an integer.

A non-zero result is interpreted as 1.

`ON` and `OFF` are accepted on input for readability purposes. They correspond respectively to 1 and 0. However, on output, they appear as 1 or 0, never `ON` or `OFF`.

Data Types

Special Numeric Values Received on Output

Special Numeric Values Received on Output

It is possible that an instrument returns unusual values in certain cases. For information on these values, see Applicable Data Types for Output —IEEE 488.2 *on page 329*.

B *IEEE 488.2 and Specific Command Reference*

This chapter presents detailed information about the commands and queries supplied with your FTB-500.

IEEE 488.2 Commands–Quick Reference

The FTB-500 recognizes the required commands identified in IEEE 488.2. The table below summarizes these commands. These commands are fully explained on the following pages.

Command	Function
*CLS	Clear status command
*ESE	Standard event status enable command
*ESE?	Standard event status enable query
*ESR?	Standard event status register query
*IDN?	Identification query
*OPC	Operation complete command
*OPC?	Operation complete query
*RST	Reset command
*SRE	Service request enable command
*SRE?	Service request enable query
*STB?	Read status byte query
*TST?	Self-test query
*WAI	Wait for pending operations to be completed

IEEE 488.2 Required Commands

		*CLS
Description	The *CLS command clears the Standard Event Status Register and the Error/Event Queue.	
Syntax	*CLS	
Parameter(s)	None	

ESE*Description**

The *ESE command sets the Standard Event Status Enable Register bits, as defined in the table below. This register contains a mask value for the bits to be enabled in the Standard Event Status Register.

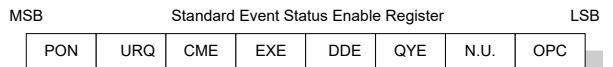
**Syntax**

*ESE<wsp> <RegisterValue>

Parameter(s)

RegisterValue:

The program data syntax for <RegisterValue> is defined as a <DECIMAL NUMERIC PROGRAM DATA> element.

The <RegisterValue>, expressed in base 2, represents the bit values of the Standard Event Status Enable Register.

IEEE 488.2 and Specific Command Reference

IEEE 488.2 Required Commands

***ESE**

The table below shows the contents of this register.

Bit	Weight	Meaning
PON	128	Power ON Enable
URQ	64	User ReQuest Enable
CMD	32	CoMmanD Error Enable
EXE	16	Execution Error Enable
DDE	8	Device Dependent Error Enable
QRY	4	QueRry Error Enable
N.U.	2	Not used
OPC	1	Operation Complete Enable

A value of 1 in the Enable Register enables the corresponding bit in the Status Register, a value of 0 disables the bit. The value of the <RegisterValue> shall be in the range of 0 through 255.

Example(s)

*ESE 25
where 25 = (bit EXE, bit DDE and bit OPC)

*ESE 0
clears the content of the Standard Event Status Enable register

See Also

*ESE?
*ESR?

*ESE?

Description With the *ESE? query you can determine the current contents of the Standard Event Status Enable Register. See the contents of this register below.

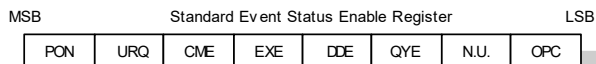

Syntax *ESE?

Parameter(s) None

Response Syntax <RegisterValue>

IEEE 488.2 and Specific Command Reference

IEEE 488.2 Required Commands

*ESE?

Response(s)

RegisterValue:

The response data syntax for <RegisterValue> is defined as a <NR1 NUMERIC RESPONSE DATA> element.

The <RegisterValue> ranges from 0 through 255.

The <RegisterValue> value expressed in base 2 (binary) represents the bit values of the Standard Event Status Enable register. See below.

Bit	Weight	Meaning
PON	128	Power ON Enable
URQ	64	User ReQuest Enable
CMD	32	CoMmanD Error Enable
EXE	16	Execution Error Enable
DDE	8	Device Dependent Error Enable
QRY	4	QueRry Error Enable
N.U.	2	Not used
OPC	1	Operation Complete Enable

Example(s)

*ESE? returns 133
where 133 = (bit PON, bit QYE and bit OPC)

See Also

*ESE
*ESR?

***ESR?**

Description With the *ESR? query you can determine the current contents of the Standard Event Status Register. Reading the Standard Event Status Register clears it. See the contents of this register below.

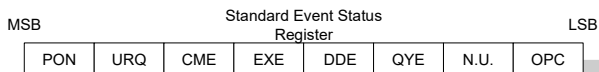

Syntax *ESR?

Parameter(s) None

Response Syntax <RegisterValue>

IEEE 488.2 and Specific Command Reference

IEEE 488.2 Required Commands

*ESR?

Response(s)

RegisterValue:

The response data syntax for <RegisterValue> is defined as a <NR1 NUMERIC RESPONSE DATA> element.

The <RegisterValue> ranges from 0 through 255.

The <RegisterValue> value expressed in base 2 (binary) represents the bit values of the Standard Event Status register. See below.

Bit	Weight	Meaning
PON	128	Power ON Enable
URQ	64	User ReQuest Enable
CMD	32	CoMmanD Error Enable
EXE	16	Execution Error Enable
DDE	8	Device Dependent Error Enable
QRY	4	QueRry Error Enable
N.U.	2	Not used
OPC	1	Operation Complete Enable

Example(s)

*ESR? returns 33
where 33 = (bit CME and bit OPC)

See Also

*ESE
*ESE?

***IDN?**

Description	The intent of the *IDN? query is for the unique identification of devices over the system interface.
Syntax	*IDN?
Parameter(s)	None
Response Syntax	<Identification>
Response(s)	<p><i>Identification:</i></p> <p>The response data syntax for <Identification> is defined as an <ARBITRARY ASCII RESPONSE DATA> element.</p>

The response syntax for the *IDN? query, <Identification> is defined as an <ARBITRARY ASCII RESPONSE DATA> element. This implies that the *IDN? query should be the last <QUERY MESSAGE UNIT> in a <TERMINATED PROGRAM MESSAGE>.

The response is organized into four fields separated by commas. The field definitions are as follows:

Field 1 (Manufacturer): EXFO Inc.
Field 2 (Model): Instrument Model

IEEE 488.2 and Specific Command Reference

IEEE 488.2 Required Commands

***IDN?**

Field 3 (Serial number): ASCII character (0 if not available)

Field 4 (Firmware level): ASCII character (0 if not available)

ASCII character 0 represents a single ASCII-encoded byte with a value of 30 (48 decimal).

The presence of data in all fields is mandatory. If either field 3 or 4 is not available, the ASCII character 0 shall be returned for that field. A field may contain any 7-bit ASCII-encoded bytes in the range of 20 through 7E (32 through 126 decimal) except commas (2C, 44 decimal) and semicolons (3B, 59 decimal).

Example(s)

*IDN? returns EXFO Inc.,
FTB-500,125-2A55,1.0.1.97

Notes

The overall length of the *IDN? response is less than or equal to 72 characters.

***OPC**

Description	The *OPC command makes synchronization between the instrument and an external controller possible. The *OPC command causes the instrument to set bit 0 (Operation Complete) in the Standard Event Status Register to the TRUE (logic 1) state when the instrument completes all pending operations. Detection of the Operation Complete message can be accomplished by continuous polling of the Standard Event Status Register using the *ESR? common query command. However, using a service request eliminates the need to poll the Standard Event Status Register thereby freeing the controller to do other useful work.
Syntax	*OPC
Parameter(s)	None
See Also	*OPC? *WAI

*OPC?

Description	The *OPC? query makes possible the synchronization between the instrument and an external controller by reading the Output Queue or by waiting for a service request on the Message Available (MAV) bit in the Status Byte Register. The *OPC? query causes the instrument to place an ASCII character, 1, into its Output Queue when the device completes all pending operations. A consequence of this action is that the MAV bit in the Status Byte Register is set to state 1.
Syntax	*OPC?
Parameter(s)	None
Response Syntax	<Acknowledge>
Response(s)	<i>Acknowledge:</i> The response data syntax for <Acknowledge> is defined as a <NR1 NUMERIC RESPONSE DATA> element. The <Acknowledge> response is a single ASCII-encoded byte corresponding to 1. The receipt of an <Acknowledge> response indicates that all pending selected device operations have been completed.
Example(s)	*OPC? returns 1
See Also	*OPC *WAI

RST*Description**

The *RST command performs a device reset. This command is the third reset level in a three-level reset strategy. The Reset command shall do the following:

- a) Sets the device-specific functions to a known state that is independent of the past-use history of the device.
- b) Forces the device into OCIS state (Operation complete Command Idle State).
- c) Forces the device into OQIS state (Operation complete Query Idle State).

The Reset command explicitly DOES NOT affect the following:

- a) The state of the Communication interface.
- b) The Output Queue.
- c) Any Event Enable Register setting, including the Standard Event Status Enable Register setting.
- d) Any Event Register setting, including the Standard Event Status Register settings.
- e) Calibration data that affects device specifications.
- f) The Service Request Enable Register setting.

Syntax

*RST

Parameter(s)

None

IEEE 488.2 and Specific Command Reference

IEEE 488.2 Required Commands

***SRE**

Description

The *SRE command sets the Service Request Enable Register bits. See the contents of this register below. This register contains a mask value to enable the bits in the Status Byte Register.

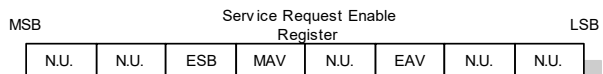

Syntax

*SRE<wsp> <RegisterValue>

Parameter(s)

RegisterValue:

The program data syntax for <RegisterValue> is defined as a <DECIMAL NUMERIC PROGRAM DATA> element.

The <RegisterValue> value ranges from 0 through 255.

The <RegisterValue>, expressed in base 2 (binary), represents the bit values of the Service Request Enable Register.

***SRE**

See the contents of this register below.

Bit	Weight	Meaning
N.U.	128	Not used
N.U.	64	Not used
ESB	32	Event Summary Bit Enable
MAV	16	Message AVailable Enable
N.U.	8	Not used
EAV	4	Error / Event AVailable Enable
N.U.	2	Not used
N.U.	1	Not used

A bit value of zero shall indicate a disabled condition.

Example(s)

*SRE 52
where 52 = (bit ESB, bit MAV and bit EAV)

See Also

*SRE?
*STB?

IEEE 488.2 and Specific Command Reference

IEEE 488.2 Required Commands

*SRE?

Description

With the *SRE? query you can determine the current contents of the Service Request Enable Register. See the contents of this register below.

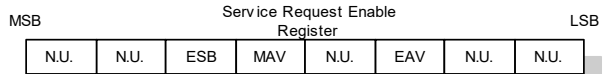

Bit	Weight	Meaning
N.U.	128	Not used
N.U.	64	Not used
ESB	32	Event Summary Bit Enable
MAV	16	Message AAvailable Enable
N.U.	8	Not used
EAV	4	Error / Event AAvailable Enable
N.U.	2	Not used
N.U.	1	Not used

Syntax

*SRE?

Parameter(s)

None

Response Syntax

<RegisterValue>

***SRE?**

Response(s)

RegisterValue:

The response data syntax for <RegisterValue> is defined as a <NR1 NUMERIC RESPONSE DATA> element.

The <RegisterValue> ranges from 0 through 255.

When converted to binary (base 2), the <RegisterValue> represents the current bit values of the Service Request Enable Register.

Example(s)

*SRE returns 32 (bit ESB)

See Also

*SRE
*STB?

IEEE 488.2 and Specific Command Reference

IEEE 488.2 Required Commands

***STB?**

Description

With the *STB? query you can read the status byte and Master Summary Status bit. See the content of this register below.

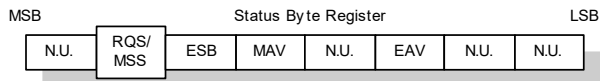
**Syntax**

*STB?

Parameter(s)

None

Response Syntax

<RegisterValue>

STB?*Response(s)***RegisterValue:*

The response data syntax for <RegisterValue> is defined as a <NR1 NUMERIC RESPONSE DATA> element.

The <RegisterValue> ranges from 0 through 255.

The <RegisterValue> value, expressed in base 2 (binary) represents the bit values of the Status Byte Register. See the contents of this register below.

Bit	Weight	Meaning
N.U.	128	Not used
RQS/ MSS	64	ReQuest Service (read by serial polling)/MaSter Summary bit (read by *STB?)
ESB	32	Event Summary Bit Enable
MAV	16	Message AVailable Enable
N.U.	8	Not used
EAV	4	Error / Event AVailable Enable
N.U.	2	Not used
N.U.	1	Not used

Example(s)

*STB? returns 68
where 68 = (bit MSS and bit EAV)

See Also

*SRE
*SRE?

IEEE 488.2 and Specific Command Reference

IEEE 488.2 Required Commands

*TST?	
Description	The *TST? query causes an internal self-test and places a response into the Output Queue indicating whether or not the device completed the self-test without any detected errors. Upon successful completion of *TST?, the device settings is restored to their values prior to the *TST?.
Syntax	*TST?
Parameter(s)	None
Response Syntax	<Result>
Response(s)	<p><i>Result:</i></p> <p>The response data syntax for <Result> is defined as a <NR1 NUMERIC RESPONSE DATA> element.</p> <p>The <Result> value ranges from -32767 through +32767.</p> <p>A <Result> with a value of zero indicates that the self-test has been completed without errors detected. A <Result> with a value not equal to zero indicates that the self-test was not completed or was completed with errors detected.</p>
Example(s)	*TST? returns 0 (self-test was completed with success)

***WAI**

Description	The *WAI command shall prevent the device from executing any further commands or queries until the no-operation-pending flag becomes TRUE.
Syntax	*WAI
Parameter(s)	None
Example(s)	*WAI
See Also	*OPC *OPC?

Specific Commands—Quick Reference

The table below contains a summary of the FTB-500 specific commands. These commands are fully explained on the following pages.

Command						Parameter(s)
FORMat	[DATA]					ASCIi PACKed[,<Length>]
	[DATA]?					
INSTRument	CATalog?					
	CATalog	FULL?				
SYSTem	DATE					<Year>,<Month>,<Day>
	DATE?					
	ERRor	[NEXT]?				
	TIME					<Hour>,<Minute>,<Seconds>
	TIME?					
	VERSIon?					

Specific Commands

:FORMat[:DATA]

Description

The FORMat[:DATA] command selects the data format and <Length>. The <Length> parameter is optional for all data format, its meaning is dependent on the data format selected.

If PACKed type is selected, the data is transferred in a <DEFINITE BLOCK RESPONSE DATA>. The ASCii-type data is automatically identified by its syntax. Therefore, in these cases, the FORMat subsystem is only necessary to determine the output format.

At *RST, ASCii is selected as the default data format and the <Length> is set to 0.

Syntax

:FORMat[:DATA] <wsp>ASCii|PACKed[, <Length>]

Parameter(s)

► *Type:*

The program data syntax for the first parameter is defined as a <CHARACTER PROGRAM DATA> element. The allowed <CHARACTER PROGRAM DATA> elements for this parameter are: ASCii|PACKed.

:FORMat[:DATA]

In ASCii format, the numeric data is transferred to ASCii bytes in <NR1 NUMERIC RESPONSE DATA>, <NR2 NUMERIC RESPONSE DATA> or <NR3 NUMERIC RESPONSE DATA> representation, as appropriate.

In PACKed format, data is transferred to a <DEFINITE BLOCK RESPONSE DATA>, in a manner specified in the device documentation.

► *Length:*

The program data syntax for <Length> is defined as a <DECIMAL NUMERIC PROGRAM DATA> element.

When ASCii data format is selected, the optional <Length> parameter specifies the number of significant digits to be returned. A <Length> value of zero indicates that the device selects the number of significant digits to be returned. When a <Length> of zero has been specified, the FORMat[:DATA]? query returns zero as its second parameter.

When the PACKed data format is selected, the optional parameter <Length> it not used.

Example(s)

FORM ASC
FORM ASC,6
FORM:DATA PACKED

See Also

FORMat[:DATA]?

:FORMat[:DATA]?

Description	<p>The FORMat[:DATA]? query returns the data format and the <Length>.</p> <p>At *RST, ASCii is selected as the default data format and the <Length> is set to 0.</p>
Syntax	:FORMat[:DATA]?
Parameter(s)	None
Response Syntax	<Type>,<Length>
Response(s)	<p>➤ <i>Type:</i></p> <p>The response data syntax for <Type> is defined as a <CHARACTER RESPONSE DATA> element.</p> <p>The ASCII <Type> is returned when numeric data is transferred to ASCII bytes in <NR1 NUMERIC RESPONSE DATA>, <NR2 NUMERIC RESPONSE DATA> or <NR3 NUMERIC RESPONSE DATA> representation, as appropriate.</p> <p>The PACKED <Type> is returned when data is transferred to a <DEFINITE BLOCK RESPONSE DATA>, as specified in the device documentation.</p> <p>➤ <i>Length:</i></p> <p>The response data syntax for <Length> is defined as a <NR1 NUMERIC RESPONSE DATA> element.</p>

:FORMat[:DATA]?

When the data is returned in ASCII, the <Length> is the number of significant digits to be returned. A <Length> value of zero indicates that the device selects the number of significant digits to be returned.

When the data is returned in PACKED <Type>, the <Length> is not used and always returns 0.

Example(s)

FORM? returns ASCII,6

FORM? returns PACKED,0

See Also

FORMat[:DATA]?

:INSTrument:CATalog?

Description	<p>The INSTrument:CATalog? query returns a comma-separated list of <STRING RESPONSE DATA>, which contains the names of all logical instruments and groups. If no logical instruments are defined, a single null <STRING RESPONSE DATA> is returned.</p> <p>This is not affected by a *RST command.</p>
Syntax	:INSTrument:CATalog?
Parameter(s)	None
Response Syntax	<Catalog>
Response(s)	<p><i>Catalog:</i></p> <p>The response data syntax for <Catalog> is defined as a <STRING RESPONSE DATA> element.</p> <p>The list of <STRING PROGRAM DATA> contains the names of all logical instruments and groups.</p>
Example(s)	INST:CAT? returns “FTB-5240 Optical Spectrum Analyzer (1250nm-1650nm),”FTB-5240 Optical Spectrum Analyzer (1250nm-1650nm)”
See Also	INSTrument:CATalog:FULL?

:INSTrument:CATalog:FULL?

Description	<p>The INSTrument:CATalog:FULL? returns a list of <STRING RESPONSE DATA> - <NR1 NUMERIC RESPONSE DATA> pairs. The <STRING RESPONSE DATA> contains the name of the logical instrument. The immediately following <NR1 NUMERIC RESPONSE DATA> formatted number is its associated logical instrument number. All response data elements are separated by commas. If no logical instrument is defined, a null <STRING RESPONSE DATA> value followed by a zero is returned.</p> <p>This is not affected by a *RST command.</p>
Syntax	:INSTrument:CATalog:FULL?
Parameter(s)	None
Response Syntax	<Catalog>
Response(s)	<p><i>Catalog:</i></p> <p>The response data syntax for <Catalog> is defined as a <STRING RESPONSE DATA> element.</p> <p>The list of <STRING RESPONSE DATA> contains the names of all logical instruments and groups. The immediately following <NR1 NUMERIC RESPONSE DATA> formatted number is its associated logical instrument number.</p>
Example(s)	<p>INST:CAT:FULL? returns "FTB-5240 Optical Spectrum Analyzer (1250nm-1650nm)",1,"FTB-5240 Optical Spectrum Analyzer (1250nm-1650nm)",3</p>
See Also	INSTrument:CATalog?.

:SYSTem:DATE

Description	<p>The SYSTem:DATE command is used to set the device's internal calendar.</p> <p>This is not affected by a *RST command.</p>
Syntax	:SYSTem:DATE<wsp><Year>,<Month>,<Day> >
Parameter(s)	<p>➤ <i>Year:</i></p> <p>The program data syntax for <Year> is defined as a <DECIMAL NUMERIC PROGRAM DATA> element.</p> <p>The <Year> is rounded to the nearest integer. Its range is limited by the capability of the device. The year shall be entered as a four-digit number, including century and millennium information.</p> <p>➤ <i>Month:</i></p> <p>The program data syntax for <Month> is defined as a <DECIMAL NUMERIC PROGRAM DATA> element.</p> <p>The <Month> is rounded to the nearest integer. Its range is 1 to 12 inclusive. The number 1 corresponds to January, 2 to February, and so on.</p>

:SYSTem:DATE

➤ *Day:*

The program data syntax for <Day> is defined as a <DECIMAL NUMERIC PROGRAM DATA> element.

The <Day> is rounded to the nearest integer. It ranges from 1 to the number of days in the month from the previous parameter. This command keeps track of the number of days in each month, accounting for leap years through the range of years that it accepts.

Example(s)

SYST:DATE 2001,11,29

See Also

SYSTem:DATE?

:SYSTem:DATE?

Description	The SYSTem:DATE query returns the instrument's internal calendar. This is not affected by a *RST command.
Syntax	:SYSTem:DATE?
Parameter(s)	None
Response Syntax	<Year>,<Month>,<Day>

:SYSTem:DATE?

Response(s)

► *Year:*

The response data syntax for <Year> is defined as a <NR1 NUMERIC RESPONSE DATA> element.

The <Year> is a four-digit number, including century and millennium information.

► *Month:*

The response data syntax for <Month> is defined as a <NR1 NUMERIC RESPONSE DATA> element.

The <Month> ranges from 1 to 12, inclusively. The number 1 corresponds to January, 2 to February, and so on.

► *Day:*

The response data syntax for <Day> is defined as a <NR1 NUMERIC RESPONSE DATA> element.

The <Day> ranges from 1 to the number of days in the month from the previous field. This command keeps track of the number of days in each month, accounting for leap years through the range of years that it accepts.

Example(s)

SYST:DATE? returns 2001,11,29

See Also

SYSTem:DATE

:SYSTem:ERRor[:NEXT]?

Description	<p>The SYSTem:ERRor[:NEXT]? queries the error/event queue for the next item and removes it from the queue. The response message consists of two fields separated by commas <Code>,<Description[,Info]>.</p> <p>SYSTem:ERRor[:NEXT]? is a query only and, therefore, does not have an associated *RST state.</p>
Syntax	:SYSTem:ERRor[:NEXT]?
Parameter(s)	None
Response Syntax	<Code>,<Description[,Info]>
Response(s)	<p>► <i>Code:</i></p> <p>The response data syntax for <Code> is defined as a <NR1 NUMERIC RESPONSE DATA> element.</p> <p>The <Code> is a unique integer in the range [-32768, 32767]. All positive numbers are instrument-dependent. All negative numbers are reserved by the SCPI standard with certain standard error/event codes described in an appendix of this document. The zero value is also used to indicate that no error or event has occurred.</p> <p>► <i>Description[,Info]:</i></p> <p>The response data syntax for <Description[,Info]> is defined as a <STRING RESPONSE DATA> element.</p>

:SYSTem:ERRor[:NEXT]?

The <Description[,Info]> parameter of the full response is a quoted string containing a description followed by information text [,Info]. Each <Code> has a unique and fixed <Description> associated with it. The <Date> and <Time> are appended to the [,info] separated by a semi-colon using the following format:

<Date><wsp><Time> where

<Date> = Year/Month/Day

<Time> = Hour,Minute,Second (24 hour time)

The maximum length of <Description[,Info]> is 255 characters. For standard defined error/event <Codes>, the <Description> is sent exactly as indicated in the appendix of this document.

Example(s)

SYST:ERR:NEXT? returns -222,"Data out of range"
SYST:ERR:NEXT? returns -222,"Data out of range,instrument monomodule 5240, 2001/11/29 14:56:16.259"

:SYSTem:TIME

Description	<p>This device has an internal clock and implements the SYSTem:TIME command to set the clock time over the interface.</p> <p>This is not affected by a *RST command.</p>
Syntax	:SYSTem:TIME<wsp><Hour>,<Minute>,<Seconds>
Parameter(s)	<p>➤ <i>Hour:</i></p> <p>The program data syntax for <Hour> is defined as a <DECIMAL NUMERIC PROGRAM DATA> element.</p> <p>The <Hour> is always rounded to the nearest integer. It ranges from 0 to 23 inclusively. The device accepts hour information in 24-hour format.</p> <p>➤ <i>Minute:</i></p> <p>The program data syntax for <Minute> is defined as a <DECIMAL NUMERIC PROGRAM DATA> element.</p> <p>The <Minute> is always rounded to the nearest integer. It ranges from 0 to 59 inclusively.</p>

:SYSTem:TIME

➤ *Seconds:*

The program data syntax for <Seconds> is defined as a <DECIMAL NUMERIC PROGRAM DATA> element.

The <Second> is rounded to the resolution of the clock. It ranges from 0 to 60. A value of 60 is allowed since rounding may cause a number greater than 59.5 to be rounded to 60. When this element is rounded to 60 it shall be set to 0 and the minute value incremented. Any other carries shall be rippled through the date.

Example(s)

SYST:TIME 12,47,29

See Also

SYSTem:TIME?

:SYSTem:TIME?

Description	This device has an internal clock and implements the SYSTem:DATE? query to get the clock time over the interface. This is not affected by a *RST command.
Syntax	:SYSTem:TIME?
Parameter(s)	None
Response Syntax	<Hour>,<Minute>,<Second>

:SYSTem:TIME?

Response(s)

► *Hour:*

The response data syntax for <Hour> is defined as a <NR1 NUMERIC RESPONSE DATA> element.

The <Hour> ranges from 0 to 23. The instruments returns hour information in 24-hour format.

► *Minute:*

The response data syntax for <Minute> is defined as a <NR1 NUMERIC RESPONSE DATA> element.

The <Minute> ranges from 0 to 59.

► *Second:*

The response data syntax for <Second> is defined as a <NR1 NUMERIC RESPONSE DATA> element.

The <Second> ranges from 0 to 59. The resolution of the clock is the second.

Example(s)

SYST:TIME? returns 16,55,38

See Also

SYSTem:TIME

:SYSTem:VERSion?

Description	<p>The SYSTem:VERSion? query returns a value corresponding to the SCPI version number to which the device complies.</p> <p>The SYSTem:VERSion? is a query only and, therefore, does not have an associated *RST state.</p>
Syntax	:SYSTem:VERSion?
Parameter(s)	None
Response Syntax	<Version>
Response(s)	<p><i>Version:</i></p> <p>The response data syntax for <Version> is defined as a <NR2 NUMERIC RESPONSE DATA> element.</p> <p>The <Version> is shown in the form Year.Revision, where Year represents the year-version (that is 1990) and Revision represents an approved revision number for that year. If no approved revisions are claimed, then this extension is 0.</p>
Example(s)	SYSTem:VERSion? returns 1999.0 (no approved revisions are claimed)

C SCPI-Based Errors

Error Number	Description	Probable Cause
-100	“Command error”	This is the generic syntax error for devices that cannot detect more specific errors. This code indicates only that a Command Error as defined in IEEE 488.2, 11.5.1.1.4 has occurred.
-101	“Invalid character”	A syntactic element contains a character which is invalid for that type; for example, a header containing an ampersand, SETUP&. This error might be used in place of errors -114, -121, -141, and perhaps some others.
-102	“Syntax error”	An unrecognized command or data type was encountered; for example, a string was received when the device does not accept strings.
-103	“Invalid separator”	The parser was expecting a separator and encountered an illegal character; for example, the semicolon was omitted after a program message unit, *EMC 1:CH1:VOLTS 5.
-104	“Data type error”	The parser recognized a data element different than one allowed; for example, numeric or string data was expected but block data was encountered.
-105	“GET not allowed”	A Group Execute Trigger was received within a program message (see IEEE 488.2, 7.7).
-108	“Parameter not allowed”	More parameters were received than expected for the header; for example, the *EMC common command only accepts one parameter, so receiving *EMC 0,1 is not allowed.
-109	“Missing parameter”	Fewer parameters were received than required for the header; for example, the *EMC common command requires one parameter, so receiving *EMC is not allowed.

SCPI-Based Errors

Error Number	Description	Probable Cause
-110	“Command header error”	An error was detected in the header. This error message should be used when the device cannot detect the more specific errors described for errors -111 through -119.
-111	“Header separator error”	A character which is not a legal header separator was encountered while parsing the header; for example, no white space followed the header, thus *GMC"MACRO" is an error.
-112	“Program mnemonic too long”	The header contains more than twelve characters (see IEEE 488.2, 7.6.1.4.1).
-113	“Undefined header”	The header is syntactically correct, but it is undefined for this specific device; for example, *XYZ is not defined for any device.
-114	“Header suffix out of range”	The value of a numeric suffix attached to a program mnemonic (see IEEE 488.2, Syntax and Style section 6.2.5.2) makes the header invalid.
-115	“Unexpected number of parameters”	The number of parameters received does not correspond to the number of parameters expected. This is typically due to an inconsistency with the number of instruments in the selected group (see section on INSTRUMENT:DEFine:GROup).
-120	“Numeric data error”	This error, as well as errors -121 through -129, are generated when parsing a data element which appears to be numeric, including the non-decimal numeric types. This particular error message should be used if the device cannot detect a more specific error.
-121	“Invalid character in number”	An invalid character for the data type being parsed was encountered; for example, an alpha in a decimal numeric or a "9" in octal data.

Error Number	Description	Probable Cause
-123	“Exponent too large”	The magnitude of the exponent was larger than 32000 (see IEEE 488.2, 7.7.2.4.1).
-124	“Too many digits”	The mantissa of a decimal numeric data element contained more than 255 digits excluding leading zeros (see IEEE 488.2, 7.7.2.4.1).
-128	“Numeric data not allowed”	A legal numeric data element was received, but the device does not accept one in this position for the header.
-130	“Suffix error”	This error, as well as errors -131 through -139, are generated when parsing a suffix. This particular error message should be used if the device cannot detect a more specific error.
-131	“Invalid suffix”	The suffix does not follow the syntax described in IEEE 488.2, 7.7.3.2, or the suffix is inappropriate for this device.
-134	“Suffix too long”	The suffix contained more than 12 characters (see IEEE 488.2, 7.7.3.4).
-138	“Suffix not allowed”	A suffix was encountered after a numeric element which does not allow suffixes.
-140	“Character data error”	This error, as well as errors -141 through -149, are generated when parsing a character data element. This particular error message should be used if the device cannot detect a more specific error.
-141	“Invalid character data”	Either the character data element contains an invalid character or the particular element received is not valid for the header.
-144	“Character data too long”	The character data element contains more than twelve characters (see IEEE 488.2, 7.7.1.4).
-148	“Character data not allowed”	A legal character data element was encountered where prohibited by the device.

SCPI-Based Errors

Error Number	Description	Probable Cause
-150	“String data error”	This error, as well as errors -151 through -159, are generated when parsing a string data element. This particular error message should be used if the device cannot detect a more specific error.
-151	“Invalid string data”	A string data element was expected, but was invalid for some reason (see IEEE 488.2, 7.7.5.2); for example, an END message was received before the terminal quote character.
-158	“String data not allowed”	A string data element was encountered but was not allowed by the device at this point in parsing.
-160	“Block data error”	This error, as well as errors -161 through -169, are generated when parsing a block data element. This particular error message should be used if the device cannot detect a more specific error.
-161	“Invalid block data”	A block data element was expected, but was invalid for some reason (see IEEE 488.2, 7.7.6.2); for example, an END message was received before the length was satisfied.
-168	“Block data not allowed”	A legal block data element was encountered but was not allowed by the device at this point in parsing.
-170	“Expression error”	This error, as well as errors -171 through -179, are generated when parsing an expression data element. This particular error message should be used if the device cannot detect a more specific error.
-171	“Invalid expression”	The expression data element was invalid (see IEEE 488.2, 7.7.7.2); for example, unmatched parentheses or an illegal character.
-178	“Expression data not allowed”	A legal expression data was encountered but was not allowed by the device at this point in parsing.

Error Number	Description	Probable Cause
-180	"Macro error"	This error, as well as errors -181 through -189, are generated when defining a macro or executing a macro. This particular error message should be used if the device cannot detect a more specific error.
-181	"Invalid outside macro definition"	Indicates that a macro parameter placeholder ($\$<number>$) was encountered outside of a macro definition.
-183	"Invalid inside macro definition"	Indicates that the program message unit sequence, sent with a *DDT or *DMC command, is syntactically invalid (see IEEE 488.2, 10.7.6.3).
-184	"Macro parameter error"	Indicates that a command inside the macro definition had the wrong number or type of parameters.
-200	"Execution error"	This is the generic syntax error for devices that cannot detect more specific errors. This code indicates only that an Execution Error as defined in IEEE 488.2, 11.5.1.1.5 has occurred.
-201	"Invalid while in local"	Indicates that a command is not executable while the device is in local due to a hard local control (see IEEE 488.2, 5.6.1.5); for example, a device with a rotary switch receives a message which would change the switches state, but the device is in local so the message can not be executed.
-202	"Settings lost due to rtl"	Indicates that a setting associated with a hard local control (see IEEE 488.2, 5.6.1.5) was lost when the device changed to LOCS from REMS or to LWLS from RWLS.
-203	"Command protected"	Indicates that a legal password-protected program command or query could not be executed because the command was disabled.

SCPI-Based Errors

Error Number	Description	Probable Cause
-210	“Trigger error”	-----
-211	“Trigger ignored”	Indicates that a GET, *TRG, or triggering signal was received and recognized by the device but was ignored because of device timing considerations; for example, the device was not ready to respond. Note: a DT0 device always ignores GET and treats *TRG as a Command Error.
-212	“Arm ignored”	Indicates that an arming signal was received and recognized by the device but was ignored.
-213	“Init ignored”	Indicates that a request for a measurement initiation was ignored as another measurement was already in progress.
-214	“Trigger deadlock”	Indicates that the trigger source for the initiation of a measurement is set to GET and subsequent measurement query is received. The measurement cannot be started until a GET is received, but the GET would cause an INTERRUPTED error.
-215	“Arm deadlock”	Indicates that the arm source for the initiation of a measurement is set to GET and subsequent measurement query is received. The measurement cannot be started until a GET is received, but the GET would cause an INTERRUPTED error.
-220	“Parameter error”	Indicates that a program data element related error occurred. This error message should be used when the device cannot detect the more specific errors described for errors -221 through -229.
-221	“Settings conflict”	Indicates that a legal program data element was parsed but could not be executed due to the current device state (see IEEE 488.2, 6.4.5.3 and 11.5.1.1.5).

Error Number	Description	Probable Cause
-222	"Data out of range"	Indicates that a legal program data element was parsed but could not be executed because the interpreted value was outside the legal range as defined by the device (see IEEE 488.2, 11.5.1.1.5).
-223	"Too much data"	Indicates that a legal program data element of block, expression, or string type was received that contained more data than the device could handle due to memory or related device-specific requirements.
-224	"Illegal parameter value"	Used where exact value, from a list of possible, was expected.
-225	"Out of memory"	The device has insufficient memory to perform the requested operation.
-226	"Lists not same length"	Attempted to use LIST structure having individual LIST's of unequal lengths.
-230	"Data corrupt or stale"	Possibly invalid data; new reading started but not completed since last access.
-231	"Data questionable"	Indicates that measurement accuracy is suspect.
-232	"Invalid format"	Indicates that a legal program data element was parsed but could not be executed because the data format or structure is inappropriate. For example when loading memory tables or when sending a SYSTem:SET parameter from an unknown instrument.

SCPI-Based Errors

Error Number	Description	Probable Cause
-233	“Invalid version”	Indicates that a legal program data element was parsed but could not be executed because the version of the data is incorrect to the device. This particular error should be used when file or block data formats are recognized by the instrument but cannot be executed for reasons of version incompatibility. For example, a not supported file version, a not supported instrument version
-240	“Hardware error”	Indicates that a legal program command or query could not be executed because of a hardware problem in the device. Definition of what constitutes a hardware problem is completely device-specific. This error message should be used when the device cannot detect the more specific errors described for errors -241 through -249.
-241	“Hardware missing”	Indicates that a legal program command or query could not be executed because of missing device hardware; for example, an option was not installed. Definition of what constitutes missing hardware is completely device-specific.
-250	“Mass storage error”	Indicates that a mass storage error occurred. This error message should be used when the device cannot detect the more specific errors described for errors -251 through -259.
-251	“Missing mass storage”	Indicates that a legal program command or query could not be executed because of missing mass storage; for example, an option that was not installed. Definition of what constitutes missing mass storage is device-specific.
-252	“Missing media”	Indicates that a legal program command or query could not be executed because of a missing media; for example, no disk. The definition of what constitutes missing media is device-specific.

Error Number	Description	Probable Cause
-253	"Corrupt media"	Indicates that a legal program command or query could not be executed because of corrupt media; for example, bad disk or wrong format. The definition of what constitutes corrupt media is device-specific.
-254	"Media full"	Indicates that a legal program command or query could not be executed because the media was full; for example, there is no room on the disk. The definition of what constitutes a full media is device-specific.
-255	"Directory full"	Indicates that a legal program command or query could not be executed because the media directory was full. The definition of what constitutes a full media directory is device-specific.
-256	"File name not found"	Indicates that a legal program command or query could not be executed because the file name on the device media was not found; for example, an attempt was made to read or copy a nonexistent file. The definition of what constitutes a file not being found is device-specific.
-257	"File name error"	Indicates that a legal program command or query could not be executed because the file name on the device media was in error; for example, an attempt was made to copy to a duplicate file name. The definition of what constitutes a file name error is device-specific.
-258	"Media protected"	Indicates that a legal program command or query could not be executed because the media was protected; for example, the write-protect tab on a disk was present. The definition of what constitutes protected media is device-specific.

SCPI-Based Errors

Error Number	Description	Probable Cause
-260	“Expression error”	[Indicates that a expression program data element related error occurred. This error message should be used when the device cannot detect the more specific errors described for errors -261 through -269.]
-261	“Math error in expression”	[Indicates that a syntactically legal expression program data element could not be executed due to a math error; for example, a divide-by-zero was attempted. The definition of math error is device-specific.]
-270	“Macro error”	[Indicates that a macro-related execution error occurred. This error message should be used when the device cannot detect the more specific errors described for errors -271 through -279.]
-271	“Macro syntax error”	[Indicates that a syntactically legal macro program data sequence, according to IEEE 488.2, 10.7.2, could not be executed due to a syntax error within the macro definition (see IEEE 488.2, 10.7.6.3).]
-272	“Macro execution error”	[Indicates that a syntactically legal macro program data sequence could not be executed due to some error in the macro definition (see IEEE 488.2, 10.7.6.3).]
-273	“Illegal macro label”	[Indicates that the macro label defined in the *DMC command was a legal string syntax, but could not be accepted by the device (see IEEE 488.2, 10.7.3 and 10.7.6.2); for example, the label was too long, the same as a common command header, or contained invalid header syntax.]
-274	“Macro parameter error”	[Indicates that the macro definition improperly used a macro parameter placeholder (see IEEE 488.2, 10.7.3).]

Error Number	Description	Probable Cause
-275	“Macro definition too long”	[Indicates that a syntactically legal macro program data sequence could not be executed because the string or block contents were too long for the device to handle (see IEEE 488.2, 10.7.6.1).]
-276	“Macro recursion error”	[Indicates that a syntactically legal macro program data sequence could not be executed because the device found it to be recursive (see IEEE 488.2, 10.7.6.6).]
-277	“Macro redefinition not allowed”	[Indicates that a syntactically legal macro label in the *DMC command could not be executed because the macro label was already defined (see IEEE 488.2, 10.7.6.4).]
-278	“Macro header not found”	[Indicates that a syntactically legal macro label in the *GMC? query could not be executed because the header was not previously defined.]
-280	“Program error”	[Indicates that a downloaded program-related execution error occurred. This error message should be used when the device cannot detect the more specific errors described for errors -281 through -289. A downloaded program is used to add algorithmic capability to a device. The syntax used in the program and the mechanism for downloading a program is device-specific.]
-281	“Cannot create program”	[Indicates that an attempt to create a program was unsuccessful. A reason for the failure might include not enough memory.]
-282	“”Illegal program name	[The name used to reference a program was invalid; for example, redefining an existing program, deleting a nonexistent program, or in general, referencing a nonexistent program.]
-283	“Illegal variable name”	[An attempt was made to reference a nonexistent variable in a program.]

SCPI-Based Errors

Error Number	Description	Probable Cause
-284	“Program currently running”	[Certain operations dealing with programs may be illegal while the program is running; for example, deleting a running program might not be possible.]
-285	“Program syntax error”	[Indicates that a syntax error appears in a downloaded program. The syntax used when parsing the downloaded program is device-specific.]
-286	“Program runtime error”	-----
-290	“Memory use error”	[Indicates that a user request has directly or indirectly caused an error related to memory or <data_handle>, this is not the same as “bad” memory.]
-291	“Out of memory”	-----
-292	“Referenced name does not exist”	-----
-293	“Referenced name already exist”	-----
-294	“Incompatible type”	[Indicates that the type or structure of a memory item is inadequate]
-300	“Device-specific error”	[This is the generic device-dependent error for devices that cannot detect more specific errors. This code indicates only that a Device-Dependent Error as defined in IEEE 488.2, 11.5.1.1.6 has occurred.]
-310	“System error”	[Indicates that some error, termed "system error" by the device, has occurred. This code is device-dependent.]
-311	“Memory error”	[Indicates some physical fault in the device's memory, such as parity error.]

Error Number	Description	Probable Cause
-312	“PUD memory lost”	[Indicates that the protected user data saved by the *PUD command has been lost.]
-313	“Calibration memory lost”	[Indicates that nonvolatile calibration data used by the *CAL? command has been lost.]
-314	“Save/Recall memory lost”	[Indicates that the nonvolatile data saved by the *SAV? command has been lost.]
-315	“Configuration memory lost”	[Indicates that nonvolatile configuration data saved by the device has been lost. The meaning of this error is device-specific.]
-320	“Storage fault”	[Indicates that the firmware detected a fault when using data storage. This error is not an indication of physical damage or failure of any mass storage element.]
-321	“Out of memory”	[An internal operation needed more memory than was available.]
-330	“Self-test failed”	-----
-340	“Calibration failed”	-----
-350	“Queue overflow”	[A specific code entered into the queue in lieu of the code that caused the error. This code indicates that there is no room in the queue and an error occurred but was not recorded.]
-360	“Communication error”	[This is the generic communication error for devices that cannot detect the more specific errors described for errors -361 through -363.]
-361	“Parity error in program message”	[Parity bit not correct when data received for example, on a serial port.]
-362	“Framing error in program message”	[A stop bit was not detected when data was received for example, on a serial port (for example, a baud rate mismatch).]

SCPI-Based Errors

Error Number	Description	Probable Cause
-363	“Input buffer overrun”	[Software or hardware input buffer on serial port overflows with data caused by improper or nonexistent pacing.]
-365	“Time out error”	[This is a generic device-dependent error.]
-400	“Query error”	[This is the generic query error for devices that cannot detect more specific errors. This code indicates only that a Query Error as defined in IEEE 488.2, 11.5.1.1.7 and 6.3 has occurred.]
-410	“Query INTERRUPTED”	[Indicates that a condition causing an INTERRUPTED Query error occurred (see IEEE 488.2, 6.3.2.3); for example, a query followed by DAB or GET before a response was completely sent.]
-420	“Query UNTERMINATED”	[Indicates that a condition causing an UNTERMINATED Query error occurred (see IEEE 488.2, 6.3.2.2); for example, the device was addressed to talk and an incomplete program message was received.]
-430	“Query DEADLOCKED”	[Indicates that a condition causing an DEADLOCKED Query error occurred (see IEEE 488.2, 6.3.1.7); for example, both input buffer and output buffer are full and the device cannot continue.]
-440	“Query UNTERMINATED after indefinite response”	[Indicates that a query was received in the same program message after an query requesting an indefinite response was executed (see IEEE 488.2, 6.5.7.5).]
-500	“Power on”	[The instrument has detected an off to on transition in its power supply.]
-600	“User request”	[The instrument has detected the activation of a user request local control.]

Error Number	Description	Probable Cause
-700	"Request control"	[The instrument requested to become the active IEEE 488.1 controller-in-charge.]
-800	"Operation complete"	[The instrument has completed all selected pending operations in accordance with the IEEE 488.2, 12.5.2 synchronization protocol.]

D *COM Properties and Events*

The FTB-500 also provides objects based on Microsoft Component Object Model (COM). COM defines a common way to access and create software components and services.

COM promotes the integration and the reuse of software components, as well as interoperability. In order to interoperate, components developed in different languages must adhere to a binary structure specified by Microsoft.

OLE and ActiveX are based on COM. Also, programming languages such as C, C++, Smalltalk, Pascal, Ada, Java, and LabVIEW can create and use COM components.

You can build your own programs using the provided properties and events via the IcSCPIAccess interface (available on your unit). For information on how to configure your FTB-500 for DCOM control, see *Configuring DCOM Access to Your Unit* on page 199.

ActiveX (COM/DCOM)—Quick Reference

The following diagram illustrates the different properties and events available.

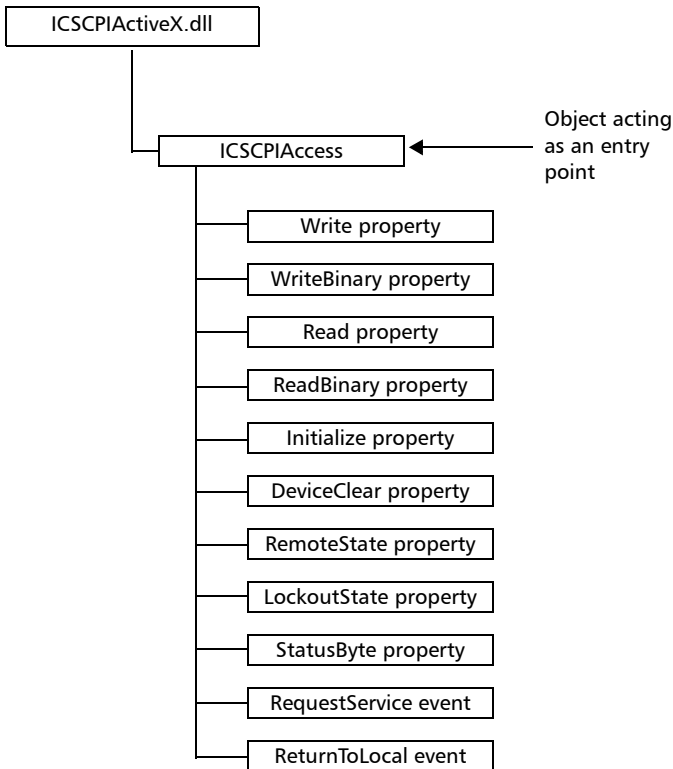

These properties and events are fully explained in the following pages.

Properties

Write

Description	With this method you can send a program message (single command or compound of commands) to the device input buffer.
Syntax	object. <i>Write</i> (<i>Message</i>)
Parameter(s)	<i>Message</i> : Required. A string value corresponding to the program message to be sent.
Possible error(s)	<i>Timeout</i> : This error will occur if the operation could not be completed within the allowed delay. For information on timeout setting, see <i>Initialize</i> on page 403.

WriteBinary

Description	With this method you can send a program message (single command or compound of commands) as an array of bytes into the device input buffer.
Syntax	<code>object.Write (BinaryArray)</code>
Parameter(s)	<i>BinaryArray</i> : Required. An array of bytes corresponding to the program message to be sent.
Notes	Use this method instead of the <i>Write</i> method if you need to send commands in binary (COM is UNICODE).
Possible error(s)	<i>Timeout</i> : This error will occur if the operation could not be completed within the allowed delay. For information on timeout setting, see <i>Initialize</i> on page 403.



IMPORTANT

Before you retrieve data with the *Read* or *ReadBinary* methods, you must specify the format in which the information must be returned. Details on how to correctly set the format can be found below.

Read

Description	With this method you can retrieve all the data from the device output queue in a UNICODE format.
Syntax	<code>object.Read</code>
Parameter(s)	None.
Response(s)	A string value (in UNICODE format).
Notes	<p>This method must be used in conjunction with the <i>Write</i> method. Always ensure that a query has been previously sent before attempting to read a response from the output queue.</p> <p>To properly set the data format, send the following command (using the <i>Write</i> method): FORM:DATA<wsp>ASCII <number_of_digits> where <number_of_digits> corresponds to the number of digits after the decimal point that you require.</p> <p>Remember that the retrieved data will have to be converted to a numeric format before you can use it in calculations, for example.</p>
Possible error(s)	<p><i>Timeout</i>: This error will occur if the allowed delay has expired before the preceding <i>Write</i> operation could send a response to the output queue. For information on timeout setting, see <i>Initialize</i> on page 403.</p> <p><i>QueryUnterminated</i>: This error will occur if the output queue is empty (for example, no query has been made previously).</p>

ReadBinary

Description	With this method you can retrieve data from the device output queue in a binary format.
Syntax	<code>object.ReadBinary</code>
Parameter(s)	None.
Response(s)	An array of bytes.
Notes	<p>This method must be used in conjunction with the <i>Write</i> method. Always ensure that a query has been previously sent before attempting to read a response from the output queue.</p> <p>To properly set the data format, send the following command (using the <i>Write</i> method): FORM:DATA<wsp>PACKED</p> <p>The retrieved data <i>does not</i> need to be converted to a numeric format before you can use it in calculations, for example.</p> <p>To help you know the actual length of the retrieved data, it has the following structure:</p> <ul style="list-style-type: none">➤ The first byte contains the # character.➤ The byte that immediately follows contains the number of subsequent bytes that you have to check to know the total length.

ReadBinary

For example, if you receive this response (here, values are expressed in decimal instead of binary for easier readability):

```
# 2 1 3 7 5 8 9 2 ...
```

The byte that immediately follows the # contains 2, which means that you have to read the two following bytes to know the length (in bytes) of the retrieved data. The bytes indicate 1 and 3. The length will then be 13 bytes. The actual response will begin at byte number 5, in this case.

Possible error(s)

Timeout: This error will occur if the allowed delay has expired before the preceding *Write* operation could send a response to the output queue. For information on timeout setting, see *Initialize* on page 403.

QueryUnterminated: This error will occur if the output queue is empty (for example, no query has been made previously).

Initialize

Description

With this method you can configure the timeout value that is, the allowed delay for Read and Write operations, in milliseconds.

Syntax

```
object.Initialize(Timeout)
```

Parameter(s)

Timeout: Required. A numeric value corresponding to the delay in milliseconds.

Notes

If the *Initialize* method is not invoked, the default value is 10 000 milliseconds.

COM Properties and Events

Properties

DeviceClear	
Description	This method performs a <i>Device Clear</i> operation as specified in the IEEE 488.1 standard.
Syntax	<code>object.DeviceClear</code>
Parameter(s)	None.

RemoteState	
Description	This property returns or sets the device's remote state.
Syntax	<code>object.RemoteState</code> (to retrieve the state) <code>object.RemoteState=State</code> (to set the state) <i>State</i> : a Boolean value corresponding to: True: Remote False: Local
Parameter(s)	None.
Response(s)	If the property is used to get the device's remote state, the property will return a Boolean value.
Access	Get/Set

LockoutState

Description	This property returns or sets the device's lockout state.
Syntax	<p>object.<i>LockoutState</i> (to retrieve the state)</p> <p>object.<i>LockoutState</i>=<i>State</i> (to set the state)</p> <p><i>State</i>: a Boolean value corresponding to:</p> <p style="padding-left: 40px;">True: Lockout</p> <p style="padding-left: 40px;">False: No lockout</p>
Parameter(s)	None.
Response(s)	If the property is used to get the device's lockout state, the property will return a Boolean value.
Access	Get/Set

StatusByte

Description	This read-only property returns the device's status byte. Refer to IEEE 488.2 standard for status byte description.
Syntax	object. <i>StatusByte</i>
Parameter(s)	None.
Response(s)	A value corresponding to the device's status byte.
Notes	This property can be used in conjunction with <i>RequestService</i> event (see <i>RequestService</i> on page 406) to find out why the device caused a Service Request (SRQ).
Access	Get

Events

RequestService	
Description	This event is triggered whenever the device causes a Service Request (SRQ).
Parameter(s)	None.
Notes	<p>It is the user's responsibility to configure the different registers (*SRE, *ESE) as stated in the IEEE 488.2 standard to receive SRQ.</p> <p>When used in conjunction with <i>StatusByte</i> property (see <i>StatusByte</i> on page 405), this event allows you to determine the cause of the SRQ.</p>

ReturnToLocal	
Description	This event is triggered when the user presses the Local button from the controller's front panel when the device is in Remote state.
Parameter(s)	None.

E **Communicating Through TCP/IP over Telnet**

Introducing TCP/IP over Telnet

The EXFO Instrument Control provides SCPI automation or remote control over Telnet through TCP/IP as a Windows Service that continuously listens to a port from a Telnet server (FTB/IQS/LTB) on which modules to be tested are connected.

TCP/IP protocols are used for communication.

Note: *Port 5024 is designated for sending SCPI commands in the Telnet protocol.*

All Windows versions include the Telnet client and the Telnet server components. With these components, you can create a remote command console session on a remote computer.

Commands can be executed simply by logging on the server using the Telnet interface.

There are two types of commands that can be sent over Telnet: SCPI commands and internal protocol commands of the TCP/IP over Telnet service. The internal commands allow you to perform certain actions such as send SCPI commands as a script instead of one by one, force the disconnection of an active session, view the status of modules and of connected clients, etc.

Features

- A client from any operating system (Windows, Linux, or Unix) can use the freely available Telnet components to connect to the service.
- A client can connect to multiple modules at a time.
- A user can connect to multiple modules through single/multiple sessions.
- A client can execute single commands or a batch of commands.
- A user can disconnect any client/session that is already connected.

Configuring Your Unit and Modules to Work With TCP/IP over Telnet

The TCP/IP over Telnet Service, which is part of the EXFO Instrument Control, is a mediator between the Telnet client and the test instrument.

Once your unit is configured properly, any request from the Telnet client is transferred to the appropriate instrument. The instrument executes the request and returns the response to TCP/IP over Telnet accordingly.



IMPORTANT

If you are working with an FTB-2/ FTB-2 Pro, an LTB-1, or an LTB-8 unit, before being able to control instruments with SCPI commands, you must first allow remote access to these instruments.

To allow remote access to your instruments (FTB-2/FTB-2 Pro, LTB-1, and LTB-8 only):

1. From ToolBox X, tap or click the **System Settings** button.
2. Tap or click **Remote Control Configuration**.

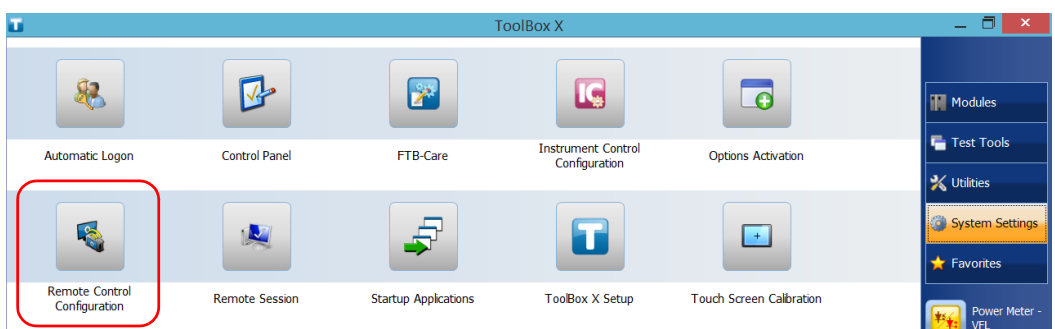

Communicating Through TCP/IP over Telnet

Configuring Your Unit and Modules to Work With TCP/IP over Telnet

3. If necessary, tap or click **Change settings**, and then, when the application prompts you to authorize the changes to your unit (identified as “computer”), select **Yes**.

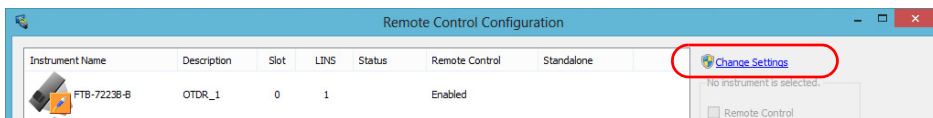

4. From the **Remote Control Configuration** window you will see all the inserted modules. Select the module for which you want to have remote access.

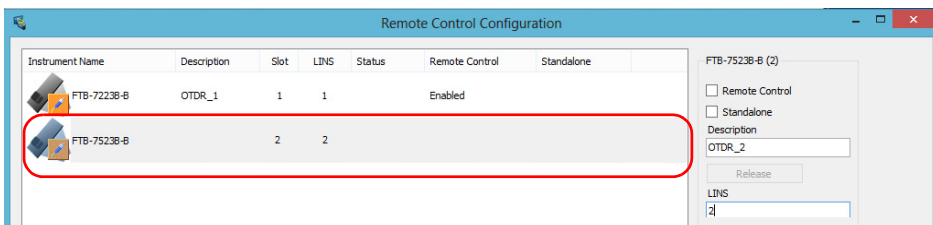

Communicating Through TCP/IP over Telnet

Configuring Your Unit and Modules to Work With TCP/IP over Telnet

5. Set the parameters:
 - Select **Remote Control** to be able to access the module remotely (via TCP/IP over Telnet or other).
 - Select **Standalone** to leave the module active even if all users close their dedicated applications.
6. If desired, under **Description**, type a description that will help you identify the instrument.

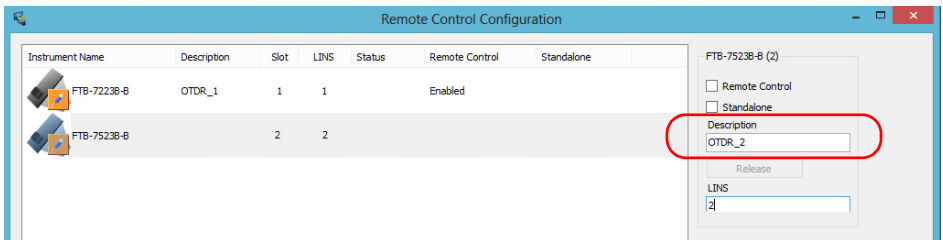

Note: You can enter up to 10 characters. The description can correspond to the test interface ID or to any other short text of your choice.

Communicating Through TCP/IP over Telnet

Configuring Your Unit and Modules to Work With TCP/IP over Telnet

7. If necessary, under **LINS**, modify the logical instrument number that you will use to access the instrument remotely.

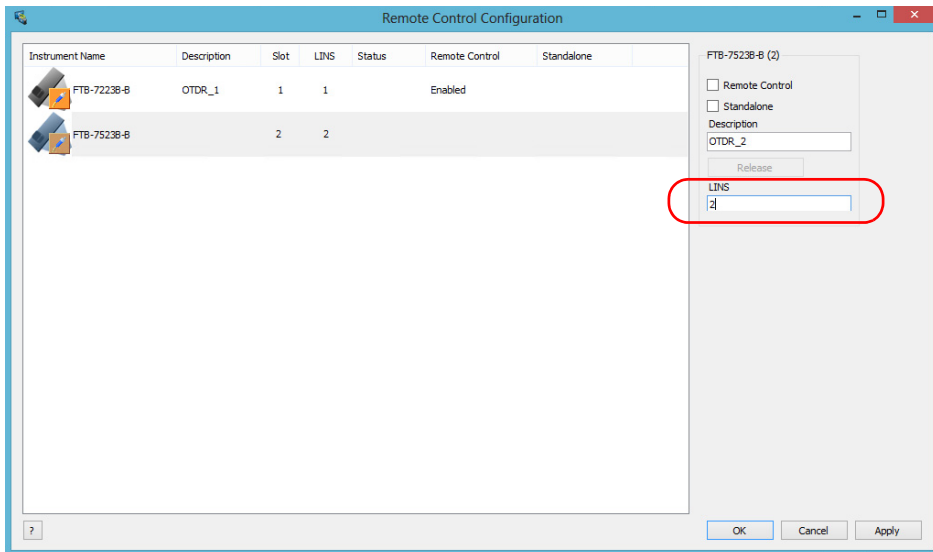

Note: If the **LINS** column is empty, it means that the corresponding module cannot be controlled using SCPI commands.

8. Tap or click **Apply** to confirm your changes or **OK** to apply your changes and close the window.

Note: This information will be updated the next time you start the module application, or set Instrument Control in remote mode. Refer to the corresponding module documentation for more details.

Communicating Through TCP/IP over Telnet

Configuring Your Unit and Modules to Work With TCP/IP over Telnet

To activate TCP/IP over Telnet on your unit:

1. Access the Instrument Control Configuration utility:
 - On an IQS-600: From IQS Manager, click the **Utilities** function tab, and then click **Instrument Control Configuration**.
 - On an FTB-500: From ToolBox, tap the **System Settings** button, then tap **Instrument Control Configuration**.
 - On an FTB-2/FTB-2 Pro, an LTB-1, or an LTB-8: From ToolBox X, tap or click the **System Settings** button, then tap or click **Instrument Control Configuration**.
2. If necessary, tap or click **Change settings**, and then, when the application prompts you to authorize the changes to your unit (identified as “computer”), select **Yes**.

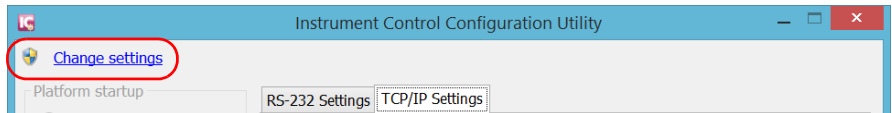

Communicating Through TCP/IP over Telnet

Configuring Your Unit and Modules to Work With TCP/IP over Telnet

3. Under **Platform Startup**, select **Remote**.

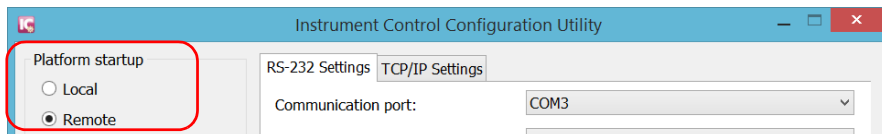

4. Under **Communication Type**, select **TCP/IP**.

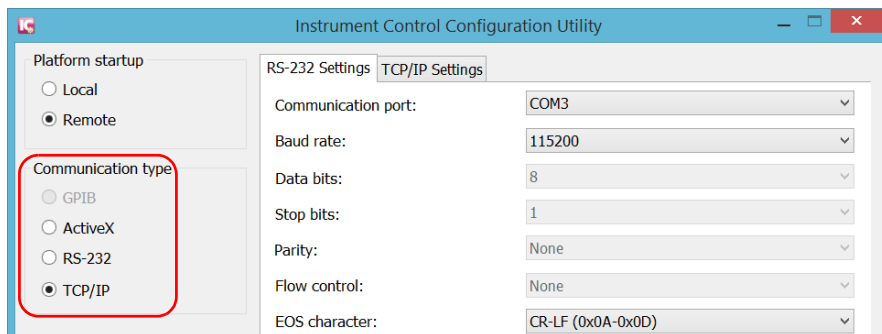

5. Tap or click **Apply**, and then **OK**.
6. Depending on the unit you are using, restart either IQS Manager, ToolBox, or ToolBox X.

Executing SCPI Commands Over Telnet

You can remotely control the modules by executing SCPI commands through TCP/IP over Telnet. The commands are sent remotely from the Telnet client (on a computer) to the Telnet server (in this case, the IQS, FTB, or LTB unit).

To execute a single SCPI command, you can type or paste the command directly in the Telnet editor window.

To execute multiple SCPI commands (script), you must enclose them within a BEGIN and END block in the Telnet editor window.

You can connect from a remote Windows client or a Linux (or Unix) remote client.

Note: *The Telnet client is available on the FTB-500, FTB-2 Pro, LTB-8, and IQS-600 controller if you intend to use these units as computers to connect to a Telnet server. However, on an FTB-2 or an LTB-1, the Telnet client is not available. You must use the PuTTY application to establish communication.*

Communicating Through TCP/IP over Telnet

Executing SCPI Commands Over Telnet

To connect through TCP/IP over Telnet from a remote Windows client:

1. From your computer, start Windows.
2. On the taskbar, click **Start** (Start button () under Windows 8.1 and Windows 10) and select **Run**.
3. In the **Open** box, type *telnet*, and then click **OK**.

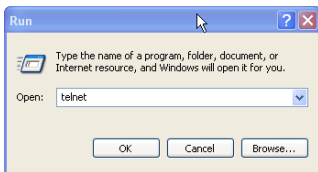

Note: *If you receive an error message, it probably means that the Telnet client is not already activated on your computer. In this case, in the **Open** box, type `pkgmgr /iu:TelnetClient`, and then click **OK** to enable the client. Once it is done, perform step 3 again.*

4. In the displayed Telnet editor window, type the `OPEN <IP_ADDRESS_OF_TELNET_SERVER> <PORT>` command to connect to the TCP/IP Telnet Service.

Example: `open 10.192.2.45 5024`

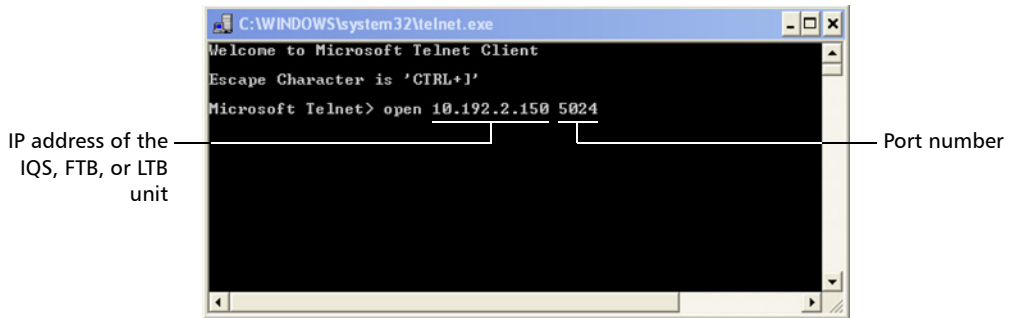

Note: *Port 5024 is designated for sending SCPI commands in the Telnet protocol.*

5. Press ENTER to establish a connection with the Service.

Once the connection is established, the `READY>` prompt is displayed in the Telnet editor window.

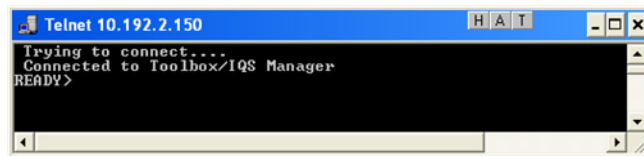

Note: *If the connection cannot be established, the **Connection to host lost** message is displayed instead.*

Communicating Through TCP/IP over Telnet

Executing SCPI Commands Over Telnet

6. Enter the desired SCPI commands as follows:

- For a single SCPI command: Type or copy the desired command in the Telnet editor window, and then press ENTER to execute it.

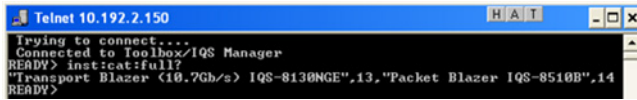

- For multiple SCPI commands: Copy the desired commands from any script file, enclose them in a BEGIN and END block in the Telnet editor window, and then press ENTER. For more information, see *Internal Commands of the TCP/IP over Telnet Protocol* on page 422.

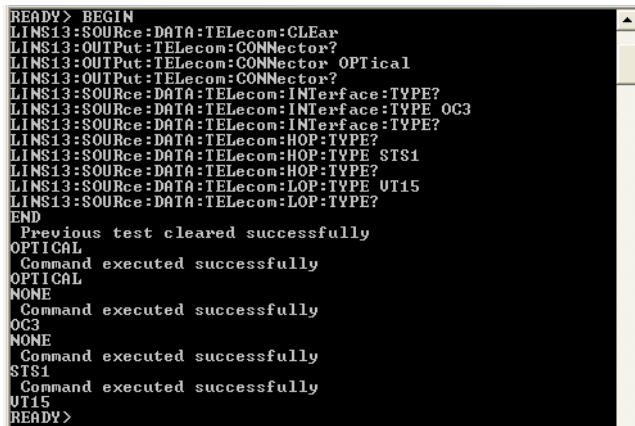

Note: Multiple commands that are not enclosed in BEGIN...END blocks will be executed, but problems may occur (results of one command mixed with the results of another one, skipped commands, etc.).

Once at least one valid command is executed, the module is blocked for any other sessions until the module is released. For more information, see *Releasing Modules* on page 421.

7. Click  to close the session.

To connect through TCP/IP over Telnet from a remote Linux client:

1. From your computer, right-click on the desktop, and then click **Open Terminal**.

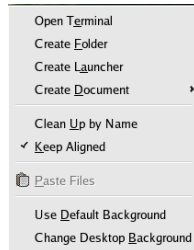

The command prompt is displayed in the Telnet editor window.

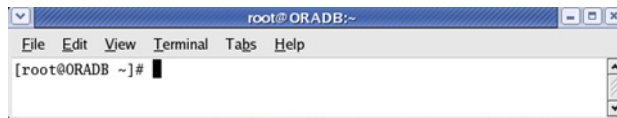

2. Connect to the TCP/IP Telnet Service by typing the `OPEN <IP_ADDRESS_OF_TELNET_SERVER> <PORT>` command:

Example: `open 10.192.2.45 5024`

Note: Port 5024 is designated for sending SCPI commands in the Telnet protocol.

The connection is established when the message **Connected to Toolbox/IQS Manager** is displayed in the Telnet editor window.

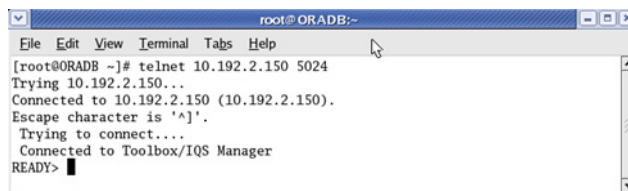

Communicating Through TCP/IP over Telnet

Executing SCPI Commands Over Telnet

3. Enter the desired SCPI commands as follows:
 - For a single SCPI command: Type or copy the desired command in the Telnet editor window, and then press ENTER to execute it.

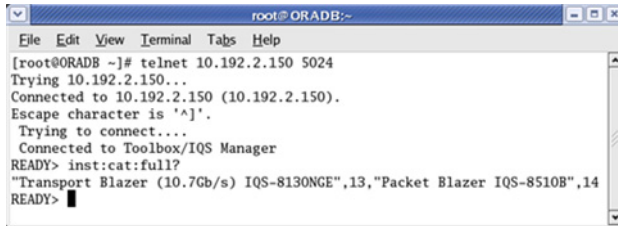

```
root@ORADB:~  
File Edit View Terminal Tabs Help  
[root@ORADB ~]# telnet 10.192.2.150 5024  
Trying 10.192.2.150...  
Connected to 10.192.2.150 (10.192.2.150).  
Escape character is '^'.  
Trying to connect...  
Connected to Toolbox/IQS Manager  
READY> inst:cat:full?  
"Transport Blazer (10.7Gb/s) IQS-8130NGE",13,"Packet Blazer IQS-8510B",14  
READY> █
```

- For multiple SCPI commands: Copy the desired commands from any script file, enclose them in a BEGIN and END block in the Telnet editor window, and then press ENTER. For more information, see *Internal Commands of the TCP/IP over Telnet Protocol* on page 422.

Note: *Multiple commands that are not enclosed in BEGIN...END blocks will be executed, but problems may occur (results of one command mixed with the results of another one, skipped commands, etc.).*

Once at least one valid command is executed, the module is blocked for any other sessions until the module is released. For more information, see *Releasing Modules* on page 421.

4. Click  to close the session.

Releasing Modules

A module is blocked as soon as a connection is established from any user session executing the internal command `CONNECT LINS`, or a valid instrument (SCPI) command.

For example, when the SCPI command `LINS10:SOURce:DATA:TELEcom:CLEAr` command is executed for the first time by client session 10.192.2.155:1364, the module is blocked for any other client/session until you release it.

A module is released by one of the following actions:

- Executing the `CLOSE LINS` command to disconnect the link with the module. For more information, see *CLOSE LINS* on page 426.
- Executing the `CLOSE` command to end the current session once the execution of all the desired commands has been completed. For more information, see *CLOSE* on page 425.
- Closing the current session by clicking the Close button on the Telnet editor windows' title bar.
- Shutting down and restarting the client computer.
- A network interruption.

A module can also be released when you terminate the communication by using the `KILL LINS` command. For more information, see *KILL LINS* on page 428.

Internal Commands of the TCP/IP over Telnet Protocol

The internal commands allow you to perform certain actions such as send SCPI commands as a script instead of one by one, force the disconnection of an active session, view the status of modules and of connected clients, etc. The internal commands are not case-sensitive.

By default, log files are generated both for client and server (all logs are kept on your unit). You can delete them with the CLEAR LOGS command (see *CLEAR LOGS* on page 425), or manually via the file explorer. The client and sever logs are kept respectively in the *C:\ProgramData\EXFO\SCPI Over TCPIP Logs\Client log* and in the *C:\ProgramData\EXFO\SCPI Over TCPIP Logs\Server log* folders.

ABORT BEGIN

Syntax: ABORT BEGIN

The ABORT BEGIN command stops the execution of the SCPI commands that are enclosed in a BEGIN and END block, and returns to the READY> prompt in the Telnet editor window.

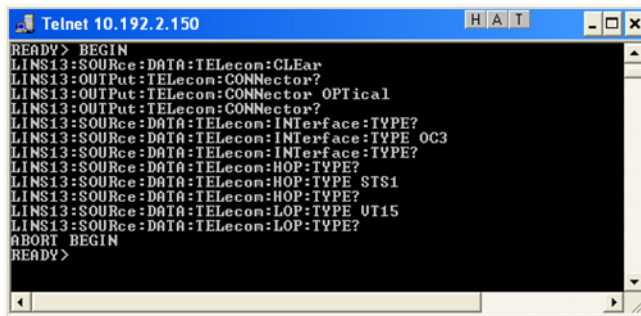

```
Telnet 10.192.2.150  H A T  - _ X
READY> BEGIN
LINS13:SOURce:DATA:TELEcon:CLEar
LINS13:OUTPut:TELEcon:CONNector?
LINS13:OUTPut:TELEcon:CONNector OPTical
LINS13:OUTPut:TELEcon:CONNector?
LINS13:SOURce:DATA:TELEcon:INTerFace:TYPE?
LINS13:SOURce:DATA:TELEcon:INTerFace:TYPE OC3
LINS13:SOURce:DATA:TELEcon:INTerFace:TYPE?
LINS13:SOURce:DATA:TELEcon:HOP:TYPE?
LINS13:SOURce:DATA:TELEcon:HOP:TYPE STS1
LINS13:SOURce:DATA:TELEcon:HOP:TYPE?
LINS13:SOURce:DATA:TELEcon:LOP:TYPE UT15
LINS13:SOURce:DATA:TELEcon:LOP:TYPE?
ABORT BEGIN
READY>
```

Communicating Through TCP/IP over Telnet

Internal Commands of the TCP/IP over Telnet Protocol

BEGIN and END

To execute multiple SCPI commands, you must enclose them in BEGIN and END blocks in a Telnet editor window.

Note: *To execute a single command, simply type or paste the command in the Telnet editor window.*

Note: *You cannot enclose internal commands in a BEGIN and END block, except the ABORT BEGIN command.*

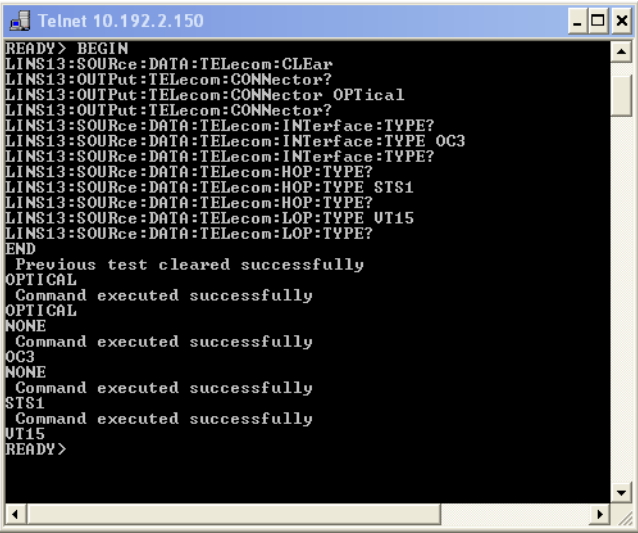

```
Telnet 10.192.2.150
READY> BEGIN
LINS13:SOURce:DATA:TELEcom:CLEAr
LINS13:OUTPut:TELEcom:CONNector?
LINS13:OUTPut:TELEcom:CONNector OPTical
LINS13:OUTPut:TELEcom:CONNector?
LINS13:SOURce:DATA:TELEcom:INterface:TYPE?
LINS13:SOURce:DATA:TELEcom:INterface:TYPE OC3
LINS13:SOURce:DATA:TELEcom:INterface:TYPE?
LINS13:SOURce:DATA:TELEcom:HOP:TYPE?
LINS13:SOURce:DATA:TELEcom:HOP:TYPE STS1
LINS13:SOURce:DATA:TELEcom:HOP:TYPE?
LINS13:SOURce:DATA:TELEcom:LOP:TYPE UT15
LINS13:SOURce:DATA:TELEcom:LOP:TYPE?
END
Previous test cleared successfully
OPTICAL
Command executed successfully
OPTICAL
NONE
Command executed successfully
OC3
NONE
Command executed successfully
STS1
Command executed successfully
UT15
READY>
```

CLEAR LOGS

Syntax: CLEAR LOGS

This command clears all the client and server log files that are older than 36 hours (default value) from the time you execute the command.

```
Trying to connect...
Connected to Toolbox/IGS Manager.
READY> clear logs
Clearing Log files older then 1 hours was not success
READY>
```

Note: You can also delete the logs manually via the file explorer. The client and sever logs are kept respectively in the C:\ProgramData\EXFO\SCPI Over TCP/IP Logs\Client log and in the C:\ProgramData\EXFO\SCPI Over TCP/IP Logs\Server log folders.

CLOSE

Syntax: CLOSE

The CLOSE command terminates the current Telnet session.

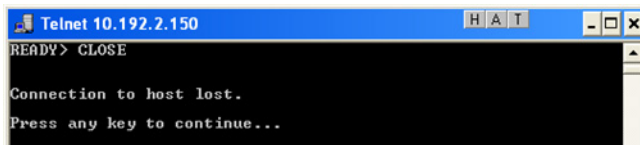

```
Telnet 10.192.2.150
READY> CLOSE
Connection to host lost.
Press any key to continue...
```

Communicating Through TCP/IP over Telnet

Internal Commands of the TCP/IP over Telnet Protocol

CLOSE LINS

Syntax: CLOSE LINS<Unit_Number> <Module_Slot_Number>

You must specify the unit number and the slot number identifying the module for which you want to close the connections.

This command allows to close active connections. You can send this command to close all client's connections with any module, including the current connection.

If the command is not executed successfully, the possible reasons could be:

- The module is not present at the specified position.
- The provided information does not correspond to a valid LINS.



```
Telnet 10.192.3.13
Trying to connect...
Connected to Toolbox/IS Manager.
READY> connect line14
Client: 10.192.2.218:2190 connected to Module at LINS14 now.
READY> close lins14
LINS14 is closed by this client.
READY> _
```

CONNECT LINS

Syntax: CONNECT LINS<Unit_Number><Module_Slot_Number>

You must specify the unit number and the slot number identifying the module to which the session will connect.

This command allows to connect to different modules through TCP/IP. You can connect to multiple modules from a single session.

If the command is not executed successfully, the possible reasons could be:

- The module is already connected to a different client session.
- The module is not present at the specified position.
- The provided information does not correspond to a valid LINS.



```
Telnet 10.192.3.13
Trying to connect...
Connected to Toolbox/IS Manager.
READY> connect lins14
Client: 10.192.2.218:2190 connected to Module at LINS14 now.
READY> _
```

Note: *For backward compatibility reasons, to connect to a single module, you do not have to use the CONNECT LINS command. A valid instrument command (for example, Lins10:SOURce:DATA:TELEcom:CLEar) for a valid LINS position will work for a first module. However, you will need to use the CONNECT LINS command if you want to connect to other modules as well.*

Communicating Through TCP/IP over Telnet

Internal Commands of the TCP/IP over Telnet Protocol

KILL LINS

Syntax: KILL LINS<Unit_Number><Module_Slot_Number>

You must specify the unit number and the slot number identifying the module for which you want to terminate the session.

This command allows any user to terminate the session that contains the specified connection (LINS). This means it will terminate all active connections that belongs to a session.

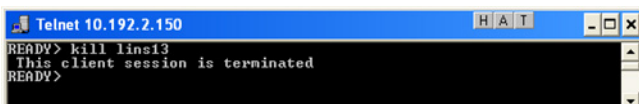

```
Telnet 10.192.2.150
READY> kill lins13
This client session is terminated
READY>
```

To know the status of the modules before terminating connections using the KILL LINS command, you can first enter the STATUS CLIENT command. For more information, see *STATUS CLIENT* on page 429.

In the example below, two modules are connected: LINS13 and LINS10.

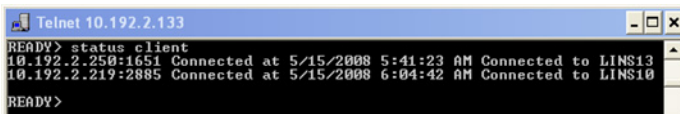

```
Telnet 10.192.2.133
READY> status client
10.192.2.250:1651 Connected at 5/15/2008 5:41:23 AM Connected to LINS13
10.192.2.219:2885 Connected at 5/15/2008 6:04:42 AM Connected to LINS10
READY>
```

To disconnect the LINS10 module used by another session, enter the *kill lins10* command. The **This client session is terminated** message is displayed once the module is disconnected.

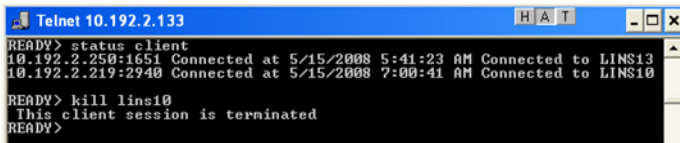

```
Telnet 10.192.2.133
READY> status client
10.192.2.250:1651 Connected at 5/15/2008 5:41:23 AM Connected to LINS13
10.192.2.219:2940 Connected at 5/15/2008 7:00:41 AM Connected to LINS10
READY> kill lins10
This client session is terminated
READY>
```

Communicating Through TCP/IP over Telnet

Internal Commands of the TCP/IP over Telnet Protocol

Enter again the STATUS CLIENT command to confirm the termination of the module (LINS10 in our example). Only the information of the remaining connected client is displayed.

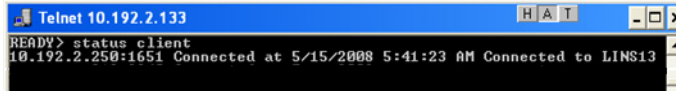

```
Telnet 10.192.2.133 H A T
READY> status client
10.192.2.250:1651 Connected at 5/15/2008 5:41:23 AM Connected to LINS13
```

STATUS CLIENT

Syntax: STATUS CLIENT

This command lists out all clients with their connection time and modules.

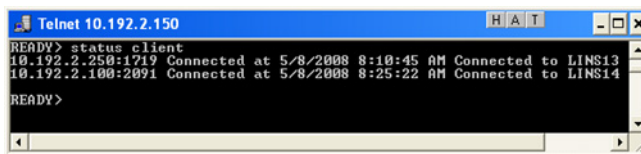

```
Telnet 10.192.2.150 H A T
READY> status client
10.192.2.250:1719 Connected at 5/8/2008 8:10:45 AM Connected to LINS13
10.192.2.100:2091 Connected at 5/8/2008 8:25:22 AM Connected to LINS14
READY>
```

STATUS CONNECTION

Syntax: STATUS CONNECTION

This command lists out all the connections with their *Idle* or *Active* status.

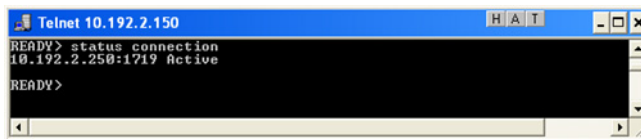

```
Telnet 10.192.2.150 H A T
READY> status connection
10.192.2.250:1719 Active
READY>
```

Note: *If any connection is idle for a certain period (5 minutes by default), the service automatically changes the status to Idle.*

Communicating Through TCP/IP over Telnet

Internal Commands of the TCP/IP over Telnet Protocol

STATUS MODULE

Syntax: STATUS MODULE

This command lists out all the modules with the slot numbers where they are located.

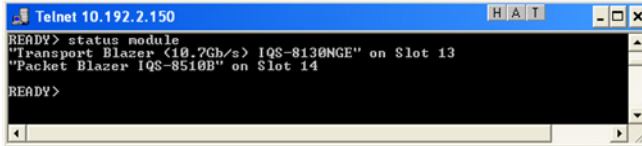

```
Telnet 10.192.2.150
READY> status module
"Transport Blazer (10.7Gb/s) IQS-8130NGE" on Slot 13
"Packet Blazer IQS-8510B" on Slot 14
READY>
```

WHO M I?

Syntax: WHO M I?

This command retrieves the IP address and the communication port of the current session.

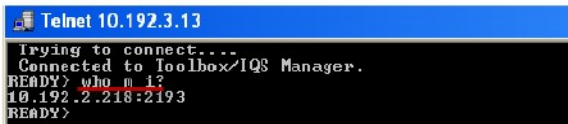

```
Telnet 10.192.3.13
Trying to connect...
Connected to Toolbox/IQS Manager.
READY> who m i?
10.192.2.218:2193
READY>
```

Index

- 3G USB modem, using 116
- A**
- AC adapter 12
- AC requirements 22
- accessing
- Internet with a 3G USB modem 116
 - online help 306
 - power meter and VFL 133
 - ToolBox 40
- activating on-screen keyboard 42
- ActiveX
- control 190
 - linking units 191
 - selecting 196
- adapter 22
- adjusting
- brightness 61
 - date, time and time zone 94
 - right-click 71
 - volume 62
- after-sales service 307
- alarm LED 8
- angled brackets 234
- anti-theft mechanism 55
- antivirus software 54
- appearance, date and time 92
- applications
- installing 45
 - module, starting 41
 - modules 7
 - ToolBox, starting 131
- ASCII format 194
- automatic
- fan speed 13
 - Windows updates 281
- automation 189
- available disk space 138
- B**
- backlight
- button 11
 - setting 61
- battery
- gauge 270
 - inserting 265
 - LED 8
 - maintenance recommendations 261
 - recalibrating 272
 - removing 265
 - status 270
 - type allowed 12, 264
- bay, power meter 276
- Bluetooth
- data transfer 139
 - limitations 139
- boot, first 38
- braces 234
- brackets
- angled 234
 - square 233
- brightness, adjusting 61, 109
- browsing Web 115
- buttons
- backlight 11
 - LOCAL 11
 - program switcher 11
- C**
- calibrating the touchscreen 67
- capacitors 21
- capacity, storage 138
- capturing images 113

Index

caution	
of personal hazard.....	15
of product hazard.....	15
certification information	vii
changing	
batteries	265
communication settings	195
date and time	94
language	83
charger.....	22
charging batteries	261
Charm bar, display	42
choosing	
language	83
power management option.....	95
time zone	94
cleaning	
detector ports.....	258
front panel	257
touchscreen.....	260
VFL connectors	259
cleanup disk	154
close window	42
codes, error	238
colon	234
COM, local control	190
COM/DCOM	
events	406
properties	399
comma	235
commands	
IEEE 488.2	342
SCPI	232
specific	363
TCP/IP	422–429
communication	
ActiveX	190
changing settings	195
default settings.....	198
Ethernet TCP/IP	189, 190
RS-232	189, 190
TCP/IP over Telnet	190, 407–414
configuring	
power management options.....	95
unit.....	38
connecting	
to a VPN.....	158
USB device	56
connector cleaner	259
ConnectorMax2	135
consulting PDF files	112
control	
ActiveX.....	190
Ethernet TCP/IP	189, 190
module	189
remote	189
RS-232	190
TCP/IP over Telnet	190
conventions, programming	232, 235, 237
conventions, safety.....	15
copying	
commands into text document....	254, 256
files and folders	138
creating PDF files	111
current modules view	41
customer service.....	317
D	
data	
transfer	139
types	319
data input	
IEEE 488.2	320
SCPI.....	339
data output IEEE 488.2	
special	332, 340
standard	329
date and time	
adjusting.....	94
formats	92
DC connector.....	5

-
- DCOM
- configuring computers 199
 - technology..... 190
- deleting
- files and folders 138
 - unused system files..... 154
- description
- function buttons..... 11
 - LED panel..... 8
- detecting module..... 29
- detector port, cleaning..... 258
- digit 233
- disconnecting unit..... 20
- Disk Cleanup 154
- disk space, free..... 138
- display Charm bar 42
- documentation..... 306
- documents, printing..... 111
- dongle, 3G USB..... 116
- down, swipe..... 42
- drivers, LabVIEW 48
- E**
- equipment returns 317
- error messages in remote control..... 238
- Ethernet TCP/IP
- control..... 189, 190
 - port 191
- examples, LabVIEW 241
- exiting ToolBox..... 40
- Explorer, Internet 115
- external power supply..... 22
- F**
- fan speed 13
- fiber inspection probe..... 135
- file size limit, Bluetooth..... 139
- files and folders, managing..... 138
- FIP 135
- first startup 38
- freeing disk space..... 154
- front module lock..... 4
- front panel, cleaning 257
- function buttons description 11
- fuse
- replacement..... 21, 283
 - type 283
- G**
- gestures, touchscreen..... 42
- grounding stud 23
- H**
- hard drive LED 8
- hazard, laser radiation..... 19
- headset
- port..... 3, 4
 - volume..... 62
- help, online 306
- hibernation mode..... 32
- hour, setting..... 94
- I**
- identification label..... 307
- IEEE 488.2 commands 342
- indoor use 21
- inlets..... 20
- input
- IEEE 488.2 data types 320
 - SCPI data types 339
- inserting
- batteries..... 265
 - module 26
- inspecting fibers 135
- installing
- monitor..... 58
 - software..... 45
 - third-party software 54
 - unit 21
 - VPN clients..... 158
- instrument control settings 195

Index

interface, changing language..... 83
Internet connection..... 115, 116

K

Kensington lock..... 55
keyboard
 on-screen..... 42
 USB..... 56
keywords, SCPI..... 234

L

label, identification 307
LabVIEW
 demo application..... 241
 installing drivers 48
 principles..... 239
LAN network 190
language, selecting 83
laser safety
 information 19
 LED 8
LED panel description..... 8
left, swipe 42
linking units
 Ethernet port..... 191
 serial port 192
list separator 234
LOCAL button..... 11
local control 190, 196
location
 AC adapter connector..... 5, 6
 hardware buttons..... 2
 LCD touchscreen..... 2
 LED panel 2
lock mechanism 55

M

maintenance
 battery 261
 detector ports 258
 front panel..... 257
 general information 257
 touchscreen 260
managing files and folders 138
mandatory commands 342
manuals..... 306
maximum
 distance, Bluetooth 139
 file size..... 139
mechanical connector cleaning 259
microphone
 port..... 3, 4
 volume..... 62
mnemonic, definition 234
modifying power plans..... 95
module
 controlling 189
 detection 29
 insertion..... 26
 lock 4
 removal..... 26
monitor, external..... 58
monitoring remote commands..... 253
mouse, USB 56
moving files and folders 138
multiple capabilities 233
multitasking with ToolBox..... 7

N

navigating the Internet..... 115
network, LAN/WAN 190

O

online help 306
on-screen keyboard 42
opening user guides 112

- operating system..... 42
 operation language..... 83
 options
 Bluetooth..... 139
 power meter and VFL 133
 software 51
 ToolBox..... 105
 output IEEE 488.2
 special 332, 340
 standard 329
- P**
- PACKed format 194
 Pass Fail status LED 8
 PDF files
 generating 111
 viewing 112
 physical keyboard..... 56
 pipe character 234
 platform commands..... 363
 port
 Ethernet..... 191
 serial..... 192
 power
 cable..... 20
 LED 8
 management 95
 plug 20
 sources 12
 supply..... 22
 power meter, accessing..... 133
 power plans, selecting and modifying..... 95
 press and hold..... 44
 printing documents..... 111
 probe 135
 product
 identification label..... 307
 specifications 14
 program switcher button 11
 programmable instruments,
 standards 189, 232
 protective cap..... 258
 purchased options..... 51
- R**
- radiation hazard, laser 19
 reading PDF files..... 112
 real keyboard..... 56
 recalibrating batteries..... 272
 receiving data
 via Bluetooth..... 139
 with Ethernet port 191
 with serial port..... 192
 recharging batteries 261
 regional and language settings 38
 register
 diagram 230, 231
 ESE..... 228
 ESR..... 228
 SRE..... 228
 STB..... 228
 remaining disk space 138
 remote control
 ActiveX (DCOM) 190, 191
 configuring 196, 199, 414
 description of commands 232
 error messages..... 238
 LED 8
 methods..... 189
 monitoring..... 253
 RS-232 189, 190, 192
 TCP/IP 190, 407–429
 removing
 batteries..... 265
 module 26
 repairing unit..... 21
 replacing fuses 283
 return merchandise authorization (RMA) .. 317
 reverting to default settings 198
 right, swipe 42
 right-clicking with touchscreen 44, 71

Index

RS-232		
communication	189	
control	190	
port	192	
selecting	196	
rules		
programming	237	
syntax	235	
syntax conventions	232	
S		
safety		
caution	15	
conventions	15	
information	19	
power cable	20	
warning	15	
SCPI		
commands	232	
data types	339	
guidelines	189, 232	
screen captures	113	
securing unit	55	
selecting		
language	83	
startup applications	79	
time zone	94	
semicolon	235	
sending data		
via Bluetooth	139	
with Ethernet port	191	
with serial port	192	
separator	234, 235	
service and repairs	317	
service centers	318	
service request enable register (SRE)	228	
setting		
date and time	92, 94	
instrument control utility	195	
shipping to EXFO	317	
short and long formats, date	92	
show Charm bar	42	
shutdown modes	32	
sleep mode	32	
software		
accessing	40	
exiting	40	
installing	45	
options	51	
upgrading	45	
space	233	
speaker volume	62, 109	
specific commands	363	
specifications, product	14	
speed of right-click	71	
square brackets	233	
standard event status		
enable register (ESE)	228	
register (ESR)	228	
standard status data structure		
diagram	230, 231	
general	228	
starting		
applications	41, 131	
ToolBox	40	
startup, selecting applications for	79	
status byte register (STB)	228	
storage requirements	257	
stud, grounding	23	
supports for unit	25	
surfing the Internet	115	
swipe	42	
symbols, safety	15	
syntax		
rules	232, 235	
SCPI	232	
symbols	233	

-
- T**
- TCP/IP
- activating 409
 - commands 422–429
 - configuring parameters 197
 - connecting to Linux 419
 - connecting to Windows 415
 - control 189, 190
 - features 408
 - introduction 407
 - port number 5024 407
 - release examples 421
 - selecting 196, 414
 - technical specifications 14
 - technical support 307
 - temperature for storage 257
 - third-party software 54
 - time zone, selecting 94
- ToolBox
- applications 131
 - language 83
 - options 105
- ToolBox. *see also* software
- touchscreen
- calibrating 67
 - cleaning 260
 - gestures 42
 - right-clicking 44
- transferring data via Bluetooth 139
- transportation requirements 257, 314
- turning unit on/off 32
- type of fuses 21
- types, data 319
- U**
- unit
- back and bottom supports 25
 - disconnecting 20
 - first configuration 38
 - installing 21
 - repairing 21
 - ventilation 21
- updating
- applications 45
 - Windows applications 281
- upgrading software 45
- USB device 56
- user guides 306
- using a 3G USB modem 116
- V**
- ventilation 21
- vertical bar 234
- VFL
- accessing 133
 - cleaning 259
- viewing
- current modules 41
 - PDF files 112
- virtual private network (VPN) 158
- W**
- WAN network 190
- warranty
- certification 316
 - exclusions 316
 - general 315
 - liability 316
 - null and void 315
- Web browser 115
- white space 233
- Windows
- 8.1 Pro version 42
 - update of applications 281

Index

Windows Mobility Center.....	109
Windows.old folder.....	154
wireless connection.....	116
wizard, configuration.....	38
working with Windows.....	42
wsp.....	233

CHINESE REGULATION ON RESTRICTION OF HAZARDOUS SUBSTANCES (RoHS)
中国关于有害物质限制的规定

NAMES AND CONTENTS OF THE TOXIC OR HAZARDOUS SUBSTANCES OR ELEMENTS
CONTAINED IN THIS EXFO PRODUCT
包含在本 EXFO 产品中的有毒有害物质或元素的名称及含量

Part Name 部件名称	Lead 铅 (Pb)	Mercury 汞 (Hg)	Cadmium 镉 (Cd)	Hexavalent Chromium 六价铬 (Cr(VI))	Polybrominated biphenyls 多溴联苯 (PBB)	Polybrominated diphenyl ethers 多溴二苯醚 (PBDE)
Enclosure 外壳	O	O	O	O	O	O
Electronic and electrical sub-assembly 电子和电气组件	X	O	X	O	X	X
Optical sub-assembly ^a 光学组件 ^a	X	O	O	O	O	O
Mechanical sub-assembly ^a 机械组件 ^a	O	O	O	O	O	O

Note:

注:

This table is prepared in accordance with the provisions of SJ/T 11364.

本表依据 SJ/T 11364 的规定编制。

O: Indicates that said hazardous substance contained in all of the homogeneous materials for this part is below the limit requirement of GB/T 26572.

O: 表示该有害物质在该部件所有均质材料中的含量均在 GB/T 26572 标准规定的限量要求以下。

X: indicates that said hazardous substance contained in at least one of the homogeneous materials used for this part is above the limit requirement of GB/T 26572. Due to the limitations in current technologies, parts with the "X" mark cannot eliminate hazardous substances.



X: 表示该有害物质至少在该部件的某一均质材料中的含量超出 GB/T 26572 标准规定的限量要求。

标记 "X" 的部件, 皆因全球技术发展水平限制而无法实现有害物质的替代。

a. If applicable.

如果适用。

MARKING REQUIREMENTS
标注要求

Product 产品	Environmental protection use period (years) 环境保护使用期限 (年)	Logo 标志
This EXFO product 本 EXFO 产品	10	
Battery ^a 电池	5	

a. If applicable.
如果适用。

P/N: 1070459

www.EXFO.com · info@exfo.com

CORPORATE HEADQUARTERS	400 Godin Avenue	Quebec (Quebec) G1M 2K2 CANADA Tel.: 1 418 683-0211 · Fax: 1 418 683-2170
EXFO AMERICA	3400 Waterview Parkway Suite 100	Richardson, TX 75080 USA Tel.: 1 972-761-9271 · Fax: 1 972-761-9067
EXFO EUROPE	Winchester House, School Lane	Chandlers Ford, Hampshire S053 4DG ENGLAND Tel.: +44 2380 246 800 · Fax: +44 2380 246 801
EXFO ASIA-PACIFIC	62 Ubi Road 1, #09-01/02 Oxley Bizhub 2	SINGAPORE 408734 Tel.: +65 6333 8241 · Fax: +65 6333 8242
EXFO CHINA	Beijing Global Trade Center, Tower C, Room 1207, 36 North Third Ring Road East, Dongcheng District	Beijing 100013 P. R. CHINA Tel.: +86 (10) 5825 7755 · Fax: +86 (10) 5825 7722
EXFO SERVICE ASSURANCE	270 Billerica Road	Chelmsford MA, 01824 USA Tel.: 1 978 367-5600 · Fax: 1 978 367-5700
EXFO FINLAND	Elektroniikkatie 2	FI-90590 Oulu, FINLAND Tel.: +358 (0) 403 010 300 · Fax: +358 (0) 8 564 5203
TOLL-FREE	(USA and Canada)	1 800 663-3936

© 2016 EXFO Inc. All rights reserved.
Printed in Canada (2016-10)

