

FTB-5230S/-OCA

Optical Spectrum and Channel Analyzers
for FTB-500



Copyright © 2013 EXFO Inc. All rights reserved. No part of this publication may be reproduced, stored in a retrieval system or transmitted in any form, be it electronically, mechanically, or by any other means such as photocopying, recording or otherwise, without the prior written permission of EXFO Inc. (EXFO).

Information provided by EXFO is believed to be accurate and reliable. However, no responsibility is assumed by EXFO for its use nor for any infringements of patents or other rights of third parties that may result from its use. No license is granted by implication or otherwise under any patent rights of EXFO.

EXFO's Commerce And Government Entities (CAGE) code under the North Atlantic Treaty Organization (NATO) is 0L8C3.

The information contained in this publication is subject to change without notice.

Trademarks

EXFO's trademarks have been identified as such. However, the presence or absence of such identification does not affect the legal status of any trademark.

Units of Measurement

Units of measurement in this publication conform to SI standards and practices.

Patents

Feature(s) of this product is/are protected by one or more of US patents 6,636,306; 8,358,930; 8,364,034 and equivalent patents pending and granted in other countries; patent appl. US 2013/0163987 A1; and US patents 6,612,750 and 8,373,852.

Version number: 10.0.7

Contents

Certification Information	v
1 Introducing the FTB-5230S/-OCA Optical Spectrum and Channel Analyzers	1
Models	2
Typical Applications	2
Optional Software Packages	3
Post-Processing Application	3
Conventions	4
2 Safety Information	5
3 Getting Started with Your OSA/OCA	7
Inserting and Removing Test Modules	7
Starting the OSA/OCA Application	12
Exiting the Application	14
4 Preparing Your OSA/OCA for a Test	15
Cleaning and Connecting Optical Fibers	15
Installing the EXFO Universal Interface (EUI)	17
Selecting a Test Mode	18
Nulling Electrical Offsets	20
Performing User Calibration	22
Using the Autonaming Feature	34
5 Setting Up the Instrument in WDM Mode	41
Defining Preferences	43
Setting Up WDM Analysis Parameters	59
Setting Up Acquisition Parameters	86
6 Setting Up the Instrument in Drift Mode	91
Defining Preferences	93
Setting Up Drift Analysis Parameters	107
Setting Up Acquisition Parameters	131
Building a Custom Drift Measurement	138
7 Setting Up Your OCA	149
8 Starting a Measurement	153

9	Managing Files and Test Configurations	155
	Using the Discover Feature	155
	Managing Measurement Files	158
	Opening Other Test Mode Files in WDM Mode	162
	Managing Favorites	163
	Importing a Configuration from the Current Trace	173
	Using a Restore Point	173
10	Managing Results	175
	Managing WDM Test Results	176
	Managing Drift Test Results	185
	Managing OCA Test Results	196
	Adjusting the Display Size	201
	Viewing WDM Graph in Full-Screen Mode	203
	Using Zoom Controls	204
	Managing Markers	206
	Managing Trace Information	210
	Generating Reports	214
11	Maintenance	217
	Cleaning EUI Connectors	217
	Recalibrating the Unit	220
	Recycling and Disposal (Applies to European Union Only)	221
12	Troubleshooting	223
	Viewing Online Documentation	223
	Contacting the Technical Support Group	224
	Transportation	226
13	Warranty	229
	General Information	229
	Liability	230
	Exclusions	231
	Certification	231
	Service and Repairs	232
	EXFO Service Centers Worldwide	233
A	Technical Specifications	235
	Index	237

Certification Information

North America Regulatory Statement

This unit was certified by an agency approved in both Canada and the United States of America. It has been evaluated according to applicable North American approved standards for product safety for use in Canada and the United States.

Electronic test and measurement equipment is exempt from FCC part 15, subpart B compliance in the United States of America and from ICES-003 compliance in Canada. However, EXFO Inc. makes reasonable efforts to ensure compliance to the applicable standards.

The limits set by these standards are designed to provide reasonable protection against harmful interference when the equipment is operated in a commercial environment. This equipment generates, uses, and can radiate radio frequency energy and, if not installed and used in accordance with the user guide, may cause harmful interference to radio communications. Operation of this equipment in a residential area is likely to cause harmful interference in which case the user will be required to correct the interference at his own expense.

Modifications not expressly approved by the manufacturer could void the user's authority to operate the equipment.

European Community Declaration of Conformity

An electronic version of the declaration of conformity for your product is available on our website at www.exfo.com. Refer to the product's page on the Web site for details.

1 **Introducing the FTB-5230S/-OCA Optical Spectrum and Channel Analyzers**

The FTB-5230S Optical Spectrum Analyzer (OSA) is designed to measure optical power as a function of wavelength or frequency and Optical Signal to Noise Ratio (OSNR) based on the IEC method (interpolation method).

It offers truly portable spectral characterization for DWDM network commissioning.

The FTB-5230S-OCA Optical Channel Analyzer (OCA) is designed to measure optical power as a function of wavelength or frequency.

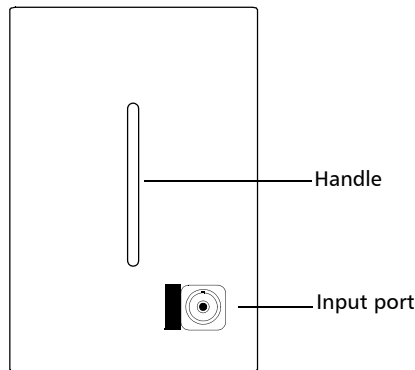

Models

The OSA/OCA comes in different models:

- The FTB-5230S is an entry-level optical spectrum analyzer that is ideal for a variety of field applications, including DWDM and CWDM network commissioning and troubleshooting. The test modes available for your module are WDM and Drift.
- The FTB-5230S-OCA (Optical Channel Analyzer): This model is designed to measure optical power as a function of wavelength or frequency. It offers truly portable spectral characterization for CWDM and DWDM network commissioning.

Typical Applications

You can use your OSA/OCA for the following tasks:

- Characterizing channels in the O- to U-band spectra (OSA only)
- Troubleshooting and monitoring key parameters on CWDM or DWDM signals to check system stability
- Characterizing all channel spacings, from 50 GHz DWDM to CWDM
- Testing high-speed networks (beyond 40 Gbit/s)

Optional Software Packages

Optional software options are available for your OCA application.

Note: *Software options are not available on the OSA.*

Option Name	Description
WDM	This option enables you to perform full WDM analyses as well as WDM drift measurements, just as you would with an FTB-5230S OSA.

Post-Processing Application

A post-processing, or offline version of the application is available for you to use on a conventional computer. This offline version has most of the module application, but does not allow you to perform acquisitions.

Note: *The post-processing application is not available for the OCA.*

Conventions

Before using the product described in this guide, you should understand the following conventions:



WARNING

Indicates a potentially hazardous situation which, if not avoided, could result in *death or serious injury*. Do not proceed unless you understand and meet the required conditions.



CAUTION

Indicates a potentially hazardous situation which, if not avoided, may result in *minor or moderate injury*. Do not proceed unless you understand and meet the required conditions.



CAUTION

Indicates a potentially hazardous situation which, if not avoided, may result in *component damage*. Do not proceed unless you understand and meet the required conditions.



IMPORTANT

Refers to information about this product you should not overlook.

2 **Safety Information**



WARNING

Do not install or terminate fibers while a light source is active. Never look directly into a live fiber and ensure that your eyes are protected at all times.



WARNING

The use of controls, adjustments and procedures other than those specified herein may result in exposure to hazardous situations or impair the protection provided by this unit.



IMPORTANT



When you see the following symbol on your unit , make sure that you refer to the instructions provided in your user documentation. Ensure that you understand and meet the required conditions before using your product.



IMPORTANT

Other safety instructions relevant for your product are located throughout this documentation, depending on the action to perform. Make sure to read them carefully when they apply to your situation.



CAUTION

The following symbol indicates that your unit is equipped with a laser source:



Safety Information

Your instrument is a Class 1 laser product in compliance with standards IEC 60825-1: 2007 and 21 CFR 1040.10, except for deviations pursuant to Laser Notice No. 50, dated June 24, 2007. Invisible laser radiation may be encountered at the output port.

The following label indicates that a product contains a Class 1 source:



The maximum input power for the FTB-5230S/-OCA Optical Spectrum and Channel Analyzers is ≤ 4 W. For more information on equipment ratings, refer to the user documentation for your platform.

3 Getting Started with Your OSA/OCA

Inserting and Removing Test Modules



CAUTION

Never insert or remove a module while the FTB-500 is turned on. This will result in immediate and irreparable damage to both the module and unit.



CAUTION

To avoid damaging your unit, use it only with modules approved by EXFO.



WARNING

When the laser safety LED () is flashing on the FTB-500, at least one of your modules is emitting an optical signal. Please check all modules, as it might not be the one you are currently using.

To insert a module into the FTB-5230S/OCA:

1. Exit ToolBox and turn off your unit.
2. Position the FTB-500 so that its right panel is facing you.

Getting Started with Your OSA/OCA

Inserting and Removing Test Modules

3. Take the module and place it so that the connector pins are at the back, as explained and shown below.

Identification sticker must be facing up and connector pins at the right of the retaining screw hole.

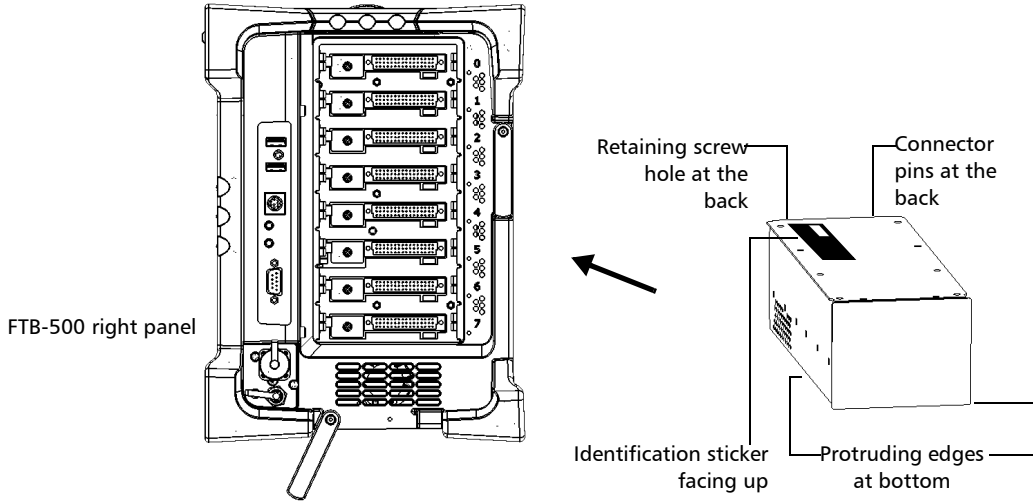

4. Insert the protruding edges of the module into the grooves of the receptacle's module slot.
5. Push the module all the way to the back of the slot, until the retaining screw makes contact with the receptacle casing.
6. Place the FTB-500 so that its left panel is facing you.

Getting Started with Your OSA/OCA

Inserting and Removing Test Modules

7. While applying slight pressure to the module, turn the retaining screw clockwise until it is tightened.

This will secure the module into its “seated” position.

Turn retaining screw knob
clockwise

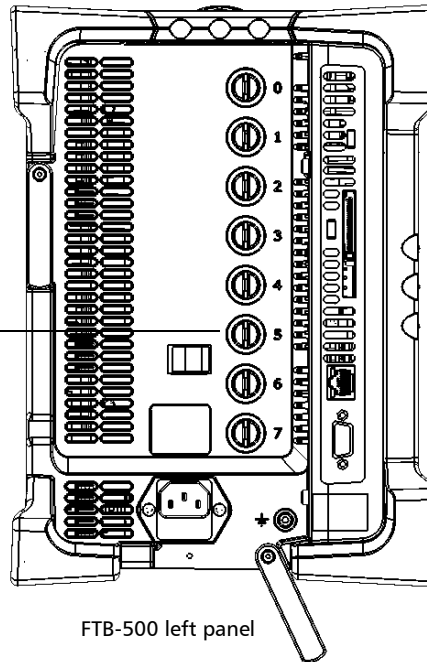
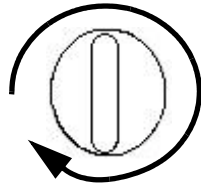

FTB-500 left panel

When you turn on the unit, the startup sequence will automatically detect the module.

Getting Started with Your OSA/OCA

Inserting and Removing Test Modules

To remove a module from the FTB-500:

1. Exit ToolBox and turn off your unit.
2. Position the FTB-500 so that the left panel is facing you.
3. Turn the retaining screw counterclockwise until it stops.

The module will be slowly released from the slot.

Turn retaining screw knob(s)
counterclockwise

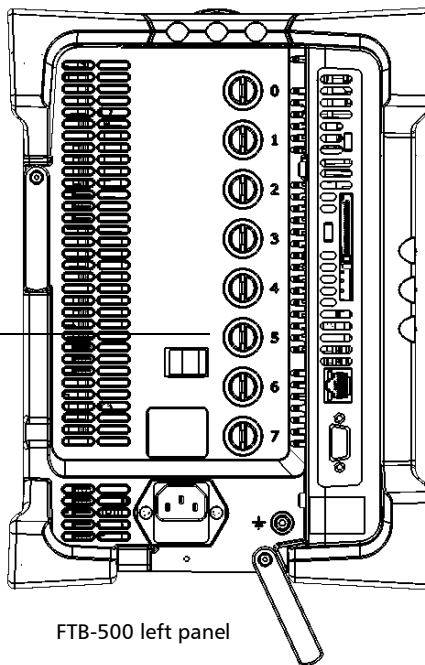
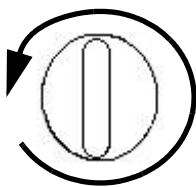

4. Place the FTB-500 so that the right panel is facing you.

5. Hold the module by its sides or by the handle (*NOT by the connector*) and pull it out.

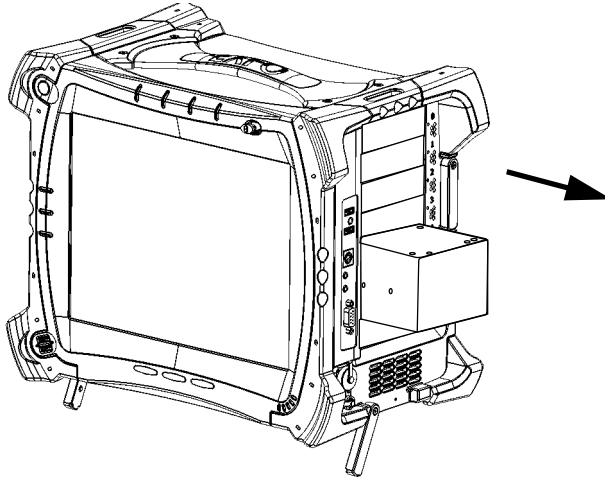

6. Cover empty slots with the supplied protective covers.



CAUTION

Failure to reinstall protective covers over empty slots will result in ventilation problems.

Getting Started with Your OSA/OCA

Starting the OSA/OCA Application

Starting the OSA/OCA Application

Your FTB-5230S/-OCA Optical Spectrum and Channel Analyzers module can be configured and controlled from its dedicated ToolBox application.

Note: For details about ToolBox, refer to the FTB-500 user guide.

To start the application:

1. From the main window, select the module to use.

It will turn blue to indicate that it is highlighted.

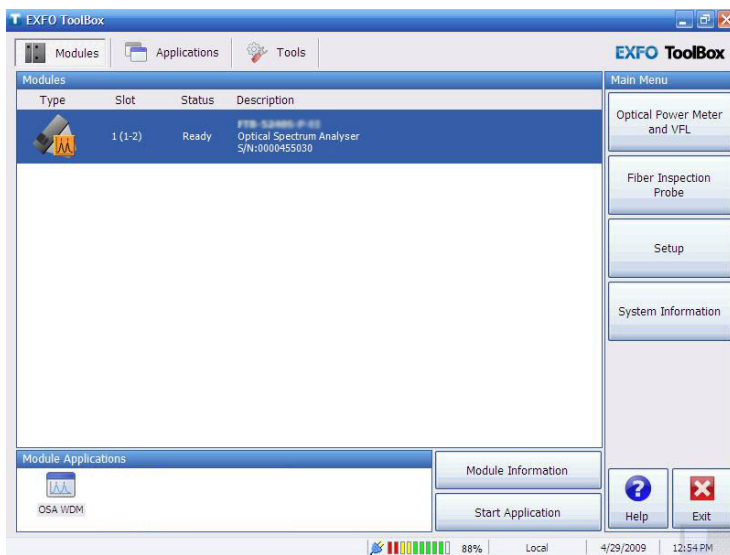

- Click the corresponding button in the **Module Applications** box.

The main window (shown below) contains all the commands required to control the OSA/OCA:

The screenshot displays the FTB-5230S software interface. The top section, labeled 'Display panes', features a spectral plot with 10 channels (L0-L9) and a 'Function buttons' sidebar on the right. The bottom section, labeled 'Result panes', contains a table with acquisition results for 7 channels.

Ch. #	f (THz)	Power (dBm)	OSNR (dB)	Noise (dBm)	BW 3.00 dB (GHz)	BW 20.00 dB (GHz)
1	1522.294	(0.97)	55.45	(TEC)-54.48	0.127	0.355
2	1530.162	(1.21)	56.77	(TEC)-55.56	0.126	0.365
3	1538.017	(2.43)	57.11	(TEC)-54.68	0.130	0.355
4	1546.193	(2.45)	57.56	(TEC)-55.10	0.134	0.353
5	1554.548	(1.70)	57.17	(TEC)-55.47	0.137	0.355
6	1562.790	(2.00)	57.29	(TEC)-55.39	0.165	0.388
7	1570.776	(1.01)	55.93	(TEC)-54.92	0.168	0.395

FTB-5230S

Getting Started with Your OSA/OCA

Exiting the Application

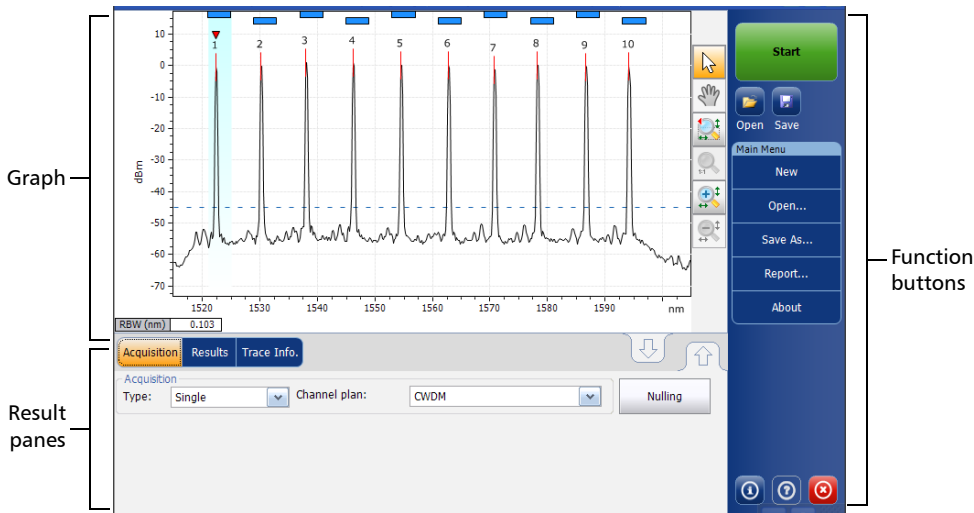

FTB-5230S-OCA

Note: The illustrations in this user guide may differ slightly from those on your unit depending on the resolution, application and platform type.

Exiting the Application

Closing any application that is not currently being used helps freeing system memory.

To close the application from the main window:

Click  in the top right corner of the main window.

OR

Click the **Exit** button located at the bottom of the function bar.

4 **Preparing Your OSA/OCA for a Test**



IMPORTANT

For optimal test results, you should allow a minimum warm up period of two hours for your OSA/OCA before starting your tests.

Cleaning and Connecting Optical Fibers



IMPORTANT

To ensure maximum power and to avoid erroneous readings:

- Always inspect fiber ends and make sure that they are clean as explained below before inserting them into the port. EXFO is not responsible for damage or errors caused by bad fiber cleaning or handling.
- Ensure that your patchcord has appropriate connectors. Joining mismatched connectors will damage the ferrules.

To connect the fiber-optic cable to the port:

- 1.** Inspect the fiber using a fiber inspection microscope. If the fiber is clean, proceed to connecting it to the port. If the fiber is dirty, clean it as explained below.
- 2.** Clean the fiber ends as follows:
 - 2a.** Gently wipe the fiber end with a lint-free swab dipped in isopropyl alcohol.
 - 2b.** Use compressed air to dry completely.
 - 2c.** Visually inspect the fiber end to ensure its cleanliness.

Preparing Your OSA/OCA for a Test

Cleaning and Connecting Optical Fibers

3. Carefully align the connector and port to prevent the fiber end from touching the outside of the port or rubbing against other surfaces.

If your connector features a key, ensure that it is fully fitted into the port's corresponding notch.

4. Push the connector in so that the fiber-optic cable is firmly in place, thus ensuring adequate contact.

If your connector features a screwsleeve, tighten the connector enough to firmly maintain the fiber in place. Do not overtighten, as this will damage the fiber and the port.

Note: *If your fiber-optic cable is not properly aligned and/or connected, you will notice heavy loss and reflection.*

EXFO uses good quality connectors in compliance with EIA-455-21A standards.

To keep connectors clean and in good condition, EXFO strongly recommends inspecting them with a fiber inspection probe before connecting them. Failure to do so will result in permanent damage to the connectors and degradation in measurements.

Installing the EXFO Universal Interface (EUI)

The EUI fixed baseplate is available for connectors with angled (APC) or non-angled (UPC) polishing. A green border around the baseplate indicates that it is for APC-type connectors.

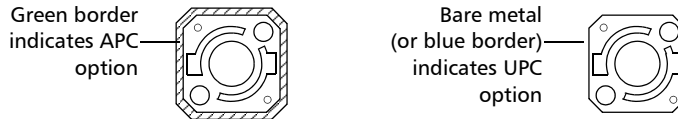

To install an EUI connector adapter onto the EUI baseplate:

1. Hold the EUI connector adapter so the dust cap opens downwards.

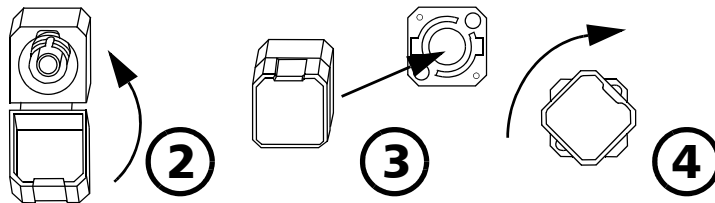

2. Close the dust cap in order to hold the connector adapter more firmly.
3. Insert the connector adapter into the baseplate.
4. While pushing firmly, turn the connector adapter clockwise on the baseplate to lock it in place.

Preparing Your OSA/OCA for a Test

Selecting a Test Mode

Selecting a Test Mode

Your module gives you different ways to test all your DWDM systems:

- WDM: Allows you to analyze an optical link. By default, the WDM test mode is selected.
- Drift: Allows you to monitor an optical link for a fixed duration.

Note: You cannot select a test mode in the OCA application.

To select a test mode:

1. From the **Main Menu**, press **Mode**.

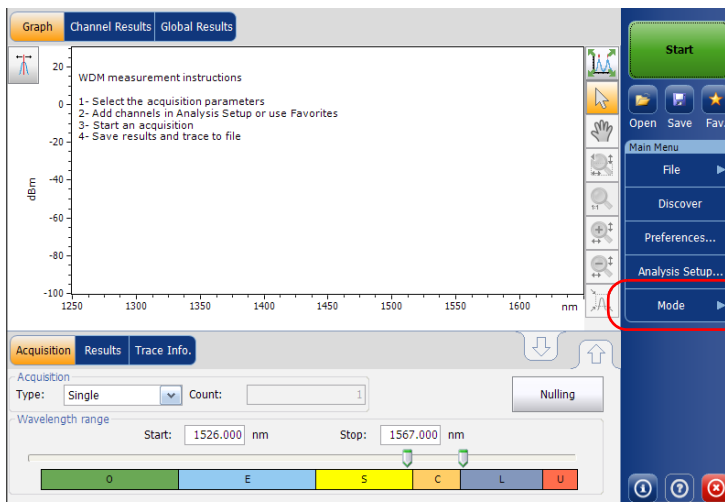

2. Select the desired test mode.

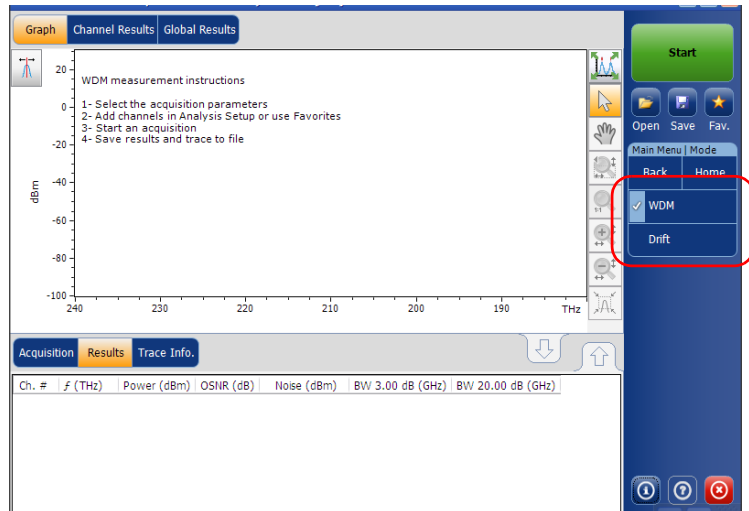

Once you select the mode, you will notice a against the selected mode and all the tabs on the main window and the main menu will change accordingly.

After selecting the test mode, you must configure it. You will find specific instructions for your test mode in the corresponding related chapters.

Nulling Electrical Offsets

The offset nulling process provides a zero-power reference measurement, thus eliminating the effects of electronic offsets and dark current due to detectors.

Temperature and humidity variations affect the performance of electronic circuits and optical detectors. For this reason, EXFO recommends performing a nulling of the electrical offsets whenever environmental conditions change.

Nulling can be performed for all tests modes. In addition, a nulling is performed automatically each time you start the OSA/OCA application, and at regular intervals afterwards.

Note: *You cannot perform an offset nulling in the offline version of the application.*

To perform an offset nulling:

1. From the main window, select the **Acquisition** tab.

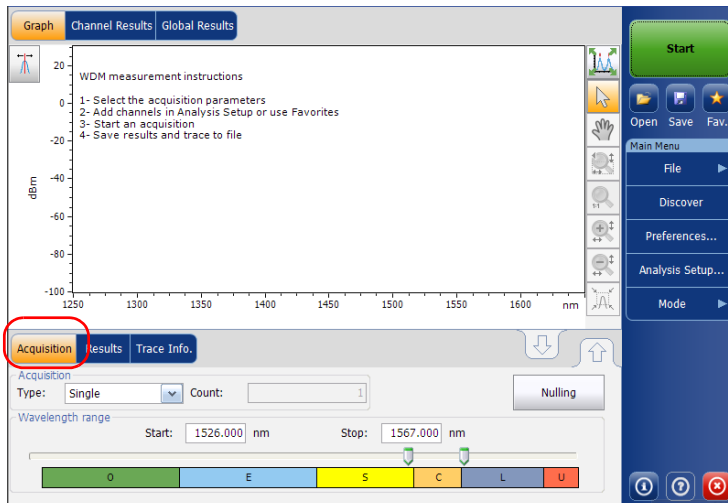

2. Disconnect any incoming signal to obtain an optimal accuracy.
3. Press **Nulling**.

You are notified that the nulling is in progress in the status bar. Nulling should be completed in a few seconds.

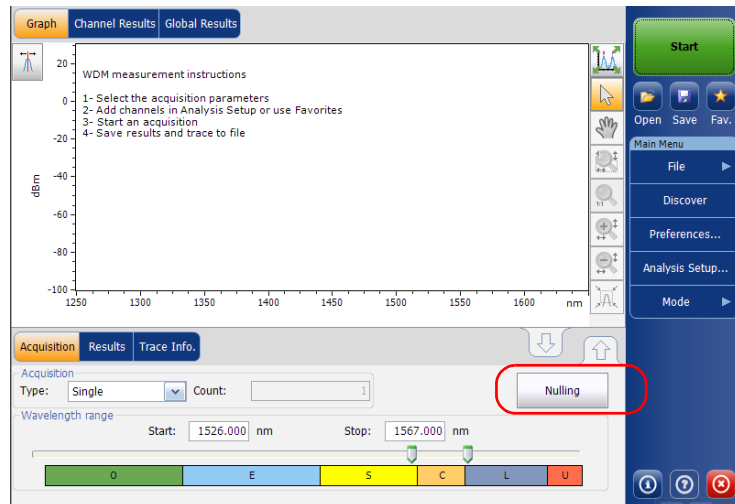

Note: Several features, such as the **Start** button and **Discover**, are not available during the nulling process.

Performing User Calibration

Calibrating your module can help you achieve better results. It is particularly important when the measurement accuracy is critical or when your OSA/OCA has experienced unusual shock or vibrations. To reach the highest possible accuracy, you can perform a wavelength or power calibration. Your OSA/OCA allows you to modify and read the user calibration values, revert to the factory calibration, load and save the modified user calibration file. The user configuration file (*.txt) contains the reference and modified wavelength and power values.

You can perform user calibration in any test mode. Select a test mode as explained in *Selecting a Test Mode* on page 18, and follow the procedures mentioned below for performing user calibration.

Note: *The procedure is not available for the OCA application.*

Note: *The procedure for performing user calibration is the same for all test modes. The procedure is explained with WDM mode only in this document.*



IMPORTANT

For optimal results, you should allow a minimum warm up period of two hours for your OSA/OCA before performing user calibration.



IMPORTANT

You must clear the correction factor list before making new calibration measurements. If calibration measurements are made when user correction factors are inside the module, the latter will affect the measurements and the calibration results become inapplicable.

Note: *If you want to keep the correction factor list for a later use, save it under a different name in the folder.*

Note: The user calibration feature is not available in the offline version of the application.

To perform a user calibration:

1. Allow your unit to warm up.
2. From the **Main Menu**, press **Analysis Setup**.

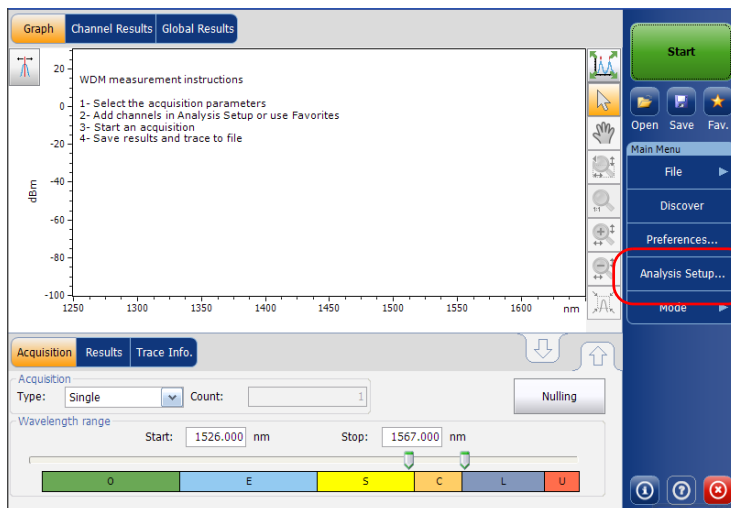

Preparing Your OSA/OCA for a Test

Performing User Calibration

3. Select the **Calibration** tab.

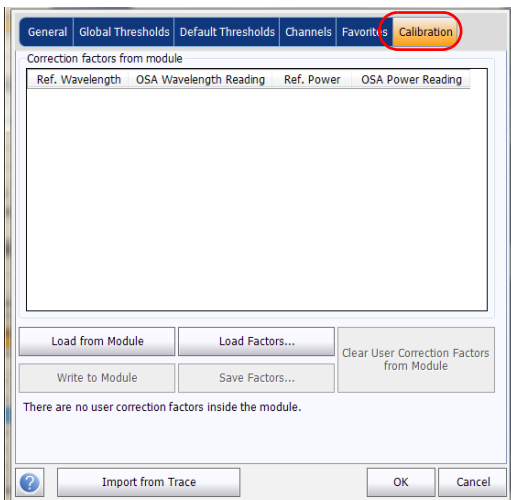

Note: You cannot edit the power or wavelength values directly from the application. The modifications in the user calibration have to be made in a text file, and then it can be loaded in the application.

4. If user correction factors are in the system, press **Clear User Correction Factors from Module**, then confirm your choice.

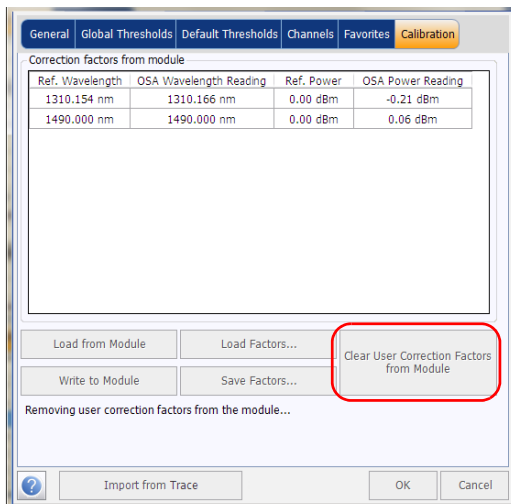

5. Take measurements for your test mode.

Preparing Your OSA/OCA for a Test

Performing User Calibration

6. Note the measurements to a .txt file using the following format:
 - The first column is the reference wavelengths, in nm.
 - The second column is the wavelength read by your module, in nm.
 - The third column is the reference power, in dBm.
 - The fourth column is the power read by your module, in dBm.

Note: *The columns are separated by a semi-colon (;). You can have up to 100 calibration points.*

Here is an example of a measurement file:

1310.154; 1310.167; -1.34; -1.55

1490.000; 1490.000; 1.09; 1.15

1551.334; 1551.298; -5.20; -5.45

1625.401; 1625.448; 0.00; 0.00

Note: *The decimal separator is a point (.). This format is independent of the regional settings.*

7. Save your .txt file in a location of your choice.

8. Back in the **Calibration** tab on your unit, load the file using **Load Factors**.

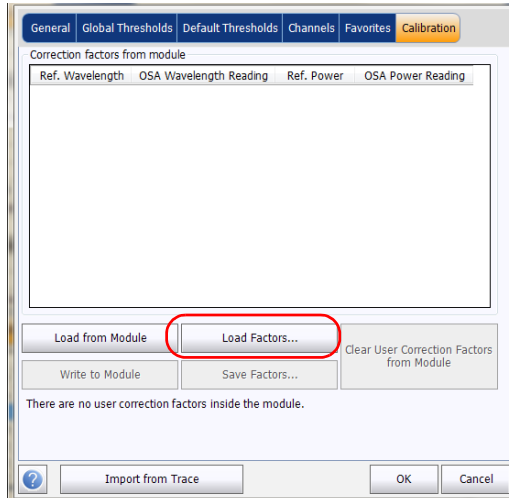

9. Select the modified user calibration file and press **Open**.

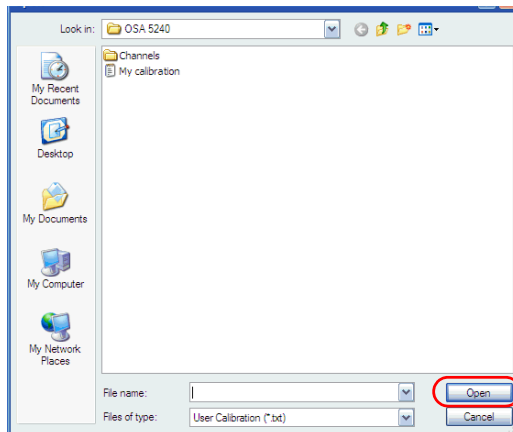

Preparing Your OSA/OCA for a Test

Performing User Calibration

The calibration values will replace the Correction factors list in the **Analysis setup - Calibration** window.

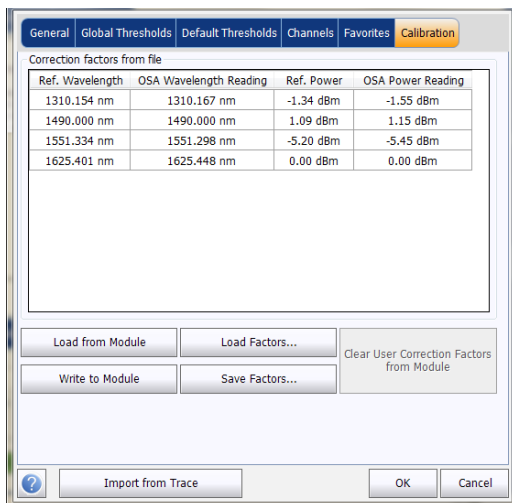

10. Press **Write to Module** to apply the modified calibration values to the module.

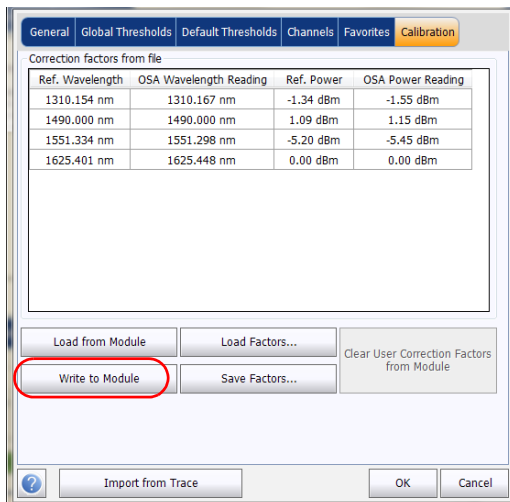

Preparing Your OSA/OCA for a Test

Performing User Calibration

11. To verify that the calibration changes are properly applied to the module, press **Load from Module**.

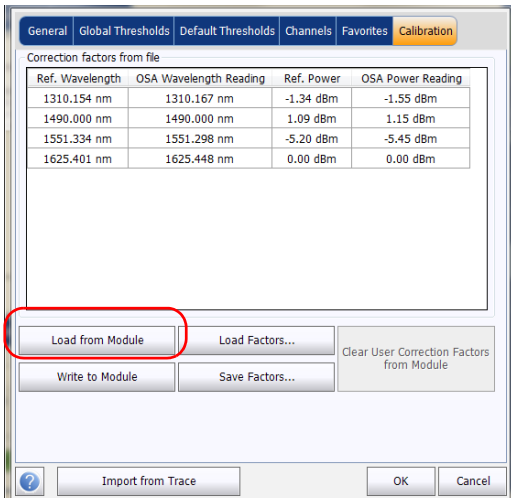

Note: The **OK** and **Cancel** buttons do not have any impact on the calibration page or the correction factors inside the module.

To save a user calibration:

1. From the Main Menu, press **Analysis Setup**.

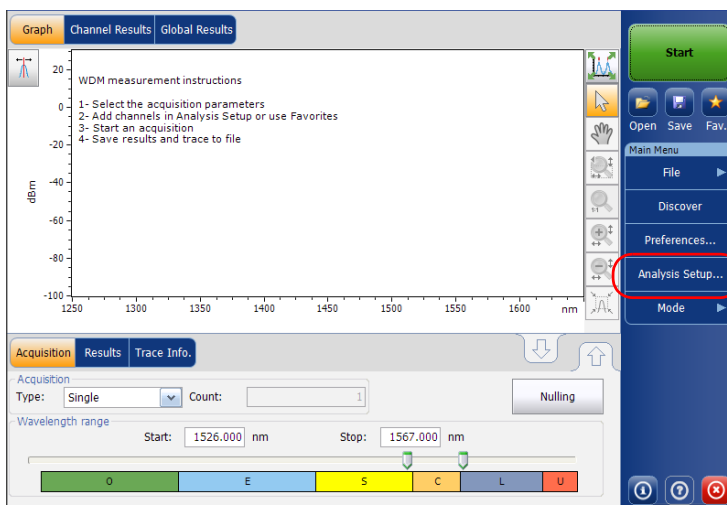

Preparing Your OSA/OCA for a Test

Performing User Calibration

2. Select the **Calibration** tab.

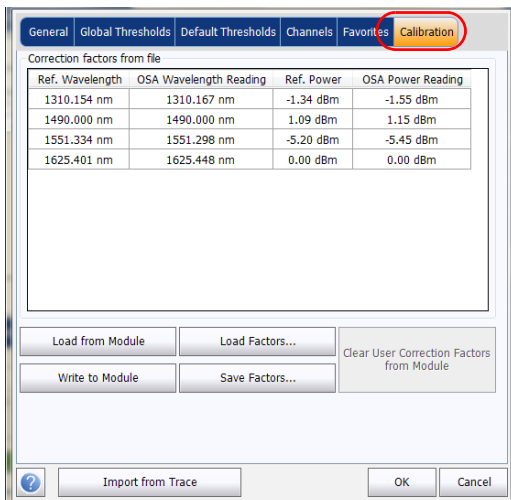

3. Press **Save Factors**, to save the modified user calibration values.

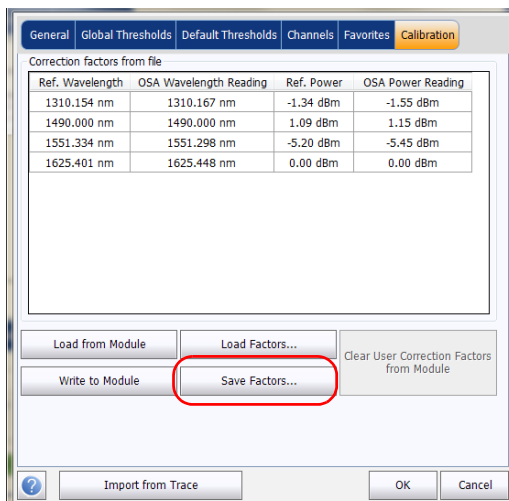

Using the Autonaming Feature

Defining a file autonaming format will allow you to quickly and automatically name traces in a sequential order. The customized name appears when the file is saved using the Save As option. You can select which fields you want to include in the file name and the order in which they should be displayed.

The Link ID is used by the application to suggest a file name when you want to save the current acquisition. The link parameters are prefix and suffix values (file names) for the link IDs.

Note: *The autonaming feature is not available in the offline application.*

Note: *The autonaming feature is always active for the OCA application and you can customize it using the trace identification information.*

Note: *The procedure below uses the WDM test mode as an example, but the autonaming feature is available for all test modes.*

To customize the file name:

1. From the **Main Menu**, press **Preferences**.

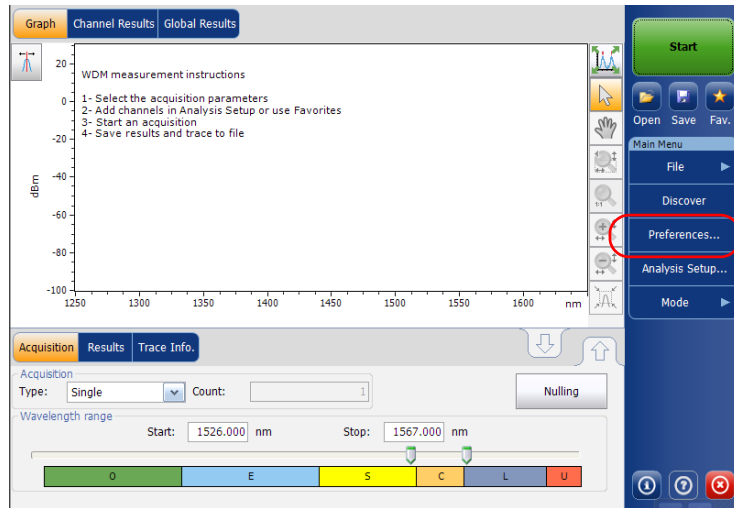

Preparing Your OSA/OCA for a Test

Using the Autonaming Feature

2. Select the **File Name** tab.

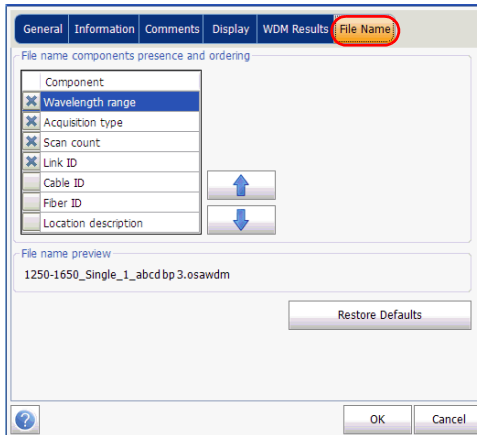

3. Select which parameters you want to include in the file name from the list of available choices:

- Wavelength/frequency range: current wavelength/frequency acquisition range.
- Acquisition type: current acquisition type.
- Scan count: current number of scans in the acquisition tab.
- Link ID: prefix value for the link ID configured in the **Preferences-Information** tab.
- Cable ID: prefix value for the cable ID configured in the **Preferences-General** tab.
- Fiber ID: prefix value for the fiber ID configured in the **Preferences-General** tab.
- Location description: location description provided in the **Preferences-Information** tab.

4. Press the up or down arrows to change the order in which the field values will appear in the file name.

Based on your selection, a preview of the file name is displayed under **File name preview**. The field values are separated with an underscore (_).

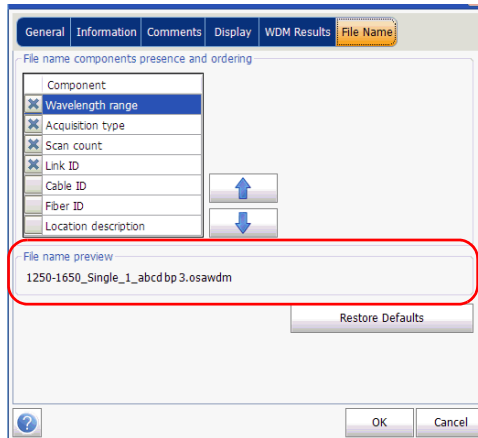

5. Press **OK** to save the changes and close the window, or press **Cancel** to exit without saving.

Press **Restore Defaults** to remove all the changes and apply the default settings.

The OCA default file name is “Link###”, where ### is an auto-incrementing number starting at 1 and ending at 999 (after reaching 999, it returns to 1). You can add cable ID and fiber ID information to the name.

Preparing Your OSA/OCA for a Test

Using the Autonoming Feature

To customize the file name in the OCA application:

1. From the main window, select the **Trace Info.** tab.
2. Press **Trace identification.**

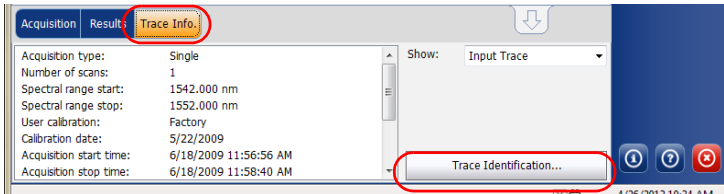

3. In the **General** tab, enter the cable ID and fiber ID information you want to use.

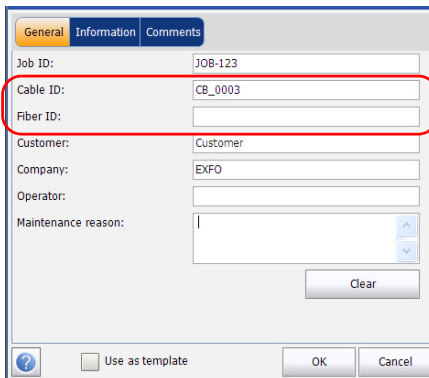

4. Select the **Use as template** option.

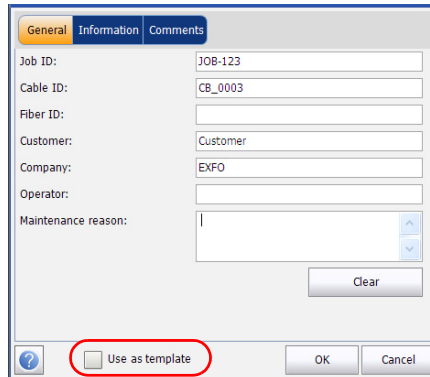

The screenshot shows a dialog box with three tabs: 'General' (selected), 'Information', and 'Comments'. The 'General' tab contains the following fields:

- Job ID: JOB-123
- Cable ID: CB_0003
- Fiber ID: (empty)
- Customer: Customer
- Company: EXFO
- Operator: (empty)
- Maintenance reason: (empty text area with up/down arrows)

At the bottom of the dialog, there is a 'Clear' button and a 'Use as template' checkbox, which is circled in red. To the right of the checkbox are 'OK' and 'Cancel' buttons.

5. Press **OK** to confirm your choice.

The new default file name will be “CableID_FiberID_Link###”. If you want to change the word “Link” or the increment number, you can do so in the **Save As** window, where the information will be kept for the next time you save a file.

5 **Setting Up the Instrument in WDM Mode**

Note: *This mode is not available in the OCA application.*

Before performing a spectral analysis in the WDM mode, you must set up the test application with the appropriate parameters, as explained in this chapter.

Select the WDM test mode as explained in *Selecting a Test Mode* on page 18 before setting up the WDM test parameters.

- The *preferences* are the result displayed in the graph and tables, as well as the job information and related comments saved with each file.
- The *analysis parameters* include the channel list details, pass-fail threshold settings and allows you to select the noise and power calculation methods.
- The *acquisition parameters* include the type of measurement you want to perform and the wavelength range.

See *Defining Preferences* on page 43, *Setting Up WDM Analysis Parameters* on page 59 and *Setting Up Acquisition Parameters* on page 86 for more details.

Setting Up the Instrument in WDM Mode

You can set up your unit in different manners, depending on your testing needs.

- The preferred way is to use the complete analysis setup parameters and complete the information in all tables, as explained in *Setting Up WDM Analysis Parameters* on page 59. This setup will be used for the next acquisition.
- The easiest way to set up the instrument, especially when the operator does not know in advance what to expect at the input of the module is to use the **Discover** button. After the **Discover** button has been pressed, a measurement and analysis will be performed according to the best setup determined by the instrument and this setup will be used for the next scan. This is explained in *Using the Discover Feature* on page 155.
- The most efficient way to set up the instrument is to use one of the favorites configurations, uploading a pre-customized acquisition and analysis setup configuration. The operator in the field only has to press the  button, select the appropriate configuration and press **Start**. As an example, a pre-customized configuration could be: “32 channels DWDM 50GHz”; “Toronto-Montreal CWDM” or “Vendor ABC DWDM ROADM 40Gb”. This is explained in *Managing Favorites* on page 163.
- You can also import the setup from the current trace. This method will take the data and channel information from the current trace and apply them in the corresponding tabs. For more information, see *Setting Up WDM Analysis Parameters* on page 59.

Defining Preferences

The preferences window allows you to set general information and comments on trace, set display parameters and customize the WDM results table.

Note: Only the **Display** and **WDM Results** tabs are available in offline mode.

Defining Trace Information

The trace information relates to the description of the job to be done, cable and job IDs, and any relevant information about what is being tested.

To enter general information:

1. From the **Main Menu**, press **Preferences**.

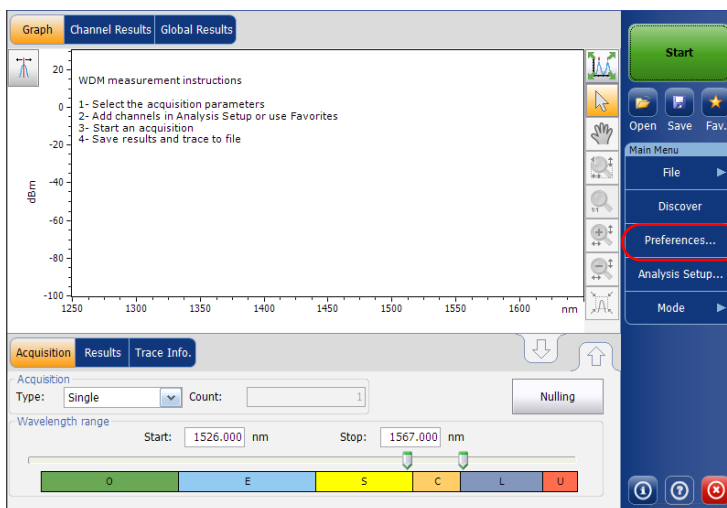

Setting Up the Instrument in WDM Mode

Defining Preferences

2. Select the **General** tab.

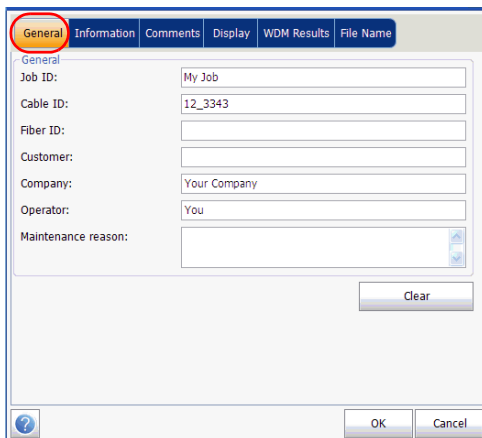

The screenshot shows a software window with a tabbed interface. The 'General' tab is selected and highlighted with a red circle. The window contains the following fields and controls:

- General** (tab, highlighted)
- Information** (tab)
- Comments** (tab)
- Display** (tab)
- WDM Results** (tab)
- File Name** (tab)
- Job ID:** Text input field containing 'My Job'
- Cable ID:** Text input field containing '12_3343'
- Fiber ID:** Text input field (empty)
- Customer:** Text input field (empty)
- Company:** Text input field containing 'Your Company'
- Operator:** Text input field containing 'You'
- Maintenance reason:** Text input field (empty)
- Clear** button (located below the Maintenance reason field)
- OK** button (bottom right)
- Cancel** button (bottom right)
- Help** icon (bottom left)

3. Define the general parameters as needed.
4. Press **OK** to save the changes and close the window, or press **Cancel** to exit without saving.

Press **Clear** to clear all the changes made in the **General** tab.

To enter link and location information:

1. From the Main Menu, press Preferences.

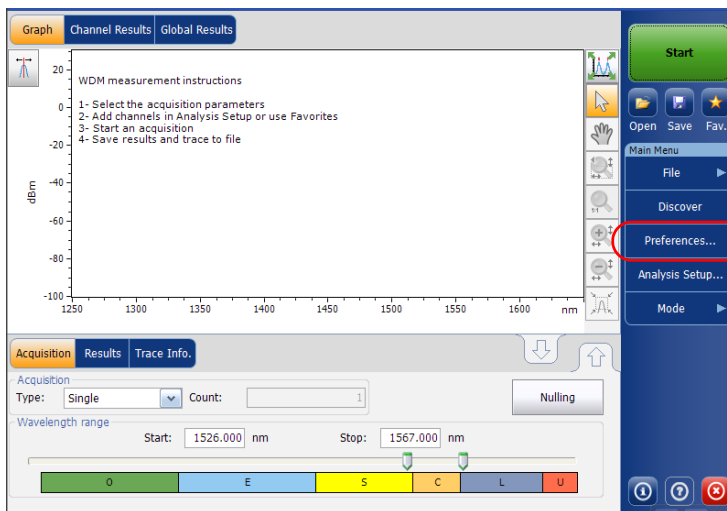

2. Select the Information tab.

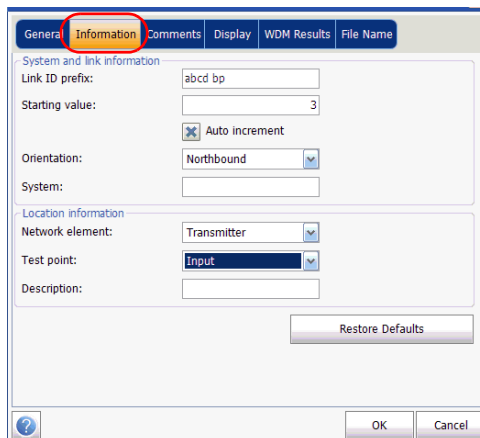

Setting Up the Instrument in WDM Mode

Defining Preferences

3. Under **System and link information**, define the following parameters as needed:

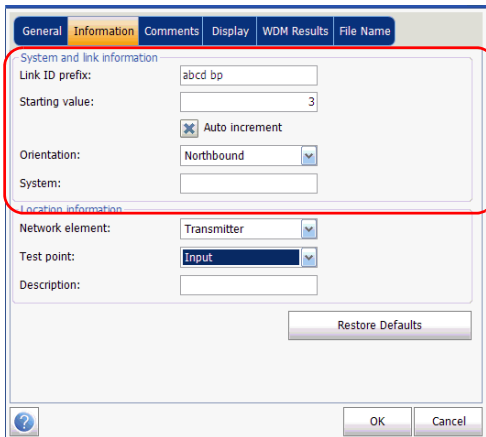

- Link ID prefix: The prefix value for the link ID. You can enter any alphanumeric value.
- Starting value: The suffix increment starting value for the link ID. This value is incremented each time a new file is saved provided the **Auto Increment** option is selected.



IMPORTANT

If the Auto Increment option is not selected, you have to manually change the file name when saving the trace file, otherwise the application will overwrite the previously saved file.

- Orientation: The orientation of the link.
- System: Information about the system under test.

4. Under **Location Information**, define the following parameters as needed:

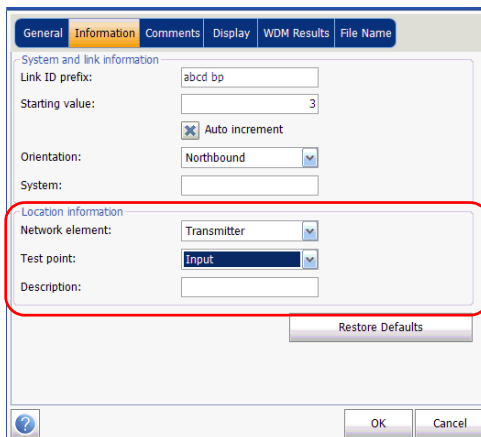

The screenshot shows a software window with several tabs: General, Information, Comments, Display, WDM Results, and File Name. The 'Information' tab is active. It contains two sections: 'System and link information' and 'Location information'. The 'Location information' section is highlighted with a red box and contains the following fields: 'Network element' (dropdown menu set to 'Transmitter'), 'Test point' (dropdown menu set to 'Input'), and 'Description' (text input field). Below the 'Location information' section is a 'Restore Defaults' button. At the bottom of the window are 'OK' and 'Cancel' buttons.

- Network element: Sets the type of network element.
 - Test point: Sets the location where the test is performed on the link.
 - Description: Enter the description of location if required.
5. Press **OK** to save the changes and close the window, or press **Cancel** to exit without saving.

Press **Restore Defaults** to remove all the changes and apply the default values.

Setting Up the Instrument in WDM Mode

Defining Preferences

To enter comments:

1. From the **Main Menu**, press **Preferences**.

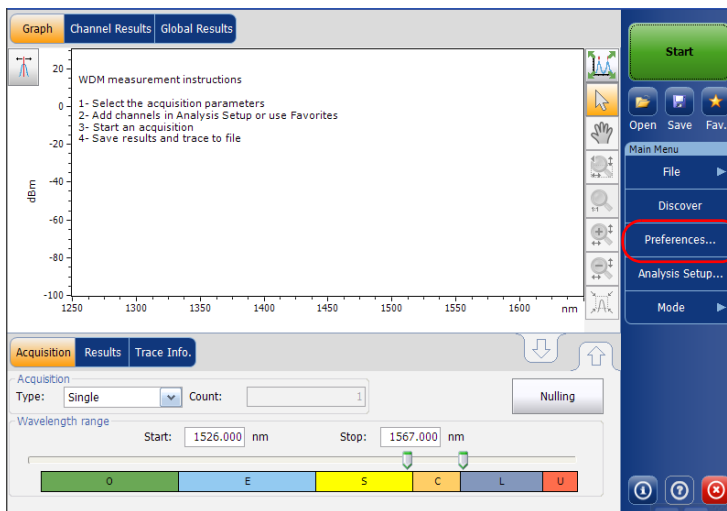

2. Select the **Comments** tab.

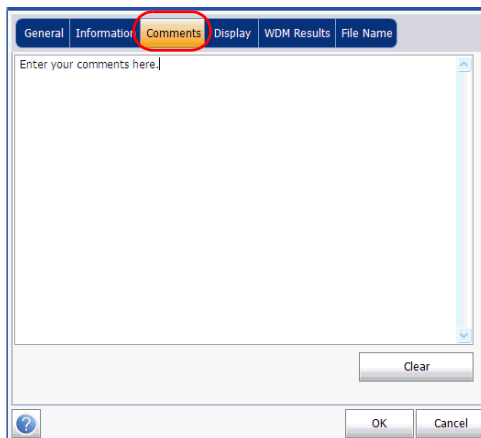

3. Enter your comments for the current trace.
4. Press **OK** to save the changes and close the window, or press **Cancel** to exit without saving.

Press **Clear** to clear all the changes made in the **Comments** tab.

Setting Up the Instrument in WDM Mode

Defining Preferences

Defining Display Parameters

The application allows you to set display settings for the acquisition trace. You can set the spectral unit for the trace and the results table. You can also select the label that should appear on the peaks of the trace.

To define display parameters:

1. From the **Main Menu**, press **Preferences**.

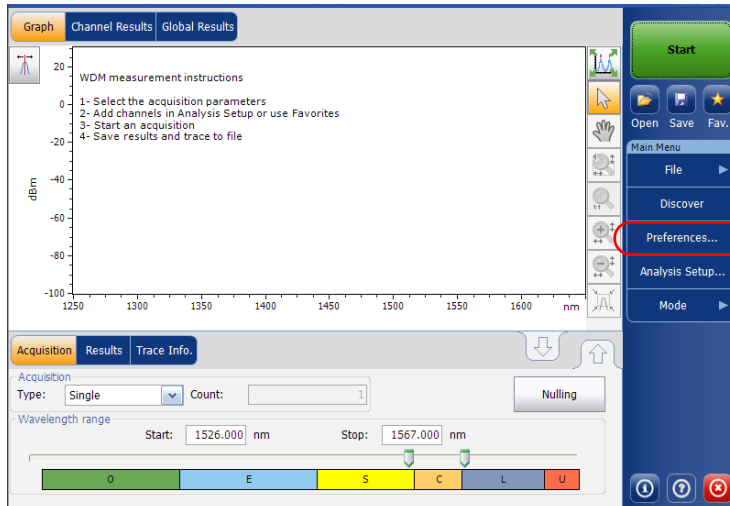

2. Select the **Display** tab.

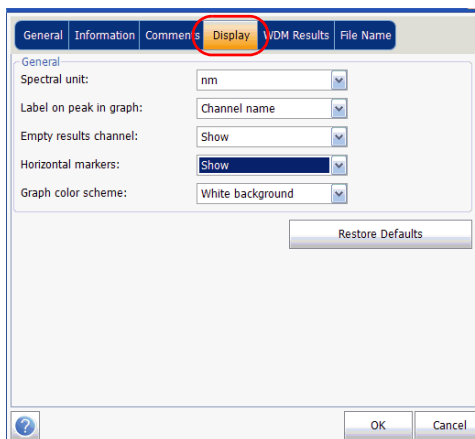

3. Select the spectral unit you want to work with, either nm or THz.

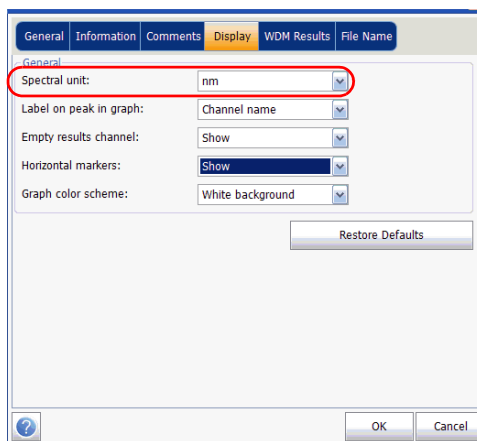

Setting Up the Instrument in WDM Mode

Defining Preferences

4. Select the label that will appear on the peaks in the graph, either the channel name, its number, or nothing.

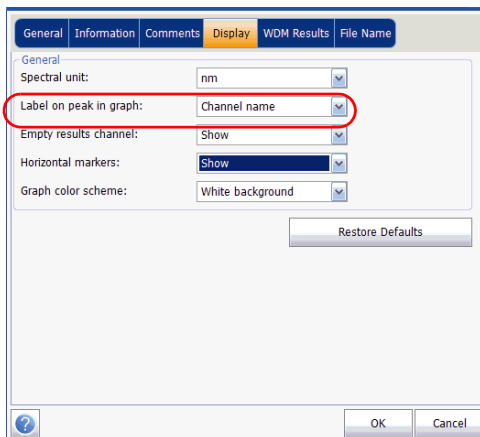

Setting Up the Instrument in WDM Mode

Defining Preferences

Note: The channel name and channel number cannot be shown at the same time.

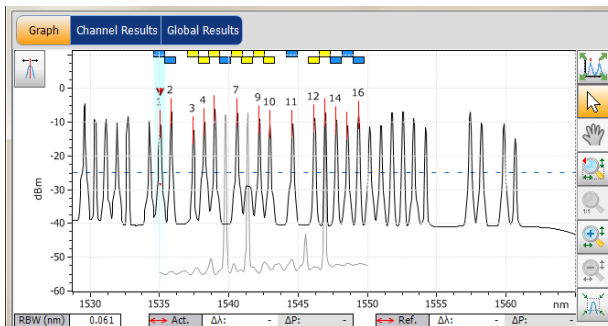

Channel numbers

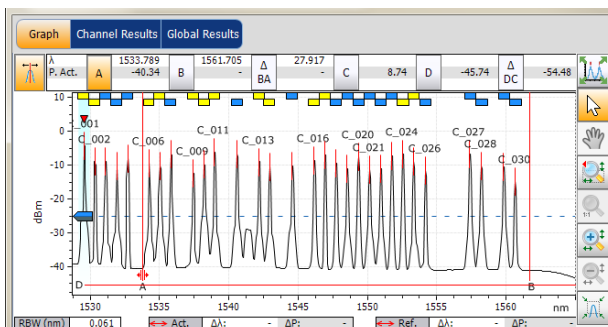

Defined channel names

Setting Up the Instrument in WDM Mode

Defining Preferences

5. Select whether you want to show or hide the empty channels from the channel list in the **Results** tab.

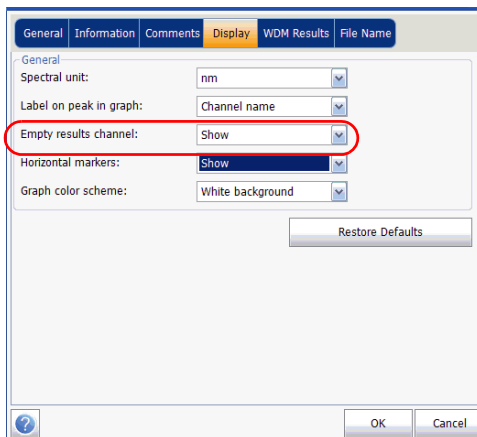

Note: When selected, empty channels are shown on screen and in the report files.

6. Select whether you want to show the horizontal markers or the integrated power and the Δ trace in the marker toolbar.

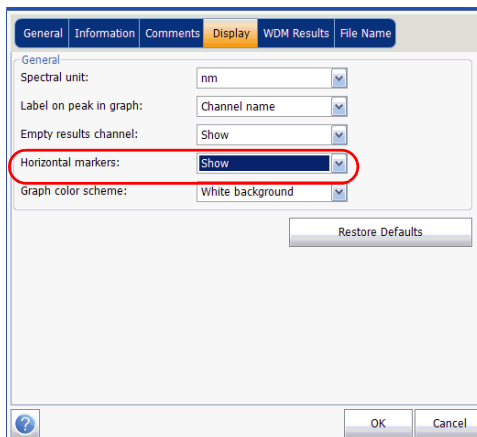

Setting Up the Instrument in WDM Mode

Defining Preferences

7. Select the background color scheme for the graph as desired.

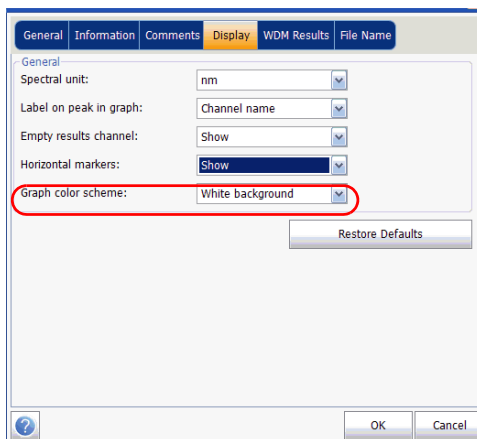

8. Press **OK** to save the changes and close the window, or press **Cancel** to exit without saving.

Press **Restore Defaults** to remove all the changes and apply the default values.

Customizing WDM Results Table

It is possible to select which results you would like to be displayed in the **Results** tab of your WDM tests.

To customize the results table:

1. From the **Main Menu**, press **Preferences**.

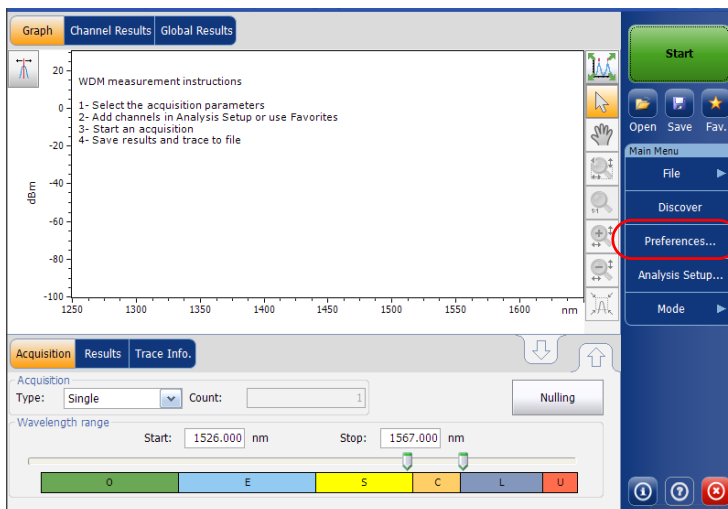

Setting Up the Instrument in WDM Mode

Defining Preferences

2. Select the **WDM Results** tab.

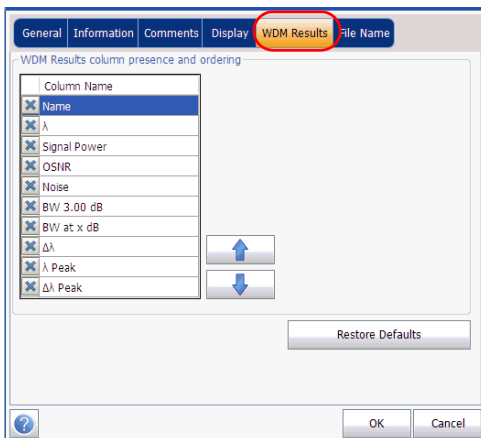

3. Select which parameters you want to display in the **Results** tab from the list of available choices:
 - Name: name of channel.
 - λ (Center wavelength/frequency): spectral center-of-mass for the peak in that channel.
 - Signal Power: signal power for the selected channel (excludes noise).
 - OSNR: optical signal to noise ratio, given by Signal power (according to the current calculation method, in dBm), minus Noise (according to the current calculation method, in dBm).
 - Noise: noise level for the selected channel. The type of noise is indicated in front of the measurement (IEC, Fit).
 - BW 3.00 dB: bandwidth measured by taking the width of a signal at 50 % linear power of the peak, or -3 dB from the peak.
 - BW at x dB: bandwidth measured by taking the width of a signal at x dB from the peak.

- $\Delta\lambda/f$: deviation of the spectral center of mass for the peak in that channel.
 - λ/f Peak: spectral peak in that channel.
 - $\Delta\lambda/f$ Peak: deviation of the spectral peak in that channel.
4. Press the up or down arrows to change the order in which the columns will appear in the **Results** tab.
 5. Press **OK** to save the changes and close the window, or press **Cancel** to exit without saving.

Press **Restore Defaults** to remove all the changes and apply the default values.

Setting Up WDM Analysis Parameters

This section presents the various analysis settings for the application, particularly the channel list and settings. You can set the default channel parameters, channel list, global thresholds, default channel thresholds, manage favorite configurations and perform user calibration.

Note: *When you change the analysis setup parameters, the new settings are active as soon as you confirm your choice. The current trace is re-analyzed, and the analysis setup parameters will be applied to the global results and channel results for the following acquisitions.*

You can either set each parameter individually, or use parameters from the current trace and import them.

Setting Up the Instrument in WDM Mode

Setting Up WDM Analysis Parameters

To import the parameters from the current trace:

1. Make sure that you have a trace on-screen.
2. From the **Main Menu**, press **Analysis Setup**.



Setting Up the Instrument in WDM Mode

Setting Up WDM Analysis Parameters

3. From any tab, press **Import from Trace**.

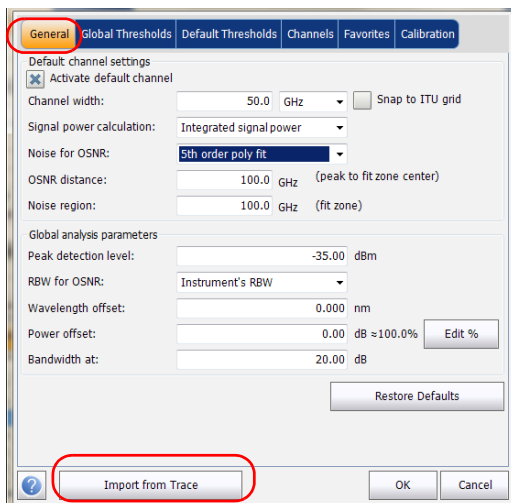

4. Press **OK** to confirm the changes.

Setting Up the Instrument in WDM Mode

Setting Up WDM Analysis Parameters

Defining General Settings

The general analysis parameters for WDM acquisitions affect the calculation of the results. Any change you make to the settings affect future traces, or you can apply them to the active trace when reanalyzing it.



IMPORTANT

In the General tab, you can set the default channel parameters. Any channel found during an acquisition that is not defined in the channel list will be analyzed according to the default channel settings.

To define general settings:

1. From the Main Menu, press Analysis Setup.

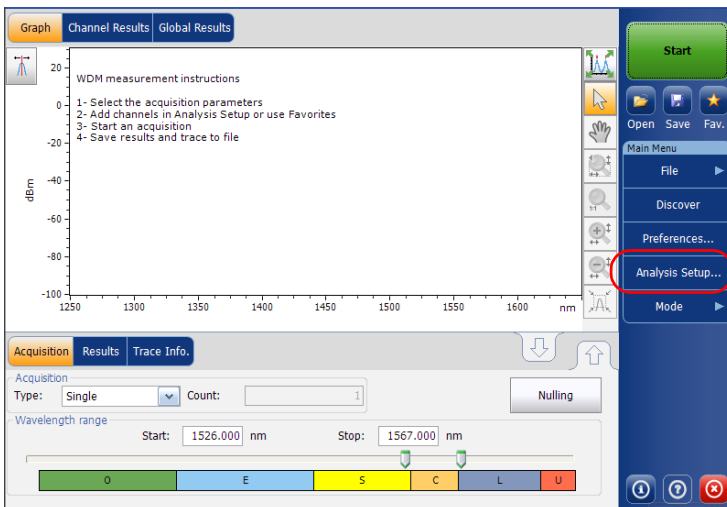

Setting Up the Instrument in WDM Mode

Setting Up WDM Analysis Parameters

2. Select the **General** tab.

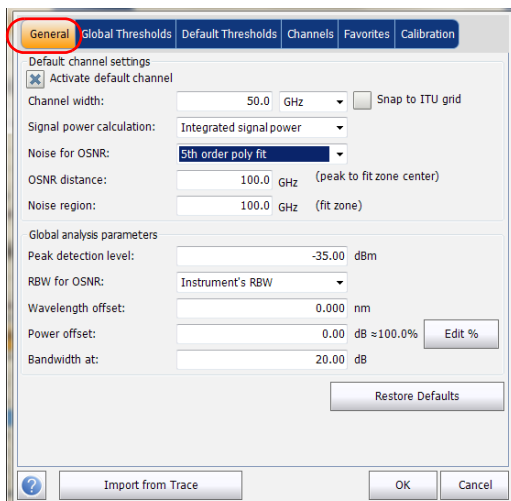

Setting Up the Instrument in WDM Mode

Setting Up WDM Analysis Parameters

- Under **Default channel settings**, define the following parameters as needed:

The screenshot shows the 'Default Thresholds' tab of the instrument's configuration window. The 'Default channel settings' section is highlighted with a red box. The 'Activate default channel' checkbox is checked. Other parameters include Channel width: 50.0 GHz, Signal power calculation: Integrated signal power, Noise for OSNR: 5th order poly fit, OSNR distance: 100.0 GHz, and Noise region: 100.0 GHz. The 'Global analysis parameters' section is also visible, showing Peak detection level: -35.00 dBm, RBW for OSNR: Instrument's RBW, Wavelength offset: 0.000 nm, Power offset: 0.00 dB ≈100.0%, and Bandwidth at: 20.00 dB. There is a 'Restore Defaults' button at the bottom right of the configuration area.

- Clear the **Activate default channel** option to use the currently defined channel list for analysis. This reduces the analysis time by eliminating the peak detection over the complete spectral range. The peaks outside the defined channel list will not be analyzed.

- Channel width (GHz or nm): indicates the limit inside which the power values will be considered in the channel.

For default channels, the channel width that sets the limits of the channel, should be the same as the channel distance or smaller (channel distance is defined while creating a channel list). If the channel width is not compatible with the channel spacing, either a single peak may be found for two distinct channels and two analysis would be performed and displayed for that peak, or, it is possible that two peaks may be found within the same channel and be considered as one multi-peak signal. With this result, you can use markers to find the spacing between adjacent channels or to find the channel width.

- Snap to ITU Grid: When selected, each detected peak will be defined by the nearest ITU channel. The ITU grid is based on the selected channel width.
- Signal power calculation: indicates which calculation method to apply for signal power value.

Integrated signal power: The integrated signal power represents the sum of the power values included between the channel limits of this channel, minus the estimated noise contribution between the same boundaries. In some cases, for instance CATV signals, signals with high-frequency modulation, or signals with an inherent line width similar or larger than the OSA/OCA's resolution bandwidth, this calculation becomes a better estimation of the true signal power.

Setting Up the Instrument in WDM Mode

Setting Up WDM Analysis Parameters

Peak signal power: The peak signal power represents the maximum power value inside the channel. Note that it differs a little from the peak measurement on the spectrum due to the fact that the estimated noise is subtracted to get the peak signal power.

Total channel power: The total channel power represents the sum of the integrated signal power and of the noise within the channel. The OSNR calculation is not performed when the signal power calculation type is the total channel power.

- **Noise for OSNR:** indicates which calculation method to use for OSNR value (InBand and InBand narrow filter are available for viewing or reanalysis purposes only when opening files from other OSA models).

Fixed range IEC based (IEC): The IEC method uses the interpolation of noise measured on both sides of the signal to estimate the noise level. The position at which the noise is estimated from the center wavelength is given by the OSNR distance.

InBand (InB): The InBand method uses a series of scans having different polarization states to calculate the noise level under the peak (InBand).

InBand narrow filter (InB nf): The InBand narrow filter method uses additional processing to provide an accurate OSNR value for the narrow carved noise. This is because with narrow filters, the noise level under the peak is not uniform and the OSNR value depends on the processing width selected.

Setting Up the Instrument in WDM Mode

Setting Up WDM Analysis Parameters

- *Fifth order polynomial fit (Fit)*: The fifth order polyfit method calculates the noise curve and thus the signal to noise ratio. The OSA will approximate the noise curve using a fifth order polynomial fit. This fit definition relies on fit and exclusion zones. Only the points in the fit zones are used to calculate the fifth order polynomial fit. If you select the fifth order polyfit method, you have to define the fit and exclusion zones for your tests using the OSNR distance and noise region fields. The exclusion zone is indirectly obtained from the OSNR distance.

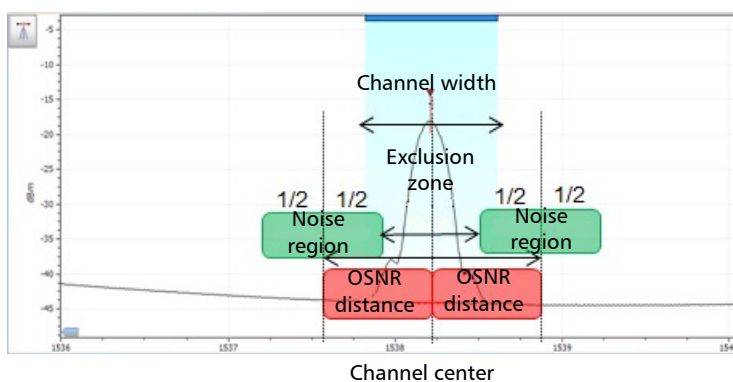

- OSNR distance (GHz or nm): Except for the fifth order polyfit selection, the OSNR distance is automatically set at the channel edge, that is, at half of the channel width from the center wavelength.

For the fifth order polyfit, the OSNR distance corresponds to the distance from the channel peak to the center of the fit zone. It is independent of the channel width.
- Noise region: The noise region, or fit zone, defines the region where the polynomial fit applies. Two identical regions are centered at the OSNR distance.

Setting Up the Instrument in WDM Mode

Setting Up WDM Analysis Parameters

4. Under **Global analysis parameters**, define the following parameters as needed:

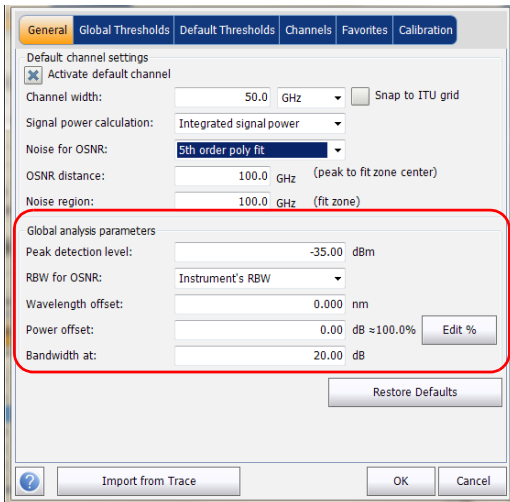

- Peak detection level (dBm): indicates the minimum power level from where the peak can be considered as a signal.
- RBW for OSNR (nm): indicates the resolution bandwidth selected for the OSNR calculation. This parameter is generally set to 0.1 nm to allow for a common basis of comparison between different OSA/OCA's having different effective resolutions. The instrument's RBW value is written below the graph. This parameter does not actually have an effect on the acquisition, but is only a normalization factor used to provide the OSNR value in a standardized manner.

- **Wavelength offset (nm):** indicates the offset value applied on the wavelength. This does not replace a calibration performed at EXFO, but it can help you temporarily sharpen the specifications if you have determined that, for example, your modules are used beyond the normal allowed use. Entering a value in THz is not possible. When an offset is applied, it is indicated at the bottom of the graph ($\lambda \leftrightarrow$).
- **Power offset (dB):** indicates the offset value applied on the power. This does not replace a calibration performed at EXFO, but it can help you achieve the specifications if you have determined that, for example, your modules are used beyond the normal allowed use. When an offset is applied, it is indicated at the bottom of the graph ($P \leftrightarrow$).

To edit the power offset as a tap percentage, press the **Edit %** button.

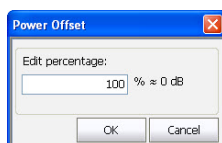

The percentage value entered in **Edit percentage** will be converted to a corresponding equivalent value in dB.

- **Bandwidth at (dB):** Set the power level used, relative to the channel peak power, to compute the second bandwidth result.
5. Press **OK** to save the changes and close the window, or press **Cancel** to exit without saving.

Press **Restore Defaults** to remove all the changes and apply the default values.

Setting Up the Instrument in WDM Mode

Setting Up WDM Analysis Parameters

Defining Global Thresholds

Any change you make to the global threshold settings affect future traces, or you can apply them to the active trace when reanalyzing it.

The application allows you to activate and deactivate the threshold functionality with a single control. When thresholds are globally enabled, the results are displayed with the Pass/Fail status based on various settings (global results, channel results). In addition, a global pass/fail status is also displayed in the **Global Results** tab (See *Global Results Tab* on page 184).

When thresholds are globally disabled, results are displayed without a Pass/Fail status and the Global pass/fail status will not be active in the **Global Results** tab. The **P/F** column under the results table will not be displayed.

The screenshot displays the software interface with the following components:

- Global Results Tab:** Contains a table of metrics and a 'Pass/fail status' section.
- Global Results Table:**

Global Results	
Channel count	38
Empty channel count	0
Average signal power	-18.67 dBm
Signal power flatness	7.50 dB
Average OSNR	28.24 dB
OSNR flatness	9.11 dB
Total power in scan range	-2.73 dBm
Global Analysis Parameters	
Peak detection level	-35.00 dBm
RBW for OSNR	0.065 nm
Wavelength offset	0.000 nm
Power offset	0.00 dB
Bandwidth at	20.00 dB
Default Channel Parameters	
- Pass/fail status:** A large text area displaying "Not Active".
- Trace Info Tab:** Contains acquisition parameters.

Trace Info	
Acquisition type:	InBand
Number of scans:	200
Spectral range start:	1520.000 nm
Spectral range stop:	1570.000 nm
User calibration:	Factory
Calibration date:	4/9/2009
Acquisition start time:	8/6/2009 6:42:35 AM
Acquisition stop time:	8/6/2009 6:44:56 AM
- Right Panel:** Includes a 'Start' button, 'Open Save Fav.' icons, a 'Main Menu' section with 'File', 'Discover', 'Preferences...', 'Analysis Setup...', and 'Mode' options, and a 'Trace Identification...' button at the bottom.

Setting Up the Instrument in WDM Mode

Setting Up WDM Analysis Parameters

You can set your pass/fail threshold limits in different ways depending on the type of test you are performing.

Threshold Limit	Definition
None	No threshold limit is set. The results will be displayed without a Pass/Fail verdict.
Min. only	The threshold limit is set for a minimum value only. The Pass/Fail verdict is declared as Pass (in green), when the value is equal to or greater than the minimum threshold set. The verdict is declared as Fail (in red), when the value is below the minimum threshold set.
Max. only	The threshold limit is set for a maximum value only. The Pass/Fail verdict is declared as Pass (in green), when the value is equal to or less than the maximum threshold set. The verdict is declared as Fail (in red), when the value is above the maximum threshold set.
Min. and Max.	The threshold limit is set for the minimum and maximum value. The Pass/Fail verdict is declared as Pass (in green), when the value is equal to or within the minimum and maximum thresholds set. The Pass/Fail verdict is declared as Fail (in red), when the value is beyond the minimum or maximum thresholds set.
Use Default	When this limit is set, the corresponding threshold set for the default channels in the Analysis Setup tab will be applied to the channel.
Max. Deviation	The threshold limit is set for the deviation value. The Pass/Fail verdict is declared as Pass (in green), when the value is equal to or within the deviation threshold set. The Pass/Fail verdict is declared as Fail (in red), when the value is beyond deviation threshold set.

Setting Up the Instrument in WDM Mode

Setting Up WDM Analysis Parameters

To define global thresholds:

1. From the **Main Menu**, press **Analysis Setup**.

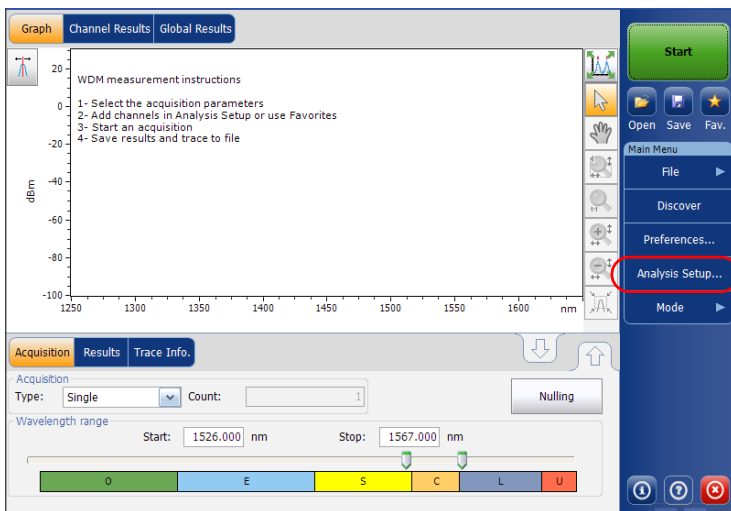

2. Select the **Global Thresholds** tab.

3. Select the **Activate all thresholds** option to manually set the global threshold values. If this option is not selected, all the thresholds will be deactivated, results are displayed without a Pass/Fail status and Global pass/fail status are not active in the **Global Results** tab.

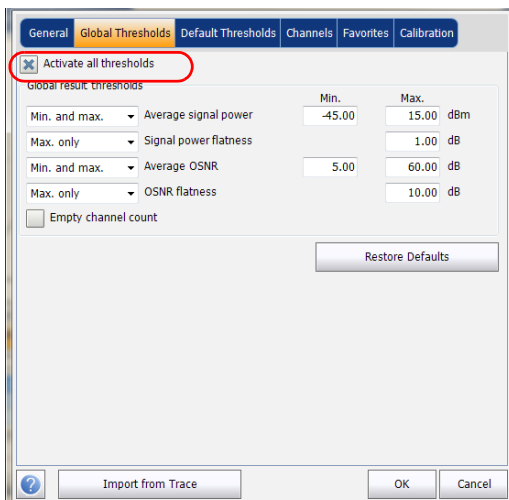

4. Enter values in the boxes as explained below:
 - Average signal power (dBm): the sum of the signal powers of all the peaks detected in the current acquisition, divided by the total number of peaks.
 - Signal power flatness (dB): the difference between the maximum and minimum signal power values of the detected peaks, in dB.
 - Average OSNR (dB): the sum of the entire OSNR of the peaks detected in the current acquisition, divided by the total number of peaks.
 - OSNR flatness (dB): the difference between the maximum and minimum OSNR values of the detected peaks, in dB.
 - Empty channel count: The number of empty channels from the channel list.

Setting Up the Instrument in WDM Mode

Setting Up WDM Analysis Parameters

5. Press **OK** to save the changes and close the window, or press **Cancel** to exit without saving.

Press **Restore Defaults** to remove all the changes and apply the default values.

Defining Default Thresholds

Default thresholds will be applied to any channel found outside the channel list during the acquisition or re-analysis.

Note: *The default thresholds settings are enabled only when the **Activate all thresholds** option is selected in the **Global Thresholds** tab. For more information, see Defining Global Thresholds on page 70.*

Setting Up the Instrument in WDM Mode

Setting Up WDM Analysis Parameters

You can set your pass/fail threshold limits in different ways depending on the type of test you are performing.

Threshold Limit	Definition
None	No threshold limit is set. The results will be displayed without a Pass/Fail verdict.
Min. only	The threshold limit is set for a minimum value only. The Pass/Fail verdict is declared as Pass (in green), when the value is equal to or greater than the minimum threshold set. The verdict is declared as Fail (in red), when the value is below the minimum threshold set.
Max. only	The threshold limit is set for a maximum value only. The Pass/Fail verdict is declared as Pass (in green), when the value is equal to or less than the maximum threshold set. The verdict is declared as Fail (in red), when the value is above the maximum threshold set.
Min. and Max.	The threshold limit is set for the minimum and maximum value. The Pass/Fail verdict is declared as Pass (in green), when the value is equal to or within the minimum and maximum thresholds set. The Pass/Fail verdict is declared as Fail (in red), when the value is beyond the minimum or maximum thresholds set.
Max. Deviation	The threshold limit is set for the deviation value. The Pass/Fail verdict is declared as Pass (in green), when the value is equal to or within the deviation threshold set. The Pass/Fail verdict is declared as Fail (in red), when the value is beyond deviation threshold set.

Setting Up the Instrument in WDM Mode

Setting Up WDM Analysis Parameters

To define default Thresholds:

1. From the Main Menu, press **Analysis Setup**.

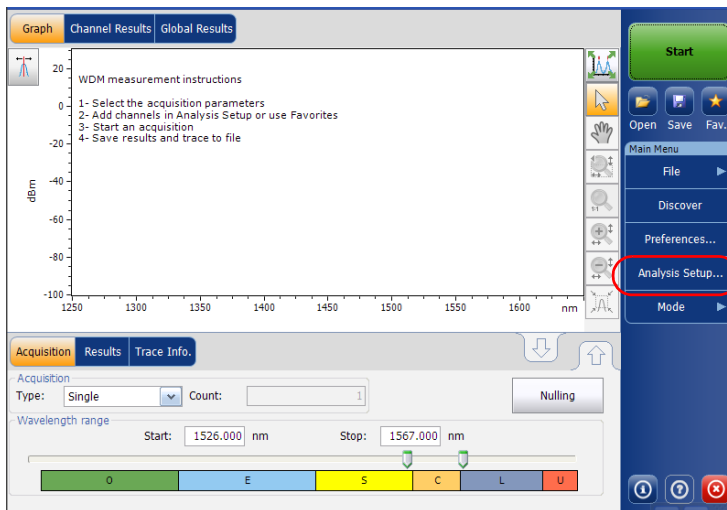

2. Select the **Default Thresholds** tab.

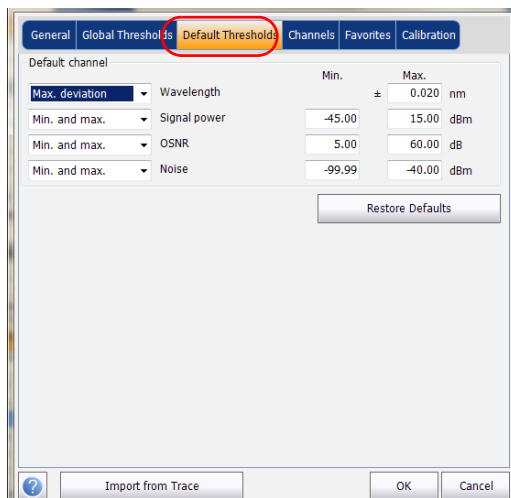

3. Enter values in the boxes as explained below:

- Wavelength/Frequency (nm/GHz): the channel's central wavelength/frequency.
- Signal power (dBm): the signal power for the default channel (excludes noise).
- Noise (dBm): the level of the noise for the selected channel.
- OSNR (dB): the optical signal to noise ratio, given by Signal power (according to the current calculation method, in dBm) minus Noise (according to the current calculation method, in dBm).

4. Press **OK** to save the changes and close the window, or press **Cancel** to exit without saving.

Press **Restore Defaults** to remove all the changes and apply the default values.

Setting Up the Instrument in WDM Mode

Setting Up WDM Analysis Parameters

Managing Channels

Testing DWDM systems involves characterizing multiple signals in a link. The application allows you to define channels using a channel editor or quickly generate them from the current data. You can also rapidly create a list of equally spaced channels. Once a channel list is created, you can modify it as needed. You can edit the analysis parameters for one channel or multiple channels.

While creating the channel list, some channels may overlap. When the channel widths are specified in nm, two channels are considered to be overlapping when more than 1.2 GHz (approximately) of frequency range is common between the two channels.

To add a channel list:

1. From the **Main Menu**, press **Analysis Setup**.

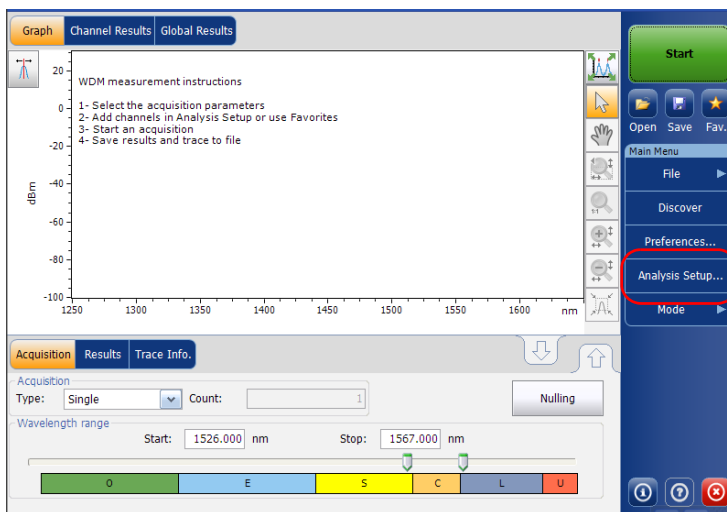

Setting Up the Instrument in WDM Mode

Setting Up WDM Analysis Parameters

2. Select the **Channels** tab.
3. By default, the channel list is empty. Press **Add Channels**.

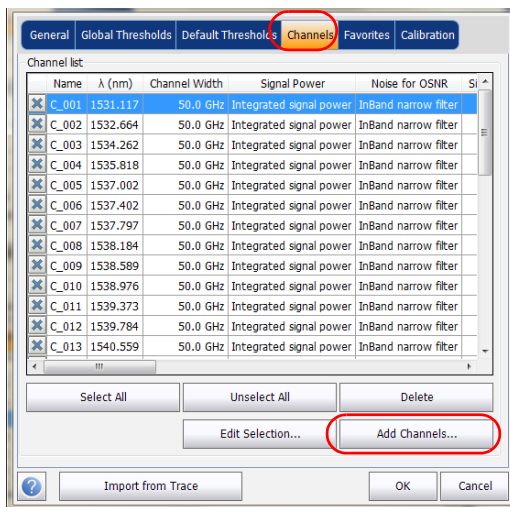

Setting Up the Instrument in WDM Mode

Setting Up WDM Analysis Parameters

4. Enter values in the boxes as explained below:

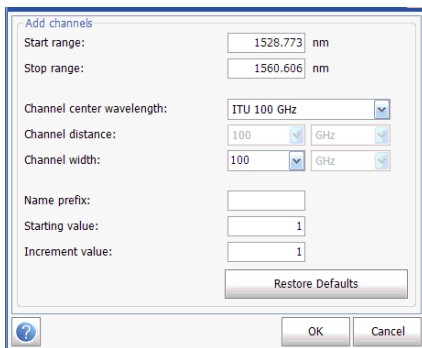

- Start range (nm or THz): starting range of the channel list.
- Stop range (nm or THz): ending range of the channel list.
- Channel center wavelength/frequency: spectral center-of-mass for the peak in that channel.

Note: When using the custom channel center wavelength option, the first channel will be centered at the Start Range, and the list will be created using channel distance and channel width.

- Channel distance (nm or GHz): distance between channels. The value of channel distance will be set depending on the selection made for the channel center wavelength option. The channel distance box will be enabled only when the channel center wavelength option is set to custom.
- Channel width (nm or GHz): limit inside which the power values will be considered in the channel. Integrated power is calculated on channel width.
- Name prefix: adds a prefix to the channel names.

Setting Up the Instrument in WDM Mode

Setting Up WDM Analysis Parameters

- Starting value: sets the increment starting value for the channel name in the channel list.
- Increment value: sets the increment value for the channel name in the channel list.

5. Press **OK** to return to the **Channels** window, which now lists the added channels.

Note: *When new channels are added, the **Use Default thresholds** selection will be applied to the channel parameters.*

Note: *A warning message will be displayed if channels are overlapping, but the analysis can still be performed on overlapping channels. If any duplicate channels are added, a confirmation message will be displayed to overwrite the existing channels with the duplicate channels.*

6. Press **OK** to save the changes and close the window, or press **Cancel** to exit without saving.

Note: *The application displays a message if more than 1000 channels are added. You can exit the **Analysis Setup** window only after deleting the extra channels from the channel list. You can delete the channels manually as required.*

Setting Up the Instrument in WDM Mode

Setting Up WDM Analysis Parameters

To edit the parameters of a specific channel:

1. From the **Main Menu**, press **Analysis Setup**.

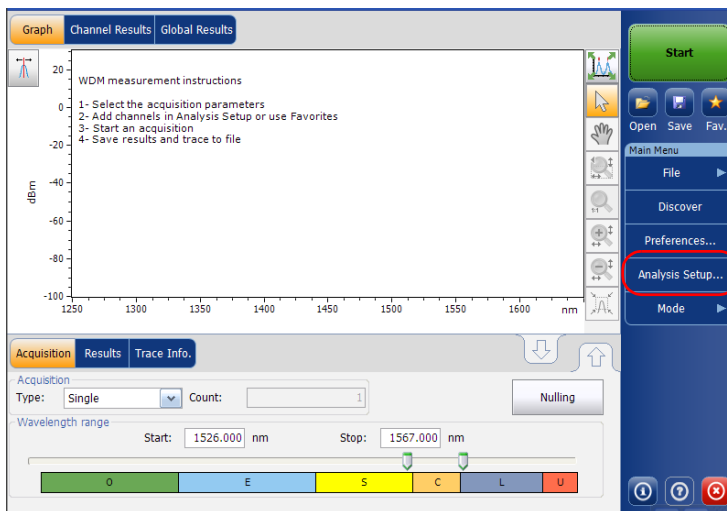

2. Select the **Channels** tab.

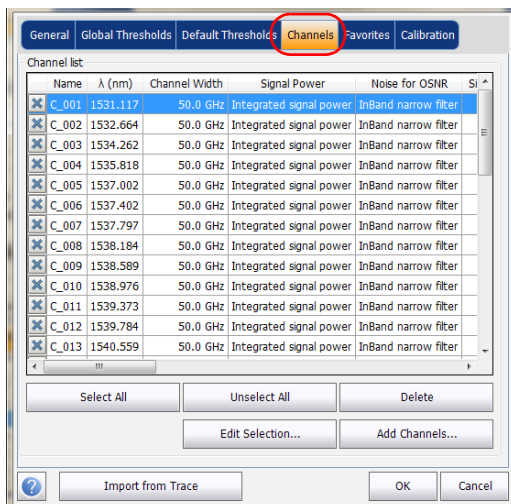

3. Select the channel or channels to be modified in the channel list.

If you want the changes to be applied to all of your channels, press **Select All**. Channels can be selected one by one or all together. You can press **Unselect All** to clear all channel selections. To delete the selected channels, press **Delete**.

Setting Up the Instrument in WDM Mode

Setting Up WDM Analysis Parameters

4. Press Edit Selection.

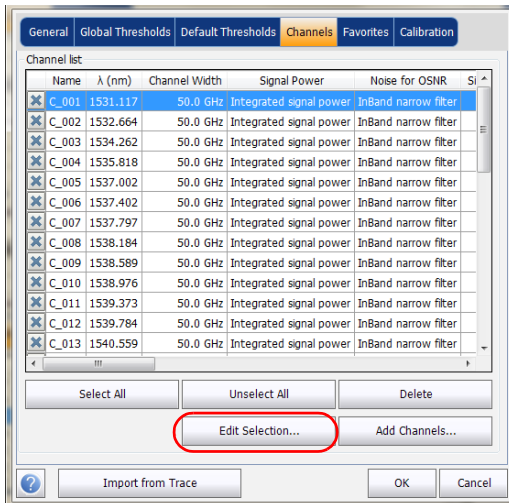

Setting Up the Instrument in WDM Mode

Setting Up WDM Analysis Parameters

5. Modify the settings as needed. For more information about the settings, see *Defining General Settings* on page 62 and *Defining Default Thresholds* on page 74. If you leave a box empty, it will remain as it was before your changes. Modify appropriate settings.

Channel center: THz Channel name:

Analysis

Channel width: GHz

Signal power calculation:

Noise for OSNR:

OSNR distance: GHz

Noise region: GHz

Thresholds

		Min.	Max.
<input type="text" value="Use default"/>	Frequency		<input type="text" value="2.5"/> GHz
<input type="text" value="Use default"/>	Signal power	<input type="text" value="-45.00"/>	<input type="text" value="15.00"/> dBm
<input type="text" value="Use default"/>	Noise	<input type="text" value="-99.99"/>	<input type="text" value="-40.00"/> dBm
<input type="text" value="Use default"/>	OSNR	<input type="text" value="5.00"/>	<input type="text" value="60.00"/> dB

6. Press **OK** to return to the **Channels** tab, which now contains the modified settings.
7. Press **OK** to save the changes and close the window, or press **Cancel** to exit without saving.

Setting Up Acquisition Parameters

Before performing your test, you must set the acquisition type and parameters.

There are three types of acquisitions in WDM mode:

- **Single:** Spectral measurement is performed once. The results are displayed according to this measurement.
- **Averaging:** Spectral measurements are performed based on the number of scans that you have entered for this parameter. The trace will be displayed after each acquisition and averaged with the previous traces.
- **Real-Time:** In real-time acquisition, spectral measurements are performed continuously until you press **Stop**. No averaging is done for spectral measurements. The graph and results are refreshed after each acquisition.

Setting Up the Instrument in WDM Mode

Setting Up Acquisition Parameters

Before performing measurements on an optical spectrum, you must select the wavelength/frequency range to use. You can perform the scan on the full range, on spectral bands, or select a custom range.

Note: *The shorter the wavelength or frequency range, the faster the acquisition.*

To set parameters in the Acquisition tab:

1. From the main window, select the **Acquisition** tab.

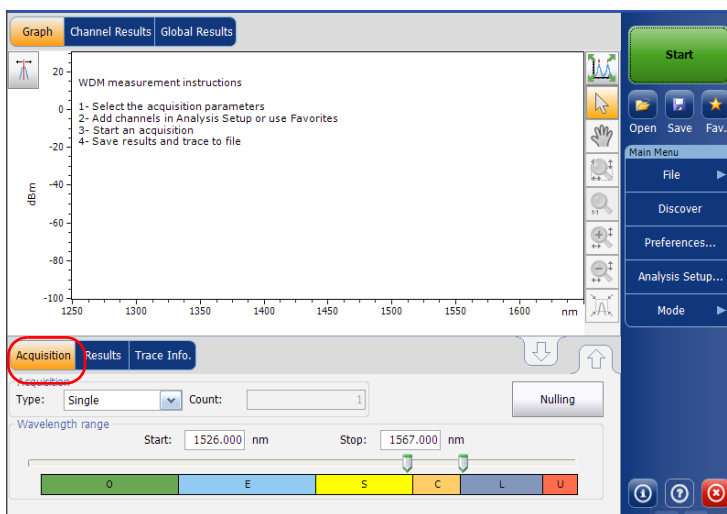

2. Select the acquisition type.

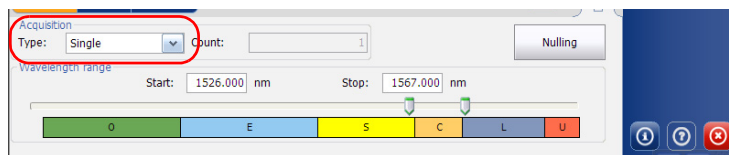

Setting Up the Instrument in WDM Mode

Setting Up Acquisition Parameters

3. If you are performing an averaging type acquisition, enter the number of scans the unit will perform.
4. Select the wavelength range for your acquisition.

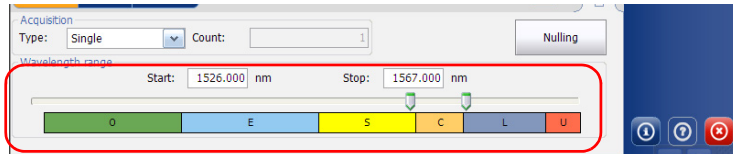

You can select the wavelength range by entering the start and stop values or by selecting a range on the double slider.

To select the wavelength range using the double slider, move the left and right handles on the double slider or simply click on any band.

Note: You can select more than one adjoining ranges to include in your range, for example, S + C.

The wavelength range covered within these bands of the spectra are listed below.

- O band (original): 1255 to 1365 nm
- E band (extended): 1355 to 1465 nm
- S band (short wavelengths): 1455 to 1535 nm
- C band (conventional “erbium window”): 1525 to 1570 nm
- L band (long wavelengths): 1560 to 1630 nm
- U band (ultralong wavelengths): 1620 to 1650 nm.

6 **Setting Up the Instrument in Drift Mode**

Note: *This mode is not available in the OCA application.*

Before performing a spectral analysis in the Drift mode, you must set up the test application with the appropriate parameters, as explained in this chapter.

Select the Drift test mode as explained in *Selecting a Test Mode* on page 18 before setting up the Drift test parameters.

- The *preferences* are the result displayed in the graph and tables, as well as the job information and related comments saved with each file.
- The *analysis parameters* include the channel list details, pass-fail threshold settings and allows you to select the noise and power calculation methods.
- The *acquisition parameters* include the type of measurement you want to perform and the wavelength range.

See *Defining Preferences* on page 93, *Setting Up Drift Analysis Parameters* on page 107 and *Setting Up Acquisition Parameters* on page 131 for more details.

Setting Up the Instrument in Drift Mode

You can set up your unit in different manners, depending on your testing needs.

- The preferred way is to use the complete analysis setup parameters and complete the information in all tables, as explained in *Setting Up Drift Analysis Parameters* on page 107. This setup will be used for the next acquisition.
- The easiest way to set up the instrument, especially when the operator does not know in advance what to expect at the input of the module is to use the **Discover** button. After the **Discover** button has been pressed, a measurement and analysis will be performed according to the best setup determined by the instrument and this setup will be used for the next scan. This is explained in *Using the Discover Feature* on page 155.
- The most efficient way to setup the instrument is to use one of the favorites configurations, uploading a pre-customized acquisition and analysis setup configuration. The operator in the field only has to press the  button, select the appropriate configuration and press **Start**. As an example, a pre-customized configuration could be: “32 channels DWDM 50GHz”; “Toronto-Montreal CWDM” or “Vendor ABC DWDM ROADM 40Gb”. This is explained in *Managing Favorites* on page 163.
- You can also import the setup from the current trace. This method will take the data and channel information from the current trace and apply them in the corresponding tabs. For more information, see *Setting Up Drift Analysis Parameters* on page 107.

Defining Preferences

The preferences window allows you to set general information and comments on trace, set display parameters and customize the drift results table.

Note: Only the **Display and Drift Results** tabs are available in offline mode.

Defining Trace Information

The trace information relates to the description of the job to be done, cable and job IDs, and any relevant information about what is being tested.

To enter general information:

1. From the **Main Menu**, press **Preferences**.

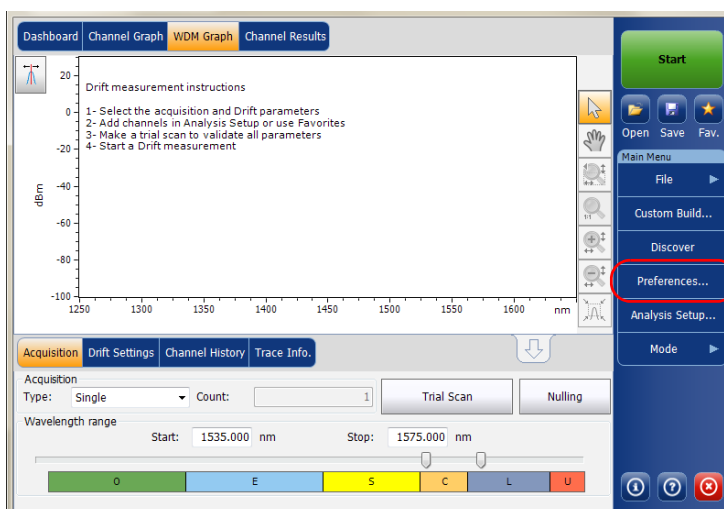

Setting Up the Instrument in Drift Mode

Defining Preferences

2. Select the **General** tab.

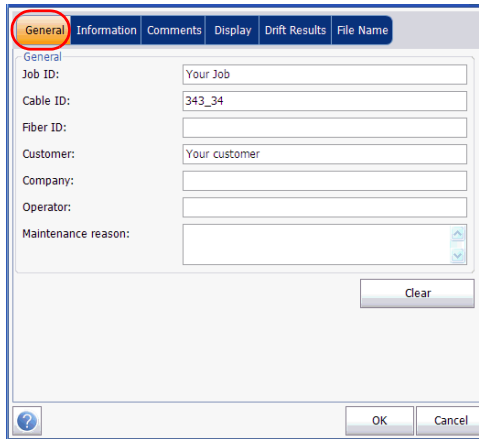

The screenshot shows a software window with a tabbed interface. The 'General' tab is selected and highlighted with a red circle. The window contains several input fields for defining preferences:

- Job ID: Your Job
- Cable ID: 343_34
- Fiber ID: (empty)
- Customer: Your customer
- Company: (empty)
- Operator: (empty)
- Maintenance reason: (empty dropdown menu)

At the bottom of the window, there are three buttons: a help button (question mark icon), an 'OK' button, and a 'Cancel' button. A 'Clear' button is also present in the lower right area of the form.

3. Define the general parameters as needed.
4. Press **OK** to save the changes and close the window, or press **Cancel** to exit without saving.

Press **Clear** to clear all the changes made in the **General** tab.

To enter link and location information:

1. From the Main Menu, press Preferences.

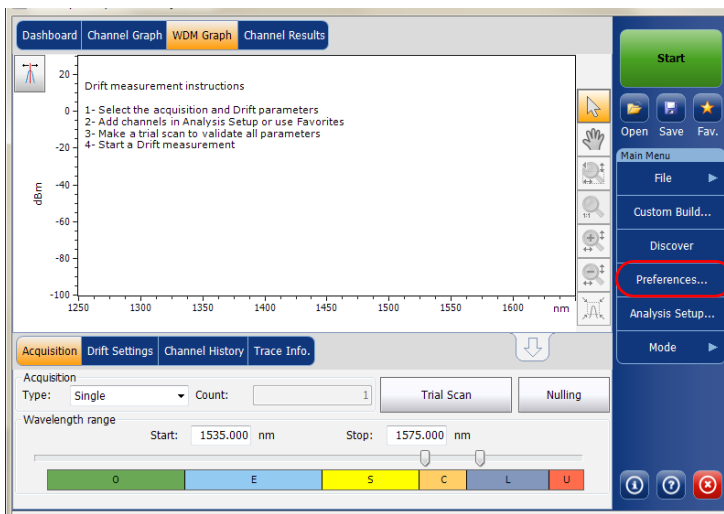

2. Select the Information tab.

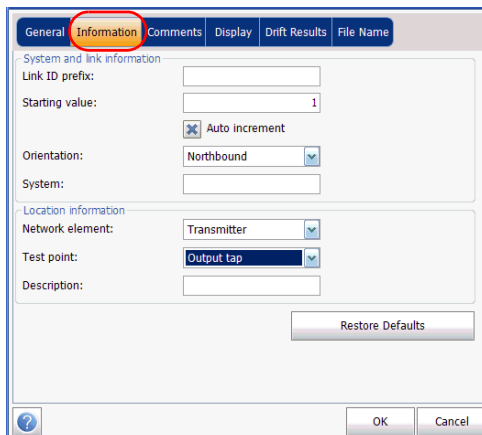

Setting Up the Instrument in Drift Mode

Defining Preferences

3. Under **System and link information**, define the following parameters as needed:

- **Link ID prefix:** prefix value for the link ID. You can enter any alphanumeric value.
- **Starting value:** suffix increment starting value for the link ID.

This value is incremented each time a new file is saved provided the **Auto Increment** option is selected.



IMPORTANT

If the **Auto Increment** option is not selected, you have to manually change the file name when saving the trace file, otherwise the application will overwrite the previously saved file.

- **Orientation:** orientation of the link.
 - **System:** information about the system under test.
4. Under **Location Information**, define the following parameters as needed:
 - **Network element:** Sets the type of network element.
 - **Test point:** Sets the location where the test is performed on the link.
 - **Description:** Enter the description of location if required.
 5. Press **OK** to save the changes and close the window, or press **Cancel** to exit without saving.

Press **Restore Defaults** to remove all the changes and apply the default values.

To enter comments:

1. From the **Main Menu**, press **Preferences**.

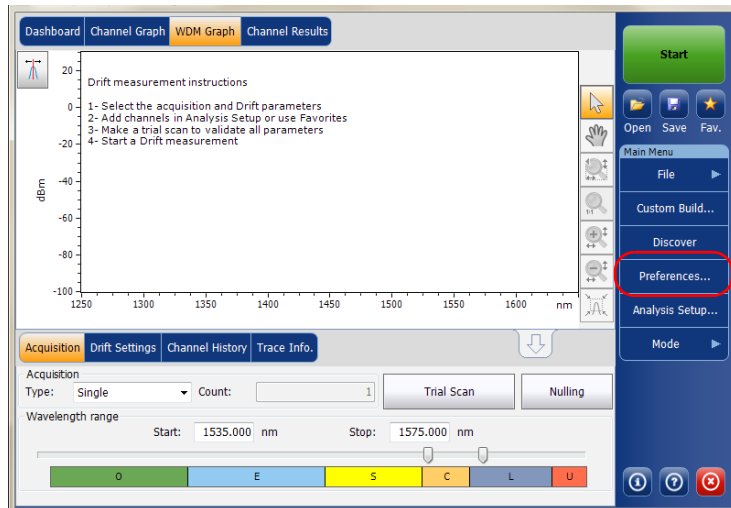

Setting Up the Instrument in Drift Mode

Defining Preferences

2. Select the **Comments** tab.

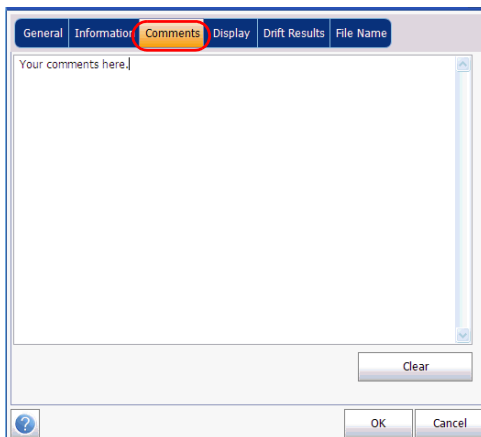

3. Enter your comments for the current trace.
4. Press **OK** to save the changes and close the window, or press **Cancel** to exit without saving.

Press **Clear** to clear all the changes made in the **Comments** tab.

Defining Display Parameters

The application allows you to set display settings for the acquisition trace. You can set the spectral unit for the trace and the results table. You can also select the label that should appear on the peaks of the trace.

To define display parameters:

1. From the **Main Menu**, press **Preferences**.

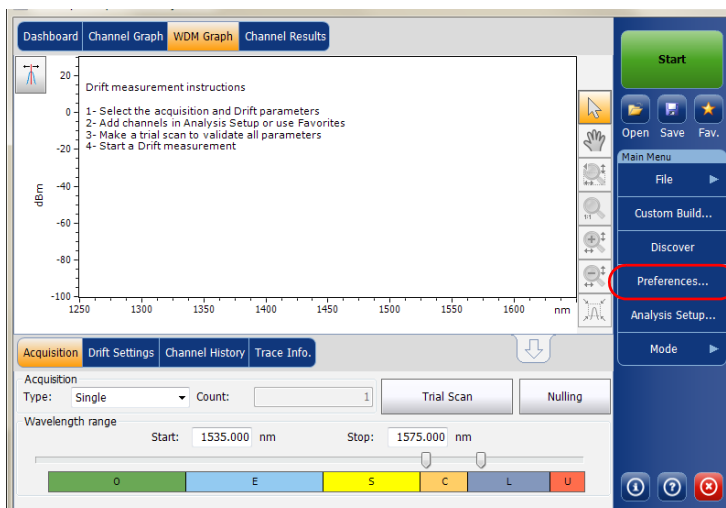

Setting Up the Instrument in Drift Mode

Defining Preferences

2. Select the **Display** tab.

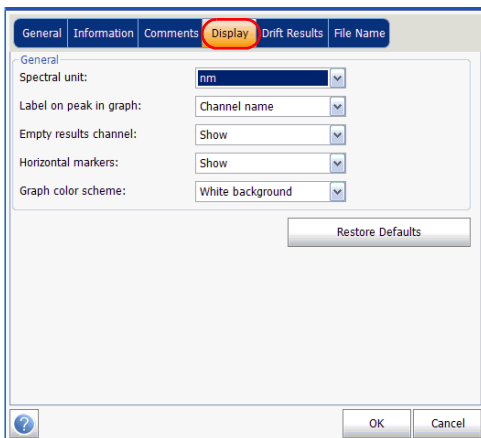

3. Select the spectral unit you want to work with, either nm or THz.

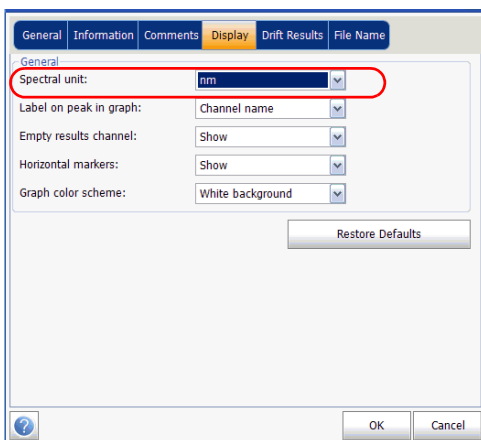

4. Select the label that will appear on the peaks in the graph, either the channel name, its number, or nothing.

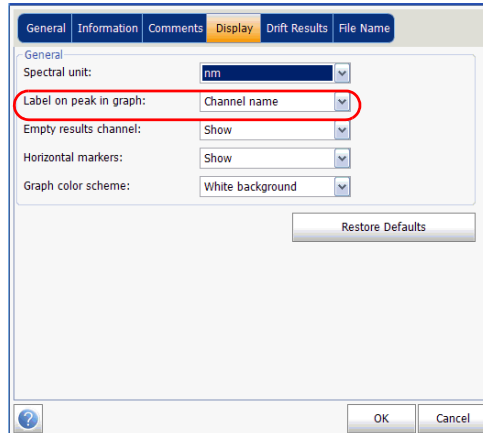

Setting Up the Instrument in Drift Mode

Defining Preferences

Note: The channel name and channel number cannot be shown at the same time.

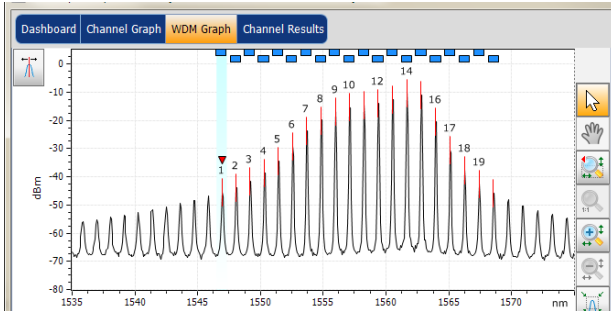

Channel numbers

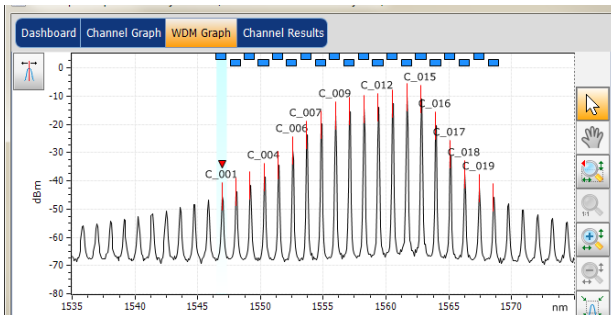

Defined channel names

5. Select whether you want to show or hide the empty channels from the channel list in the **Dashboard**, **Channel Graph**, **Channel Results** and **Channel History** tabs.

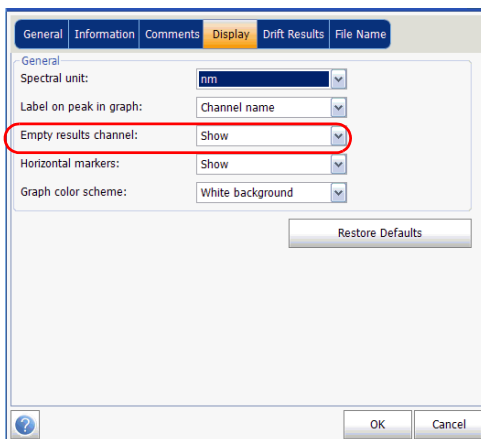

6. Select whether you want to show the horizontal markers or the integrated power trace in the marker toolbar.

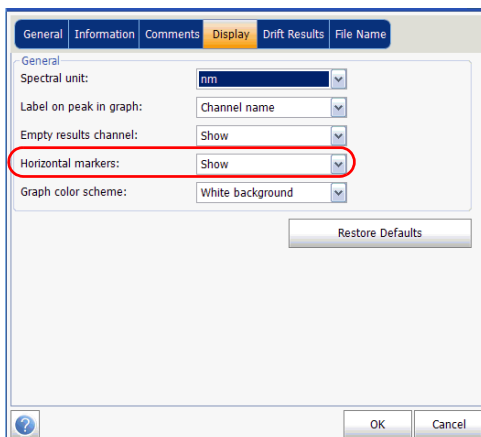

Setting Up the Instrument in Drift Mode

Defining Preferences

7. Select the background color scheme for the graph as desired.

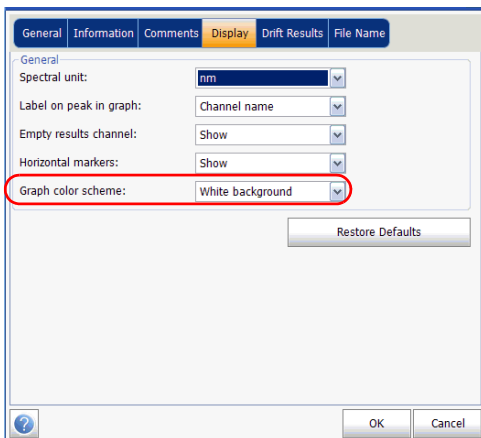

8. Press **OK** to save the changes and close the window, or press **Cancel** to exit without saving.

Press **Restore Defaults** to remove all the changes and apply the default values.

Customizing Drift Results Table

It is possible to select which results you would like to be displayed in the **Results** tab of your Drift tests.

To customize the results table:

1. From the **Main Menu**, press **Preferences**.

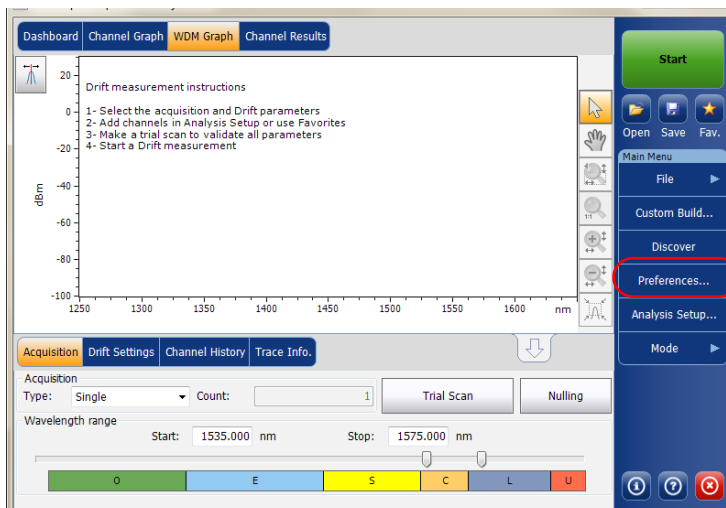

Setting Up the Instrument in Drift Mode

Defining Preferences

2. Select the **Drift Results** tab.

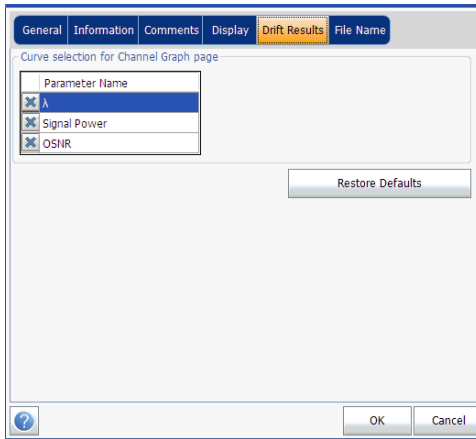

3. Select which parameters you want to display in the **Channel Graph** tab from the list of available choices:
 - Center wavelength/frequency: spectral center-of-mass for the peak in that channel.
 - Signal Power: signal power for the selected channel (excludes noise).
 - OSNR: Optical Signal to Noise Ratio, given by Signal power (according to the current calculation method, in dBm) minus Noise (according to the current calculation method, in dBm).
4. Press **OK** to save the changes and close the window, or press **Cancel** to exit without saving.

Press **Restore Defaults** to remove all the changes and apply the default values.

Setting Up Drift Analysis Parameters

This section presents the various analysis settings for the application, particularly the channel list and settings. These settings are applied on subsequent acquisitions. You can set the channel list, global thresholds, default channel thresholds, channel parameters, manage favorite configurations and perform user calibration.

Note: *The analysis setup parameters will be applied to the global results and channel results, upon the next acquisition.*

You can either set each parameter individually, or use parameters from the current trace and import them.

To import the parameters from the current trace:

1. Make sure that you have a trace on-screen.
2. From the **Main Menu**, press **Analysis Setup**.

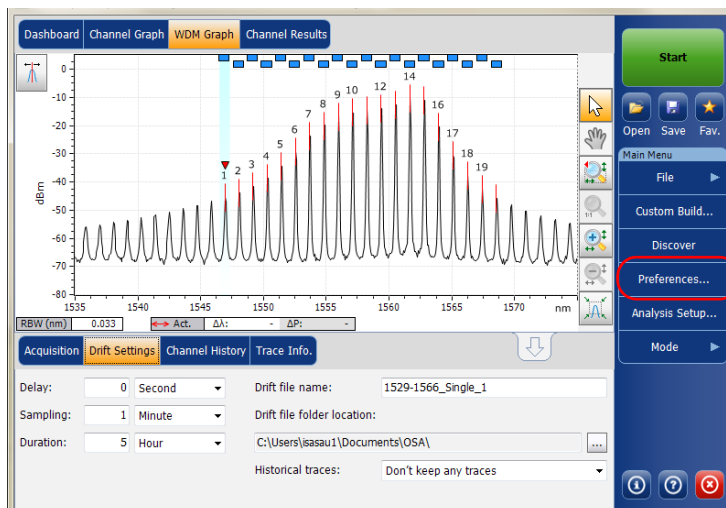

Setting Up the Instrument in Drift Mode

Setting Up Drift Analysis Parameters

3. From any tab, press **Import from Trace**.

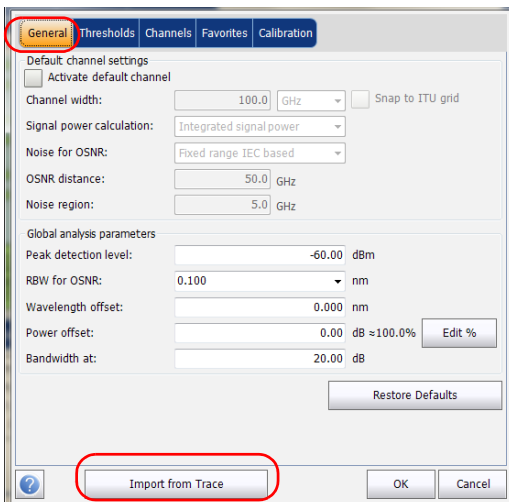

4. Press **OK** to confirm the changes.

Defining General Settings

The general analysis parameters for drift acquisitions affect the calculation of the results. These calculations take place after an acquisition. If these settings are modified, they will be applied to the next acquisition.



IMPORTANT

In the General tab, you can set the default channel parameters. Any channel found during an acquisition that is not defined in the channel list will be analyzed according to the default channel settings.

To define general settings:

1. From the Main Menu, press Analysis Setup.

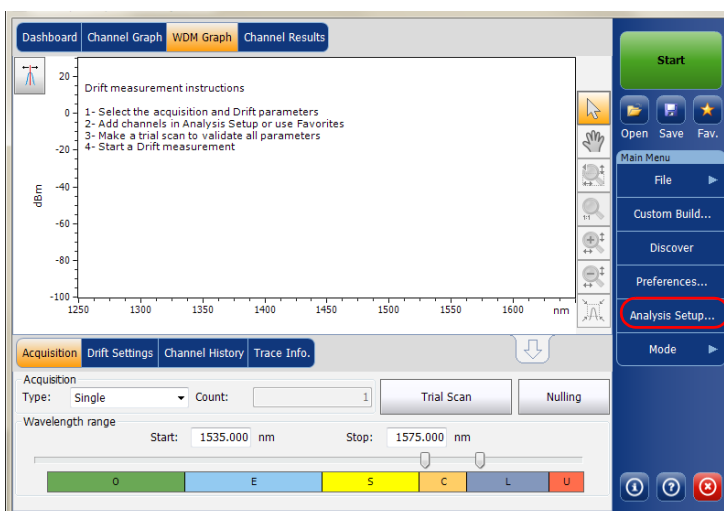

Setting Up the Instrument in Drift Mode

Setting Up Drift Analysis Parameters

2. Select the **General** tab.

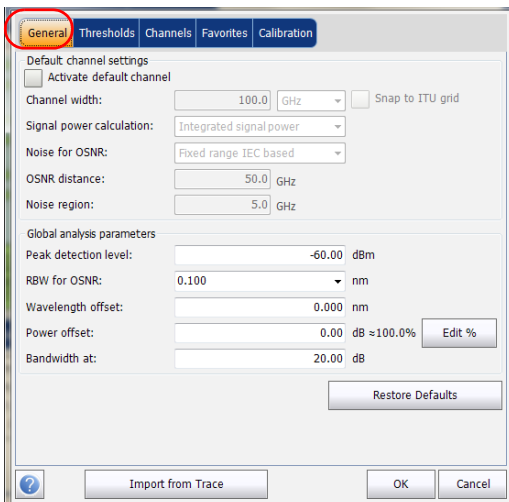

3. Under **Default channel settings**, define the following parameters as needed:

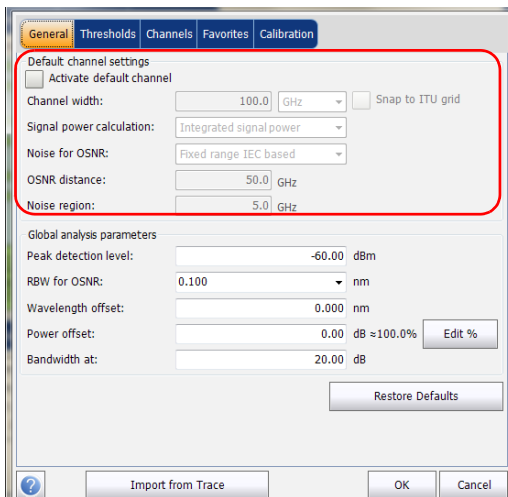

The screenshot shows a software interface with a 'General' tab selected. Under 'Default channel settings', the 'Activate default channel' checkbox is unchecked. The 'Channel width' is set to 100.0 GHz, and 'Snap to ITU grid' is unchecked. 'Signal power calculation' is set to 'Integrated signal power', 'Noise for OSNR' is 'Fixed range IEC based', 'OSNR distance' is 50.0 GHz, and 'Noise region' is 5.0 GHz. The 'Global analysis parameters' section includes 'Peak detection level' at -60.00 dBm, 'RBW for OSNR' at 0.100 nm, 'Wavelength offset' at 0.000 nm, 'Power offset' at 0.00 dB \approx 100.0% (with an 'Edit %' button), and 'Bandwidth at' at 20.00 dB. A 'Restore Defaults' button is located below these parameters. At the bottom of the window are buttons for 'Import from Trace', 'OK', and 'Cancel'.

- Clear the **Activate default channel** selection, to use the currently defined channel for analysis. This reduces the analysis time by eliminating the peak detection over the complete spectral range. The peaks outside the defined channel list will not be analyzed.

Setting Up the Instrument in Drift Mode

Setting Up Drift Analysis Parameters

- Channel width (GHz or nm): indicates the limit inside which the power values will be considered in the channel.

For default channels, the channel width that sets the limits of the channel, should be the same as the channel distance or smaller (channel distance is defined while creating a channel list). If the channel width is not compatible with the channel spacing, either a single peak may be found for two distinct channels and two analysis would be performed and displayed for that peak, or, it is possible that two peaks may be found within the same channel and be considered as one multi-peak signal. With this result, you can use markers to find the spacing between adjacent channels or to find the channel width.

- Snap to ITU Grid: When selected, each detected peak will be defined by the nearest ITU channel. The ITU grid is based on the selected channel width.
- Signal power calculation: indicates which calculation method to apply for signal power value.

Integrated signal power: The integrated signal power represents the sum of the power values included between the channel limits of this channel, minus the estimated noise contribution between the same boundaries. In some cases, for instance CATV signals, signals with high-frequency modulation, or signals with an inherent line width similar or larger than the OSA/OCA's resolution bandwidth, this calculation becomes a better estimation of the true signal power.

Peak signal power: The peak signal power represents the maximum power value inside the channel. Note that it differs a little from the peak measurement on the spectrum due to the fact that the estimated noise is subtracted to get the peak signal power.

Total channel power: The total channel power represents the sum of the integrated signal power and of the noise within the channel.

- **Noise for OSNR:** indicates which calculation method to use for OSNR value (InBand and InBand narrow filter are available for viewing or reanalysis purposes only when opening files from other OSA models).

Fixed range IEC based (IEC): The IEC method uses the interpolation of noise measured on both sides of the signal to estimate the noise level. The position at which the noise is estimated from the center wavelength is given by the OSNR distance.

InBand (InB): The InBand method uses a series of scans having different polarization states to calculate the noise level under the peak (InBand).

InBand narrow filter (InB nf): The InBand narrow filter method uses additional processing to provide an accurate OSNR value for the narrow carved noise. This is because with narrow filters, the noise level under the peak is not uniform and the OSNR value depends on the processing width selected.

Setting Up the Instrument in Drift Mode

Setting Up Drift Analysis Parameters

Fifth order polynomial fit (Fit): The fifth order polyfit method calculates the noise curve and thus the signal to noise ratio. The OSA will approximate the noise curve using a fifth order polynomial fit. This fit definition relies on fit and exclusion zones. Only the points in the fit zones are used to calculate the fifth order polynomial fit. If you select the fifth order polyfit method, you will have to define the fit and exclusion zones for your tests using the OSNR distance and noise region fields. The exclusion zone is indirectly obtained from the OSNR distance.

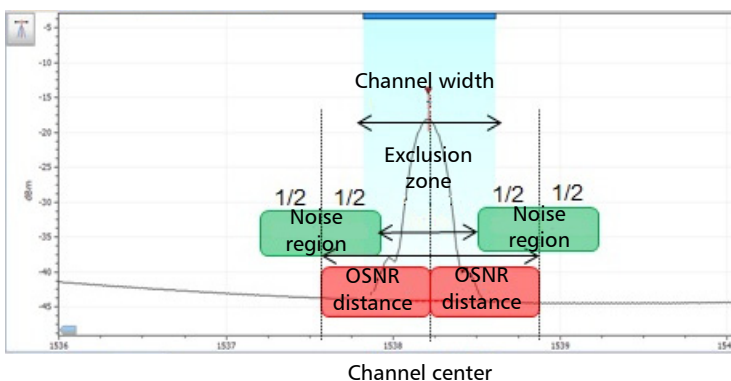

- OSNR distance (GHz or nm): Except for the fifth order polyfit selection, the OSNR distance is automatically set at the channel edge, that is, at half of the channel width from the center wavelength.

For the fifth order polyfit, the OSNR distance corresponds to the distance from the channel peak to the center of the fit zone. It is independent of the channel width.

- Noise region: The noise region, or fit zone, defines the region where the polynomial fit applies. Two identical regions are centered at the OSNR distance.

4. Under **Global analysis parameters**, define the following parameters as needed:

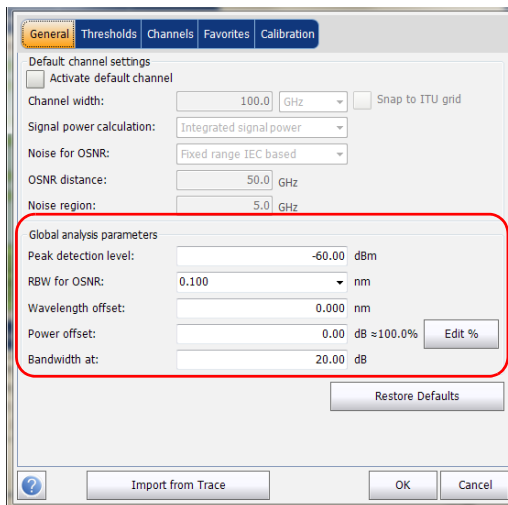

The screenshot shows a configuration dialog box with several tabs: General, Thresholds, Channels, Favorites, and Calibration. The 'General' tab is active. Under 'Default: channel settings', there are options for 'Activate default channel', 'Channel width' (100.0 GHz), 'Signal power calculation' (Integrated signal power), 'Noise for OSNR' (Fixed range IEC based), 'OSNR distance' (50.0 GHz), and 'Noise region' (5.0 GHz). A red box highlights the 'Global analysis parameters' section, which includes: 'Peak detection level' (-60.00 dBm), 'RBW for OSNR' (0.100 nm), 'Wavelength offset' (0.000 nm), 'Power offset' (0.00 dB \approx 100.0%), and 'Bandwidth at' (20.00 dB). There are also buttons for 'Restore Defaults', 'Import from Trace', 'OK', and 'Cancel'.

- Peak detection level (dBm): indicates the minimum power level from where the peak can be considered as a signal.
- RBW for OSNR (nm): indicates the resolution bandwidth selected for the OSNR calculation. This parameter is generally set to 0.1 nm to allow for a common basis of comparison between different OSA/OCA's having different effective resolutions. The instrument's RBW value is written below the graph. This parameter does not actually have an effect on the acquisition, but is only a normalization factor used to provide the OSNR value in a standardized manner.

Setting Up the Instrument in Drift Mode

Setting Up Drift Analysis Parameters

- ▶ Wavelength offset (nm): indicates the offset value applied on the wavelength. This does not replace a calibration performed at EXFO, but it can help you temporarily sharpen the specifications if you have determined that, for example, your modules are used beyond the normal allowed use. Entering a value in THz is not possible. When an offset is applied, it is indicated at the bottom of the graph ($\lambda \leftrightarrow$).
- ▶ Power offset (dB): indicates the offset value applied on the power. This does not replace a calibration performed at EXFO, but it can help you achieve the specifications if you have determined that, for example, your modules are used beyond the normal allowed use. When an offset is applied, it is indicated at the bottom of the graph (P \leftrightarrow).

To edit the power offset as a tap percentage, press the **Edit %** button.

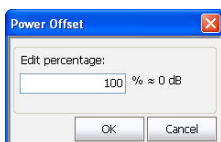

The percentage value entered in **Edit percentage** will be converted to a corresponding equivalent value in dB.

- ▶ Bandwidth at (dB): Set the power level used, relative to the channel peak power, to compute the bandwidth.
5. Press **OK** to save the changes and close the window, or press **Cancel** to exit without saving.

Press **Restore Defaults** to remove all the changes and apply the default values.

Defining Default Channel Thresholds

The thresholds will be applied to any channel found outside the channel list during the next acquisition. Thresholds will be applied to the channel results during the next acquisition.

The application allows you to activate and deactivate the threshold functionality with a single control. When thresholds are globally enabled, the results are displayed with the Pass/Fail status based on various settings.

When thresholds are globally disabled, results are displayed without a Pass/Fail status in the **Channel Graph** and **Channel History** tabs.

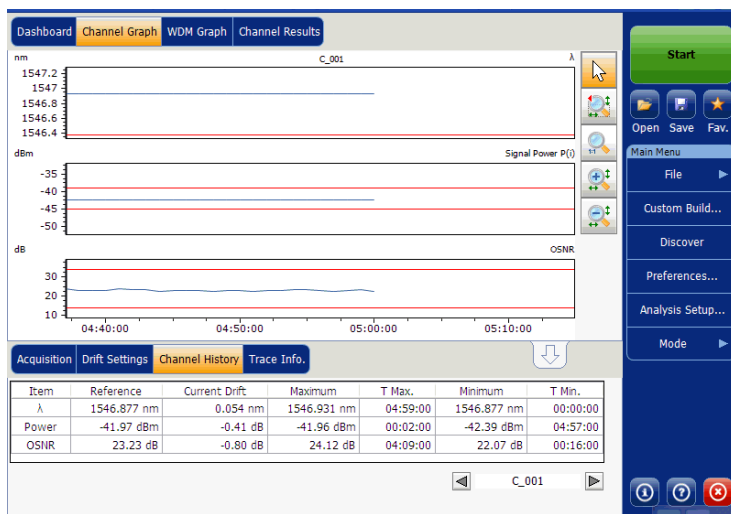

Setting Up the Instrument in Drift Mode

Setting Up Drift Analysis Parameters

When thresholds are globally disabled, the results in the **Channel Results** tab are also displayed without a Pass/Fail status.

Channel Results	
Channel number	1
Channel name	C_001
▲ Channel Results	
Center wavelength	1546.931 nm
Signal power	(I) -42.39 dBm
OSNR	22.43 dB
Noise	(IEC) -64.81 dBm
Bandwidth 3.00 dB	0.053 nm
Bandwidth 20.00 dB	0.352 nm
ENBW	0.033 nm
▲ Global Results	
Ref. empty channel count	0
▲ Global Analysis Parameters	
Peak detection level	-60.00 dBm
RBW for OSNR	0.100 nm

Setting Up the Instrument in Drift Mode

Setting Up Drift Analysis Parameters

You can set your pass/fail threshold limits in different ways depending on the type of test you are performing.

Threshold Limit	Definition
None	No threshold limit is set. The results will be displayed without a Pass/Fail verdict.
Min only	The threshold limit is set for a minimum value only. The Pass/Fail verdict is declared as Pass (in green), when the value is equal to or greater than the minimum threshold set. The verdict is declared as Fail (in red), when the value is below the minimum threshold set.
Max only	The threshold limit is set for a maximum value only. The Pass/Fail verdict is declared as Pass (in green), when the value is equal to or less than the maximum threshold set. The verdict is declared as Fail (in red), when the value is above the maximum threshold set.
Min and Max	The threshold limit is set for the minimum and maximum value. The Pass/Fail verdict is declared as Pass (in green), when the value is equal to or within the minimum and maximum thresholds set. The Pass/Fail verdict is declared as Fail (in red), when the value is beyond the minimum or maximum thresholds set.
Max. Deviation	The threshold limit is set for the deviation value. The Pass/Fail verdict is declared as Pass (in green), when the value is equal to or within the deviation threshold set. The Pass/Fail verdict is declared as Fail (in red), when the value is beyond deviation threshold set.

Setting Up the Instrument in Drift Mode

Setting Up Drift Analysis Parameters

To define the default channel thresholds:

1. From the Main Menu, press **Analysis Setup**.

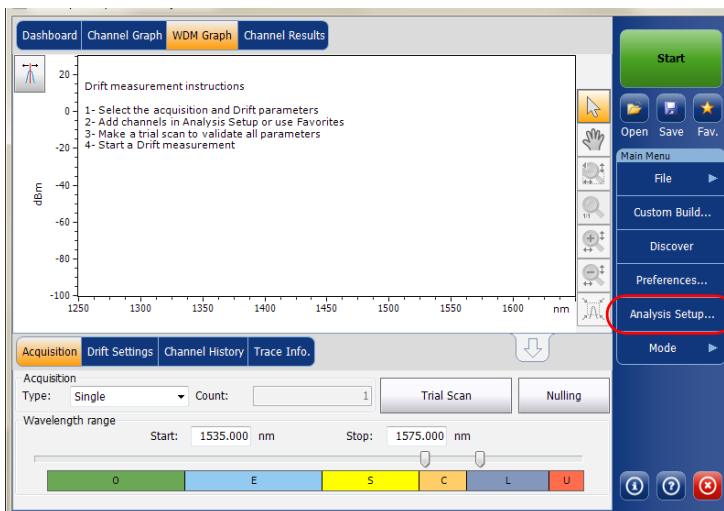

2. Select the **Thresholds** tab.

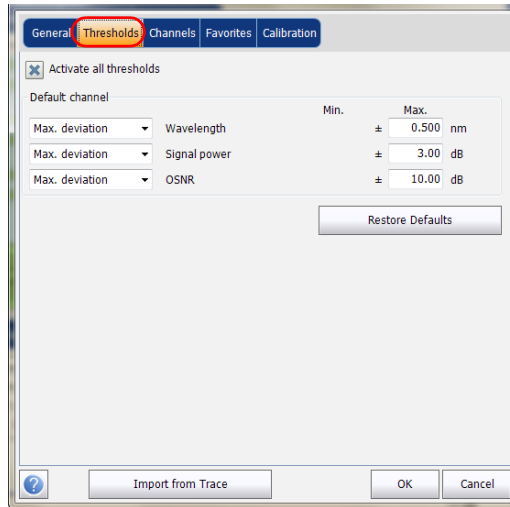

Setting Up the Instrument in Drift Mode

Setting Up Drift Analysis Parameters

3. Select the **Activate all thresholds** option to manually set the channel threshold values. If this option is not selected, all the thresholds will be deactivated, results are displayed without a Pass/Fail status in the **Channel Graph**, **Channel History** and **Channel Results** tabs.

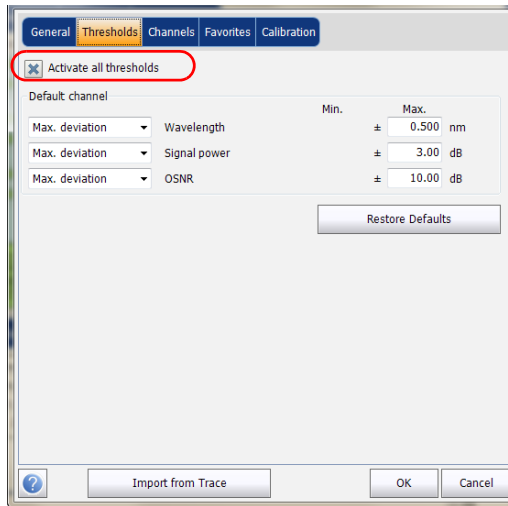

4. Enter values in the boxes as explained below:
 - Wavelength/Frequency (nm/GHz): central wavelength/frequency of the channel.
 - Signal power (dBm): signal power for the selected channel (excludes noise).
 - OSNR (dB): Optical Signal to Noise Ratio, given by Signal power (according to the current calculation method, in dBm) minus Noise (according to the current calculation method, in dBm).
5. Press **OK** to save the changes and close the window, or press **Cancel** to exit without saving.

Press **Restore Defaults** to remove all the changes and apply the default values.

Managing Channels

Testing DWDM systems involves characterizing multiple signals in a link. The application allows you to define channels using a channel editor or quickly generate them from the current data. You can also rapidly create a list of equally spaced channels. Once a channel list is created, you can modify it as needed. You can edit the analysis parameters for one channel or multiple channels.

While creating the channel list, some channels may overlap. When the channel widths are specified in nm, two channels are considered to be overlapping when more than 1.2 GHz (approximately) of frequency range is common between the two channels.

To add a channel list:

1. From the **Main Menu**, press **Analysis Setup**.

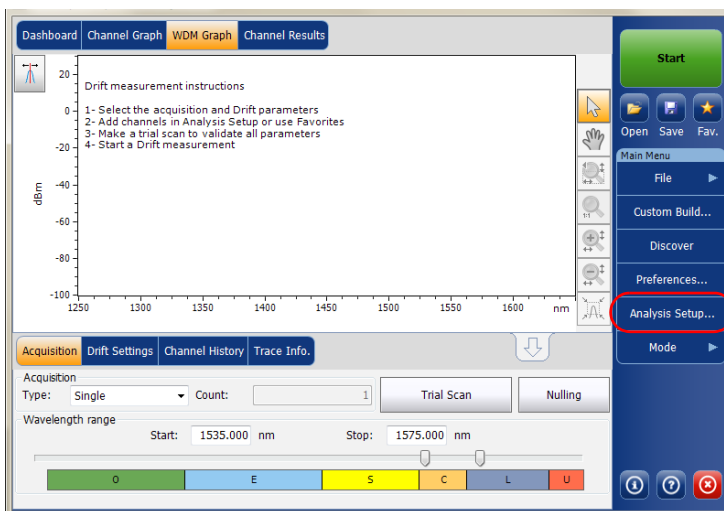

Setting Up the Instrument in Drift Mode

Setting Up Drift Analysis Parameters

2. Select the **Channels** tab.
3. By default, the channel list is empty. Press **Add Channels**.

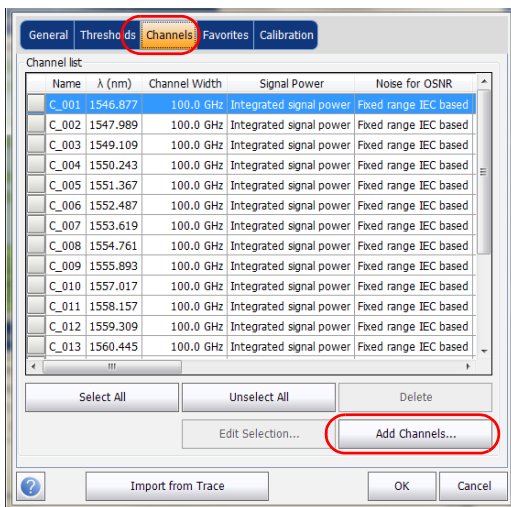

4. Enter values in the boxes as explained below:

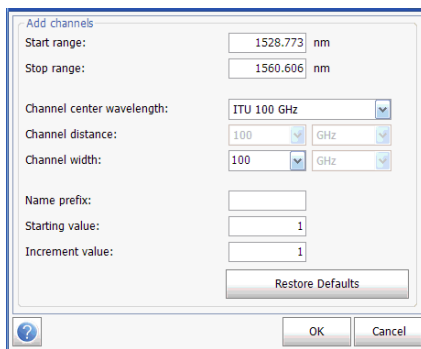

- Start range (nm or THz): starting range of the channel list.
- Stop range (nm or THz): ending range of the channel list.
- Channel center wavelength/frequency: spectral center-of-mass for the peak in that channel.

Note: When using the custom channel center wavelength option, the first channel will be centered at the Start Range, and the list will be created using channel distance and channel width.

Setting Up the Instrument in Drift Mode

Setting Up Drift Analysis Parameters

- Channel distance (nm or GHz): distance between the channels. The value of channel distance will be set depending on the selection made for the channel center wavelength option. The channel distance box will be enabled only when the channel center wavelength option is set to custom.
 - Channel width (nm or GHz): limit inside which the power values will be considered in the channel. Integrated power is calculated on channel width.
 - Name prefix: adds prefix to the channel names.
 - Starting Value: increment starting value for the channel name in the channel list.
 - Increment value: increment value for the channel name in the channel list.
5. Press **OK** to return to the **Channels** window, which now lists the added channels.

Note: *When new channels are added, the Use Default thresholds will be applied to the channel parameters.*

Note: *A warning message will be displayed if any channels are overlapping, but the analysis can still be performed on overlapping channels. If any duplicate channels are added, a confirmation message will be displayed to overwrite the existing channels with the duplicate channels.*

6. Press **OK** to save the changes and close the window, or press **Cancel** to exit without saving.

Note: *The application displays a message if more than 1000 channels are added. You can exit the **Analysis Setup** window only after deleting the extra channels from the channel list. You can delete the channels manually as required.*

Setting Up the Instrument in Drift Mode

Setting Up Drift Analysis Parameters

To edit the parameters of a specific channel:

1. From the **Main Menu**, press **Analysis Setup**.

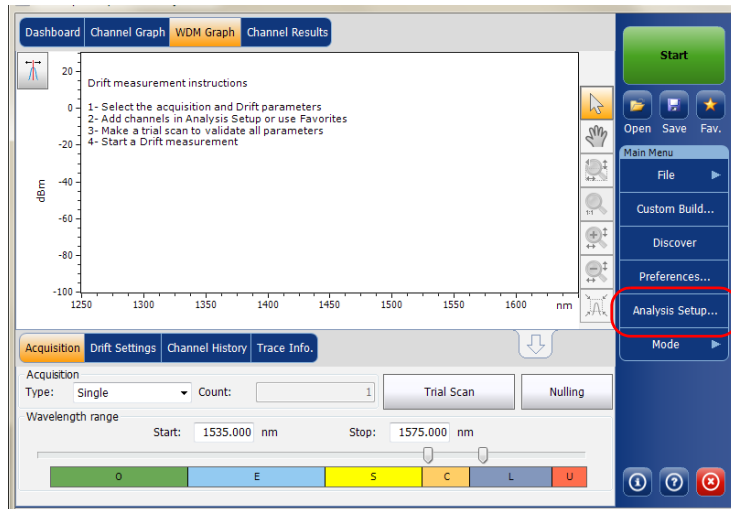

Setting Up the Instrument in Drift Mode

Setting Up Drift Analysis Parameters

2. Select the Channels tab.

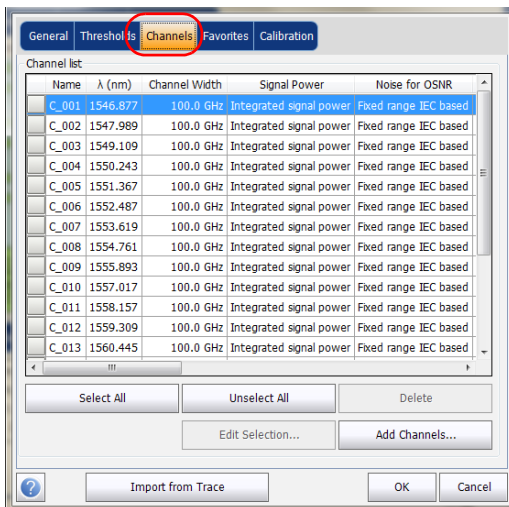

3. Select the channel or channels to be modified in the channel list.

If you want the changes to be applied to all of your channels, press **Select All**. Channels can be selected one by one or all together. You can press **Unselect All** to clear all channel selections. To delete the selected channels, press **Delete**.

4. Press **Edit Selection**.

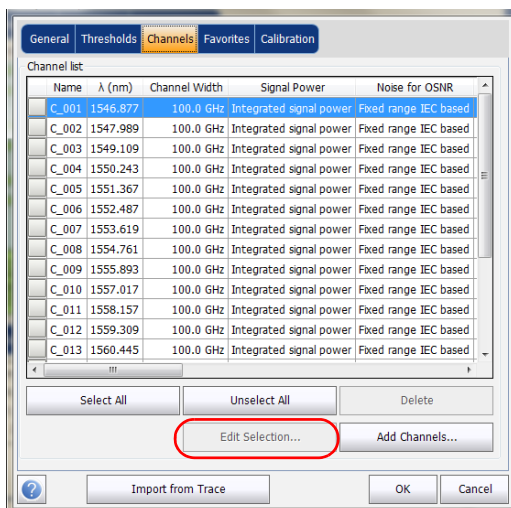

Setting Up the Instrument in Drift Mode

Setting Up Drift Analysis Parameters

5. Modify the settings as needed. For more information about the settings, see *Managing Channels on page 123*. If you leave a box empty, it will remain as it was before your changes. Modify appropriate settings.

The screenshot shows a configuration window with the following fields and values:

- Channel center: 1531.898 nm
- Channel name: 005
- Analysis section:
 - Channel width: 100.0 GHz
 - Signal power calculation: Integrated signal power
 - Noise for OSNR: Fixed range IEC based
 - OSNR distance: 50.0 GHz
 - Noise region: 5.0 GHz
- Restore Defaults button
- Thresholds section:

	Min.	Max.
Wavelength		0.020 nm
Signal power	-45.00	15.00 dBm
OSNR	5.00	60.00 dB

6. Press **OK** to return to the **Channels** tab, which now contains the modified settings.
7. Press **OK** to save the changes and close the window, or press **Cancel** to exit without saving.

Setting Up Acquisition Parameters

Before performing your test, you must set the acquisition type and parameters from the **Acquisition** tab and other parameters from the **Drift Settings** tab.

There are three types of acquisitions in Drift mode: single, averaging and InBand.

- **Single:** Spectral measurement is performed once. The results are displayed according to this measurement.
- **Averaging:** Spectral measurements are performed based on the number of scans that you have entered for this parameter. The trace will be displayed after each acquisition and averaged with the previous traces.

Before performing measurements on an optical spectrum, you must select the wavelength/frequency range to use. You can perform the scan on the full range, on spectral bands, or select a custom range.

Note: *The shorter the wavelength or frequency range, the faster the acquisition.*

You can configure the delay, sampling and total duration for a drift measurement. You can also configure the drift files name and select a location where it should be saved.

The application allows you to perform a trial scan while setting up the drift measurement.

Setting Up the Instrument in Drift Mode

Setting Up Acquisition Parameters

To set parameters in the Acquisition tab:

1. From the main window, select the **Acquisition** tab.

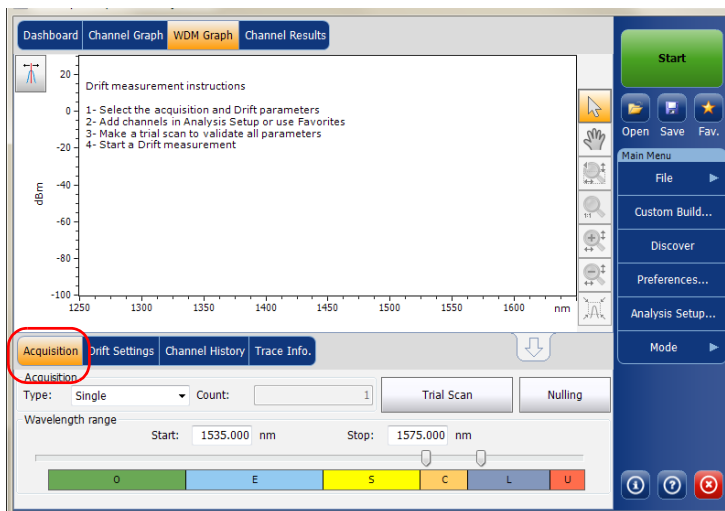

2. Select the acquisition type.

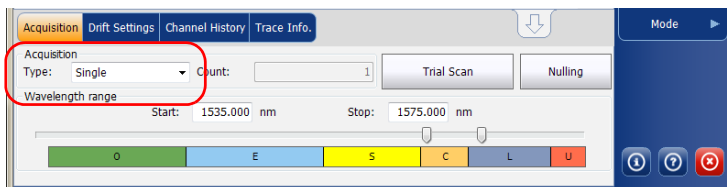

3. If you are performing an averaging type acquisition, enter the number of scans the unit will perform.

Note: You cannot modify the number of scans count value if you are performing a single acquisition.

4. Select the wavelength range for your acquisition.

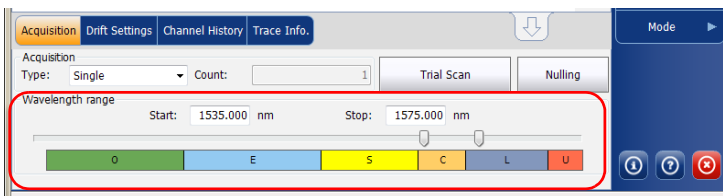

You can select the wavelength range by entering the start and stop values or by selecting a range on the double slider.

To select the wavelength range using the double slider, move the left and right handles on the double slider or simply click on any band.

Note: You can select more than one adjoining ranges to include in your range, for example, S + C.

Setting Up the Instrument in Drift Mode

Setting Up Acquisition Parameters

The wavelength range covered within these bands of the spectra are listed below.

- O band (original): 1255 to 1365 nm
- E band (extended): 1355 to 1465 nm
- S band (short wavelengths): 1455 to 1535 nm
- C band (conventional “erbium window”): 1525 to 1570 nm
- L band (long wavelengths): 1560 to 1630 nm
- U band (ultralong wavelengths): 1620 to 1650 nm.

To set parameters in the Drift Settings tab:

1. From the main window, select the **Drift Settings** tab.

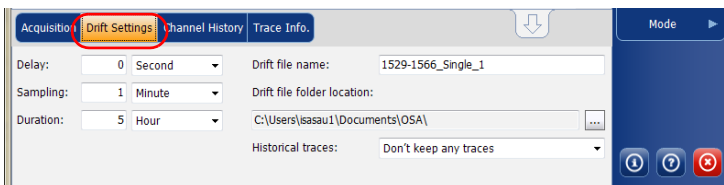

2. Set a delay unit and count before taking the first acquisition in a drift measurement. The application will wait for this time before taking the first acquisition of a drift measurement.

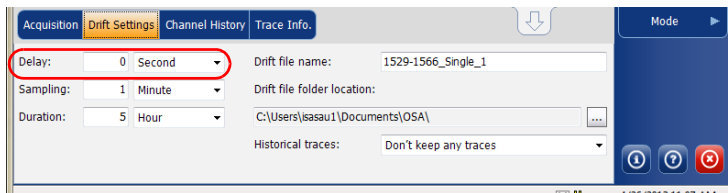

Setting Up the Instrument in Drift Mode

Setting Up Acquisition Parameters

3. Select a sampling unit and enter a sampling count to configure a time that should be elapsed between the start of each acquisition during a drift measurement.

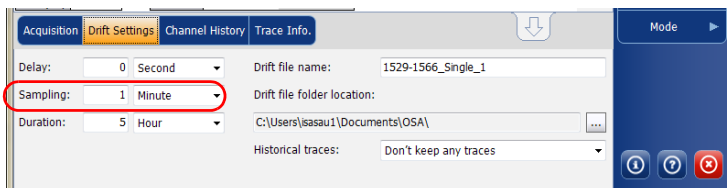

4. Select a duration unit and enter a duration count to configure the total duration of a drift measurement.

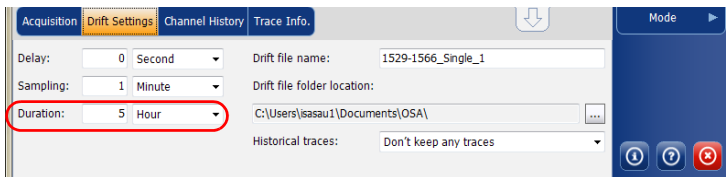

5. Enter a drift file name that should be used to save the drift file.

Note: This is not available in offline mode.

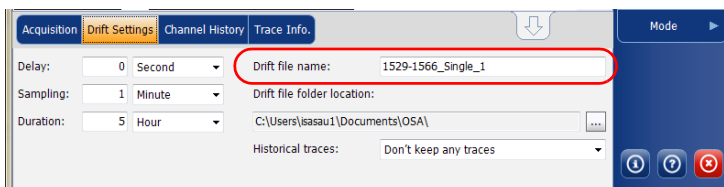

Setting Up the Instrument in Drift Mode

Setting Up Acquisition Parameters

6. Select a location where the drift file should be saved.

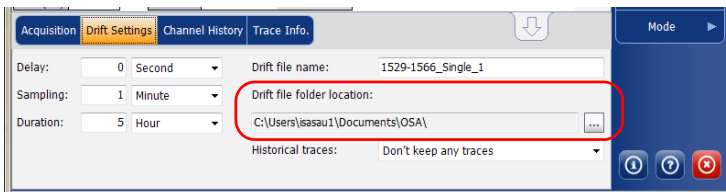

7. Select whether you want to keep all of the historical traces in the subfolder, keep only the significant ones, or keep none. The historical traces are stored in separate *.osawdm files.

A significant event is when

- a value from a given channel has crossed its threshold (going from pass to fail).
- there is no signal power in a given channel.

These historical files are stored in a dedicated folder having the same name as the associated drift measurement file name.

Note: You can have a maximum of 3 significant traces per channel.

Note: This option is not available in offline mode.

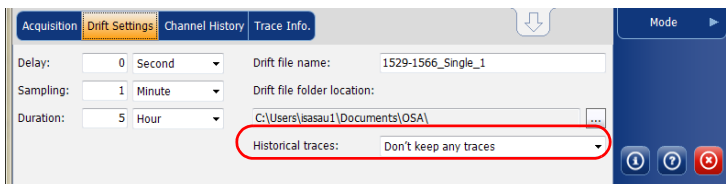

Setting Up the Instrument in Drift Mode

Setting Up Acquisition Parameters

8. To test your parameters, return to the **Acquisition** tab. Press **Trial Scan** to perform a trial acquisition.

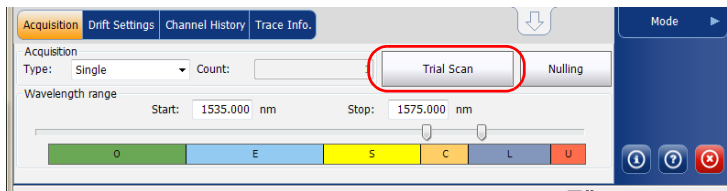

When a trial acquisition is running, the **Start** button is disabled. You are notified that the acquisition is in progress in the status bar.

The trial scan is performed using the analysis setup parameters. When the acquisition is complete, the resulting acquisition is displayed in the **WDM Graph** tab and **Channel Results** tab. The **Channel History** tab displays results as if only time 0:00 was available. The other drift mode tabs are empty (**Dashboard**, **Channel Graph**).

Setting Up the Instrument in Drift Mode

Building a Custom Drift Measurement

Building a Custom Drift Measurement

You can build a drift measurement using a WDM measurement you already have as a reference. The selected channels and thresholds can be imported from the analysis setup or the reference measurement.

A custom drift measurement is particularly useful for offline processing of your data over time and comparing result variations.

The WDM measurements you add must meet specific criteria to be included in the custom build. The table below describes those compatibility criteria.

Note: *Files that are not compatible will automatically be rejected from the custom build measurement.*

Criteria	Test	Compatibility Status
Acquisition type	Target WDM measurement acquisition type differs from drift reference trace acquisition type	Compatible with warnings
Acquisition number of scans	Target WDM measurement acquisition number of scans differs from drift reference trace acquisition number of scans.	Compatible with warnings
Spectral range	<ul style="list-style-type: none">➤ Target WDM measurement acquisition spectral range only partially overlaps spectral range of drift reference trace.➤ There is no overlap between target WDM measurement spectral range and drift reference trace spectral range.	<ul style="list-style-type: none">➤ Compatible with warnings➤ Incompatible

Setting Up the Instrument in Drift Mode

Building a Custom Drift Measurement

Criteria	Test	Compatibility Status
Acquisition start time	<ul style="list-style-type: none"> ➤ Target WDM measurement acquisition start time is identical to another WDM measurement (including the drift reference trace) acquisition time. 	<ul style="list-style-type: none"> ➤ Compatible with warnings
	<ul style="list-style-type: none"> ➤ Target WDM measurement acquisition start time overlaps with another WDM measurement (including the drift reference trace) acquisition time range. 	<ul style="list-style-type: none"> ➤ Incompatible
Calibration type (user/factory)	Target WDM measurement instrument's calibration type differs from drift reference trace instrument's calibration type.	Compatible with warnings
Calibration date	Target WDM measurement instrument's calibration date differs from drift reference trace instrument's calibration date	Compatible with warnings
Instrument's model	Target WDM measurement instrument's model differs from drift reference trace instrument's model	Compatible with warnings
Instrument's serial number	Target WDM measurement instrument's serial number differs from drift reference trace instrument's serial number	Compatible with warnings
Instrument's RBW	Target WDM measurement instrument's RBW differs from drift reference trace instrument's RBW	Compatible with warnings

Setting Up the Instrument in Drift Mode

Building a Custom Drift Measurement

Criteria	Test	Compatibility Status
Power offset	Target WDM measurement power offset differs from drift reference trace power offset	Compatible with warnings
Wavelength offset	Target WDM measurement wavelength offset differs from drift reference trace wavelength offset	Compatible with warnings
Noise measurement	Target WDM measurement acquired trace data does not support configured noise measurement analysis parameter. (This criteria is specific for In-Band noise measurement against IEC acquired data)	Compatible with warnings

Setting Up the Instrument in Drift Mode

Building a Custom Drift Measurement

To build a custom drift measurement:

- 1.** If you have not done so already, select the Drift test mode.
- 2.** From the main window, select **Custom Build**.
- 3.** Select the reference trace you want to use to build the measurement, then click **Next**.

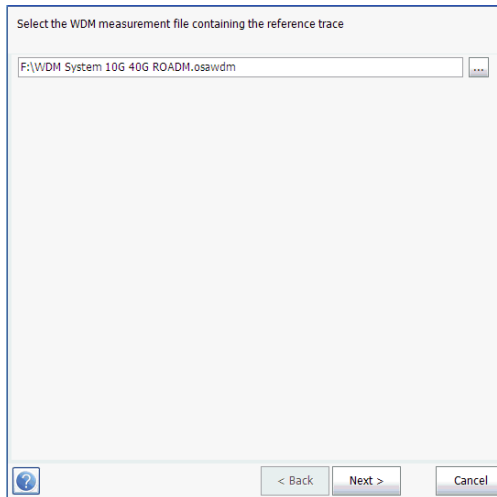

Setting Up the Instrument in Drift Mode

Building a Custom Drift Measurement

4. Select whether you want to import the analysis setup from the selected reference file, or use the settings currently set in your application, then click **Next**.

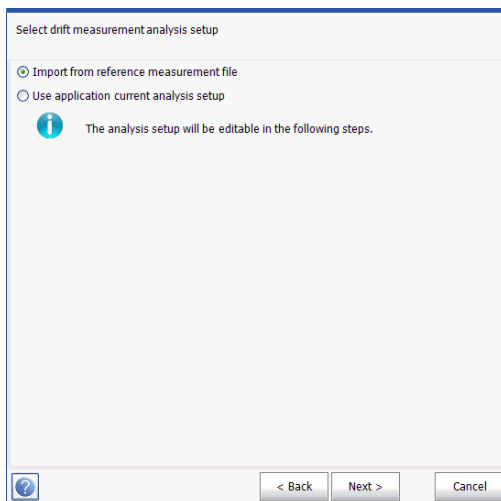

5. Enter, or review if they were imported, the general details for your measurement. See *Defining General Settings* on page 109 for details on each item.

Adjust analysis setup general parameters

Default: channel settings

Activate default channel

Channel width: 50.0 GHz Snap to ITU grid

Signal power calculation: Integrated signal power

Noise for OSNR: InBand narrow filter

OSNR distance: GHz

Noise region: GHz

Global analysis parameters

Peak detection level: -35.00 dBm

RBW for OSNR: Instrument's RBW

Bandwidth at: 20.00 dB

Restore Defaults

< Back Next > Cancel

6. Click **Next**.

Setting Up the Instrument in Drift Mode

Building a Custom Drift Measurement

7. If desired, adjust the threshold settings for your measurement. For details on each item, see *Defining Default Channel Thresholds* on page 117. When you are done, click **Next**.

Adjust analysis setup threshold parameters

Activate all thresholds

Default channel

	Min.	Max.	
Max. deviation Wavelength		0.020	nm
Min. and max. Signal power	-45.00	15.00	dBm
Min. and max. OSNR	5.00	60.00	dB

Restore Defaults

< Back Next > Cancel

Setting Up the Instrument in Drift Mode

Building a Custom Drift Measurement

8. Select which channels are to be included in the drift measurement. For details on each item, see *Managing Channels* on page 123. When you are done, click **Next**.

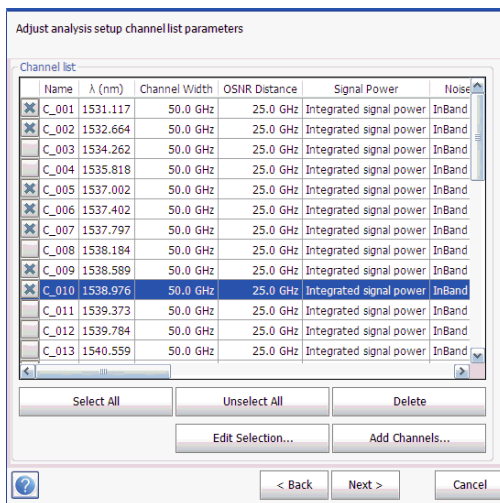

Setting Up the Instrument in Drift Mode

Building a Custom Drift Measurement

9. Add one or more measurement files at this point, then click **Next**.

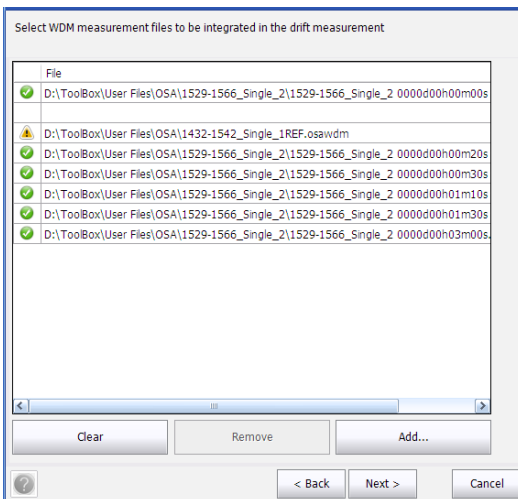

- 10.** Before starting the measurement process, you can select what to do with the historical traces (keep them all, keep only the significant ones, or keep none), set the drift file name and its location.

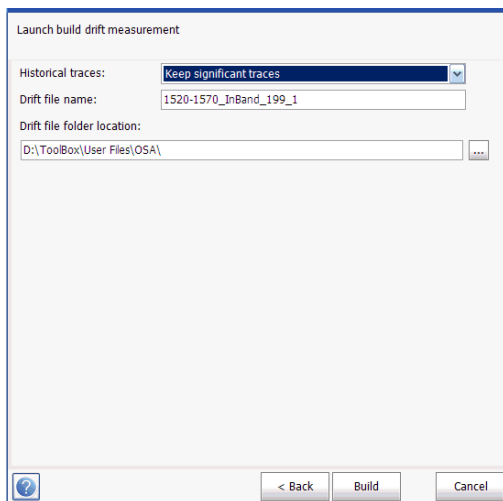

- 11.** Once you are ready, click **Build**.

Once the process is complete, you can navigate through the results of the built drift.

7 *Setting Up Your OCA*

Performing a spectral analysis with your Optical Channel Analyzer (OCA) is simple and can be achieved after selecting a few parameters.

Before performing your test, you must set the acquisition type and channel plan.

Your OCA features two types of acquisitions:

- **Single:** Spectral measurement is performed once. The results are displayed according to this measurement.
- **Real-Time:** In real-time acquisition, spectral measurements are performed continuously until you press **Stop**. No averaging is done for spectral measurements. The graph is refreshed after each acquisition.

Before performing measurements on an optical spectrum, you must select the channel plan you want to use for your test:

- **CWDM:** ITU CWDM channels covering the O- through L-Bands (1255 nm to 1630 nm).
- **DWDM:** 50 GHz ITU DWDM channels covering the C-Band (1525 nm to 1570 nm).
- **DWDM over CWDM:** CWDM channels covering the O- through -L bands (1255 nm to 1630 nm) with DWDM channels in the C-band.
- **CFP 40GBase-LR4:** the four WDM channels assigned to lanes 0 to 3 of 40GBase C form-factor pluggable transceiver modules (1260 nm to 1340 nm).
- **CFP 100GBase-LR4:** the four WDM channels assigned to lanes 0 to 3 of 100GBase C form-factor pluggable transceiver modules (1290 nm to 1315 nm).
- **CFP 100GBase-LR10:** the ten WDM channels assigned to lanes 0 to 9 of 100GBase C form-factor pluggable transceiver modules (1515 nm to 1605 nm).
- **Custom 1:** first user-defined channel plan (by default, same as CWDM).
- **Custom 2:** second user-defined channel plan (by default, same as DWDM).

Setting Up Your OCA

To set parameters in the Acquisition tab:

1. From the main window, select the **Acquisition** tab.

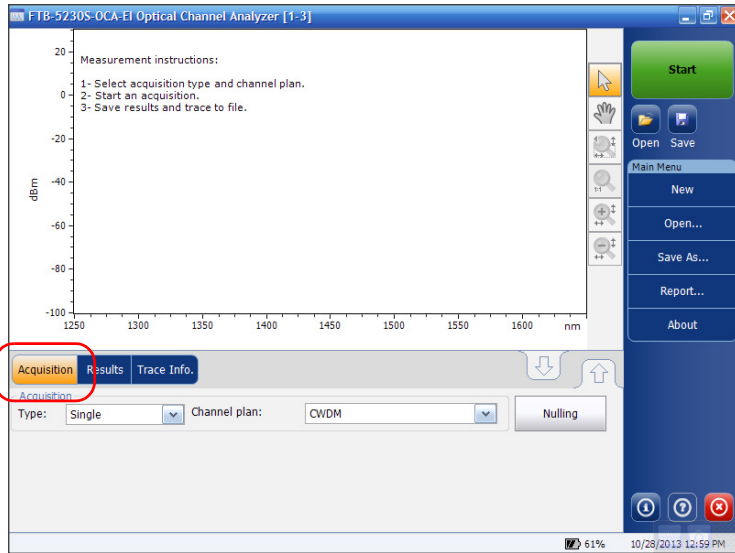

2. Select the acquisition type.

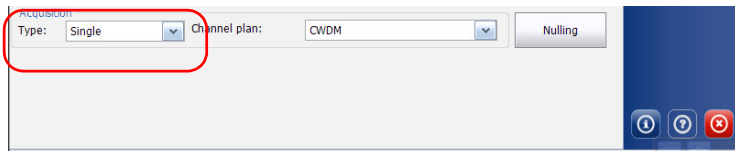

3. Select the channel plan to use.



To create a channel plan and use it as one of the Custom channel plans:

1. Start the post-processing application on a computer, and select the WDM test mode.
2. From the **Main Menu**, select **Analysis Setup**.
3. Create the channel plan:
 - If you want to start from an existing configuration, import the configuration to use in the **Favorites** tab, or select a configuration already in the list, then click **Apply Selection**.OR
 - To start a configuration from scratch (or modify an existing one), use the **General** and **Channel** tabs to change the parameters.

Note: *For details on how to set up acquisition parameters and channel lists, see Defining General Settings on page 62 and Managing Channels on page 78.*

Note: *Only the basic WDM analysis parameters used for channel detection and power measurement are taken into account in OCA WDM analysis.*

4. If you want to change the acquisition range, exit the **Analysis Setup** window, and change the wavelength range start and stop values in the **Acquisition** tab of the main window (see *Setting Up Acquisition Parameters* on page 86 for details).
5. Once your modifications are complete, return to the **Analysis Setup** window and select the **Favorites** tab.
6. Click **Save As**, select the location where you want to put your configuration file, and rename your file either Custom1.osawdmsetup or Custom2.osawdmsetup, and click **Save**.

Setting Up Your OCA

7. In Windows Explorer, rename the extension of your file from .osawdmsetup to .ocawdmsetup.
8. Using a USB key or network connection, place the renamed file in the [...] \Configuration Files \OCA \Favorites folder of your unit. Confirm the overwrite of the existing Custom file if needed.

Note: *If you want to modify an existing Custom channel plan, make a copy of it in Windows Explorer, and rename it with the .osawdmsetup extension before importing it in the **Favorites** tab of the OSA post-processing application.*

8 Starting a Measurement

Before starting a measurement you must select and configure a test mode. You will find the instructions to select a test mode in *Selecting a Test Mode* on page 18. For instructions on configuring various test modes, see their respective sections.

Note: *You cannot start a measurement in offline mode.*

To start the measurement:

From the main window, Press **Start**. The button will turn into a **Stop** button.

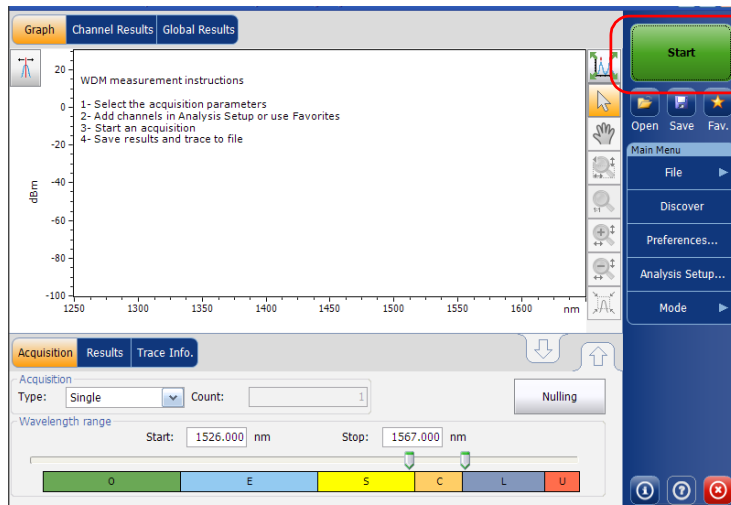

You are notified that the acquisition is in progress in the status bar.

When the acquisition is complete, the corresponding trace or traces, plus result data, trace information and pass-fail statuses, if activated, appear.

Note: *There are no pass-fail statuses in the OCA application.*

9 **Managing Files and Test Configurations**

Using the Discover Feature

The Discover feature allows you to start a measurement procedure to automatically build an analysis setup (scan range, channel list, analysis parameters, etc.) based on the signal being detected on the input port of the module.

Note: *The Discover feature is not available on the OCA application.*

The procedure starts with a full range single scan (1250 nm to 1650 nm) to determine signal spectral range. It is followed by a second scan to establish the analysis parameters by locating the various peaks from the incoming signal.

When the discover process is successful, the application displays the results and graph for the detected channels and the newly discovered analysis parameters are applied automatically to the analysis setup.

Note: *If no signal is detected with the first scan, then the graph shows the full range scan and ends the discover procedure. The application analysis parameters remain unchanged.*

Managing Files and Test Configurations

Using the Discover Feature

Discover analysis parameters are established as follows:

- The acquisition spectral range is set at 5 nm before the first detected signal peak, and 5 nm after the last detected signal peak (respecting spectral range limits).
- A channel list is created based on detected signal peaks; default settings are applied for all channel parameters.
- The center wavelength of each channel is aligned with an ITU grid (200, 100, 50 or 25 GHz for DWDM).
- The channel width is determined using the overlap criteria; if two channels overlap by more than 0.001 nm or 0.001 GHz, then their widths are reduced to the lower width. If the width of two channels is at 25 GHz and they still overlap, then the width is not reduced and the application considers it as a multi-peak signal (like recent modulation formats for 10 Gb/s or 40 Gb/s) and sets the width of the channel to 50 GHz.

Note: *One of the limitations of using the Discover feature is that the channels are discovered based on the ITU-Grid. All detected peaks will be aligned with an ITU-channel; the channel width and distance are computed and fit in one of the ITU grids (25, 50, 100 or 200 GHz). If your channel is not based on the ITU grid, the results may not be correct. In this case, you can use the default channel definition or create a new channel list.*

To start an automatic setup measurement:

Note: You cannot do a setup measurement in offline mode.

From the **Main Menu**, press **Discover**. The **Start** button turns into a **Stop** button and the first scan of the discover starts.

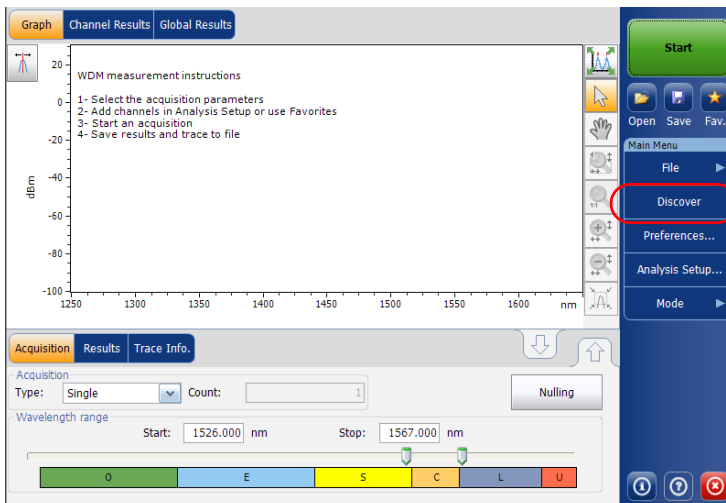

Note: If you already have an active trace on screen that was modified, you will be prompted to save it. Any reference trace will be cleared.

You are notified that the discover acquisition is in progress in the status bar.

When the automatic setup measurement is complete, you can start using these newly detected parameters. Simply press **Start** to perform another measurement with the newly found settings.

Managing Measurement Files

The application allows you to manage the measurement files. You can save files for future reference, open files to continue a test, or clear them to make room on your unit.

Note: *You cannot open OCA files in the OSA application, nor OSA files in the OCA application.*

To save files:

1. From the **Main Menu**, Press **File**, and then press **Save As** (for the OCA application, there is no **File** menu).

OR

From the main window, press .

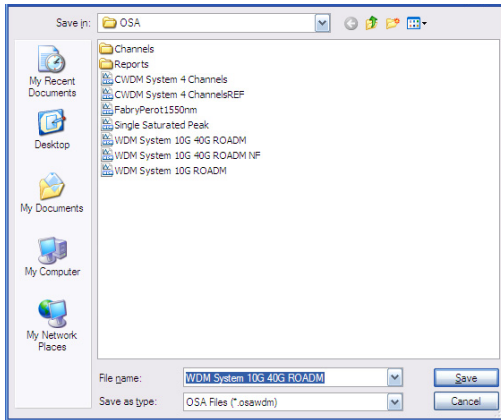

2. If desired, change the location and file name.
3. Press **Save** to save the trace, else press **Cancel** to exit the window.

Note: *Once a trace is overwritten, you cannot access it anymore.*

Note: *You cannot save a reference trace.*

To open a file:

1. From the **Main Menu**, Press **File**, and then press **Open** (for the OCA application, there is no **File** menu).

OR

From the main window, press .

2. If you had already acquired (but not saved) a trace, a warning window appears, asking you if you want to save the current trace. Press **Yes** to save the trace. Once the trace is saved, you can open a new trace. Press **No** to display the new trace without saving the previously acquired one. Press **Cancel** to return to the previous window.

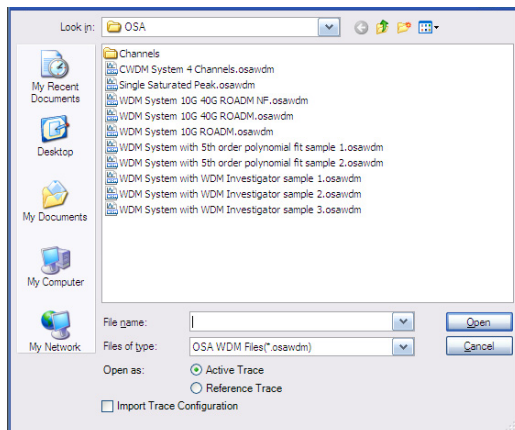

Managing Files and Test Configurations

Managing Measurement Files

3. Scroll through the list and select a trace to open.
4. If you are in WDM mode, select whether the trace will be loaded as the active trace or the reference trace.

You can select whether you want to also import the trace configuration and overwrite the current analysis setup and acquisition context at the same time that you open the file. The file type must be the same for the configuration importation to be valid. If you have selected to open a reference trace, the importation is done automatically.

Note: *If you open an active trace and a reference trace is already present, the current analysis setup will be applied to the active trace. If you open a reference trace its analysis setup will replace the current analysis setup.*

5. Press **Open** to open the file. The trace appears in the **Graph** tab. All the values in the main window will also be updated from the file.

To clear a file:

1. From the **Main Menu**, Press **File**. (for the OCA application, skip step 1)
2. Press **New**.

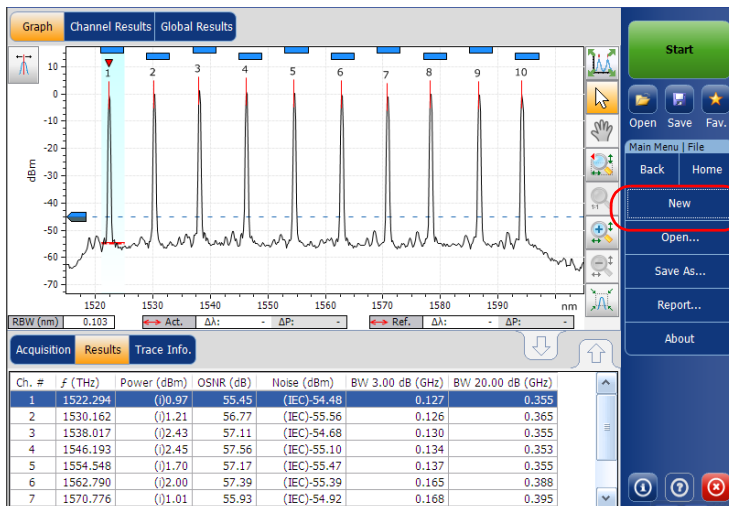

3. If you had already acquired (but not saved) a trace, a warning window appears, asking you if you want to save the current trace. Press **Yes** to save the trace. Once the trace is saved, you can make room for a new trace. Press **No** to create a new trace without saving the previously acquired one. Press **Cancel** to return to the previous window.

Note: In WDM mode, any reference trace will be cleared at this point.

Opening Other Test Mode Files in WDM Mode

Your application allows you to open different file types in WDM mode.

Note: *This feature is not available in the OCA application.*

While loading a spectral transmittance (.osast) file, the application will re-analyze the newly imported data using the current WDM analysis setup.

While loading a legacy (.osw/.osm) file, the application will import only the raw trace data and acquisition conditions (date, acquisition type, averaging count and wavelength range). All results will be re-analyzed using the current WDM analysis setup.

While loading an EDFA (.osaedfa) file, the application will re-analyze the newly imported data using a temporary setup built from the retrieved channel list, retrieved default channel settings and blanks filled using the current WDM analysis setup.

While loading a spectral transmittance or EDFA file, the application imports trace data as follows:

- If an Input trace is present in the file, it is imported as the WDM reference trace.
- If an Output trace is present in the file, it is imported as the WDM active trace.

Managing Favorites

Favorites are configuration files that contain all of the parameters from the **Analysis Setup** tab and **Acquisition** tab. When you often use the same settings, you can save them as a favorite, then recall them for future acquisitions.

Note: *The Favorites feature is not available for the OCA application.*

To load a test configuration:

1. From the **Main Menu**, press **Analysis Setup**.

OR

From the main window, press .

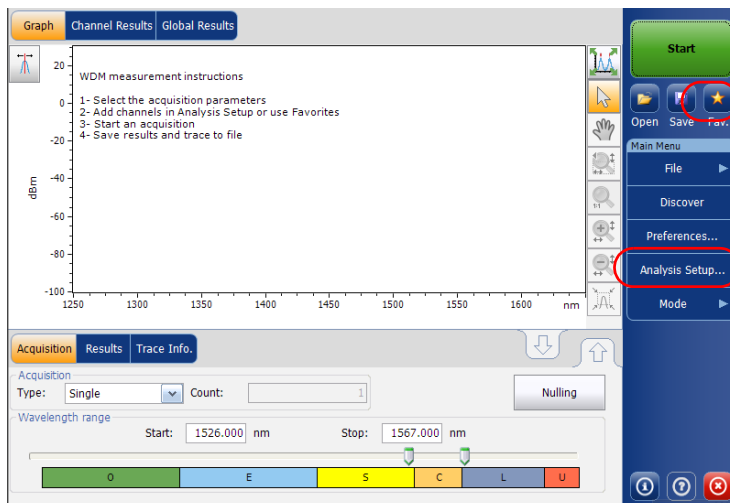

Managing Files and Test Configurations

Managing Favorites

2. Select the **Favorites** tab.

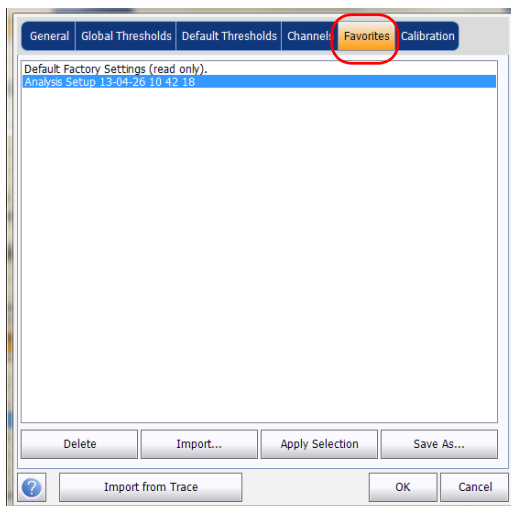

3. To apply the settings from a favorite file to the current analysis setup, select a file from the favorites list and press **Apply Selection**. This button will be enabled only when a file is selected from the favorites list. When you press **Apply Selection**, the contents of the file are loaded in the other tabs of this window.

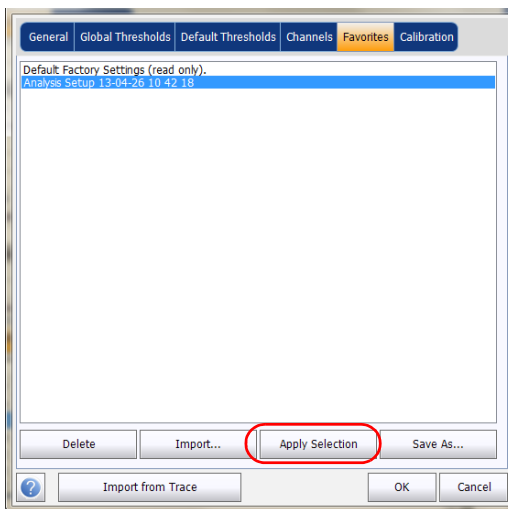

4. Press **OK** to proceed with the loaded configuration and close the window, or press **Cancel** to exit without saving.

Note: *Pressing **OK** automatically starts the reanalysis process if a measurement file was already present.*

Managing Files and Test Configurations

Managing Favorites

To save a test configuration:

1. From the **Main Menu**, press **Analysis Setup**.

OR

From the main window, press .

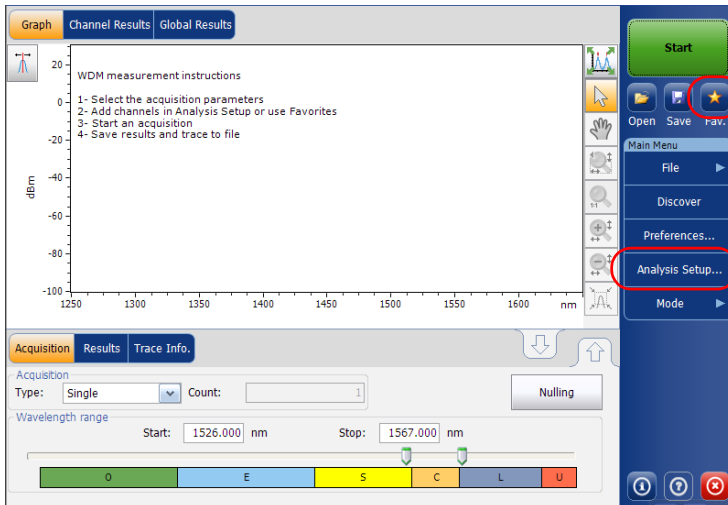

2. Select the **Favorites** tab.

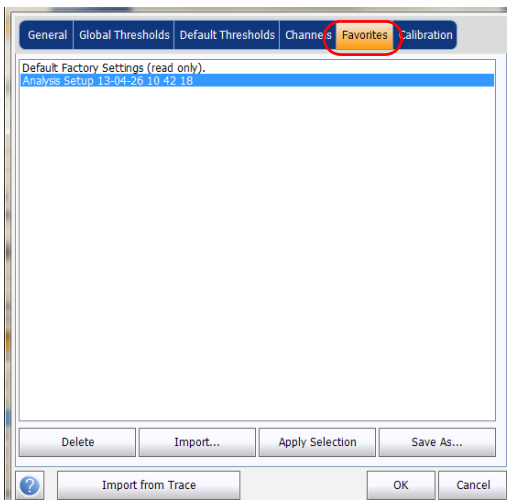

3. To save an analysis setup to a file, press **Save As**. The default folder where the file will be saved is the Favorites folder. You should use this folder unless you want to transfer a copy on an external storing device such as a USB stick.

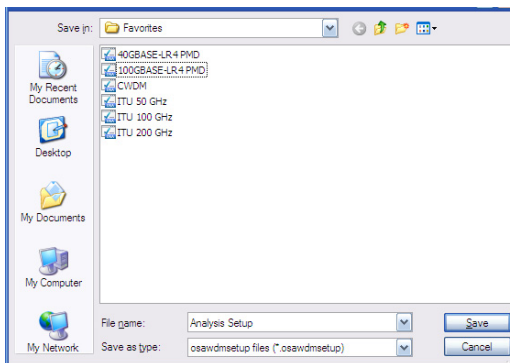

Managing Files and Test Configurations

Managing Favorites

4. In the **Save As** window, enter a file name and press **Save**. The file will be added to the favorites list in the **Analysis Setup – Favorites** tab.
5. Press **Save** to save the configuration and close the window, or press **Cancel** to exit without saving.

To import a test configuration:

1. From the **Main Menu**, press **Analysis Setup**.

OR

From the main window, press .

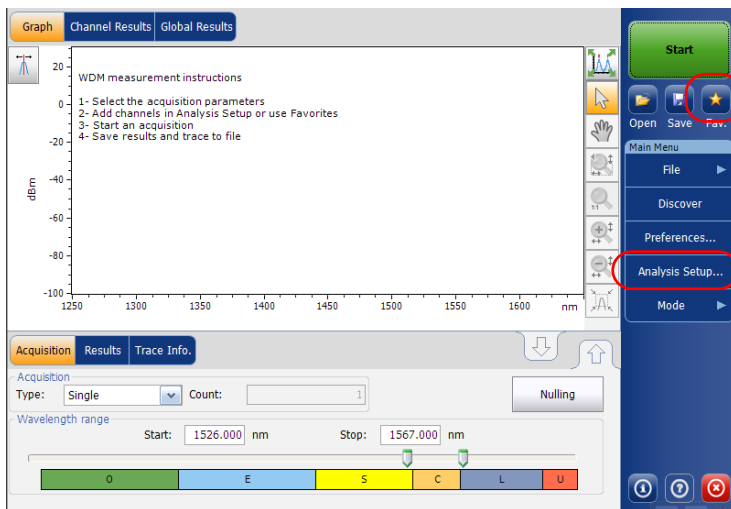

2. Select the **Favorites** tab.

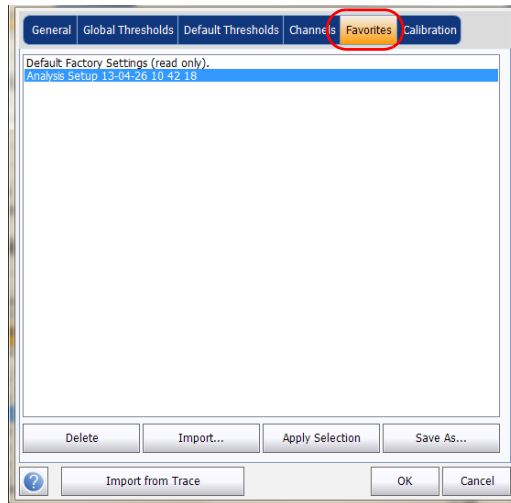

3. Press **Import** to import an analysis setup from a file.

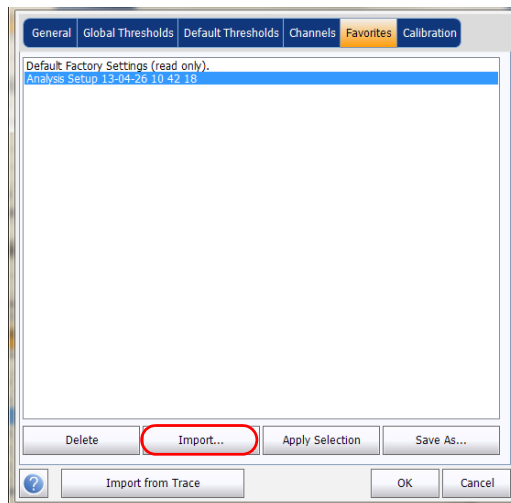

Managing Files and Test Configurations

Managing Favorites

4. From the Import window, select the file you want to import and press **Open**. The file will be added to the favorites list in the **Analysis Setup – Favorites** tab.

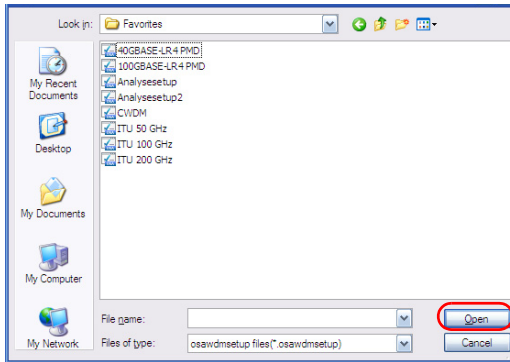

5. Press **OK** to load the configuration and close the window, or press **Cancel** to exit without saving.

Note: To load this newly imported test configuration, you must select it from the favorites list and press **Apply Selection**.

To delete a test configuration:

1. From the **Main Menu**, press **Analysis Setup**.

OR

From the main window, press .

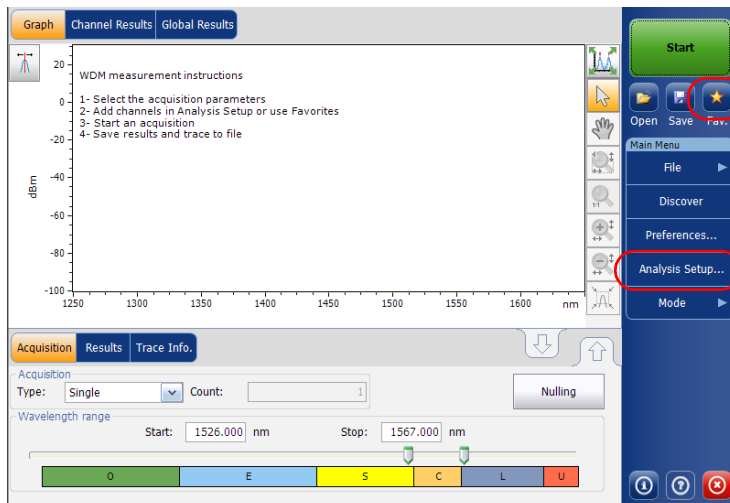

Managing Files and Test Configurations

Managing Favorites

2. Select the **Favorites** tab.

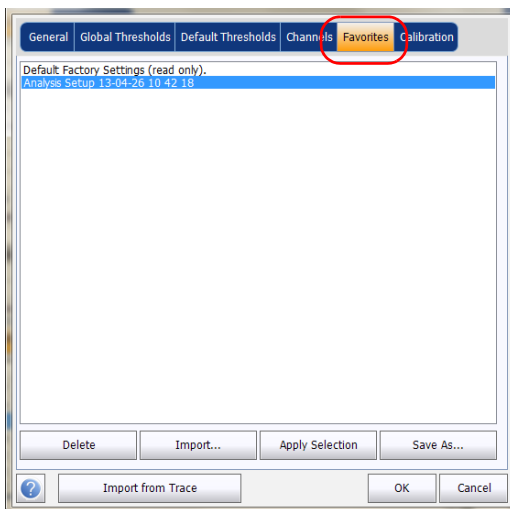

3. To delete a configuration file from the favorites list, select it and press **Delete**. Press **Yes** to confirm your choice.

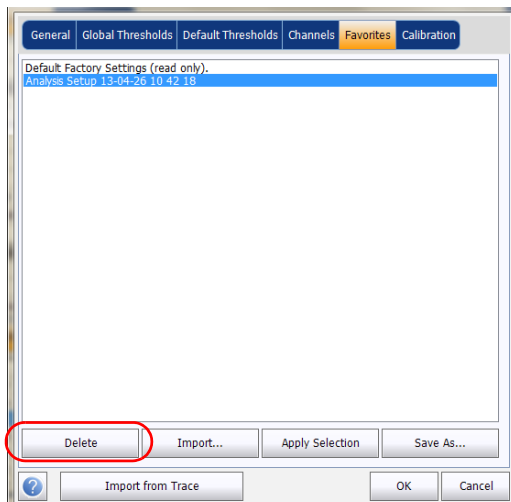

Importing a Configuration from the Current Trace

In the OSA application, you can import the analysis and channel configuration from the measurement file currently on-screen. See *Setting Up WDM Analysis Parameters* on page 59 for details.

Using a Restore Point

When you modify the analysis setup and press **OK**, a restore point is created. This can be useful when you want to revert to the values you had prior to changing a test configuration.

You can keep up to three restore points during a working session, but they are cleared when you start a new session, or if you change the test mode.

10 *Managing Results*

Each test mode has its own results tabs, where you can view the trace details, channel results and global results for all measured channels.

You can use zoom options on the trace, configure markers to view the power values for specific wavelengths (OSA only), and view trace information.

You can also manage trace files and generate reports for all test modes.

Note: *When a power result is flagged using an asterisk (*), it means that the detector is saturated. When the optical power on the detector is too high, the detector gets saturated and the returned value is probably incorrect.*

Note: *When an OSNR or a noise result is flagged using a question mark (?), it means that the quality of the result is insufficient to make a valid calculation. This indication can be produced when analyzing an InBand/i-InBand measurement, or when computing noise through polynomial fit (when viewing files from the FTB-5240S series modules). This indication can arise in the following situations:*

- InBand/i-InBand averaging was made using a very few scans (1 or 2 for example). Usually produced when the operator presses the **Stop** button before the end of the InBand/i-InBand acquisition.
- The data in the measured channel is subjected to fast polarization scrambling, or is a polarization multiplexed signal.
- One channel might have a misfit with the current state of the polarization scrambler inside the module. This can be corrected by moving the fiber at the entrance of the module.
- The polarization scrambler inside the module could be defective. If you suspect this option please contact EXFO technical support for a more complete diagnosis.
- Polynomial fit coefficient correlation is questionable.

Managing Results

Managing WDM Test Results

Managing WDM Test Results

The application allows you to view and manage your WDM test results. You can view the graph of your acquisition, results for a single channel, global results and information about the trace.

Graph Tab

The **Graph** tab allows you to view the spectrum of the active and reference traces. This graph represents the optical power against wavelength or frequency.

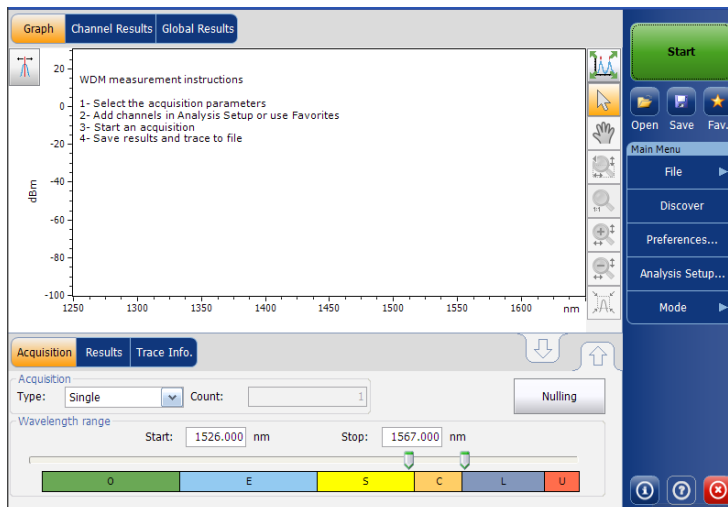

When the acquisition is taken (see *Starting a Measurement* on page 153 for details on how to perform a test), the active trace will be displayed in the tab with information along the following axis values:

- X axis: wavelength in nm or frequency in THz.
- Y axis: optical power expressed in dBm, as measured in the optical resolution bandwidth (RBW) of the OSA/OCA. This reference RBW is shown at the bottom of the graph.

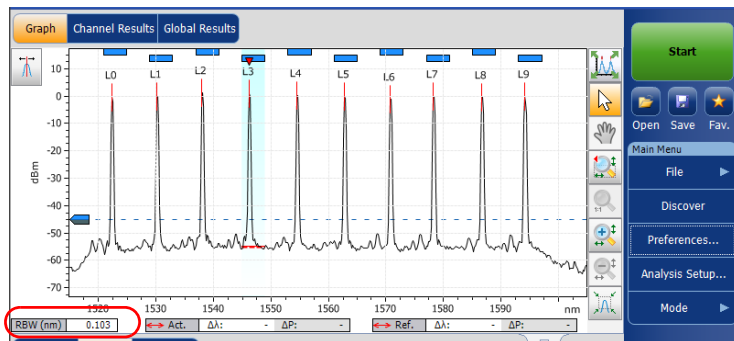

If the current active trace was previously saved, the application will display the file name of the current trace in the title bar.

The graph will display peak indicators for all the channels found by the application with a red vertical line over the peaks to indicate the peak position.

A blue horizontal bar (■) will be displayed on the top of a channel if it does not overlap with another channel. If the channel overlaps with another channel, the horizontal bar will be yellow (■).

Managing Results

Managing WDM Test Results

The selected peak indicator, a small red inverted triangle (▼) points down at the top of the currently selected channel peak. In the graph zone, you can change the selected peak by clicking inside the peak limits of the desired channel. Peak selection in the graph is synchronized with the channel selection in lower tab results list; changing the selection in the graph modifies the selection in the list and vice-versa.

Note: *This is valid only for channels in the list for which a signal is detected. If you select a channel that has no signal, no peak is selected in the graph.*

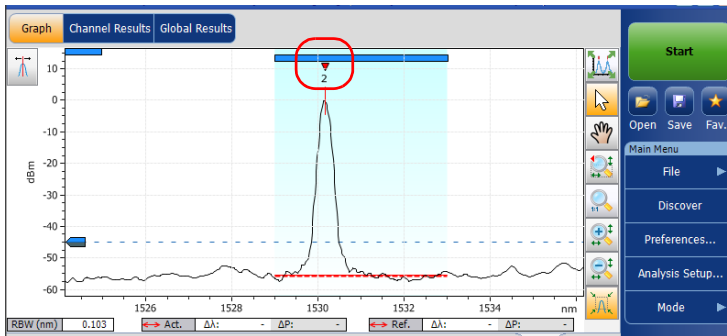

The noise level for a channel is indicated by a dotted line under the selected peak. The width of the noise level indicator is set according to the current Noise for OSNR setting. The width of the noise level indicator depends on the noise associated with the OSNR setting (from the largest to the narrowest): IEC, InB, InB nf and fit.

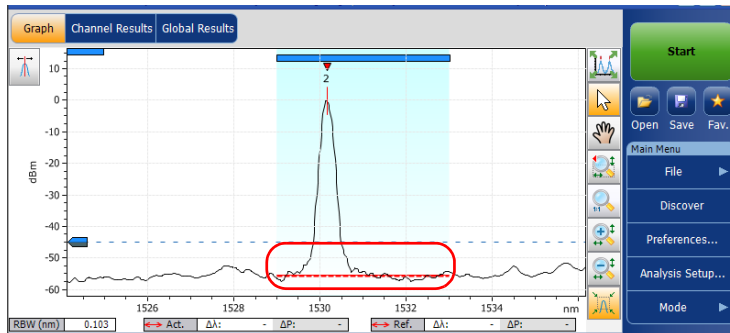

A dotted line across the full spectral width corresponds to the peak detection level indicator. This line indicates the minimum power level (dBm) from where a peak can be considered as a valid signal.

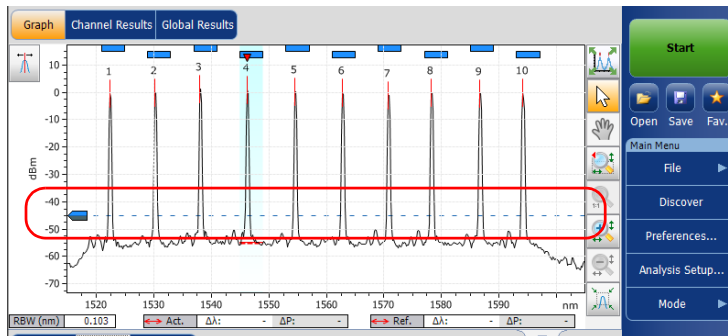

A peak detection level cursor is available in the graph when the **Results** tab is selected. The cursor is positioned along the Y-axis in accordance with the application's peak detection level global analysis parameter.

Managing Results

Managing WDM Test Results

You can move the cursor to modify the peak detection level for the current measurement. Each time the cursor is moved, the trace(s) is/are fully analyzed again using the application analysis setup.

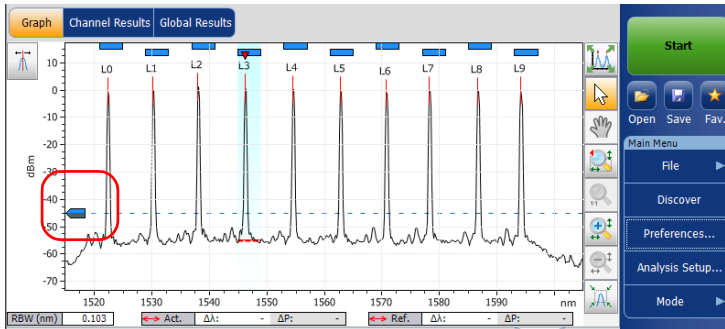

Note: If you select another tab than **Results**, the cursor disappears, but you can still see the peak detection level indicator line.

Note: If there is a reference trace, it appears in gray in the graph.

Note: For more information on these, see *Managing Markers on page 206* and *Using Zoom Controls on page 204*.

Results Tab

In the **Results** tab, each channel will be represented for both the active and reference traces, with the delta between both results. Only the results for the channels within the scan range will be analyzed. The pass (✓)/fail (✗) verdict for thresholds are also displayed; if the verdict is fail for any parameter, its value will appear in red.

To view results:

From the main window, select the **Results** tab.

Ch. #	f (THz)	Power (dBm)	OSNR (dB)	Noise (dBm)	BW 3.00 dB (GHz)	BW 20.00 dB (GHz)
1	1522.294	(0).97	55.45	(TEC)-54.48	0.127	0.355
2	1530.162	(0)1.21	56.77	(TEC)-55.56	0.126	0.365
3	1538.017	(0)2.43	57.11	(TEC)-54.68	0.130	0.355
4	1546.193	(0)2.45	57.56	(TEC)-55.10	0.134	0.353
5	1554.548	(0)1.70	57.17	(TEC)-55.47	0.137	0.355
6	1562.790	(0)2.00	57.39	(TEC)-55.39	0.165	0.388
7	1570.776	(0)1.01	55.93	(TEC)-54.92	0.168	0.395

Note: For details on filtering displayed channel results, see Defining Display Parameters on page 50

For details on each result type, see Customizing WDM Results Table on page 57.

Managing Results

Managing WDM Test Results

Channel Results Tab

The application allows you to view the complete information about the parameters measured for the selected channel. This is also where the pass/fail verdict for thresholds are displayed. If the verdict is fail for any parameter, its value will appear in red. If the verdict is pass, its value will appear in green.

To view channel results:

1. From the main window, select **Channel Results** tab.

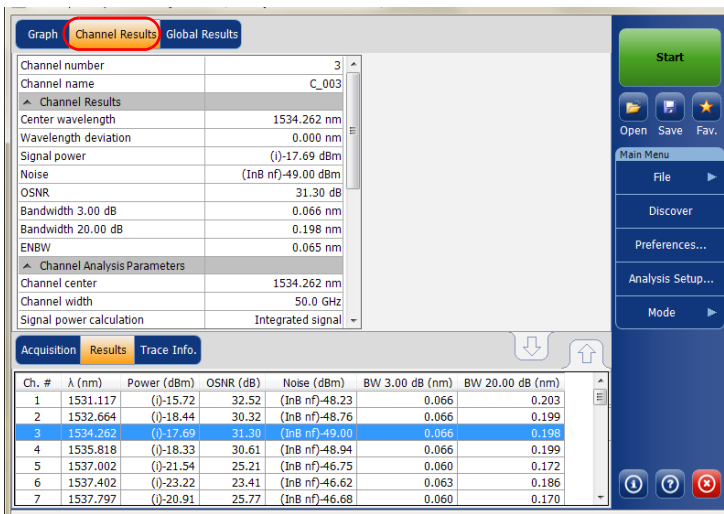

2. Select a row from the **Results** tab to view the results for this channel.

The screenshot shows the 'Channel Results' tab in the software. The 'Results' tab is selected, and a table of channel results is displayed. The third row is highlighted in blue, indicating it is the active trace. The table columns are Ch. #, λ (nm), Power (dBm), OSNR (dB), Noise (dBm), BW 3.00 dB (nm), and BW 20.00 dB (nm).

Ch. #	λ (nm)	Power (dBm)	OSNR (dB)	Noise (dBm)	BW 3.00 dB (nm)	BW 20.00 dB (nm)
1	1531.117	(i)-15.72	32.52	(InB nf)-48.23	0.066	0.203
2	1532.664	(i)-18.44	30.32	(InB nf)-48.76	0.066	0.199
3	1534.262	(i)-17.69	31.30	(InB nf)-49.00	0.066	0.198
4	1535.818	(i)-18.33	30.61	(InB nf)-48.94	0.066	0.199
5	1537.002	(i)-21.54	25.21	(InB nf)-46.75	0.060	0.172
6	1537.402	(i)-23.22	23.41	(InB nf)-46.62	0.063	0.186
7	1537.797	(i)-20.91	25.77	(InB nf)-46.68	0.060	0.170

Note: Values displayed in the **Channel Result** tabs are those of the active trace only.

Note: For details on each result type, see Customizing WDM Results Table on page 57 and Defining General Settings on page 62.

Note: The wavelength/frequency deviation is the difference between the channel center wavelength/frequency and the measured signal center wavelength/frequency.

Managing Results

Managing WDM Test Results

Global Results Tab

The application allows you to view the global results of the current measurement. The pass/fail verdict for thresholds are displayed in the **Global Results** tab. If the verdict is fail for any parameter, its value appears in red. If the verdict is pass, its value appears in green.

To view global results:

From the main window, select the **Global Results** tab.

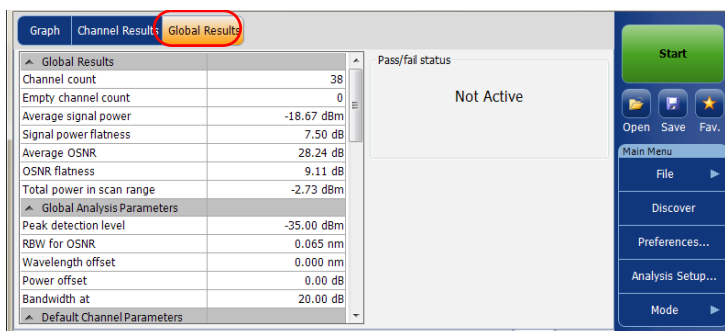

Results and analysis parameters global to all channels will be displayed. For more information on each item, see *Defining Global Thresholds* on page 70 and *Defining General Settings* on page 62.

In addition, you can view the global pass/fail status, provided the thresholds are activated in the **Global Result Thresholds** tab in the **Analysis Setup** window. If the thresholds are enabled, the **Global pass/fail status** pane will display a Pass or Fail status based on the global results, or **Not Active** if the thresholds are disabled.

Note: Values displayed in the **Global Results** tab are indicated for the active trace only.

Managing Drift Test Results

The application allows you to view and manage your drift test results. You can view the dashboard, channel graph and WDM graph of your drift acquisition, channel history results for a single channel and information about the trace.

Dashboard Tab

The dashboard allows you to view at-a-glance the pass/fail status of each parameter for each channel that is measured during a drift measurement. When there is no measurement, the dashboard is blank.

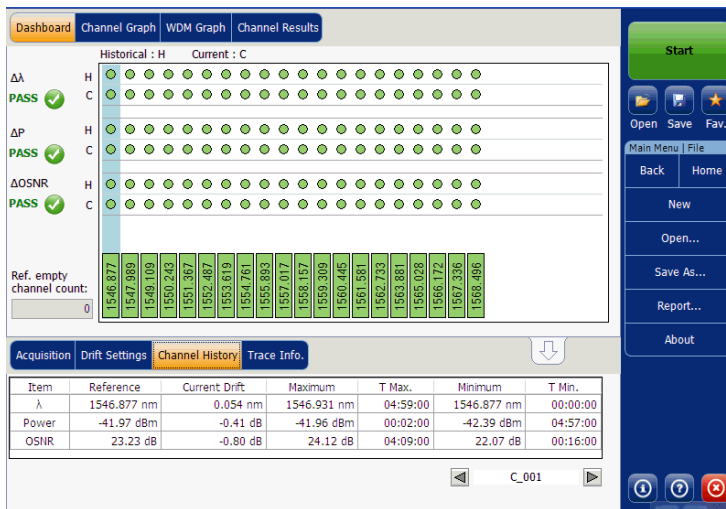

Managing Results

Managing Drift Test Results

You can select a channel directly from the dashboard or from the **Channel History** tab. For each channel, the dashboard displays the pass/fail status for each of the following parameters:

- Central wavelength/frequency
- Signal power
- OSNR

Both the current pass/fail status (last completed acquisition) and the historical pass/fail status are displayed in the dashboard. The historical pass/fail status will be set to Fail as soon as one occurrence of fail has occurred in the past or in the current acquisition.

The screenshot shows a software interface with a 'Channel Results' tab. It displays a grid of pass/fail status for three parameters: $\Delta\lambda$, ΔP , and $\Delta OSNR$. Each parameter has two rows: 'Historical : H' and 'Current : C'. All cells in the grid contain a green circle with a checkmark, indicating 'PASS'. Below the grid is a list of reference wavelengths. At the bottom, a table provides drift test results for three parameters: λ , Power, and OSNR.

Item	Reference	Current Drift	Maximum	T Max.	Minimum	T Min.
λ	1546.877 nm	0.054 nm	1546.931 nm	04:59:00	1546.877 nm	00:00:00
Power	-41.97 dBm	-0.41 dB	-41.96 dBm	00:02:00	-42.39 dBm	04:57:00
OSNR	23.23 dB	-0.80 dB	24.12 dB	04:09:00	22.07 dB	00:16:00

The dashboard shows a global status (all channels) for each parameter. This global status is set to Fail if at least one channel has a failed historical status for that given parameter, otherwise the global status is set to Pass.

The dashboard displays the following parameters and their global status:

- $\Delta\lambda$: PASS (indicated by a green checkmark)
- ΔP : PASS (indicated by a green checkmark)
- $\Delta OSNR$: PASS (indicated by a green checkmark)

The table below shows the drift settings for each parameter:

Item	Reference	Current Drift	Maximum	T Max.	Minimum	T Min.
λ	1546.877 nm	0.054 nm	1546.931 nm	04:59:00	1546.877 nm	00:00:00
Power	-41.97 dBm	-0.41 dB	-41.96 dBm	00:02:00	-42.39 dBm	04:57:00
OSNR	23.23 dB	-0.80 dB	24.12 dB	04:09:00	22.07 dB	00:16:00

Managing Results

Managing Drift Test Results

The dashboard displays a channel status (all parameters) for a given channel. This channel status is set to Fail as soon as one of the parameters has a failed historical status for that given channel, otherwise the channel status is set to Pass.

Historical : H Current : C

Δλ
PASS ✓
H
C

ΔP
PASS ✓
H
C

ΔOSNR
PASS ✓
H
C

Ref. empty channel count

1546.877
1547.989
1549.109
1550.243
1551.367
1552.467
1553.619
1554.761
1555.893
1557.017
1558.157
1559.309
1560.445
1561.581
1562.733
1563.881
1565.028
1566.172
1567.336
1568.496

Acquisition Drift Settings Channel History Trace Info.

Item	Reference	Current Drift	Maximum	T Max.	Minimum	T Min.
λ	1546.877 nm	0.054 nm	1546.931 nm	04:59:00	1546.877 nm	00:00:00
Power	-41.97 dBm	-0.41 dB	-41.96 dBm	00:02:00	-42.39 dBm	04:57:00
OSNR	23.23 dB	-0.80 dB	24.12 dB	04:09:00	22.07 dB	00:16:00

C_001

Channel Graph Tab

The **Channel Graph** tab displays three different graphs for the selected channel. You can select which graphs you want to display from the **Drift Results** tab in the **Preferences** Window. The three graphs are X-Y plots of:

- Spectral position (center of mass of wavelength or frequency) of the channel over time
- Signal power of the channel over time
- OSNR of the channel over time

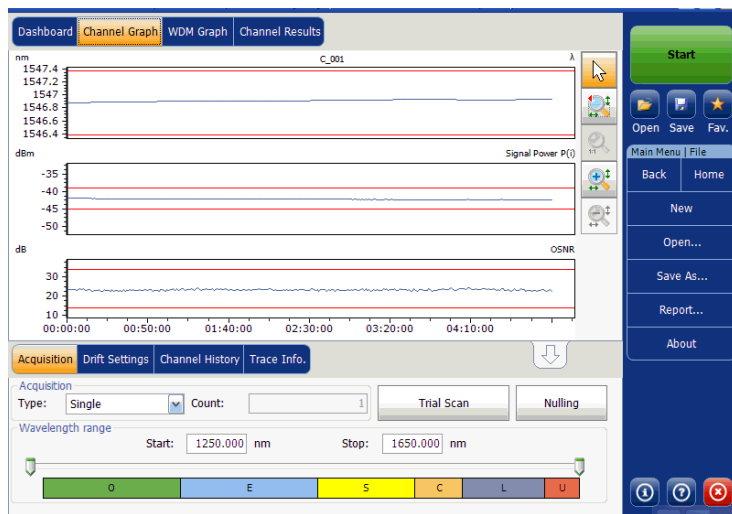

Managing Results

Managing Drift Test Results

Channel History Tab

The channel history table shows channel results for the active trace. The result is displayed for the selected channel only. The pass/fail verdict for thresholds are also displayed in the results table. If the verdict is fail for any parameter, its value will appear in red.

The application displays the progress of the measurement in the status bar, while the acquisition is taken. The Elapsed time and Expected duration for the measurement to stop is displayed in the **Channel History** tab.

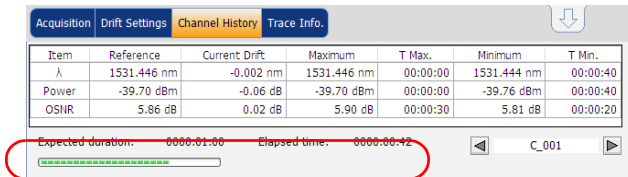

To view channel history results:

From the main window, select the **Channel History** tab.

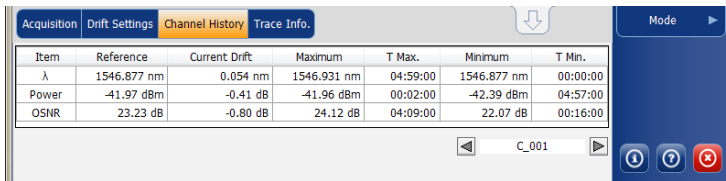

Results for the following parameters related to the selected channel are displayed in the **Channel History** table:

- Spectral position (center of mass of wavelength or frequency) of the channel against time (nm or THz)
- Signal power of the channel against time (dBm)
- OSNR of the channel against time (dB)

For each of the above parameters, the following results are displayed:

- Reference: channel reference values for the current drift acquired during the initial acquisition.
- Current Drift: current drift values, that is, the current deviation from the channel's reference for the drift's latest acquisition.
- Maximum: maximum values reached during the drift.
- T Max.: time of the drift at which the channel was at its maximum value. Displayed time is relative to the time at the start of the drift measurement.
- Minimum: minimum values reached during the drift.
- T Min.: time of the drift at which the channel was at its minimum value. Displayed time is relative to the time at the start of the drift measurement.

A small red marker (▼) will point down at the peak in the **WDM Graph** tab when you select a channel in the **Channel History** tab. The red marker will move accordingly to indicate the corresponding peak on the graph, with a focus on the selected channel.

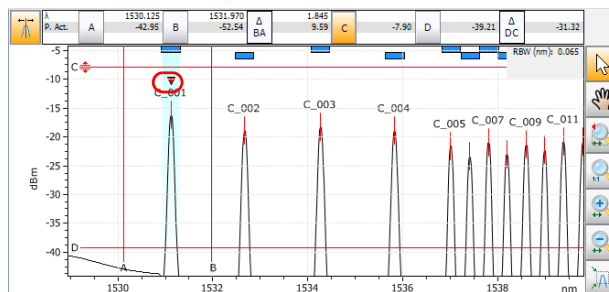

Managing Results

Managing Drift Test Results

WDM Graph Tab

The **WDM Graph** tab allows you to view the spectrum of the active trace for the last WDM acquisition in your drift measurement. This graph represents the optical power versus wavelength or frequency.

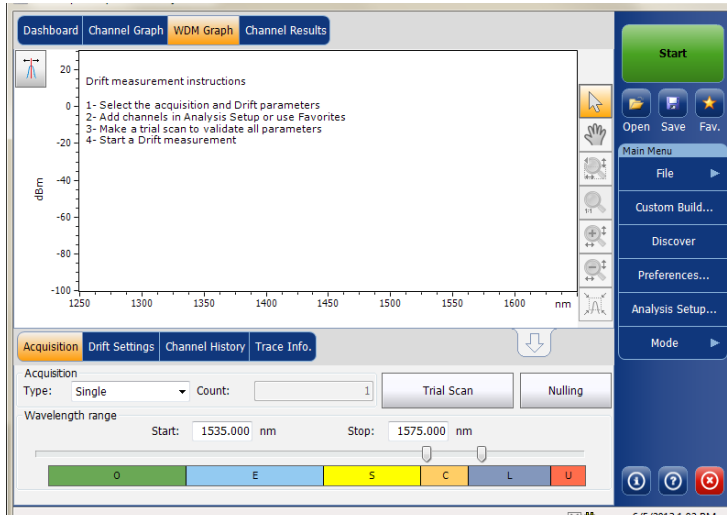

When the acquisition is taken (see *Starting a Measurement* on page 153 for details on how to perform a test), the active trace will be displayed in the tab with information along the following axis values:

- X axis: wavelength in nm or frequency in THz.
- Y axis: optical power expressed in dBm, as measured in the optical resolution bandwidth (RBW) of the OSA/OCA. This reference RBW is shown at the bottom of the graph.

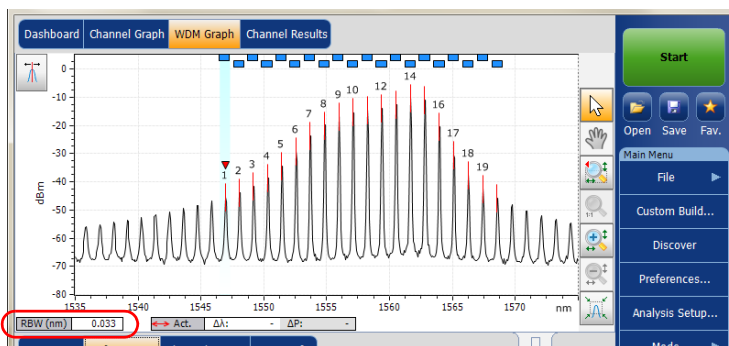

The graph will display peak indicators for all the channels found by the application with a red vertical line over the peaks to indicate the peak position.

A blue horizontal bar (■) will be displayed on the top of a channel if it does not overlap with another channel. If the channel overlaps with another channel, the horizontal bar will be yellow (■).

Managing Results

Managing Drift Test Results

Channel Results Tab

When you select a channel in the **Channel History** tab, the **Channel Results** tab will show complete information about the parameters measured for the selected channel. The pass/fail verdict for thresholds are also displayed in the **Channel Results** tab. If the verdict is fail for any parameter, its value appears in red. If the verdict is pass, its value appears in green.

To view channel results:

1. From the main window, select **Channel Results** tab.

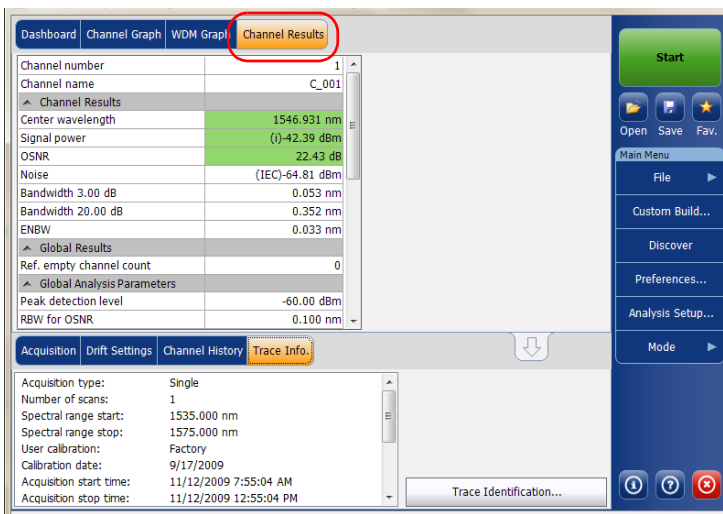

2. Select a channel from the **Channel History** tab to view the channel results for the selected channel.

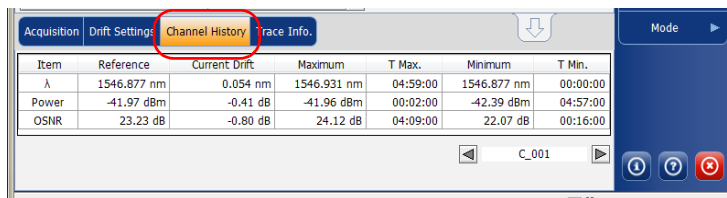

The screenshot shows a software interface with a table of test results. The 'Channel History' tab is highlighted with a red circle. The table has the following data:

Item	Reference	Current Drift	Maximum	T. Max.	Minimum	T Min.
λ	1546.877 nm	0.054 nm	1546.931 nm	04:59:00	1546.877 nm	00:00:00
Power	-41.97 dBm	-0.41 dB	-41.96 dBm	00:02:00	-42.39 dBm	04:57:00
OSNR	23.23 dB	-0.80 dB	24.12 dB	04:09:00	22.07 dB	00:16:00

Note: For details on each item, see Customizing WDM Results Table on page 57 and Defining General Settings on page 62.

Managing Results

Managing OCA Test Results

Managing OCA Test Results

The application allows you to view and manage your OCA test results. You can view the graph of your acquisition, channel results, total power, and information about the trace.

Note: *OCA measurement files (.ocawdm) are not compatible with the OSA application; they can only be opened by the OCA application.*

Note: *Viewing and modifying existing OCA measurement files is only possible with the module application; there is no post-processing application for this type of measurement.*

Graph

The graph allows you to view the spectrum of the trace. This graph represents the optical power against wavelength.

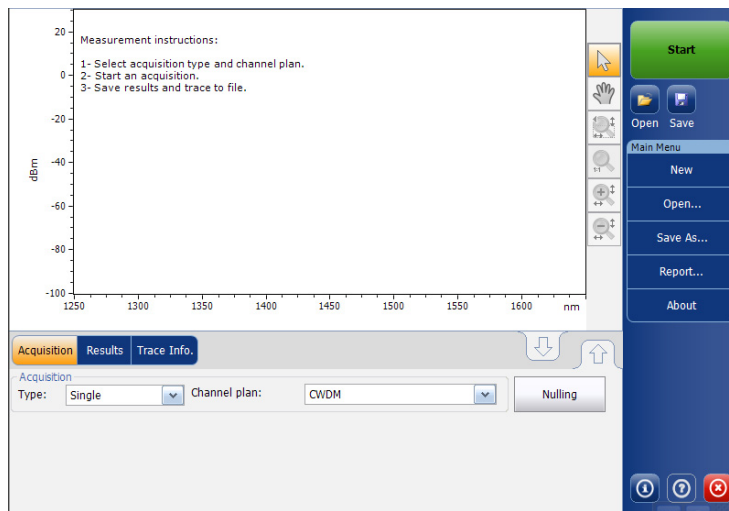

When the acquisition is taken (see *Starting a Measurement* on page 153 for details on how to perform a test), the trace will be displayed in the graph with information along the following axis values:

- X axis: wavelength in nm.
- Y axis: optical power expressed in dBm, as measured in the optical resolution bandwidth (RBW) of the module. This reference RBW is shown at the bottom of the graph.

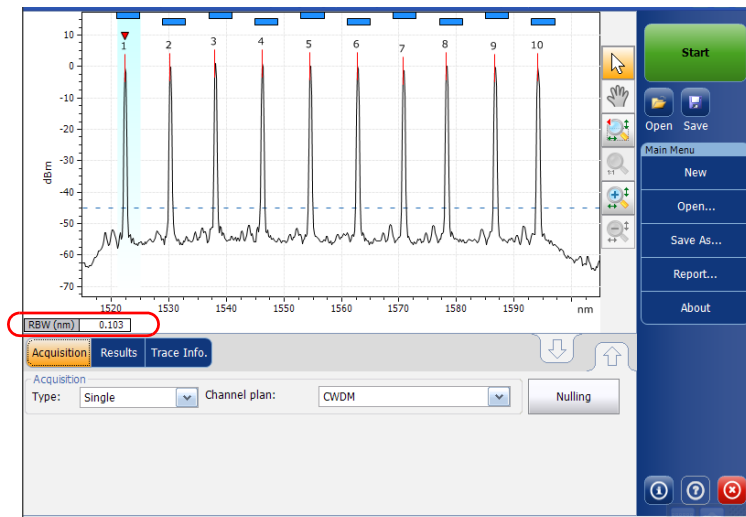

If the current trace was previously saved, the graph will display the file name of the current trace in the status bar.

The graph will display peak indicators for all the channels found by the application with a red vertical line over the peaks to indicate the peak position.

Managing Results

Managing OCA Test Results

The graph will display peak indicators for all the channels found by the application with a red vertical line over the peaks to indicate the peak position.

A blue horizontal bar (■) will be displayed on the top of a channel if it does not overlap with another channel. If the channel overlaps with another channel, the horizontal bar will be yellow (■).

The graph will also display the selected peak indicator; a small red inverted triangle (▼) pointing down at the top of the currently selected channel peak. In the graph zone, you can change the selected peak by clicking inside the peak limits of the desired channel. Peak selection in the graph is synchronized with the channel selection in lower tab results list; changing the selection in the graph modifies the selection in the list and vice-versa.

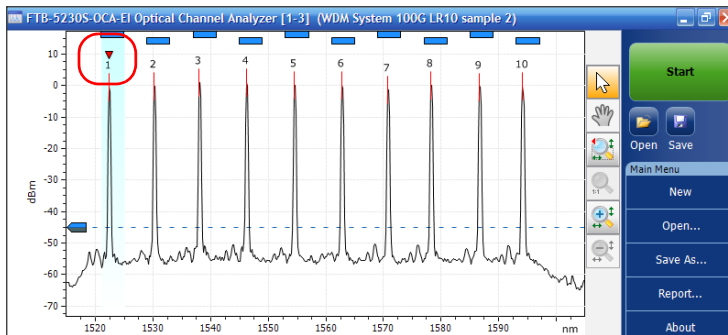

The graph will also display a dotted line across the full spectral width corresponding to the peak detection level indicator. This line indicates the minimum power level (dBm) from where a peak can be considered as a valid signal.

A peak detection level cursor is available in the graph when the **Results** tab is selected. The cursor is positioned along the Y-axis in accordance with the channel plan default peak detection level analysis parameter.

You can move the cursor to modify the peak detection level for the current measurement. Each time the cursor is moved, the trace is fully analyzed again using the currently selected channel plan.

Note: If you select another tab than **Results**, the cursor disappears, but you can still see the peak detection level indicator line.

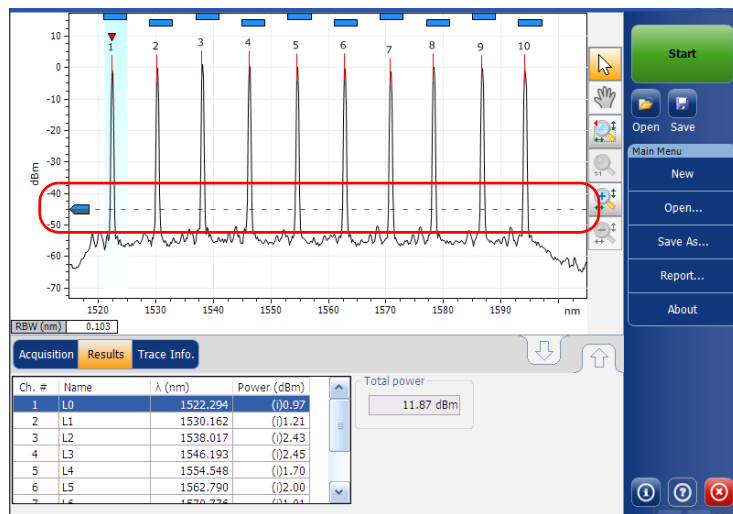

Managing Results

Managing OCA Test Results

Results Tab

The results table shows the current channel results for the trace and the total power in the scan range. Empty channel results will not be displayed in the channel list.

To view results:

From the main window, select the **Results** tab.

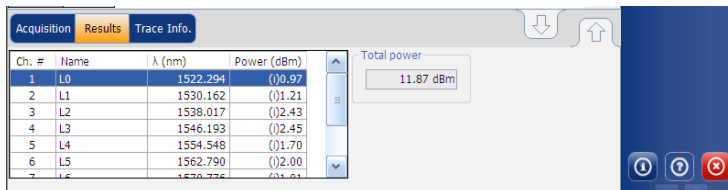

Ch. #	Name	λ (nm)	Power (dBm)
1	L0	1522.294	(0)0.97
2	L1	1530.162	(0)1.21
3	L2	1538.017	(0)2.43
4	L3	1546.193	(0)2.45
5	L4	1554.548	(0)1.70
6	L5	1562.790	(0)2.00
7	L6	1570.776	(0)1.01

Total power
11.87 dBm

Adjusting the Display Size

Your application allows you to toggle the view of your main window. You can change the view of the upper and lower tabs from the normal view to 100 % upper tabs or 100 % lower tabs view.

To adjust the display size:

For 100 % upper tabs view, press .

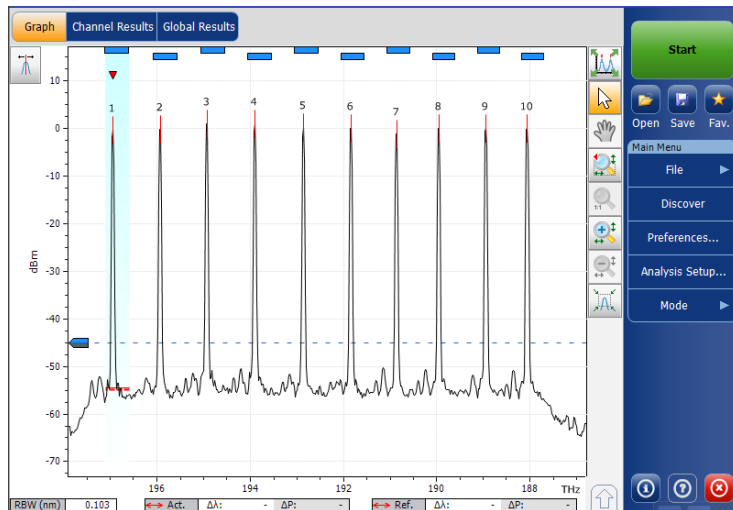

Managing Results

Adjusting the Display Size

For 100 % lower tabs view, press .

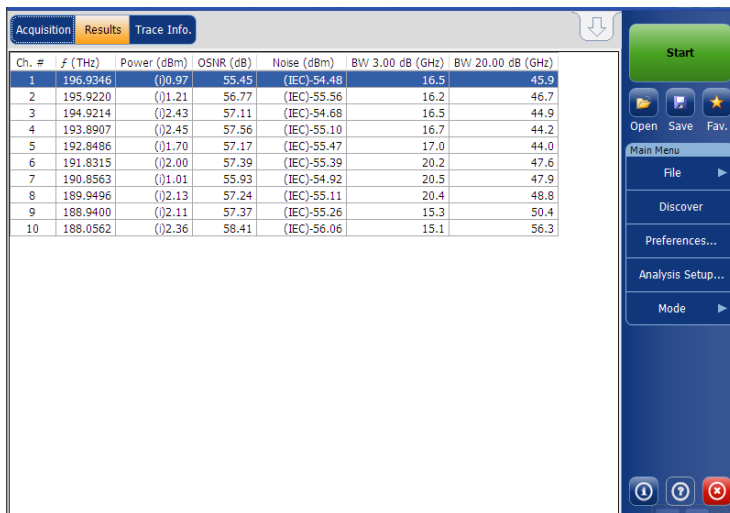

The screenshot displays a software interface with a table of results and a sidebar menu. The table has the following columns: Ch. #, f (THz), Power (dBm), OSNR (dB), Noise (dBm), BW 3.00 dB (GHz), and BW 20.00 dB (GHz). The data is as follows:

Ch. #	f (THz)	Power (dBm)	OSNR (dB)	Noise (dBm)	BW 3.00 dB (GHz)	BW 20.00 dB (GHz)
1	196.9346	(0)0.97	55.45	(IEC)-54.48	16.5	45.9
2	195.9220	(0)1.21	56.77	(IEC)-55.56	16.2	46.7
3	194.9214	(0)2.43	57.11	(IEC)-54.68	16.5	44.9
4	193.8907	(0)2.45	57.56	(IEC)-55.10	16.7	44.2
5	192.8486	(0)1.70	57.17	(IEC)-55.47	17.0	44.0
6	191.8315	(0)2.00	57.39	(IEC)-55.39	20.2	47.6
7	190.8563	(0)1.01	55.93	(IEC)-54.92	20.5	47.9
8	189.9496	(0)2.13	57.24	(IEC)-55.11	20.4	48.8
9	188.9400	(0)2.11	57.37	(IEC)-55.26	15.3	50.4
10	188.0562	(0)2.36	58.41	(IEC)-56.06	15.1	56.3

The sidebar menu on the right includes a 'Start' button, 'Open', 'Save', and 'Fav.' options, a 'Main Menu' section with 'File', 'Discover', 'Preferences...', 'Analysis Setup...', and 'Mode' options, and three circular icons at the bottom.

Viewing WDM Graph in Full-Screen Mode

The full-screen mode allows you to see the WDM graph, including the markers, using the whole screen of your unit. It also displays three lines of results.

If you have only one active trace, the results show three channels. If you have an active trace and a reference channel, you will see the results for one channel.

Note: This feature is not available for the OCA module.

To display the trace in full-screen mode:

Use the  button located on the upper right-hand section of the graph.

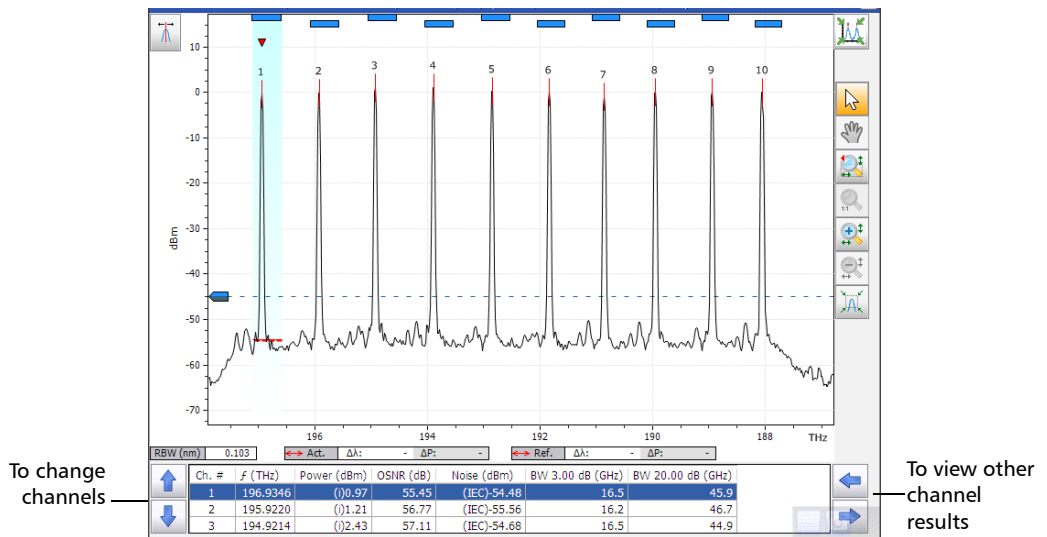

Using Zoom Controls

Use the zoom controls to change the scale of the trace display.

You can zoom in on or out of the graph using the corresponding buttons or let the application automatically adjust the zoom on the currently selected peak from the results table.

You can quickly zoom in on or out of a selected peak.

You can also return to the original graph value.

The application provides an automatic zoom on peak feature. When this feature is activated and you press on a row in the peak results grid, the graph will zoom and tab to show that peak covering 33 % of the graph canvas. By default, this option is deactivated.



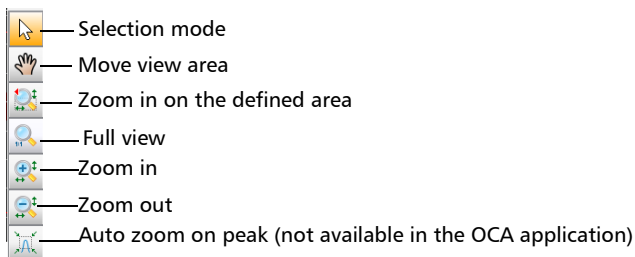

Note: *The auto zoom on peak feature is not available in the OCA application.*

Note: *You cannot select channels on the graph when the markers are displayed.*



Note: *You can only move the markers with the  button.*

To view specific portions of the graph:

- You can define which portion of the graph will be visible by pressing  and dragging the graph with the stylus or your finger.
- You can also zoom in on a specific area by pressing  and defining the zoom area with the stylus or your finger (a rectangle with dotted lines will appear to help you define the area). Once you release the stylus, the application automatically zooms in on the graph.
- You can zoom in or out on the center of the portion of the graph that is displayed by using, respectively,  or . The application automatically adjusts the zoom by 50 % and 100 % respectively.

To automatically zoom in on the selected peak:

Select the peak on the graph or in the table results and press .

To revert to the complete graph view:

Press .

Managing Markers

You can use markers to perform manual measurements and verification directly on the trace. All test modes feature two vertical markers and two horizontal markers. The vertical markers are used to indicate the power level on the trace at the wavelength or frequency it is positioned, and the horizontal markers are used for indicating power at the level they are. You can measure actual power and wavelength values of any point on the trace using the vertical markers.

Note: *Markers are not available in the OCA application.*

Note: *Horizontal markers will be displayed only if the markers are activated in the **Preferences** tab of the related test mode.*

Each marker is identified by a letter: A and B are for vertical markers, and C and D for horizontal markers.

The application allows you to fix the distance between the markers. When this feature is activated, while moving any one marker, both markers will move at the same rate and distance.

Markers A and B in the marker toolbar act as toggle buttons to enable selection. When a marker is activated, the color of the button changes to orange and the selected marker displays a double arrow at the base of the marker in the graph tab, which means that the marker can be moved.

At this point, if you select the other vertical marker in the graph tab, the selection of the toggle switches to this marker. However, if you select the other marker button from the marker toolbar, both markers will be selected and the distance between both will be locked.

Note: *If you select a vertical marker while the horizontal markers are active, the selection will toggle to the other type of marker and vice versa.*

Note: *If you zoom into the graph, or pan within it, the markers remain in their set positions.*

You can also use the automated marker positioning to place the markers around a specific channel peak. The positions are set from the results grid, according to the following by default:

- A: set at the peak wavelength “ λ Peak(nm)” or frequency “ f peak(Thz)”.
- B: set at the wavelength/frequency which corresponds to a 3 dB drop from the peak maximum power (Signal power “p” without subtracting the noise).
- C: set at the peak power (λ Peak).
- D: set at 3 dB below marker C.

If you move one of the markers, these new settings are kept for the next use of the automated markers until you reset them or select another zoom feature.

If the channel you select does not display a signal, the markers remain in the position that they were before.

To display the marker toolbar:

Press the  button on the top left-hand corner of the display.

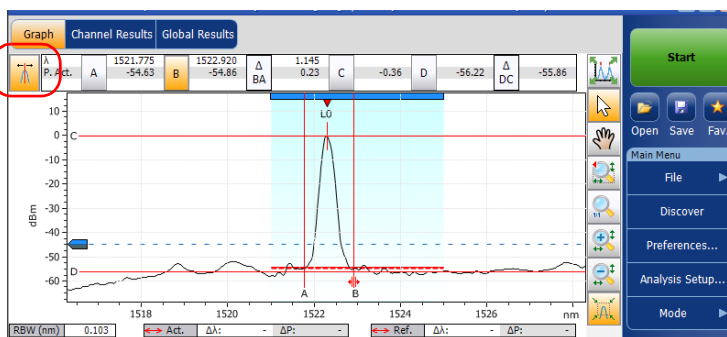

To display the automated markers:

Press the  button. The focus will be done on the currently selected channel in the **Results** tab.

Managing Results

Managing Markers

To manually enter a marker position value:

1. If you have not done so already, press the  button on the top left-hand corner of the display to make the marker toolbar appear.



2. Set the marker by entering precise values in the box corresponding to it or by dragging it on-screen.

As markers A and B appear on the graph, the following values will be displayed in the marker toolbar.

- power values corresponding to the wavelength position of both markers.
- wavelength or frequency difference between the markers (A-B)
- power difference in dB between the markers
- integrated power between the markers in dBm (when horizontal markers are hidden)
- power difference between the traces (active against reference or input against output) for both markers in dB (when horizontal markers are hidden).

As markers C and D appear on the graph, the power difference between the markers (C-D) related to the horizontal markers will be displayed in the marker toolbar.

You can also move the markers directly on the graph tab. Drag the marker to the desired area in the display. You will notice that the corresponding box in the marker toolbar changes according to the marker's position. If you want to set a precise value for the marker, simply enter it in the box.

Note: *After using the zoom tools in the graph tab, you can only move the markers again on the graph after deactivating the zoom. Pressing the arrow in the zoom tools section will deactivate the zoom function.*

Note: *Markers A and B cannot cross. Displacing a marker over the second one will cause both markers to move together.*

Managing Results

Managing Trace Information

Managing Trace Information

After acquiring a trace, you might want to view details about the acquisition. The **Trace Info.** tab shows information related to acquisition parameters and conditions. You can also edit information about the tested fiber and job or add comments. This information is saved along with the trace.

Note: Trace information is available for both active and reference traces, but you can edit only the trace information pertaining to the active trace.

Note: If you want to apply the settings of the **Trace Identification** window to the **Preferences** tab (or in the case of the OCA application, to the file name), select the **Use as template** option and press **OK**.

To view trace information parameters:

1. From the main window, select the **Trace Info.** tab.

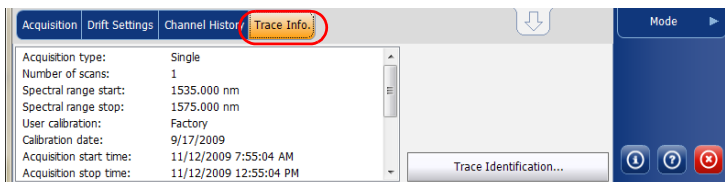

2. For some test types (if there is a reference trace), select which trace you want to view.

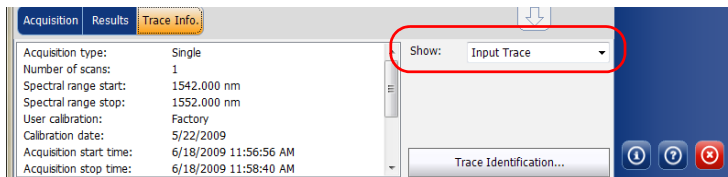

To edit general information:

1. From the main window, select the **Trace Info.** tab.
2. Press **Trace Identification.**

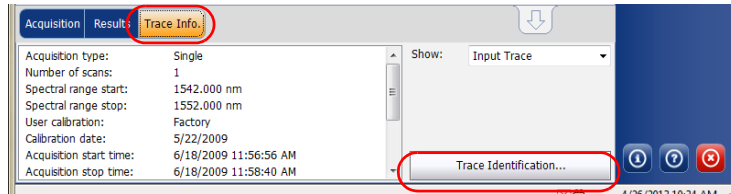

Note: Trace identification is not available for the WDM reference trace.

3. Select the **General** tab.

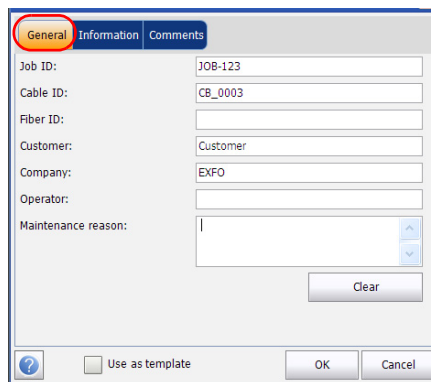

4. Edit the general information as required.
5. Press **OK** to save the changes and close the window, or press **Cancel** to exit without saving.

Press **Clear** to clear all the changes made in the **General** tab.

Note: In the OCA application, the cable ID and fiber ID information are used in the autonaming scheme. Any information entered in the two fields will be included in the file name.

Managing Results

Managing Trace Information

To edit trace information:

Note: This feature is not available in the OCA application.

1. From the main window, select the **Trace Info.** tab.
2. Press **Trace Identification.**

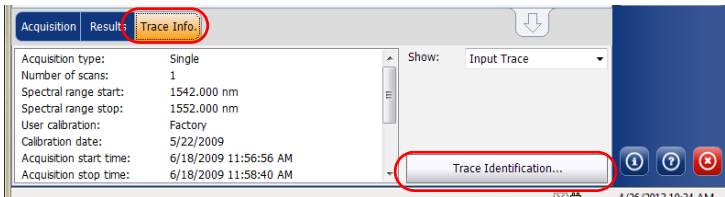

3. Select the **Information** tab.

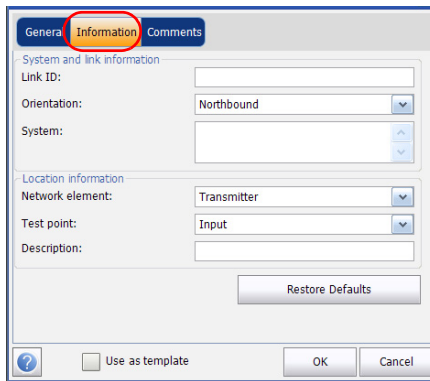

4. Edit the information as required.
5. Press **OK** to save the changes and close the window, or press **Cancel** to exit without saving.

Press **Restore Defaults** to remove all the changes and apply the default values.

To edit comments:

Note: This feature is not available in the OCA application.

1. From the main window, select the **Trace Info.** tab.
2. Press **Trace Identification.**

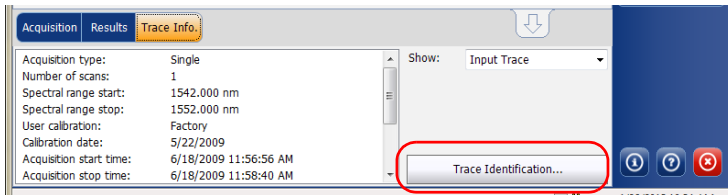

3. Select the **Comments** tab.

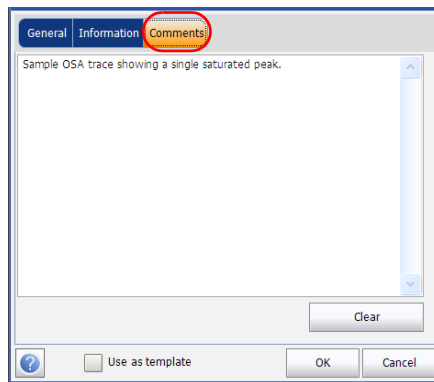

4. Edit comments in the **Comments** window for the current trace.
5. Press **OK** to save the changes and close the window, or press **Cancel** to exit without saving.

Press **Clear** to clear all the changes made in the **Comments** tab.

Managing Results

Generating Reports

Generating Reports

After performing any acquisition, you can generate a report for the current acquisition and save it in .html, PDF or .txt format depending on the supported file type for your test mode. The report file will include trace information, acquisition conditions and other results and details specific to each test mode.

Note: Empty channels that are shown on screen are included in the report files.

To generate a report:

1. From the **Main Menu**, select **File** (for the OCA application, skip step 1).
2. Press **Report**.

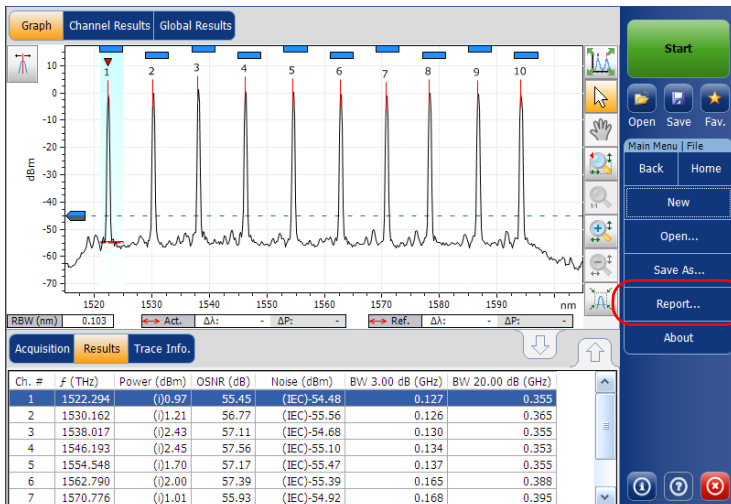

3. In the **Save As** window, enter a file name.

4. From the **Save as type** list, select the format for your report.

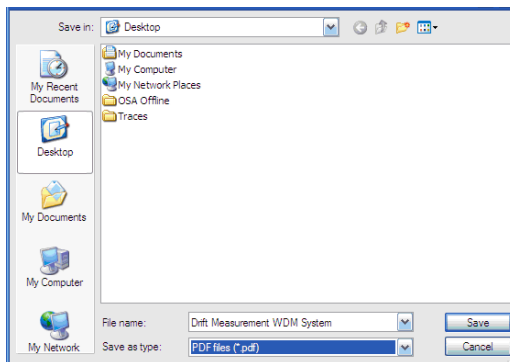

5. Press **Save**. The report will be added to the **Reports** folder. You can change the location where you want to save the report as desired.

11 Maintenance

To help ensure long, trouble-free operation:

- Always inspect fiber-optic connectors before using them and clean them if necessary.
- Keep the unit free of dust.
- Clean the unit casing and front panel with a cloth slightly dampened with water.
- Store unit at room temperature in a clean and dry area. Keep the unit out of direct sunlight.
- Avoid high humidity or significant temperature fluctuations.
- Avoid unnecessary shocks and vibrations.
- If any liquids are spilled on or into the unit, turn off the power immediately, disconnect from any external power source, remove the batteries and let the unit dry completely.



WARNING

The use of controls, adjustments and procedures other than those specified herein may result in exposure to hazardous situations or impair the protection provided by this unit.

Cleaning EUI Connectors

Regular cleaning of EUI connectors will help maintain optimum performance. There is no need to disassemble the unit.



IMPORTANT

If any damage occurs to internal connectors, the module casing will have to be opened and a new calibration will be required.

Maintenance

Cleaning EUI Connectors



WARNING

Looking into the optical connector while the light source is active **WILL** result in permanent eye damage. EXFO strongly recommends to **TURN OFF** the unit before proceeding with the cleaning procedure.

To clean EUI connectors:

1. Remove the EUI from the instrument to expose the connector baseplate and ferrule.

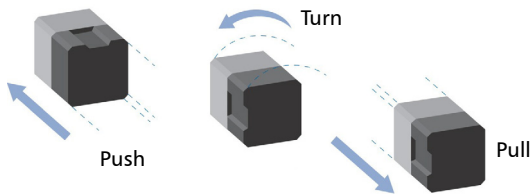

2. Moisten a 2.5 mm cleaning tip with *one drop* of isopropyl alcohol (alcohol may leave traces if used abundantly).
3. Slowly insert the cleaning tip into the EUI adapter until it comes out on the other side (a slow clockwise rotating movement may help).

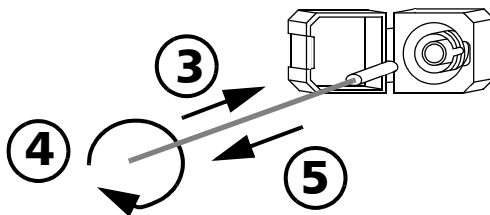

4. Gently turn the cleaning tip one full turn, then continue to turn as you withdraw it.
5. Repeat steps 3 to 4 with a dry cleaning tip.

Note: Make sure you don't touch the soft end of the cleaning tip.

6. Clean the ferrule in the connector port as follows:

6a. Deposit *one drop* of isopropyl alcohol on a lint-free wiping cloth.



IMPORTANT

Isopropyl alcohol may leave residues if used abundantly or left to evaporate (about 10 seconds).

Avoid contact between the tip of the bottle and the wiping cloth, and dry the surface quickly.

6b. Gently wipe the connector and ferrule.

6c. With a dry lint-free wiping cloth, gently wipe the same surfaces to ensure that the connector and ferrule are perfectly dry.

6d. Verify connector surface with a portable fiber-optic microscope (for example, EXFO's FOMS) or fiber inspection probe (for example, EXFO's FIP).

7. Put the EUI back onto the instrument (push and turn clockwise).

8. Throw out cleaning tips and wiping cloths after one use.

Recalibrating the Unit

EXFO manufacturing and service center calibrations are based on the ISO/IEC 17025 standard (*General Requirements for the Competence of Testing and Calibration Laboratories*). This standard states that calibration documents must not contain a calibration interval and that the user is responsible for determining the re-calibration date according to the actual use of the instrument.

The validity of specifications depends on operating conditions. For example, the calibration validity period can be longer or shorter depending on the intensity of use, environmental conditions and unit maintenance, as well as the specific requirements for your application. All of these elements must be taken into consideration when determining the appropriate calibration interval of this particular EXFO unit.

Under normal use, the recommended interval for your FTB-5230S/-OCA Optical Spectrum and Channel Analyzers is: one year.

For newly delivered units, EXFO has determined that the storage of this product for up to six months between calibration and shipment does not affect its performance (EXFO Policy PL-03).

To help you with calibration follow-up, EXFO provides a special calibration label that complies with the ISO/IEC 17025 standard and indicates the unit calibration date and provides space to indicate the due date. Unless you have already established a specific calibration interval based on your own empirical data and requirements, EXFO would recommend that the next calibration date be established according to the following equation:

Next calibration date = Date of first usage (if less than six months after the calibration date) + Recommended calibration period (one year)

To ensure that your unit conforms to the published specifications, calibration may be carried out at an EXFO service center or, depending on the product, at one of EXFO's certified service centers. Calibrations at EXFO are performed using standards traceable to national metrology institutes.

Note: *You may have purchased a FlexCare plan that covers calibrations. See the Service and Repairs section of this user documentation for more information on how to contact the service centers and to see if your plan qualifies.*

Recycling and Disposal (Applies to European Union Only)

For complete recycling/disposal information as per European Directive WEEE 2012/19/UE, visit the EXFO Web site at www.exfo.com/recycle.

12 Troubleshooting

Viewing Online Documentation

In addition to the online help available from the application, you will also find a printable PDF version on your installation DVD.

To access online help:

At the bottom of the **Main Menu**, tap .

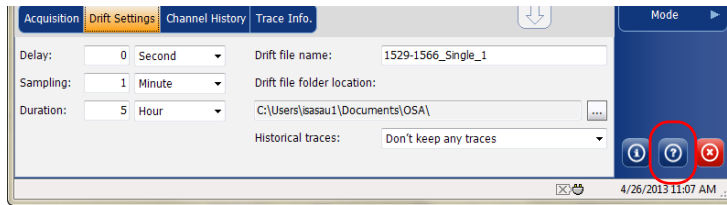

Troubleshooting

Contacting the Technical Support Group

Contacting the Technical Support Group

To obtain after-sales service or technical support for this product, contact EXFO at one of the following numbers. The Technical Support Group is available to take your calls from Monday to Friday, 8:00 a.m. to 7:00 p.m. (Eastern Time in North America).

Technical Support Group

400 Godin Avenue
Quebec (Quebec) G1M 2K2
CANADA

1 866 683-0155 (USA and Canada)
Tel.: 1 418 683-5498
Fax: 1 418 683-9224
support@exfo.com

For detailed information about technical support, and for a list of other worldwide locations, visit the EXFO Web site at www.exfo.com.

If you have comments or suggestions about this user documentation, you can send them to customer.feedback.manual@exfo.com.

To accelerate the process, please have information such as the name and the serial number (see the product identification label), as well as a description of your problem, close at hand.

You may also be requested to provide software and module version numbers. This information, as well as technical support contact information, can be found in the **About** window.

To view the information about the product:

From the Main Menu, press .

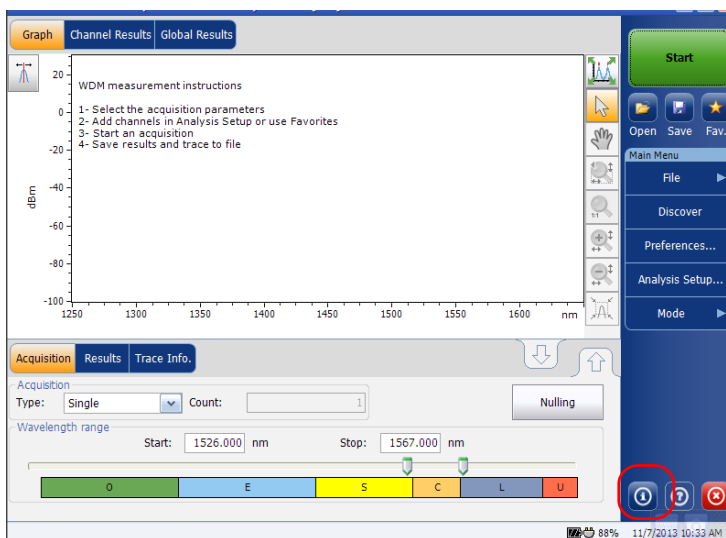

Transportation

Maintain a temperature range within specifications when transporting the unit. Transportation damage can occur from improper handling. The following steps are recommended to minimize the possibility of damage:

- Pack the unit in its original packing material when shipping.
- Avoid high humidity or large temperature fluctuations.
- Keep the unit out of direct sunlight.
- Avoid unnecessary shocks and vibrations.



IMPORTANT

Keep this information close at hand, as it contains important details about your product.



CAUTION

- Always use the GP-10-055 case when transporting the FTB-5230S module. EXFO does not recommend transporting the modules in a platform and/or in a case other than the one designed for your specific module.
- Handle the case with care when transporting the module.
- Please follow these guidelines. Modules damaged from rough handling during transport or shipment are not covered by any EXFO warranty.

The following image show the GP-10-055 case with the module inside.



13 Warranty

General Information

EXFO Inc. (EXFO) warrants this equipment against defects in material and workmanship for a period of 1 year from the date of original shipment. EXFO also warrants that this equipment will meet applicable specifications under normal use.

During the warranty period, EXFO will, at its discretion, repair, replace, or issue credit for any defective product, as well as verify and adjust the product free of charge should the equipment need to be repaired or if the original calibration is erroneous. If the equipment is sent back for verification of calibration during the warranty period and found to meet all published specifications, EXFO will charge standard calibration fees.



IMPORTANT

The warranty can become null and void if:

- unit has been tampered with, repaired, or worked upon by unauthorized individuals or non-EXFO personnel.
- warranty sticker has been removed.
- case screws, other than those specified in this guide, have been removed.
- case has been opened, other than as explained in this guide.
- unit serial number has been altered, erased, or removed.
- unit has been misused, neglected, or damaged by accident.

THIS WARRANTY IS IN LIEU OF ALL OTHER WARRANTIES EXPRESSED, IMPLIED, OR STATUTORY, INCLUDING, BUT NOT LIMITED TO, THE IMPLIED WARRANTIES OF MERCHANTABILITY AND FITNESS FOR A PARTICULAR PURPOSE. IN NO EVENT SHALL EXFO BE LIABLE FOR SPECIAL, INCIDENTAL, OR CONSEQUENTIAL DAMAGES.

Warranty

Liability

Liability

EXFO shall not be liable for damages resulting from the use of the product, nor shall be responsible for any failure in the performance of other items to which the product is connected or the operation of any system of which the product may be a part.

EXFO shall not be liable for damages resulting from improper usage or unauthorized modification of the product, its accompanying accessories and software.

Exclusions

EXFO reserves the right to make changes in the design or construction of any of its products at any time without incurring obligation to make any changes whatsoever on units purchased. Accessories, including but not limited to fuses, pilot lamps, batteries and universal interfaces (EUI) used with EXFO products are not covered by this warranty.

This warranty excludes failure resulting from: improper use or installation, normal wear and tear, accident, abuse, neglect, fire, water, lightning or other acts of nature, causes external to the product or other factors beyond the control of EXFO.



IMPORTANT

In the case of products equipped with optical connectors, EXFO will charge a fee for replacing connectors that were damaged due to misuse or bad cleaning.

Certification

EXFO certifies that this equipment met its published specifications at the time of shipment from the factory.

Service and Repairs

EXFO commits to providing product service and repair for five years following the date of purchase.

To send any equipment for service or repair:

1. Call one of EXFO's authorized service centers (see *EXFO Service Centers Worldwide* on page 233). Support personnel will determine if the equipment requires service, repair, or calibration.
2. If equipment must be returned to EXFO or an authorized service center, support personnel will issue a Return Merchandise Authorization (RMA) number and provide an address for return.
3. If possible, back up your data before sending the unit for repair.
4. Pack the equipment in its original shipping material. Be sure to include a statement or report fully detailing the defect and the conditions under which it was observed.
5. Return the equipment, prepaid, to the address given to you by support personnel. Be sure to write the RMA number on the shipping slip. *EXFO will refuse and return any package that does not bear an RMA number.*

Note: *A test setup fee will apply to any returned unit that, after test, is found to meet the applicable specifications.*

After repair, the equipment will be returned with a repair report. If the equipment is not under warranty, you will be invoiced for the cost appearing on this report. EXFO will pay return-to-customer shipping costs for equipment under warranty. Shipping insurance is at your expense.

Routine recalibration is not included in any of the warranty plans. Since calibrations/verifications are not covered by the basic or extended warranties, you may elect to purchase FlexCare Calibration/Verification Packages for a definite period of time. Contact an authorized service center (see *EXFO Service Centers Worldwide* on page 233).

EXFO Service Centers Worldwide

If your product requires servicing, contact your nearest authorized service center.

EXFO Headquarters Service Center

400 Godin Avenue
Quebec (Quebec) G1M 2K2
CANADA

1 866 683-0155 (USA and Canada)
Tel.: 1 418 683-5498
Fax: 1 418 683-9224
support@exfo.com

EXFO Europe Service Center

Winchester House, School Lane
Chandlers Ford, Hampshire S053 4DG
ENGLAND

Tel.: +44 2380 246800
Fax: +44 2380 246801
support.europe@exfo.com

EXFO Telecom Equipment (Shenzhen) Ltd.

3rd Floor, Building 10,
Yu Sheng Industrial Park (Gu Shu
Crossing), No. 467,
National Highway 107,
Xixiang, Bao An District,
Shenzhen, China, 518126

Tel: +86 (755) 2955 3100
Fax: +86 (755) 2955 3101
support.asia@exfo.com

A Technical Specifications



IMPORTANT

The following technical specifications can change without notice. The information presented in this section is provided as a reference only. To obtain this product's most recent technical specifications, visit the EXFO Web site at www.exfo.com.

SPECTRAL MEASUREMENT	
Wavelength range (nm)	1250 to 1650
Wavelength uncertainty (nm) ^b	±0.05 ±0.02 ^{c, d}
Reference	Internal ^e
Resolution bandwidth (FWHM) ^f (nm)	0.10 ^{b, d}
Wavelength repeatability 2σ (nm)	±0.005 ^g
Analysis modes	WDM and drift (FTB-5230S) / Optical Channel Analyzer mode (FTB-5230S-OCA)

POWER MEASUREMENT	
Dynamic range (dBm) (per channel) ^b	-65 ^d to 23 dB
Maximum total safe power (dBm)	29
Absolute power uncertainty (dB) ^h	±0.6 (0.4 typical)
Power repeatability 2σ (dB) ^{i, g}	±0.1

OPTICAL MEASUREMENT	
Optical rejection ratio at 1550 nm (dB)	
at 0.2 nm (25 GHz)	31 (35 typical)
at 0.4 nm (50 GHz)	40 (45 typical)
Channel spacing	33 to 200 GHz CWDM
PDL at 1550 nm (dB)	±0.1 ^d
ORL (dB)	>37
Measurement time (s) ^{d, i} (includes scanning, analysis and display)	1 (with the FTB-500 Platform)

GENERAL SPECIFICATIONS		
Temperature	operating storage	0 °C to 40 °C (32 °F to 104 °F) -20 °C to 50 °C (-4 °F to 120 °F)
Connectors		EI (EXFO UPC Universal Interface) EA (EXFO APC Universal Interface)
Size (H x W x D)	FTB-5230S module	96 mm x 51 mm x 260 mm (3 ¾ in x 2 in x 10 ¼ in)
Weight	FTB-5230S module	1.5 kg (3.3 lb)

Notes

- All specifications are for a temperature of 23 °C ± 2 °C with an FC/UPC connector unless otherwise specified, after warm-up.
- From 1520 to 1600 nm.
- For FTB-5230S only. After user calibration in the same test session within 10 nm from each calibration point.
- Typical.
- Integrated and wavelength-independent self-adjustment.
- Full width at half maximum.
- Over one minute in continuous acquisition mode.
- At 1550 nm, -10 dBm input.
- 40 nm span.

Index

- A**
- acquisition
 - averaging..... 86, 131
 - real-time..... 86, 149
 - single..... 86, 131, 149
 - type..... 36
 - activating
 - default channel..... 64, 111
 - thresholds..... 73, 122
 - after-sales service..... 224
 - analysis parameters
 - drift..... 107
 - WDM..... 59
 - analysis setup
 - discover feature..... 155
 - importing..... 168
 - application
 - exiting..... 14
 - starting, single-module..... 12
 - average
 - OSNR..... 73
 - signal power..... 73
 - averaging
 - acquisition..... 131
 - acquisition type..... 86
- B**
- bandwidth
 - at 3 dB..... 58
 - at x dB..... 58, 69, 116
 - resolution..... 115
 - resolution for OSNR..... 68
- C**
- cable ID..... 36
 - caution
 - of personal hazard..... 4
 - of product hazard..... 4
 - center
 - frequency..... 58, 77, 106
 - wavelength..... 58, 77, 106
 - certification information..... v
 - channel
 - center, wavelength or frequency ... 80, 125
 - count, empty..... 73
 - increment value..... 126
 - increment value, name..... 81
 - name..... 58
 - noise..... 58
 - reference value..... 191
 - results..... 182
 - spacing..... 80, 126
 - spectral peak..... 59
 - total power..... 66, 113
 - width..... 65, 80, 112, 126
 - cleaning
 - EUI connectors..... 217
 - fiber ends..... 15
 - front panel..... 217
 - clearing trace..... 161
 - comments, entering..... 48
 - connectors, cleaning..... 217
 - conventions, safety..... 4
 - current drift value..... 191
 - customer service..... 232
 - customized drift measurement..... 138
 - customizing
 - drift results..... 105
 - WDM results..... 57

Index

D

default	
channel, activating	64, 111
thresholds.....	74
deleting	
test configuration	171
trace	161
description of location	47, 96
detecting module.....	9
detection level, peak	68, 115
deviation	
spectral center of mass	59
spectral peak	59
wavelength.....	122, 183
discover feature.....	155
display parameter	50
distance	
channel.....	80
OSNR	67, 114
drift	
current value	191
customized measurement.....	138
maximum value	191
minimum value.....	191
mode.....	91
parameters	107
preferences.....	93
time for minimum value	191

E

electrical offsets, nulling	20
element, network.....	47
empty channel count	73
end range.....	125
entering comments	48
equipment returns	232
EUI	
connector adapter	17
dust cap.....	17
EUI connectors, cleaning	217
exiting application.....	14

F

fail threshold limits.....	119
fiber ends, cleaning	15
fiber ID	36
fifth order polynomial fit.....	67, 114
files	
managing	158
opening	159
saving	158
fit	
fifth order polynomial.....	67, 114
zone.....	67, 114
flatness	
OSNR	73
signal power	73
frequency	
center	58, 106
central.....	77
channel center	80, 125
range	36
front panel, cleaning	217

G

general preferences	62, 93
generating report	214
global results.....	70, 184
graph tab	176, 196

H

help. see online user guide

I

ID prefix link	96
identification label.....	224
importing analysis setup.....	168
increment channel value.....	81, 126
information	
link and location	45
system under test	96

inserting a module 7
 integrated power 65, 112
 ITU grid 65, 112

L

label, identification 224
 level noise 77
 link
 ID 36
 information 45
 orientation 46, 96
 prefix 46, 96
 starting value 46, 81, 96, 126
 location
 description 36, 47, 96
 information 45

M

maintenance
 EUI connectors 217
 front panel 217
 general information 217
 managing
 results 175
 traces 158
 markers 206
 maximum
 drift value 191
 time for drift 191
 measurement
 customized, drift 138
 starting 153
 minimum
 time value, drift 191
 value during drift 191
 warm up period 15
 mode
 drift 91
 test 3
 WDM 41

module
 detection 9
 insertion 7
 removal 7
 mounting EUI connector adapter 17

N

name
 channel 58
 prefix 80, 126
 network element 47, 96
 noise
 channel 58, 77
 curve calculation 67, 114
 OSNR 66, 113
 region 67, 114
 nulling electrical offsets 20

O

OCA
 setting up mode 149
 test results 196
 offline application 3
 offset
 nulling 20
 power 69, 116
 wavelength 69, 116
 online user guide 223
 opening files
 other formats in WDM mode 162
 trace 159
 options 3
 orientation, link 46, 96
 OSA
 description 2
 offline 3
 typical applications 2
 OSNR 58, 77, 106, 122
 average 73
 distance 67, 114
 flatness 73

Index

noise.....	66, 113
resolution bandwidth	68
P	
parameters	
display	50
drift	107
general	62
pass threshold limits	119
PDF. see online user guide	
peak	
detection level	68, 115
indicator	178, 191, 198
signal power.....	66, 113
polyfit method	67, 114
post-processing application	3
power	
difference	208
integrated.....	65, 112, 208
offset.....	69, 116
peak.....	66, 113
signal.....	58, 65, 77, 106, 112, 122
total channel	66, 113
preferences	
comments.....	48
drift	93
general	43, 93
information	45
WDM	43
prefix	
link ID	96
name	80, 126
preparing OSA for a test	15
product	
identification label.....	224
specifications.....	235

R

range	
frequency.....	36
start	80, 125
stop	80, 125
wavelength	36
real-time acquisition mode.....	86, 149
reference, channel	191
region, noise.....	67, 114
removing a module	7
report, generating	214
resolution bandwidth	115
resolution bandwidth, OSNR	68
results.....	57
channels.....	182
customizing	105
global	70
tab	184
viewing	175
return merchandise authorization (RMA) ..	232

S

safety	
caution	4
conventions	4
warning	4
saving traces.....	158
scan count.....	36
service and repairs.....	232
service centers	233
setting up OCA mode.....	149
setting up WDM mode	41
settings, general.....	62
setup	
analysis	155
importing.....	168
shipping to EXFO.....	232
signal power.....	66
average	73
calculation	65, 112
channel.....	58, 77, 106, 122

flatness 73
 peak..... 113
 signal to noise ratio..... 67, 114
 single acquisition mode 86, 131, 149
 snap to ITU grid 65, 112
 software packages 3
 software. see application
 spacing, channels..... 126
 specifications, product 235
 spectral center of mass, deviation 59
 spectral peak..... 59
 spectral peak, deviation 59
 start range 80, 125
 starting measurement..... 153
 starting value, link..... 81, 96, 126
 stop range..... 125
 storage requirements 217
 symbols, safety..... 4
 system information 46, 96

T

T max 191
 T min for drift..... 191
 tab, graph 176, 196
 technical specifications..... 235
 technical support 224
 temperature for storage..... 217
 test
 configuration, deleting 171
 modes..... 3
 point..... 47, 96
 results, WDM..... 176
 test results, OCA..... 196
 threshold limits 119
 thresholds
 activating..... 73, 122
 default..... 74
 time of drift for maximum value 191
 total channel power 66, 113

trace
 clearing 161
 managing 158
 opening 159
 saving 158
 transportation requirements..... 217, 226
 typical applications..... 2

U

user guide. see online user guide

V

value
 channel name, increment 81
 link start..... 126

W

warm up period..... 15
 warranty
 certification..... 231
 exclusions 231
 general..... 229
 liability..... 230
 null and void..... 229
 wavelength
 center..... 58, 106
 central..... 77
 channel center 80, 125
 deviation..... 122, 183
 difference..... 208
 offset 69, 116
 range 36

Index

WDM

analysis parameters	59
general settings	62
opening files in other formats	162
results, customizing	105
setting up mode	41
test results	176
width, channels	65, 80, 112, 126

Z

zoom controls	204
---------------------	-----

NOTICE

通告

CHINESE REGULATION ON RESTRICTION OF HAZARDOUS SUBSTANCES

中国关于危害物质限制的规定

NAMES AND CONTENTS OF THE TOXIC OR HAZARDOUS SUBSTANCES OR ELEMENTS CONTAINED IN THIS EXFO PRODUCT



包含在本 **EXFO** 产品中的有毒有害物质或元素的名称和含量

O	Indicates that this toxic or hazardous substance contained in all of the homogeneous materials for this part is below the limit requirement in SJ/T11363-2006 表示该有毒有害物质在该部件所有均质材料中的含量均在 SJ/T11363-2006 标准规定的限量要求以下。
X	Indicates that this toxic or hazardous substance contained in at least one of the homogeneous materials used for this part is above the limit requirement in SJ/T11363-2006 表示该有毒有害物质至少在该部件的某一均质材料中的含量超出 SJ/T11363-2006 标准规定的限量要求。

Part Name 部件名称	Toxic or hazardous Substances and Elements 有毒有害物质和元素					
	Lead 铅 (Pb)	Mercury 汞 (Hg)	Cadmium 镉 (Cd)	Hexavalent Chromium 六价铬 (Cr VI)	Polybrominated biphenyls 多溴联苯 (PBB)	Polybrominated diphenyl ethers 多溴二苯醚 (PBDE)
Enclosure 外壳	O	O	O	O	O	O
Electronic and electrical sub-assembly 电子和电子组件	X	O	X	O	X	X
Optical sub-assembly ^a 光学组件 ^a	X	O	O	O	O	O
Mechanical sub-assembly ^a 机械组件 ^a	O	O	O	O	O	O

- a. If applicable.
如果适用。

MARKING REQUIREMENTS
标注要求

Product 产品	Environmental protection use period (years) 环境保护使用期限 (年)	Logo 标志
This Exfo product 本 EXFO 产品	10	
Battery ^a 电池 ^a	5	

- a. If applicable.
如果适用。

P/N: 1065480

www.EXFO.com · info@exfo.com

CORPORATE HEADQUARTERS	400 Godin Avenue	Quebec (Quebec) G1M 2K2 CANADA Tel.: 1 418 683-0211 · Fax: 1 418 683-2170
EXFO AMERICA	3400 Waterview Parkway Suite 100	Richardson, TX 75080 USA Tel.: 1 972-761-927 · Fax: 1 972-761-9067
EXFO EUROPE	Winchester House, School Lane	Chandlers Ford, Hampshire S053 4DG ENGLAND Tel.: +44 2380 246 800 · Fax: +44 2380 246 801
EXFO ASIA-PACIFIC	100 Beach Road, #25-01/03 Shaw Tower	SINGAPORE 189702 Tel.: +65 6333 8241 · Fax: +65 6333 8242
EXFO CHINA	Beijing Global Trade Center, Tower C, Room 1207, 36 North Third Ring Road East, Dongcheng District	Beijing 100013 P. R. CHINA Tel.: +86 (10) 5825 7755 · Fax: +86 (10) 5825 7722
EXFO SERVICE ASSURANCE	270 Billerica Road	Chelmsford MA, 01824 USA Tel.: 1 978 367-5600 · Fax: 1 978 367-5700
EXFO FINLAND	Elektroniikkatie 2	FI-90590 Oulu, FINLAND Tel.: +358 (0) 403 010 300 · Fax: +358 (0) 8 564 5203
TOLL-FREE	(USA and Canada)	1 800 663-3936

© 2013 EXFO Inc. All rights reserved.
Printed in Canada (2013-11)

