

---

# FTB-5700

Single-Ended Dispersion Analyzer  
for FTB-200



---

Copyright © 2007–2010 EXFO Inc. All rights reserved. No part of this publication may be reproduced, stored in a retrieval system or transmitted in any form, be it electronically, mechanically, or by any other means such as photocopying, recording or otherwise, without the prior written permission of EXFO Inc. (EXFO).

Information provided by EXFO is believed to be accurate and reliable. However, no responsibility is assumed by EXFO for its use nor for any infringements of patents or other rights of third parties that may result from its use. No license is granted by implication or otherwise under any patent rights of EXFO.

EXFO's Commerce And Government Entities (CAGE) code under the North Atlantic Treaty Organization (NATO) is 0L8C3.

The information contained in this publication is subject to change without notice.

### ***Trademarks***

EXFO's trademarks have been identified as such. However, the presence or absence of such identification does not affect the legal status of any trademark.

### ***Units of Measurement***

Units of measurement in this publication conform to SI standards and practices.

EXFO's Universal Interface is protected by US patent 6,612,750.

Protected by international PCT patent application (published under WO2007/036051) and several other pending applications.

Version number: 5.0.1

# Contents

Certification Information .....	v
<b>1 Introducing the FTB-5700 Single-Ended Dispersion Analyzer .....</b>	<b>1</b>
Module Description .....	2
Typical Applications .....	2
Basic FTB-5700 Single-Ended Dispersion Analyzer Operation .....	3
Conventions .....	5
<b>2 Safety Information .....</b>	<b>7</b>
<b>3 Getting Started with the Single-Ended Dispersion Analyzer .....</b>	<b>9</b>
Inserting and Removing Test Modules .....	9
Starting Module Applications .....	15
<b>4 Setting Up the Single-Ended Dispersion Analyzer .....</b>	<b>17</b>
Setting up Application Details .....	17
Customizing Thresholds .....	22
Setting the Wavelength Range .....	24
Setting PMD and CD Acquisition Parameters .....	26
Defining the Automatic Fiber Name Format .....	29
Managing Test Configurations .....	30
Setting Test Preferences .....	34
<b>5 Operating the Single-Ended Dispersion Analyzer .....</b>	<b>37</b>
Cleaning and Connecting Optical Fibers .....	37
Installing the EXFO Universal Interface (EUI) .....	39
Performing a Test .....	40
<b>6 Managing Results .....</b>	<b>45</b>
Modifying Analysis Parameters and Related Information .....	48
Opening Existing Files .....	56
Removing Unwanted Results .....	57
Closing Result Files .....	58
Generating a Report .....	59
<b>7 Maintenance .....</b>	<b>61</b>
Cleaning EUI Connectors .....	62
Recalibrating the Unit .....	64
Recycling and Disposal (Applies to European Union Only) .....	65

## Contents

---

<b>8 Troubleshooting</b> .....	<b>67</b>
Solving Common Problems .....	67
Obtaining Online Help .....	74
Contacting the Technical Support Group .....	75
Transportation .....	76
<b>9 Warranty</b> .....	<b>77</b>
General Information .....	77
Liability .....	78
Exclusions .....	79
Certification .....	79
Service and Repairs .....	80
EXFO Service Centers Worldwide .....	81
<b>A Technical Specifications</b> .....	<b>83</b>
<b>Index</b> .....	<b>85</b>

## Certification Information

### **F.C.C. Information**

Electronic test equipment is exempt from Part 15 compliance (FCC) in the United States. However, compliance verification tests are systematically performed on most EXFO equipment.

### **CE Information**

Electronic test equipment is subject to the EMC Directive in the European Union. The EN61326 standard prescribes both emission and immunity requirements for laboratory, measurement, and control equipment. This unit has undergone extensive testing according to the European Union Directive and Standards.

# Certification Information

---

## **EXFO** **CE** **DECLARATION OF CONFORMITY**

Application of Council Directive(s):	2006/95/EC - The Low Voltage Directive 2004/108/EC - The EMC Directive 2006/66/EC - The Battery Directive 93/68/EEC - CE Marking And their amendments
Manufacturer's Name:	EXFO Inc.
Manufacturer's Address:	400 Godin Avenue Quebec, Quebec Canada, G1M 2K2 (418) 683-0211
Equipment Type/Environment:	Test & Measurement / Industrial
Trade Name/Model No.:	Single-Ended Dispersion Analyzer / FTB-5700

**Standard(s) to which Conformity is Declared:**

<b>EN 61010-1:2001 Edition 2.0</b>	<b>Safety Requirements for Electrical Equipment for Measurement, Control, and Laboratory Use, Part 1: General Requirements.</b>
<b>EN 61326-1:2006</b>	<b>Electrical Equipment for Measurement, Control and Laboratory Use - EMC Requirements – Part 1: General requirements</b>
<b>EN 60825-1:2007 Edition 2.0</b>	<b>Safety of laser products – Part 1: Equipment classification, requirements, and user's guide</b>
<b>EN 55022: 2006 + A1: 2007</b>	<b>Information technology equipment - Radio disturbance characteristics - Limits and methods of measurement</b>

*I, the undersigned, hereby declare that the equipment specified above conforms to the above Directive and Standards.*

**Manufacturer**

Signature:

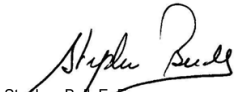

Full Name: Stephen Bull, E-Eng  
Position: Vice-President Research and Development  
Address: 400 Godin Avenue, Quebec (Quebec),  
Canada, G1M 2K2  
Date: January 09, 2009

# **1** *Introducing the FTB-5700 Single-Ended Dispersion Analyzer*

The FTB-5700 Single-Ended Dispersion Analyzer is the world's first combined CD and PMD analyzer doing both measurements from a single end of the fiber. It features a single connector port and software for both type of measurements; CD and PMD are characterized by pressing a single button. This is done without the need for a remote unit or light source.

As long as the remote end of the fiber is unterminated and with a UPC connector, a single technician can perform advanced testing, that is, CD and PMD measurements. The results are also compiled into a single test file and a single report for both tests.

# Introducing the FTB-5700 Single-Ended Dispersion Analyzer

## Module Description

---

### Module Description

The figure below illustrates the front panel for your Single-Ended Dispersion Analyzer

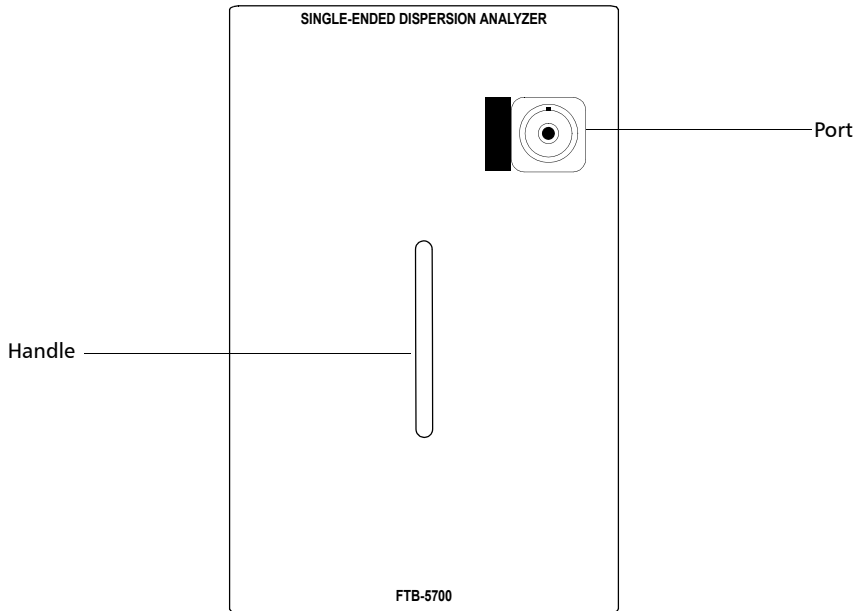

### Typical Applications

With its dynamic range, level of accuracy and feature set, the FTB-5700 Single-Ended Dispersion Analyzer is a perfect tool for any network manager or technician to perform advance testing of 10 Gbit/s networks or faster, on any fiber length up to 120 km. The FTB-5700 Single-Ended Dispersion Analyzer helps validating fiber quality for the given speed or providing information enabling compensation.



### Basic FTB-5700 Single-Ended Dispersion Analyzer Operation

The purpose of the FTB-5700 Single-Ended Dispersion Analyzer unit is to be simple of use, with minimal parameter setting requirements. The parameter most likely to be changed by a user is the fiber type.

In order to achieve optimal measurements, you must however remember a few concepts:

- The measurement technique for the unit requires only a strong reflective event at the end of the link to perform CD and PMD measurements. The measurement is taken at the location of this reflective event at a wavelength of 1550 nm.

**Note:** *Reflective events are caused by an abrupt discontinuity in the index of refraction. They cause a significant portion of the energy initially launched into the fiber to be reflected back toward the source.*

- You must have a UPC connector at the end of the fiber to measure the overall link. If the appropriate termination is not found, the unit returns an error message (see *Troubleshooting* on page 67 for details).

**Note:** *Other reflective terminations include mirror connectors, fiber pigtailed mirrors, cleaved fibers. However, do not use fiber loop mirrors or Faraday-type mirrors.*

## Introducing the FTB-5700 Single-Ended Dispersion Analyzer

### *Basic FTB-5700 Single-Ended Dispersion Analyzer Operation*

---

Once the fiber end event position is found, the unit checks the dynamics and evaluates the wavelength range over which to perform the measurement. It then selects the acquisition conditions and sequence of the measurement before starting the acquisition itself.

You must also remember that the fiber under test (FUT) must meet the following requirements for optimal testing conditions:

- The FUT length must be terminated by a UPC connector.
- The FUT length must be less than 120 km.
- The FUT must not have a filter at 1550 nm.

**Note:** *Since the instrument is single ended, it cannot measure through components that allow light to travel only in one direction, such as amplifiers and circulators.*

## Conventions

Before using the product described in this manual, you should understand the following conventions:



### **WARNING**

Indicates a potentially hazardous situation which, if not avoided, could result in *death or serious injury*. Do not proceed unless you understand and meet the required conditions.



### **CAUTION**

Indicates a potentially hazardous situation which, if not avoided, may result in *minor or moderate injury*. Do not proceed unless you understand and meet the required conditions.



### **CAUTION**

Indicates a potentially hazardous situation which, if not avoided, may result in *component damage*. Do not proceed unless you understand and meet the required conditions.



### **IMPORTANT**

Refers to information about this product you should not overlook.



## 2 **Safety Information**



### **WARNING**

Do not install or terminate fibers while a light source is active. Never look directly into a live fiber and ensure that your eyes are protected at all times.



### **WARNING**

Use of controls, adjustments and procedures for operation and maintenance other than those specified herein may result in hazardous radiation exposure or impair the protection provided by this unit.

Your instrument is a Class 1 laser product in compliance with standards IEC 60825-1 and 21 CFR 1040.10. Laser radiation may be encountered at the output port.

The following label indicates that a product contains a Class 1 source:

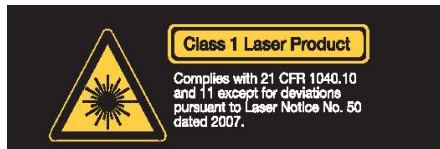



# 3 ***Getting Started with the Single-Ended Dispersion Analyzer***

## **Inserting and Removing Test Modules**



### **CAUTION**

Never insert or remove a module while the FTB-200 Compact Modular Platform is turned on. This will result in immediate and irreparable damage to both the module and unit.



### **WARNING**

When the laser safety LED () is flashing, at least one of your modules is emitting an optical signal. Please check all modules, as it might not be the one you are currently using.

## Getting Started with the Single-Ended Dispersion Analyzer

### *Inserting and Removing Test Modules*

---

#### **To insert a module into the FTB-200 Compact Modular Platform:**

1. Turn off your unit.
2. Position the unit so that its front panel is facing you.

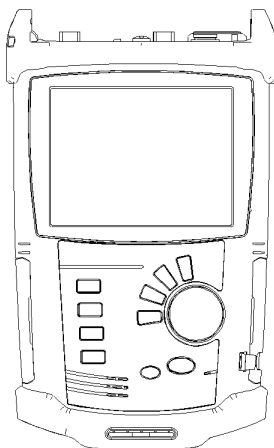



## Getting Started with the Single-Ended Dispersion Analyzer

### *Inserting and Removing Test Modules*

---

3. Take the module and place it vertically so that the retaining screw hole is at the left of the connector pins.



### **CAUTION**

Inserting a module upside down could result in permanent damage to the module, as the connector pins might be bent.

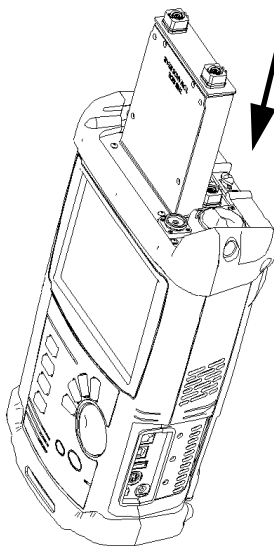

4. Insert the protruding edges of the module into the grooves of the unit's module slot.
5. Push the module all the way to the bottom of the slot, until the retaining screw makes contact with the unit casing.
6. Place the unit so that its bottom panel is facing you.

## Getting Started with the Single-Ended Dispersion Analyzer

### *Inserting and Removing Test Modules*

---

7. While applying slight pressure to the module, use a coin to turn the retaining screw clockwise until it is tightened.

This will secure the module into its “seated” position.

Turn retaining screws  
clockwise

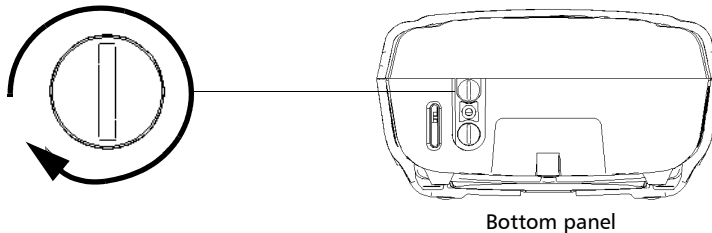

When you turn on the unit, the startup sequence will automatically detect the module.

## Getting Started with the Single-Ended Dispersion Analyzer

### *Inserting and Removing Test Modules*

---

#### **To remove a module from the FTB-200 Compact Modular Platform:**

1. Turn off your unit.
2. Position the unit so that the bottom panel is facing you.
3. Using a coin, turn the retaining screw counterclockwise until it stops.

The module will be slowly released from the slot.

Turn retaining screws  
counterclockwise

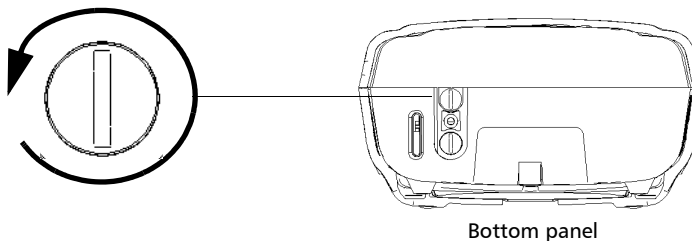

4. Place the unit so that the top panel is facing you.

## Getting Started with the Single-Ended Dispersion Analyzer

### *Inserting and Removing Test Modules*

---

5. Hold the module by its sides or by the handle (*NOT by the connector*) and pull it out.

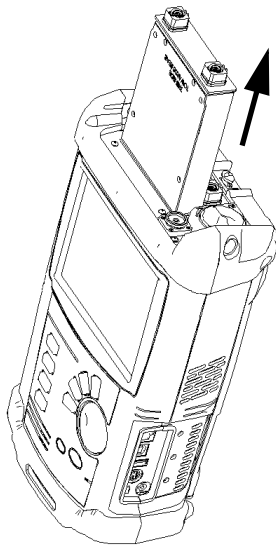

### **CAUTION**

Pulling out a module by a connector could seriously damage both the module and connector. Always pull out a module by its casing.

6. Cover empty slots with the supplied protective covers.

## Starting Module Applications

Your modules can be configured and controlled from their dedicated applications in ToolBox CE.

### **To start a module application:**

1. From ToolBox CE select the module to use.

It will turn blue to indicate that it is highlighted.

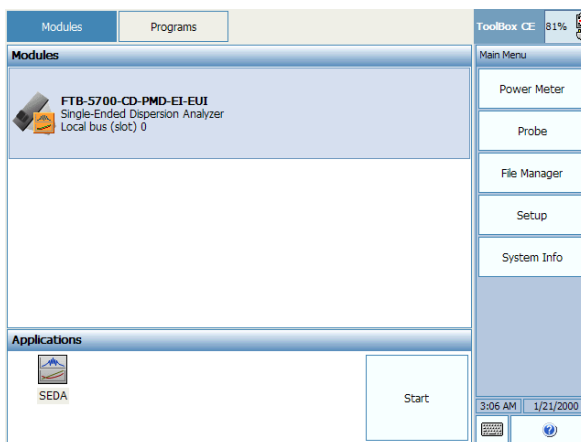

2. Under **Applications**, select an application, then press **Start**.

### **To start the Power Meter or Probe application:**

From **Main Menu**, press **Power Meter** or **Probe**.



## 4 **Setting Up the Single-Ended Dispersion Analyzer**

The many features of the Single-Ended Dispersion Analyzer are controlled by the Windows CE-compatible Compact ToolBox software. Please refer to the *FTB-200 Compact Modular Platform* user guide for more information.

The parameters you set will be kept in memory after turning off the FTB-200 Compact Modular Platform.

### **Setting up Application Details**

You can customize the distance units, the CD display values and whether or not you are warned each time a scan is complete.

You can also keep the intermediate data when performing tests. This option should be used when there is a problem with the Single-Ended Dispersion Analyzer or a measurement. Once you have acquired this intermediate data, which represents all of the actions done by the unit when performing the test, you can take this file and send it to EXFO for troubleshooting purposes.



### **IMPORTANT**

Selecting the Keep intermediate data option will increase the size of your result file in a significant manner.

In cases where many events are detected as potential end of fiber event, the assisted fiber length detection is another option that gives you the opportunity to select a specific reflective event as the end of the fiber.

# Setting Up the Single-Ended Dispersion Analyzer

## Setting up Application Details

**To set up the application details:**

1. From the button bar, click **Setup**.

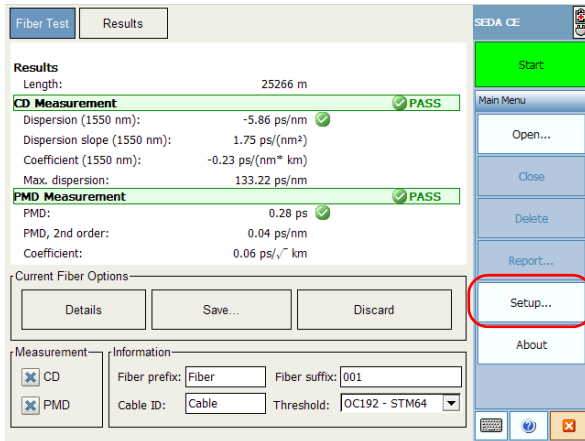

2. Select the **Application** tab.
3. Select the units to use for your measurements.

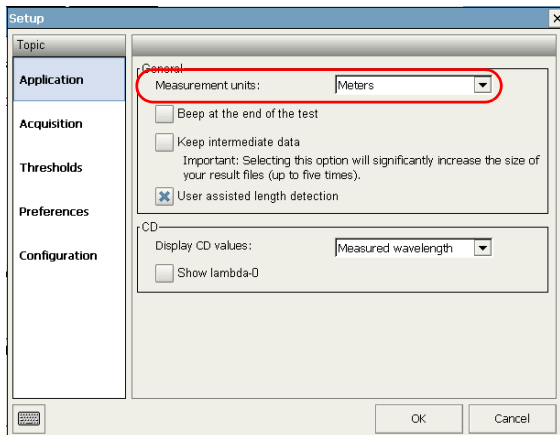



4. If you would like the unit to warn you when a test is complete, select the corresponding option.

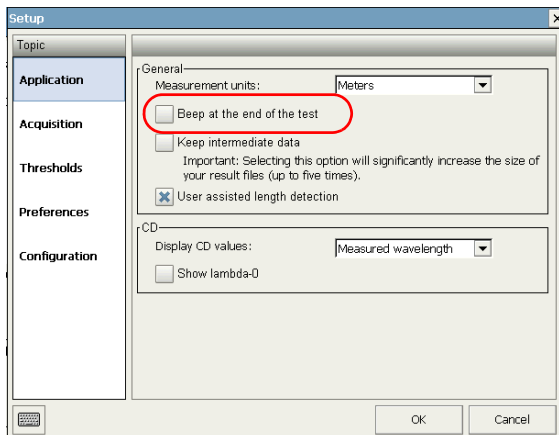

5. If you want your Single-Ended Dispersion Analyzer to keep the intermediate data when performing the analysis, select the corresponding option.

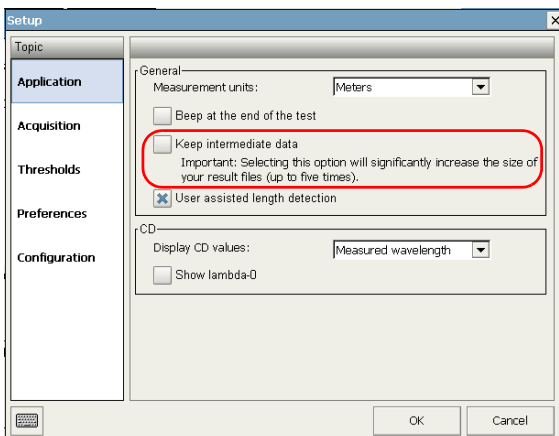

# Setting Up the Single-Ended Dispersion Analyzer

## Setting up Application Details

6. If you want to manually choose an event as the proper end of the fiber, select the **User assisted length detection** box.

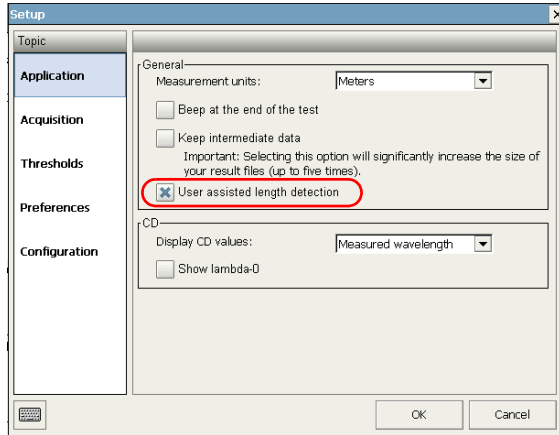

7. Under **CD**, select the **Show lambda-0** check box to show the value if desired (the lambda-0 value is the extrapolated wavelength at which the dispersion equals 0).

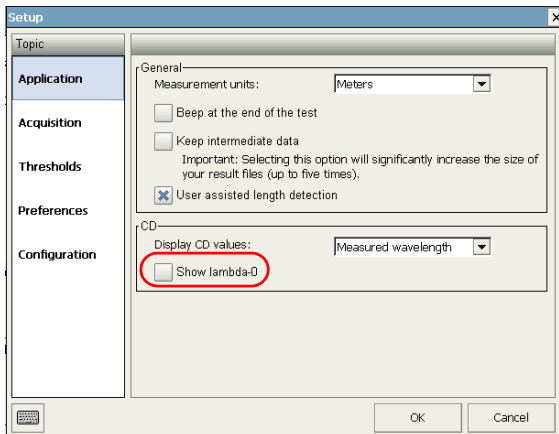

8. Select the display type for the CD values amongst the available choices:
  - Measured wavelength (default value)
  - Step by 1 nm
  - ITU-50
  - ITU-100
  - ITU-200

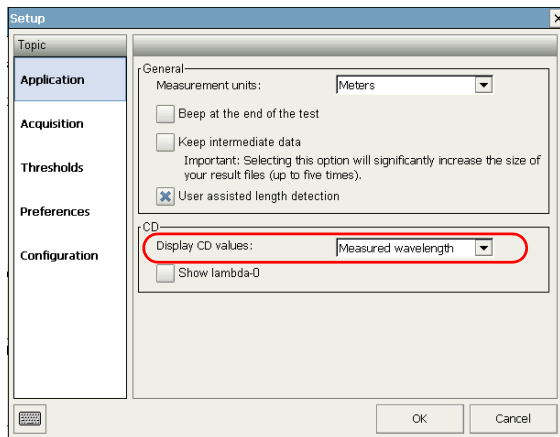

9. To confirm and save the changes, click **OK**.

# Setting Up the Single-Ended Dispersion Analyzer

## Customizing Thresholds

### Customizing Thresholds

The Single-Ended Dispersion Analyzer allows you to specify thresholds both for the CD and PMD aspects of your tests to determine if the results are as expected or if they exceed the specified limits.

**Note:** You cannot modify or delete the predefined thresholds provided with your Single-Ended Dispersion Analyzer.

#### To set the thresholds:

1. From the button bar, click **Setup**.

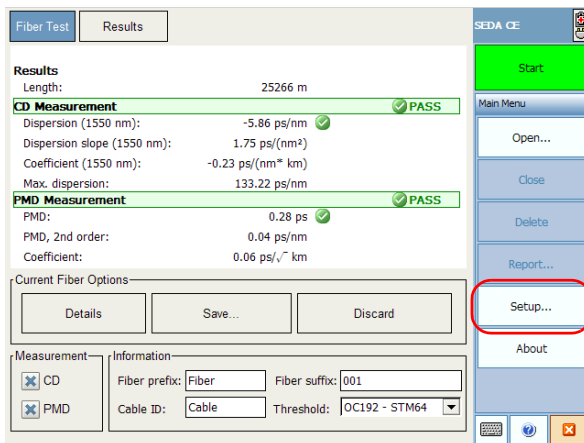

2. Select the **Thresholds** tab.

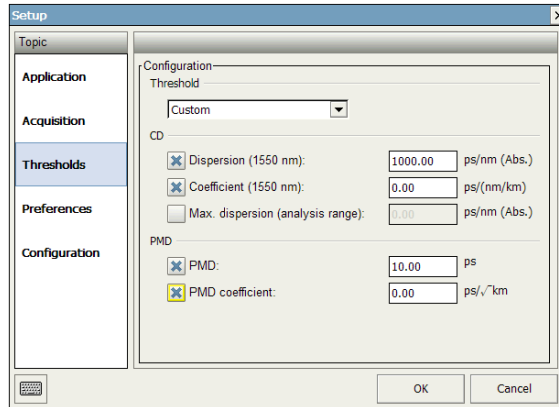

3. Select a predefined threshold in the **Thresholds** list. If you select **Custom**, the chromatic dispersion and PMD sections become editable and you can specify which values to use for the items below.
  - Dispersion (at 1550 nm)
  - Coefficient (at 1550 nm)
  - Max. dispersion (analysis range)
  - PMD
  - PMD coefficient
4. To confirm and save the changes, click **OK**.

# Setting Up the Single-Ended Dispersion Analyzer

## Setting the Wavelength Range

### Setting the Wavelength Range

You can set the wavelength range within which you want to perform your acquisitions. You can work with predefined range of the tunable source or set the wavelength range by using the custom option. This option could be useful to perform acquisitions in a specific area of a band or between two bands.

#### To set the wavelength range:

1. From the button bar, click **Setup**.

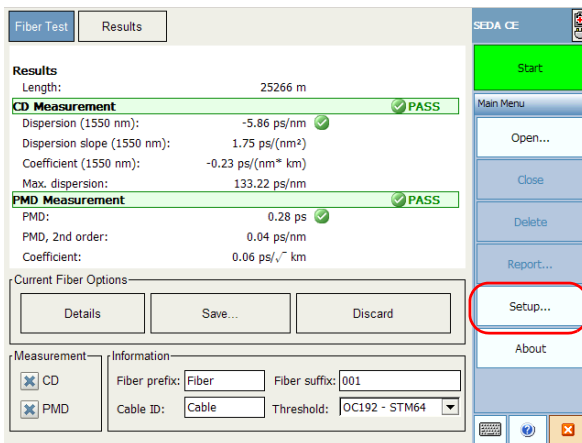

### 2. Select the **Acquisition** tab.

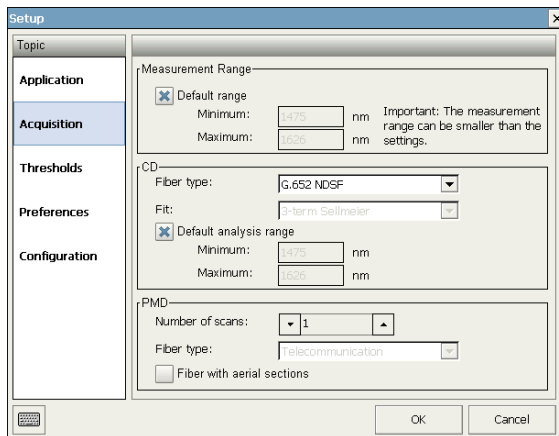

### 3. Select the range.

- To use the default range, select the corresponding option. The default range is directly linked to the type of fiber in use.
- To use a customized range, disable the **Default** range option to activate the minimum and maximum value boxes and enter the desired values.

### 4. Click **OK** to confirm and save your changes.

## Setting Up the Single-Ended Dispersion Analyzer

### Setting PMD and CD Acquisition Parameters

Parameters are kept in memory even after turning off the FTB-200 Compact Modular Platform.

These parameters include the following:

Parameter	Details
CD Fiber Type	<p>There are several types of CD fibers. They have a wavelength range of 1475 nm to 1626 nm, but different fits.</p> <ul style="list-style-type: none"><li>➤ G.652 NDSF (3-term Sellmeier fit)</li><li>➤ G.653 DSF (quadratic fit)</li><li>➤ G.655 NZDSF (quadratic fit)</li><li>➤ G.656 Wideband NZDSF (quadratic fit)</li><li>➤ Custom (default cubic fit)</li></ul> <p><b>Note:</b> <i>The only fiber type with an editable fit is Custom.</i></p> <p><b>Note:</b> <i>The CD and PMD fiber types are linked, therefore if you select a fiber type, the choices available in the other file type list will change accordingly.</i></p>
Fit	The type of equation applied to measure CD (for example, quadratic or 3-Term Sellmeier).
Number of scans	The number of times the module will take measurements for measuring PMD. A higher scan count will result in more accurate data, but will take longer to perform.



## Setting Up the Single-Ended Dispersion Analyzer

### Setting PMD and CD Acquisition Parameters

---

Parameter	Details
PMD Fiber type	<p>Must be set to one of the following types:</p> <ul style="list-style-type: none"><li>▶ <b>Telecommunication:</b> also known as <i>strong coupling</i>. If you are working directly in the field, you will always use this fiber type.</li><li>▶ <b>Polarization-Maintaining (PM):</b> also known as <i>weak coupling</i>. This type is rarely used and is required for specific types of tests only.</li></ul> <p><b>Note:</b> <i>Traces taken with a particular fiber type cannot be reanalyzed with a different fiber type afterwards.</i></p>
Analysis Range	<p>The analysis range is the value used to calculate the ITU grid and the maximum value for the acquisition. The analysis range can be different from the wavelength measurement range.</p>
Fiber with aerial sections	<p>If the fiber installations are, for example, between buildings, or suspended to reach the intended location, the movement created by wind or other outside elements can affect the PMD measurement. Select this option to compensate for such possible movements.</p>

# Setting Up the Single-Ended Dispersion Analyzer

## Setting PMD and CD Acquisition Parameters

### To set the acquisition parameters:

1. From the button bar, click **Setup**.

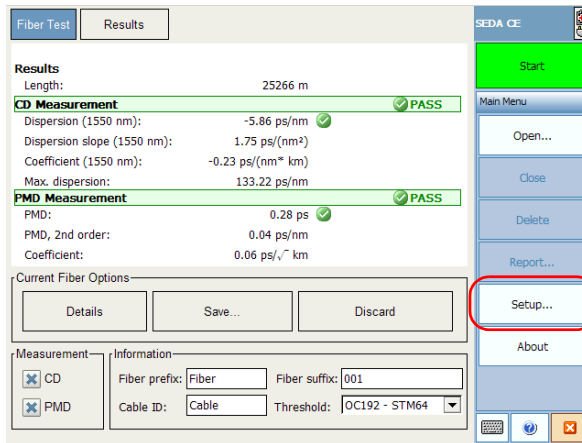

2. Select the **Acquisition** tab.

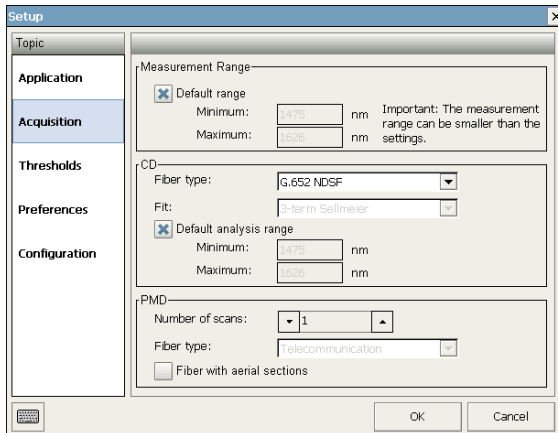

3. Change the settings as needed according to the table above.
4. Click **OK** to confirm and save your changes.

## Defining the Automatic Fiber Name Format

Each time you make a new acquisition, the fiber name changes automatically according to a pattern you will have previously defined. This name corresponds to the concatenation of a static part (prefix) and a variable part that will be incremented.

### To define the fiber name format:

1. From the main window, select the **Fiber Test** tab.
2. Under **Information**, set the various parameters according to your needs.

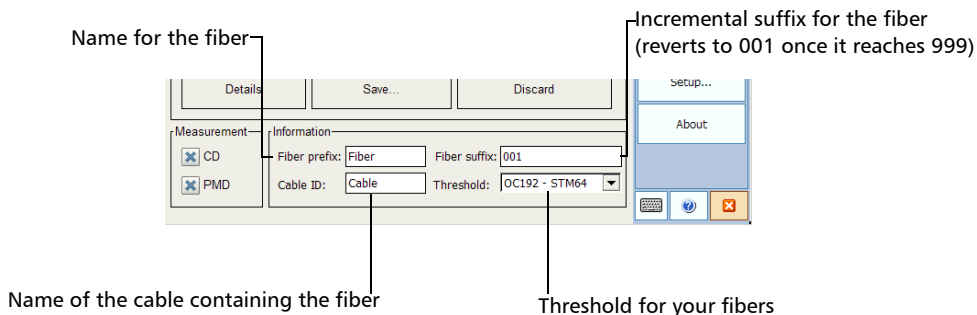

**Note:** The fiber name, cable ID and automated additions to the file name such as the date can be set in the **Preferences** tab of the **Setup** window. See Setting Test Preferences on page 34 for details.

## Setting Up the Single-Ended Dispersion Analyzer

### Managing Test Configurations

## Managing Test Configurations

If you often perform the same test types with preset threshold values, you can speed up your tests by saving configurations.

**Note:** *The configuration files are independent of the unit on which they were saved. This means that if you transfer or copy the configuration file to another test unit, you can use it as if it had been saved on this new unit.*

### To save a configuration:

1. Set the parameters on your unit as desired.
2. From the main window, click **Setup**.

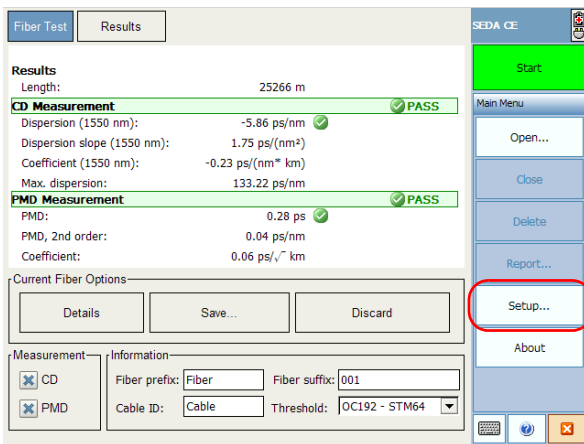

3. Select the **Configuration** tab.

**4. Click **Export Configuration**.**

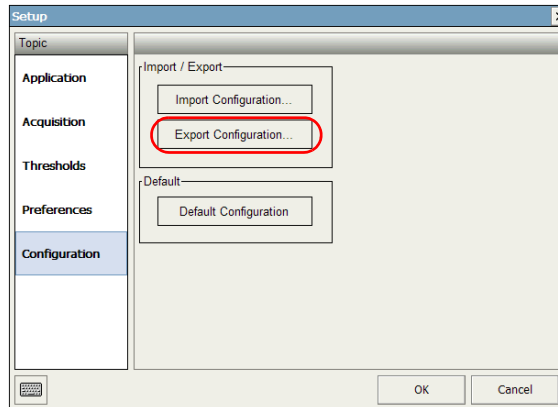

**5. Select the location and name for your file, then click **OK**.**

# Setting Up the Single-Ended Dispersion Analyzer

## Managing Test Configurations

**To retrieve an existing configuration file:**

1. From the main window, click **Setup**.

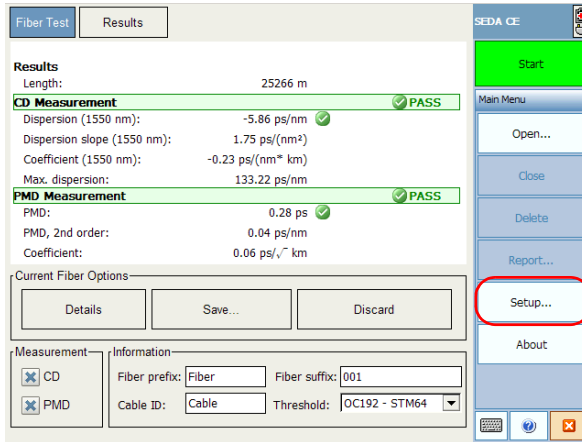

2. Select the **Configuration** tab.
3. Click **Import Configuration**.

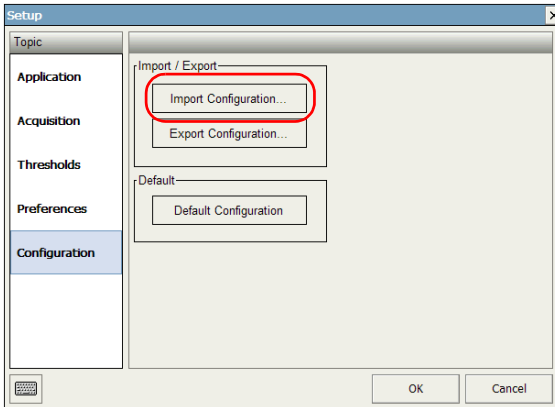

4. Locate the file corresponding to your configuration, then click **OK**.

**To revert to the default configuration:**

1. From the main window, click **Setup**.

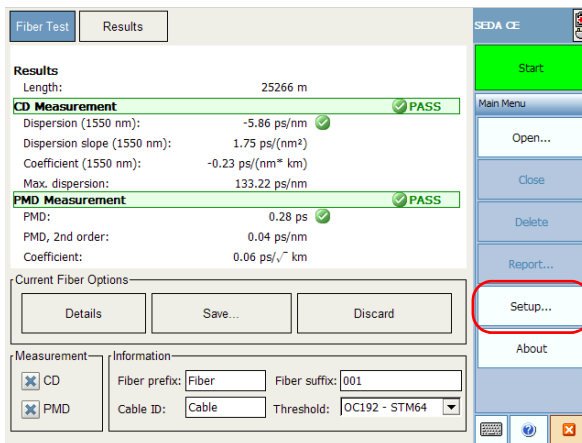

2. Select the **Configuration** tab.
3. Click **Default Configuration**.

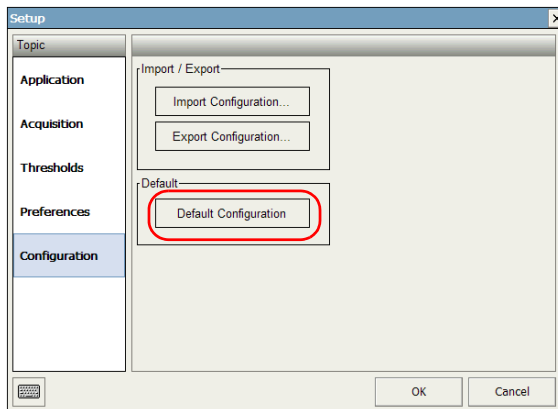

# Setting Up the Single-Ended Dispersion Analyzer

## Setting Test Preferences

### Setting Test Preferences

You can set the autonaming and information preferences for your tests. This will help you better identify the different tests you perform with your module.

**To set the test preferences:**

1. From the main window, click **Setup**.

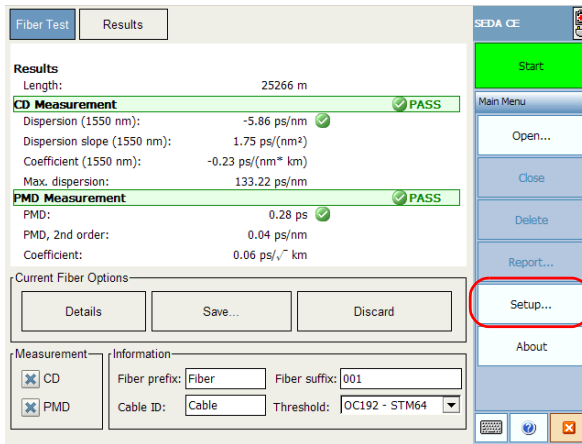

2. Select the **Preferences** tab.



3. Enter the information pertaining to your test. This information will be attached to the acquisitions you perform afterwards.

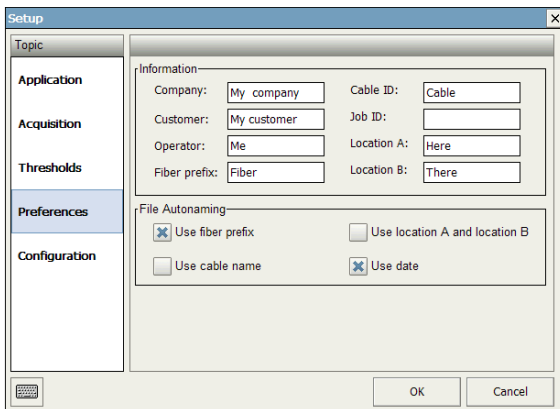

The screenshot shows the 'Setup' dialog box with the 'Information' tab selected. The 'Topic' list on the left includes Application, Acquisition, Thresholds, Preferences, and Configuration. The 'Information' section contains the following fields:

Company:	My company	Cable ID:	Cable
Customer:	My customer	Job ID:	
Operator:	Me	Location A:	Here
Fiber prefix:	Fiber	Location B:	There

The 'File Autonoming' section contains the following options:

<input checked="" type="checkbox"/> Use fiber prefix	<input type="checkbox"/> Use location A and location B
<input type="checkbox"/> Use cable name	<input checked="" type="checkbox"/> Use date

Buttons for 'OK' and 'Cancel' are located at the bottom right.

4. If you want the application to automatically include the fiber prefix, cable name, A and B location or date in the file name scheme, select the corresponding option.

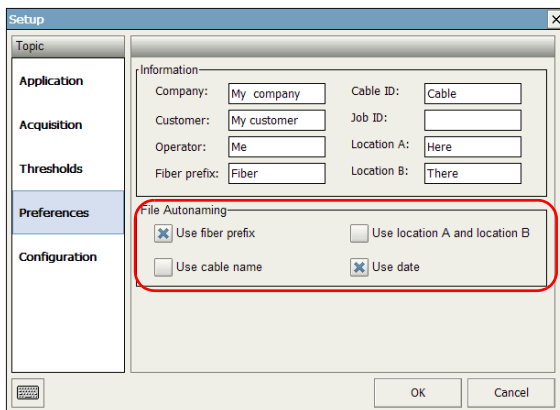

This screenshot is identical to the previous one, but the 'File Autonoming' section is highlighted with a red rectangle. The options are:

<input checked="" type="checkbox"/> Use fiber prefix	<input type="checkbox"/> Use location A and location B
<input type="checkbox"/> Use cable name	<input checked="" type="checkbox"/> Use date

Buttons for 'OK' and 'Cancel' are located at the bottom right.

5. Click **OK** to confirm your choice.



# 5 **Operating the Single-Ended Dispersion Analyzer**

## **Cleaning and Connecting Optical Fibers**



### **IMPORTANT**

To ensure maximum power and to avoid erroneous readings:

- Always inspect fiber ends and make sure that they are clean as explained below before inserting them into the port. EXFO is not responsible for damage or errors caused by bad fiber cleaning or handling.
- Ensure that your patchcord has appropriate connectors. Joining mismatched connectors will damage the ferrules.

#### ***To connect the fiber-optic cable to the port:***

- 1.** Inspect the fiber using a fiber inspection microscope. If the fiber is clean, proceed to connecting it to the port. If the fiber is dirty, clean it as explained below.
- 2.** Clean the fiber ends as follows:
  - 2a.** Gently wipe the fiber end with a lint-free swab dipped in isopropyl alcohol.
  - 2b.** Use compressed air to dry completely.
  - 2c.** Visually inspect the fiber end to ensure its cleanliness.

## Operating the Single-Ended Dispersion Analyzer

### *Cleaning and Connecting Optical Fibers*

---

- 3.** Carefully align the connector and port to prevent the fiber end from touching the outside of the port or rubbing against other surfaces.

If your connector features a key, ensure that it is fully fitted into the port's corresponding notch.

- 4.** Push the connector in so that the fiber-optic cable is firmly in place, thus ensuring adequate contact.

If your connector features a screwsleeve, tighten the connector enough to firmly maintain the fiber in place. Do not overtighten, as this will damage the fiber and the port.

**Note:** *If your fiber-optic cable is not properly aligned and/or connected, you will notice heavy loss and reflection.*

## Installing the EXFO Universal Interface (EUI)

The EUI fixed baseplate is available for connectors with angled (APC) or non-angled (UPC) polishing. A green border around the baseplate indicates that it is for APC-type connectors.

Green border  
indicates APC  
option

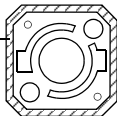

Bare metal  
(or blue border)  
indicates UPC  
option

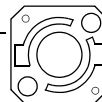

### ***To install an EUI connector adapter onto the EUI baseplate:***

- 1.** Hold the EUI connector adapter so the dust cap opens downwards.

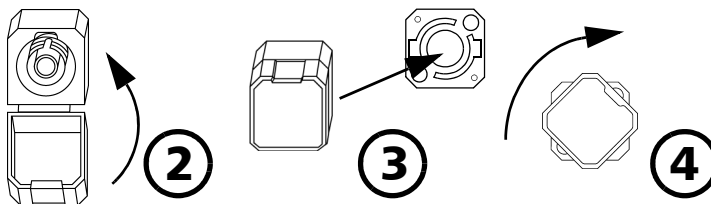

- 2.** Close the dust cap in order to hold the connector adapter more firmly.
- 3.** Insert the connector adapter into the baseplate.
- 4.** While pushing firmly, turn the connector adapter clockwise on the baseplate to lock it in place.

## Performing a Test

The Single-Ended Dispersion Analyzer allows you to acquire single traces on a specific fiber. You can test the PMD, the CD, or both at the same time.



### **IMPORTANT**

Your FTB-5700 Single-Ended Dispersion Analyzer was designed to automatically determine the length of your fiber and test accordingly. If the test is still performed and the length indicated is not appropriate, this means that a strong reflective event is present on the fiber before the non-reflective termination.

If such a situation occurs, clean the fiber end or add a reflector at the end of the fiber to improve your results.

## To start an acquisition:

1. Set the acquisition parameters as needed. See the corresponding user guide sections for more details.
2. Select whether the acquisition will include PMD, CD, or both.

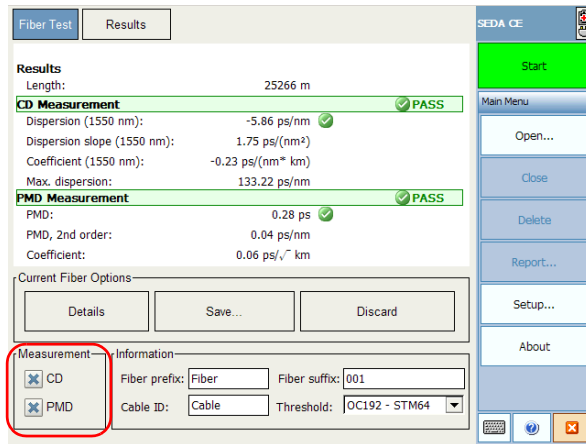

3. Verify that the fiber (FUT) is properly connected and that the setup is appropriate.



## IMPORTANT

The FUT must be terminated by a UPC connector.

# Operating the Single-Ended Dispersion Analyzer

## Performing a Test

4. From the button bar, click **Start** to start a measurement sequence.

When the measurement is complete, the results are displayed in the grid.

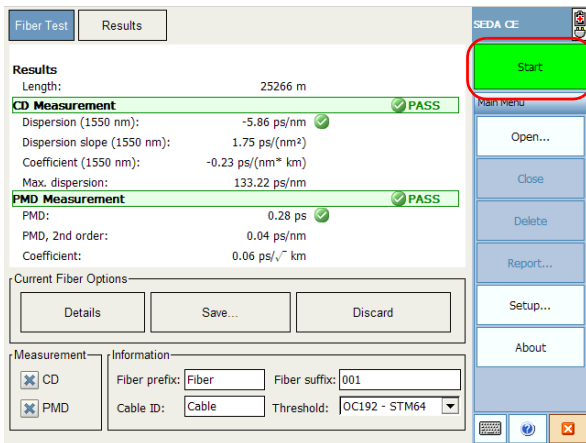

5. If the **User-assisted length detection** box is activated (see *Setting up Application Details* on page 17 for more information), and that there are more than one potential events that could signal the end of the link, you will be prompted to select the one you want at this point.

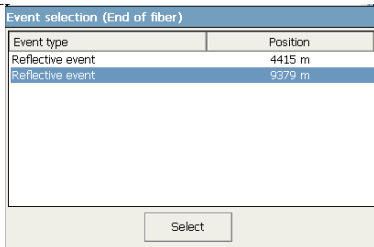



6. Click **Select** to close the window.
7. If you are satisfied with the results, click **Save**. The entry will be sent to the **Results** tab.

If you are not satisfied with the results, click **Discard** to clear the test window and perform a new test.

***To stop the acquisition before it is complete:***

Click the **Stop** button. The button changes back to a green **Start** button.



## 6 **Managing Results**

Your FTB-5700 Single-Ended Dispersion Analyzer allows you to work with two types of results:

- Newly acquired results
- Results loaded from existing files

To view and analyze your results, the application provides:

- A graph and a table presenting details for a specific acquisition in the case of chromatic dispersion
- A window giving you an overview of all the available acquisitions, plus the related details

It also offers customizing, saving, export and printing features based on these results.



### **IMPORTANT**

Your FTB-5700 Single-Ended Dispersion Analyzer was designed to automatically determine the length of your fiber and test accordingly. If the test is still performed and the length indicated is not appropriate, this means that a strong reflective event is present on the fiber before the non-reflective termination.

If such a situation occurs, clean the fiber end or add a reflector at the end of the fiber to improve your results.

## Managing Results

### **To view a specific result and the related information:**

From the main window **Results** tab, once you have taken a measurement and saved it, or opened measurement files, you can select the fiber for which you want to view the results.

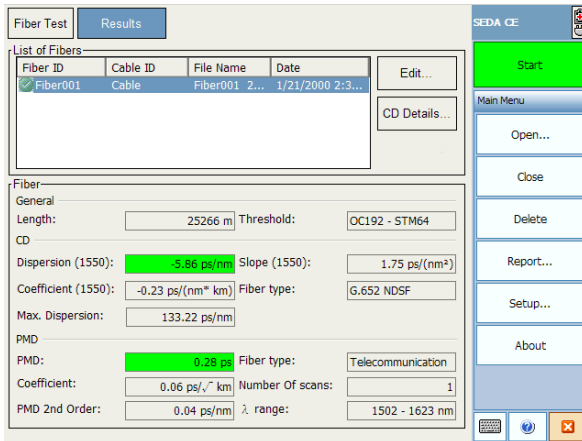

### **To view CD Details:**

In the **Fiber Test** tab, click **Details**.

OR

In the **Results** tab, click **CD Details**.

**To specify the type of display to show on the graph:**

In the CD Display window, under the graph, select either **Chromatic dispersion** or **Chromatic dispersion coefficient**.

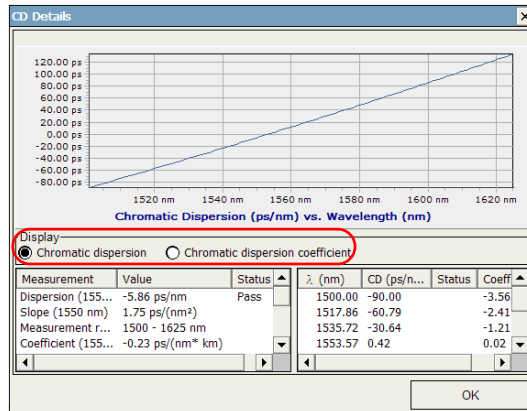

The graph and the results in the **Display** table will change accordingly.

## Managing Results

### *Modifying Analysis Parameters and Related Information*

# Modifying Analysis Parameters and Related Information

Once you have acquired test results, you can modify the parameters and perform the analysis again with the new settings. You can also add or modify information about the job and cable at this point.

## Modifying Cable Information

Since the test was already performed, you can add specific comments on the cable at this point, or rename it in a easy to recognize manner.

### ***To modify cable information for your test:***

1. Acquire test results by performing a scan, or retrieve a file or files from the **Open** button.
2. In the **Results** tab, press **Edit**.

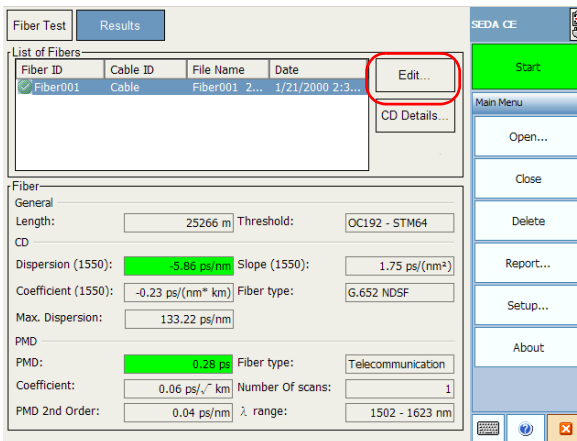

**3. Select the **Cable** tab.**

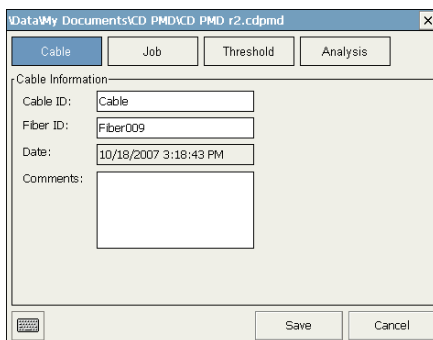

The screenshot shows a software window titled "DataWy Documents\CD PMD\CD PMD r2.cdpmid". The window has four tabs: "Cable", "Job", "Threshold", and "Analysis". The "Cable" tab is selected. Below the tabs, there is a section labeled "Cable Information" containing the following fields:

- Cable ID: Cable
- Fiber ID: Fiber009
- Date: 10/18/2007 3:18:43 PM
- Comments: (empty text box)

At the bottom of the window, there are two buttons: "Save" and "Cancel".

**4. Fill the boxes according to your needs.**

**5. When you are done, click **Save**.**

## Managing Results

### Modifying Analysis Parameters and Related Information

## Modifying Job Information

If the job was performed by a different person than the original settings indicated, or that the location changed, you may adjust the information here.

### To modify job information for your test:

1. Acquire test results by performing a scan, or retrieve a file or files from the **Open** button.
2. In the **Results** tab, press **Edit**.

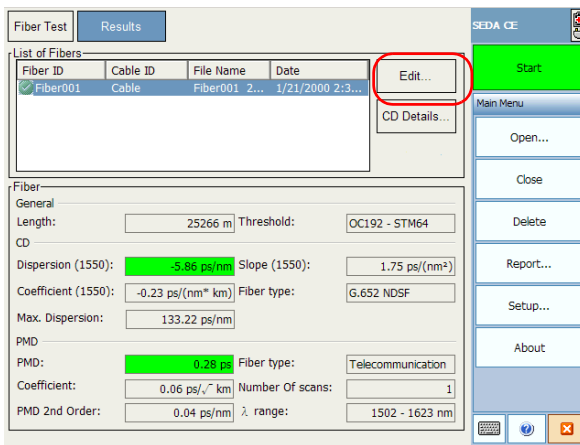



**3. Select the Job tab.**

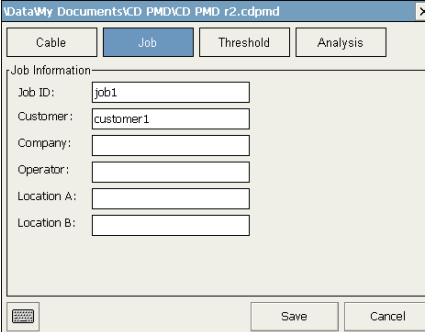

The screenshot shows a software window titled "Data\My Documents\CD PMD\CD PMD r2.cd\pmd" with a close button (X). The window contains four tabs: "Cable", "Job", "Threshold", and "Analysis". The "Job" tab is selected and highlighted in blue. Below the tabs is a "Job Information" section with several input fields: "Job ID:" (containing "job1"), "Customer:" (containing "customer1"), "Company:", "Operator:", "Location A:", and "Location B:". At the bottom of the window, there is a keyboard icon, a "Save" button, and a "Cancel" button.

**4. Fill the boxes according to your needs.**

**5. When you are done, click **Save**.**

## Managing Results

### Modifying Analysis Parameters and Related Information

## Modifying Threshold Parameters

Any change in the threshold parameters will take effect when you reanalyze the trace file.

### To modify threshold parameters for your test:

1. Acquire test results by performing a scan, or retrieve a file or files from the **Open** button.
2. In the **Results** tab, press **Edit**.

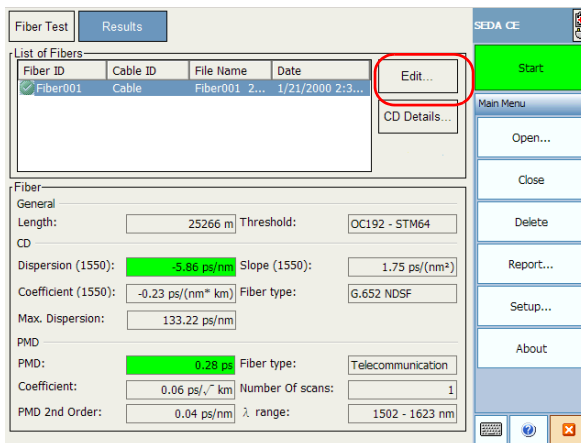

3. Select the **Threshold** tab.
4. Change the desired threshold settings (for details on the settings, see *Customizing Thresholds* on page 22).

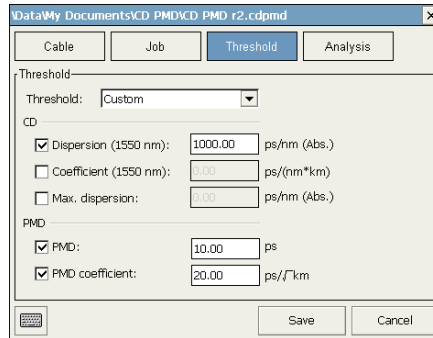

The screenshot shows a software window titled "DataMy Documents\CD PMD\CD PMD r2.cdpm.d" with a close button. The window has four tabs: "Cable", "Job", "Threshold" (selected), and "Analysis". The "Threshold" tab contains the following settings:

- Threshold: Custom (dropdown menu)
- CD section:
  - Dispersion (1550 nm): 1000.00 ps/nm (Abs.)
  - Coefficient (1550 nm): 20.00 ps/(nm\*km)
  - Max. dispersion: 1.00 ps/nm (Abs.)
- PMD section:
  - PMD: 10.00 ps
  - PMD coefficient: 20.00 ps/√km

At the bottom of the window, there is a keyboard icon, a "Save" button, and a "Cancel" button.

5. Save your analysis parameters; the results are changed accordingly by your unit.

## Managing Results

### *Modifying Analysis Parameters and Related Information*

## Modifying Analysis Parameters

The analysis parameters include the analysis range and the fiber type.

### **To modify analysis parameters for your test:**

1. Acquire test results by performing a scan, or retrieve a file or files from the **Open** button.
2. In the **Results** tab, press **Edit**.

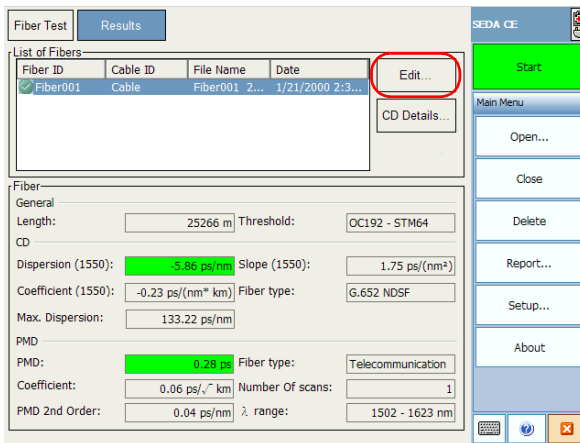

3. Select the **Analysis** tab.
4. Change the desired analysis settings (for details on the settings, see *Setting PMD and CD Acquisition Parameters* on page 26).

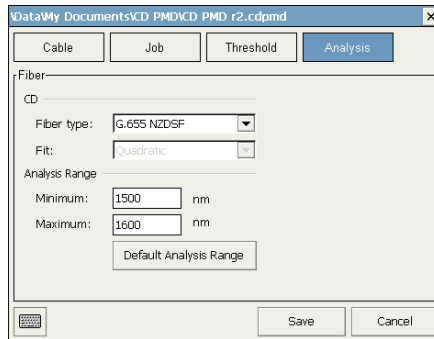

5. Save your analysis parameters; the results are changed accordingly by your unit.

### Opening Existing Files

You can open existing files without losing the current results and information.



#### IMPORTANT

If a file is already selected in the list, the opened file will replace the selected file. If no file was selected, the new file will be added at the bottom of the list.

#### To open an existing file:

1. From the button bar, click **Open**.

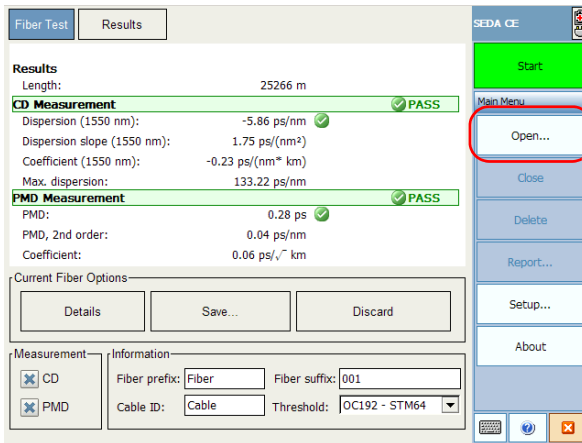

A standard **Open** dialog box is displayed, allowing you to select the desired file.

2. When you are done, from the displayed dialog box, click **Open** to load the files.

## Removing Unwanted Results

When a problem occurs, such as a fiber break, you may want to remove the corresponding erroneous measurement. This could be useful to avoid distorting results and statistics.



### IMPORTANT

Removing a saved file using the Delete button will remove the file from the drive.

#### To remove unwanted results from the disk:

1. From the main window **Results** tab, once you have taken a and saved a measurement or opened measurement files, you can select the fiber to remove.
2. Select the desired fiber by clicking on it once, then click **Delete**.

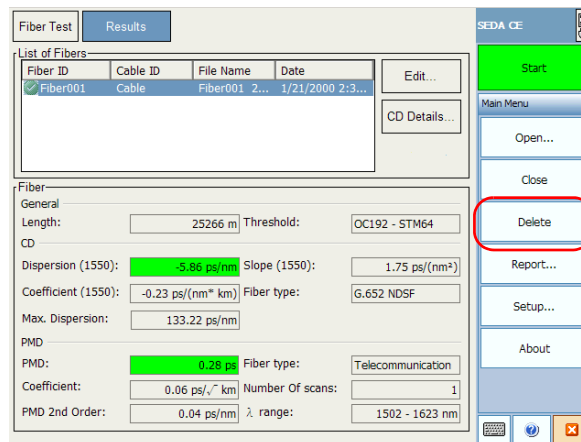

3. A confirmation message will be displayed. Click **Yes** to confirm.

## Managing Results

### Closing Result Files

For easier result management, you may want to close the result files manually.

**Note:** *You do not need to close files manually before exiting the Single-Ended Dispersion Analyzer application. You will be prompted if some result files have not been saved.*

#### To close files:

1. In the **Results** tab, select the file to close.
2. Click **Close**.

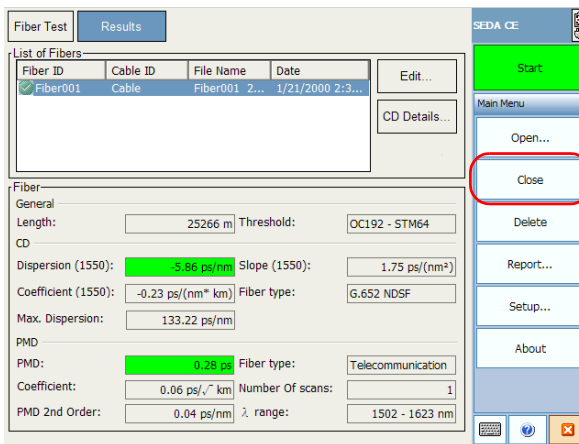



## Generating a Report

You can generate an html report for the currently selected file.

### To generate a report:

1. From either the **Fiber Test** or **Results** window, click **Report**.

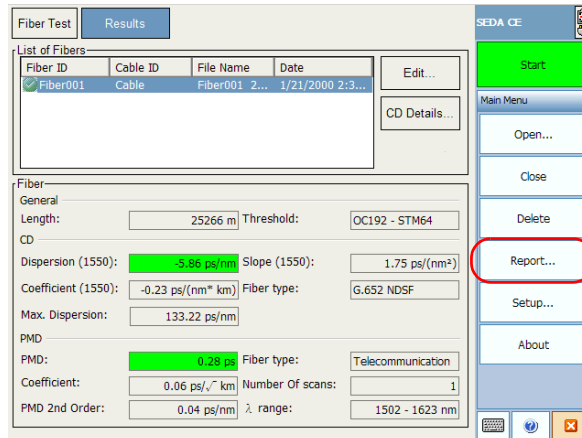

2. Select a name and location for your report.
3. Click **OK** to create the report.

**Note:** Should you move your report for further consultation, make sure that you take all of the support files that were created with the report, if any.



# 7 **Maintenance**

To help ensure long, trouble-free operation:

- Always inspect fiber-optic connectors before using them and clean them if necessary.
- Keep the unit free of dust.
- Clean the unit casing and front panel with a cloth slightly dampened with water.
- Store unit at room temperature in a clean and dry area. Keep the unit out of direct sunlight.
- Avoid high humidity or significant temperature fluctuations.
- Avoid unnecessary shocks and vibrations.
- If any liquids are spilled on or into the unit, turn off the power immediately, disconnect from any external power source, remove the batteries and let the unit dry completely.



## **WARNING**

**Use of controls, adjustments, and procedures for operation and maintenance other than those specified herein may result in hazardous radiation exposure.**

## Cleaning EUI Connectors

Regular cleaning of EUI connectors will help maintain optimum performance. There is no need to disassemble the unit.



### **IMPORTANT**

If any damage occurs to internal connectors, the module casing will have to be opened and a new calibration will be required.

**To clean EUI connectors:**

1. Remove the EUI from the instrument to expose the connector baseplate and ferrule.

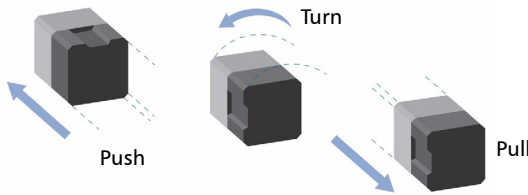

2. Moisten a 2.5 mm cleaning tip with *one drop* of isopropyl alcohol (alcohol may leave traces if used abundantly).
3. Slowly insert the cleaning tip into the EUI adapter until it comes out on the other side (a slow clockwise rotating movement may help).

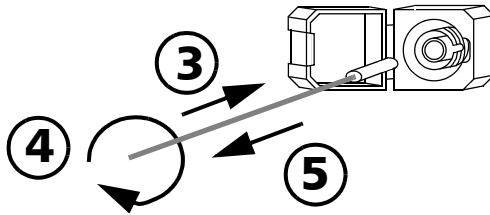

4. Gently turn the cleaning tip one full turn, then continue to turn as you withdraw it.

5. Repeat steps 3 to 4 with a dry cleaning tip.

**Note:** *Make sure you don't touch the soft end of the cleaning tip.*

6. Clean the ferrule in the connector port as follows:

**6a.** Deposit *one drop* of isopropyl alcohol on a lint-free wiping cloth.



## IMPORTANT

Isopropyl alcohol may leave residues if used abundantly or left to evaporate (about 10 seconds).

Avoid contact between the tip of the bottle and the wiping cloth, and dry the surface quickly.

- 6b.** Gently wipe the connector and ferrule.
- 6c.** With a dry lint-free wiping cloth, gently wipe the same surfaces to ensure that the connector and ferrule are perfectly dry.
- 6d.** Verify connector surface with a portable fiber-optic microscope (for example, EXFO's FOMS) or fiber inspection probe (for example, EXFO's FIP).



## WARNING

Verifying the surface of the connector **WHILE THE UNIT IS ACTIVE** WILL result in permanent eye damage.

7. Put the EUI back onto the instrument (push and turn clockwise).
8. Throw out cleaning tips and wiping cloths after one use.

## **Recalibrating the Unit**

Manufacturing and service center calibrations are based on the ISO/IEC 17025 Standard, which states that calibration documents must not contain a recommended calibration interval, unless this has been previously agreed upon with the customer.

Validity of specifications depends on operating conditions. For example, the calibration validity period can be longer or shorter depending on the intensity of use, environmental conditions and unit maintenance. You should determine the adequate calibration interval for your unit according to your accuracy requirements.

Under normal use, EXFO recommends calibrating your unit every year.

## **Recycling and Disposal (Applies to European Union Only)**



Recycle or dispose of your product (including electric and electronic accessories) properly, in accordance with local regulations. Do not dispose of it in ordinary garbage receptacles.

This equipment was sold after August 13, 2005 (as identified by the black rectangle).

- Unless otherwise noted in a separate agreement between EXFO and a customer, distributor, or commercial partner, EXFO will cover costs related to the collection, treatment, recovery, and disposal of end-of-lifecycle waste generated by electronic equipment introduced after August 13, 2005 to an European Union member state with legislation regarding Directive 2002/96/EC.
- Except for reasons of safety or environmental benefit, equipment manufactured by EXFO, under its brand name, is generally designed to facilitate dismantling and reclamation.

For complete recycling/disposal procedures and contact information, visit the EXFO Web site at [www.exfo.com/recycle](http://www.exfo.com/recycle).





# 8 Troubleshooting

## Solving Common Problems

Before calling EXFO's technical support, you may want to consider the following solutions to problems that could occur.

**Note:** *Should you have problems, you can activate the **Keep intermediate data** option in the **Acquisition** tab of the **Setup** window and send the resulting file to EXFO. This will allow us to help troubleshooting the problem.*

### General Problems

Message	Possible cause	Solution
No fiber is connected or there is a bad connection.	<ul style="list-style-type: none"><li>➤ The fiber is not properly connected.</li><li>➤ The connector is broken.</li><li>➤ There is a strong loss at the very beginning of the link.</li></ul>	<ul style="list-style-type: none"><li>➤ Verify that the fiber is properly connected.</li><li>➤ Verify that the connector is not broken.</li><li>➤ Verify that the beginning of the fiber under test does not show strong losses.</li><li>➤ Clean the connector.</li></ul>
A non-reflective fiber end was found at [distance].	The fiber under test is not terminated by a UPC connector.	Verify that the fiber under test is terminated by a UPC connector.
The signal fall-in noise is at [distance].	<ul style="list-style-type: none"><li>➤ The fiber under test is not terminated by a UPC connector.</li><li>➤ The distance is above the dynamic range.</li></ul>	<ul style="list-style-type: none"><li>➤ Verify that the fiber under test is terminated by a UPC connector.</li><li>➤ Make sure that the distance is within the dynamic range.</li></ul>

## Troubleshooting

### *Solving Common Problems*

---

Message	Possible cause	Solution
Unable to find a reflective fiber end. Please verify that the fiber under test is properly connected and terminated by a UPC connector.	Too much loss in the fiber under test	<ul style="list-style-type: none"><li>➤ Clean the fiber end.</li><li>➤ Add a reflective termination at the end of the fiber.</li></ul>
Optical power is too low.	Too much loss in the fiber under test.	<ul style="list-style-type: none"><li>➤ Clean the fiber end.</li><li>➤ Add a reflective termination at the end of the fiber.</li></ul>
Unable to find a valid wavelength range.	<ul style="list-style-type: none"><li>➤ Too much loss in the fiber under test.</li><li>➤ The wavelength range is too large.</li></ul>	<ul style="list-style-type: none"><li>➤ Clean the fiber end.</li><li>➤ Add a reflective termination at the end of the fiber.</li><li>➤ Reduce the wavelength range in the <b>Acquisition</b> tab of the <b>Setup</b> window, or select Default as the wavelength range value.</li></ul>
I cannot open my reports.	Some of the report files are missing.	Make sure that you have kept all of the report's support files with the report file itself.

## PMD-Related Problems

Message	Possible cause	Solution
Conditions are not optimal for measuring polarization mode dispersion. Cannot perform measurement.	Too much loss in the fiber under test.	<ul style="list-style-type: none"> <li>➤ Clean the fiber end.</li> <li>➤ Add a reflective termination at the end of the fiber.</li> </ul>
Unable to ensure a correct PMD measurement over the selected wavelength range.	Measurement wavelength range is too wide.	Try to narrow down the measurement wavelength range.
Optical power is not strong enough to ensure a correct PMD measurement over the selected wavelength range.	Too much loss in the fiber under test.	<ul style="list-style-type: none"> <li>➤ Clean the fiber end.</li> <li>➤ Add a reflective termination at the end of the fiber.</li> <li>➤ Reduce the wavelength range in the <b>Acquisition</b> tab of the <b>Setup</b> window, or select Default as the wavelength range value.</li> </ul>
Unable to ensure a correct PMD measurement over the selected wavelength range because the detector is saturated.	<ul style="list-style-type: none"> <li>➤ Fiber end is too reflective.</li> <li>➤ Unsuitable selected wavelength range for the measured FUT (out of the FUT bandwidth).</li> <li>➤ Unsuitable FUT. The FUT must not cut the 1550 nm wavelength.</li> </ul>	<ul style="list-style-type: none"> <li>➤ If you have put a reflective termination at the end of the fiber, remove it.</li> <li>➤ Select a wavelength range that suits the FUT and the instrument range. You can set the wavelength range in the <b>Acquisition</b> tab of the <b>Setup</b> window.</li> </ul>

## Troubleshooting

### *Solving Common Problems*

---

<b>Message</b>	<b>Possible cause</b>	<b>Solution</b>
Unable to ensure a correct PMD measurement over the selected wavelength range because of a combination of saturated detector and low optical power.	<ul style="list-style-type: none"><li>➤ Fiber end is too reflective.</li><li>➤ Unsuitable selected wavelength range for the measured FUT (out of the FUT bandwidth).</li><li>➤ Unsuitable FUT. The FUT must not cut the 1550 nm wavelength.</li></ul>	<ul style="list-style-type: none"><li>➤ If you have put a reflective termination at the end of the fiber, remove it.</li><li>➤ Select a wavelength range that suits the FUT and the instrument range. You can set the wavelength range in the <b>Acquisition</b> tab of the <b>Setup</b> window.</li></ul>
The measurement range is too short for a PMD measurement	Measurement range is too short.	Try to use a larger measurement range.
Impossible to find a valid measurement range.	<ul style="list-style-type: none"><li>➤ Too much loss in the fiber under test.</li><li>➤ Unsuitable FUT. The FUT must not cut the 1550 nm wavelength.</li></ul>	<ul style="list-style-type: none"><li>➤ Clean the fiber end.</li><li>➤ Add a reflective termination at the end of the fiber.</li></ul>

Message	Possible cause	Solution
<p>The unit has detected too important polarization fluctuations on the fiber. No PMD measurement was performed.</p>	<ul style="list-style-type: none"> <li>➤ The unit was moved during the measurement</li> <li>➤ The fiber moved during the measurement</li> </ul>	<ul style="list-style-type: none"> <li>➤ Make sure not to move the unit.</li> <li>➤ Make sure that the fiber does not move during the measurement.</li> <li>➤ If some movement is inevitable (fiber is outside with aerial sections), make sure that the <b>Fiber with aerial sections</b> option is selected in the <b>Setup</b> tab of the <b>Acquisition</b> window.</li> <li>➤ Contact EXFO if the problem is still not solved.</li> </ul>

## Troubleshooting

### Solving Common Problems

---

## CD-Related Problems

Message	Possible cause	Solution
Conditions are not optimal for measuring chromatic dispersion. Cannot achieve good measurement quality.	<ul style="list-style-type: none"><li>➤ Too much loss in the fiber under test.</li><li>➤ Multiple strong reflections close to each other at the end of fiber.</li></ul>	<ul style="list-style-type: none"><li>➤ Clean the fiber end.</li><li>➤ Add a reflective termination at the end of the fiber.</li><li>➤ In this case, add a receive fiber of at least 200 m. This will remove that condition.</li></ul>
There are not enough points to compute the model fit. Use a lower order fiber model.	The wavelength range is too big.	Reduce the wavelength range in the <b>Acquisition</b> tab of the <b>Setup</b> window, or select Default as the wavelength range value.  To reduce the constraints on the fit, it may be possible, if applicable, to lower the fit model order (for example, select a 3-term Sellmeier instead of a 5-term Sellmeier model).
There are not enough valid points to compute the model fit due to low power conditions in the selected range.	<ul style="list-style-type: none"><li>➤ Too much loss in the fiber under test.</li><li>➤ The wavelength range is unsuitable for this FUT.</li></ul>	<ul style="list-style-type: none"><li>➤ Clean the fiber end.</li><li>➤ Add a reflective termination at the end of the fiber.</li><li>➤ Select a wavelength range that suits the FUT and the instrument range. You can set the wavelength range in the <b>Acquisition</b> tab of the <b>Setup</b> window.</li></ul>

Message	Possible cause	Solution
There are not enough valid points to compute the model fit due to detector saturation conditions in the selected range.	<ul style="list-style-type: none"> <li>➤ Fiber end is too reflective.</li> <li>➤ Unsuitable FUT. The FUT must not cut the 1550 nm wavelength.</li> </ul>	<ul style="list-style-type: none"> <li>➤ If you have put a reflective termination at the end of the fiber, remove it.</li> </ul>
There are not enough valid points to compute the model fit due to a combination of detector saturation and low power conditions in the selected range.	<ul style="list-style-type: none"> <li>➤ Fiber end is too reflective.</li> <li>➤ Unsuitable selected wavelength range for the measured FUT (out of the FUT bandwidth).</li> <li>➤ Unsuitable FUT. The FUT must not cut the 1550 nm wavelength.</li> </ul>	<ul style="list-style-type: none"> <li>➤ If you have put a reflective termination at the end of the fiber, remove it.</li> <li>➤ Select a wavelength range that suits the FUT and the instrument range. You can set the wavelength range in the <b>Acquisition</b> tab of the <b>Setup</b> window.</li> </ul>

## Obtaining Online Help

An online version of the FTB-5700 Single-Ended Dispersion Analyzer user guide is conveniently available at all times from the application.

**Note:** *You will also find a printable PDF version on your installation CD.*

### **To access online help:**

Click the **Help** button on the function bar.



## Contacting the Technical Support Group

To obtain after-sales service or technical support for this product, contact EXFO at one of the following numbers. The Technical Support Group is available to take your calls from Monday to Friday, 8:00 a.m. to 7:00 p.m. (Eastern Time in North America).

For detailed information about technical support, visit the EXFO Web site at [www.exfo.com](http://www.exfo.com).

### Technical Support Group

400 Godin Avenue  
Quebec (Quebec) G1M 2K2  
CANADA

1 866 683-0155 (USA and Canada)  
Tel.: 1 418 683-5498  
Fax: 1 418 683-9224  
[support@exfo.com](mailto:support@exfo.com)

To accelerate the process, please have information such as the name and the serial number (see the product identification label), as well as a description of your problem, close at hand.

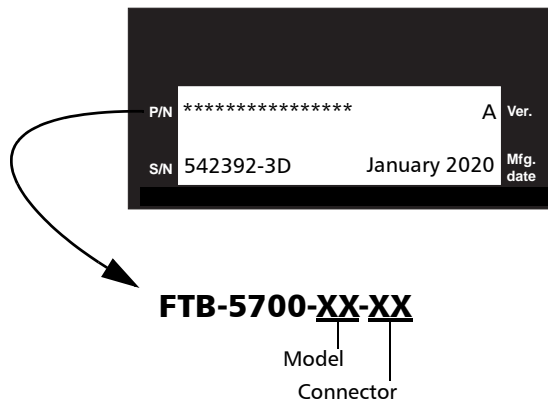

## Transportation

Maintain a temperature range within specifications when transporting the unit. Transportation damage can occur from improper handling. The following steps are recommended to minimize the possibility of damage:

- Pack the unit in its original packing material when shipping.
- Avoid high humidity or large temperature fluctuations.
- Keep the unit out of direct sunlight.
- Avoid unnecessary shocks and vibrations.

# 9 **Warranty**

## **General Information**

EXFO Inc. (EXFO) warrants this equipment against defects in material and workmanship for a period of one year from the date of original shipment. EXFO also warrants that this equipment will meet applicable specifications under normal use.

During the warranty period, EXFO will, at its discretion, repair, replace, or issue credit for any defective product, as well as verify and adjust the product free of charge should the equipment need to be repaired or if the original calibration is erroneous. If the equipment is sent back for verification of calibration during the warranty period and found to meet all published specifications, EXFO will charge standard calibration fees.



### **IMPORTANT**

The warranty can become null and void if:

- **unit has been tampered with, repaired, or worked upon by unauthorized individuals or non-EXFO personnel.**
- **warranty sticker has been removed.**
- **case screws, other than those specified in this guide, have been removed.**
- **case has been opened, other than as explained in this guide.**
- **unit serial number has been altered, erased, or removed.**
- **unit has been misused, neglected, or damaged by accident.**

THIS WARRANTY IS IN LIEU OF ALL OTHER WARRANTIES EXPRESSED, IMPLIED, OR STATUTORY, INCLUDING, BUT NOT LIMITED TO, THE IMPLIED WARRANTIES OF MERCHANTABILITY AND FITNESS FOR A PARTICULAR PURPOSE. IN NO EVENT SHALL EXFO BE LIABLE FOR SPECIAL, INCIDENTAL, OR CONSEQUENTIAL DAMAGES.

## **Warranty**

### *Liability*

---

## **Liability**

EXFO shall not be liable for damages resulting from the use of the product, nor shall be responsible for any failure in the performance of other items to which the product is connected or the operation of any system of which the product may be a part.

EXFO shall not be liable for damages resulting from improper usage or unauthorized modification of the product, its accompanying accessories and software.

## Exclusions

EXFO reserves the right to make changes in the design or construction of any of its products at any time without incurring obligation to make any changes whatsoever on units purchased. Accessories, including but not limited to fuses, pilot lamps, batteries and universal interfaces (EUI) used with EXFO products are not covered by this warranty.

This warranty excludes failure resulting from: improper use or installation, normal wear and tear, accident, abuse, neglect, fire, water, lightning or other acts of nature, causes external to the product or other factors beyond the control of EXFO.



### **IMPORTANT**

EXFO will charge a fee for replacing optical connectors that were damaged due to misuse or bad cleaning.

## Certification

EXFO certifies that this equipment met its published specifications at the time of shipment from the factory.

## Service and Repairs

EXFO commits to providing product service and repair for five years following the date of purchase.

**To send any equipment for service or repair:**

1. Call one of EXFO's authorized service centers (see *EXFO Service Centers Worldwide* on page 81). Support personnel will determine if the equipment requires service, repair, or calibration.
2. If equipment must be returned to EXFO or an authorized service center, support personnel will issue a Return Merchandise Authorization (RMA) number and provide an address for return.
3. If possible, back up your data before sending the unit for repair.
4. Pack the equipment in its original shipping material. Be sure to include a statement or report fully detailing the defect and the conditions under which it was observed.
5. Return the equipment, prepaid, to the address given to you by support personnel. Be sure to write the RMA number on the shipping slip. *EXFO will refuse and return any package that does not bear an RMA number.*

**Note:** *A test setup fee will apply to any returned unit that, after test, is found to meet the applicable specifications.*

After repair, the equipment will be returned with a repair report. If the equipment is not under warranty, you will be invoiced for the cost appearing on this report. EXFO will pay return-to-customer shipping costs for equipment under warranty. Shipping insurance is at your expense.

Routine recalibration is not included in any of the warranty plans. Since calibrations/verifications are not covered by the basic or extended warranties, you may elect to purchase FlexCare Calibration/Verification Packages for a definite period of time. Contact an authorized service center (see *EXFO Service Centers Worldwide* on page 81).

## **EXFO Service Centers Worldwide**

If your product requires servicing, contact your nearest authorized service center.

### **EXFO Headquarters Service Center**

400 Godin Avenue  
Quebec (Quebec) G1M 2K2  
CANADA

1 866 683-0155 (USA and Canada)  
Tel.: 1 418 683-5498  
Fax: 1 418 683-9224  
[quebec.service@exfo.com](mailto:quebec.service@exfo.com)

### **EXFO Europe Service Center**

Omega Enterprise Park, Electron Way  
Chandlers Ford, Hampshire S053 4SE  
ENGLAND

Tel.: +44 2380 246810  
Fax: +44 2380 246801  
[europe.service@exfo.com](mailto:europe.service@exfo.com)

### **EXFO Telecom Equipment (Shenzhen) Ltd.**

3rd Floor, Building 10,  
Yu Sheng Industrial Park (Gu Shu  
Crossing), No. 467,  
National Highway 107,  
Xixiang, Bao An District,  
Shenzhen, China, 518126

Tel: +86 (755) 2955 3100  
Fax: +86 (755) 2955 3101  
[beijing.service@exfo.com](mailto:beijing.service@exfo.com)





# A *Technical Specifications*



## IMPORTANT

The following technical specifications can change without notice. The information presented in this section is provided as a reference only. To obtain this product's most recent technical specifications, visit the EXFO Web site at [www.exfo.com](http://www.exfo.com).

### SPECIFICATIONS <sup>a</sup>

Measured wavelength range (nm)	1475 to 1626
Maximum measurement distance (km)	≥120 (140 with reflector)
Distance uncertainty (km)	±(0.01 + 1 % x distance)

#### Chromatic dispersion <sup>b</sup>

Number of test points	8
CD uncertainty (ps/nm)	±10
Test time (s)	40

#### PMD <sup>c</sup>

PMD display range (ps)	up to 50
PMD range (strong mode coupling) (ps)	0.1 to 20
PMD uncertainty (strong mode coupling) (ps) <sup>d</sup>	± (0.2 + 5 % x PMD)
Test time (s)	<180

### GENERAL SPECIFICATIONS

Temperature		
Operating	0 °C to 50 °C	(32 °F to 122 °F)
Storage	-40 °C to 70 °C	(-40 °F to 158 °F)
Relative humidity	0 % to 93 % non-condensing	
Size (H x W x D)	96 mm x 50 mm x 281 mm	(3 3/4 in x 2 in x 11 in)
Weight	1.3 kg	(2.8 lb)

### SAFETY

21 CFR 1040.10 and IEC 60825-1:2007  
CLASS 1 LASER PRODUCT

#### Notes

- Typical.
- At 1550 nm, on 100 km of G.652 single-mode fiber.
- For a fiber length ≥100 m.
- For strong mode coupling PMD (telecom fiber) up to 15 ps, with averaging.



# Index

<b>A</b>	
acquisition	
parameter setup .....	26
stopping .....	43
after-sales service .....	75
analysis parameters .....	54
application details .....	18
application, starting .....	15
automatic names for fibers .....	29
<b>B</b>	
bad results, removing .....	57
<b>C</b>	
cable information .....	48
calibration	
certificate .....	64
interval .....	64
caution	
of personal hazard .....	5
of product hazard .....	5
CD	
graph .....	47
parameters .....	26
results .....	40
thresholds .....	22
viewing details .....	46
certification information .....	v
chromatic dispersion, measuring .....	43
cleaning	
EUI connectors .....	62
fiber ends .....	37
front panel .....	61
closing files .....	58
coefficient	
chromatic dispersion .....	47
threshold .....	22
configurations .....	30
connectors, cleaning .....	62
conventions, safety .....	5
coupling	
strong .....	27
weak .....	27
customer service .....	80
<b>D</b>	
defining	
acquisition parameters .....	26
fiber name .....	29
thresholds .....	22
details, application .....	18
detecting module .....	12
display, CD graph .....	47
<b>E</b>	
equipment returns .....	80
EUI	
baseplate .....	39
connector adapter .....	39
dust cap .....	39
EUI connectors, cleaning .....	62
EXFO universal interface. see EUI	
<b>F</b>	
fiber	
defining name format .....	29
type .....	27
fiber ends, cleaning .....	37
files	
closing .....	58
opening .....	56
front panel, cleaning .....	61
FUT, naming .....	29

# Index

---

<b>G</b>	
generating report.....	59
<b>H</b>	
help. see online user guide	
<b>I</b>	
identification label.....	75
information	
cable.....	48
job.....	50
inserting a module.....	9
<b>J</b>	
job information.....	50
<b>L</b>	
label, identification.....	75
<b>M</b>	
maintenance	
EUI connectors.....	62
front panel.....	61
general information.....	61
module	
detection.....	12
insertion.....	9
removal.....	9
mounting EUI connector adapter.....	39
<b>N</b>	
naming fibers.....	29
negligible coupling fiber.....	27
<b>O</b>	
online user guide.....	74
opening file.....	56

<b>P</b>	
parameters, analysis.....	54
parameters, defining.....	26
parameters, threshold.....	52
PDF. see online user guide	
performing a test.....	40
PMD	
parameters.....	26
results.....	40
thresholds.....	22
polarization maintaining fiber.....	27
preferences, test.....	34
product	
identification label.....	75
specifications.....	83
<b>R</b>	
random coupling fiber.....	27
range, wavelength.....	24
recalibration.....	64
removing a module.....	9
removing bad results.....	57
reports, generating.....	59
results, viewing.....	46
return merchandise authorization (RMA) ....	80
<b>S</b>	
safety	
caution.....	5
conventions.....	5
warning.....	5
service and repairs.....	80
service centers.....	81
setting wavelength range.....	24
shipping to EXFO.....	80
software. see application	
specifications, product.....	83
starting acquisition.....	40
stopping an acquisition.....	43
storage requirements.....	61

strong coupling fiber..... 27  
symbols, safety..... 5

**T**

technical specifications..... 83  
technical support ..... 75  
telecom fiber..... 27  
temperature for storage..... 61  
test  
    performing ..... 40  
    viewing results..... 46  
test configurations ..... 30  
test preferences..... 34  
threshold parameters ..... 52  
transportation requirements ..... 61, 76  
type of fiber ..... 27

**U**

unit recalibration..... 64  
user guide. see online user guide

**V**

viewing  
    CD details ..... 46  
    results..... 46

**W**

warranty  
    certification ..... 79  
    exclusions ..... 79  
    general ..... 77  
    liability..... 78  
    null and void..... 77  
wavelength range ..... 24  
weak coupling fiber..... 27

## NOTICE

### 通告

#### CHINESE REGULATION ON RESTRICTION OF HAZARDOUS SUBSTANCES

#### 中国关于有害物质限制的规定

#### NAMES AND CONTENTS OF THE TOXIC OR HAZARDOUS SUBSTANCES OR ELEMENTS CONTAINED IN THIS EXFO PRODUCT



包含在本 EXFO 产品中的有毒有害物质或元素的名称和含量

O	Indicates that this toxic or hazardous substance contained in all of the homogeneous materials for this part is below the limit requirement in SJ/T11363-2006 表示该有毒有害物质在该部件所有均质材料中的含量均在 SJ/T11363-2006 标准规定的限量要求以下。
X	Indicates that this toxic or hazardous substance contained in at least one of the homogeneous materials used for this part is above the limit requirement in SJ/T11363-2006 表示该有毒有害物质至少在该部件的某一均质材料中的含量超出 SJ/T11363-2006 标准规定的限量要求。

Part Name 部件名称	Toxic or hazardous Substances and Elements 有毒有害物质和元素					
	Lead 铅 (Pb)	Mercury 汞 (Hg)	Cadmium 镉 (Cd)	Hexavalent Chromium 六价铬 (Cr VI)	Polybrominated biphenyls 多溴联苯 (PBB)	Polybrominated diphenyl ethers 多溴二苯醚 (PBDE)
Enclosure 外壳	O	O	O	O	O	O
Electronic and electrical sub-assembly 电子和电子组件	X	O	X	O	X	X
Optical sub-assembly <sup>a</sup> 光学组件 <sup>a</sup>	X	O	O	O	O	O
Mechanical sub-assembly <sup>a</sup> 机械组件 <sup>a</sup>	O	O	O	O	O	O

a. If applicable.  
如果适用。

MARKING REQUIREMENTS  
标注要求

Product 产品	Environmental protection use period (years) 环境保护使用期限 (年)	Logo 标志
This Exfo product 本 EXFO 产品	10	
Battery <sup>a</sup> 电池 <sup>a</sup>	5	

- a. If applicable.  
如果适用。

P/N: 1059006

[www.EXFO.com](http://www.EXFO.com) · [info@exfo.com](mailto:info@exfo.com)

<b>CORPORATE HEADQUARTERS</b>	400 Godin Avenue	Quebec (Quebec) G1M 2K2 CANADA Tel.: 1 418 683-0211 · Fax: 1 418 683-2170
<b>EXFO AMERICA</b>	3701 Plano Parkway, Suite 160	Plano TX, 75075 USA Tel.: 1 972 907-1505 · Fax: 1 972 836-0164
<b>EXFO EUROPE</b>	Omega Enterprise Park, Electron Way	Chandlers Ford, Hampshire S053 4SE ENGLAND Tel.: +44 2380 246810 · Fax: +44 2380 246801
<b>EXFO ASIA-PACIFIC</b>	151 Chin Swee Road #03-29, Manhattan House	SINGAPORE 169876 Tel.: +65 6333 8241 · Fax: +65 6333 8242
<b>EXFO CHINA</b>	No. 88 Fuhua First Road, Central Tower, Room 801, Futian District	Shenzhen 518048 P. R. CHINA Tel.: +86 (755) 8203 2300 · Fax: +86 (755) 8203 2306
	Beijing New Century Hotel Office Tower, Room 1754-1755, No. 6 Southern Capital Gym Road	Beijing 100044 P. R. CHINA Tel.: +86 (10) 6849 2738 · Fax: +86 (10) 6849 2662
<b>EXFO SERVICE ASSURANCE</b>	285 Mill Road	Chelmsford MA, 01824 USA Tel.: 1 978 367-5600 · Fax: 1 978 367-5700
<b>TOLL-FREE</b>	(USA and Canada)	1 800 663-3936

© 2010 EXFO Inc. All rights reserved.  
Printed in Canada (2010-06)

