

FTB-7000 Series

OTDR for FTB-400



Copyright © 1997–2009 EXFO Electro-Optical Engineering Inc. All rights reserved. No part of this publication may be reproduced, stored in a retrieval system or transmitted in any form, be it electronically, mechanically, or by any other means such as photocopying, recording or otherwise, without the prior written permission of EXFO Electro-Optical Engineering Inc. (EXFO).

Information provided by EXFO is believed to be accurate and reliable. However, no responsibility is assumed by EXFO for its use nor for any infringements of patents or other rights of third parties that may result from its use. No license is granted by implication or otherwise under any patent rights of EXFO.

EXFO's Commerce And Government Entities (CAGE) code under the North Atlantic Treaty Organization (NATO) is 0L8C3.

The information contained in this publication is subject to change without notice.

Trademarks

EXFO's trademarks have been identified as such. However, the presence or absence of such identification does not affect the legal status of any trademark.

Units of Measurement

Units of measurement in this publication conform to SI standards and practices.

Patents

EXFO's Universal Interface is protected by US patent 6,612,750.

Version number: 9.0.3

Contents

Certification Information	viii
1 Introducing the FTB-7000 Series OTDR	1
Main Features	2
Trace Acquisition Modes	3
Data Post-Processing	3
Bidirectional Averaging Utility	3
Available OTDR Models	4
OTDR Basic Principles	6
Conventions	8
2 Safety Information	9
Laser Safety Information (Models without VFL)	9
Laser Safety Information (Models with VFL)	10
3 Getting Started with Your OTDR	11
Inserting and Removing Test Modules	11
Connecting a Switch to the OTDR	17
Starting the OTDR Application	18
Understanding the Timer	21
Exiting the Application	21
4 Setting Up Your OTDR	23
Installing the EXFO Universal Interface (EUI)	23
Cleaning and Connecting Optical Fibers	24
Defining Cables	26
Naming Trace Files Automatically	49
Enabling or Disabling the First Connector Check	54
Launch Conditions for Multimode Measurements	56
5 Testing Fibers in Auto Mode	59

Contents

6 Testing Fibers in Advanced Mode	65
Setting the Autorange Acquisition Time	70
Setting the IOR, RBS Coefficient, and Helix Factor	71
Setting Distance Range, Pulse Width, and Acquisition Time	74
Enabling the High-Resolution Feature	77
Enabling or Disabling Analysis After Acquisition	79
Setting Pass/Fail Thresholds	80
Setting a Default Span Start and Span End	85
Saving the Span-Start and Span-End Information	87
Selecting the Operation Mode	88
Setting Optical Switch Parameters	90
Retesting Channels	92
Monitoring Fiber in Real-Time Mode	94
7 Testing Fibers in Template Mode	95
Template Principle	95
Restrictions of Template Mode	96
Processing Traces	98
Acquiring the Reference Trace	99
Acquiring Traces in Template Mode	101
8 Customizing the Application	111
Selecting the Default File Format	111
Enabling or Disabling File Name Confirmation	112
Enabling or Disabling Confirmation before Discarding Unnamed Trace	114
Displaying or Hiding Pass/Fail Messages	116
Selecting the Distance Units	118
Customizing the Acquisition Distance Range Values	120
Customizing the Acquisition Time Values	122
Defining the Number of Digits Displayed after the Decimal Point	124
Enabling or Disabling the Beep Emitted After Acquisitions	126
Defining OTDR Setups	127
Selecting an OTDR Setup	130

9 Analyzing Traces and Events	131
Trace Display and Events Table Description	132
Event Pane	134
Measure Pane	137
Trace Info Pane	137
Viewing Test Results	138
Using Zoom Controls	139
Setting Trace Display Parameters	142
Customizing the Event Table	144
Selecting the Pulse Width Unit	147
Selecting a Trace Display Mode	148
Displaying or Hiding a Trace	149
Clearing Traces from the Display	151
Modifying Space Between Traces on the Graph	154
Viewing and Modifying Current Trace Settings	155
Changing the Loss and Reflectance of Events	160
Inserting Events	164
Deleting Events	166
Changing the Attenuation of Fiber Sections	167
Setting the Analysis Detection Thresholds	170
Analyzing or Reanalyzing a Trace	173
Analyzing the Fiber on a Specific Fiber Span	175
Enabling or Disabling the Detection of Reflective Ends of Fiber	178
Entering Comments	182
Opening Trace Files	183
Defining a Reference Trace	187
10 Analyzing the Results Manually	189
Selecting the Attenuation and Loss Values that Will Be Displayed	189
Using Markers	191
Getting Event Distances and Relative Powers	192
Getting Event Loss (Four-Point and Least-Square Approximation)	193
Getting Attenuation (Two-Point and Least-Square Approximation)	198
Getting Reflectance	200
Getting Optical Return Loss (ORL)	201
11 Managing Trace Files	203
Saving a Trace in a Different Format	203
OTDR Trace File Compatibility	208
Copying, Moving, Renaming, or Deleting Trace Files	210

Contents

12 Creating and Printing Trace Reports	211
Adding Information to the Test Results	212
Customizing the Report	217
Printing a Report	226
13 Using the OTDR as a Light Source or VFL	229
14 Analyzing Bidirectional Traces	233
Starting and Exiting the Bidirectional Analysis Utility	234
Creating Bidirectional Trace Files	236
Opening Existing Bidirectional Trace Files	240
Viewing Test Results	242
Analyzing the Fiber on a Specific Fiber Span	243
Analyzing Bidirectional Traces	246
Changing Event Tables	248
Viewing and Modifying Current Trace Parameters	249
Saving Traces	254
Documenting Results	256
Creating a Report	256
Printing a Report	256
15 Preparing for Automation or Remote Control	257
16 Maintenance	265
Cleaning EUI Connectors	266
Verifying Your OTDR	268
Recalibrating the Unit	276
Recycling and Disposal (Applies to European Union Only)	277
17 Troubleshooting	279
Solving Common Problems	279
Error Messages	282
Obtaining Online Help	285
Contacting the Technical Support Group	286
Transportation	288
18 Warranty	289
General Information	289
Liability	290
Exclusions	290
Certification	290
Service and Repairs	291
EXFO Service Centers Worldwide	292

A Technical Specifications	293
B Description of Event Types	295
Span Start	296
Span End	296
Short Fibers	296
Continuous Fiber	297
End of Analysis	298
Non-Reflective Event	299
Reflective Event	300
Positive Event	301
Launch Level	302
Fiber Section	303
Merged Reflective Event	304
Echo	306
Reflective Event (Possible Echo)	307
C SCPI Command Reference	309
Quick Reference Command Tree	310
Product-Specific Commands—Description	316
Index	455

Certification Information

F.C.C. Information

Electronic test equipment is exempt from Part 15 compliance (FCC) in the United States. However, compliance verification tests are systematically performed on most EXFO equipment.

CE Information

Electronic test equipment is subject to the EMC Directive in the European Union. The EN61326 standard prescribes both emission and immunity requirements for laboratory, measurement, and control equipment. This unit has undergone extensive testing according to the European Union Directive and Standards.



IMPORTANT

Use of shielded remote I/O cables, with properly grounded shields and metal connectors, is recommended in order to reduce radio frequency interference that may emanate from these cables.

EXFO **CE** **DECLARATION OF CONFORMITY**

Application of Council Directive(s):	2006/95/EC - The Low Voltage Directive 2004/108/EC - The EMC Directive And their amendments
Manufacturer's Name:	EXFO Electro-Optical Engineering Inc.
Manufacturer's Address:	400 Godin Avenue Quebec, Quebec Canada, G1M 2K2 (418) 683-0211
Equipment Type/Environment:	Test & Measurement / Industrial
Trade Name/Model No.:	FTB-7200D LAN/WAN/ACCESS OTDR

Standard(s) to which Conformity is Declared:

EN 61010-1:2001	Safety Requirements for Electrical Equipment for Measurement, Control, and Laboratory Use, Part 1: General Requirements.
EN 61326-1:2006	Electrical Equipment for Measurement, Control and Laboratory Use - EMC Requirements – Part 1: General requirements
EN 60825-1:1994 +A2:2001 +A1:2002	Safety of laser products – Part 1: Equipment classification, requirements, and user's guide
EN 55022: 1998 +A2: 2003	Information technology equipment - Radio disturbance characteristics - Limits and methods of measurement

I, the undersigned, hereby declare that the equipment specified above conforms to the above Directive and Standards.

Manufacturer

Signature:

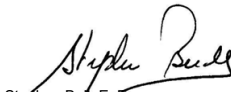

Full Name: Stephen Bull, E. Eng
Position: Vice-President Research and Development
Address: 400 Godin Avenue, Quebec (Quebec),
Canada, G1M 2K2
Date: January 09, 2009

Certification Information

EXFO **CE** DECLARATION OF CONFORMITY

Application of Council Directive(s):	2006/95/EC - The Low Voltage Directive 2004/108/EC - The EMC Directive And their amendments
Manufacturer's Name:	EXFO Electro-Optical Engineering Inc.
Manufacturer's Address:	400 Godin Avenue Quebec, Quebec Canada, G1M 2K2 (418) 683-0211
Equipment Type/Environment:	Test & Measurement / Industrial
Trade Name/Model No.:	FTB-7300E FTTx-PON/MDU OTDR

Standard(s) to which Conformity is Declared:

EN 61010-1:2001	Safety Requirements for Electrical Equipment for Measurement, Control, and Laboratory Use, Part 1: General Requirements.
EN 61326-1:2006	Electrical Equipment for Measurement, Control and Laboratory Use - EMC Requirements – Part 1: General requirements
EN 60825-1:1994 +A2:2001 +A1:2002	Safety of laser products – Part 1: Equipment classification, requirements, and user's guide
EN 55022: 1998 +A2: 2003	Information technology equipment - Radio disturbance characteristics - Limits and methods of measurement

I, the undersigned, hereby declare that the equipment specified above conforms to the above Directive and Standards.

Manufacturer

Signature:



Full Name: Stephen Bull, E. Eng
Position: Vice-President Research and Development
Address: 400 Godin Avenue, Quebec (Quebec),
Canada, G1M 2K2
Date: January 09, 2009

EXFO **CE** **DECLARATION OF CONFORMITY**

Application of Council Directive(s):	2006/95/EC - The Low Voltage Directive 2004/108/EC - The EMC Directive And their amendments
Manufacturer's Name:	EXFO Electro-Optical Engineering Inc.
Manufacturer's Address:	400 Godin Avenue Quebec, Quebec Canada, G1M 2K2 (418) 683-0211
Equipment Type/Environment:	Test & Measurement / Industrial
Trade Name/Model No.:	FTB-7400E METRO/CWDM OTDR

Standard(s) to which Conformity is Declared:

EN 61010-1:2001	Safety Requirements for Electrical Equipment for Measurement, Control, and Laboratory Use, Part 1: General Requirements.
EN 61326-1:2006	Electrical Equipment for Measurement, Control and Laboratory Use - EMC Requirements – Part 1: General requirements
EN 60825-1:1994 +A2:2001 +A1:2002	Safety of laser products – Part 1: Equipment classification, requirements, and user's guide
EN 55022: 1998 +A2: 2003	Information technology equipment - Radio disturbance characteristics - Limits and methods of measurement

I, the undersigned, hereby declare that the equipment specified above conforms to the above Directive and Standards.

Manufacturer

Signature:

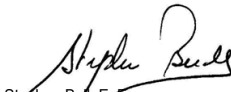

Full Name: Stephen Bull, E, Eng
Position: Vice-President Research and Development
Address: 400 Godin Avenue, Quebec (Quebec),
Canada, G1M 2K2
Date: January 09, 2009

Certification Information

EXFO DECLARATION OF CONFORMITY

Application of Council Directive(s):	2006/95/EC - The Low Voltage Directive 2004/108/EC - The EMC Directive And their amendments
Manufacturer's Name:	EXFO Electro-Optical Engineering Inc.
Manufacturer's Address:	400 Godin Avenue Quebec, Quebec Canada, G1M 2K2 (418) 683-0211
Equipment Type/Environment:	Test & Measurement / Industrial
Trade Name/Model No.:	FTB-7500E METRO/LONG-HAUL OTDR

Standard(s) to which Conformity is Declared:

EN 61010-1:2001	Safety Requirements for Electrical Equipment for Measurement, Control, and Laboratory Use, Part 1: General Requirements.
EN 61326-1:2006	Electrical Equipment for Measurement, Control and Laboratory Use - EMC Requirements – Part 1: General requirements
EN 60825-1:1994 +A2:2001 +A1:2002	Safety of laser products – Part 1: Equipment classification, requirements, and user's guide
EN 55022: 1998 +A2: 2003	Information technology equipment - Radio disturbance characteristics - Limits and methods of measurement

I, the undersigned, hereby declare that the equipment specified above conforms to the above Directive and Standards.

Manufacturer

Signature:



Full Name: Stephen Bull, E. Eng
Position: Vice-President Research and Development
Address: 400 Godin Avenue, Quebec (Quebec),
Canada, G1M 2K2
Date: January 09, 2009

EXFO **CE** **DECLARATION OF CONFORMITY**

Application of Council Directive(s):	2006/95/EC - The Low Voltage Directive 2004/108/EC - The EMC Directive And their amendments
Manufacturer's Name:	EXFO Electro-Optical Engineering Inc.
Manufacturer's Address:	400 Godin Avenue Quebec, Quebec Canada, G1M 2K2 (418) 683-0211
Equipment Type/Environment:	Test & Measurement / Industrial
Trade Name/Model No.:	FTB-7600E ULTRA-LONG-HAUL OTDR

Standard(s) to which Conformity is Declared:

EN 61010-1:2001	Safety Requirements for Electrical Equipment for Measurement, Control, and Laboratory Use, Part 1: General Requirements.
EN 61326-1:2006	Electrical Equipment for Measurement, Control and Laboratory Use - EMC Requirements – Part 1: General requirements
EN 60825-1:1994 +A2:2001 +A1:2002	Safety of laser products – Part 1: Equipment classification, requirements, and user's guide
EN 55022: 1998 +A2: 2003	Information technology equipment - Radio disturbance characteristics - Limits and methods of measurement

I, the undersigned, hereby declare that the equipment specified above conforms to the above Directive and Standards.

Manufacturer

Signature:



Full Name: Stephen Bull, E, Eng
Position: Vice-President Research and Development
Address: 400 Godin Avenue, Quebec (Quebec),
Canada, G1M 2K2
Date: January 09, 2009

1 Introducing the FTB-7000 Series OTDR

The FTB-7000 Series OTDR allows you to characterize a fiber-optic span, usually optical fiber sections joined by splices and connectors. The optical time domain reflectometer (OTDR) provides an inside view of the fiber, and can calculate fiber length, attenuation, breaks, total return loss, and splice, connector and total losses.

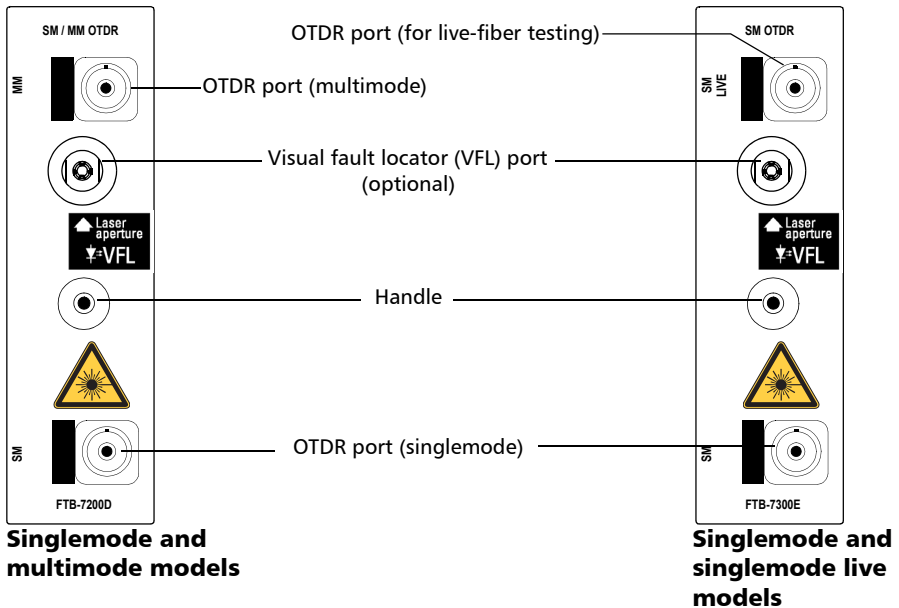

Introducing the FTB-7000 Series OTDR

Main Features

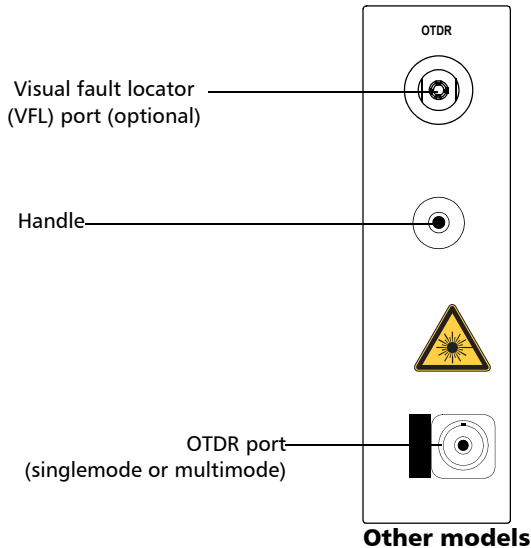

Main Features

The OTDR:

- Can be used with the FTB-400 Universal Test System (refer to *FTB-400 Universal Test System* user guide).
- Offer impressive dynamic range with short dead zones.
- Perform quick acquisitions with low noise levels to enable accurate low-loss splice location.
- Acquire OTDR traces made of up to 256 000 points that provide a sampling resolution as fine as 4 cm.
- Include a light source and can include an optional visual fault locator.

Trace Acquisition Modes

The OTDR application provides the following trace acquisition modes:

- *Auto*: Automatically calculates fiber length, sets acquisition parameters, acquires traces, and displays event tables and acquired traces.
- *Advanced*: Offers all the tools needed to perform integral OTDR tests and measurements and gives you control over all test parameters.
- *Template*: Tests fibers and compares the results to a reference trace that was previously acquired and analyzed. This allows you to save time when testing a large number of fibers. Reference trace documentation is also automatically copied to new acquisitions.

Data Post-Processing

You can install the OTDR test application on a computer to view and analyze traces without having to use an FTB-400 Universal Test System and an OTDR.

Bidirectional Averaging Utility

You can improve the accuracy of your loss measurements with the bidirectional averaging utility. This utility uses OTDR acquisitions from both ends of a fiber span (*singlemode* traces only) to average loss results for each event.

Introducing the FTB-7000 Series OTDR

Available OTDR Models

Available OTDR Models

A wide variety of multimode and singlemode OTDR models is offered at several wavelengths to cover all fiber applications from long-haul or WDM networks to metropolitan networks.

OTDR Models	Description
Singlemode FTB-7200D-B	<ul style="list-style-type: none">▶ 1310 nm and 1550 nm.▶ 35 dB dynamic range and 1 m event dead zone, useful to locate closely spaced events.▶ High-resolution feature to obtain more data points per acquisition. Data points will be closer to each other, resulting in a greater distance resolution for the trace.
Singlemode and multimode FTB-7200D-12CD-23B	<ul style="list-style-type: none">▶ Four wavelengths: two multimode (850 nm and 1300 nm) and two singlemode (1310 nm and 1550 nm) in a single module.▶ 26 dB (850 nm)/25 dB (1300 nm)/35 dB (1310 nm)/34 dB (1550 nm) dynamic range and 1 m event dead zone, particularly useful to locate closely spaced events.▶ 4.5 m of attenuation dead zone for both singlemode and multimode.▶ Allows tests on both 50 μm (C type) and 62.5 μm (D type) multimode fibers.
Singlemode and singlemode live (SM Live) FTB-7300E-XXXXB	<ul style="list-style-type: none">▶ Optimized for metro network installation and troubleshooting, access and FTTx test applications (end-to-end links), and inside plant testing.▶ Test through splitter for FTTH PON characterization.▶ Live fiber out-of-band testing with filtered SM Live port at 1625 nm or 1650 nm.▶ Attenuation and event dead zone of, respectively, 4 m and 0.8 m.▶ 38 dB dynamic range.

OTDR Models	Description
Singlemode FTB-7400E-XXXXB	<ul style="list-style-type: none"> ➤ Attenuation dead zone of 4 m for pinpoint event location ➤ Up to 40 dB dynamic range with 0.8 m event dead zone. ➤ Acquires up to 256 000 data points while sampling a single trace. ➤ Up to four test wavelengths (1310 nm, 1383 nm, 1550 nm, 1625 nm) for CWDM and DWDM link characterization
Singlemode FTB-7500E-XXXXB	<ul style="list-style-type: none"> ➤ Event dead zone of 0.8 m and attenuation dead zone of 4 m for pinpoint event location ➤ Up to 45 dB dynamic range (on NZDSF with a 20 μs pulse) ➤ High-launch power level minimizes noise effects on signal. ➤ Acquires up to 256 000 data points while sampling a single trace. ➤ Suitable for long-range applications and recommended when measuring time is a key factor.
Singlemode FTB-7600E-XXXXB	<ul style="list-style-type: none"> ➤ Up to 50 dB dynamic range (on NZDSF with a 20 μs pulse) ➤ Event dead zone of 1.5 m and attenuation dead zone of 5 m with a 5 ns pulse for high resolution ➤ Acquires up to 256 000 data points while sampling a single trace ➤ Suitable for characterization of ultra long cables ➤ Best in class analysis for accurate measurement of loss, reflectance and attenuation.

OTDR Basic Principles

An OTDR sends short pulses of light into a fiber. Light scattering occurs in the fiber due to discontinuities such as connectors, splices, bends, and faults. An OTDR then detects and analyzes the backscattered signals. The signal strength is measured for specific intervals of time and is used to characterize events.

The OTDR calculates distances as follows:

$$\text{Distance} = \frac{c}{n} \times \frac{t}{2}$$

where

- c = speed of light in a vacuum (2.998×10^8 m/s)
- t = time delay from the launch of the pulse to the reception of the pulse
- n = index of refraction of the fiber under test (as specified by the manufacturer)

An OTDR uses the effects of Rayleigh scattering and Fresnel reflection to measure the fiber's condition, but the Fresnel reflection is tens of thousands of times greater in power level than the backscatter.

- Rayleigh scattering occurs when a pulse travels down the fiber and small variations in the material, such as variations and discontinuities in the index of refraction, cause light to be scattered in all directions. However, the phenomenon of small amounts of light being reflected directly back toward the transmitter is called backscattering.
- Fresnel reflections occur when the light traveling down the fiber encounters abrupt changes in material density that may occur at connections or breaks where an air gap exists. A very large quantity of light is reflected, as compared with the Rayleigh scattering. The strength of the reflection depends on the degree of change in the index of refraction.

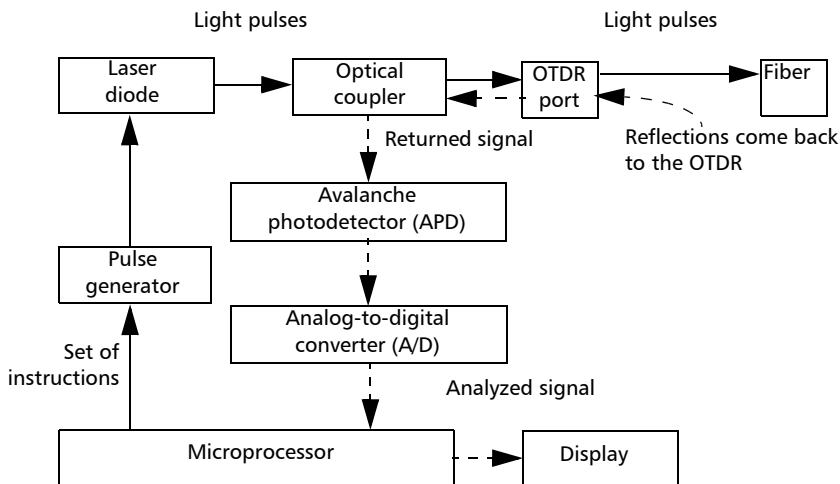

When the full trace is displayed, each point represents an average of many sampling points. You will have to zoom to see each point (see *Using Zoom Controls* on page 139).

Conventions

Before using the product described in this manual, you should understand the following conventions:



WARNING

Indicates a potentially hazardous situation which, if not avoided, could result in *death or serious injury*. Do not proceed unless you understand and meet the required conditions.



CAUTION

Indicates a potentially hazardous situation which, if not avoided, may result in *minor or moderate injury*. Do not proceed unless you understand and meet the required conditions.



CAUTION

Indicates a potentially hazardous situation which, if not avoided, may result in *component damage*. Do not proceed unless you understand and meet the required conditions.



IMPORTANT

Refers to information about this product you should not overlook.

2 **Safety Information**



WARNING

Do not install or terminate fibers while a light source is active. Never look directly into a live fiber and ensure that your eyes are protected at all times.



WARNING

Use of controls, adjustments and procedures for operation and maintenance other than those specified herein may result in hazardous radiation exposure or impair the protection provided by this unit.

Laser Safety Information (Models without VFL)

Your instrument is a Class 1M laser product in compliance with standards IEC 60825-1 Amendment 2: 2001 and 21 CFR 1040.10. Invisible laser radiation may be encountered at the output port.

The product is safe under reasonably foreseeable conditions of operation but it may be hazardous if you use optics within a diverging or collimated beam. *Do not view directly with optical instruments.*

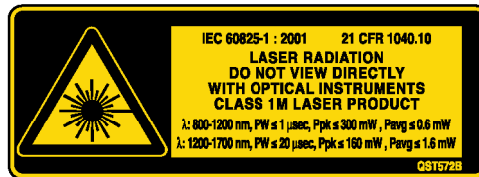

— Affixed to module's side panel

Safety Information

Laser Safety Information (Models with VFL)

Laser Safety Information (Models with VFL)

Your instrument is a Class 3R laser product in compliance with standards IEC 60825-1 Amendment 2: 2001 and 21 CFR 1040.10. It is potentially harmful in direct intrabeam viewing.

The following label(s) indicate that the product contains a Class 3R source:

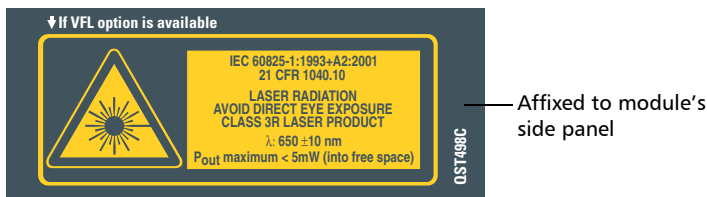

3 Getting Started with Your OTDR

Inserting and Removing Test Modules



CAUTION

Never insert or remove a module while the FTB-400 Universal Test System is turned on. This will result in immediate and irreparable damage to both the module and unit.



WARNING

When the laser safety LED () is flashing on the FTB-400, at least one of your modules is emitting an optical signal. Please check all modules, as it might not be the one you are currently using.

To insert a module into the FTB-400 Universal Test System:

1. Exit ToolBox and turn off your unit.
2. Position the FTB-400 so that its right panel is facing you.
3. Take the module and place it so that the connector pins are at the back, as explained and shown below.



CAUTION

Inserting a module upside down could result in permanent damage to the module, as the connector pins might be bent.

- (2-slot or 4-slot receptacles) identification sticker must be on left side and retaining screw hole *under* connector pins.

Getting Started with Your OTDR

Inserting and Removing Test Modules

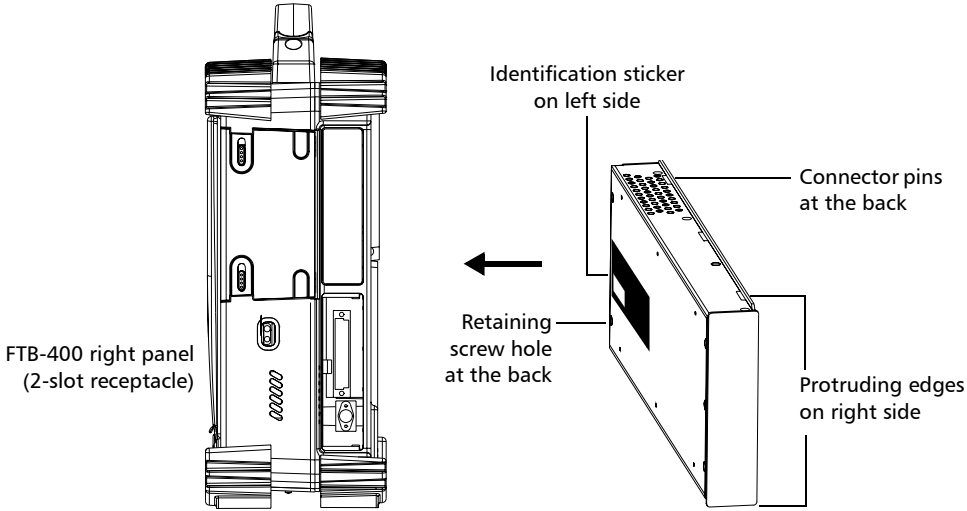

- (7-slot or 8-slot receptacles) identification sticker must be facing down and connector pins at the left of the retaining screw hole.

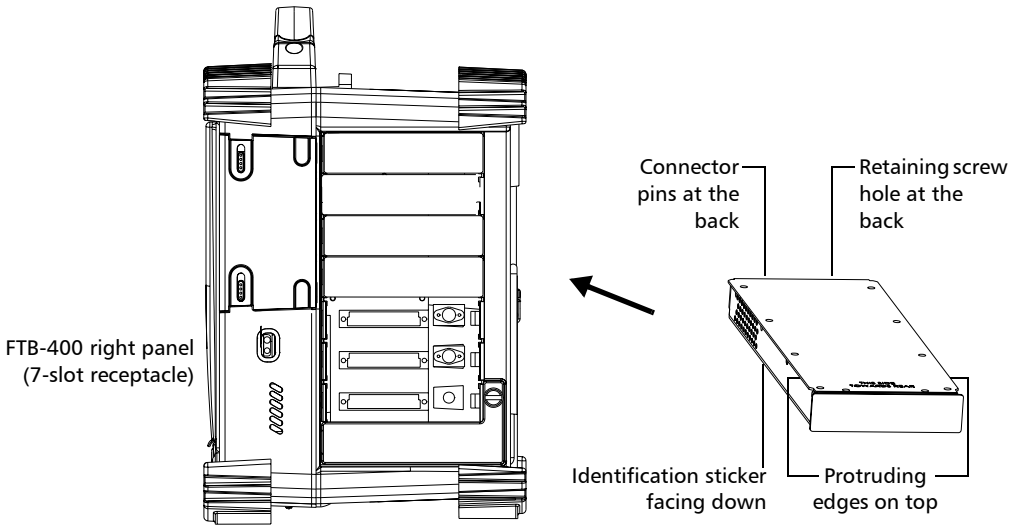

- 4.** Insert the protruding edges of the module into the grooves of the receptacle's module slot.
- 5.** Push the module all the way to the back of the slot, until the retaining screw makes contact with the receptacle casing.
- 6.** Place the FTB-400 so that its left panel is facing you.

Getting Started with Your OTDR

Inserting and Removing Test Modules

7. While applying slight pressure to the module, turn the retaining screw clockwise until it is tightened.

This will secure the module into its “seated” position.

Turn retaining screw knob
clockwise

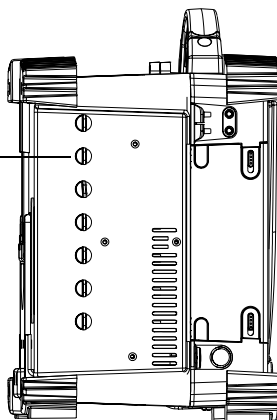
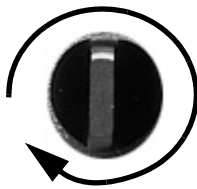

FTB-400 left panel
(7-slot or 8-slot receptacles)

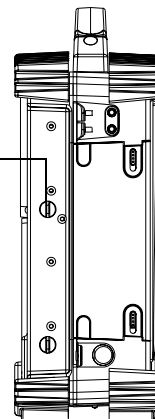

FTB-400 left panel
(2-slot or 4-slot receptacles)

When you turn on the unit, the startup sequence will automatically detect the module.

To remove a module from the FTB-400 Universal Test System:

1. Exit ToolBox and turn off your unit.
2. Position the FTB-400 so that the left panel is facing you.
3. Turn the retaining screw counterclockwise until it stops.

The module will be slowly released from the slot.

Turn retaining screw knob(s)
counterclockwise

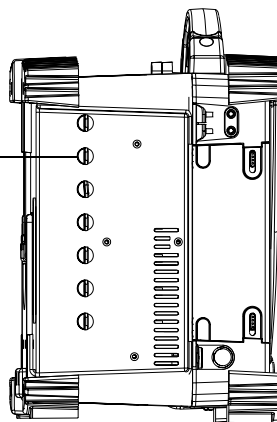
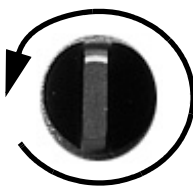

FTB-400 left panel
(7-slot or 8-slot receptacles)

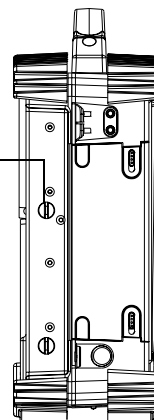

FTB-400 left panel
(2-slot or 4-slot receptacles)

4. Place the FTB-400 so that the right panel is facing you.

Getting Started with Your OTDR

Inserting and Removing Test Modules

5. Hold the module by its sides or by the handle (*NOT by the connector*) and pull it out.

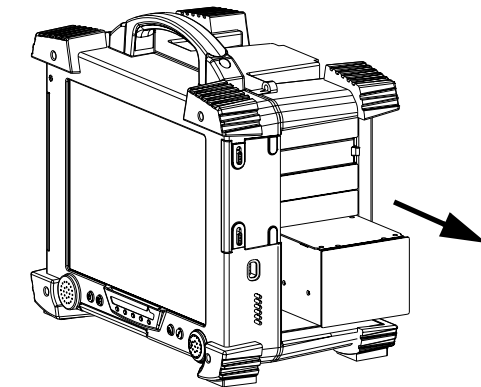

CAUTION

Pulling out a module by a connector could seriously damage both the module and connector. Always pull out a module by its casing.

6. Cover empty slots with the supplied protective covers.



CAUTION

Failure to reinstall protective covers over empty slots will result in ventilation problems.

Connecting a Switch to the OTDR

You can couple your OTDR with a switch to test several fibers without having to connect and disconnect them before each acquisition. You can test with a switch in Advanced mode only.



IMPORTANT

The switch must match the fiber type (singlemode or multimode). To test both types, you need two switches.

To avoid heavy losses in multimode testing, the switch must also match the core of the fiber under test (50 μm or 62.5 μm).

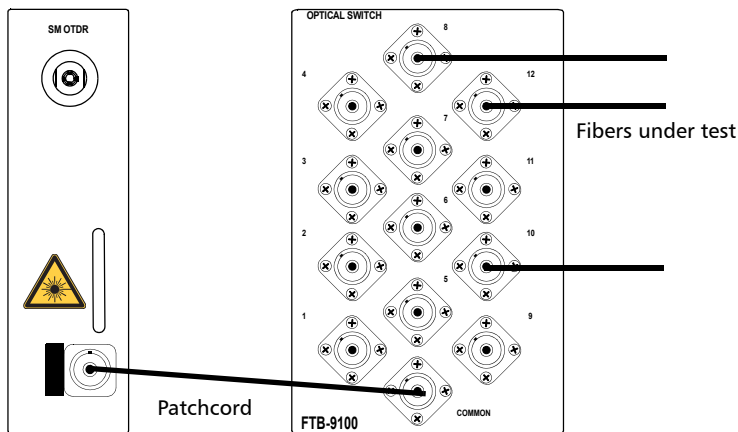

For more information on switch configuration, see *Selecting the Operation Mode* on page 88 and *Setting Optical Switch Parameters* on page 90.

For more information on the switch itself, refer to the *FTB-9100 Optical Switch* user guide.

Getting Started with Your OTDR

Starting the OTDR Application

Starting the OTDR Application

Your FTB-7000 Series OTDR module can be configured and controlled from its dedicated ToolBox application.

Note: For details about ToolBox, refer to the FTB-400 Universal Test System user guide.

To start the application:

1. From the **Current Modules** function tab, select the module to use.

It will turn white to indicate that it is highlighted.

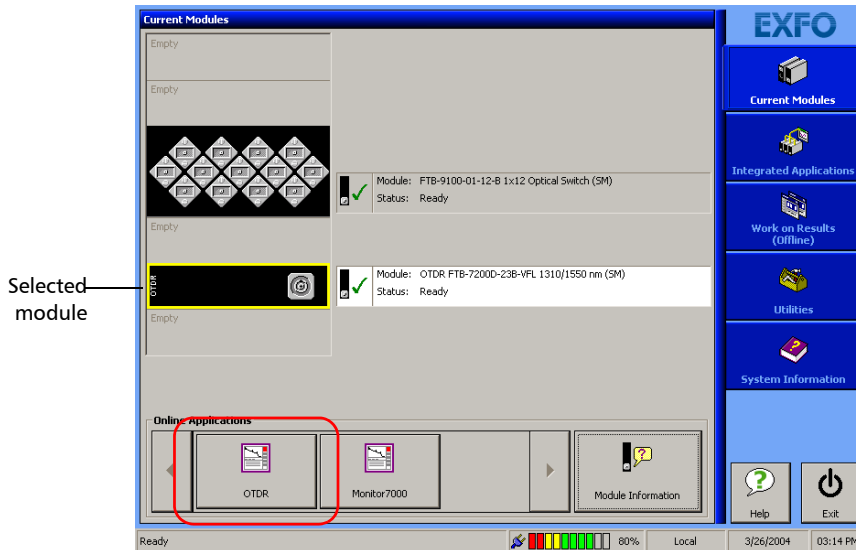

2. Click the corresponding button in the **Online Applications** box.

The main window (shown below) contains all the commands required to control the OTDR:

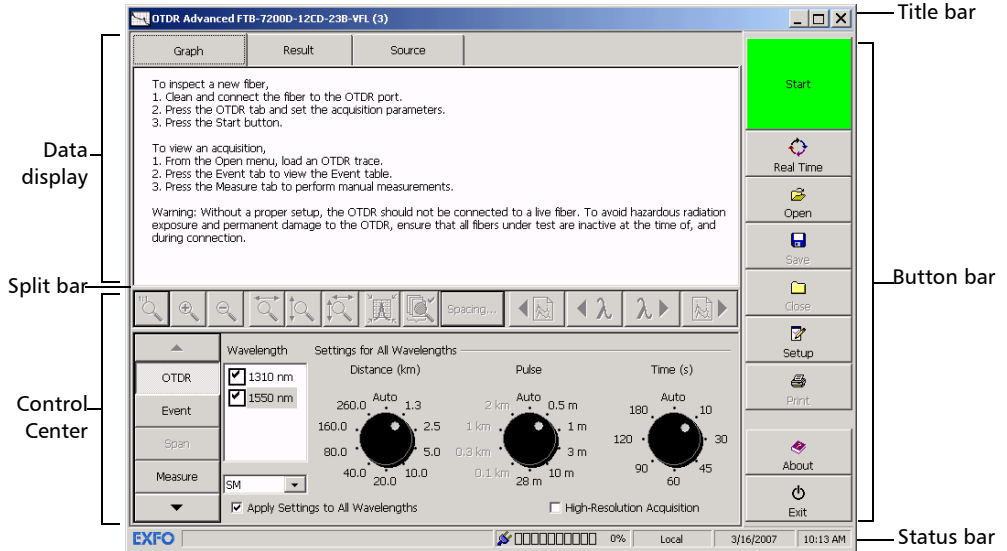

The main window will differ from the illustration above if you opened traces the last time you worked with the OTDR.

Split Bar

A split bar divides the data display and Control Center. You can drag it up or down to obtain a larger view of the graph or table display.

Getting Started with Your OTDR

Starting the OTDR Application

Title Bar

The title bar is located at the top of the main window. It displays the module name and its position in the FTB-400 Universal Test System. The module position is identified as follows:

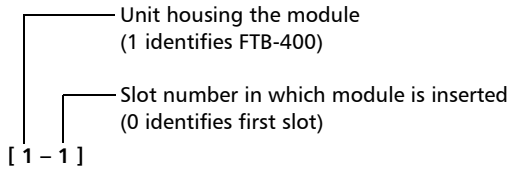

Note: On some 7-slot backplanes, slots are marked with a letter from A to G.

Status Bar

The status bar, located at the bottom of the main window, identifies the operational status of the FTB-7000 Series OTDR.

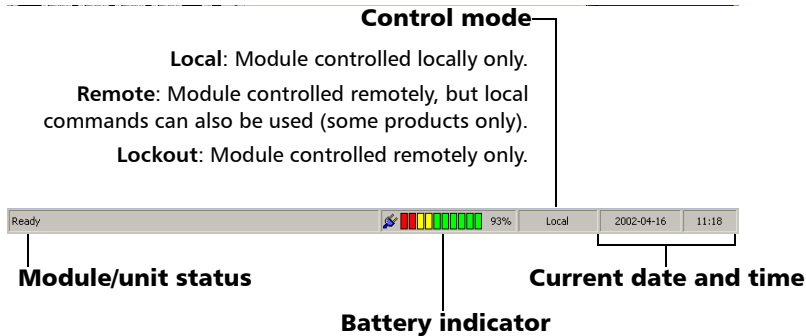

For more information about automating or remotely controlling the FTB-7000 Series OTDR, refer to your platform user guide.

Understanding the Timer

Once the acquisition has begun, a timer is displayed on the status bar, indicating the remaining time until the next acquisition.

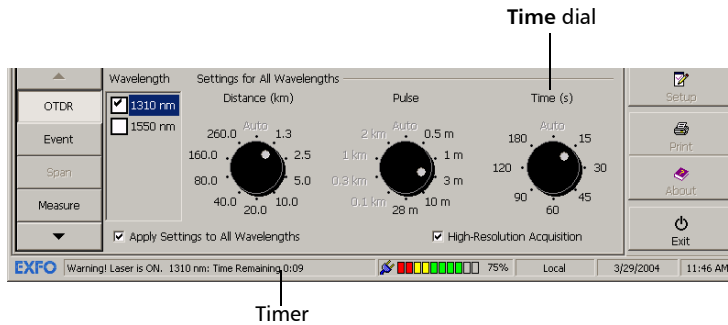

- If you increase the time on the **Time** dial during the acquisition, the timer will adjust the countdown accordingly.
- If you modify the value on the **Distance** or **Pulse** dial during the acquisition, the timer is reset.

Exiting the Application

Closing any application that is not currently being used helps freeing system memory.

To close the application from the main window:

Click  in the top right corner of the main window.

OR

Click the **Exit** button located at the bottom of the function bar.

4 *Setting Up Your OTDR*

Installing the EXFO Universal Interface (EUI)

The EUI fixed baseplate is available for connectors with angled (APC) or non-angled (UPC) polishing. A green border around the baseplate indicates that it is for APC-type connectors.

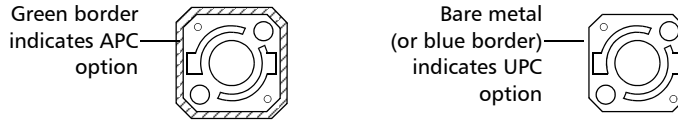

To install an EUI connector adapter onto the EUI baseplate:

1. Hold the EUI connector adapter so the dust cap opens downwards.

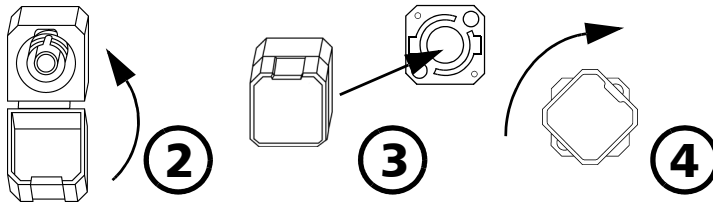

2. Close the dust cap in order to hold the connector adapter more firmly.
3. Insert the connector adapter into the baseplate.
4. While pushing firmly, turn the connector adapter clockwise on the baseplate to lock it in place.

Cleaning and Connecting Optical Fibers



IMPORTANT

To ensure maximum power and to avoid erroneous readings:

- Always inspect fiber ends and make sure that they are clean as explained below before inserting them into the port. EXFO is not responsible for damage or errors caused by bad fiber cleaning or handling.
- Ensure that your patchcord has appropriate connectors. Joining mismatched connectors will damage the ferrules.

To connect the fiber-optic cable to the port:

- 1.** Inspect the fiber using a fiber inspection microscope. If the fiber is clean, proceed to connecting it to the port. If the fiber is dirty, clean it as explained below.
- 2.** Clean the fiber ends as follows:
 - 2a.** Gently wipe the fiber end with a lint-free swab dipped in isopropyl alcohol.
 - 2b.** Use compressed air to dry completely.
 - 2c.** Visually inspect the fiber end to ensure its cleanliness.
- 3.** Carefully align the connector and port to prevent the fiber end from touching the outside of the port or rubbing against other surfaces.

If your connector features a key, ensure that it is fully fitted into the port's corresponding notch.
- 4.** Push the connector in so that the fiber-optic cable is firmly in place, thus ensuring adequate contact.

If your connector features a screwsleeve, tighten the connector enough to firmly maintain the fiber in place. Do not overtighten, as this will damage the fiber and the port.

Note: *If your fiber-optic cable is not properly aligned and/or connected, you will notice heavy loss and reflection.*

See also *Enabling or Disabling the First Connector Check* on page 54.

Defining Cables

You can specify the way cables and fibers will be identified and add comments about the tests you perform. You can include this information in reports later.

To speed up information entry, you can define cable profiles. For each new test, the application will use the active cable profile to fill out the boxes, preventing you from entering repetitive information.

After a trace acquisition, you can still change cable name, fiber and job information, as well as comments for a specific trace. For more information, see *Creating and Printing Trace Reports* on page 211.

You must be in Advanced mode to define cables.



IMPORTANT

The information you define in the Setup window will be used for future acquisitions. If you want to modify information before printing a report, see *Adding Information to the Test Results* on page 212.

Defining a Cable Name or Identifier

You can define a cable name or identifier for your cable. You can also modify existing names and delete them as needed.

To define the cable name or identifier:

1. From the main window, press **Setup**.
2. From the **Setup** dialog box, select the **Cable** tab.

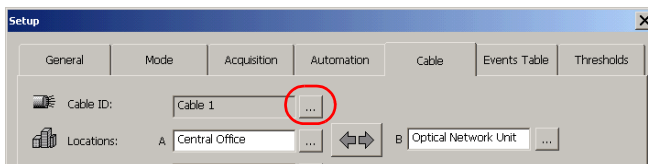

3. Press the **...** button next to the **Cable ID** box.
4. Select a name from the list, or type the desired name in the upper box.

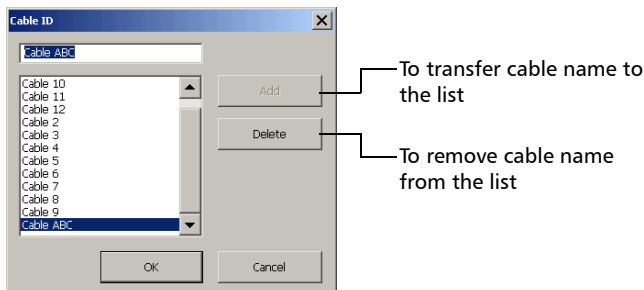

5. Press **OK**.

The selected name becomes the current cable name. If you selected a cable name whose location, subset and other fiber information have been defined, the other boxes will also be filled.

6. Press **Apply** to confirm the changes, then **OK** to return to the main window.

Setting Up Your OTDR

Defining Cables

Defining the Cable Location

You can specify where ends A and B of your cable are located. You can also swap A and B locations, which is useful when you perform bidirectional tests using the same hardware for both directions. You can modify already defined locations or delete them as needed.

To define the cable location:

1. From the main window, press **Setup**.
2. From the **Setup** dialog box, select the **Cable** tab.

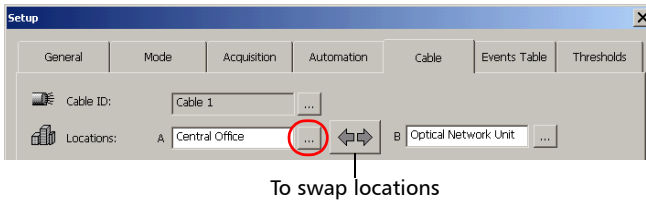

3. Enter the desired location:
 - 3a. From the appropriate **Locations** box (**A** or **B**), type the location directly.

OR

Press the  button next to the **A** (or **B**) box.
 - 3b. Select a location from the list, or type the name in the upper box.

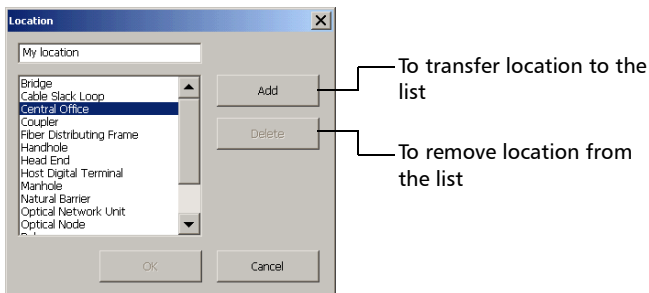

4. Press **OK** to confirm your selection.

The selected name becomes the current cable name.
5. Repeat the same procedure for **Location B**.
6. Press **Apply** to confirm the changes, then **OK** to return to the main window.

Setting Up Your OTDR

Defining Cables

Defining Subset (or Fiber) Names

You can define the way subsets, such as buffer tubes or fiber ribbons, will be identified. You can also define your own fiber name or identifier using the same method.

Each time you launch an acquisition, the subset and fiber names will change according to a pattern you will have previously defined. These names are made of a static part (alphanumeric) and a variable part (numeric). Variable part can be incremented or decremented according to your specifications, as follows:

If you select...	with incrementation	with decrementation
Continuous numbering	Variable part increases until it reaches the <i>highest possible value</i> with the selected number of digits (for example, 99 for 2 digits), then restarts at 1.	Variable part decreases until it reaches 1, then restarts at the <i>highest possible value</i> with the selected number of digits (for example, 99 for 2 digits).
Numbering by subset (by groups of 4, 8, ...)	Variable part increases until it reaches the limit value you specify, then it will go back to 1. As a limit, you can choose from predefined values or specify your own. In the latter case, the value you can enter will depend on the number of digits you have specified. For example, if you select two digits, you can enter <i>any value</i> from 01 through 99, inclusively.	Variable part decreases from the specified limit to 1, then it will go back to the specified limit value.

You can also deactivate the incrementation to re-use the same subset or fiber name.

Before incrementing the subset's variable part, the application must process all fibers in the subset.

Example:

- Subset 1 - Fiber 1
- Subset 1 - Fiber 2
- Subset 1 - Fiber...
- Subset 2 - Fiber 1
- ...

Note: *If you also want to identify your fiber with a color code, see Identifying Fibers with Colors on page 34.*

Setting Up Your OTDR

Defining Cables

To define the subset or fiber name:

1. From the main window, press **Setup**.
2. From the **Setup** dialog box, select the **Cable** tab.

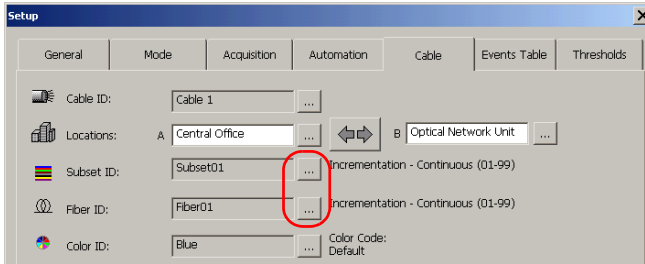

3. Press the  button next to the **Subset ID** box, then select the **Use Subset** box.

OR

Press the  button next to the **Fiber ID** box.

4. Set the various parameters according to your needs.

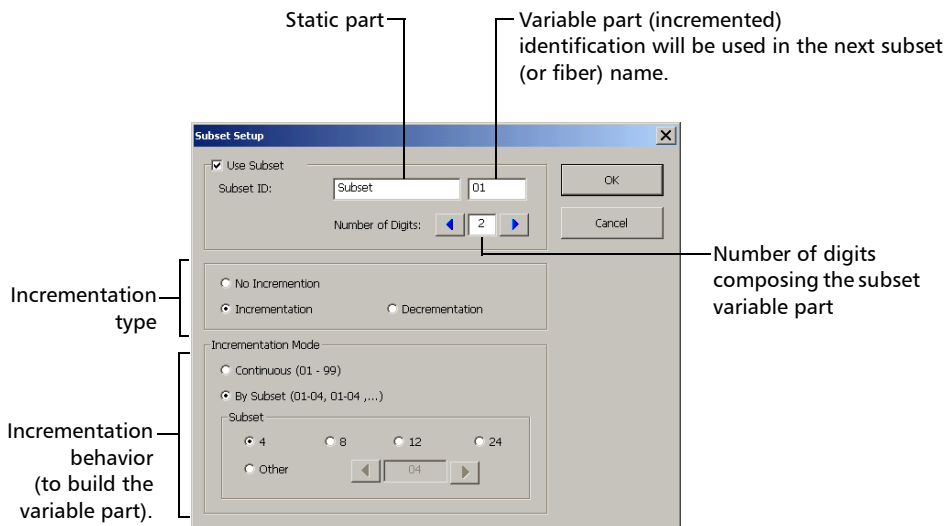

Ensure that the value composing the variable part corresponds to the number that should appear in the next subset or fiber name.

5. Press **OK** to confirm your selection.



IMPORTANT

The incrementation of the subset name will only work if you also configure the incrementation of the fiber name.

6. Press **Apply** to confirm the changes, then **OK** to return to the main window.

Setting Up Your OTDR

Defining Cables

Identifying Fibers with Colors

In addition to defining a custom name for your fibers, you can also add a color, based on the default ITU color code or on your own color codes.

A color code consists of a set of colors identified by a name and an abbreviation. For each color code, the application displays a color table showing the full and abbreviated color names as well as a number indicating the sequential order of these colors in the code.

You can modify existing color codes or delete them as needed. It is also possible to export color codes to later import them on other FTB-400 Universal Test Systems or computers instead of having to create the same color codes several times. You can also use the export function as a backup for your color codes.

To define the color code:

1. From the main window, press **Setup**.
2. From the **Setup** dialog box, select the **Cable** tab.

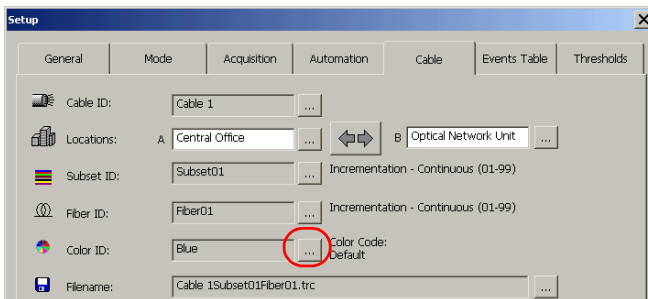

3. Press the  button next to the **Color ID** box.
4. From the **Color Code In Use** list, select a color code.

OR

Select **None** if you prefer not to use color information.

For information on how to create your own color codes, see the corresponding procedure on page 42.

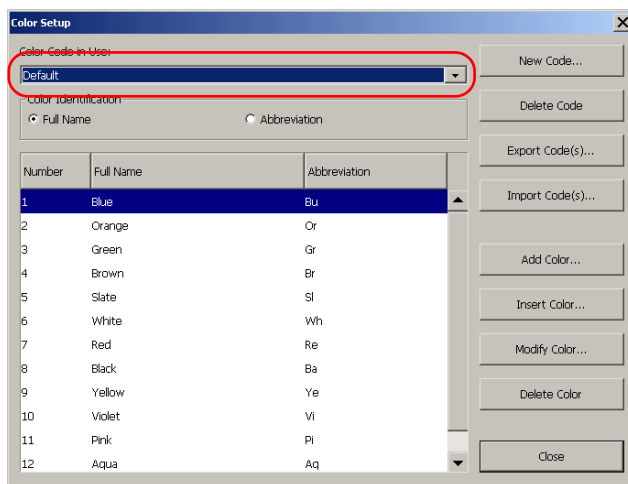

5. Under **Color Identification**, select your preference between the **Full Name** of the color, or its **Abbreviation**.
6. Press **OK** to confirm.

The color name will appear in subsequent trace names, after the fiber number, and in sequential order, according to the color code you have chosen.

Setting Up Your OTDR

Defining Cables

To create a custom color code:

1. From the main window, press **Setup**.
2. From the **Setup** dialog box, select the **Cable** tab.

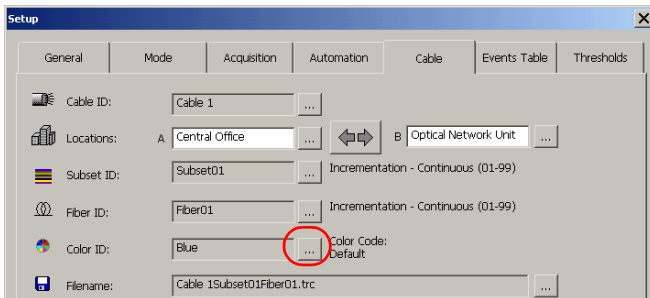

3. Press the **...** button next to the **Color ID** box.
4. From the **Color Setup** dialog box, press **New Code**.
5. In the **Color Name** field, enter a color name.

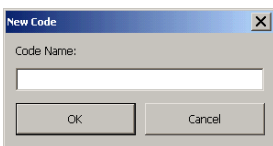

6. Press **OK**.

You return to the **Color Setup** dialog box.

The added color code is displayed in the **Color Code in Use** list. The color table is empty. You must add color names to the new color code. For more information on color creation, see the corresponding procedure on page 42.

To delete a color code:

- 1.** From the **Color Setup** dialog box, in the **Color Code in Use** list, select the color code to delete.
- 2.** Press **Delete Code**.
- 3.** In the confirmation dialog box, press **Yes**.
You return to the **Color Setup** dialog box.

Setting Up Your OTDR

Defining Cables

To export color codes:

1. From the **Color Setup** dialog box, press **Export Code(s)**.

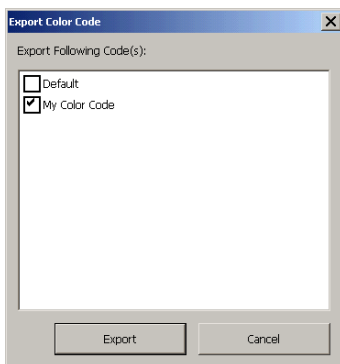

2. From the **Export Following Code(s)** list, select the all the boxes corresponding to the color codes to export in the .clr file.
3. Press **Export**.

4. If necessary, from the list of drives and folders, select a storage location.

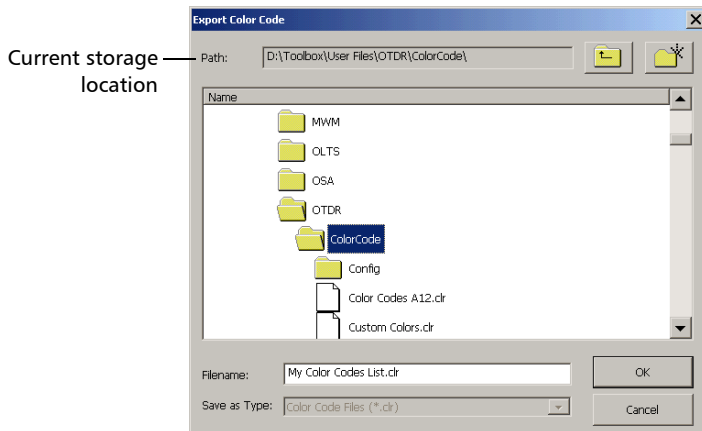

5. In the **Filename** box, enter the name you want to use for the file that will contain all the exported color codes.
6. Press **OK**.
7. Press **OK** one more time to acknowledge the confirmation message.

You return to the **Color Setup** dialog box.

Note: By default, exported color code lists are saved in the **ColorCode** folder. The factory default storage path is

D:\ToolBox\User Files\OTDR\ColorCode.

Setting Up Your OTDR

Defining Cables

To import color codes:

1. From the unit/computer on which you want to import color codes, open the **Color Setup** dialog box and press **Import Code(s)**.
2. In the **Import Color Code** dialog box, select the .clr file (containing the list of color codes) you want to import.

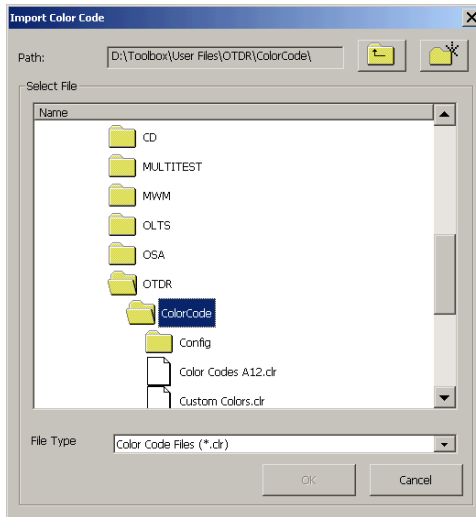

3. Press **OK**.

Note: By default, this dialog box opens in the **ColorCode** folder.

The factory default path is

D:\ToolBox\User Files\OTDR\ColorCode. However, you can import color code lists from the folder of your choice.

4. From the **Import Color Code** dialog box, in the **Code(s) to Import** list, select the boxes corresponding to the desired color codes.

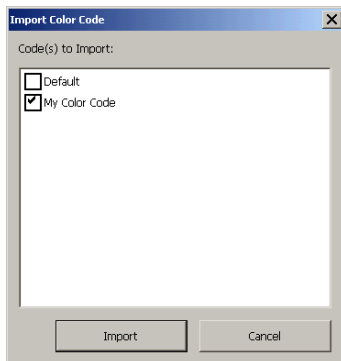

5. Press **Import**.
6. Press **OK** to acknowledge the confirmation message.

You return to the **Color Setup** dialog box.

Note: *To use one of the newly imported color codes, you must select it manually.*

Setting Up Your OTDR

Defining Cables

To add a color to a code:

1. From the **Color Setup** dialog box, in the **Color Code in Use** list, select the color code to which you want to add a color, and press **Add Color**.
2. From the **New Color** dialog box, enter the desired information.

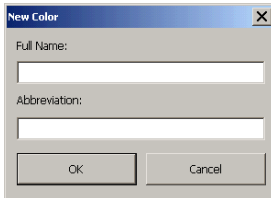

3. Press **OK**.

You return to the **Color Setup** dialog box.

The added color is displayed as the last item in the color table.

Note: To insert a new color between existing colors, use the *Insert Color* function described below.

To insert a color into a code:

1. From the **Color Setup** dialog box, in the **Color Code in Use** list, select the color code in which you want to insert a color.
2. Select the color *following* the location where you want to insert the new color and press **Insert Color**.
3. From the **New Color** dialog box, enter the desired information.
4. Press **OK**.

You return to the **Color Setup** dialog box.

The added color is displayed before the item you selected in the color table.

To modify a color name:

- 1.** From the **Color Setup** dialog box, in the **Color Code In Use** list, select the color code you want to modify.
- 2.** In the color table, select the color you want to modify, and press **Modify Color**.
- 3.** From the **Modify Color** dialog box, enter the desired information.
- 4.** Press **OK**.

You return to the **Color Setup** dialog box.

To delete a color:

- 1.** From the **Color Setup** dialog box, in the **Color Code In Use** list, select the color code you want to modify.
- 2.** In the color table, select the color you want to delete.
- 3.** Press **Delete Color**.
- 4.** Press **Yes** in the confirmation dialog box.

You return to the **Color Setup** dialog box.

Setting Up Your OTDR

Defining Cables

Entering Cable Manufacturer Information

You can enter information such as the manufacturer of the cable that houses the fiber being tested.

To enter cable manufacturer information:

1. From the main window, press **Setup**.
2. From the **Setup** dialog box, select the **Cable** tab.

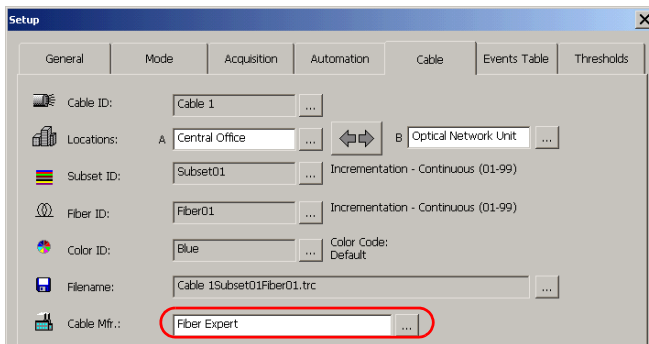

3. In the **Cable Mfr.** box, enter the desired information.
4. Press **Apply** to confirm the changes, then **OK** to return to the main window.

Entering Fiber Type Information

You can enter information such as the type of fiber being tested.

To enter fiber type information:

1. From the main window, press **Setup**.
2. From the **Setup** dialog box, select the **Cable** tab.

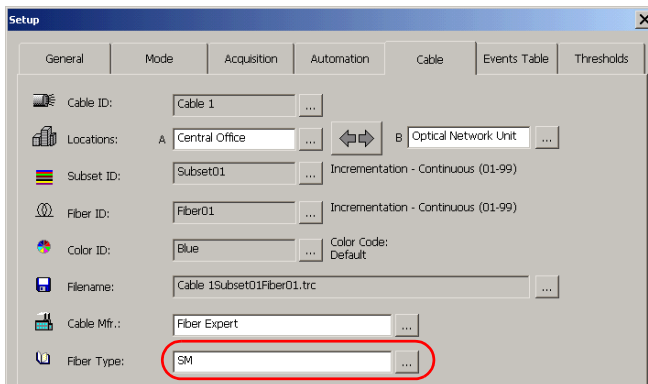

3. In the **Fiber Type** box, enter the desired information.
4. Press **Apply** to confirm the changes, then **OK** to return to the main window.

Setting Up Your OTDR

Defining Cables

Entering Job Information and Comments

You can enter job information such as the name of the job and other useful information that will be saved with all new traces.

To enter job information:

1. From the main window, press **Setup**.
2. From the **Setup** dialog box, select the **Cable** tab.

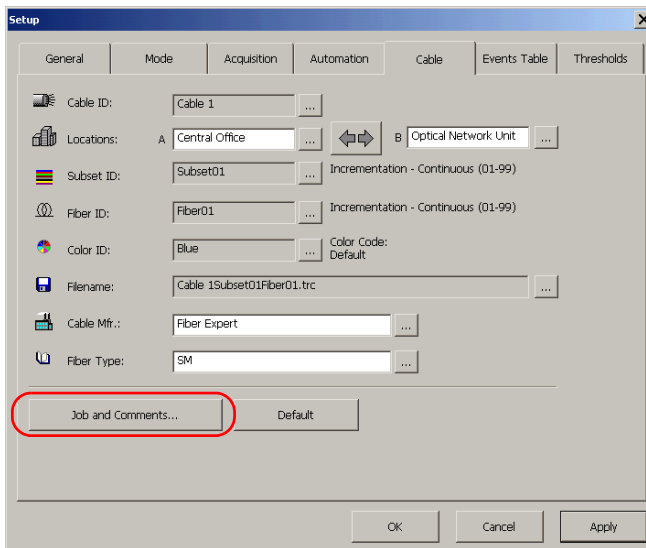

3. Press the **Job and Comments** button.

4. From the **Job and Comments** dialog box, enter information in the appropriate boxes.

You can use  to add those entries to a list; if you use them often, doing so will make them easier to recall.

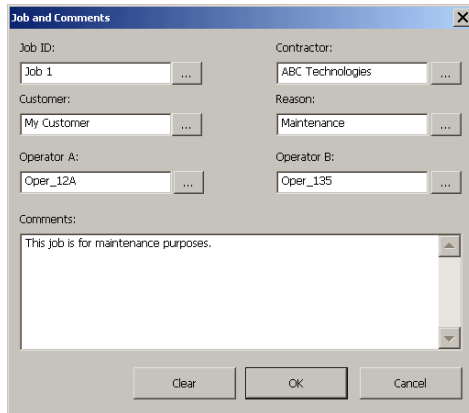

5. When all the information has been entered in the **Job and Comments** dialog box, press **Close** to save the information.
6. Press **Apply** to confirm the changes, then **OK** to return to the main window.

Note: *This information is automatically copied into the OTDR report of each acquisition made using this setup.*

Setting Up Your OTDR

Defining Cables

Reverting to Default Cable Parameters

You can clear the information appearing in the **Cable** tab and revert to default cable parameters.

To revert to default values:

1. From the main window, press **Setup**.
2. From the **Setup** dialog box, select the **Cable** tab.

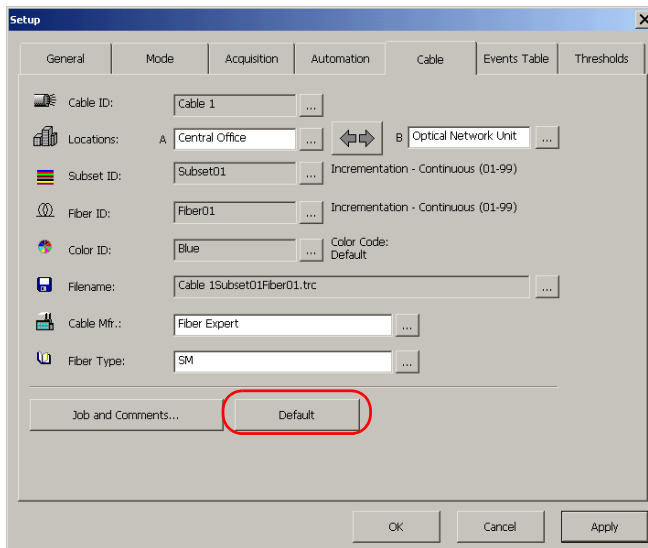

3. Press the **Default** button.
4. Press **Apply** to confirm the changes, then **OK** to return to the main window.

Naming Trace Files Automatically

Note: *The autonaming feature is not available in “offline” mode.*

When you activate the automatic file naming function, the application builds a file name according to your specifications each time you start an acquisition. You can specify the information you want to include in the file names and in which order each item should appear.

Note: *If you choose not to save a particular trace file, the suggested file name will remain available for the next trace you will acquire.*

By setting the default name and number of the first trace to be saved, all subsequent traces will be saved with the same name and incremental number structure.

This function is particularly useful when working in Template mode, when coupling a switch module with the OTDR, or when testing ribbon fibers.

If you deactivate the automatic file naming function, the application will prompt you to specify a file name. The default file name is *Unnamed.trc*.

You must be in Advanced mode to activate automatic file naming.

By default, traces are saved in native (.trc) format, but you can configure your unit to save them in other formats (see *Selecting the Default File Format* on page 111).

Setting Up Your OTDR

Naming Trace Files Automatically

To view the current file name structure:

From the main window, press **Setup**.

The current file naming scheme is displayed to the right of the **Filename** box.

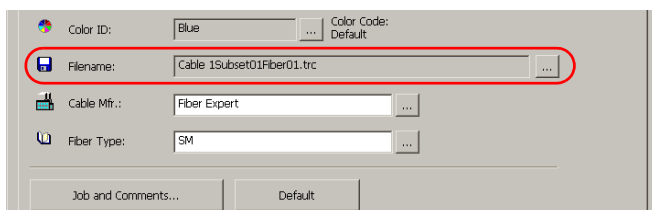

To configure the automatic file naming:

- 1.** From the button bar, press **Setup**.
- 2.** From the **Setup** dialog box, press the **Cable** tab.
- 3.** Press the  button appearing next to the **Filename** box to open the **File Autonaming** dialog box.

Setting Up Your OTDR

Naming Trace Files Automatically

4. Select the **Use File Autonaming** box to be able to set the file autonaming parameters.

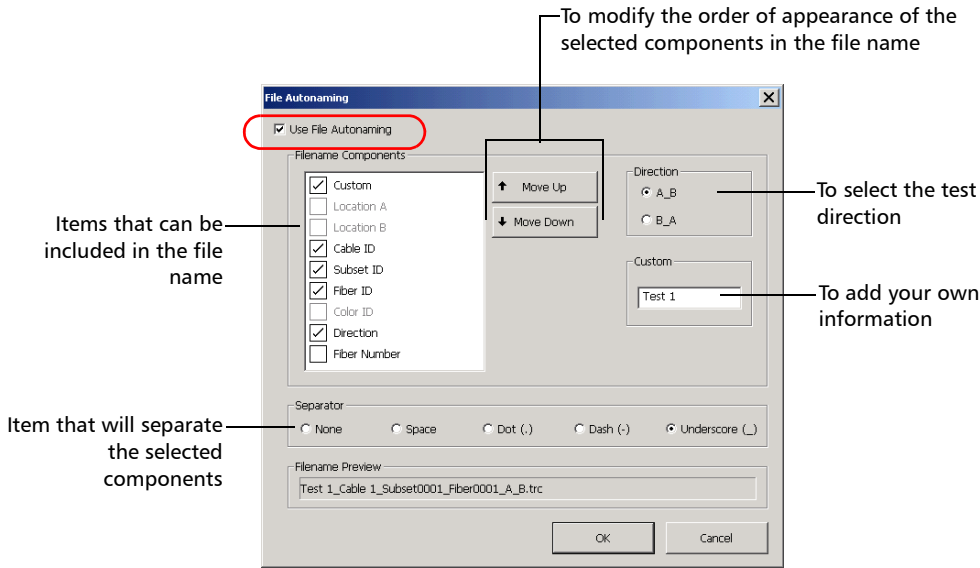

- Under **Filename Components**, select the boxes corresponding to the information you wish to include in your file names.

Note: Only the items corresponding to the components that have been defined in the **Cable** tab are available to include in the file names.

Note: If you want to include information about the test direction (A ->B or B -> A), or define your own information, you must first select, respectively, the **Direction** or **Custom** box.

- You can include information about the test direction by selecting the desired option.
- You can also add a static name that will always appear in the file name by entering it in the **Custom** box.

The items will appear in the same order they are listed (from top to bottom). The first selected item will become the first item in the file name, the second selected item will become the second item in the file name, etc.

5. If desired, modify the order of appearance of the items as follows:
 - 5a. Highlight the item you want to move.
 - 5b. Use the **Move Up** or **Move Down** button to rearrange the list.
6. Press **OK** to confirm your new settings.

Setting Up Your OTDR

Enabling or Disabling the First Connector Check

Enabling or Disabling the First Connector Check

The first connector check feature is used to verify that the fibers are properly connected to the OTDR. It verifies the injection level and displays a message when an unusually high loss occurs at the first connection, which could indicate that no fiber is connected to the OTDR port. By default, this feature is not enabled.

Note: *The first connector check is only performed when you test at singlemode wavelengths.*

When you use a switch in conjunction with your OTDR, the first connector check will verify all selected channels before starting the acquisition sequence. For more information on selecting channels, see *Setting Optical Switch Parameters* on page 90.

To enable or disable the first connector check:

- 1.** From the main window, press **Setup** then press the **Acquisition** tab.

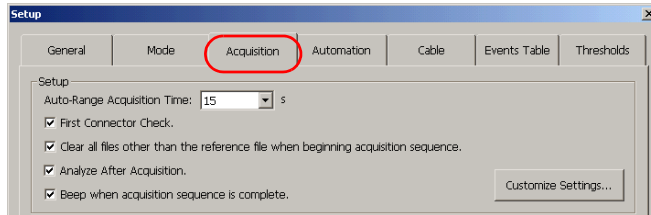

- 2.** To enable the first connector check, select the **First Connector Check** box.

OR

To disable it, clear the box.

Launch Conditions for Multimode Measurements

In a multimode fiber network, the attenuation of a signal is highly dependent on the mode distribution (or launch condition) of the source that emits this signal.

In the same way, the attenuation reading performed by any test instrument will also depend on the mode distribution of its light source.

A single light source cannot be conditioned for both 50 μm (50 MMF) and 62.5 μm (62.5 MMF) fibers at the same time:

- A source conditioned for 50 MMF testing will be under-filled for 62.5 MMF testing.
- A source conditioned for 62.5 MMF will be overfilled for 50 MMF testing.

TIA/EIA-455-34A (FOTP34, Method A2) is providing a target launch condition that is obtained when using an overfilled source followed by mandrel-wrap mode filter (five close-wound turns around a mandrel tool of a given diameter).

Your product has been conditioned for 62.5 MMF testing. However, you can also test with 50 MMF fibers.

The table below gives information about tests with the 50 μm and 62.5 μm fibers.

Fiber type	Recommended mode filter	Remarks
50 μm	<p>Perform a five-turn mandrel-wrap (wrapping the patchcord a minimum of five turns around the mandrel tool) on the patchcord connecting the OTDR to the fiber under test.</p> <p>As per FOTP-34:</p> <ul style="list-style-type: none"> ▶ For fibers with 3 mm jacket: use a mandrel tool with a diameter of 25 mm. ▶ For fibers without jacket: use a mandrel tool with a diameter of 22 mm. 	<p>Nominal launch conditions are overfilled.</p> <p>Loss measurements can be slightly pessimistic (higher loss) when compared to loss measurements done with a 50 MMF source compliant to FOTP34, Method A2.</p>
62.5 μm	No mode filter required.	Loss measurements similar to those obtained with a power meter and a source that is conditioned according to FOTP34, Method A2.



IMPORTANT

If you test with 50 μm fibers, EXFO recommends that you use a mode filter (mandrel-wrap). Otherwise, you may obtain results with a 0.1 to 0.3 dB excess loss.

5 **Testing Fibers in Auto Mode**

Auto mode automatically evaluates fiber length, sets acquisition parameters, acquires traces, and displays event tables and acquired traces.

You can select an option that will allow you to modify fiber settings (IOR also known as group index, RBS coefficient, and helix factor) or analysis detection thresholds (splice loss, reflectance, and end-of-fiber detection) once the test is complete. For more information, see *Viewing and Modifying Current Trace Settings* on page 155.

You can also configure the application so that it will always start in Auto mode directly.

In Auto mode, you can only set the following parameters directly:

- Test wavelengths (all selected by default)
- Fiber type (singlemode, singlemode live, or multimode) for models supporting these fiber types

For all other parameters, the application uses those defined in Advanced mode, except that analysis is always performed after acquisitions.

If you ever need to modify other parameters, go to Advanced mode (see *Testing Fibers in Advanced Mode* on page 65 and *Setting Up Your OTDR* on page 23).

In Auto mode, the application will automatically evaluate the best settings according to the fiber link currently connected to the unit (in less than 5 seconds). If you interrupt it, no data will be displayed.

Fiber characteristics are evaluated only once per session. Other fibers you connect to, within the same cable, will be tested with the same settings. When you start testing another link, you can reset these parameters.

Once this evaluation is complete, the application starts acquiring the trace. The trace display is continually updated.

Note: *You can interrupt the acquisition at any time. The application will display the information acquired to that point.*

Testing Fibers in Auto Mode

Once the acquisition is complete or interrupted, the analysis starts for acquisitions of 5 seconds or more.

After analysis, the trace is displayed and events appear in the events table. For more information, see *Analyzing Traces and Events* on page 131.

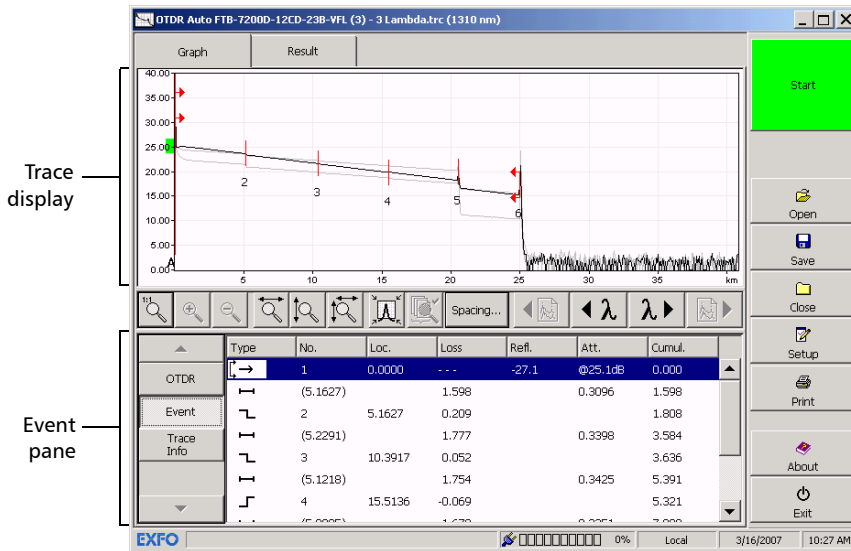

The application will also display status messages if you have selected to display pass/fail messages (see *Enabling or Disabling Analysis After Acquisition* on page 79 and *Displaying or Hiding Pass/Fail Messages* on page 116).

You can save the trace after analysis. If former results have not been saved yet, the application prompts you to save them before starting a new acquisition.

To acquire traces in Auto mode:

1. Clean the connectors properly (see *Cleaning and Connecting Optical Fibers* on page 24).
2. Connect a fiber to the OTDR port.

If your unit is equipped with two OTDR ports, ensure that you connect the fiber to the appropriate port (singlemode, singlemode live, or multimode), depending on the wavelength you intend to use.



CAUTION

Never connect a live fiber to the OTDR port without a proper setup. Any incoming optical power ranging from -65 dBm to -40 dBm will affect the OTDR acquisition. The way the acquisition will be affected depends on the selected pulse width.

Any incoming signal greater than -20 dBm could damage your OTDR permanently. For live-fiber testing, refer to the SM Live port specifications for the characteristics of the built-in filter.

3. Before activating the Auto mode, set the autorange acquisition time (see *Setting the Autorange Acquisition Time* on page 70).

Testing Fibers in Auto Mode

4. Select the Auto mode.
 - 4a. From the main window, press **Setup** then select the **Mode** tab.

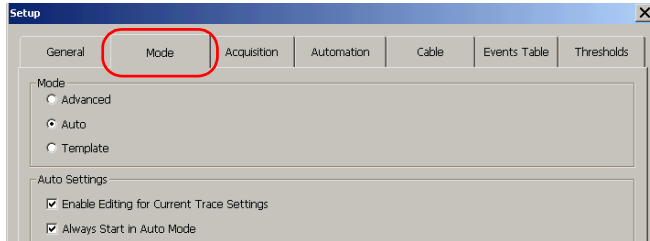

- 4b. Under **Mode**, select **Auto**.
 - If you want to edit fiber settings after the test, select the **Enable Editing for Current Trace Settings** box. Clear the box if you prefer not to edit the settings.
 - If you always want to start in Auto mode, select the corresponding box. Clear the box if you prefer to select the test mode yourself.
 - 4c. Press **Apply** to confirm, then **OK** to return to the main window.

5. Go to the **OTDR** pane.
6. If your OTDR supports singlemode, singlemode live, or multimode wavelengths, under **Wavelengths**, from the list, select the desired fiber type (for live-fiber testing, select SM Live; for C fiber, select 50 μm and for D fiber, select 62.5 μm).

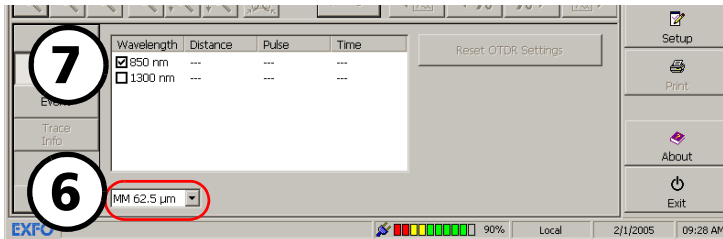

7. Select the boxes corresponding to the desired test wavelengths. You must select at least one wavelength.

8. If you want to clear the settings the OTDR has determined to start with a new set of OTDR settings, press **Reset OTDR Settings**.

9. Press **Start**.

If the first connector check feature is enabled, a message will appear if there is a problem with the injection level (see *Enabling or Disabling the First Connector Check* on page 54).

10. Once the analysis is complete, save the trace by pressing **Save** in the button bar.

If you have activated the autonaming feature, the application will use a file name based on the autonaming parameters you defined (see *Naming Trace Files Automatically* on page 49).

6 **Testing Fibers in Advanced Mode**

Advanced mode offers all the tools you need to perform complete OTDR tests and measurements manually and gives you control over all test parameters.

Note: *Most parameters can only be set if you select Advanced mode first. Once you have finished selecting your settings, you can simply return to the test mode you prefer.*

By default, in Advanced mode, all available test wavelengths are selected.

In this mode, you can either set the acquisition parameters yourself or let the application determine the most appropriate values.

In the latter case, the application will automatically evaluate the best settings according to the fiber link currently connected to the unit:

- The pulse width will be determined using a factory-defined signal-to-noise ratio (SNR) requirement specified where the End-of-Fiber (EoF) event has been detected.

The EoF event detection algorithm uses the end-of-fiber threshold defined in the **Acquisition** tab of the application setup (for more information, see *Setting the Analysis Detection Thresholds* on page 170). If you are not sure about which value to choose, revert to the factory default value for this parameter.

- The range will then be set automatically. This optimum value may differ from the values currently associated with the **Distance** dial of the main window. In this case, the application will “add” the required value and mark it with a * symbol.
- The application uses the acquisition time defined in the **Acquisition** tab of the application setup (for more information, see *Setting the Autorange Acquisition Time* on page 70). The default value is 15 seconds. Longer acquisitions give better OTDR results.

Testing Fibers in Advanced Mode

Although the application sets the acquisition parameters, you can modify these values as needed, even while the acquisition is in progress. The OTDR simply restarts the averaging each time a modification is made.

Note: You can interrupt the acquisition at any time. The application will display the information acquired to that point.

Once the acquisition is complete or interrupted, the analysis starts for acquisitions of 5 seconds or more.

After analysis, the trace is displayed and events appear in the events table. For more information, see *Analyzing Traces and Events* on page 131.

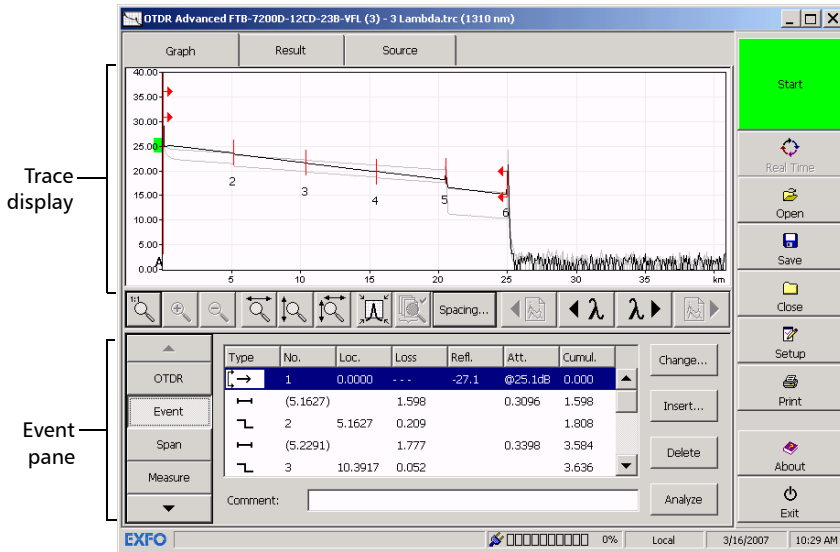

The application will also display pass/fail messages if you have selected this feature. For more information, see *Enabling or Disabling Analysis After Acquisition* on page 79 and *Displaying or Hiding Pass/Fail Messages* on page 116.

You can save the trace after analysis. If former results have not been saved yet, the application prompts you to save them before starting a new acquisition.

To acquire traces:

1. Clean the connectors properly (see *Cleaning and Connecting Optical Fibers* on page 24).
2. Connect a fiber to the OTDR port.

If your unit is equipped with two OTDR ports, ensure that you connect the fiber to the appropriate port (singlemode, singlemode live, or multimode), depending on the wavelength you intend to use.



CAUTION

Never connect a live fiber to the OTDR port without a proper setup. Any incoming optical power ranging from -65 dBm to -40 dBm will affect the OTDR acquisition. The way the acquisition will be affected depends on the selected pulse width. Any incoming signal greater than -20 dBm could damage your OTDR permanently. For live-fiber testing, refer to the SM Live port specifications for the characteristics of the built-in filter.

Testing Fibers in Advanced Mode

3. Select Advanced mode.
 - 3a. From the main window, press **Setup** then select the **Mode** tab.

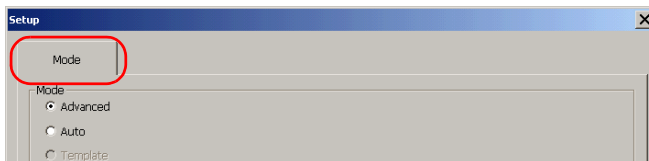

- 3b. Under **Mode**, select **Advanced**.



IMPORTANT

Press **Apply** to ensure the Advanced mode is activated. Otherwise, the tabs containing the parameters you can set will remain hidden.

- 3c. Press **Apply**, then **OK**.
4. If you want the application to provide automatic acquisition values, set the autorange acquisition time (see *Setting the Autorange Acquisition Time* on page 70).
5. If you want to set your own IOR (group index), RBS coefficient or helix factor, see *Setting the IOR, RBS Coefficient, and Helix Factor* on page 71.
6. Go to the **OTDR** pane.
7. If you want to test in high resolution, simply select the feature (see *Enabling the High-Resolution Feature* on page 77).

8. If your OTDR supports singlemode, singlemode live, or multimode wavelengths, under **Wavelengths**, from the list, select the desired fiber type (for live-fiber testing, select SM Live; for C fiber, select 50 μm and for D fiber, select 62.5 μm).

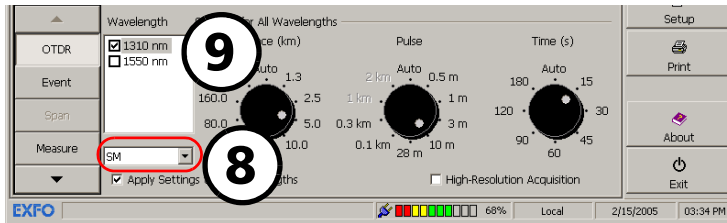

9. Select the boxes corresponding to the desired test wavelengths. You must select at least one wavelength.
10. Select the desired distance, pulse, and time values. For more information, see *Setting Distance Range, Pulse Width, and Acquisition Time* on page 74.
11. Press **Start**. If the first connector check feature is enabled, a message will appear if there is a problem with the injection level (see *Enabling or Disabling the First Connector Check* on page 54).

You can modify the acquisition parameters as needed, while the acquisition is in progress. The OTDR simply restarts the averaging each time a modification is made.

12. Once the analysis is complete, save the trace by pressing **Save** in the button bar.

If you have activated the autonaming feature, the application will use a file name based on the autonaming parameters you defined (see *Naming Trace Files Automatically* on page 49).

Testing Fibers in Advanced Mode

Setting the Autorange Acquisition Time

Setting the Autorange Acquisition Time

When performing automatic acquisitions in Advanced mode (see *Testing Fibers in Advanced Mode* on page 65) or before activating Auto mode (see *Testing Fibers in Auto Mode* on page 59), you can set an autorange acquisition time for the OTDR to average acquisitions over a set time period.

The application uses this value to determine the best settings for the test.

Note: *In Template mode, the acquisition time of the reference trace is used for all trace acquisitions, not the autorange acquisition time.*

To set the autorange acquisition time:

1. From the main window, press **Setup** then go to the **Acquisition** tab.

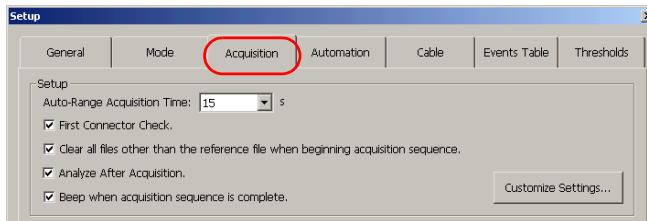

2. Go to the **Auto-Range Acquisition Time** box and press the arrow to scroll down the list and select your preference. The default value is 15 seconds.
3. Press **Apply** to confirm the changes, then **OK** to return to the OTDR application.

Setting the IOR, RBS Coefficient, and Helix Factor

You should set the IOR (group index), RBS coefficient and helix factor before performing tests in order to apply them to all newly acquired traces. However, you can also set them at a later time in the **Trace Info** pane to reanalyze a specific trace (see *Viewing and Modifying Current Trace Settings* on page 155).

Note: *In Auto mode, you can change the IOR (group index), RBS coefficient and helix factor parameters after an acquisition only if you have activated the **Enable Current Trace Settings Editing** function (see *Testing Fibers in Auto Mode* on page 59). You can always view these parameters for a specific trace by selecting the **Trace Info** pane.*

Testing Fibers in Advanced Mode

Setting the IOR, RBS Coefficient, and Helix Factor

- The index of refraction (IOR) value (also known as group index) is used to convert time-of-flight to distance. Having the proper IOR is crucial for all OTDR measurements associated with distance (event position, attenuation, section length, total length, etc.). IOR is provided by the cable or fiber manufacturer.

The test application determines a default value for each wavelength. You can set the IOR value for each available wavelength. You should verify this information before each test.

- The Rayleigh backscatter (RBS) coefficient represents the amount of backscatter in a particular fiber. The RBS coefficient is used in the calculation of event loss and reflectance, and it can usually be obtained from the cable manufacturer.

The test application determines a default value for each wavelength. You can set the RBS coefficient for each available wavelength.

- The helix factor takes into consideration the difference between the length of the cable and the length of the fiber inside the cable. Fibers within a cable are spiraling around the cable core. The helix factor describes the pitch of that spiral.

By setting the helix factor, the length of the OTDR distance axis is always equivalent to the physical length of the cable (not the fiber).

To set the IOR, RBS, and helix factor parameters:

1. From the main window, press the **Setup** button.
2. From the **Setup** window, go to the **Acquisition** tab.
3. Under **Fiber Settings**, from the **Wavelength(s)** list, select the wavelength you want to use to set IOR and RBS.

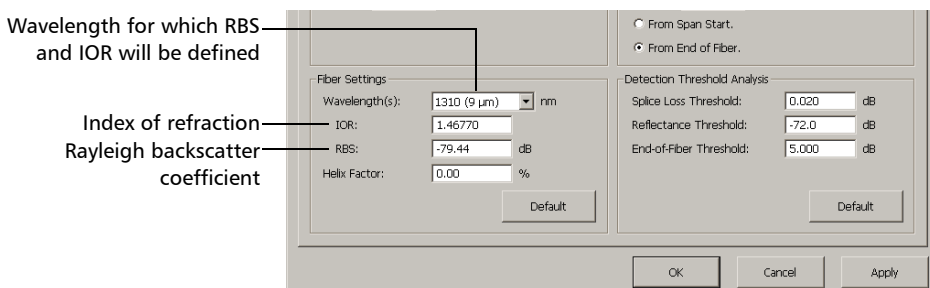

IMPORTANT

Change the default RBS coefficient *only* if you have values provided by the fiber manufacturer. If you set this parameter incorrectly, your reflectance measurements will be inaccurate.

4. Select the default settings by pressing **Default**. When the application prompts you, answer **Yes** only if you want to apply the new settings to all wavelengths.

OR

Enter your own values in the boxes, for each available wavelength.

Note: You cannot define a different helix factor for each wavelength. This value takes into account the difference between the length of the cable and the length of the fiber inside the cable; it does not vary with wavelengths.

5. Press **Apply** to confirm the changes, then **OK** to return to the main window.

Setting Distance Range, Pulse Width, and Acquisition Time

The distance range, pulse width and acquisition time are set with the controls in the Advanced main window.

- **Distance:** corresponds to the distance range of the fiber span to be tested according to the selected measurement units (see *Selecting the Distance Units* on page 118).

Changing the distance range alters the available settings of the pulse width and leaves only the settings available for the specified range. You can select either Auto or one of the predefined values.

If your OTDR model is FTB-7000D or later, you can customize the available distance range values (see *Customizing the Acquisition Distance Range Values* on page 120). If you select Auto, the application will evaluate the fiber length and set the acquisition parameters accordingly.

- **Pulse:** corresponds to the pulse width for the test. A longer pulse allows you to probe further along the fiber, but results in less resolution. A shorter pulse width provides higher resolution, but less distance range. The available distance ranges and pulse widths depend on your OTDR model.

Note: *Not all pulse widths are compatible with all distance ranges.*

You can select either Auto or one of the predefined values.

If you select Auto, the application will evaluate the fiber type and length and set the acquisition parameters accordingly.

Testing Fibers in Advanced Mode

Setting Distance Range, Pulse Width, and Acquisition Time

- **Time:** corresponds to the acquisition duration (period during which results will be averaged). Generally, longer acquisition times generate cleaner traces (this is especially true with long-distance traces) because as the acquisition time increases, more of the noise is averaged out. This averaging increases the signal-to-noise ratio (SNR) and the OTDR's ability to detect small events.

You can select either Auto or one of the displayed values.

If the predefined values do not suit your needs, you can customize one or all of them. For more information, see *Customizing the Acquisition Time Values* on page 122.

If you select Auto, the application will use the autorange acquisition time that you have previously defined (see *Setting the Autorange Acquisition Time* on page 70). It will also evaluate the fiber type and length, and set the acquisition parameters accordingly.

You can use the same distance range, pulse width and acquisition time parameters for testing at all wavelengths on a multiwavelength OTDR.



IMPORTANT

To test using the high-resolution feature, the acquisition time must be of at least 15 seconds.

Testing Fibers in Advanced Mode

Setting Distance Range, Pulse Width, and Acquisition Time

To set the parameters:

From the **OTDR** pane,

- Press the dial corresponding to the parameter you wish to set (the selection marker will move clockwise) or use the selection dial located on the front of the FTB-400 Universal Test System.

OR

- Press directly the value to select it. The selection marker will go to that value immediately.

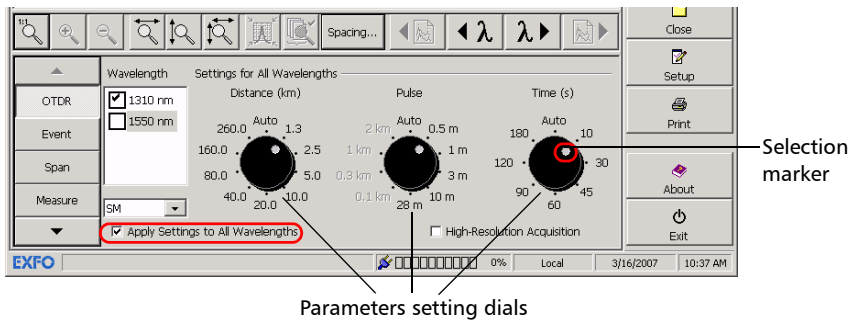

If you want the application to provide automatic acquisition values, move at least one dial to the **Auto** position. The other dials are automatically set accordingly.

If you want to use the same values for all wavelengths of a module, select the **Apply Settings to All Wavelengths** box.

Note: *If your OTDR supports singlemode, singlemode live, or multimode wavelengths, settings would be applied to either singlemode, singlemode live, or multimode wavelengths, depending on the selected fiber type (same settings for 50 μm and 62.5 μm).*

Enabling the High-Resolution Feature

If your OTDR model is FTB-7000D or later, you can select the high-resolution feature to obtain more data points per acquisition. This way, the data points will be closer to each other, which will result in a greater distance resolution for the trace.

Note: *When you test with the high-resolution feature, you should use a longer averaging time to maintain a signal-to-noise ratio (SNR) that will be equivalent to the one you would have got with the standard resolution.*

Note: *You can use high resolution with any test mode (except when you monitor fiber in real time), but you must be in Advanced mode to select it. In Template mode, you will have to acquire the reference trace using high resolution. This way, all subsequent acquisitions will use this feature automatically.*

Testing Fibers in Advanced Mode

Enabling the High-Resolution Feature



IMPORTANT

To test using the high-resolution feature, the acquisition time must be of at least 15 seconds.

To enable the high-resolution feature:

From the main window, select the **OTDR** pane. Select the **High-Resolution Acquisition** box.

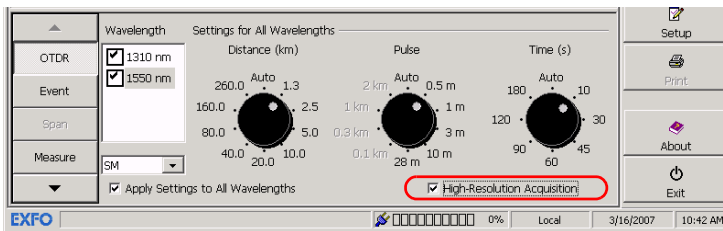

Note: If your OTDR supports singlemode, singlemode live, or multimode wavelengths, the high-resolution feature will be activated either for the singlemode, singlemode live, or multimode wavelengths, depending on the selected fiber type.

Enabling or Disabling Analysis After Acquisition

The OTDR trace acquisition procedure will be completed by the analysis. You can either choose to automatically analyze each trace immediately after the acquisition, or perform the analysis whenever it suits you best.

When the analysis process is disabled, the Event table of a newly acquired trace will be empty. To generate the Event table, see *Analyzing or Reanalyzing a Trace* on page 173).

Note: *In Auto mode, the application always performs an analysis after the acquisition.*

To enable or disable the analysis after trace acquisition:

1. From the main window, press **Setup**.
2. Go to the **Acquisition** tab.
3. If you want the OTDR to automatically analyze an acquired trace, select the **Analyze After Acquisition** box.

If you clear the check box, the trace will be acquired without being analyzed.

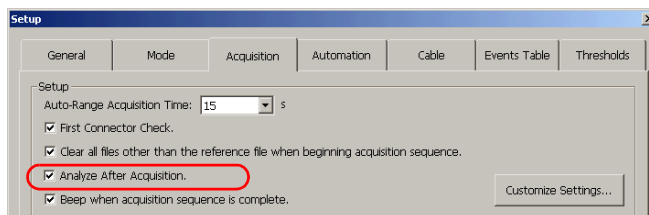

4. Press **Apply** to confirm and **OK** to return to the main window.

Setting Pass/Fail Thresholds

Your OTDR allows you to activate and set Pass/Fail threshold parameters for your tests.

You can set thresholds for splice loss, connector loss, reflectance, fiber section attenuation, span loss, span length, and span ORL. You can apply the same pass/fail thresholds to all test wavelengths or apply them separately to each one.

You can set different pass/fail thresholds for each available test wavelength. These pass/fail thresholds will be applied to the analysis results of all newly acquired traces with the corresponding wavelength.

The following table provides the default, minimum and maximum thresholds.

Test	Default	Minimum	Maximum
Splice loss (dB)	0.500	0.015	5.000
Connector loss (dB)	1.000	0.015	5.000
Reflectance (dB)	-40.00	-80.00	0.00
Fiber section attenuation (dB/km)	0.40	0.00	5.000
Span loss (dB)	45.000	0.000	45.000
Span length (km)	0.00	0.0000	300.0000
Span ORL (dB)	15.00	15.00	40.000

Once the thresholds are set, the application will be able to perform Pass/Fail tests to determine the status of the various events (pass, warning, fail).

The Pass/Fail test is performed on two occasions:

- when analyzing or reanalyzing a trace
- when you open a trace file

By default, when the thresholds are set, the application displays symbols in the **Result** tab to identify the events' status. Values that are greater than the predefined fail thresholds are displayed in white on a red background in the events table. Values that are greater than the predefined warning thresholds are displayed in black on a yellow background.

You can also set the application to display pass/fail messages when the Pass/Fail test is performed (see *Displaying or Hiding Pass/Fail Messages* on page 116).

4. Select the wavelength to which you want to apply the thresholds:
 - To apply the same pass/fail thresholds setup to trace acquisitions performed at all wavelengths, press the **Apply Settings to All Wavelengths** button.

OR

 - To specify a specific wavelength for which to set pass/fail thresholds, select the desired wavelength from the **Wavelengths** box and press **Apply** to confirm your changes.

Note: *If you want to define thresholds for specific wavelengths, repeat steps 3 to 4 for each wavelength.*

5. Press **Apply** to confirm the changes, then **OK** to return to the main window.

Testing Fibers in Advanced Mode

Setting Pass/Fail Thresholds

To view event status:

1. From the main window, go to the **Result** tab. The events' status, at each wavelength, is indicated by a symbol.

The screenshot shows the OTDR Advanced software interface. The 'Result' tab is active, displaying a table of test results. The table has columns for Filename, Status, Avg. loss, Span loss, Avg. splice, Max. splice, and Span length. The status column uses symbols: a green circle for 'Pass', a yellow circle with an exclamation mark for 'Warning', and a red circle with an exclamation mark for 'Fail'. The row for '1310 nm' is highlighted in blue, and the 'Status Details...' button is circled in red.

Filename	Status	Avg. loss	Span loss	Avg. splice	Max. splice	Span length
<input checked="" type="checkbox"/> 1310 nm	Pass (green)	0.401 dB/km	10.028 dB	0.064 dB	0.209 dB	24.9912 km
<input checked="" type="checkbox"/> 1550 nm	Warning (yellow)	0.369 dB/km	9.217 dB	0.099 dB	0.348 dB	24.9980 km
<input checked="" type="checkbox"/> 1625 nm	Fail (red)	0.494 dB/km	12.357 dB	0.267 dB	0.522 dB	25.0031 km
<input checked="" type="checkbox"/> D:\ToolBox\User Files\OTDR\Continuous Fiber.trc						
<input checked="" type="checkbox"/> 1310 nm	Pass (green)	0.365 dB/km	3.724 dB	---	---	10.2153 km
<input checked="" type="checkbox"/> D:\ToolBox\User Files\OTDR\Dual.trc						
<input checked="" type="checkbox"/> 1310 nm	Fail (red)	0.397 dB/km	19.030 dB	0.480 dB	0.831 dB	47.9321 km
<input checked="" type="checkbox"/> 1550 nm	Fail (red)	0.349 dB/km	16.739 dB	1.296 dB	2.394 dB	47.9096 km

File: Move Up, Move Down, Set as Reference, Status Details..., Save As...
Trace: Set as Current Trace, Report/Documentation...

EXFO 0% Local 3/16/2007 12:53 PM

2. If you need more information about particular event status, select the fiber for which you want more information (the row should be highlighted) and press **Status Details**.

Setting a Default Span Start and Span End

By default, the span start and span end of a fiber are assigned, respectively, to the first event (the launch level event) and the last event (often a non-reflective or reflective end event) of a trace.

You can change the default fiber span that will be applied during the initial trace analysis.

You can even define a fiber span for short fibers by placing the span start and the span end on the same event.

Changes to the span start and span end will modify the contents of the events table. The span start becomes event 1 and its distance reference becomes 0. Only events between the span start and span end will be numbered in the trace display and Event table. The cumulative loss is calculated within the defined fiber span only.

Note: *You can also change the span start and span end of a specific trace without changing the default span start or span end (see Analyzing the Fiber on a Specific Fiber Span on page 175).*

To keep the defined fiber span during trace reanalysis, activate the fiber span delimitation memory (for details, see Saving the Span-Start and Span-End Information on page 87); otherwise, the span start and span end markers are reset to zero in the process.

Testing Fibers in Advanced Mode

Setting a Default Span Start and Span End

To change the default span start and span end for traces:

1. From the main window, press **Setup**.
2. From the **Setup** window, go to the **Acquisition** tab.
3. Under **Span Start** and **Span End**, go to the **Position** box and enter the desired value, using the distance units displayed to the right of the field. to the **Position** box and enter the desired value, using the distance units displayed to the right of the field.

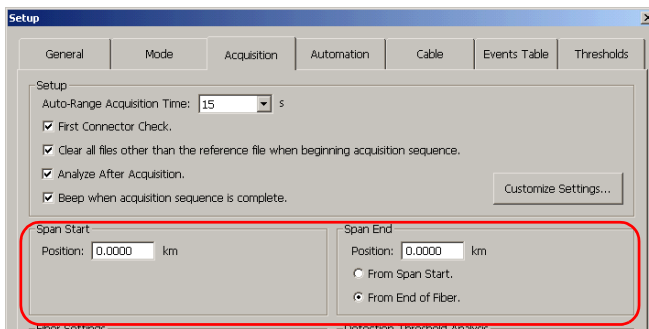

Under **Span End**, indicate whether the span end position is from the fiber span start or from the end of the fiber.

If you have loaded several traces with different fiber spans, the traces will be aligned from their span starts.

Saving the Span-Start and Span-End Information

Saving the modified span-start and span-end information allows you to reapply the current span start and span end of a trace when you reanalyze, instead of applying the default fiber span originally used for the acquisition.

For details on setting a default span start and end for trace acquisitions, see *Setting a Default Span Start and Span End* on page 85.

To save the span-start and/or span-end information or to deactivate the feature:

1. From the main window, press the **Setup** button.
2. Go to the **Events Table** tab.
3. Select the **Span Start Memory** and/or the **Span End Memory** boxes.

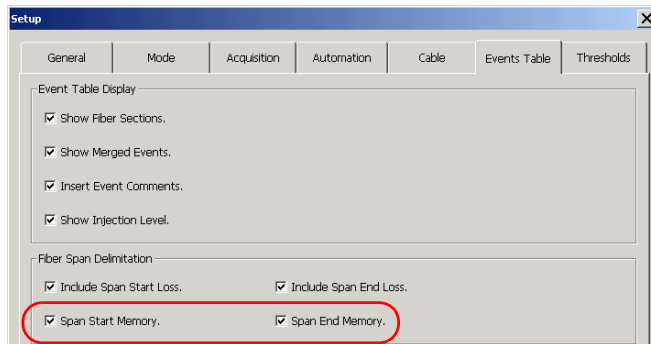

Note: *If you prefer not to save the values, simply clear the **Span Start Memory** and/or the **Span End Memory** boxes.*

4. Press **Apply** to confirm the changes, then **OK** to return to the main window.

Selecting the Operation Mode

There are two operation modes available:

- **Manual** mode is available only when you work with a switch. It is used to acquire traces one at a time. Before each acquisition, you must select the desired channel from the list of channels you had previously configured.
- **Auto** mode is available with or without a switch to perform a sequence of acquisitions:
 - Once
 - Indefinitely (until you stop the test manually)
 - A specified number of times, at certain intervals

If you choose to repeat the sequence, you must specify a time gap to set the interval for repeating the sequence. If the time gap is shorter than the time required to complete a sequence, there will be no pause between repetitions.

To select the operation mode:

1. From the main window, press **Setup**.
2. From the Setup window, go to the **Automation** tab.
3. Under **Operation Mode**, select the desired mode.

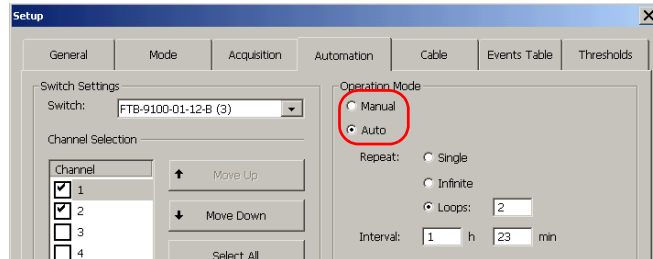

If you have chosen **Auto** mode,

- If you only want one sequence, select **Single**.
- If you want to repeat the sequences until you press **Stop**, select **Infinite**.

From the **Interval** section, in the **h** box, enter the number of hours between the sequences. In the **m** box, enter the number of minutes.

- If you want to specify the number of times the sequence will be performed, select **Loop**.

From the **Interval** section, in the **h** box, enter the number of hours between the sequences. In the **m** box, enter the number of minutes.

Setting Optical Switch Parameters

You can configure your switch to use any combination of channels in the desired order (e.g., channel 2, then 4, then 1 will be tested). It is always possible to reset the order to the default value (channel 1, then 2, then 3, and so on). You can test with a switch in Advanced mode only.



IMPORTANT

The application can only use switches whose type matches the fiber type (singlemode or multimode). To test both singlemode and multimode fibers, you will need two different switches.



IMPORTANT

To avoid heavy losses in multimode testing, the switch must also match the core of the fiber under test (50 μm or 62.5 μm).

To set the channel configuration:

1. From the main window, press **Setup**.
2. From the Setup window, go to the **Automation** tab.
3. From the **Switch** box, select the desired switch (press the arrow next to the box to view the available switches).

Note: *If you no longer want to use a switch in your test, simply select **None**.*

- From the **Channel Selection** section, select the boxes corresponding to the channels you want to use and clear the boxes of those you do not want to use.

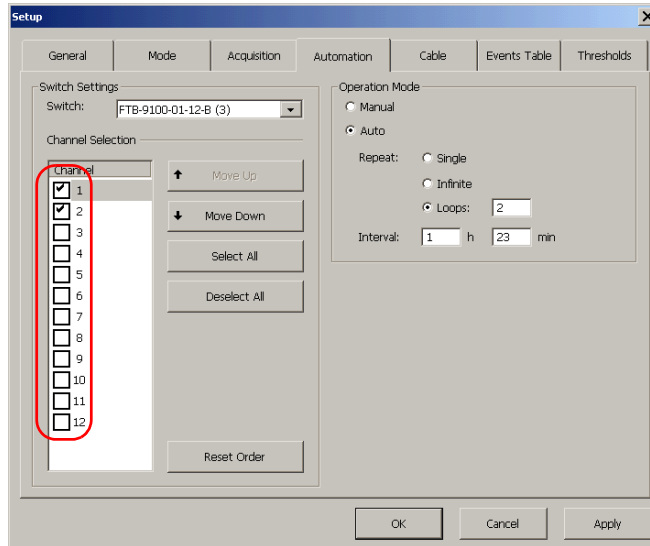

Note: You can quickly select/deselect channels by using the **Select All** and **Deselect All** buttons.

- If necessary, rearrange the order of the channels.
 - From the list of channel, select a channel to move.
 - Use the **Move Up** and/or **Move Down** buttons to modify the order.
- If necessary, adjust the operation mode. For more information, see *Selecting the Operation Mode* on page 88.
- Press **Apply** to confirm your changes and **OK** to return to the main window.

Testing Fibers in Advanced Mode

Retesting Channels

Retesting Channels

At the end of an acquisition sequence, you can view the test results (see *Viewing Test Results* on page 138). It is possible to retest all the fibers with a specific status (pass, warning or fail) or a single fiber at a specific wavelength.

Note: *You can only retest fibers in Advanced mode, just after the test is complete.*



IMPORTANT

If you have configured the application to automatically close all files except the reference file (see *Analyzing or Reanalyzing a Trace* on page 173), only the channels being retested will remain on the screen.

If you want to view all results, deactivate the automatic file-closing feature.

To retest fibers:

1. From the main window, go to the **Result** tab. If you want to retest a specific fiber at a specific wavelength, ensure that the row containing the desired wavelength is highlighted.

2. Press the **Retest Channels** button.

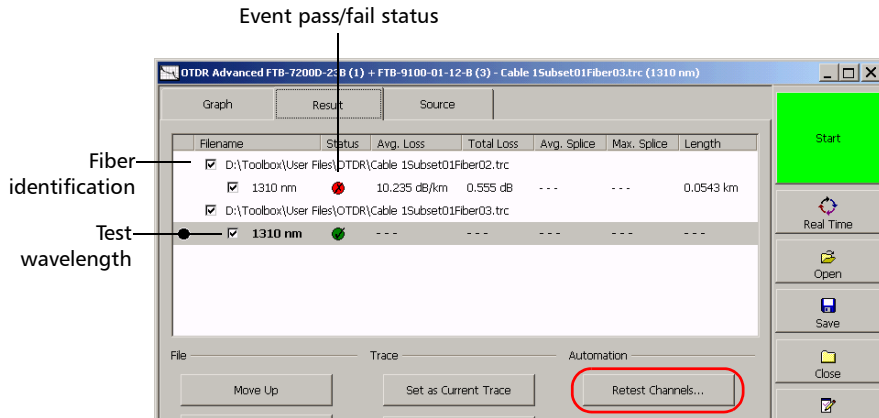

3. Specify which channels must be retested.

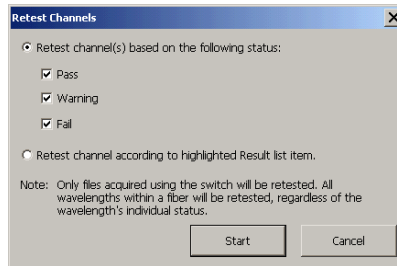

- If you want to retest fibers according to their status, select **Retest channel(s) based on the following status** then select all the boxes corresponding to the desired status.

OR

- If you want to retest a specific fiber, select **Retest channel(s) according to selected/highlighted Result list item**.

From the dialog box, press **Start**. After your confirmation, all traces corresponding to your criteria are automatically retested.

Testing Fibers in Advanced Mode

Monitoring Fiber in Real-Time Mode

Monitoring Fiber in Real-Time Mode

The application allows you to immediately view sudden changes in the fiber link. In this mode, the trace is refreshed instead of averaged until you stop the Real Time mode (to change settings before launching the test) or launch an acquisition with the current settings.

Note: You can only use one wavelength at a time to monitor your fiber.

You can switch from real-time mode to the averaging time interval mode at any time. However, once an acquisition is launched, you cannot switch back to real mode. You have to stop the acquisition or wait until the test is complete.

To activate the real-time mode:

1. If your module supports singlemode, singlemode live, or multimode wavelengths, specify the desired fiber type (for live-fiber testing, select SM Live; for C fiber, select 50 μm and for D fiber, select 62.5 μm).

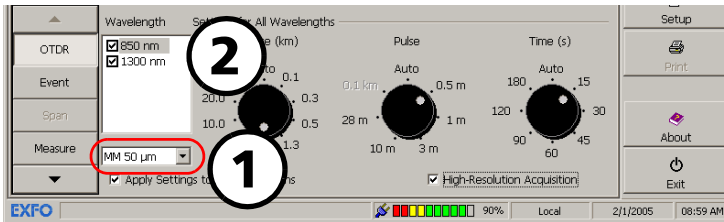

2. From the **Wavelength** list, ensure that the desired wavelength is *highlighted*.
3. From the button bar, select **Real Time**.

To deactivate the real-time mode:

- If you only want to stop monitoring, press **Stop Real Time**.
- If you are ready to launch a test, press **Start**. All the wavelengths for which boxes are selected will be tested (not only the highlighted one).

7 **Testing Fibers in Template Mode**

Template mode allows you to test fibers and compare them to a reference trace that was previously acquired and analyzed.

Template Principle

Cables contain numerous fibers. Theoretically, on all these fibers, you will find the same events at the same location (due to connectors, splices, etc.). Template mode allows you to test these fibers one after the other quickly and efficiently and ensures that no event remains undetected.

The Template mode concept is to acquire a reference trace (template), add comments about the events as well as information and comments on the current job, then save the trace.

For a more accurate reference trace, you can update it with new events that may occur during the first acquisitions (the number depends on how many reference acquisitions you wish to perform).

When events are added to the reference trace, the application automatically updates previous traces. For example, if an event occurred on the sixth acquisition, the application would update traces 1 through 5. The test application will flag possible problems and discrepancies between the reference trace and other traces.

Each new acquisition will be compared to the reference trace and the software will mark and measure any missing event.

Comments for events in the reference trace, as well as the reference trace report, are automatically copied to subsequent traces.

You can save the trace after analysis. If former results have not been saved yet, the application prompts you to save them before starting a new acquisition.

Template mode can be used on an unlimited number of traces, as long as you have at least one reference trace. Thus, you can use Template mode to automate trace acquisition or documentation tasks at the office.

Restrictions of Template Mode

To speed up trace acquisition in Template mode, certain restrictions apply.

- You cannot edit traces manually in this mode.
- You should enter event comments and fill out the reference trace report beforehand. However, you can add comments and report information to the reference trace until you start acquiring or recall traces.
- The parameters used to acquire the reference trace are automatically applied when acquiring subsequent traces (including the high-resolution feature, when applicable).
- The OTDR that you intend to use must support at least one wavelength that was used to acquire the reference trace.
- The reference trace and subsequent traces (or recalled traces) must respect the following criteria:

Testing Fibers in Template Mode

Restrictions of Template Mode

Item	To be valid...
Pulse width	<p>➤ Must be:</p> $\left(\frac{\text{Reference trace pulse}}{4} \right) \leq \text{Current trace pulse}$ <p>OR</p> $\text{Current trace pulse} \leq (\text{Reference trace pulse} \times 4)$
Pulse width	<p>➤ This would also be valid:</p> $\left(\frac{\text{Current trace pulse}}{4} \right) \leq \text{Reference trace pulse}$ <p>OR</p> $\text{Reference trace pulse} \leq (\text{Current trace pulse} \times 4)$
Fiber types	<p>➤ Compare singlemode traces with singlemode traces.</p> <p>➤ Compare multimode traces with multimode traces.</p>
Number of events	Traces must have at least two events (span start and span end) and a fiber section.
Acquisition mode	Reference trace must not be acquired in Real mode (see <i>Monitoring Fiber in Real-Time Mode</i> on page 94).
Wavelengths	Reference wavelengths and wavelengths of subsequent (or reloaded) traces must be identical.

Processing Traces

In Template mode, you can process traces:

- directly from the OTDR application (with an OTDR)
- on an FTB-400 without an OTDR or on a computer where ToolBox is installed. For more information, refer to the *FTB-400 Universal Test System* user guide.

Operations performed with a module are described in detail in the following sections. At the end of each section, a note will indicate how to achieve the same results on a computer.

When you process traces using an OTDR, you acquire the traces as you go along. When you process traces on a computer, you use traces stored on disk; therefore, applying the span length is optional.

Acquiring the Reference Trace

You must acquire a reference trace *before* you activate the Template mode. The acquisition parameters you define for this reference trace will be used to acquire subsequent traces.

To acquire the reference trace:

1. Clean the connectors properly (see *Cleaning and Connecting Optical Fibers* on page 24).
2. Connect a fiber to the OTDR port.

If your unit is equipped with two OTDR ports, ensure that you connect the fiber to the appropriate port (singlemode, singlemode live, or multimode), depending on the wavelength you intend to use.



CAUTION

Never connect a live fiber to the OTDR port without a proper setup. Any incoming optical power ranging from -65 dBm to -40 dBm will affect the OTDR acquisition. The way the acquisition will be affected depends on the selected pulse width. Any incoming signal greater than -20 dBm could damage your OTDR permanently. For live-fiber testing, refer to the SM Live port specifications for the characteristics of the built-in filter.

3. Acquire a trace in Auto or Advanced test mode. If you want to test using high resolution, you will have to select this feature *before* acquiring the reference trace. For more information, see *Testing Fibers in Auto Mode* on page 59 or *Testing Fibers in Advanced Mode* on page 65.

Testing Fibers in Template Mode

Acquiring the Reference Trace

4. If desired, add comments to specific events (for more information, see *Entering Comments* on page 182).
5. If desired, enter information and comments about the current job (for more information, see *Entering Job Information and Comments* on page 46).
6. Once the analysis is complete, save the trace by pressing **Save** in the button bar.

If you have activated the autonaming feature, the application will use a file name based on the autonaming parameters you defined (see *Naming Trace Files Automatically* on page 49).

Note: *The application will only display the **Save As** dialog box if you have activated the feature to always be prompted when you save a file. From this dialog box, you can change the location, the file name and the file format.*

Note: *For easier management, you can name the reference trace as the cable ID and set the autonaming function to include both the cable ID and fiber number (for more information, see *Naming Trace Files Automatically* on page 49).*

Acquiring Traces in Template Mode

To select Template mode, you must first open your reference trace (newly acquired and saved trace or open trace file) in the application. For details, see *Opening Trace Files* on page 183 and *Defining a Reference Trace* on page 187.

If you want your reference trace to be more accurate, you can update it with the new events that might be found.

You can also configure the application to automatically switch to Template mode once the reference update is complete, that is, after the number of acquisitions (or files to open) you specified is reached.

The application allows you to either:

- Consider only the events already indicated on the reference trace and ignore any other event occurring on the current trace.
- Keep all the events on the current trace, whether they are on the reference trace or not. You can delete these events later.

Note: *Once Template mode is selected, it is not possible to modify fiber or acquisition parameters.*

Testing Fibers in Template Mode

Acquiring Traces in Template Mode

To acquire traces in Template mode:

1. If necessary, clean the connectors (see *Cleaning and Connecting Optical Fibers* on page 24) and connect a fiber to the OTDR port.

If your unit is equipped with two OTDR ports, ensure that you connect the fiber to the appropriate port (singlemode, singlemode live, or multimode), depending on the wavelength you intend to use.



CAUTION

Never connect a live fiber to the OTDR port without a proper setup. Any incoming optical power ranging from -65 dBm to -40 dBm will affect the OTDR acquisition. The way the acquisition will be affected depends on the selected pulse width.

Any incoming signal greater than -20 dBm could damage your OTDR permanently. For live-fiber testing, refer to the SM Live port specifications for the characteristics of the built-in filter.

2. Ensure that you have acquired your reference trace, entered your comments, and created a report.

3. Select the Template mode.

3a. From the main window, press **Setup**, then select the **Mode** tab.

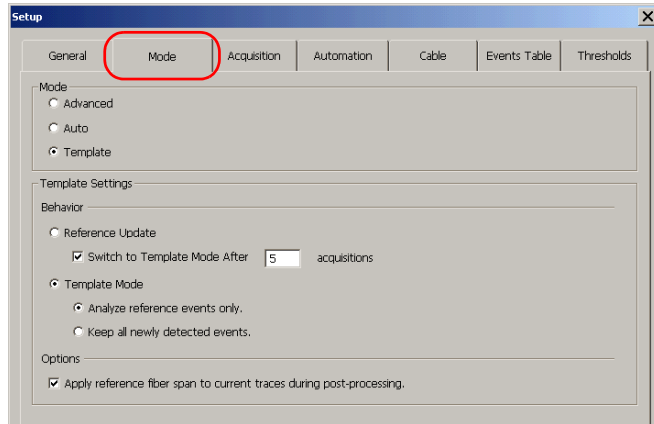

3b. Under **Mode**, select **Template**.

Testing Fibers in Template Mode

Acquiring Traces in Template Mode

- 3c.** If necessary, select **Reference Update** to update your reference trace for the next acquisitions.

If you want the application to automatically start Template mode after updating the reference trace, select the **Switch to Template Mode After** box and enter a number of acquisitions in the corresponding box.

If **Reference Update** mode is active, you will notice that the **Add to Ref.** and **Delete** buttons are available in the **Event** table pane of the main window.

- 3d.** Set the Template mode option you want to use on the current trace acquisition:

- Consider only the events already indicated on the reference trace and ignore any other event occurring on the current trace.
- Keep all the events on the current trace, whether they are on the reference trace or not. You can delete these events later.

- 3e.** If you want to automatically apply the fiber span defined in the template reference trace to all acquired traces, select the **Apply reference fiber span to current traces during post-processing** check box.

If you clear the box, the analysis will be performed on the common portion of the areas delimited by the span start and end of the reference trace and the span start and end of the main trace.

- 3f.** Press **Apply** to confirm, then **OK** to return to the main window.

Once Template mode is selected, the reference trace is displayed in red on the graph.

- 4.** If you selected **Reference Update** at step 3c, update your reference trace as follows:

4a. Press **Start**.

If the first connector check feature is enabled, a message will appear if there is a problem with the injection level (see *Enabling or Disabling the First Connector Check* on page 54).

All traces will automatically be acquired and analyzed, and the events will be identified.

Note: *In offline operation, instead of pressing **Start** to acquire traces, you simply recall traces stored on the hard disk of the FTB-400 Universal Test System.*

- 4b.** If applicable, the application will display the number of new events detected for each wavelength.

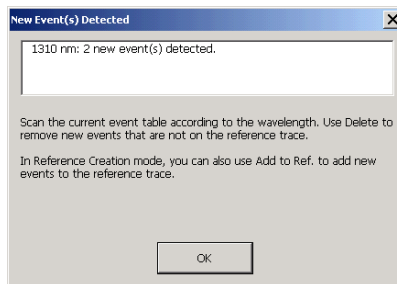

- 4c.** Press **OK** to close the dialog box.

Note: *You can only add events to the reference trace during reference update.*

Note: *If you chose the **Keep all newly detected events** feature for the acquisitions that will be performed after the update, you may find it useful to add newly detected events to obtain a more accurate reference trace.*

Testing Fibers in Template Mode

Acquiring Traces in Template Mode

- 4d.** Question marks will appear in the **Event** table to identify new events not found on the reference trace. If you want to add these marked events to the reference trace, press **Add to Ref.** You can also delete unwanted events with the **Delete** button.

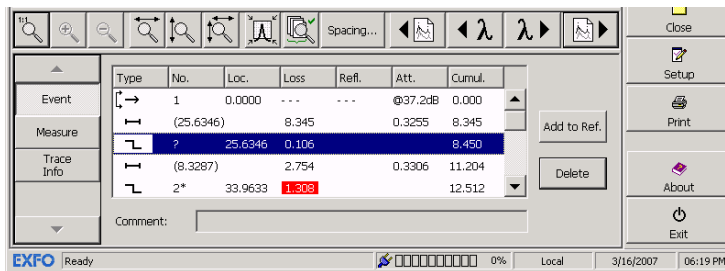

- Asterisks (“*”) identify events that were not found on the main trace, but that were added because they exist on the reference trace.
- Question marks identify events found on the main trace that do not exist on the reference trace. Numbers will be assigned to new events when the trace is analyzed.

Asterisks and question marks are used to identify events without modifying the existing event numbers. This way, you can match the events of the reference trace with those of the main trace more easily.

Note: If you selected the **Analyze reference events only** feature (from Setup), the **Add to Ref.** and **Delete** buttons do not appear. Events that are not on the reference trace, but that are detected on the acquired trace, are deleted.

- 4e.** Once the analysis is complete, save the trace by pressing **Save** in the button bar.

If you have activated the autonaming feature, the application will use a file name based on the autonaming parameters you defined (see *Naming Trace Files Automatically* on page 49).

Note: *The application will only display the **Save As** dialog box if you have activated the feature to always be prompted when you save a file. From this dialog box, you can change the location, the file name and the file format.*

- 4f.** Repeat steps 4a to 4e as necessary to update your reference trace.

Testing Fibers in Template Mode

Acquiring Traces in Template Mode

5. Once the reference update is complete (or if you did not select the reference update), the application automatically switches to Template mode. New events will be managed according to the option you selected at step 3d. Perform acquisitions in Template mode as follows:

5a. Press **Start**.

If the first connector check feature is enabled, a message will appear if there is a problem with the injection level (see *Enabling or Disabling the First Connector Check* on page 54).

All traces will automatically be acquired and analyzed, and the events will be identified.

- 5b.** The application will prompt you if new events are found.

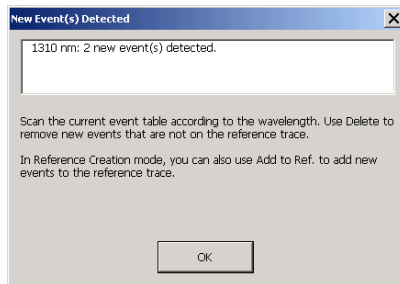

- 5c.** Once the analysis is complete, save the trace by pressing **Save** in the button bar.

The screenshot shows the EXFO software interface. The top part is a graph with 'Graph' and 'Result' tabs. The graph plots loss (y-axis, 0.00 to 45.00) against distance (x-axis, 0 to 100 km). A trace is shown with several events marked by red vertical lines and question marks. The events are labeled 1, 2*, 3, and 4. Below the graph is a toolbar with various icons and a 'Spacing...' button. Below the toolbar is a table with columns: Type, No., Loc., Loss, Refl., Att., and Cumul. The table has four rows: Event, Measure, Trace Info, and another Measure row. The 'Measure' row is highlighted in blue. Below the table is a 'Delete' button and a 'Comment:' field. On the right side of the interface is a vertical toolbar with buttons: Start (green), Real Time, Open, Save, Close, Setup, Print, About, and Exit. At the bottom of the interface is a status bar with 'EXFO Ready', a progress indicator, '0%', 'Local', '3/16/2007', and '06:24 PM'.

Type	No.	Loc.	Loss	Refl.	Att.	Cumul.
Event	1	0.0000	@37.2dB	0.000
Measure	(25.6346)		8.345		0.3255	8.345
Trace Info	?	25.6346	0.106			8.450
	(8.3287)		2.754		0.3306	11.204
	2*	33.9633	1.308			12.512

New event found

Event present on reference trace, but not found on current trace

If you have activated the autonaming feature, the application will use a file name based on the autonaming parameters you defined (see *Naming Trace Files Automatically* on page 49).

Note: The application will only display the **Save As** dialog box if you have activated the feature to always be prompted when you save a file. From this dialog box, you can change the location, the file name and the file format.

- 5d.** Repeat steps 3d to 5c as necessary.

8 Customizing the Application

You can customize the appearance and behavior of your OTDR application.

Selecting the Default File Format

You can define the default file format the application will use when you save your traces.

By default, traces are saved in native (.trc) format, but you can configure your unit to save them in other formats.

The available formats are the same as those presented in *Saving a Trace in a Different Format* on page 203.

If you select *ASCII* or *ASCII+* formats, file autonaming (see *Naming Trace Files Automatically* on page 49) will not work when you save your files. Since the application does not support these formats, it will always keep the same file name and consider that the trace has never been saved.

To select the default file format:

1. From the main window, press **Setup**, then select the **General** tab.
2. From the **Default Format for New File** box, select the desired format.

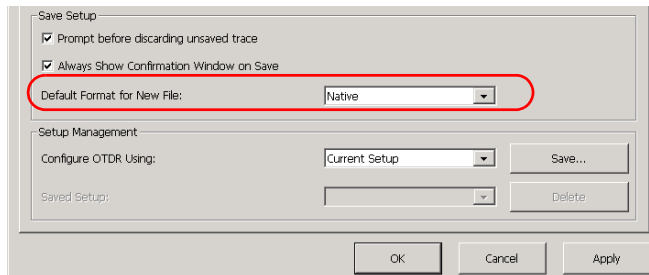

Press **Apply** to confirm the changes, then **OK** to return to the main window.

Enabling or Disabling File Name Confirmation

By default, each time you save a file, the application prompts you to confirm the file name.

If you disable the file name confirmation, the application will directly use a file name based on autonaming settings (see *Naming Trace Files Automatically* on page 49).

- If the autonaming feature is deactivated, the application will always use the same file name (default or last name used with the autonaming feature). The application will prompt you to save the file, to avoid replacing it accidentally.
- If the autonaming feature is activated, a new name will be automatically generated only if:
 - At least the fiber ID is set to incrementation (or decrementation). For more information, see *Defining Subset (or Fiber) Names* on page 30.
- AND
- The file name includes the fiber ID.

Otherwise, the application will behave exactly as if the autonaming feature was deactivated.

If you disable the file name confirmation, you will not be prompted at all when you save a file.

To enable or disable file name confirmation:

1. From the main window window, press **Setup**, then select the **General** tab.
2. If you want to confirm file name each time you press **Save**, select the **Always Show Confirmation Window on Save** check box.

OR

If you never want to be prompted, clear the check box.

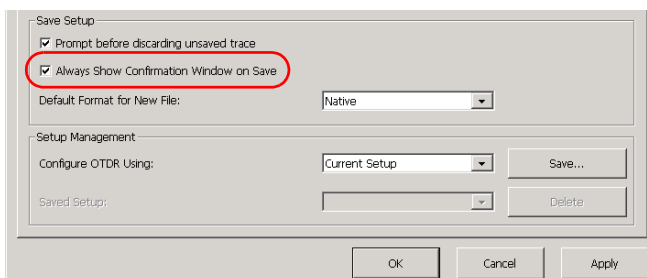

3. Press **Apply** to confirm the changes, then **OK** to return to the main window.

Customizing the Application

Enabling or Disabling Confirmation before Discarding Unnamed Trace

Enabling or Disabling Confirmation before Discarding Unnamed Trace

By default, each time you press the **Start** button when a trace has not been saved, the application prompts you to confirm if you want to save the trace or not.

If you disable the confirmation, the application will discard the unnamed trace directly.

To enable or disable confirmation:

1. From the main window, press **Setup**, then select the **General** tab.

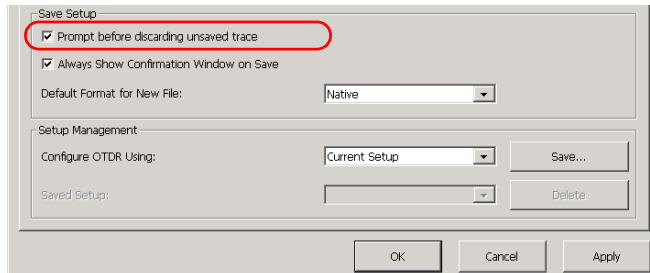

2. If you want to confirm the deletion each time you press **Save**, select the **Prompt before discarding unnamed trace** box.

OR

If you never want the application to discard the unnamed trace automatically, clear the box.

3. Press **Apply** to confirm the changes, then **OK** to return to the main window.

Displaying or Hiding Pass/Fail Messages

The application can display messages indicating the event status of all the traces associated with the current fiber (one trace per wavelength). The current fiber corresponds to the fiber associated with the current trace in the **Result** tab of the main window (see *Displaying or Hiding a Trace* on page 149).

The messages are displayed at the end of an analysis (or a reanalysis), when the thresholds are modified or when a trace file is opened.

If you select...	The application will display a message if...
Pass	all events are below the thresholds
Warning	at least one event exceeds the warning thresholds
Fail	at least one event exceeds the fail thresholds

If you want to modify the threshold values used to determine warning and fail status, see *Setting Pass/Fail Thresholds* on page 80.

To display the messages:

1. From the main window, press **Setup**, then select the **Thresholds** tab.
2. Ensure that the **Fail** and/or **Warning** check boxes are selected.

If not, the application will not use the associated thresholds and no message will be displayed.

3. Under **Popup Messages**, select the check boxes corresponding to the desired status.

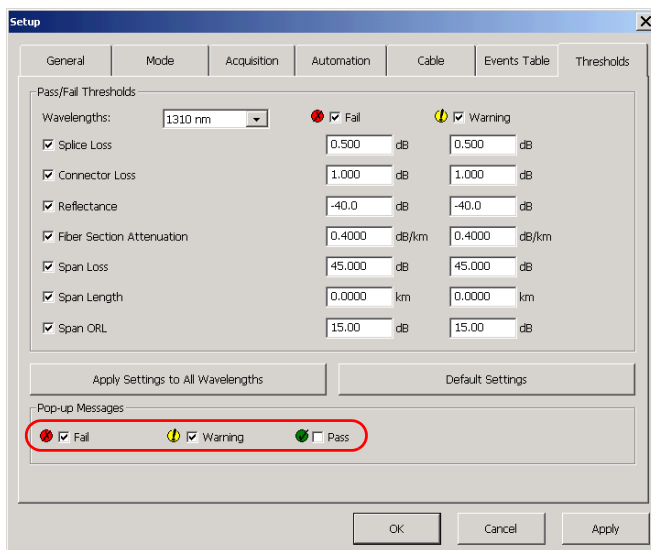

4. Press **Apply** to confirm the changes, then **OK** to return to the main window.

Customizing the Application

Selecting the Distance Units

Selecting the Distance Units

You can select the measurement units that will be used throughout the application, except for certain values such as the pulse and the wavelength. By convention, these values are always expressed in meters (nanometers for the wavelengths).

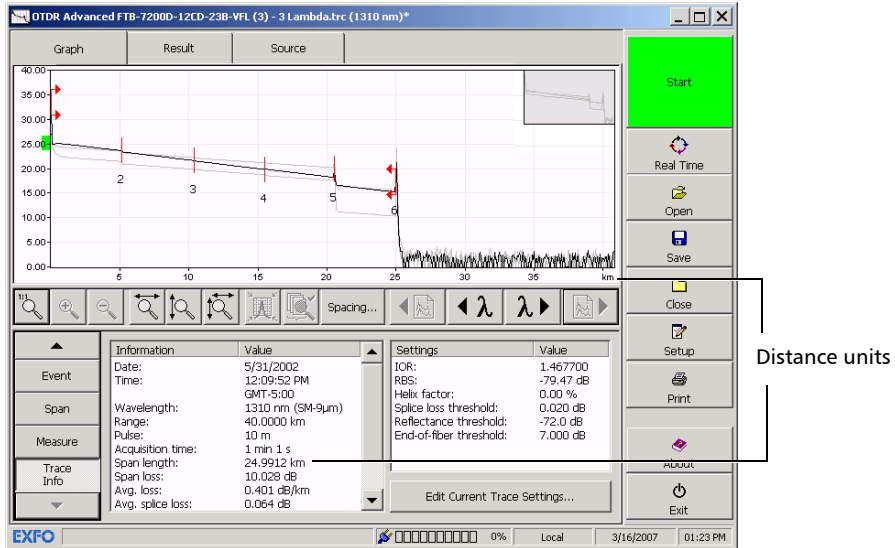

The default distance units are the kilometers.

Note: If you select **Kilometers (km)** or **Kilofeet (kf)**, **m** and **f** may appear instead to display more precise measurements.

Note: The attenuation of fiber sections is always presented in dBs per kilometer even if the distance units you selected are not the kilometers. This follows the standards of the fiber-optic industry that provides the attenuation values in dBs per kilometer.

To select the distance units for your display:

1. From the main window, press the **Setup** button.
2. From the **Setup** dialog box, select the **General** tab.
3. In the **Distance Unit** list, select the distance units to display.

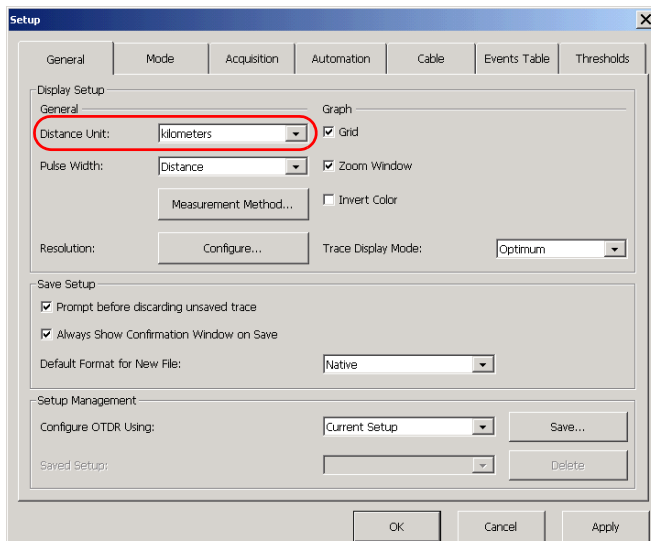

4. Press **Apply** to confirm the changes, then **OK** to return to the main window.

Once you exit the Setup dialog box, in the bottom right-hand corner of the trace display, you will notice that the distance unit abbreviation has changed. It will read **km** for kilometers, **mi** for miles, or **kf** for kilofeet, depending on your selection.

Customizing the Application

Customizing the Acquisition Distance Range Values

Customizing the Acquisition Distance Range Values

Note: This function is available in Advanced mode only.

If your OTDR model is FTB-7000D or later, you can customize the values associated with the **Distance** dial. Once the customization is complete, you are ready to set the distance range value for your test. For more information, see *Setting Distance Range, Pulse Width, and Acquisition Time* on page 74.

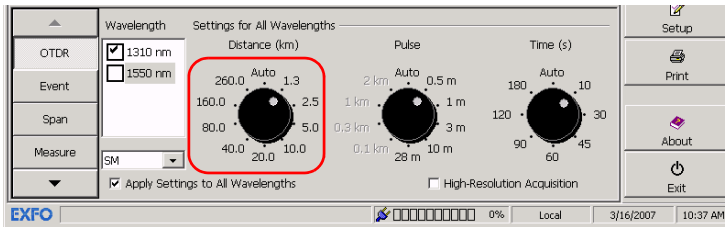

Note: The *Auto* value cannot be modified.

To customize the distance range values:

1. From the main window, select **Setup**, then the **Acquisition** tab.
2. Press the **Customize Settings** button.

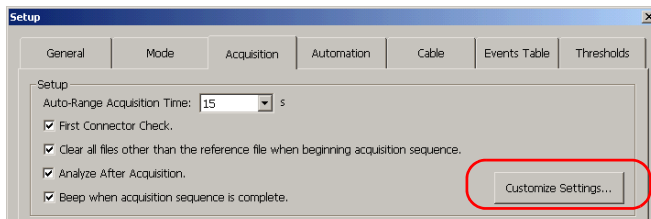

3. If your OTDR supports singlemode, multimode or filtered wavelengths, specify the desired fiber type.

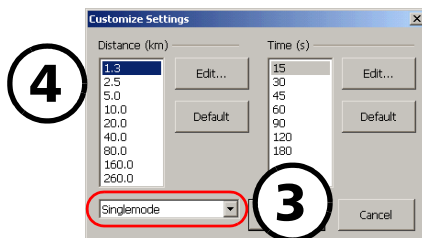

4. From the **Distance** list, select the value you want to modify (the value will become highlighted), then press the **Edit** button.

Note: You can revert to factory values by pressing the **Default** button.

5. In the displayed dialog box, enter the new value and confirm with **OK**. Press **OK** once again to close the **Customize Settings** dialog box.

You return to the **Acquisition** tab.

Customizing the Application

Customizing the Acquisition Time Values

Customizing the Acquisition Time Values

Note: This function is available in Advanced mode only.

You can customize the values associated with the **Time** dial. The acquisition time values represent the time during which the OTDR will average acquisitions.

If your OTDR model is FTB-7000D or later, you can even define acquisition time as short as 5 seconds (10 seconds for older modules).

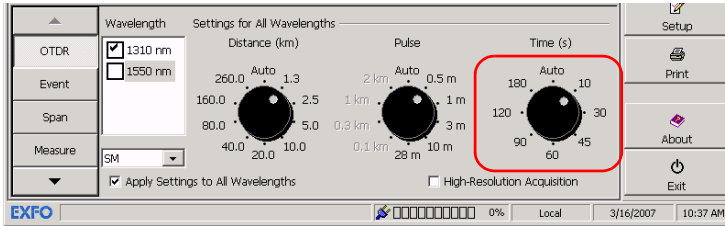

You can customize the acquisition time to improve the signal-to-noise ratio (SNR) of the trace and enhance the detection of low-level events. The SNR improves by a factor of two (or 3 dB) each time the acquisition time is increased by a factor of four.

To customize the acquisition time values:

1. From the main window, select **Setup**, then the **Acquisition** tab.
2. Press the **Customize Settings** button.

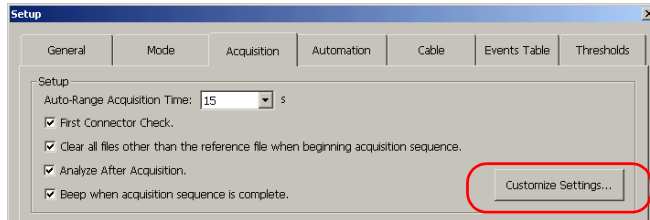

3. From the **Time(s)** list, select the value you want to modify (the value will become highlighted), then press the **Edit** button.

Note: You can revert to factory values by pressing the **Default** button.

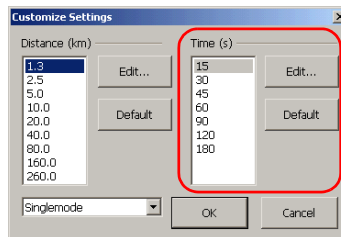

4. In the displayed dialog box, enter the new value and confirm with **OK**. Press **OK** once again to close the **Customize Settings** dialog box.

You return to the **Acquisition** tab.

Customizing the Application

Defining the Number of Digits Displayed after the Decimal Point

Defining the Number of Digits Displayed after the Decimal Point

You can set the number of digits that will be displayed after the decimal point for the following values:

- Span loss
- Reflectance
- Section attenuation
- Span length
- Span ORL

This will affect the way values are displayed and, possibly, the status of the results (pass, warning or fail).

The following table indicates what would happen with a particular fiber section having an attenuation value of 0.5523.

Value	Number of digits	Displayed value	Warning threshold	Result status
0.5523	3	0.552	0.550	Warning
0.5523	2	0.55	0.55	Pass

Note: *The displayed values are rounded, not truncated.*

Note: *This function is available in Advanced mode only.*

To define the number of digits that will be displayed after the decimal point:

1. From the button bar, select **Setup** then select the **General** tab.
2. Press the **Configure** button.
3. Modify the number of digits as follows:
 - 3a. Select the desired value from the list.

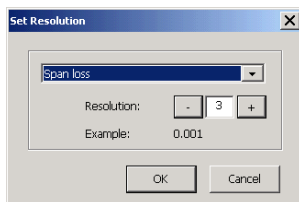

- 3b. In the **Resolution** box, type the desired value or use the buttons located on each side of the box to adjust the value.
 - 3c. Press **OK** to confirm your selection.
4. Press **OK** to return to the main window.

Customizing the Application

Enabling or Disabling the Beep Emitted After Acquisitions

Enabling or Disabling the Beep Emitted After Acquisitions

The application can emit a sound to inform you that the acquisition sequence is complete.

To enable or disable the beep:

1. From the main window, select **Setup**, then select the **Acquisition** tab.
2. If you want to enable the beep, select the **Beep when acquisition sequence is complete** box.

OR

If you prefer to disable the beep, clear the box.

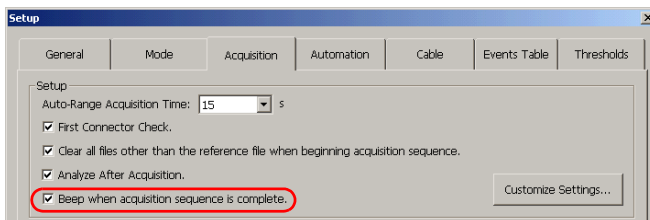

3. Press **Apply** to confirm your changes and **OK** to return to the main window.

Defining OTDR Setups

Once you have established all your configuration parameters, you may choose to save your setup for future use. You can also modify existing OTDR setups or delete them as needed.

Note: *To speed up the OTDR setup definition, you can use an already existing setup, make the changes you need and save it under a new name (see the procedure on page 128).*

To save an OTDR setup:

1. Make sure you have established all your parameters first (by entering the required data in all tabs of the **Setup** dialog box).
2. From the main window, press **Setup**.
3. From the **Setup** dialog box, select the **General** tab.
4. In the **Configure OTDR Using** list, ensure that **Current Setup** is selected.

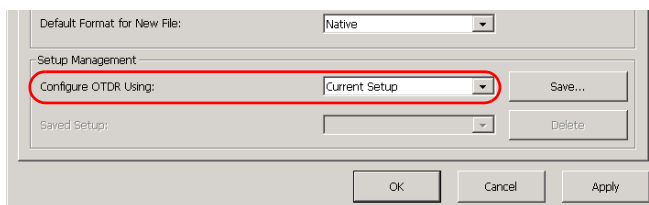

5. Press **Save**.

The **OTDR** dialog box opens.

6. Enter the file name in the box, and press **OK**.
The setup is now added to the **Saved Setup** list.

Customizing the Application

Defining OTDR Setups

To modify an existing OTDR setup:

1. From the main window, press the **Setup** button.
2. From the **Setup** dialog box, select the **General** tab.
3. In the **Configure OTDR Using** list, ensure that **Saved Setup** is selected.

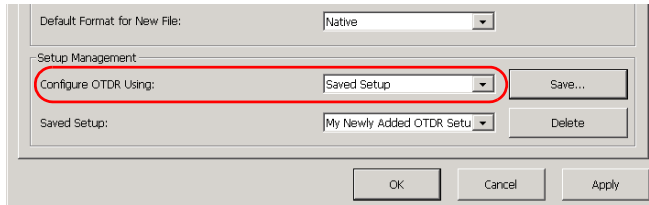

4. From the **Saved Setup** dialog box, select the desired OTDR setup.
5. Make any changes you want and press **Save**.
 - If you want to modify the existing file (overwriting it), keep the file name as is and press **OK**. When the application prompts you, press **Yes**.
 - If you want to create a distinct file and leave the existing file intact, enter a new file name and press **OK**.
6. Your modifications will only be effective if you press **Apply**, then **OK** from the **Setup** dialog box.

To delete an OTDR setup:

1. From the main window, press the **Setup** button.
2. From the **Setup** dialog box, select the **General** tab.
3. In the **Configure OTDR Using** list, ensure that **Saved Setup** is selected.

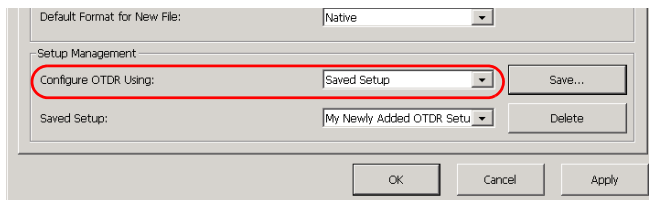

IMPORTANT

Once an OTDR setup is deleted, it cannot be recovered.

4. From the **Saved Setup** dialog box, select the OTDR setup to delete and press **Delete**.
5. When the application prompts you to confirm, press **Yes**.

Customizing the Application

Selecting an OTDR Setup

Selecting an OTDR Setup

You can select which OTDR setup you will use for your test session. There are two possibilities:

- **Current Setup:** to retrieve the last configuration used.
- **Saved Setup:** to specify which of the saved configurations you want to use.

To select an OTDR setup:

1. From the main window, press the **Setup** button.
2. From the **Setup** dialog box, select the **General** tab.
3. In the **Configure OTDR Using** list, select **Current Setup**.

OR

Select **Saved Setup** and from the **Saved Setup** dialog box, select an OTDR setup.

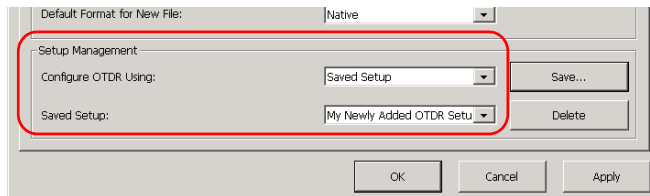

4. Press **Apply** then **OK**.

9 **Analyzing Traces and Events**

Once the acquired trace is analyzed, it appears in the trace display and the events are displayed in the events table at the bottom of the screen. The trace display and events table are explained in the following sections. You can also reanalyze existing traces. For information on the various file formats you can open with the application, see *Opening Trace Files* on page 183.

From the graph, you can also access the following tabs to have more information:

- Events
- Trace info.

Analyzing Traces and Events

Trace Display and Events Table Description

Trace Display and Events Table Description

The application shows the analysis results both on a graph and in a table. The events, that are detailed in the events table (see *Event Pane* on page 134), are marked by numbers along the displayed trace.

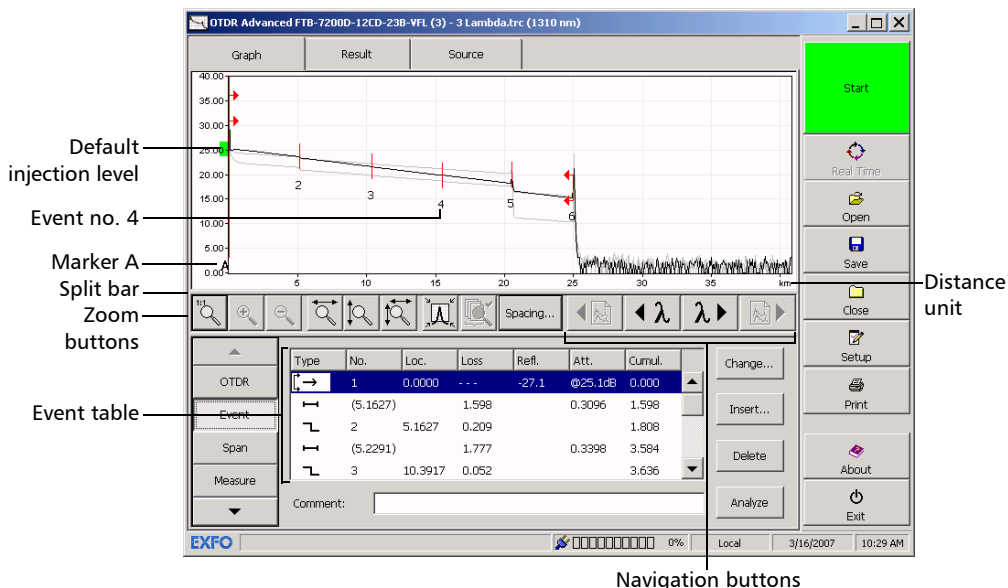

Some items in the trace display are always visible, while others will appear only if you choose to display them. The contents of the graph area changes according to the selected pane.

The light green rectangle on the Y-axis (relative powers) indicates the proper injection level range for the defined test pulse. If the current injection level is outside the appropriate range, the application will display a warning message if you selected the first connector check feature (see *Enabling or Disabling the First Connector Check* on page 54).

Once the trace is acquired, you can change trace display parameters (such as the grid and zoom window display). For more information, see *Setting Trace Display Parameters* on page 142.

Note: *Drag the split bar between the trace display and tabs to change their relative dimensions on the screen.*

If you want to zoom in on an event selected in the events table, see *Using Zoom Controls* on page 139.

You can view all of the traces, in turn, in both the **Trace Info** pane and the trace display with the navigation buttons. For more information, see *Displaying or Hiding a Trace* on page 149.

Event Pane

You can view information about all detected events on a trace and fiber sections by scrolling through the events table. When you select an event in the events table, marker **A** appears on the trace over the selected event. When the selected event is a fiber section, this fiber section is delimited by two markers (**A** and **B**). For more information on markers, see *Using Markers* on page 191.

These markers pinpoint an event or a fiber section, depending on what is selected in the events table. You can move markers directly by selecting an element in the events table or on the graph. You can also drag markers from one location to another on the graph.

The events table lists all the events detected on the fiber. An event can be defined as the point at which change in the transmission properties of light can be measured. Events can consist of losses due to transmission, splices, connectors or breaks. If the event is not within the established thresholds, its status will be set to “warning” or “fail”.



Type	No.	Loc.	Loss	Ref.	Att.	Cumul.	
→	1	0.0000	---	-27.1	@25.1dB	0.000	Change...
↔	(5.1627)		1.598		0.3096	1.598	Insert...
↔	2	5.1627	0.209			1.808	Delete
↔	(5.2291)		1.777		0.3398	3.584	Analyze
↔	3	10.3917	0.052			3.636	

Comment:

Buttons: Setup, Print, About, Exit

If you press and hold the row corresponding to a specific event or fiber section for a few seconds, the application will display a tooltip identifying the item (for example, Non-reflective fault). If an asterisk appears next to the event symbol, the tooltip will also show “(*:Modified)” to indicate that this event has been modified manually.

If the asterisk appears next to the event number, “(*:Added)” will appear to indicate that this event has been inserted manually.

For each item listed in the events table, information is displayed:

- **Type:** Various symbols are used to describe different event types. For a more detailed description of symbols, see *Description of Event Types* on page 295.
- **No.:** Event number (a sequential number assigned by the OTDR test application) or, in parentheses, the length of a fiber section (the distance between two events).
- **Loc.:** Location; that is, distance between the OTDR and the measured event or between the event and the beginning of the fiber span.
- **Loss:** Loss in dB for each event or fiber section (calculated by the application).
- **Refl.:** Reflectance measured at each reflective event along the fiber.
- **Att.:** Attenuation (loss/distance) measured for each fiber section.

Note: *The attenuation value is always presented in dB per kilometers even if the distance units you selected are not the kilometers. This follows the standards of the fiber-optic industry that provides the attenuation values in dB per kilometers.*

- **Cumul.:** Cumulative loss from the trace span start to span end; the running total is provided at the end of each event and fiber section.

Cumulative loss is calculated for the events displayed in the events table, excluding those that are hidden. For a more accurate link loss value, refer to the loss measurement displayed in the **Trace Info** pane.

If you want to modify events or fiber sections, see *Changing the Loss and Reflectance of Events* on page 160, *Inserting Events* on page 164, and *Changing the Attenuation of Fiber Sections* on page 167.

Analyzing Traces and Events

Event Pane

To quickly locate an event in the events table:

Select the event on the trace.

The list scrolls automatically to the event you selected.

The screenshot shows the OTDR software interface with the following components:

- Graph:** A line graph showing signal loss over distance (km). The y-axis ranges from 0.00 to 40.00, and the x-axis ranges from 0 to 35 km. Several red vertical markers are placed on the trace, labeled 1 through 6. A green vertical marker labeled 'Marker A' is at approximately 1.5 km.
- Event no. 4:** A label pointing to the fourth event marker on the trace.
- Marker A:** A label pointing to the green vertical marker on the trace.
- Event table:** A table with columns: Type, No., Loc., Loss, Refl., Att., and Cumul. The table contains three rows of event data.
- Event editing buttons:** A red box highlights four buttons on the right side of the event table: 'Change...', 'Insert...', 'Delete', and 'Analyze'.

Type	No.	Loc.	Loss	Refl.	Att.	Cumul.
→	1	0.0000	---	-27.1	@25.1dB	0.000
↔	(5.1627)	1.598	0.209			1.598
↔	(5.2291)	1.777	0.3398			3.584
↔	10.3917	0.052				3.636

Measure Pane

The application shows two, three or four markers: **a**, **A**, **B**, and **b**, depending on the button you pressed under **Measurements**.

These markers can be repositioned along the trace to calculate loss, attenuation, reflectance, and optical return loss (ORL).

You can reposition all markers by using the controls in the **Markers** section. You can drag them directly from the trace display. Selecting marker **A** or **B** will move the **a-A** or **B-b** pair.

For more information on how to perform manual measurements, see *Analyzing the Results Manually* on page 189.

Trace Info Pane

The information about all the trace files (including the reference) can be displayed.

You can view all of the traces, in turn, in both the **Trace Info** pane and the trace display with the navigation buttons. For more information, see *Displaying or Hiding a Trace* on page 149.

Analyzing Traces and Events

Viewing Test Results

Viewing Test Results

The application allows you to view current results directly after an acquisition sequence or to reload data from existing files.

To view test results:

From the main window, select the **Result** tab.

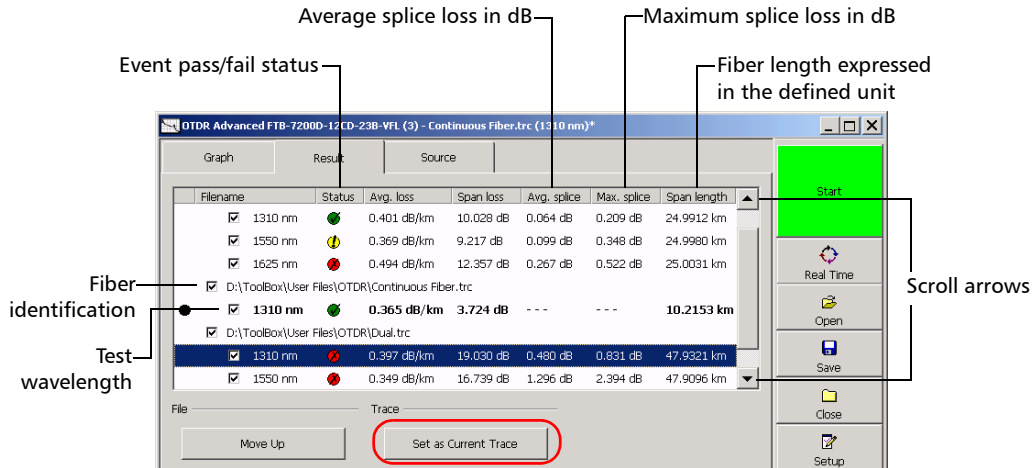

Note: The **Result** tab displays the results of pass/fail tests performed at the time of trace acquisitions. Therefore, it will not be updated if you modify existing traces later.

To view the graph corresponding to a listed trace:

1. From the **Result** tab, select the desired trace and press the **Set as Current Trace** button.

Note: Since a trace cannot be both a reference and a main (current) trace at the same time, the **Set as Current Trace** button will remain unavailable if you select the reference trace from the list.

2. Select the **Graph** tab.

Using Zoom Controls

Use the zoom controls to change the scale of the trace display. With the zoom controls, a magnifying glass icon appears in the trace display. When the scale changes, the trace display is always centered on the area surrounding the magnifying glass icon.

You can zoom in on or out of the graph using the corresponding buttons or let the application automatically adjust the zoom on the currently selected event from the events table (only available when the events window is displayed).

You can quickly zoom in on or out of the selected event.

You can also return to the original graph value.

- When you manually zoom in or out on a trace, the application will apply the new zoom factor and marker positions to the other traces (wavelengths) of a same file and on the reference file, if applicable. Both the zoom factor and marker positions will be saved along with the trace (same settings for all wavelengths).
- When you zoom in or out on the selected event, the application keeps the zoom on this event until you select another event or change zoom or marker positions (via the **Measure** tab). You can select a different event for each wavelength (for example, event 2 at 1310 nm and event 5 at 1550 nm). The selected events will be saved along with the trace.
- You can also apply the zoom factor and marker positions of the current trace to all the trace files that are currently open. However, these files will be treated exactly as if you manually zoomed in or out on the traces.

Analyzing Traces and Events

Using Zoom Controls

To view specific portions of the graph:

1. On the trace display, drag the magnifying glass icon to the area where you want to adjust the zoom.
2. Select the desired type of zoom.

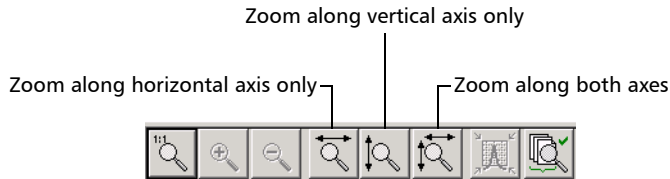

3. Press the button corresponding to the desired behavior as many times as needed.

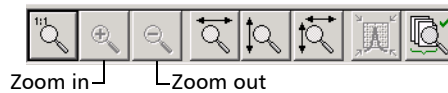

Note: You can also use the selection dial located on the front of the FTB-400 Universal Test System to zoom in or out.

To automatically zoom in on the selected event:

1. From the main window, select the **Graph** tab and press the **Event** button.
2. From the events table, select the desired event.
3. Press  to automatically adjust the zoom factor.

To apply the same zoom factor and marker positions to all traces that are open:

From the main window, select the **Graph** tab and press .

To revert to the complete graph view:

Press the  button.

Analyzing Traces and Events

Setting Trace Display Parameters

Setting Trace Display Parameters

You can set display preferences such as:

- the grid: You can display or hide the grid appearing on the graph's background. By default, the grid is displayed.
- the graph background: You can display the graph with a black (invert color feature) or a white background. By default, the background is white.

Note: *The application always prints graphs with a white background.*

- the zoom window: The zoom window shows you which portion of the graph is being magnified.

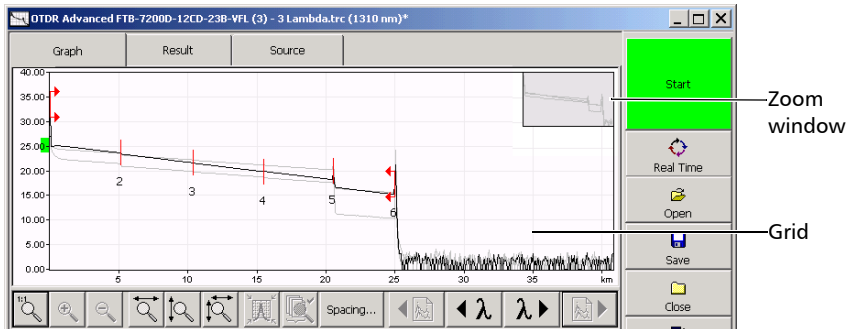

To set the trace display parameters:

1. From the main window, press the **Setup** button, then select the **General** tab.
2. Select the boxes corresponding to the item you want to display on the graph.

OR

To hide them, clear the boxes.

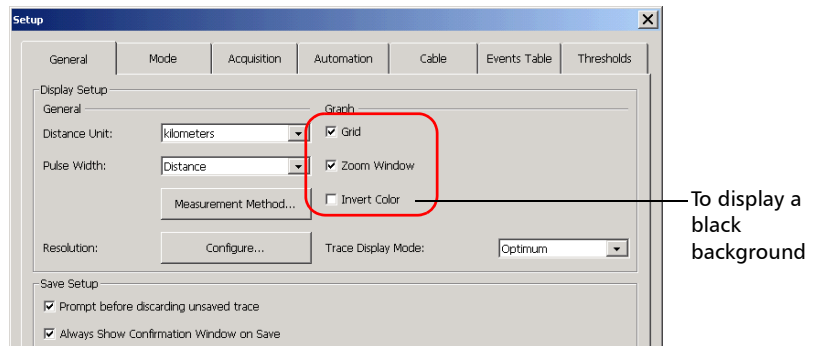

Changes will be applied once you exit the **Setup** dialog box.

Press **Apply** to confirm the changes, then **OK** to return to the main window.

Customizing the Event Table

Note: *This function is available in Advanced mode only.*

You can include or exclude items from the events table to better suit your needs.

Note: *Hiding the fiber sections, the merged events or the comments will not delete these items.*

- *Fiber sections:* You can display or hide fiber sections in the events table and in the linear view, depending on the types of values you want to display.

For example, by hiding the fiber sections, you can obtain the running total of connector and splice losses instead of having a loss value for the entire link.

- *Merged events:* Merged events consist of events that are located very close to one another. When the application detects such events, it displays one global loss value and individual reflectance values for the merged events. It is possible to display or hide merged events in the events table.
- *Comments:* You can display or hide the comments area appearing at the bottom of the events table.

- **Launch level:** In the events table, the Launch Level event is represented by the → icon. In the **Att.** column, the injection level value for that event is identified by the @ symbol. You can hide the injection level value and symbol from the **Att.** column, but not the → icon.

Type	No.	Loc.	Loss	Refl.	Att.	Cumul.
→	1	0.0000	---	-27.1	@25.1dB	0.000
—	(5.1627)		1.598			1.598
└	2	5.1627	0.209			1.808
—	(5.2291)		1.777		0.3398	3.584
└	3	10.3917	0.052			3.636

- **Including span start and span end loss:** When applicable, the application will include the losses caused by the span start and span end events in the displayed values.

If you activated the pass/fail test (see *Setting Pass/Fail Thresholds* on page 80), span-start and span-end events will be taken into account when determining the status (pass/fail) of connector loss and reflectance.

If you want to record the span-start and span-end points of the current trace so that the application can apply them after reanalysis, see *Saving the Span-Start and Span-End Information* on page 87.

Analyzing Traces and Events

Customizing the Event Table

To customize the events table appearance:

- 1.** From the main window, press the **Setup** button, then select the **Events Table** tab.
- 2.** Select the boxes corresponding to the item you want to display or include in the table.

OR

To hide them, clear the boxes.

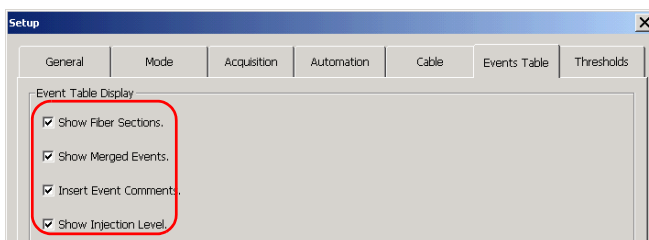

- 3.** Press **Apply** to confirm and **OK** to return to the main window.

Selecting the Pulse Width Unit

You can select the unit that is used in the **Trace Info** window to express the pulse value. The pulse value can be expressed in units of time or distance (see *Selecting the Distance Units* on page 118).

To select the pulse width unit:

1. From the main window, press **Setup**.
2. From the **Setup** dialog box, select the **General** tab.
3. Press the arrow next to the **Pulse Width** box arrow and select the desired unit.
4. Press **Apply** to confirm the changes, then **OK** to return to the main window.

Once you exit the **Setup** dialog box, your selection is displayed in the **Trace Info** pane, under **Pulse**.

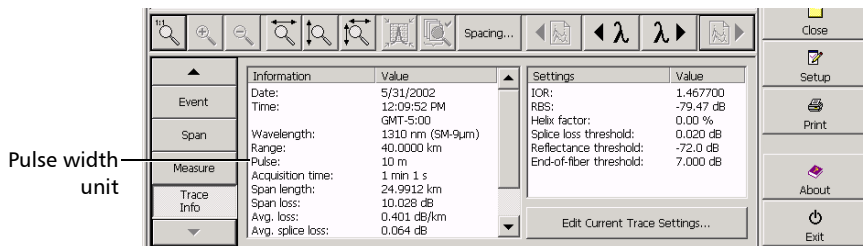

Selecting a Trace Display Mode

You can choose the way the application will display traces on-screen and in reports. The available choices are:

- **Complete Trace:** to display the whole trace and full acquisition distance.
- **Span:** to display the trace from the span start to the span end.
- **Optimum:** to display the trace with a minimum amount of noise after the fiber end.

To select a trace display mode:

- 1.** From the main window, press the **Setup** button.
- 2.** From the **Setup** dialog box, select the **General** tab.
- 3.** Press the arrow of the **Trace Display Mode** box and select the desired display mode.
- 4.** Press **Apply** to confirm the changes, then **OK** to return to the main window.

Once you exit the **Setup** dialog box, the display will be changed according to your selection.

Displaying or Hiding a Trace

There are two ways of displaying or hiding traces in the OTDR test application.

- You can view, in turn, all the trace files you have opened, including main and reference traces, as well as multiwavelength traces.
- You can select the fibers and the wavelengths (for multiwavelength files) that will be available when using the navigation bar. You can also specify which trace will be displayed in the **Graph** tab (current trace). By default, the application takes the last item from the list of trace files you have just opened.

To display or hide traces in turn:

In the **Graph** tab, press the appropriate button from the navigation bar to switch from one fiber to another or from one wavelength to another (for multiwavelength files).

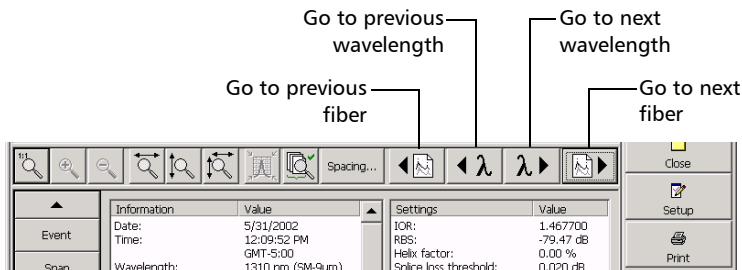

Analyzing Traces and Events

Displaying or Hiding a Trace

To specify which traces to display or hide:

1. From the main window, select the **Result** tab.

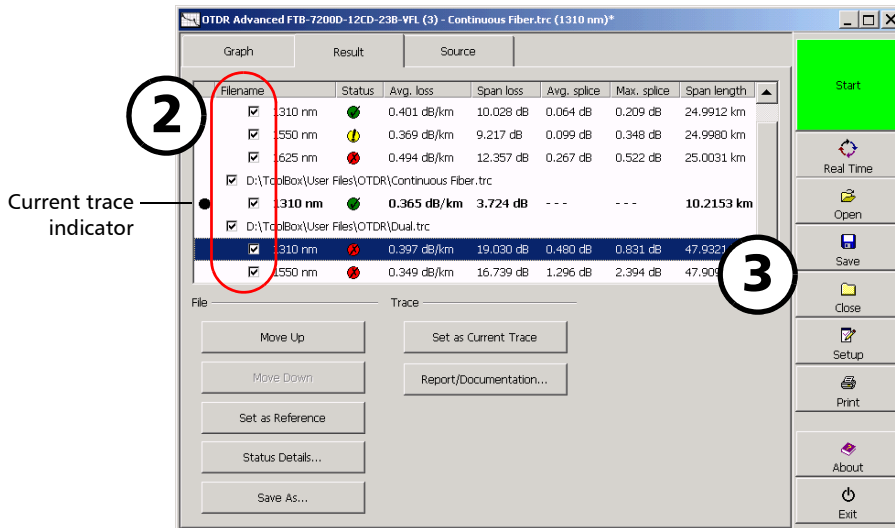

2. Select the boxes corresponding to the traces to display.

OR

Clear the boxes to hide them.

Note: A hidden trace cannot be displayed with the navigation bar. In multiwavelength trace files, you can show or hide traces independently.

3. From the list of traces, select the row corresponding to the trace you want to set as the current trace (the row will become highlighted) and press the **Set as Current Trace** button.

A black dot will appear at the left of the trace to indicate that it was selected as such.

The trace will turn black in the display to indicate that it was selected.

Clearing Traces from the Display

Note: *This feature is available in all test modes. However, you have to be in Advanced mode to set the application to automatically clear the traces from the display (except the reference trace) before launching the acquisition.*

Note: *Clearing traces from the display does not delete them from the disk.*

Although the test application automatically opens the last trace files used, you can clear the screen and launch new acquisitions. Also, if a trace you acquired does not meet your requirements, you can clear that trace and start over. In Template mode, you cannot clear the reference trace directly; you have to clear it in Advanced mode, acquire or load another reference trace, and then return to Template mode.

You can also specify whether you want the application to automatically clear all files except the reference file when the acquisition is started.

Analyzing Traces and Events

Clearing Traces from the Display

To clear traces from the display:

1. From the main window, on the button bar, press **Close**.
2. From the **Close File(s)** dialog box, select the check boxes corresponding to the files you want to clear.

You can use the **Select All** or **Deselect All** button to speed up your selection.

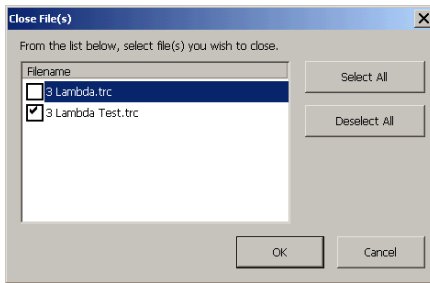

3. Press **OK** to confirm.

If you had already acquired or modified (but not stored) some traces, a warning message appears for each trace (even if the trace is hidden) asking you if you want to save it.

To set automatic clearing of the trace display:

- 1.** From the main window, press the **Setup** button.
- 2.** From the **Setup** dialog box, select the **Acquisition** tab, then select the **Clear all files other than the reference file when beginning acquisition sequence** box.

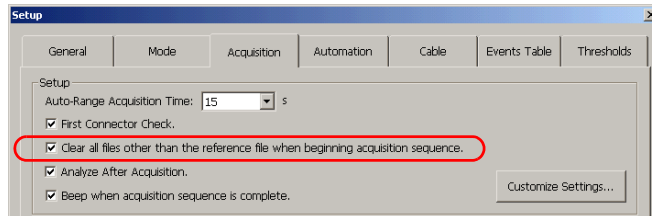

- 3.** Press **Apply** to confirm the changes, then **OK** to return to the main window.

Once you launch your test, the files will be automatically closed. If you had already acquired or modified (but not stored) some traces, a warning message appears for each trace (even if the trace is hidden) asking you if you want to save it or not.

The same principle will apply if you retest some channels (see *Retesting Channels* on page 92).

Analyzing Traces and Events

Modifying Space Between Traces on the Graph

Modifying Space Between Traces on the Graph

For easier viewing of the traces appearing on the graph, you can increase or decrease the vertical space between each of them.

To increase or decrease the space between traces:

1. From the **Graph** tab in the main window, press **Spacing**.

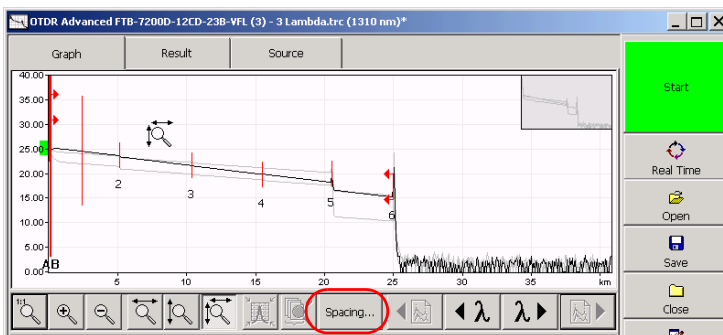

2. Adjust trace spacing using buttons and slider in the **Trace Spacing** dialog box.

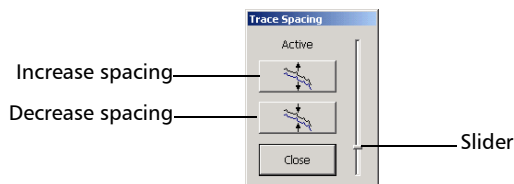

- To increase trace spacing, press the corresponding button or move the slider upwards.
- To decrease trace spacing, press the corresponding button or move the slider downwards.

When you are satisfied with the graph appearance, press **Close**.

Viewing and Modifying Current Trace Settings

You can view the trace parameters and modify them at your convenience.

Note: *Parameter modification is only possible in Advanced mode and in Auto mode (if you selected the **Enable Editing for Current Trace Settings** in the **Mode** tab). For more information on the activation and deactivation of this feature, see *Testing Fibers in Auto Mode* on page 59.*

Two groups of parameters can be changed:

- Fiber settings: index of refraction (IOR) also known as group index, Rayleigh backscatter (RBS) coefficient, and helix factor.
- Analysis detection thresholds: for splice loss, reflectance, and end-of-fiber detection.

Modifications you make are only applied to the current trace (that is, to a particular wavelength), not to all traces.

These modifications alter the displayed traces. These settings will also be used when you reanalyze the trace.

The application will only reanalyze the trace if you modify the RBS coefficient (no analysis necessary when you modify the IOR or helix factor). If you want to modify the parameters that will be used for future acquisitions, see *Setting the IOR, RBS Coefficient, and Helix Factor* on page 71 and *Setting the Analysis Detection Thresholds* on page 170.

Analyzing Traces and Events

Viewing and Modifying Current Trace Settings

To view trace settings:

Press the **Trace Info** button.

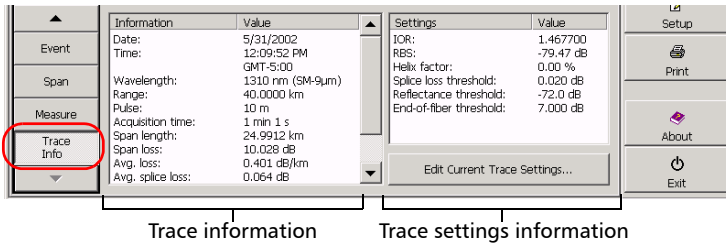

Note: Even if more than one trace is available, the **Trace Info** pane only shows one at a time. To display the traces in turn, use the navigation bar. The active trace appears in black in the trace display.

These parameters are displayed:

- **Time:** Time at which the acquisition was completed, with the time zone.
- **Wavelength:** Test wavelength and type of fiber used: **SM** (singlemode) or **MM** (multimode).
- **Range:** Distance range used to perform the acquisition.
- **Pulse:** Pulse width used to perform the acquisition.
- **Acquisition Time:** Duration (in minutes and seconds) of the acquisition.
- **Length:** Measured length of the total fiber span between span start and span end.
- **Span loss:** Total measured loss of the fiber between span start and span end.
- **Avg. Loss:** Average loss of the total fiber span, indicated as a function of distance.

- **Avg. Splice Loss:** Average of all non-reflective events between span start and span end.
- **Max. Splice Loss:** Maximum loss of all non-reflective events between span start and span end.
- **Span ORL:** ORL calculated between the span start and the span end.
- **High-Resolution Acq.:** High-resolution feature was selected to perform the acquisition. For more information, see *Enabling the High-Resolution Feature* on page 77.
- **Helix Factor:** Helix for the displayed trace. If you modify this parameter, the trace distance measurements will be adjusted.
- **IOR:** Refraction index of the displayed trace, also known as group index. If you modify this parameter, the distance measurements for the trace will be adjusted. You can enter an IOR value directly or let the application calculate it with the distance between span start and span end you provide. The IOR value is displayed with six digits after the decimal point.
- **RBS:** Rayleigh backscatter coefficient setting of the displayed trace. If you modify this parameter, the reflectance and ORL measurements for the trace will be adjusted.
- **Splice Loss Threshold:** Current setting for detecting small non-reflective events during trace analysis.
- **Reflectance Threshold:** Current setting for detecting small reflective events during trace analysis.
- **End-of-Fiber Threshold:** Current setting for detecting important event loss that could compromise signal transmission during trace analysis.

Analyzing Traces and Events

Viewing and Modifying Current Trace Settings

To modify the current trace settings:

1. From the main window, go to the **Graph** tab and press the **Trace Info** button.

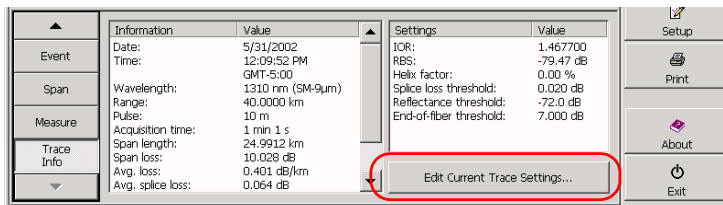

2. Press the **Edit Current Trace Settings** button.
3. Enter the desired values for the current trace in the appropriate boxes.

OR

If you want to revert to default values, press **Default**.

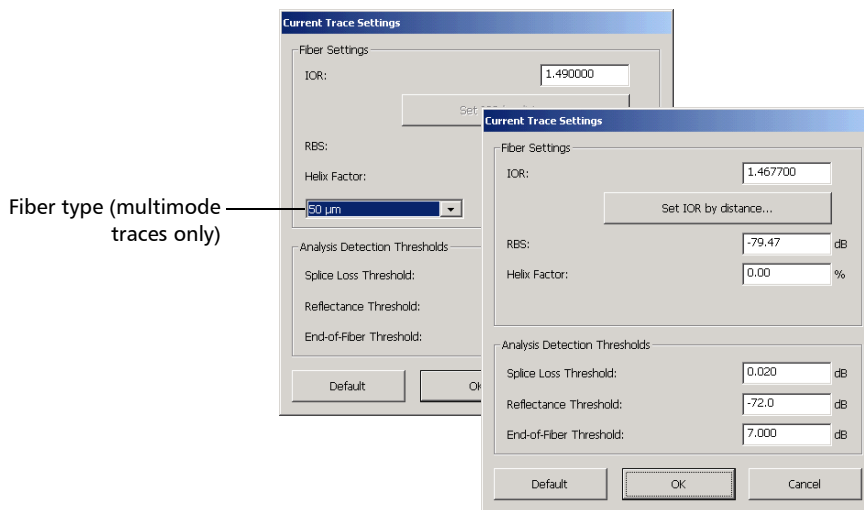

Note: Except for the fiber type, modifications you make will only be applied to the current trace (that is, to a particular wavelength), not to all traces.

You can change the fiber type of a multimode trace. The application will adjust the fiber type of *all* multimode wavelengths (traces).

Unless you are absolutely sure of the different parameter values, revert to default values to avoid fiber setting mismatches. You should do the same for other multimode wavelengths.

If you already know the IOR value, you can enter it in the corresponding box. However, if you prefer to let the application calculate the IOR value as a function of the distance between span start and span end, press **Set IOR by Distance**, then enter the distance value.

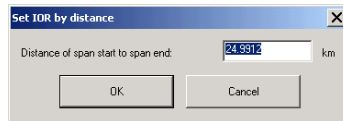

4. Press **OK** to apply the changes.

You return to the **Trace Info** pane.

Changing the Loss and Reflectance of Events

Note: *This function is available in Advanced mode only.*

You can change the loss and reflectance of almost any existing event except:

- continuous fiber
- end of analysis
- launch level
- merged events
- reflective end
- total events

In the case of a reflective event, you can also specify whether the event corresponds to an echo, a possible echo, or if it really is a reflective event.



IMPORTANT

If you reanalyze a trace, all of the modified events will be lost and the events table will be re-created.

Note: *If you want to modify the attenuation value of a fiber section, see [Changing the Attenuation of Fiber Sections](#) on page 167.*

To change the loss and reflectance of an event:

1. Select the event for which you want to modify the loss or reflectance.
2. Press **Change**.

A magnifying glass icon and four markers (**a**, **A**, **B**, and **b**) appear in the trace display.

You can reposition all markers directly by dragging them, or by pressing where you want to relocate them on the graph. Selecting marker **A** or **B** will move the **a-A** or **B-b** pair.

Note: The current marker locations are set, during the analysis, to calculate and display the original event loss and reflectance.

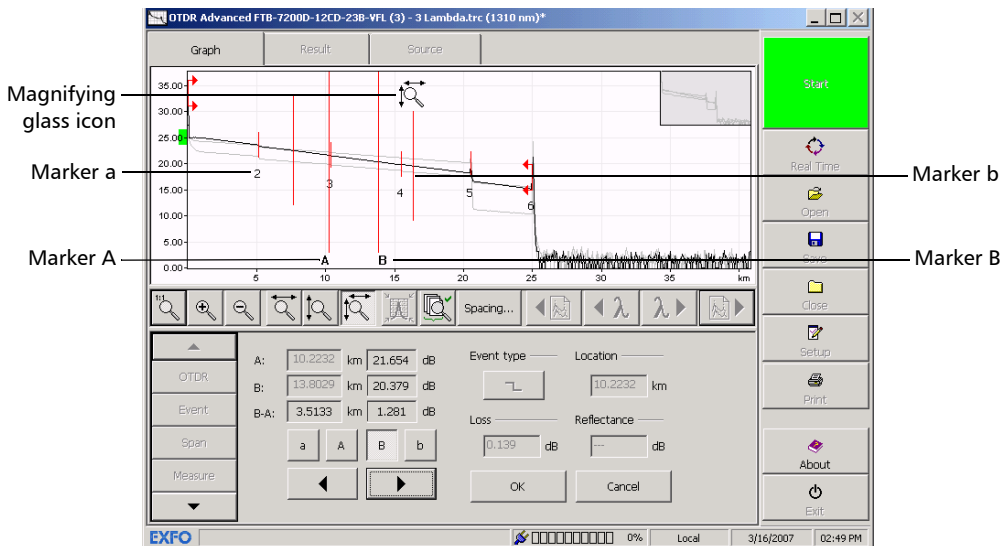

Analyzing Traces and Events

Changing the Loss and Reflectance of Events

3. Position marker **A** as close as possible to the event, and submarker **a** (to the left of marker **A**) as far as possible from marker **A**, without including the preceding event.

The area between markers **A** and **a** must not include any significant variation. For more information on positioning markers, see *Using Markers* on page 191.

4. Position marker **B** after the end of the event, where the trace returns to a regular loss inside the fiber, and submarker **b** (to the right of marker **B**), as far as possible from marker **B**, without including the following event.

The area between markers **B** and **b** must not include any significant variation. For more information on positioning markers, see *Using Markers* on page 191.

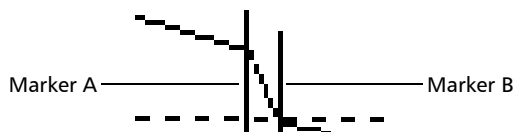

Event loss and reflectance are displayed, respectively, in the **Loss** and **Reflectance** boxes.

OTDR	A: 7.1109 km 12.421 dB	Event Type Π	Location 7.1109 km
Event	B: 10.0985 km 7.542 dB	Loss 4.879 dB	Reflectance -50.1 dB
Span	B-A: 3.0539 km 5.671 dB		
Measure	a A B b	OK	Cancel

Loss and reflectance values

5. If you selected a reflective event, you can modify the echo status using the **Event Type** button.

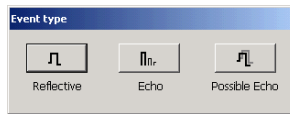

6. Press the button corresponding to the desired event type.

Loss and reflectance are calculated automatically, based on the position of the markers.

7. Press **OK** to accept the modifications you have made or **Cancel** to return to the events table without saving the changes.

The modified events are identified with “*” (appearing beside the event symbol) in the events table as shown below.

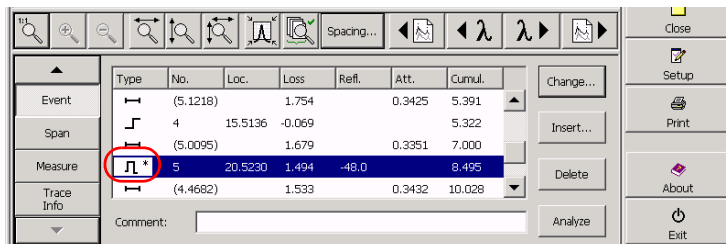

The screenshot shows the software interface with a toolbar at the top and a table of events. The table has columns for Type, No., Loc., Loss, Refl., Att., and Cumul. The row with Type "λ*" and No. 5 is highlighted. The "λ*" symbol is circled in red. To the right of the table are buttons for Change..., Insert..., Delete, and Analyze. On the far right, there is a vertical toolbar with buttons for Close, Setup, Print, About, and Exit.

Type	No.	Loc.	Loss	Refl.	Att.	Cumul.
λ	(5.1218)		1.754		0.3425	5.391
λ	4	15.5136	-0.069			5.322
λ	(5.0095)		1.679		0.3351	7.000
λ*	5	20.5230	1.494	-48.0		8.495
λ	(4.4682)		1.533		0.3432	10.028

Inserting Events

You can insert events in the event table manually.

This could be useful, for example, if you know that there is a splice at a given location, but the analysis does not detect it because it is hidden in the noise or because the splice loss is lower than the minimum detection threshold (see *Setting Pass/Fail Thresholds* on page 80).

You can add this event to the events table manually. This will add a number on the trace at the location of the insertion, but it will *not* modify the trace.



IMPORTANT

Inserted events are removed when you reanalyze a trace.

To insert an event:

1. From the main window, select the **Graph** tab and press the **Event** button.
2. From the **Event** pane, press **Insert**.

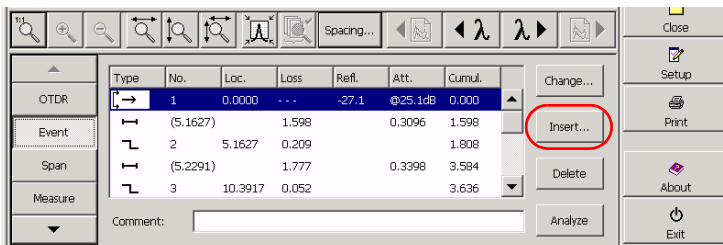

3. Select the location where you want to insert an event.

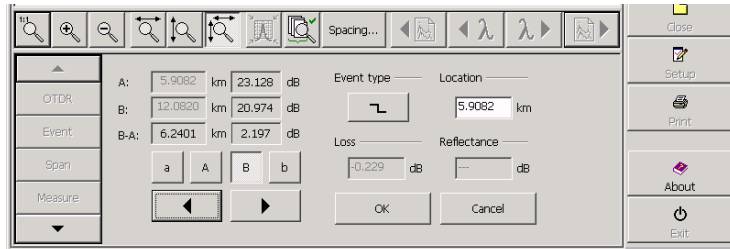

Four markers are available to measure the inserted event, but only marker **A** identifies where the event will be inserted. Use one of the following methods:

- Enter the location of the new event in the **Location** box.
 - Use the marker arrows to move marker **A** on the trace display.
4. Once you have determined the location, press the **Event Type** button.



5. Press the button corresponding to the desired event type.

Loss and reflectance are calculated automatically, based on the position of the markers. You may enter the event loss and reflectance values in the appropriate boxes.

6. Press **OK** to insert the event or **Cancel** to return to the events table without making any changes.

Inserted events are marked with asterisks (appearing beside the event number).

Deleting Events

Note: *This function is available in Advanced mode only.*

Almost any event can be deleted from the events table, except:

- end of analysis
- fiber section
- launch level
- echo
- end of fiber
- span start
- span end

Note: *The “End-of-fiber” event indicates the span end that was set for the first analysis of the trace, not the span end assigned to another event or distance from the span end in the **Acquisition tab**.*



IMPORTANT

The only way to “recover” deleted items is to reanalyze the trace, as you would for a new trace. For more information, see *Analyzing or Reanalyzing a Trace* on page 173.

To delete an event:

- 1.** Select the event you want to delete.
- 2.** Press **Delete**.
- 3.** When the application prompts you, press **OK** to confirm the deletion, or **No** to keep the event.

Changing the Attenuation of Fiber Sections

Note: *This function is available in Advanced mode only.*

You can change the attenuation value of fiber sections.



IMPORTANT

If you reanalyze a trace, all of the modifications made to the fiber sections will be lost and the events table will be re-created.

Note: *If you want to modify events, see [Changing the Loss and Reflectance of Events](#) on page 160.*

Analyzing Traces and Events

Changing the Attenuation of Fiber Sections

To modify the attenuation of a fiber section:

1. From the event table, select the fiber section.
2. Press the **Change Event** button.

The **A** and **B** markers appear in the trace display.

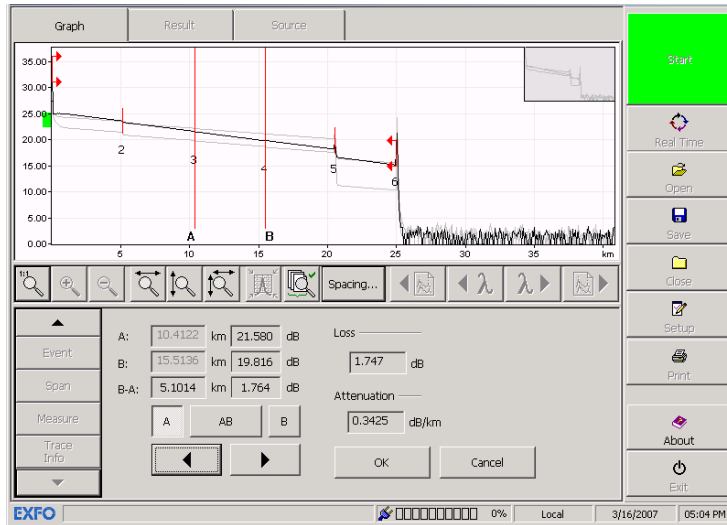

3. Position markers as desired to modify the attenuation value. For more information on positioning markers, see *Using Markers* on page 191.

Note: *The markers serve only to set the new attenuation value. Their actual locations will not be modified.*

Fiber section loss and attenuation are displayed respectively in the **Loss (LSA)** and **Att. (LSA)** boxes.

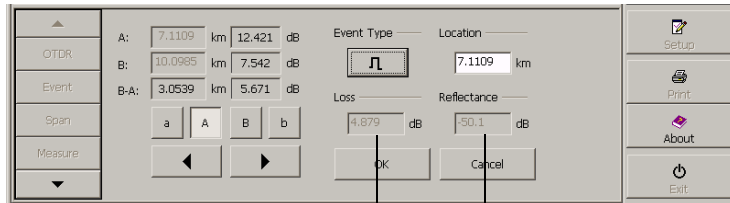

Loss and reflectance values

4. Press **OK** to accept the modifications you have made or **Cancel** to return to the events table without saving the changes.

The modified fiber sections are identified with “*” in the events table as shown below.



Setting the Analysis Detection Thresholds

Note: *This function is available in Advanced mode only.*

To optimize event detection, you can set the following analysis detection thresholds:

- *Splice loss threshold:* To display or hide small non-reflective events.
- *Reflectance threshold:* To hide false reflective events generated by noise, transform non-harmful reflective events into loss events, or detect reflective events that could be harmful to network and other fiber-optic equipment.
- *End-of-fiber threshold:* To stop the analysis as soon as an important event loss occurs; for example, an event that could compromise signal transmission toward the end of a network.



IMPORTANT

The end-of-fiber (EoF) threshold that you define will be used in Advanced mode if you let the application evaluate the acquisition settings.

If you set this threshold, an EoF event will be inserted at the first event for which the loss crosses the threshold. The application will then use this EoF event to determine the acquisition settings.

The following examples show how different splice-loss threshold levels can affect the number of displayed events, especially small non-reflective events such as those caused by two splices. Three traces are shown, corresponding to three threshold level settings.

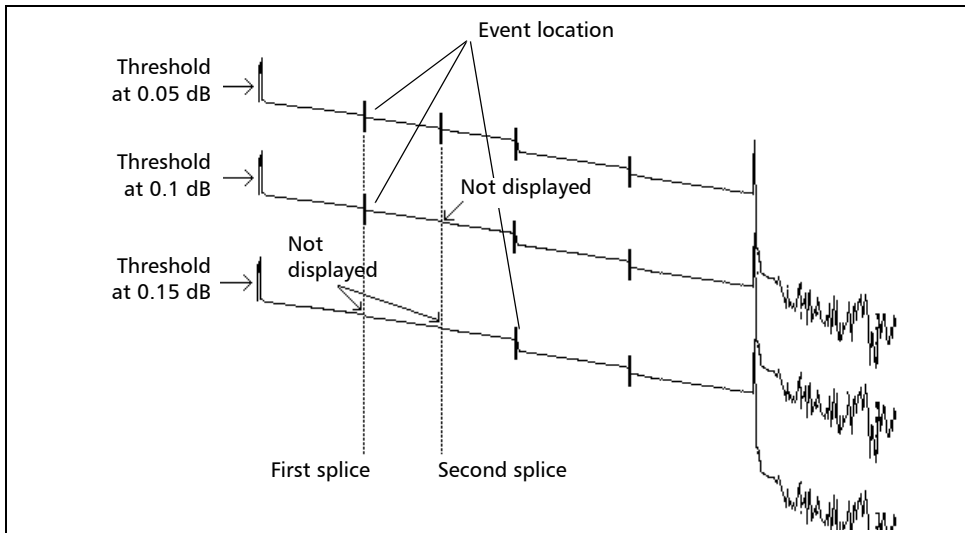

➤ *Threshold at 0.05 dB*

With the threshold set to 0.05 dB, two events are displayed at distances corresponding to the location of the first and second splices.

➤ *Threshold at 0.1 d*

Only the first splice is displayed, as the threshold is set to 0.1 dB and the second splice loss is lower than 0.1 dB.

➤ *Threshold at 0.15 d*

The first two splices are not displayed, as the threshold is set to 0.15 dB and the first and second splice losses are lower than 0.15 dB.

Analyzing Traces and Events

Setting the Analysis Detection Thresholds

To set the analysis detection thresholds:

1. From the main window, press **Setup**.
2. From the **Setup** dialog box, select the **Acquisition** tab.
3. Under **Detection Threshold Analysis**, set the parameters.

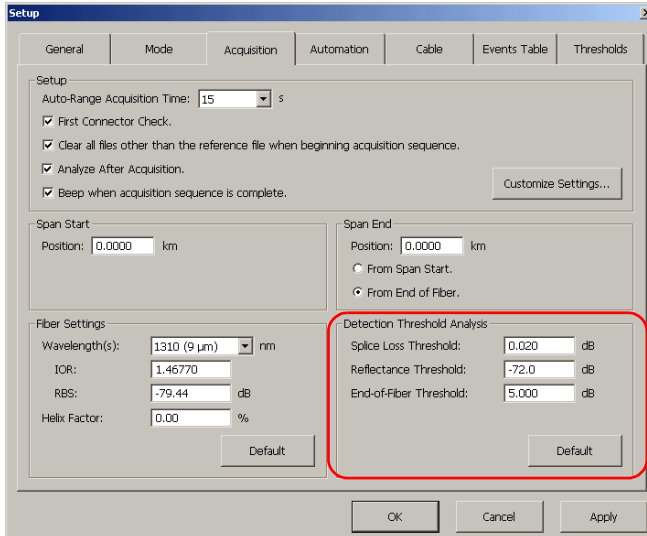

- Enter the desired values in the appropriate boxes.

OR

- Under **Detection Threshold Analysis**, select the default settings by pressing **Default**.

4. Press **Apply** to confirm the changes, then **OK** to return to the main window.

The analysis detection thresholds you have just set are applied to all newly acquired traces. It is also possible to change these thresholds for a specific trace for reanalysis. For details, see *Viewing and Modifying Current Trace Settings* on page 155.

Analyzing or Reanalyzing a Trace

Note: *This function is available in Advanced mode only.*

You can analyze a displayed trace at any time. Analyzing or reanalyzing a trace will:

- produce an events table for a trace, if there was none (for example, the *Analyze After Acquisition* feature was not selected; see *Enabling or Disabling Analysis After Acquisition* on page 79).
- reanalyze a trace acquired with a previous version of the software.
- update the events table of a trace, if you acquired that trace with an older version of the OTDR application.
- re-create the events table if it was modified.
- reset the span start to zero and the span end to end-of-fiber, unless you have saved them (see *Saving the Span-Start and Span-End Information* on page 87).
- perform a Pass/Fail test, if enabled (for more information, see *Setting Pass/Fail Thresholds* on page 80).

When you reanalyze a trace acquired in Template mode:

- Events copied from the reference trace (identified by “*”) will be lost.
- The application will assign a number to the events that were identified by question marks.

If you prefer to focus your analysis on a specific fiber span, see *Analyzing the Fiber on a Specific Fiber Span* on page 175.

Analyzing Traces and Events

Analyzing or Reanalyzing a Trace

To analyze or reanalyze a trace:

1. From the main window, select the **Graph** tab, then press the **Event** button.
2. Press the **Analyze** button.

Pass/Fail messages will be displayed if you selected that feature (see *Displaying or Hiding Pass/Fail Messages* on page 116).

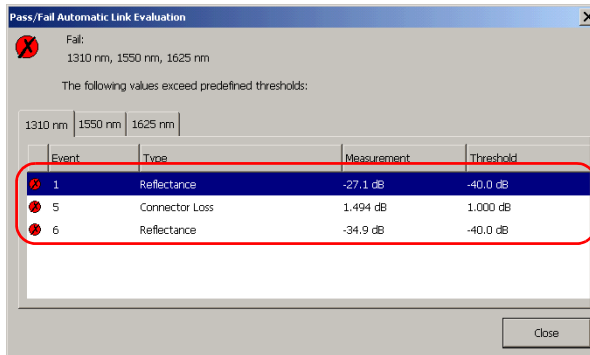

3. Press **Close** to return to the main window.

Analyzing the Fiber on a Specific Fiber Span

Note: *This function is available in Advanced mode only.*

If you want to focus your fiber analysis on a specific fiber span, you can define events (new or existing) as a span start and/or span end. You can even define a fiber span for short fibers by placing the span start and the span end on the same event.

Note: *You can set a default span start and end, which will be applied during the first analysis performed upon trace acquisition. Once the span is set, you can set the start and end data as default values.*

Analyzing Traces and Events

Analyzing the Fiber on a Specific Fiber Span

To set a fiber span:

1. From the main window, select the **Graph** tab, and press the **Span** button.
2. Select **Span Start** or **Span End** depending on the type of span event you want to create.

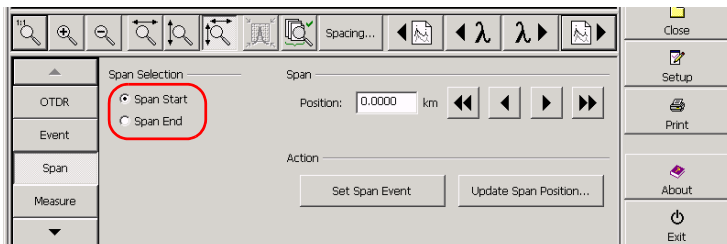

3. Define the span event location by moving marker **A** along the trace using one of the following methods:
 - Drag marker **A** to the desired span event location.
 - Enter a distance value in the **Position** box.
 - Use the single-arrow buttons to move marker **A** on the trace.
 - Use one of the double-arrow buttons to move marker **A** from event to event; this will designate an existing event as a span event.

Note: *Each of the first three elements may lead to the creation of a new event, except if your location corresponds to an already existing event on the trace.*

4. Press **Set Span Event** to set the span start or span end marker on the appropriate event in the trace display.



IMPORTANT

To keep a set fiber span during trace reanalysis, activate the fiber span delimitation memory (see *Saving the Span-Start and Span-End Information* on page 87). Otherwise, the span start and span end markers are reset to zero in the process.

5. If you want to define the new span start and/or end as the default values, press **Update Span Position**. The values will be transferred to the **Acquisition** tab of the **Setup** window. For more information, see *Setting a Default Span Start and Span End* on page 85.

Changes to the span start and span end will modify the contents of the events table. The span start becomes event 1 and its distance reference becomes 0. Only events between the span start and span end will be numbered in the trace display and Event table. The cumulative loss is calculated within the defined fiber span only.

Enabling or Disabling the Detection of Reflective Ends of Fiber

By default, the application stops the analysis as soon as there is too much noise on a trace to ensure accurate measurements. However, you can configure the application to search the “noisy” portion of the trace to detect strong reflective events (such as those caused by UPC connectors) and set the span end at this point.

If your OTDR model is FTB-7000D or later, you can configure the application to detect reflective ends of fiber.

Note: *The detection of reflective ends of fiber is only performed when you test at singlemode wavelengths.*

Once you have selected the option, the detection will be performed automatically on the next acquisitions.







If a trace was acquired without selecting the option first, you will have to reanalyze the trace manually (for more information on trace reanalysis, see *Analyzing or Reanalyzing a Trace* on page 173). When you reanalyze a trace, to benefit from the option, you should select *Reset span delimiter positions*.

The application will take into account the option only if there is a significant reflective event located after the end of analysis.

Analyzing Traces and Events

Enabling or Disabling the Detection of Reflective Ends of Fiber

The table below shows the differences you will notice in the event table depending on if you enable the detection of reflective ends of fiber or not.

Option not selected (conventional analysis)			Option selected	
Case	Event on which span end is set	Loss or reflectance value	Event on which span end is set	Loss or reflectance value
Span end located on a physical event that crosses the end-of-fiber (EoF) threshold	Non-reflective fault  or reflective fault 	Value as calculated by the conventional analysis	Same as the conventional analysis	Same as the conventional analysis
Span end located on a physical event whose loss is below the EoF threshold	Non-reflective fault  or reflective fault 	Value as calculated by the conventional analysis	If applicable, reflective fault  (located in the “noisy” area) ^a	If applicable, reflectance value as calculated by the conventional analysis. ^b
Span end not located on any physical event	End of analysis 	N/A	If applicable, reflective fault  (located in the “noisy” area) ^{c,d}	If applicable, reflectance value as calculated by the conventional analysis. ^b

- The cumulative loss value will remain the same for all elements appearing after the event on which the span end was set according to the conventional analysis. The span loss value (**Trace Info.** tab) will correspond to the loss calculated between span start and the event on which the span end was set according to the conventional analysis.
- Value is underestimated because the event is located in the “noisy” area.
- The end-of-analysis event is replaced by a non-reflective event  with a loss value of 0 dB.
- The cumulative loss value will remain the same for all elements appearing after the inserted event. The span loss value (**Trace Info.** tab) will correspond to the loss calculated between span start and the inserted event.

Analyzing Traces and Events

Enabling or Disabling the Detection of Reflective Ends of Fiber



IMPORTANT

The analysis will stop as soon as the loss of an event crosses the end-of-fiber (EoF) threshold. The application will mark the event as an end-of-fiber event.

In this case, even if you selected the option, the application *will not* search the “noisy” portion of the trace for reflective ends of fiber. If you want to do so, you will have to increase the EoF threshold (see *Setting the Analysis Detection Thresholds* on page 170).

To enable or disable the detection of reflective ends of fiber:

1. From the main window, press the **Setup** button.
2. From the **OTDR Setup** dialog box, go to the **Event Table** tab.
3. If you want to enable the option, under **End-of-Fiber parameters**, select the **Reflective end-of-fiber detection** box.

OR

If you prefer to disable the option, clear the box.

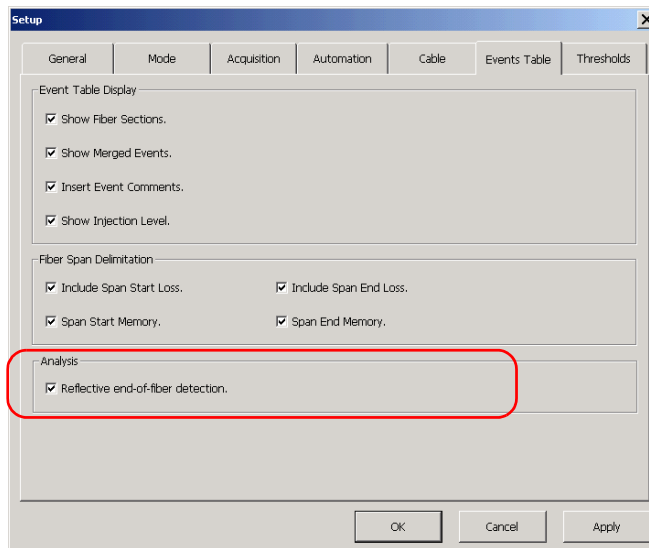

4. Press **Apply** to confirm the changes, then **OK** to return to the main window.

Entering Comments

Note: *This function can be used in Advanced mode only.*

Once you have acquired or opened a trace, you may wish to add comments to specific events. They will appear at the bottom of the events table whenever the specified event is selected. The comments will be saved and can be accessed or changed at any time by opening the trace file and performing the same procedure.

Note: *When you reanalyze the trace, all comments are kept, except those associated with events inserted manually.*

To enter comments:

1. Locate the event for which you want to enter comments. For more information, see *Event Pane* on page 134.
2. In the **Comment** box, enter comments about the specified event.

Note: *If the **Comment** box is hidden, see *Customizing the Event Table* on page 144.*

Opening Trace Files

You can open as many trace files as there is available memory, except in Template mode, which only allows you to open two files at a time (reference trace and main trace).

For the application, all trace files are equal. For this reason, if you want a particular trace to be considered as the reference trace, you must set it as such (see *Defining a Reference Trace* on page 187).

Note: *You cannot open bidirectional trace files in the OTDR test application. Use the Bidirectional Analysis utility instead (see Analyzing Bidirectional Traces on page 233).*

Analyzing Traces and Events

Opening Trace Files

When you open trace files, the application always displays the first wavelength of the file.

Type of file	Zoom	Marker
Trace that has been saved with an automatic zoom on the selected event ( button was pressed)	Application automatically zooms in on the event that was selected on the first trace (wavelength) of the file. If you switch to the next trace, the application will automatically zoom in on the event that was selected for the second trace.	Markers that are displayed correspond to those of the selected event.
Trace that has been saved with a manual zoom.	Application zooms in on the first trace (wavelength) of the file, according to the zoom area and zoom factor that were saved with the file. Application does not zoom in on the selected events. The same zoom will be applied to all traces.	Markers are displayed in the same state they were when you saved the file. Markers will remain at the same location even if you switch to another trace.
Old trace file	Traces are displayed in full view mode. The first event of the trace is selected.	Application defines default positions for markers.

If you want to keep the current zoom and markers, you must save your file before opening another one.

The application can open trace files saved in different formats, but does not necessarily allow all operations on them.

File format	File extension	Display	Modification	Reanalysis
Native	.trc	✓	✓	✓
Telcordia (Bellcore) EXFO version 100	.sor	✓	✓	✓
Telcordia (Bellcore) EXFO version 200	.sor	✓	✓	✓
FTB-100 version 2.7	.ftb100	✓	✓	✓
FTB-300	.ftb300	✓	✓	✓
Telcordia (Bellcore) non-EXFO version 100	.sor	✓	✗	✗
Telcordia (Bellcore) non-EXFO version 200	.sor	✓	✓	✗
NetTest (native)	---	✓	✗	✗

For detailed information on compatibility between EXFO's file formats and software versions, see *OTDR Trace File Compatibility* on page 208.

For information on the various criteria that are applied when loading traces in Template mode, see *Restrictions of Template Mode* on page 96.

For information on how to navigate between traces, see *Displaying or Hiding a Trace* on page 149.

Analyzing Traces and Events

Opening Trace Files

To open a trace file:

1. From the button bar, press **Open**.
2. From the list, select the desired file (ensure that it becomes highlighted).

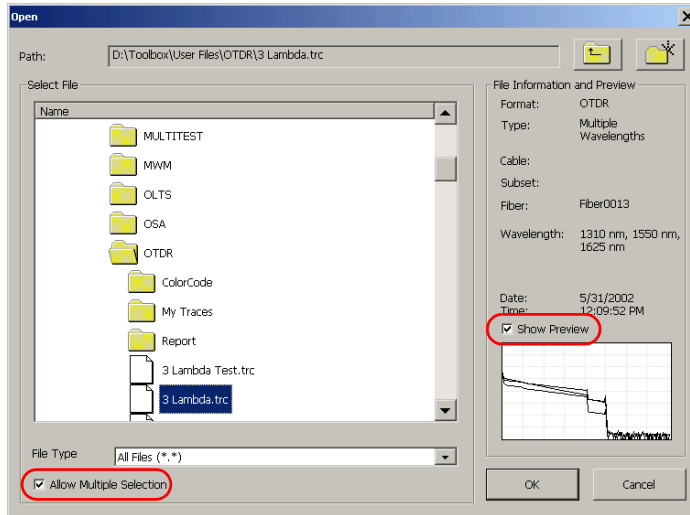

Note: You can select the **Show Preview** box to display an overview of the trace(s) to ensure you will open the appropriate file.

Note: You can load several files at the same time by selecting the **Allow Multiple Selection** box before choosing the files from the list (all the selected files will become highlighted).

3. Press **OK**.

Defining a Reference Trace

A reference trace is used to compare fibers within the same cable, monitor fiber deterioration or compare fibers before and after installation. Once a trace file has been opened, you can define it as the reference trace. The application will then display it, in red, on the graph.

There is only one reference file open at a time. A trace cannot be a reference and a main (current) trace at the same time.

A reference trace can be defined in both Advanced and Template modes.

- In Template mode, the reference definition is automatic. To be able to select Template mode, at least one trace must be already loaded. Consequently, as soon as you select this mode, the application automatically sets the loaded trace as the reference.

If several traces are loaded when you select Template mode, the application will prompt you to identify which file you want to use as a reference. All other files will be closed (you will be asked to save any file that has been modified).

In Template mode, you cannot directly remove the reference state from a file. You will have to switch to Advanced mode to remove it.

- In Advanced mode, the reference definition is manual.

Analyzing Traces and Events

Defining a Reference Trace

To define a reference trace manually:

1. Load the trace you want to use as the reference trace (see *Opening Trace Files* on page 183).
2. From the main window, select the **Result** tab.
3. Select the trace you want to use as reference (ensure that it is highlighted) and press **Set as Reference**.

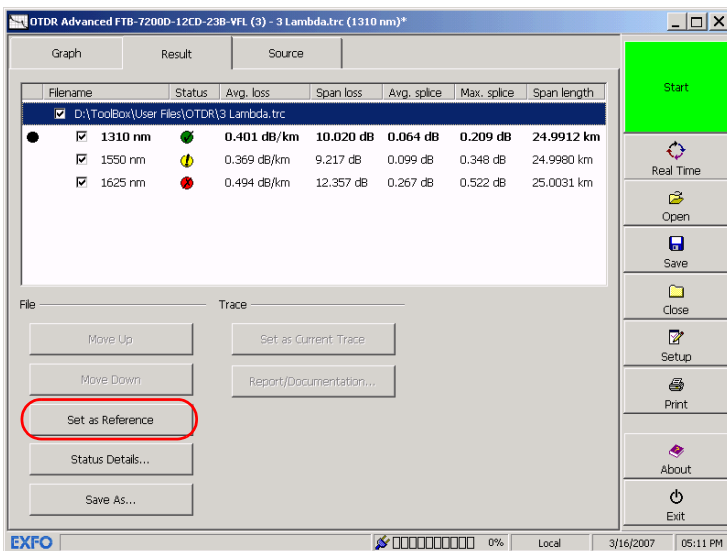

The name of the file set as reference is displayed in red and ♦ appears to its left.

Note: If you want to remove the reference state, simply press the **Remove Reference State** button.

10 Analyzing the Results Manually

Once a trace has been acquired or opened, you can use markers and zoom in on or out of any event or trace segment to measure splice loss, fiber section attenuation, reflectance, and optical return loss.

Selecting the Attenuation and Loss Values that Will Be Displayed

By default, in the **Measure** tab, the application only displays the values obtained by using the same measurement methods as the analysis, that is the four-point event loss and the A-B LSA attenuation.

Note: *This function is available in Advanced mode only.*

You can display the values corresponding to the following measurement methods:

- For loss:
 - Four-point event loss
 - A-B LSA (Least-Square Approximation) loss
- For attenuation:
 - Two-point section attenuation
 - A-B LSA (Least-Square Approximation) attenuation

Note: *You must select at least one measurement method for loss value and one measurement method for attenuation value.*

Analyzing the Results Manually

Selecting the Attenuation and Loss Values that Will Be Displayed

To select the attenuation and loss values that will be displayed:

1. From the button bar, press **Setup** then go to the **General** tab.
2. Press the **Measurement Method** button.
3. Select which values you want to see in the **Measure** tab.

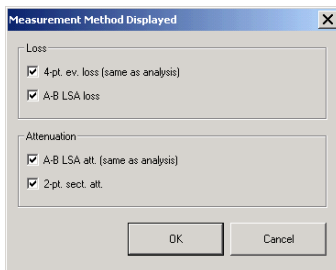

Press **OK** to confirm your selection.

4. Press **OK** to return to the main window.

Using Markers

You can use markers to view the position and relative power of an event.

Markers are available when you press **Measure** from the main window, as well as in the Change and Insert windows, accessible from the **Event** pane.

To move a marker:

1. Press the button corresponding to the marker you want to move.
2. Once the appropriate marker is selected, use the right and left arrow buttons to move the marker along the trace.

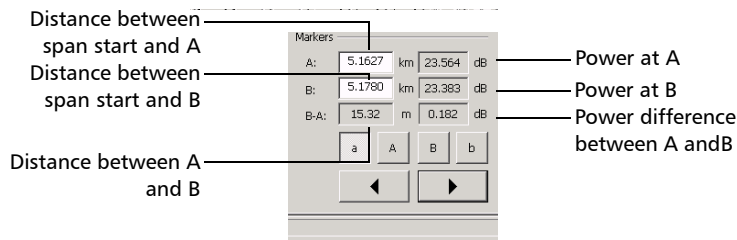

Note: You can also select the marker directly on the trace display and drag it to the desired position.

If a marker is moved close to another, both will move together. This ensures a minimum distance is maintained between markers.

A marker may disappear from the trace after you zoom in (see *Using Zoom Controls* on page 139). You can recall it by selecting the button corresponding to the missing marker and by using one of the arrows to bring the selected marker back into the displayed area.

Analyzing the Results Manually

Getting Event Distances and Relative Powers

Getting Event Distances and Relative Powers

The OTDR test application automatically calculates the position of an event and displays this distance in the events table.

You can retrieve the position of an event as well as the distance between events manually. You can also display various relative power readings.

Distances and relative powers correspond to the X-axis and Y-axis, respectively.

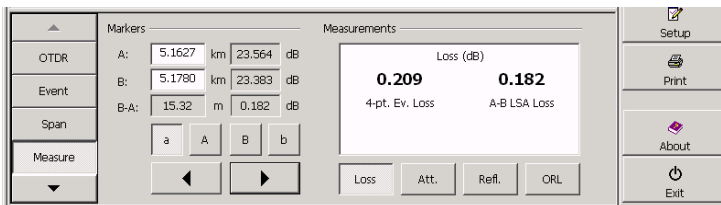

To get the distance to an event and the associated relative power level:

1. From the main window, select the **Graph** tab and press the **Measure** button.
2. Move marker **A** to the beginning of the event. For more information about markers, see *Using Markers* on page 191.

Getting Event Loss (Four-Point and Least-Square Approximation)

Event loss (expressed in dB) is calculated by measuring the signal level reduction in Rayleigh backscatter (RBS) caused by this event. Event loss can result from both reflective and non-reflective events.

Two loss calculations are provided simultaneously: the four-point event loss and the A-B LSA loss. Both calculations use the least-square approximation (LSA) method to determine the event loss. *However, the four-point event loss is the preferred method and the one that corresponds to the loss displayed in the events table.*

Analyzing the Results Manually

Getting Event Loss (Four-Point and Least-Square Approximation)

- *Four-point event loss*: the LSA method is used to fit a straight line to the backscatter data within the two regions defined by markers a, A and b, B, that is over the regions to the left and to the right of the event bordered by markers A and B, respectively.

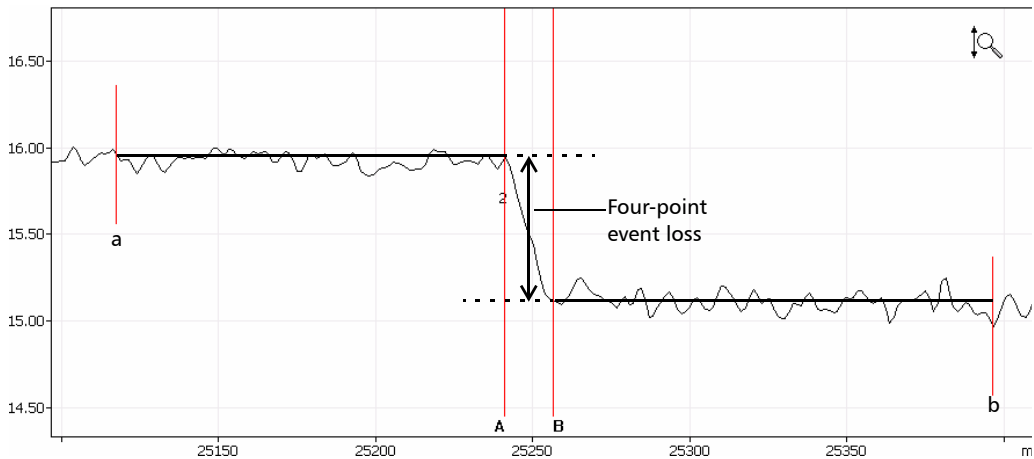

The two fitted lines are then extrapolated toward the center of the event and the loss event is directly read from the drop in power between the two lines.

Analyzing the Results Manually

Getting Event Loss (Four-Point and Least-Square Approximation)

- *A-B LSA loss*: the loss of the event bordered by the markers A and B is obtained by fitting a straight line to the backscatter data between these two markers.

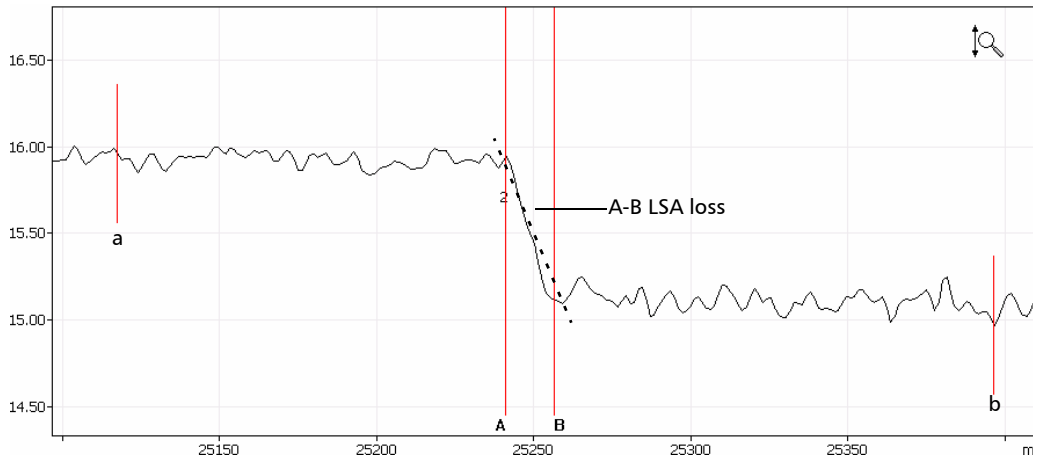

The event is then obtained by the reduction in power (dB) over the distance between the two markers, as calculated from the slope of the fitted line.

Although this method works fairly well for splice loss, it is clearly not appropriate for reflective events (definitely not a “straight-line” event). A-B LSA Loss is mainly used to rapidly compute loss over a given length of a fiber section.

Note: *A-B LSA event loss measurements should be used on fiber sections only. Measuring events will not yield meaningful results.*

Analyzing the Results Manually

Getting Event Loss (Four-Point and Least-Square Approximation)

To get event loss:

- 1.** From the main window, go to the **Graph** tab and press the **Measure** button.
- 2.** In the **Measurements** section, press **Loss**. Markers **a**, **A**, **B** and **b** appear on the graph.
- 3.** Zoom in and position marker **A** at the *end* of the linear area *preceding* the event to be measured. For more information, see *Using Zoom Controls* on page 139 and *Using Markers* on page 191.
- 4.** Position submarker **a** at the *beginning* of the linear area *preceding* the event to be measured (must not include any significant events).

Analyzing the Results Manually

Getting Event Loss (Four-Point and Least-Square Approximation)

5. Position marker **B** at the *beginning* of the linear area *following* the event to be measured.
6. Position submarker **b** at the *end* of the linear area *following* the event to be measured (must not include any significant events).

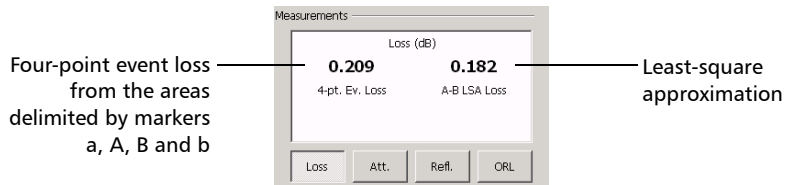
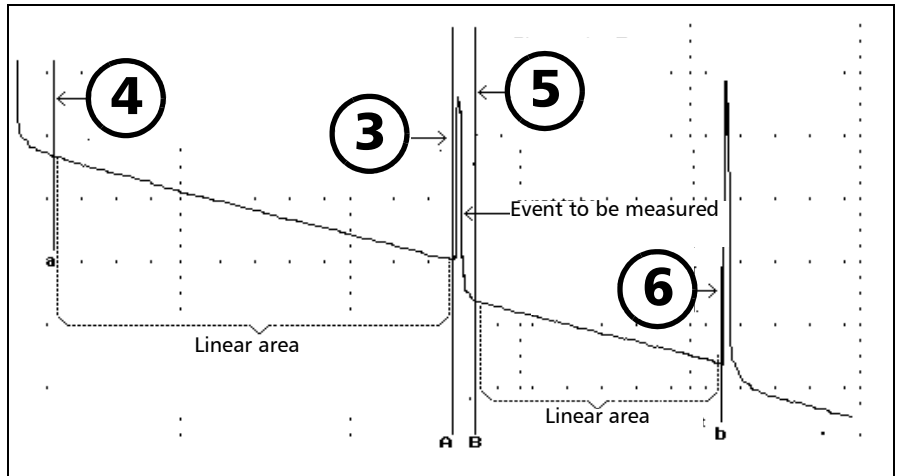

Getting Attenuation (Two-Point and Least-Square Approximation)

A two-point attenuation measurement gives the reduction in Rayleigh backscatter level as a function of distance (always expressed in dB/km to follow the standards of the fiber-optic industry) between two selected points. Only those two points are used to perform the calculation and there is no averaging.

The least-square approximation (LSA) method measures the attenuation (loss over distance) between two points by fitting a straight line in the backscatter data between markers **A** and **B**. The LSA attenuation corresponds to the difference in power (Δ dB) over the distance between two points.

The LSA method, when compared to the two-point method, gives an average measurement and is more reliable when there is a high level of noise. However, it should not be used if an event such as an echo appears between the two markers.

Analyzing the Results Manually

Getting Attenuation (Two-Point and Least-Square Approximation)

To get attenuation:

1. From the main window, go to the **Graph** tab and press the **Measure** button.
2. In the **Measurements** section, press the **Att.** button. Markers **A** and **B** appear on the graph.
3. Place markers **A** and **B** at any two points on the trace. For more information, see *Using Markers* on page 191.
4. Zoom in on the trace and fine-tune the marker positioning if necessary. For more information, see *Using Zoom Controls* on page 139.

Note: *There should not be any events between markers A and B when performing the two-point attenuation measurement.*

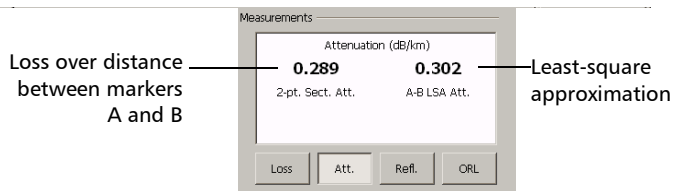

Getting Reflectance

Reflectance is the ratio of reflected light to input light.

Note: *When performing reflectance measurements on recalled traces from non-EXFO test equipment that were saved in Telcordia (Bellcore) format, the results displayed could be less accurate than with EXFO file format.*

To get reflectance:

1. From the main window, go to the **Graph** tab and press the **Measure** button
2. In the **Measurements** section, press the **Refl.** button. Markers **a**, **A** and **B** appear on the graph.
3. Zoom in and position marker **A** on the linear area *preceding* the event to be measured. For more information, see *Using Zoom Controls* on page 139 and *Using Markers* on page 191.
4. Position submarker **a** at the beginning of the linear area *preceding* the event to be measured.
5. Position marker **B** at the *peak* of the reflective event to be measured.

Note: *Using this procedure, you can measure the reflectance of all the events in a merged reflective fault event.*

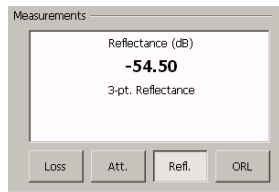

Note: *For non-reflective events, ***** will be displayed.*

Getting Optical Return Loss (ORL)

Note: You must use a singlemode OTDR for ORL calculations. The ORL measurement may not be displayed if the acquisition was obtained with older OTDR modules.

The ORL calculation will provide the following information:

- the ORL between markers **A** and **B**
- the total ORL is calculated between the span start and the span end

Optical return loss (ORL) refers to the total effect of multiple reflections and scattering events within a fiber-optic system.

To get the ORL value:

1. From the main window, go to the **Graph** tab and press the **Measure** button.
2. In the **Measurements** section, press **ORL**. Markers A and B appear on the graph.

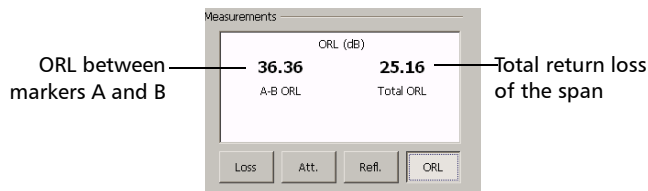

3. Position markers A and B to delimit the area for which you want to know the ORL value.

11 ***Managing Trace Files***

Once you have acquired traces, or when you want to work with them after an acquisition, you will need to save, open, rename, and delete trace files.

Saving a Trace in a Different Format

By default, the application saves the traces in EXFO format (.trc). However, you can configure the application to save traces directly in other formats (see *Selecting the Default File Format* on page 111).

For a list of file formats that can be loaded, modified or reanalyzed with the application, see *Opening Trace Files* on page 183.

Managing Trace Files

Saving a Trace in a Different Format

File format	File extension	Description
Native	.trc	Compatible with ToolBox version 6.21 or later, the FTB-400 platform, the FTB-200, FTB-150, and AXS-100 Series units. For more information, see <i>OTDR Trace File Compatibility</i> on page 208.
ToolBox 6.7 - 6.20	.trc	Compatible with ToolBox version 6.7 or later, the FTB-400 platform, the FTB-200, FTB-150, and AXS-100 Series units. For more information, see <i>OTDR Trace File Compatibility</i> on page 208.
Telcordia (Bellcore) version 100 and Telcordia (Bellcore) version 200	.sor	<ul style="list-style-type: none">▶ Compatible with the standard Telcordia (Bellcore) OTDR record format.▶ A Telcordia (Bellcore) trace recalled on a non-EXFO OTDR that is Telcordia-compatible (SOR format) will display only the data required for Telcordia (Bellcore). The same Telcordia (Bellcore) trace recalled on an EXFO OTDR will display full trace data.▶ If the original file has more than one wavelength, the application will generate a .sor file for each of them.
FTB-100 version 2.7	.ftb100	Compatible with all versions of the FTB-100B Mini-OTDR.

File format	File extension	Description
FTB-300	.ftb300	<ul style="list-style-type: none">▶ Compatible with ToolBox 5 and the FTB-300 UTS, as well as with all versions of ToolBox 6.▶ If the original file has more than one wavelength, the application will generate a .trc file for each of them.
ASCII	.asc	A 500-point trace with all acquisition parameters in ASCII format
ASCII+	.asc	Contains all OTDR acquisition points (8000 to 128 000 points) with all acquisition parameters in ASCII format.



IMPORTANT

Once a trace is stored in ASCII format, you cannot recall it as a trace in the OTDR. Therefore, save the trace in the default EXFO OTDR format first.

Note: *Changing the file extension from Windows Explorer does not change the file format of EXFO OTDR traces. You must use the application to save your files.*

Managing Trace Files

Saving a Trace in a Different Format

To save a file in another format:

1. From the main window, select the **Result** tab and, from the list, select the file you want to save in another format (ensure that it is highlighted).

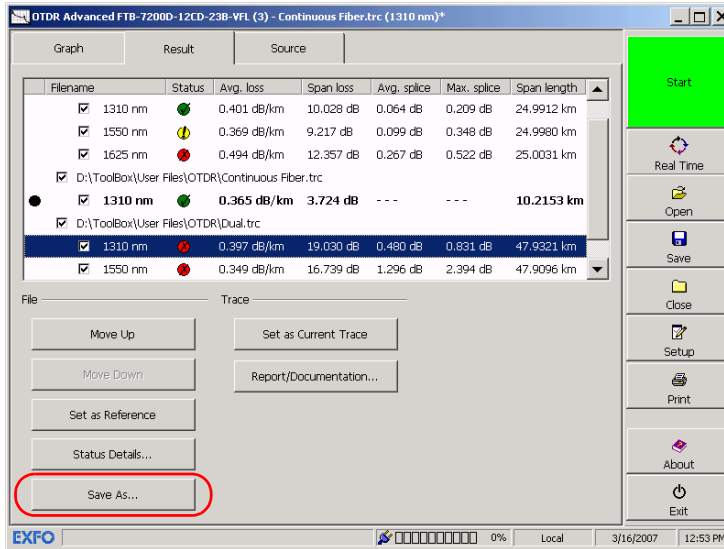

2. Press **Save As**.

3. From the **Save as** dialog box, select the desired file format.

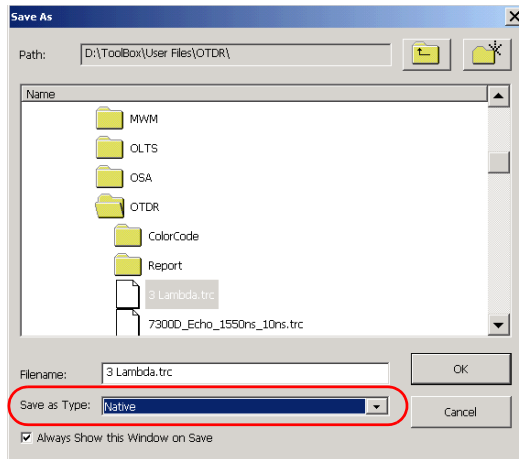

If necessary, change the file name appearing in the corresponding box.

4. Press **OK** to save the file in the selected format.

OTDR Trace File Compatibility

The table presented hereafter shows the compatibility between the format of a specific trace and the software that you may use to open that trace.

Symbols used in the table	Meaning
✓	Fully compatible
Conv	Conversion or reanalysis necessary
×	Not compatible

Software used to open the file...								
		ToolBox 5.5	ToolBox 6.5 or earlier	ToolBox 6.7 to 6.20	ToolBox 6.21 or later	FTB-100 2.5 or earlier	FTB-100 2.6 or 2.7	FTB-100 2.8 or later/ FTB-150 FTB-200 AXS-100
File generated with...	ToolBox 5.5	X	X	X	X	Conv ^a	Conv ^a	Conv ^a
	ToolBox 6.5 or earlier	Conv ^b	X	X	X	Conv ^a	Conv ^a	Conv ^a
	ToolBox 6.7 to 6.20	Conv ^c	Conv ^c	X	X	Conv ^{a,d}	Conv ^a	Conv ^a
	ToolBox 6.21 or later	Conv ^c	Conv ^c	Conv ^{f,e}	X	Conv ^{a,d}	Conv ^a	X
	FTB-100 2.2 or earlier	X	X	X	X	X	X	X
	FTB-100 2.5		X	X	X	X	X	X
	FTB-100 2.6 or 2.7			X	X	X	X	X
	FTB-100 2.8 or later/ FTB-150 FTB-200 AXS-100			Conv ^{e,f}	X	Conv ^{a,d,f}	Conv ^{a,d,f}	X

- a. Should be saved in or converted to FTB-100 (.ftb100) format.
- b. Should be reanalyzed to view the events table.
- c. Data should be saved in FTB-300 (.ftb300) format and reanalyzed to view the events table.
- d. Triple-wavelength trace files are not compatible.
- e. Should be converted to ToolBox 6.7-6.20 format.
- f. Should be converted with ToolBox 6.21 or later.

Managing Trace Files

Copying, Moving, Renaming, or Deleting Trace Files

Copying, Moving, Renaming, or Deleting Trace Files

If you want to copy, move, rename, or delete trace files, you will have to process the files manually via Windows Explorer available from **ToolBox > Utilities**. For more information, refer to the *FTB-400 Universal Test System* user guide and Microsoft Windows Help.

12 **Creating and Printing Trace Reports**

For future reference, you can add notes on the location and identification of the tested fiber, type of job performed and general comments related to a trace in trace reports. You can specify which information must be included in your printed documents.

You can recall a trace in the OTDR application, modify the related information and save the changes with the trace.

Editing information from the **Report** window does not automatically change the setups on the **Cable** tab of the **Setup** dialog box. Furthermore, it does not automatically update the information in traces that have been generated, if they are not currently loaded in the test application except when operating in Template mode.

You can save the newly entered information to the cable setup. You can also recall the default information from the cable setup and save it in the open trace.

Adding Information to the Test Results

After acquiring a trace, you might want to include or update information about the tested fiber and job or add comments. The information you enter is saved only for the currently open trace file.



IMPORTANT

From the Report/Documentation window, you can modify information before printing a report.

However, this information will **NOT** be used for future acquisitions automatically. If you want to enter information that will be used for future acquisitions, see *Defining Cables* on page 26.

Note: *The information must be entered before acquiring traces in Template mode. For more information, see Testing Fibers in Template Mode on page 95.*

Note: *You can view traces from non-EXFO test equipment that were saved in the Telcordia (Bellcore) format. However, you cannot create reports with these traces or add report information to them.*

To speed up the documentation process, you can recall the information from the cable setup (**Cable** tab of the **Setup** dialog box).

You can also use the new information you enter to modify the cable setup so that this information could be applied to all new traces.

For more information about cable parameters to be applied to all newly acquired traces or the autonaming options, see *Defining Cables* on page 26.

Some of the information is common to all wavelengths (location A and B, cable ID and fiber ID). Some other is specific to the current wavelength (job ID, customer and comments). If you clear information from the **Report** window, both the common and the specific information will be deleted. The information specific to other wavelengths will not be deleted (you must delete it manually).

Creating and Printing Trace Reports

Adding Information to the Test Results

To add information to the test results:

1. From the main window, once a trace has been acquired or reopened, select the **Result** tab.
2. From the trace list, select the desired trace and press **Report/Documentation**.

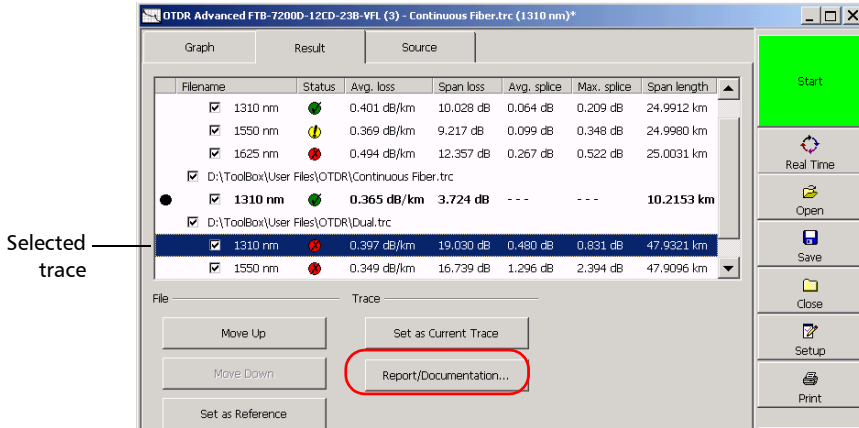

3. Select one of the tabs (**Fiber**, **Job**, or **Comments**) and enter information in the appropriate boxes.

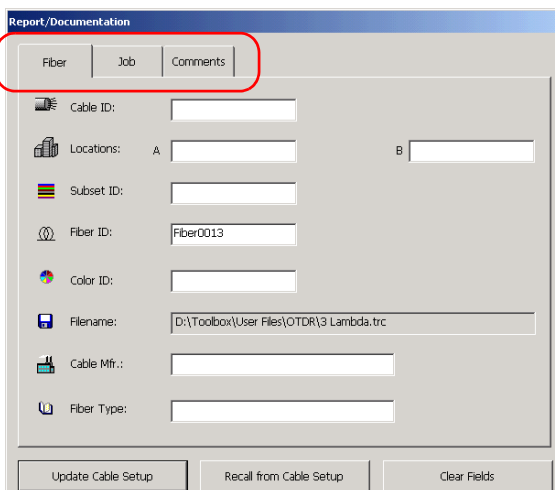

The screenshot shows a dialog box titled "Report/Documentation" with three tabs: "Fiber", "Job", and "Comments". The "Fiber" tab is selected and highlighted with a red circle. Below the tabs are several input fields with icons to their left:

- Cable ID: [Empty text box]
- Locations: A [Empty text box] B [Empty text box]
- Subset ID: [Empty text box]
- Fiber ID: [Text box containing "Fiber0013"]
- Color ID: [Empty text box]
- Filename: [Text box containing "D:\Toolbox\User Files\OTDR\3 Lambda.trc"]
- Cable Mfr.: [Empty text box]
- Fiber Type: [Empty text box]

At the bottom of the dialog are three buttons: "Update Cable Setup", "Recall from Cable Setup", and "Clear Fields".

Note: *The information in the **Test Date**, **Test Time**, **Unit A**, and **Serial Number A** boxes is provided by the application and cannot be edited.*

4. Press **OK** to confirm and return to the main window.

The information is saved with the trace and can be viewed or changed at any time.

Creating and Printing Trace Reports

Adding Information to the Test Results

To clear all the information from tab:

Press the **Clear Fields** button.

To retrieve information from the cable window:

Press **Recall from Cable Setup**.

To transfer the new information to the cable setup:

Press **Update Cable Setup**.

Note: *You can also update the cable setup with report information recorded in recalled traces from non-EXFO test equipment saved in Telcordia (Bellcore) format.*

Customizing the Report

You can customize your report before printing it by specifying which type of document you want, which information will appear in your report and in what order. You can even insert or remove page breaks between sections.

If you choose the compressed format, you cannot insert page breaks between sections.

If you choose the multitrace format, you cannot remove sections from the report or insert page breaks between sections. In this format, traces are included automatically in the report. However, you can select which of the marker information or the link measurements, will appear in the printed document.

By default, the report contains a header that can include only the default “OTDR Report” title or other items such as the file name or the test date.

You can also add a footer to your document. Unless you specify that you prefer to see only the page number, the following elements are added to the bottom of the pages:

- a space for a signature
- the printing date and the page number

Note: *Most of the information presented hereafter also applies to bidirectional traces (Bidirectional Analysis tool). However, some items, such as the multitrace report format, are not available with the Bidirectional Analysis tool.*

Creating and Printing Trace Reports

Customizing the Report

The application offers the following types of reports:

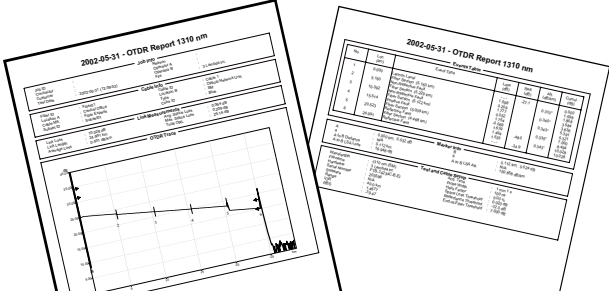
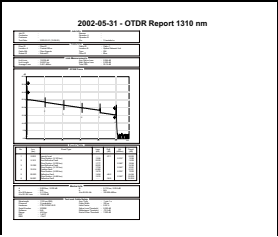
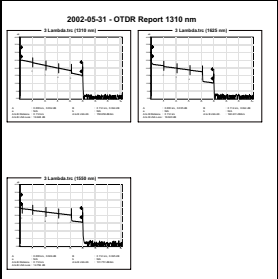
Report format	Sample
Normal	
Compressed ^a	
Multitrace ^{a,b}	

- a. Not available with the GP-273 printer module.
- b. Not available for bidirectional traces.

The following table shows the various items that can appear on a report:

Item appearing on the report	Summarized	Compressed	Multi-trace
Job information: test date and time (including the time zone), unit serial and model numbers, job and customer ID.	X	X	
Cable information: a single table containing information such as the fiber ID, cable ID, location A and B.	X	X	
Link measurements: link length and loss, average loss, splice loss, and span ORL.	X	X	
Trace	X	X	X
Event table (with fiber sections): If you configured the application to display fail or warning results (from the Setup window), the failed results will appear in white on a black background. The results with a warning status will appear in black on a white rectangle (GP-273 printer module) or on a grey background (all other printers). Otherwise, results having a fail or a warning status will not be “highlighted”.	X	X	
Pass/Fail thresholds: loss, reflectance, fiber section attenuation thresholds as they are defined in Setup (Thresholds) tab. Note: <i>Selecting this item will not highlight the results having a fail or warning status in the report. You must select Fail or Warning in the Setup and include the Event table item in your report.</i>	X	X	

Creating and Printing Trace Reports

Customizing the Report

Item appearing on the report	Summarized	Compressed	Multi-trace
Marker information: a, A, b, B, and A to B distances, as well as A to B attenuation, loss, and ORL. This item is not available in Auto mode.	X	X	X
Test and cable setup for main and reference traces: file name, OTDR model, software version, wavelength, distance, IOR, RBS, acquisition time, pulse width, and helix factor. In Template mode, only the information of the current trace will be printed.	X	X	
Comments By default, this item is selected.	X	X	

To customize your report:

1. From the main window, press the **Print** button.
2. From the **Print Configuration** dialog box, select the **Report** tab.
3. From the **Format** list, select the desired type of report.

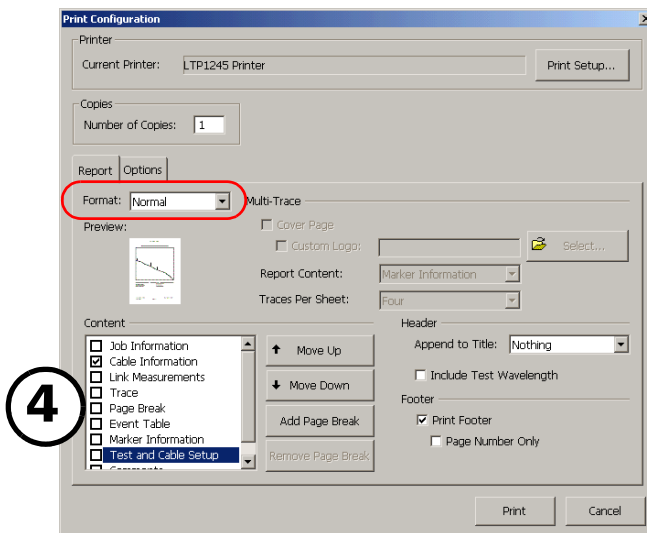

4. From the **Content** list, select all the boxes corresponding to the sections you want to include in your report.

You can remove any unwanted section by clearing the corresponding boxes.

Note: *You cannot remove sections of a multitrace report.*

Creating and Printing Trace Reports

Customizing the Report

5. If you selected the **Multi-Trace** format, from the **Report Content** list, select the section you want to include in the report.

The screenshot shows the 'Multi-Trace' configuration dialog. The 'Format' is set to 'Multi-Trace'. The 'Cover Page' section is highlighted with a red box and contains the following options:

- Cover Page
- Custom Logo: \\Spqc\fs01\Mar\7000 et f (with a 'Select...' button)
- Report Content: Marker Information (dropdown)

Other settings include:

- Traces Per Sheet: Four (dropdown)
- Header: Append to Title: Nothing (dropdown)
- Include Test Wavelength
- Footer: Print Footer, Page Number Only
- Content list: Trace, Marker Information
- Buttons: Move Up, Move Down, Add Page Break, Remove Page Break

6. If necessary, rearrange the order of appearance of the various sections.
 - 6a. From the **Content** list, select the section to move (ensure that the item is highlighted).
 - 6b. Use the **Move Up** and/or **Move Down** buttons.

Note: You cannot rearrange the order of sections of a multitrace report.

7. If you selected the **Normal** format and you want to add or remove gadd or remove page breaks, proceed as follows

To add a page break, from the **Content** list, select the section *before* which you want to insert a page break (ensure that the item is highlighted) and press **Add Page Break**.

OR

To remove a page break, from the **Content** list, select the page break to remove (ensure that the item is highlighted) and press **Remove Page Break**.

Note: *You cannot add or remove page breaks in compressed or multitrace reports.*

8. If necessary, you can add an item to the default title of your report by selecting the desired item from the **Append to Title** list.

You can also include the test wavelength by selecting the **Include Test Wavelength** box.

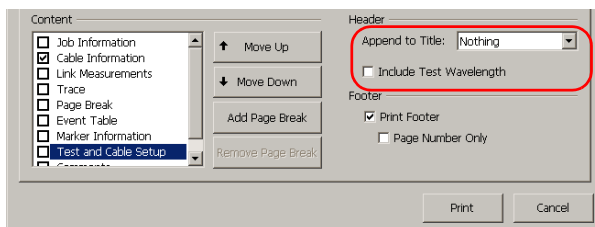

Creating and Printing Trace Reports

Customizing the Report

9. If necessary, you can add a footer to your report by selecting the **Print Footer** box.

If you prefer not to see the printing date, select the **Page Number Only** box.

10. If you selected **Multi-Trace**, you can also:

- Add a cover page to your report by selecting the **Cover Page** check box. You can include a logo on this cover page by pressing the **Select** button and select the logo file.

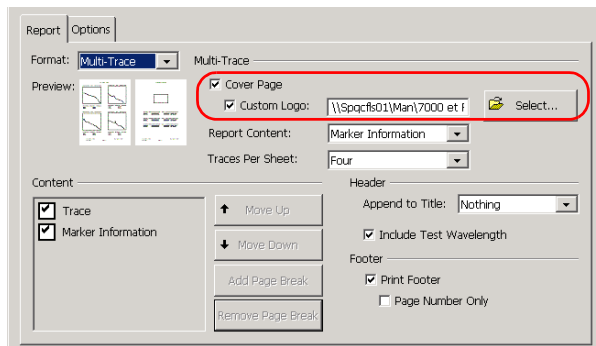

- Select how many traces should be displayed per page by selecting the desired value in the **Traces Per Sheet** box.

11. If desired, you can set various parameters that will determine the way graphs and/or event tables will be printed.

11a. Press the **Options** tab.

11b. Select the boxes corresponding to the items you wish to activate.

- By default, the Bidirectional Analysis tool only prints the bidirectional trace. However, if you also want to print the original A->B and B->A traces, select the **Print AB and BA Traces** box.
- Select the **Print Event Table between Spans** box to print information related to the fiber span you have set.

Note: *In the Bidirectional Analysis tool, this option is only available if you selected the **Print AB and BA Traces** box.*

- You can select the **Print with zoom** item if you want the traces to be printed with the zoom factor you selected:

Manual zoom: Graphs will be printed exactly as they appear on screen. The same zoom factor will be applied to all traces (wavelengths) of a particular file.

Zoom on selected event: Graphs will be printed with zoom on the area corresponding to the selected event (one event per trace, that is, one per wavelength).

- Select the **Print with markers** box to include the A and B markers on the graph.

Note: *If you want to view a table containing the positions of all markers, from the **Report** tab (of the **Print Configuration** window), select the **Marker Information** box to include this section in your document.*

- Select the **Print Reference in Graph** box to include the trace that you set as reference in the printed graphs (see *Defining a Reference Trace* on page 187). The reference trace will appear in gray and the other traces in black.

You are now ready to specify the printing options and to launch the printing. For more information, see *Printing a Report* on page 226.

Printing a Report

Once you have entered information about the test and customized your report, you can print your report. For more information, see *Adding Information to the Test Results* on page 212 and *Customizing the Report* on page 217.

You can specify which traces you want to print:

- **Print All Traces:** to print all the traces that are loaded in the application. Each open file will generate a distinct report.
- **Print Visible Traces:** to print all the traces that are selected in the **Result** tab of the main window (see *Displaying or Hiding a Trace* on page 149).
- **Print Current Trace:** to print the trace identified as the current trace (selected wavelength) in the **Result** tab of the main window (see *Displaying or Hiding a Trace* on page 149).
- **Print Current Fiber:** to print all the traces associated with the current fiber (one trace per wavelength). The current fiber corresponds to the fiber associated with the current trace in the **Result** tab of the main window (see *Displaying or Hiding a Trace* on page 149).

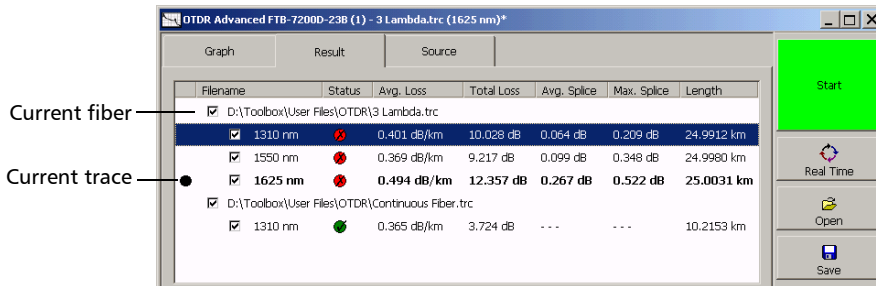

Note: These options are not available for bidirectional traces (*Bidirectional Analysis tool*).

To print your report:

1. From the main window, press **Print**.
2. If necessary, from the **Print Configuration** window, press the **Print Setup** button to change the current printer and its parameters.

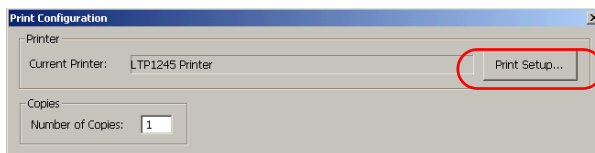

3. In the **Number of Copies** box, enter the desired value.
4. From the **Print Range** section, select the box corresponding to the traces you want to print.
5. Press **Print**.

The application will keep in memory the items you have included in your reports for future use.

13 Using the OTDR as a Light Source or VFL

Note: This function is available in Advanced mode only.

- If you want to perform measurements with a power meter and your OTDR as a source, the OTDR port can transmit a special tone. This port can be used only to transmit—not detect that tone.

You can also activate the auto-off feature that will stop the light emission automatically after the specified lapse of time.

- The Visual Fault Locator (VFL) option is used to set the OTDR to send a red signal along the fiber, which can be used for visual fault location and fiber identification.

Note: The VFL option will be available only if your OTDR is equipped with a VFL port.



CAUTION

Never connect a live fiber to the OTDR port without a proper setup. Any incoming optical power ranging from -65 dBm to -40 dBm will affect the OTDR acquisition. The way the acquisition will be affected depends on the selected pulse width.

Any incoming signal greater than -20 dBm could damage your OTDR permanently. For live-fiber testing, refer to the SM Live port specifications for the characteristics of the built-in filter.

Using the OTDR as a Light Source or VFL

To use your OTDR as a source:

1. Clean the connectors properly (see *Cleaning and Connecting Optical Fibers* on page 24).
2. Connect one end of the fiber under test to the OTDR port.

If your unit is equipped with two OTDR ports, ensure that you connect the fiber to the appropriate port (singlemode, singlemode live, or multimode), depending on the wavelength you intend to use.

3. From the main window, go to the **Source** tab. Ensure that **Wavelength** is selected.
4. From the **Wavelength** box, select the wavelength you want to use.

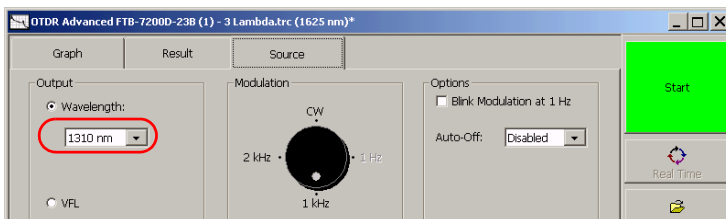

Note: *If only one wavelength is available, it is selected by default.*

5. Select the desired modulation.

With the **Modulation** dial,

- For loss measurement, with a power meter at the other end, select **CW** (to set the source to continuous output).
- For fiber identification, select **1 kHz** or **2 kHz**. This will allow the person at the other end of the link to identify the fiber under test, which could be particularly useful when working with cables containing many fibers.

For easier fiber identification, the application also offers a flashing pattern. If you select this pattern, the modulated signal (1 KHz or 2 KHz) will be sent for 1 second, then will be off for the next second, then be sent again for 1 second, and so on. If you want the OTDR to emit light in a flashing pattern, select the **Blink Modulation at 1 Hz** box.

6. From the **Auto-Off** box, select the duration after which you want the laser to shut off. If you want to deactivate the automatic shut-off, simply select **Disabled**.

7. Press **Start**. You can stop light emission at any time by pressing **Stop**.

Using an EXFO power meter with tone-detection features, such as the FOT-930 or FPM-300, an operator at the other end will be able to quickly locate the correct fiber or perform loss measurements. Refer to the power meter user guide for details.

Using the OTDR as a Light Source or VFL

To identify fiber faults visually:

1. Clean the connectors properly (see *Cleaning and Connecting Optical Fibers* on page 24).
2. Connect the fiber under test to the VFL port.
3. From the main window, go to the **Source** tab, then select **VFL**.

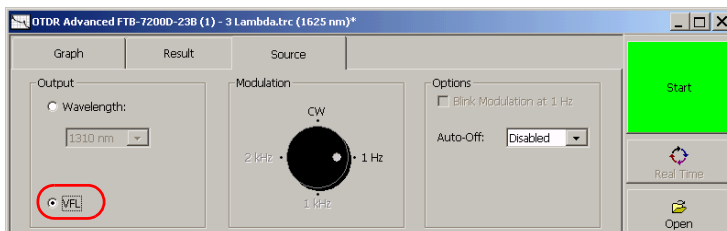

4. With the **Modulation** dial, select **1 Hz** or **CW**. Choose **1 Hz** to set the VFL to 1 Hz pulsed output, and **CW** to set it to a continuous output.
5. From the **Auto-Off** box, select the duration after which you want the laser to shut off. If you want to deactivate the automatic shut-off, simply select **Disabled**.
6. Press **Start** to send the VFL signal. You can stop the VFL signal emission at any time by pressing **Stop**.

14 Analyzing Bidirectional Traces

Note: *The OTDR Bidirectional Analysis utility is available only from the ToolBox's Work on Results function tab*

If two OTDR traces are acquired in opposite directions on the same fiber span, the OTDR Bidirectional Analysis utility allows you to match the corresponding events.

The application performs a bidirectional analysis and generates an events table with the averaged loss for each event; that is, the average of the losses obtained from both directions.

Bidirectional analysis is the recommended method for splice loss measurements on singlemode fibers by the Telecommunications Industry Association (test procedure *EIA/TIA FOTP-61 Measurement of Fiber or Cable Attenuation Using an OTDR*).

This method removes the so-called “gainers” (increase in the optical power) and exaggerated losses and provides accurate measurements. This analysis is particularly useful to test the quality of a link, especially if it comprises several sections with different types of fibers or fibers from different manufacturers.

Gainers and exaggerated losses result from the joining of two fibers of different mode-field diameters (MFD). The mode-field diameter of a fiber corresponds to the size of the area where light is dispersed across its core and cladding.

Mismatch of MFDs will contribute to differences in backreflected signal that are not related to the loss at the splice point, that is to the true loss seen in transmission. In this case, a unidirectional OTDR trace will show an apparent increase (gainer) or decrease (exaggerated loss) in signal, depending on the direction of measurement.

Bidirectional averaging of OTDR splice loss measurements provides the most accurate splice loss results.

You can also analyze OTDR traces that use a multiwavelength feature.

To work with the OTDR Bidirectional Analysis utility, you must acquire and save the traces before the analysis.

Starting and Exiting the Bidirectional Analysis Utility

To start the Bidirectional Analysis utility:

1. From ToolBox, press the **Work on Results (Offline)** function tab.
2. Go to the **OTDR** tab, then press the **Bidirectional Analysis** button.

The main window is displayed. If you are using this utility for the first time, or if you have closed the files before exiting last time you used the utility, no trace will be automatically loaded.

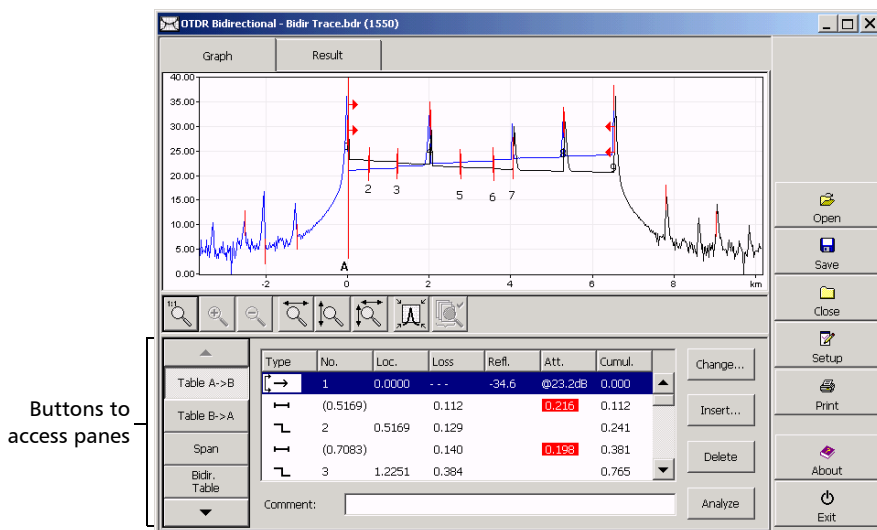

The main window contains buttons allowing you to access the following panes:

- Results for the A->B trace, presented in a table
- Results for the B->A trace, presented in a table
- Results for the bidirectional trace, presented in a table
- Options to modify span-start and span-end values
- Information about the A->B trace and settings used
- Information about the B->A trace and settings used
- Information about the bidirectional trace and settings used

To close the application from the main window:

- Press  (in the top right corner of the main window).
- Press the **Exit** button located at the bottom of the button bar.

Creating Bidirectional Trace Files

To work with the OTDR Bidirectional Analysis utility, you must acquire and save the traces (in the OTDR application) before opening them with the Bidirectional Analysis utility.

You can open unidirectional trace files to combine them into a bidirectional trace. It is possible to use both single-wavelength and multiwavelength traces. However, once a multiwavelength trace file is recalled, it is converted to a single-wavelength trace file and you will have to specify which wavelength the application will use. Bidirectional files will automatically be created for the other wavelengths. You can save these bidirectional files or discard them.

The A->B and B->A traces must respect the following criteria:

Item	To be valid...
Pulse width	Must be identical for both traces.
Fiber types	Use only traces acquired using <i>singlemode</i> fibers.
Acquisition offset	Must be set to zero for both traces.
Wavelengths	Must be identical for both traces.
Trace	Both must be unidirectional files (.trc files).

When two traces are opened in the bidirectional analysis utility, the A->B trace is on the left and the B->A trace is on the right. If the analysis does not match the traces, error or warning messages will appear. A message will be displayed if there are any inconsistencies in the events table, wavelength, index of refraction, helix factor, or Rayleigh backscatter coefficient.

Note: *The A->B and B->A traces are displayed in full view mode (1:1 zoom factor).*

Analyzing Bidirectional Traces

Creating Bidirectional Trace Files

To create a bidirectional trace file:

1. If necessary, clear the window by pressing the **Close** button on the button bar.

The application will prompt you if some files have not been saved.

2. From the button bar, press **Open**.
3. In the **Open** dialog box, select **Create Bidirectional File by Opening A->B File and B->A File**.

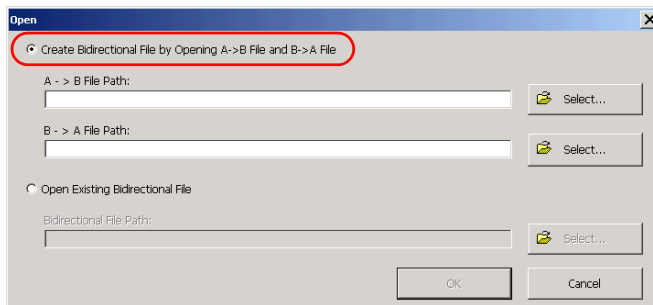

4. Select the files to open.
 - 4a. Press the **Select** button, on the right of the **A->B File Path** box.
 - 4b. Select the first file (ensure that it is highlighted) and press **OK**.

Note: You can select the **Show Preview** box to display an overview of the trace(s) to ensure you will open the appropriate file.

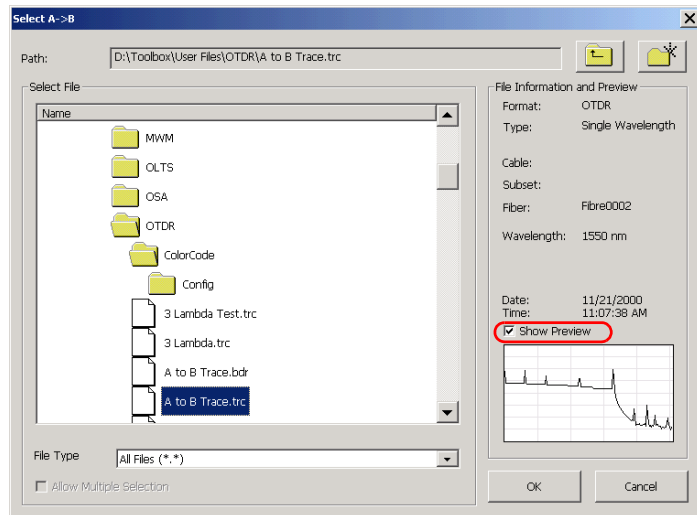

- 4c. Press the **Select** button, on the right of the **B->A File Path** box.
 - 4d. Select the second file (ensure that it is highlighted) and press **OK**.
5. Back to the **Open** dialog box, press **OK** to confirm.
6. If you selected a multiwavelength file:
 - 6a. Specify the desired wavelength and press **OK**.

The application will prompt you to save the other bidirectional files that were automatically generated.

- 6b. For each file, press **Yes** to save the file or **No** to discard it.

Analyzing Bidirectional Traces

Opening Existing Bidirectional Trace Files

Opening Existing Bidirectional Trace Files

You can open previously merged bidirectional traces to view results or to reanalyze the trace.

To open an existing bidirectional trace file:

1. If necessary, clear the window by pressing the **Close** button on the button bar.

The application will prompt you if any files have not been saved.

2. From the button bar, press **Open**.
3. In the **Open** dialog box, select **Open Existing Bidirectional File**.

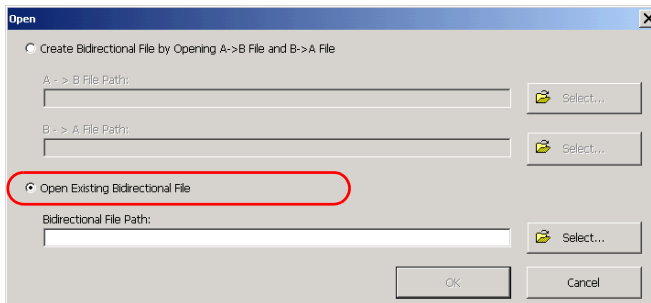

4. Press the **Select** button, on the right of the **Bidirectional File Path** box.
5. Select the desired file (ensure that it is highlighted) and press **OK**.

Note: You can select the **Show Preview** box to display an overview of the trace(s) to ensure you will open the appropriate file.

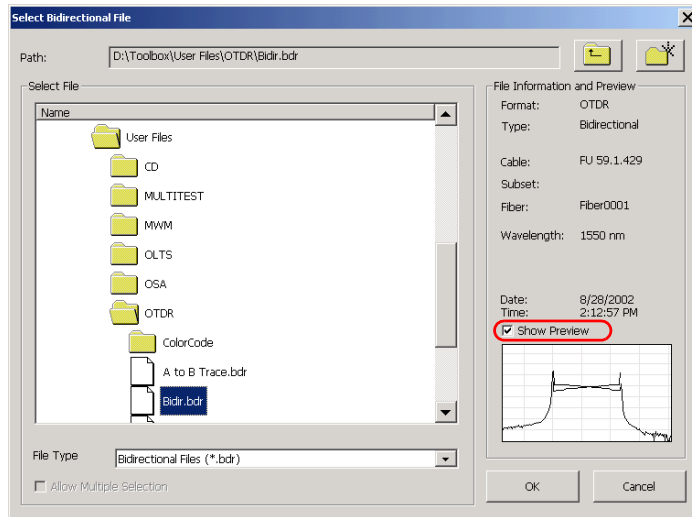

6. Back to the **Open** dialog box, press **OK** to confirm.

Analyzing Bidirectional Traces

Viewing Test Results

Viewing Test Results

The application allows you to view the results of the A->B and B->A traces according to the thresholds defined in the Bidirectional Analysis tool. You can also view the corresponding graph and obtain more information about the status of the bidirectional and/or A->B and B->A status.

To view test results:

From the main window, select the **Result** tab.

The screenshot shows the 'Result' tab of the OTDR Bidirectional - Bidir Trace.bdr (1550) window. The window title bar includes 'File name and directory' and 'Wavelength and direction'. The main area contains a table with columns for 'Filename', 'Status', 'Avg. loss', 'Span loss', 'Avg. splice', 'Max. splice', and 'Span length'. The table lists two traces: '1550 nm (A->B)' and '1550 nm (B->A)'. The 'Status' column shows green checkmarks for both. The 'Avg. loss' column shows 0.398 dB/km for A->B and 0.475 dB/km for B->A. The 'Span loss' column shows 2.603 dB for A->B and 3.108 dB for B->A. The 'Avg. splice' column shows 0.186 dB for A->B and 0.221 dB for B->A. The 'Max. splice' column shows 0.384 dB for A->B and 0.373 dB for B->A. The 'Span length' column shows 6.5418 km for A->B and 6.5430 km for B->A. The 'Fiber length and selected measurement unit' label points to the 'Span length' column. The window also features a 'Graph' tab, a 'File' menu, and a 'Trace' menu with buttons for 'Bidir. Status Details...', 'Report/Documentation...', 'Save As...', and 'A->B Status Details...'. A vertical toolbar on the right contains 'Open', 'Save', 'Close', 'Setup', and a printer icon.

Filename	Status	Avg. loss	Span loss	Avg. splice	Max. splice	Span length
D:\ToolBox\User Files\OTDR\Bidir Trace.bdr						
1550 nm (A->B)	✔	0.398 dB/km	2.603 dB	0.186 dB	0.384 dB	6.5418 km
1550 nm (B->A)	✔	0.475 dB/km	3.108 dB	0.221 dB	0.373 dB	6.5430 km

To view detailed status:

Press **Bidir. Status Details**.

OR

Select a trace and press **A->B Status Details** (or **B->A Status Details**).

To view the graph:

Select the **Graph** tab.

Analyzing the Fiber on a Specific Fiber Span

If you want to focus your fiber analysis on a specific fiber span, you can define events (new or existing) as span start and span end.

Span start and span end are defined on both the A->B and B->A trace. Traces are aligned on the span start of the A->B trace and on the span end of the B->A trace. The two other span events are not used in the bidirectional analysis.

Changes to the span start and span end modify the events table. The span start becomes Event 1 and its distance reference becomes 0. All events on both traces are numbered on the trace display. The cumulative loss is calculated within the defined fiber span only.

Note: *To keep a set fiber span during trace reanalysis, activate the fiber span delimitation memory (for details, see Saving the Span-Start and Span-End Information on page 87); otherwise, the span start and span end markers are reset to zero in the process.*

You can use the zoom control buttons to modify the trace display. For more information, see *Using Zoom Controls* on page 139.

Analyzing Bidirectional Traces

Analyzing the Fiber on a Specific Fiber Span

To set a fiber span:

1. From the main window, press the **Span** button.

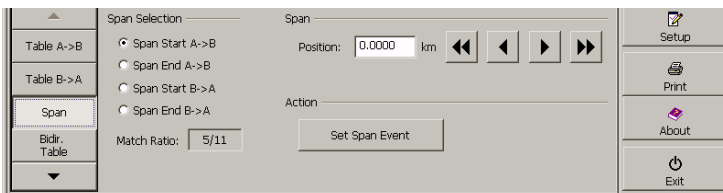

2. Select the **Span Start** or **Span End** option according to the type of span event you want to create for the A->B and B->A trace.

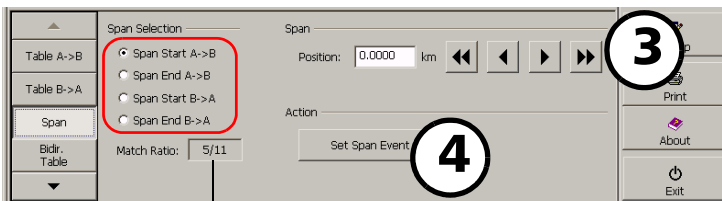

Ratio of matched events between
A-> B trace and B->A trace

3. Enter the span event location by moving marker **A** along the trace using one of the following options:
 - Drag marker **A** to position it to the desired span event location.
 - Enter a distance value in the **Position** box.
 - Use the single-arrow buttons to move marker **A** on the trace.
 - Use one of the double-arrow buttons to move marker **A** from event to event; this will designate an existing event as a span event.

Note: *Each of the first three options above may lead to the creation of a new event, except if your location corresponds to an already existing event on the trace.*

4. Select **Set Span Event** to set the span start or span end marker on the appropriate event in the trace display.
The change is applied automatically.

Analyzing Bidirectional Traces

You can use either single-wavelength or multiwavelength trace files for bidirectional analysis. For details, see *Creating Bidirectional Trace Files* on page 236 and *Opening Existing Bidirectional Trace Files* on page 240.

Once the trace files are open, you can proceed with the analysis.

For information about inserting, deleting and reanalyzing a trace, changing trace display parameters and entering comments, see *Analyzing Traces and Events* on page 131.

To analyze a multiwavelength trace file:

1. Open the desired trace files.

For more information, see *Creating Bidirectional Trace Files* on page 236 and *Opening Existing Bidirectional Trace Files* on page 240.

2. Press the **Bidir. Table** button.

The bidirectional event table lists all the events detected on the fiber.

Event type detected
(see *Description of Event Types* on page 295)

Event number or span length (distance between two events)

Distance from the span start to the specified event

Attenuation (loss/distance) of individual fiber section

Current loss in dB

Type	No.	Loc.	Att.	Avg. Loss	Cumul.	A to B Loss	B to A Loss
Table A->B	1	0.0000	---	0.000	---	---	---
Table B->A	(2.0604)	2.0604	0.162	0.333	0.333	0.268	0.399
Span	(1.7663)	1.7663	0.214	0.379	0.963	0.374	0.383
Bidir. Table	3	3.8267	-0.020	0.943	-0.040	0.000	

Comment: _____

Average of the loss measured between A->B and B-> A traces (most important information)

Cumulative loss calculated from span start to specified event. Includes loss of each event of the span.

3. When the bidirectional analysis of the first wavelength is complete, you can save the analysis as a single trace.

For information about saving traces, see *Saving Traces* on page 254.

4. If you want to create a bidirectional trace at an other wavelength, repeat the previous procedure.

Changing Event Tables

You can change event tables and edit the A->B and B->A traces.

If you change events in one event table, the bidirectional event table will be adjusted accordingly.

If an event is detected in one direction but not in the other, it will automatically be inserted by the utility at the location most likely to designate an event within the default tolerance interval; the current loss measured before an average bidirectional loss will be calculated.

To change event tables and edit the A->B or B->A trace:

Press the corresponding direction button (**Table A->B** or **Table B->A**) and then press the **Change** button.

For more information, see *Analyzing Traces and Events* on page 131.

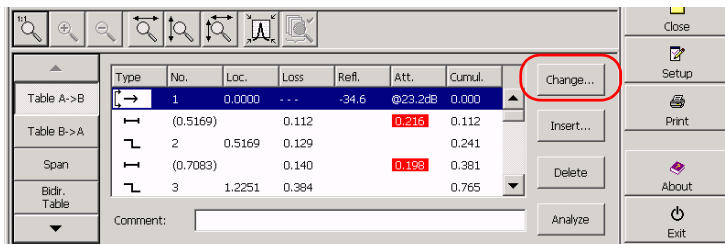

Viewing and Modifying Current Trace Parameters

You can view the current trace parameters for the bidirectional trace as well as for the A -> B and B -> A traces. However, you can only modify the analysis settings for the current A->B and B->A traces, not for the bidirectional trace.

Two groups of parameters can be changed:

- the fiber settings: index of refraction (IOR), Rayleigh backscatter (RBS) coefficient, and Helix factor
- the analysis detection thresholds: for splice loss, reflectance, and end-of-fiber detection

These modifications alter the displayed traces. These settings will also be used when you reanalyze the trace.

By default, a tolerance interval parameter is used during bidirectional analysis to match events from A->B and B->A traces in the resulting bidirectional trace.

When you know the exact location of events in traces acquired in both directions and are expecting a perfect match, you could get pairs of closely spaced events in a combined trace. This is due to a difference in the measured distance of events in each direction, which is greater than the default tolerance interval.

You can increase the tolerance interval value in order to eliminate mismatched events on the bidirectional trace.

Analyzing Bidirectional Traces

Viewing and Modifying Current Trace Parameters

To view trace parameters:

Press the **Bidir. Info**, **A->B Info** or **B->A Info** button.

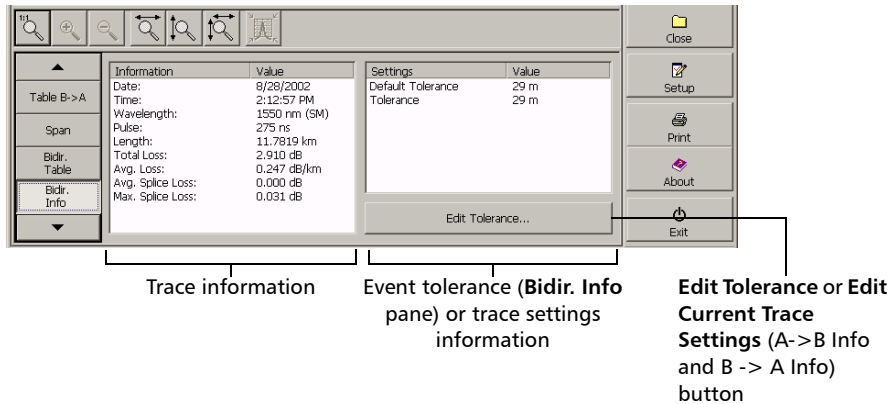

The following parameters are displayed:

- **Pulse:** Pulse width used to perform the acquisition.
- **Length:** Measured length of the total fiber span between span start and span end.
- **Span Loss:** Total measured loss of the fiber between span start and span end.
- **Avg. Loss:** Average loss of the total fiber span as a function of distance.
- **Avg. Splice Loss:** Average of all non-reflective events between span start and span end.
- **Max. Splice Loss:** Maximum value of all non-reflective events between span start and span end.

These parameters are also displayed for the bidirectional trace:

- **Default Tolerance:** Default tolerance applied for matching events from A->B and B->A traces in the resulting bidirectional trace.
- **Tolerance:** Tolerance interval value used in the bidirectional trace file that can be modified by user to eliminate mismatched events.

Parameters specific to the A->B or B->A trace are also displayed:

- **Range:** Acquisition range.
- **Span ORL:** ORL calculated between the span start and the span end.
- **High-Resolution Acq.:** Indicates whether or not the acquisitions were performed using the high-resolution feature.
- **Helix Factor:** Helix factor setting of the displayed trace. If you modify this parameter, the distance measurements for the trace will be adjusted.
- **IOR:** Index of refraction of the displayed trace. If you modify this parameter, the distance measurements for the trace will be adjusted. You can enter an IOR value directly or let the application calculate it with the distance between span start and span end you provide.
- **RBS:** Rayleigh backscatter coefficient of the displayed trace. If you modify this parameter, the reflectance and ORL measurements for the trace will be adjusted.
- **Splice Loss Threshold:** Splice loss threshold for detecting small non-reflective events during trace analysis.
- **Reflectance Threshold:** Reflectance threshold for detecting small reflective events during trace analysis.
- **End-of-Fiber Threshold:** End-of-fiber threshold for detecting important event loss, which could compromise signal transmission, during trace analysis.

Analyzing Bidirectional Traces

Viewing and Modifying Current Trace Parameters

To modify the current trace settings:

1. From the main window, press the **A->B Info** or **B->A Info** button then press the **Edit Current Trace Settings** button.

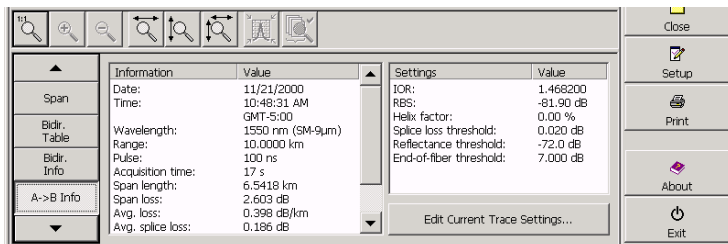

2. Enter values for the current trace in the appropriate boxes.

OR

Revert to default values by pressing the **Default** button.

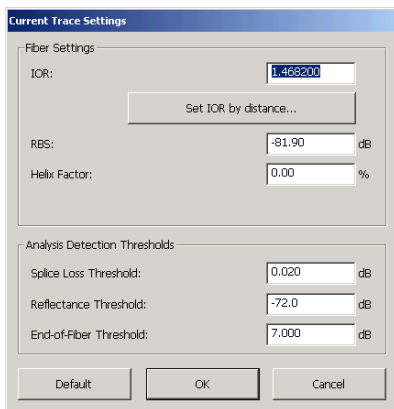

If you already know the IOR value, you can enter it in the corresponding box. However, if you prefer to let the application calculate the IOR value as function of the distance between span start and span end, press **Set IOR by Distance**, then enter the distance value.

3. Press **OK** to confirm.

You return to the **Trace Info** pane.

Note: *Modifying the current trace parameters in the **A->B Info** or **B->A Info** pane affects the trace that is displayed.*

To change the tolerance interval value:

1. Press the **Bidir. Info** button and then **Edit Tolerance**.

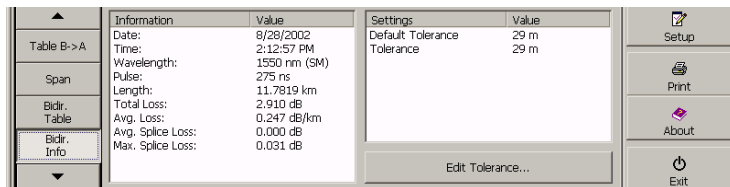

2. Enter the desired value in the **Tolerance (to be adjusted)** box.

OR

Press **Default** to use the default tolerance value.

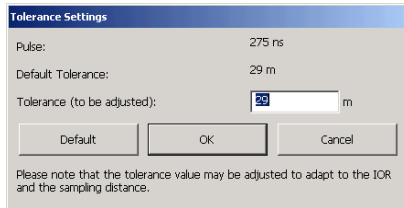

3. Press **OK**.

You return to the **Bidir. Info** pane.

Note: *The new value will be used for all subsequent analyses. This value will be changed if the utility is reset to the default event-matching tolerance value.*

Saving Traces

After recalling, analyzing and displaying the two traces in the bidirectional table, these traces may be stored as a merged bidirectional trace in order to facilitate file management. All information in the tables, comments and reports for A->B, B->A, as well as the bidirectional trace will be saved in the bidirectional file.

By default, the application saves the bidirectional file only. Consequently, the changes you make will not be automatically saved to the original files. You will have to save the A->B file and/or the B->A file manually.

It is also possible to modify the file path, but not the file format (.*bdr* for the bidirectional file and .*trc* for the A->B and the B->A files).

If you want to discard the original traces and only keep the bidirectional file, you will have to delete the files manually via Microsoft Explorer available from **ToolBox > Utilities**. For more information, refer to the *FTB-400 Universal Test System* user guide and Microsoft help.

To save the bidirectional file directly:

From the button bar, press **Save**.

To save files manually:

1. From the main window, select the **Result** tab then press **Save As**.

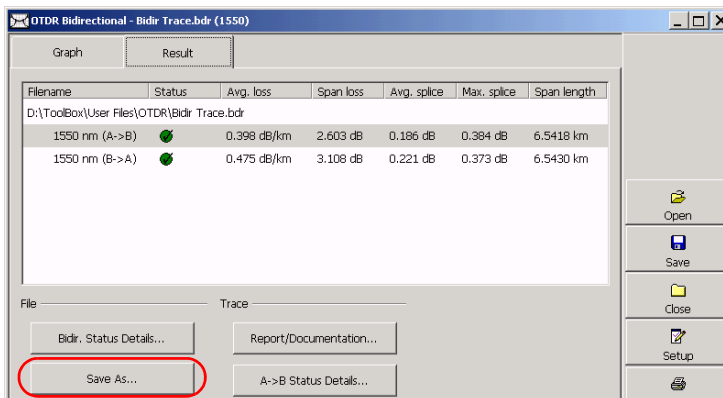

2. From the **Save As** dialog box, select a folder or create one to save your file.

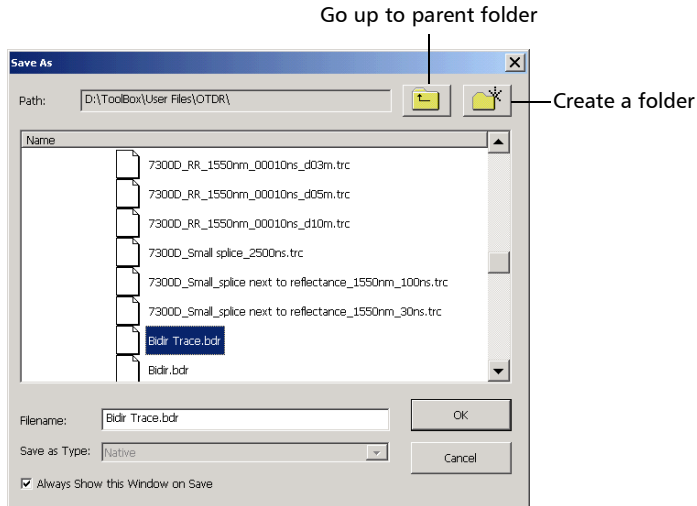

3. From **File To Be Saved**, select the file you want to save.
4. In the **Filename** box, type a name for your file and press **OK**.



IMPORTANT

If you specified an existing file name, the application will display a warning message. To avoid losing data, press *Yes* **only** if you want to overwrite the existing file.

Documenting Results

After acquiring a trace, you might want to include or update information about the tested fiber and job or add comments. For more information, see *Adding Information to the Test Results* on page 212.

Creating a Report

You can customize your report before printing it by specifying which type of document you want, which information will appear in your report and in what order. For more information, see *Customizing the Report* on page 217.

Printing a Report

Once you have entered information about the test and customized your report, you can print it. For more information, see *Adding Information to the Test Results* on page 212, *Customizing the Report* on page 217, and *Printing a Report* on page 226.

15 ***Preparing for Automation or Remote Control***

Your OTDR can be controlled automatically or remotely after configuring the appropriate parameters.

EXFO supplies commands that follow the guidelines determined by the SCPI consortium as well as LabVIEW drivers. EXFO also supplies COM properties and events allowing you to build your own application.

Detailed information on the provided commands can be found in *SCPI Command Reference* on page 309. For more information on automation, remote control and programming, refer to the *FTB-400 Universal Test System* user guide.

Preparing for Automation or Remote Control

You can display a monitor window allowing you to view information related to your OTDR such as the current parameters, status, etc. The provided information is updated according to the SCPI commands you send to the OTDR.

The window is divided into sections corresponding to specific SCPI commands. References to the various commands are presented in the following pages.

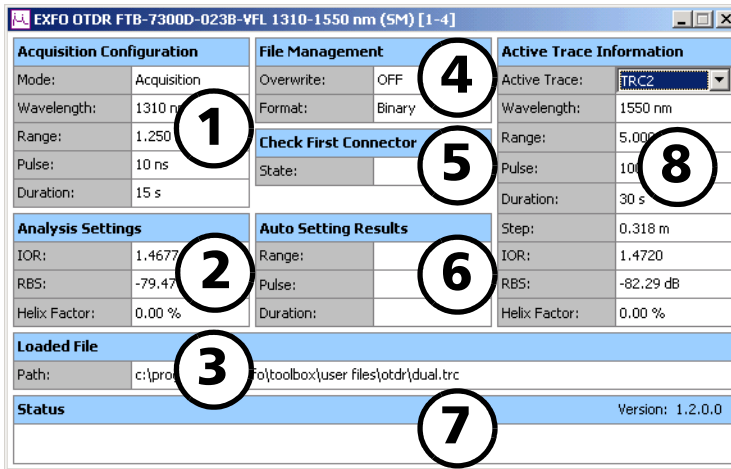

Note: You cannot edit information directly from this window.

To display the monitor window:

1. From ToolBox, go to the **Current Modules** function tab.
2. Press the **Monitor** button.

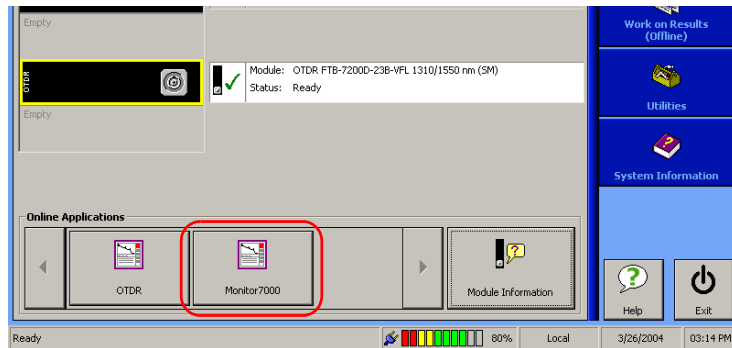

You can hide (minimize) the monitor window and make it appear as needed.

To hide the monitor window:

Use the  button on the upper-right corner of the window.

To show a hidden monitor window:

1. Press the *Program Switcher* button. This button is located on the front panel of the FTB-400 Universal Test System (for more information, refer to the *FTB-400 Universal Test System* user guide).
2. Select the OTDR application.

Preparing for Automation or Remote Control

- **①** Acquisition Configuration: Current parameters used for acquisition.

See :CONFigure[1..n]:ACQquisition:MODE? on page 370

See :CONFigure[1..n]:ACQquisition:WAVelength? on page 378

See :CONFigure[1..n]:ACQquisition:RANGe? on page 374

See :CONFigure[1..n]:ACQquisition:PULSe? on page 371

See :CONFigure[1..n]:ACQquisition:DURation? on page 364

Acquisition Configuration	
Mode:	Acquisition
Wavelength:	1310 nm
Range:	1.250 km
Pulse:	10 ns
Duration:	15 s

- **②** Analysis Settings: Current values used for analysis.

See :CONFigure[1..n]:ANALysis:IORefractiOn? on page 383

See :CONFigure[1..n]:ANALysis:RBScaTter? on page 385

See :CONFigure[1..n]:ANALysis:HFACTOR? on page 381

Analysis Settings	
IOR:	1.4677
RBS:	-79.47 dB
Helix Factor:	0.00 %

Loaded File

Preparing for Automation or Remote Control

- ③ Loaded File: File name and path of the currently loaded file.

See :MMEMory[1..n]:LOAD:NAME? on page 411

Loaded File	
Path:	c:\program files\exfo\toolbox\user files\otdr\dual.trc
Status	

- ④ File Management: Saving behavior and file type. The file type (format) reflects the setting you make with the corresponding SCPI command. Consequently, it will not be updated at the loading of a file.

See :MMEMory[1..n]:STORE:TRACe:OVERwrite? on page 416

See :MMEMory[1..n]:DATA:TYPE? on page 410

FL 1310-1550 nm (5M) [1-4]		
File Management		Active Tra
Overwrite:	OFF	Active Trace
Format:	Binary	Wavelength
Check First Connector		Range:

- ⑤ Check First Connector: Indicates if a fiber is connected (*Pass*) to the detector port or not (*Fail*). If you want to use this feature, remember to set the OTDR's acquisition mode to *CFConnector* first.

See :FETCh[1..n]:CFConnector? on page 397

Check First Connector		Range:
State:	Pass	Pulse:
		Duration:
Check First Connector		
State:	Fail	

Preparing for Automation or Remote Control

- ⑥ Auto Setting Results: Acquisition values suggested by the application to get the best possible results. If you want to use this feature, remember to set the OTDR's acquisition mode to *ACquisition* first.



IMPORTANT

The OTDR parameters are NOT automatically set to the suggested values. You must set them yourself using the appropriate SCPI commands.

See <code>:FETCh[1..n]:ASETting:RANGe?</code> on page 396	<table border="1"><thead><tr><th colspan="2">Auto Setting Results</th></tr></thead><tbody><tr><td>Range:</td><td>5.000 km</td></tr><tr><td>Pulse:</td><td>100 ns</td></tr><tr><td>Duration:</td><td>15 s</td></tr></tbody></table>	Auto Setting Results		Range:	5.000 km	Pulse:	100 ns	Duration:	15 s	Step:
Auto Setting Results										
Range:		5.000 km								
Pulse:		100 ns								
Duration:	15 s									
See <code>:FETCh[1..n]:ASETting:PULSe?</code> on page 395	IOR:									
See <code>:FETCh[1..n]:ASETting:DURation?</code> on page 394	RBS:									
		Helix Factor								

- ⑦ Status: Current state of your OTDR (initialization in progress, ready, etc.) and error messages.

Loaded File	
Path:	
Status	
Version: 1.1.0.12	
Initialization in progress... Please wait !	

See `:INITiate[1..n]:STATe?` on page 408
`:ERRor[1..n]?` on page 392

- **8** Active Trace Information: Information available for the selected (active) trace. When you are working with a loaded file, you can specify which of the available traces will become the active trace. The related information is automatically refreshed according to your selection.

Each trace corresponds to a specific wavelength:

- TRC1 for the first wavelength
- TRC2 for the second wavelength (if applicable)
- TRC3 for the third wavelength (if applicable)

Note: During data acquisition, only one trace is available at a time. This trace corresponds to the wavelength currently being used.

Active Trace Information	
Active Trace:	TRC2
Wavelength:	1550 nm
Range:	5.000 km
Pulse:	100 ns
Duration:	30 s
Step:	0.318 m
IOR:	1.4720
RBS:	-82.29 dB
Helix Factor:	0.00 %

See :FETCh[1..n]:WAVelength? on page 406

See :FETCh[1..n]:RANGe? on page 402

See :FETCh[1..n]:PULSe? on page 401

See :FETCh[1..n]:DURation? on page 398

See :FETCh[1..n]:STEP? on page 403

See :CALCulate[1..n]:IORefractor on page 333

See :CALCulate[1..n]:RBScatter? on page 344

See :CALCulate[1..n]:HFACtor? on page 329

16 *Maintenance*

To help ensure long, trouble-free operation:

- Always inspect fiber-optic connectors before using them and clean them if necessary.
- Keep the unit free of dust.
- Clean the unit casing and front panel with a cloth slightly dampened with water.
- Store unit at room temperature in a clean and dry area. Keep the unit out of direct sunlight.
- Avoid high humidity or significant temperature fluctuations.
- Avoid unnecessary shocks and vibrations.
- If any liquids are spilled on or into the unit, turn off the power immediately and let the unit dry completely.



WARNING

Use of controls, adjustments, and procedures for operation and maintenance other than those specified herein may result in hazardous radiation exposure.

Cleaning EUI Connectors

Regular cleaning of EUI connectors will help maintain optimum performance. There is no need to disassemble the unit.



IMPORTANT

If any damage occurs to internal connectors, the module casing will have to be opened and a new calibration will be required.

To clean EUI connectors:

1. Remove the EUI from the instrument to expose the connector baseplate and ferrule.

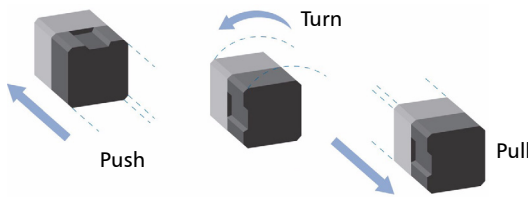

2. Moisten a 2.5 mm cleaning tip with *one drop* of isopropyl alcohol (alcohol may leave traces if used abundantly).
3. Slowly insert the cleaning tip into the EUI adapter until it comes out on the other side (a slow clockwise rotating movement may help).

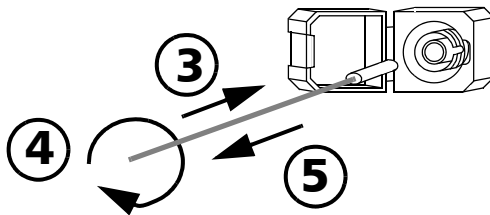

4. Gently turn the cleaning tip one full turn, then continue to turn as you withdraw it.

5. Repeat steps 3 to 4 with a dry cleaning tip.

Note: *Make sure you don't touch the soft end of the cleaning tip.*

6. Clean the ferrule in the connector port as follows:

6a. Deposit *one drop* of isopropyl alcohol on a lint-free wiping cloth.



IMPORTANT

Isopropyl alcohol may leave residues if used abundantly or left to evaporate (about 10 seconds).

Avoid contact between the tip of the bottle and the wiping cloth, and dry the surface quickly.

- 6b.** Gently wipe the connector and ferrule.
- 6c.** With a dry lint-free wiping cloth, gently wipe the same surfaces to ensure that the connector and ferrule are perfectly dry.
- 6d.** Verify connector surface with a portable fiber-optic microscope (for example, EXFO's FOMS) or fiber inspection probe (for example, EXFO's FIP).



WARNING

Verifying the surface of the connector WHILE THE UNIT IS ACTIVE WILL result in permanent eye damage.

7. Put the EUI back onto the instrument (push and turn clockwise).
8. Throw out cleaning tips and wiping cloths after one use.

Verifying Your OTDR

You can perform several tests to ensure your OTDR operates within specifications.

Deviation is measured to determine if the OTDR needs recalibration.

Setting your OTDR to zero can only be done at EXFO. However, you can test your OTDR to verify the accuracy of its measurement origin.

To measure the deviation:

1. Connect at least 2 km of fiber to the OTDR output port.
2. Set the distance range at 2.5 km and acquisition time at 180 seconds.
3. Measure the deviation between a 10 ns pulse and a 30 ns pulse for each laser.

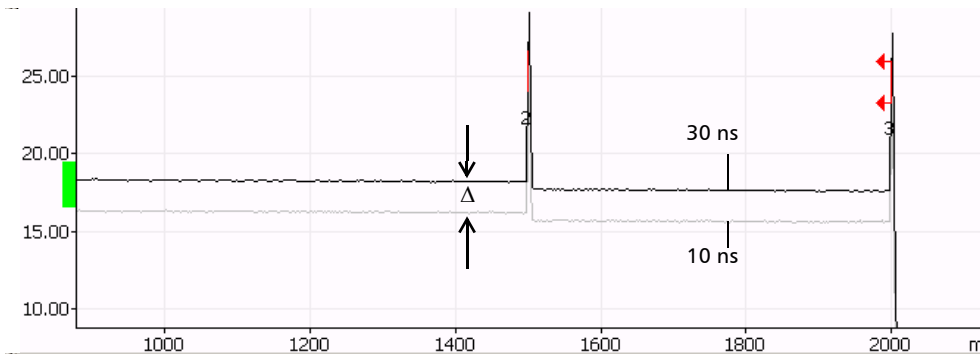

The deviation (Δ) should be between 2.0 dB and 3.0 dB. The deviation must be measured in the linear backscatter region. Do not measure the deviation near distinct reflections.

Performance will be affected if the observed deviation is beyond these limits. The OTDR will eventually require a factory calibration.

Note: *This does not affect the precision of distance or loss measurements.*

To evaluate the launch level:

1. Connect at least 2 km of fiber to the OTDR port.
 - Ensure that the OTDR port and connectors are properly cleaned and that the fiber settings are accurate (IOR, Helix factor and RBS).
 - Do not use a test jumper between the OTDR and the fiber under test to limit the number of connectors.
2. Set the distance range to the fiber length used for the evaluation, the pulse width to the shortest value available, and the acquisition time to 15 seconds.
3. Evaluate the launch level at 0 km by extrapolating the linear region of the curve.

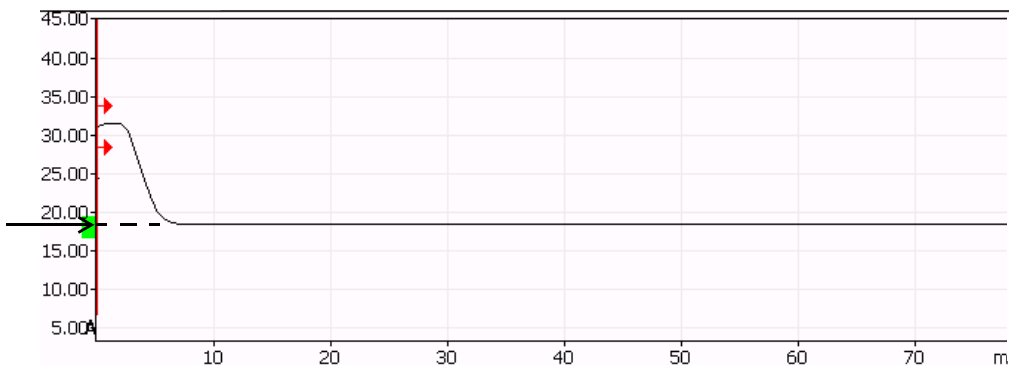

The launch level should be located within the launch window (light green rectangle) appearing on the left side of the Y-axis on the graph. If the launch level is below this window, clean the output connector again, retest the fiber and change the output connector if necessary. If the situation persists, you will observe a degradation in dynamic range. Return the OTDR to EXFO.

Note: *This does not affect the precision of distance or loss measurements.*

Maintenance

Verifying Your OTDR

To verify the OTDR's zero:

1. Connect a patchcord, approximately 10 m long, to the OTDR port. The exact length of the jumper must have been measured mechanically. Ideally, you should use an unjacketed patchcord.
 - Ensure that the OTDR port and connectors are correctly cleaned.
 - Ensure that the fiber settings are accurate (IOR, Helix factor and RBS).
2. Set the distance range to less than 2 km, the pulse width to 10 ns and the acquisition time to 30 s.
3. Take a distance measurement, positioning marker A as shown below.

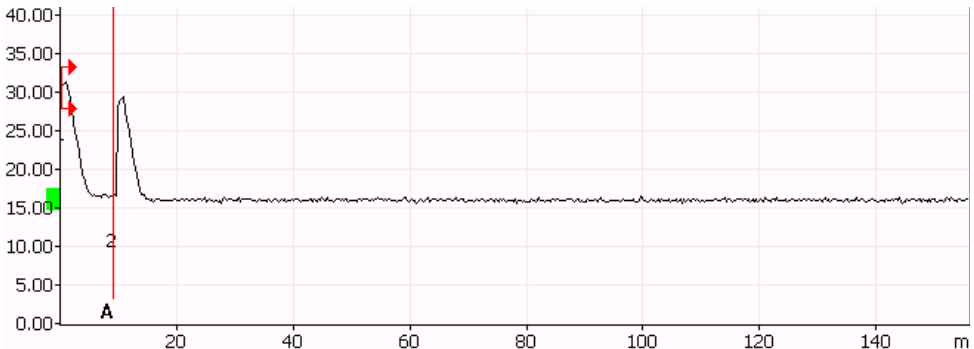

Note: You can also press the **Analyze** button from the **Event** pane. The analysis should return the right position directly.

The position of the marker should be equal to the length of the jumper (± 2 m). For example, 8 to 12 m if the jumper is 10 m long.

If the distance error is beyond this limit, return the OTDR to EXFO.

To measure the event and attenuation dead zones:

1. Connect 2 km of fiber directly to the OTDR port. Use the shortest pulse width and distance range possible.
 - Ensure that the OTDR port and connectors are correctly cleaned.
 - Ensure that the fiber settings are accurate (IOR, Helix factor, and RBS).
2. Measure the length (E) of the first reflection at 1.5 dB from the maximum, as shown below. This is the event dead zone.
3. Measure the distance (A) between the beginning of the reflection and the point where the trace returns to the backscattering level with a 0.5 dB uncertainty, as shown below. Use A and B markers in the **Measure** pane. This is the attenuation dead zone.

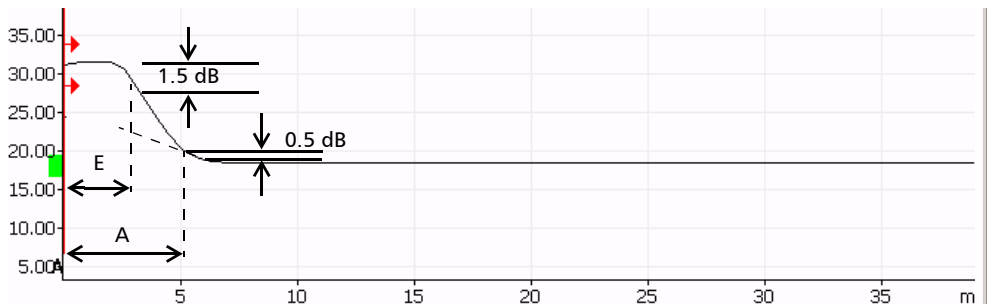

If the results exceed the “maximum permitted specification” (refer to the calibration certificate that came with your product), performance will be affected. A damaged output connector may be the cause.

The reflectance of the output connector should be below -35 dB to attain an adequate dead zone. If reflectance is greater than -35 dB (e.g., -20), the incorrect dead zone will be the result of a bad connection. If this is the case, carefully clean the connector. If the problem persists, change the output connector. If the problem remains even after changing the output connector, return the OTDR to EXFO.

Note: *This does not affect the precision of the distance or loss measurements.*

Maintenance

Verifying Your OTDR

To measure the dynamic range:

1. Connect the OTDR as indicated below. Other configurations are possible, such as the one explained in the section on how to determine measurement range, if you use the shortest fiber length from that setup. In all cases, the fiber should have several sections longer than 2 km, with no loss greater than 8 dB and with an average attenuation not exceeding 1 dB/km.

Ensure the OTDR port and connectors are correctly cleaned, and that the fiber settings are accurate (IOR, Helix factor, and RBS).

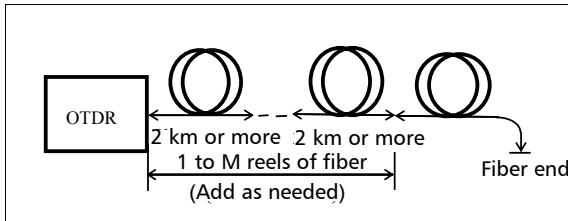

- Set the distance range to 160 km (singlemode fiber), the pulse width to the longest value available and the acquisition time to 180 seconds.

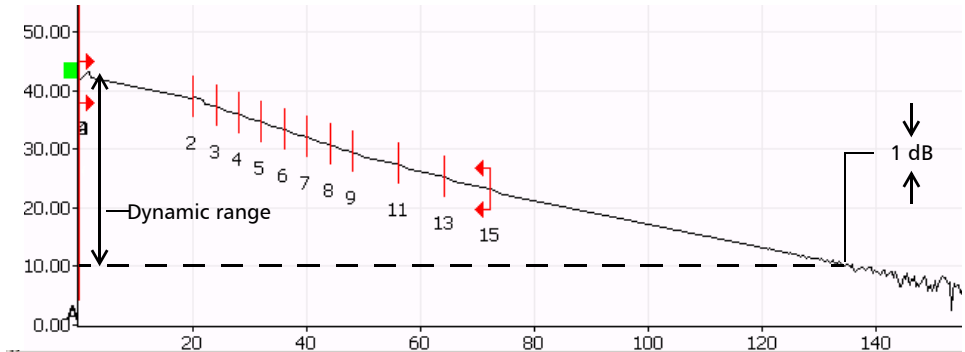

Dynamic range is the difference between the launch level and the position on the curve where the peak-to-peak noise level is 1 dB, plus a correction factor relative to the noise amplitude (which is 5.2 dB).

If the result falls below the “minimum permitted specification” (refer to the calibration certificate that came with your product), you will observe a degradation of performance. It could be caused by a damaged output connector. If this is the case, clean the connector. If the problem persists, change the output connector. If the problem remains even after changing the output connector, return the OTDR to EXFO.

Note: *This does not affect the precision of the distance or loss measurements.*

Maintenance

Verifying Your OTDR

To determine the measurement range (singlemode models only):

1. Connect the OTDR as indicated below. Other configurations are possible, but the fiber should have several sections longer than 2 km, with no loss greater than 8 dB and with the average attenuation not exceeding 1 dB/km. A variable attenuator will be used to adjust the loss in the span.

One or several non-reflective events with a nominal loss of 0.5 dB should be present. Join a series of fiber reels between the OTDR and the variable attenuator for a length of approximately 20 km. Join another series of reels to complete the fiber length needed for the test.

- Ensure that the OTDR port and connectors are correctly cleaned.
- Make sure the fiber settings are accurate (IOR, Helix factor, and RBS).

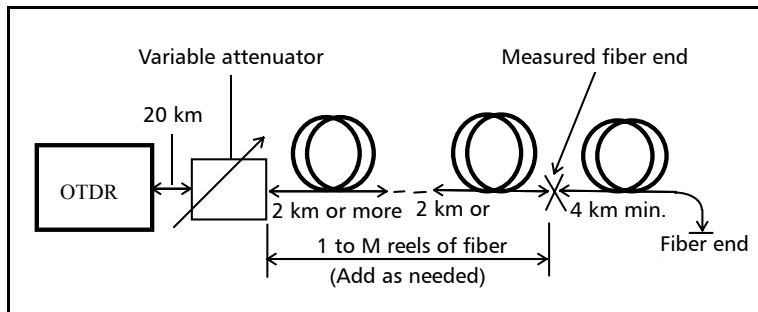

2. Set the distance range to 80 km (singlemode fiber), the pulse width to the longest value available and the acquisition time to 180 seconds.

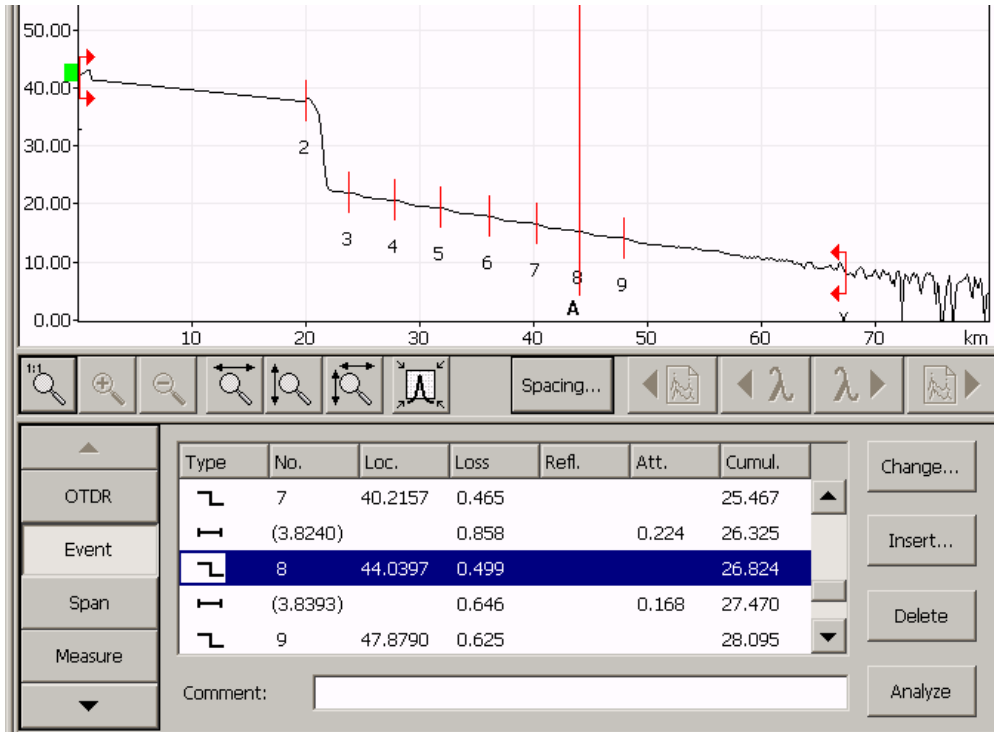

The measurement range using the non-reflective event method represents the amount of attenuation (dB) between the launch level and a 0.5 dB splice (which can be detected and measured to an accuracy of ± 0.1 dB). You can measure it by simply making an acquisition on a fiber with a known attenuation and a known 0.5 dB splice. Attenuation between the splice and the launch level is added until the analysis can no longer measure the splice to within ± 0.1 dB.

Recalibrating the Unit

Manufacturing and service center calibrations are based on the ISO/IEC 17025 Standard, which states that calibration documents must not contain a recommended calibration interval, unless this has been previously agreed upon with the customer.

Validity of specifications depends on operating conditions. For example, the calibration validity period can be longer or shorter depending on the intensity of use, environmental conditions and unit maintenance. You should determine the adequate calibration interval for your unit according to your accuracy requirements.

Under normal use, EXFO recommends calibrating your unit every year.

Recycling and Disposal (Applies to European Union Only)



Recycle or dispose of your product (including electric and electronic accessories) properly, in accordance with local regulations. Do not dispose of it in ordinary garbage receptacles.

This equipment was sold after August 13, 2005 (as identified by the black rectangle).

- Unless otherwise noted in a separate agreement between EXFO and a customer, distributor, or commercial partner, EXFO will cover costs related to the collection, treatment, recovery, and disposal of end-of-lifecycle waste generated by electronic equipment introduced after August 13, 2005 to an European Union member state with legislation regarding Directive 2002/96/EC.
- Except for reasons of safety or environmental benefit, equipment manufactured by EXFO, under its brand name, is generally designed to facilitate dismantling and reclamation.

For complete recycling/disposal procedures and contact information, visit the EXFO Web site at www.exfo.com/recycle.

17 Troubleshooting

Solving Common Problems

Problem	Cause	Solution
The selection dial located on the front of the FTB-400 Universal Test System is not working.	The software reinstallation process is incomplete.	Restart the FTB-400.
New module is not working.	The software version installed on your FTB-400 Universal Test System is too old for the module currently being used.	Update ToolBox software version using the CD that came with your new module (refer to the <i>FTB-400 Universal Test System</i> user guide).
The application does not use your custom thresholds.	The thresholds have been defined on the wrong wavelength.	Ensure that the desired wavelength is selected before saving the new thresholds or apply the new thresholds to all wavelengths. For more information, see <i>Setting Pass/Fail Thresholds</i> on page 80.

Problem	Cause	Solution
The application displays a message indicating that a “Non-resolved fiber end” event has been found.	The fiber under test is too long.	Ensure that the fiber under test is shorter than the maximum length the OTDR can measure.

Troubleshooting

Solving Common Problems

Problem	Cause	Solution
<p>The application displays a message indicating that a “live fiber error” occurred and the fiber <i>was not</i> connected to the SM Live port.</p>	<p>Light has been detected on the OTDR port during the acquisition or while you were monitoring a fiber in real-time mode.</p>	<p>Disconnect the fiber from the OTDR port. Press OK to close the message. Start another acquisition without any fiber connected to the OTDR. The message about live fiber error should not appear and the OTDR trace should look “normal”.</p> <p>If you still see the message about live fiber error even if no fiber is connected to the OTDR, contact EXFO.</p> <p>Never connect a live fiber to the OTDR port without a proper setup. Any incoming optical power ranging from -65 dBm to -40 dBm will affect the OTDR acquisition. The way the acquisition will be affected depends on the selected pulse width. Any incoming signal greater than -20 dBm could damage your OTDR permanently. For live-fiber testing, refer to the SM Live port specifications for the characteristics of the built-in filter.</p>

Problem	Cause	Solution
<p>The application displays a message indicating that a “live fiber error” occurred and the fiber <i>was</i> connected to the SM Live port.</p>	<p>The level of integrated power in the filter bandwidth of the SM Live port is too high. A transmission wavelength from the network could be too close to the SM Live wavelength.</p>	<p>Disconnect the fiber from the OTDR port. Press OK to close the message. Start another acquisition without any fiber connected to the OTDR. The message about live fiber error should not appear and the OTDR trace should look “normal”.</p> <p>If you still see the message about live fiber error even if no fiber is connected to the OTDR, contact EXFO.</p> <p>Singlemode live-fiber testing requires that the integrated power in the test channel (corresponding to the filter bandwidth of the SM Live port) be as low as possible. Any incoming optical power ranging from -65 dBm to -40 dBm will affect the OTDR acquisition. The way the acquisition will be affected depends on the selected pulse width. Higher power levels will prevent acquisition from running. Verify network compatibility with the SM Live wavelength. Ensure that the network is not transmitting wavelengths greater than 1600 nm.</p>
<p>In multimode fiber testing, launch level remains out of the launch window (light green rectangle) even after cleaning and verifying connection.</p>	<p>Wrong fiber type selected.</p>	<ul style="list-style-type: none"> ➤ If you are testing C fiber, from the Auto or Advanced main window, select MM 50 μm. ➤ If you are testing D fiber, from the Auto or Advanced main window, select MM 62.5 μm.

Troubleshooting

Error Messages

Error Messages

Error Message	Possible Cause	Solution
ToolBox Fatal Error: OTDR Card Module Memory Error	<p>The module could have a defective memory.</p> <p>There could be a conflict between the module and another item on the BUS (for example, a network card).</p> <p>This error should not arise unless the user has modified the instrument.</p>	<p>Verify that the instrument has not been modified by the user.</p> <p>If the instrument has been modified, try the module in another FTB-400.</p> <p>If the problem persists, return the instrument to EXFO.</p>
ToolBox Fatal Error: OTDR Card Module INVALID IO PORT	<p>The OTDR does not recognize the requested communication port.</p> <p>There could be a conflict between the module and another item on the BUS (for example, a network card).</p> <p>The software could attempt to access a communication port different from the one configured in the module.</p>	<p>Verify that the instrument has not been modified by the user.</p> <p>If the instrument has been modified, try the module in another FTB-400.</p> <p>If the problem persists, return the instrument to EXFO.</p>
ToolBox Fatal Error: OTDR Card Module Coding Version Error or Control Version Error	<p>These two errors appear when the software version is not compatible with the hardware version.</p>	<p>Take note of the module serial number and the software version.</p> <p>Contact EXFO to verify that you have the most recent software version and to be sure that it is compatible with the module.</p>

Error Message	Possible Cause	Solution
ToolBox Fatal Error: OTDR Card Module Unknown Model Error	This error arises if the software version is incompatible with the hardware, or less frequently, if the module memory has been corrupted.	Take note of the module serial number and the software version. Contact EXFO to verify that you have the most recent software version and to be sure that it is compatible with the module.
ToolBox Fatal Error: OTDR Card Module APD Error	The photodetector is not working. The module should not be used.	Return the module to EXFO.
ToolBox Fatal Error: OTDR Card Module Offset Error	The voltage in the module is out of specifications. The module should not be used.	Return the module to EXFO.
ToolBox Fatal Error: OTDR Card Module Checksum Error	The memory is corrupted. The module should not be used.	Return the module to EXFO.
ToolBox Fatal Error: OTDR Card Module Failed Insertion Loss Reference Test. ORL calculation can no longer be performed	An optical component has been damaged. The equipment may still be used, but the performance of the module may not be optimal, particularly with pulses shorter than 1 μ s. ORL measurements will not be accurate.	Return the module to EXFO.
Calibration EEPROM data is corrupted	A problem was detected with the calibration EEPROM checksum.	Contact EXFO.
Timeout occurred while attempting to read calibration EEPROM	Impossible to read the contents of the calibration EEPROM because the module is not responding.	Contact EXFO.

Troubleshooting

Error Messages

Error Message	Possible Cause	Solution
Communication test with the module has failed.	The module is not able to perform the commands properly.	Contact EXFO.
Unable to read current version of the calibration EEPROM.	The software version installed on your FTB-400 Universal Test System is too old for the module currently being used.	Update ToolBox software version (refer to the <i>FTB-400 Universal Test System</i> user guide).
Module memory error.	Impossible to access the memory where data points are stored.	Contact EXFO.
Unable to adjust the amplification chain's offset.	Impossible to set an internal component (ADC) to the appropriate position when the photodetector <i>is not</i> connected. The module is probably defective.	Contact EXFO.
Unable to adjust offset with APD connected.	Impossible to set an internal component (ADC) to the appropriate position when the photodetector <i>is</i> connected. Light is suddenly detected in the module even though no sign of a live fiber was detected at the beginning of the acquisition.	<ul style="list-style-type: none">➤ Ensure that no live fiber is connected to the OTDR port.➤ Stop any acquisition that could be underway, disconnect the fiber from the OTDR port and close the connector's cap to ensure no light will reach the port. Start a new acquisition. <p>If the problem persists, contact EXFO.</p>

Obtaining Online Help

An online version of the FTB-7000 Series OTDR user guide is available at all times from the application.

Note: You will also find a printable PDF version on your installation CD.

To access online help:

In the button bar, click **About** then click **User Guide**.

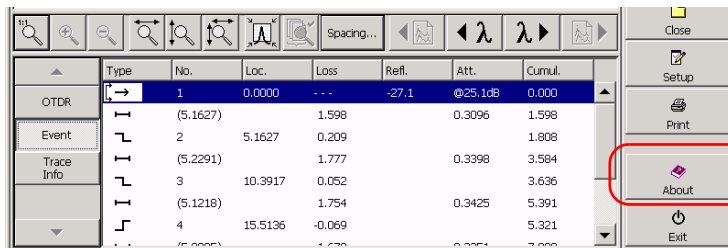

Troubleshooting

Contacting the Technical Support Group

Contacting the Technical Support Group

To obtain after-sales service or technical support for this product, contact EXFO at one of the following numbers. The Technical Support Group is available to take your calls from Monday to Friday, 8:00 a.m. to 7:00 p.m. (Eastern Time in North America).

For detailed information about technical support, visit the EXFO Web site at www.exfo.com.

Technical Support Group

400 Godin Avenue
Quebec (Quebec) G1M 2K2
CANADA

1 866 683-0155 (USA and Canada)
Tel.: 1 418 683-5498
Fax: 1 418 683-9224
support@exfo.com

To accelerate the process, please have information such as the name and the serial number (see the product identification label—an example is shown below), as well as a description of your problem, close at hand.

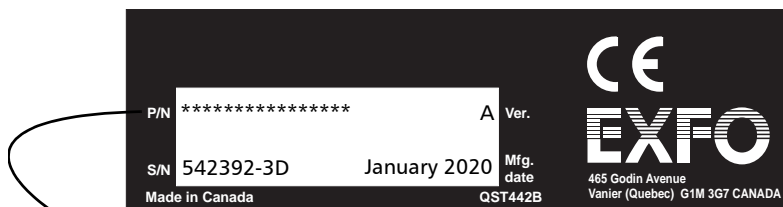

FTB-7200D-XX-XX-XX

FTB-7X00D-XX-XX-XX

FTB-7X00E-XXB-XX-XX

Model

Connector code

Visual fault locator option

You may also be requested to provide software and module version numbers. This information, as well as technical support contact information, can be found by clicking **About** in the function bar.

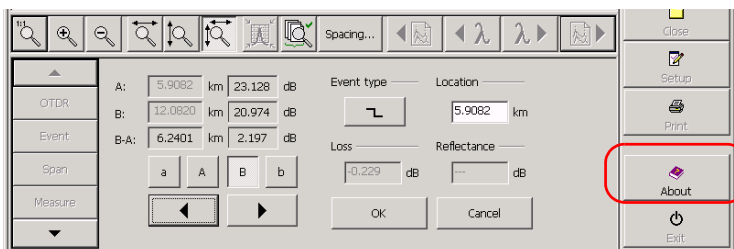

Transportation

Maintain a temperature range within specifications when transporting the unit. Transportation damage can occur from improper handling. The following steps are recommended to minimize the possibility of damage:

- Pack the unit in its original packing material when shipping.
- Avoid high humidity or large temperature fluctuations.
- Keep the unit out of direct sunlight.
- Avoid unnecessary shocks and vibrations.

18 *Warranty*

General Information

EXFO Electro-Optical Engineering Inc. (EXFO) warrants this equipment against defects in material and workmanship for a period of one year from the date of original shipment. EXFO also warrants that this equipment will meet applicable specifications under normal use.

During the warranty period, EXFO will, at its discretion, repair, replace, or issue credit for any defective product, as well as verify and adjust the product free of charge should the equipment need to be repaired or if the original calibration is erroneous. If the equipment is sent back for verification of calibration during the warranty period and found to meet all published specifications, EXFO will charge standard calibration fees.



IMPORTANT

The warranty can become null and void if:

- unit has been tampered with, repaired, or worked upon by unauthorized individuals or non-EXFO personnel.
- warranty sticker has been removed.
- case screws, other than those specified in this guide, have been removed.
- case has been opened, other than as explained in this guide.
- unit serial number has been altered, erased, or removed.
- unit has been misused, neglected, or damaged by accident.

THIS WARRANTY IS IN LIEU OF ALL OTHER WARRANTIES EXPRESSED, IMPLIED, OR STATUTORY, INCLUDING, BUT NOT LIMITED TO, THE IMPLIED WARRANTIES OF MERCHANTABILITY AND FITNESS FOR A PARTICULAR PURPOSE. IN NO EVENT SHALL EXFO BE LIABLE FOR SPECIAL, INCIDENTAL, OR CONSEQUENTIAL DAMAGES.

Warranty

Liability

Liability

EXFO shall not be liable for damages resulting from the use of the product, nor shall be responsible for any failure in the performance of other items to which the product is connected or the operation of any system of which the product may be a part.

EXFO shall not be liable for damages resulting from improper usage or unauthorized modification of the product, its accompanying accessories and software.

Exclusions

EXFO reserves the right to make changes in the design or construction of any of its products at any time without incurring obligation to make any changes whatsoever on units purchased. Accessories, including but not limited to fuses, pilot lamps, batteries and universal interfaces (EUI) used with EXFO products are not covered by this warranty.

This warranty excludes failure resulting from: improper use or installation, normal wear and tear, accident, abuse, neglect, fire, water, lightning or other acts of nature, causes external to the product or other factors beyond the control of EXFO.



IMPORTANT

EXFO will charge a fee for replacing optical connectors that were damaged due to misuse or bad cleaning.

Certification

EXFO certifies that this equipment met its published specifications at the time of shipment from the factory.

Service and Repairs

EXFO commits to providing product service and repair for five years following the date of purchase.

To send any equipment for service or repair:

1. Call one of EXFO's authorized service centers (see *EXFO Service Centers Worldwide* on page 292). Support personnel will determine if the equipment requires service, repair, or calibration.
2. If equipment must be returned to EXFO or an authorized service center, support personnel will issue a Return Merchandise Authorization (RMA) number and provide an address for return.
3. If possible, back up your data before sending the unit for repair.
4. Pack the equipment in its original shipping material. Be sure to include a statement or report fully detailing the defect and the conditions under which it was observed.
5. Return the equipment, prepaid, to the address given to you by support personnel. Be sure to write the RMA number on the shipping slip. *EXFO will refuse and return any package that does not bear an RMA number.*

Note: *A test setup fee will apply to any returned unit that, after test, is found to meet the applicable specifications.*

After repair, the equipment will be returned with a repair report. If the equipment is not under warranty, you will be invoiced for the cost appearing on this report. EXFO will pay return-to-customer shipping costs for equipment under warranty. Shipping insurance is at your expense.

Routine recalibration is not included in any of the warranty plans. Since calibrations/verifications are not covered by the basic or extended warranties, you may elect to purchase FlexCare Calibration/Verification Packages for a definite period of time. Contact an authorized service center (see *EXFO Service Centers Worldwide* on page 292).

Warranty

EXFO Service Centers Worldwide

EXFO Service Centers Worldwide

If your product requires servicing, contact your nearest authorized service center.

EXFO Headquarters Service Center

400 Godin Avenue
Quebec (Quebec) G1M 2K2
CANADA

1 866 683-0155 (USA and Canada)
Tel.: 1 418 683-5498
Fax: 1 418 683-9224
quebec.service@exfo.com

EXFO Europe Service Center

Omega Enterprise Park, Electron Way
Chandlers Ford, Hampshire S053 4SE
ENGLAND

Tel.: +44 2380 246810
Fax: +44 2380 246801
europe.service@exfo.com

EXFO China Service Center/ Beijing OSIC

Beijing New Century Hotel
Office Tower, Room 1754-1755
No. 6 Southern Capital Gym Road
Beijing 100044
P. R. CHINA

Tel.: +86 (10) 6849 2738
Fax: +86 (10) 6849 2662
beijing.service@exfo.com

A Technical Specifications



IMPORTANT

The following technical specifications can change without notice. The information presented in this section is provided as a reference only. To obtain this product's most recent technical specifications, visit the EXFO Web site at www.exfo.com.

All specifications valid at 23 °C ± 2 °C with an FC/PC connector, unless otherwise specified.

SPECIFICATIONS

All specifications below apply to the FTB-7200D-12CD-23B multimode (MM)/singlemode (SM) model and the FTB-7200D-12CD multimode-only version.

Model	Wavelength (nm) ^a	Dynamic range ^{b, c} (dB)	Event dead zone ^d (m)	Attenuation dead zone ^d (m)
FTB-7200D-12CD	850 ± 20/1300 ± 20	27/26	1/1	3/4
FTB-7200D-12CD-23B	1310 ± 20/1550 ± 20	36/34	1/1	4.5/5
Distance range (km)	Multimode: 0.1, 0.3, 0.5, 1.3, 2.5, 5, 10, 20, 40 Singlemode: 1.3, 2.5, 5, 10, 20, 40, 80, 160, 260			
Pulse width (ns)	Multimode: 5, 10, 30, 100, 275, 1000 Singlemode: 5, 10, 30, 100, 275, 1000, 2500, 10 000, 20 000			
Launch conditions ^e	Class CPR 1 or 2			
Linearity (dB/dB)	±0.03			
Loss threshold (dB)	0.01			
Loss resolution (dB)	0.001			
Sampling resolution (m)	Multimode: 0.04 to 2.5 Singlemode: 0.04 to 5			
Sampling points	Up to 128 000			
Distance uncertainty ^f (m)	± (0.75 + 0.0025 % x distance + sampling resolution)			
Measurement time	User-defined (60 min maximum)			
Typical real-time refresh (Hz)	3			
Stable source output power ^g (dBm)	-1.5 (1300 nm), -7 (1550 nm)			
Visual fault locator (optional)	Laser, 650 nm ± 10 nm CW, typical P _{out} in 62.5/125 µm: 3 dBm (2 mW)			

NOTES

- Typical.
- Typical dynamic range with longest pulse and three-minute averaging at SNR = 1.
- Multimode dynamic range is specified for 62.5 µm fiber; a 3 dB reduction is seen when testing 50 µm fiber.
- Typical dead zone for multimode reflectance below -35 dB and singlemode reflectance below -45 dB, using a 5 ns pulse.
- For multimode port, controlled launch conditions allow 50 µm and 62.5 µm multimode fiber testing.
- Does not include uncertainty due to fiber index.
- Typical output power is given at 1300 nm for multimode output and 1550 nm for singlemode output.

SINGLEMODE OTDR MODULE SPECIFICATIONS

Model ^h	Wavelength ⁱ (nm)	Dynamic range at 20 µs ^j (dB)	Event dead zone ^k (m)	Attenuation dead zone ^k (m)
FTB-7200D-XXX	1310 ± 20/1550 ± 20	36/34	1	4.5/5
FTB-7300E-XXX-XX ^o	1310 ± 20/1490 ± 10/1550 ± 20/1625 ± 10/1650 ± 5	39/35/37/39/37 ⁿ	0.8	4/4.5/4.5/4.5/4.5
FTB-7400E-XXXX	1310 ± 20/1383 ± 1/1550 ± 20/1625 ± 10	42/40/41/41	0.8	4/4/4.5/4.5
FTB-7500E-XX ^l	1310 ± 20/1550 ± 20/1625 ± 10	45/45/45	0.8	4/4.5/4.5
FTB-7600E-XX	1310 ± 20/1550 ± 20/1625 ± 10	50/50/48 ^m	1/1.5/1	5/5/5

NOTES

- For complete details on all available configurations, refer to the Ordering Information section.
- Typical.
- Typical dynamic range with a three-minute averaging at SNR = 1.
- Typical dead zone of singlemode modules for reflectance below -45 dB, using a 5 ns pulse.
- Typical dynamic range at 1550 nm for the FTB-7500E-0023B configuration is 2 dB lower.
- With NZDS fiber (G.655).
- Non-SM Live 1625 nm dynamic range is 37 dB.
- SM Live port built in filter's bandpass: 1625 nm ± 15 nm/1650 nm ± 5 nm.

Technical Specifications

GENERAL SPECIFICATIONS

	7200D	7300E-B/7400E-B/7500E-B/7600E-B
Distance range (km)	1.25, 2.5, 5, 10, 20, 40, 80, 160, 260	1.25, 2.5, 5, 10, 20, 40, 80, 160, 260, 400
Pulse width (ns) ^r	5, 10, 30, 100, 275, 1000, 2500, 10 000, 20 000	5, 10, 30, 100, 275, 1000, 2500, 10 000, 20 000
Linearity (dB/dB)	±0.03	±0.03
Loss threshold (dB)	0.01	0.01
Loss resolution (dB)	0.001	0.001
Sampling resolution (m)	0.04 to 5	0.04 to 5
Sampling points	Up to 128 000	Up to 256 000
Distance uncertainty ^p (m)	± (0.75 + 0.0025 % x distance + sampling resolution)	± (0.75 m + 0.001 % x distance + sampling resolution)
Measurement time	User-defined (60 min maximum)	User-defined (5 sec minimum to 60 min maximum)
Typical real-time refresh (Hz)	3	4
Stable source output power ^q (dBm)	-7 (7200D)	-2.5 (7300E), -4.5 (7400E-0023B), 1 (7500E-0034B), 5 (7600E-0023B)
Visual fault locator (optional)	Laser, 650 nm ± 10 nm CW, typical P _{out} in 62.5/125 μm: 3 dBm (2 mW)	Laser, 650 nm ± 10 nm CW, typical P _{out} in 62.5/125 μm: 3 dBm (2 mW)

NOTES

p. Does not include uncertainty due to fiber index.

q. Typical output power value at 1550 nm.

r. FTB-7300E models include a 50 ns and 500 ns pulse width.

B *Description of Event Types*

This section describes all types of events that may appear in the events table generated by the application. Here is a guide to the descriptions:

- Each type of event has its own symbol.
- Each type of event is represented by a graph of a fiber trace, which illustrates the power reflected back toward the source as a function of distance.
- An arrow points to the location of the event type in the trace.
- Most graphs show one complete trace; that is, an entire acquisition range.
- Some graphs show only a portion of the entire range to view events of interest more closely.

Description of Event Types

Span Start

Span Start

The Span Start of a trace is the event that marks the beginning of the fiber span. By default, the Span Start is placed on the first event of a tested fiber (typically the first connector of the OTDR itself).

You can make another event the start of the span you want to focus your analysis on. This will set the beginning of the events table at a specific event along the trace.

Span End

The Span End of a trace is the event that marks the end of the fiber span. By default, the Span End is placed on the last event of a tested fiber, and is called the end-of-fiber event.

You can also make another event the end of the span you want to focus your analysis on. This will set the end of the events table at a specific event along the trace.

Short Fibers

You can test short fibers with the application. You can even define a fiber span for short fibers by placing the span start and the span end on the same event.

Continuous Fiber ----

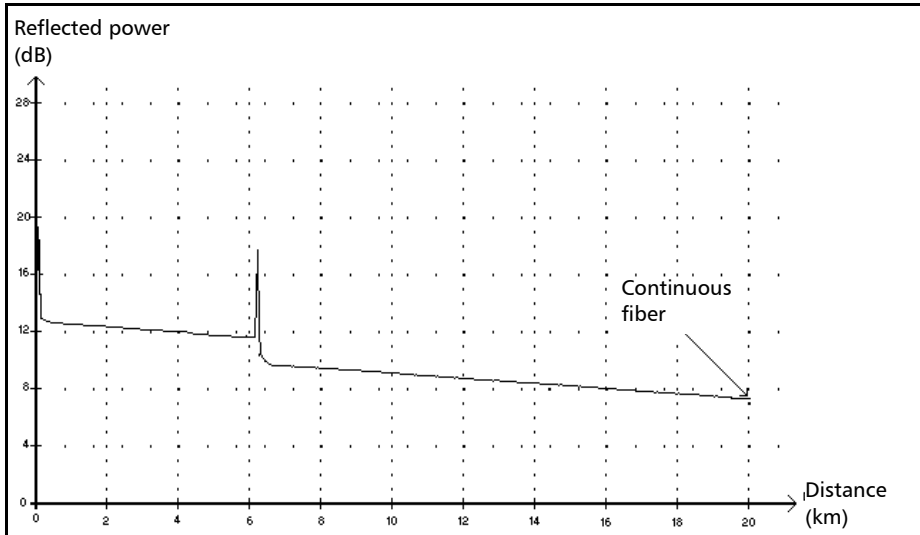

This event indicates that the selected acquisition range was shorter than the fiber length.

- The fiber end was not detected because the analysis process ended before reaching the end of the fiber.
- The acquisition distance range should therefore be increased to a value greater than the fiber length.
- There is no loss or reflectance specified for continuous fiber events.

Description of Event Types

End of Analysis

End of Analysis →

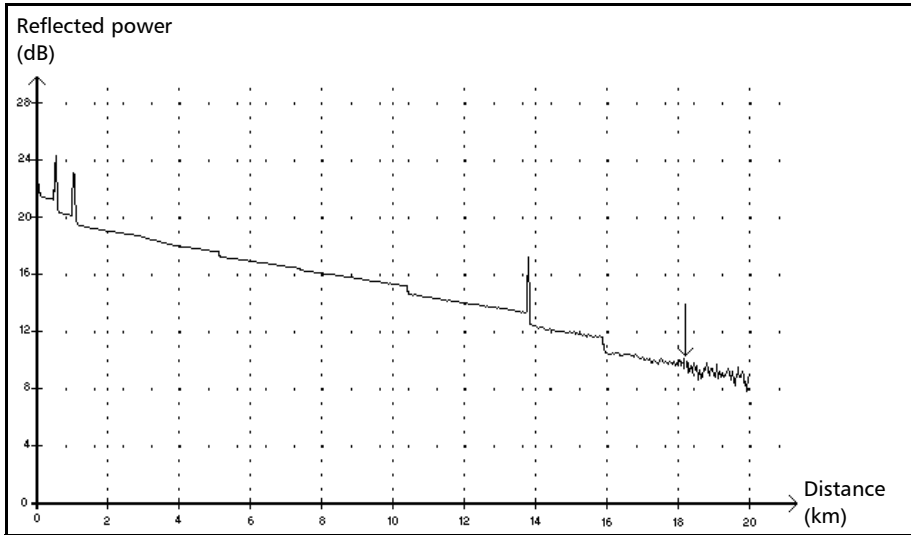

This event indicates that the pulse width used did not provide enough dynamic range to get to the end of the fiber.

- The analysis ended before reaching the end of the fiber because the signal-to-noise ratio was too low.
- The pulse width should therefore be increased so the signal reaches the end of the fiber with a sufficient signal-to-noise ratio.
- There is no loss or reflectance specified for end-of-analysis events.

Non-Reflective Event

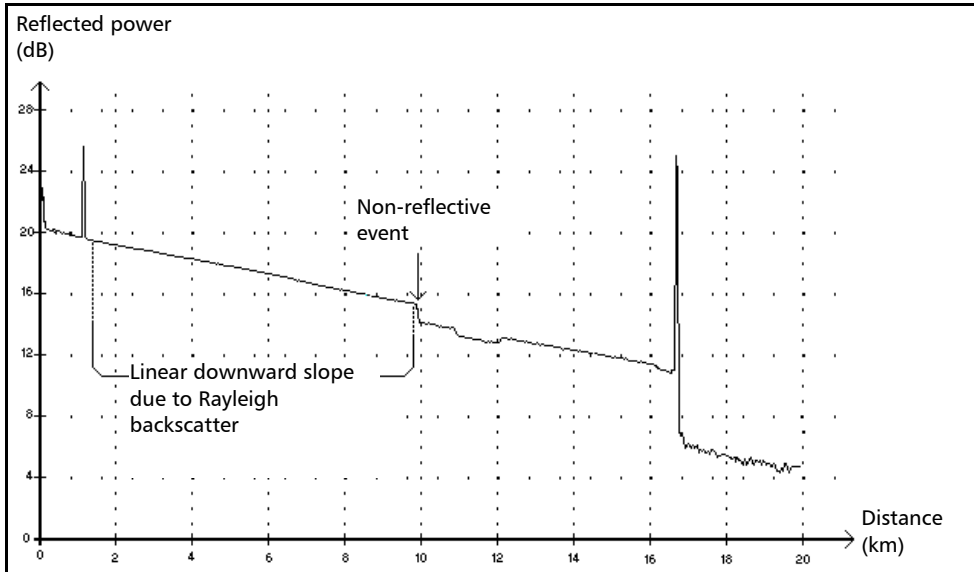

This event is characterized by a sudden decrease in the Rayleigh backscatter signal level. It appears as a discontinuity in the downward slope of the trace signal.

- This event is often caused by splices, macrobends, or microbends in the fiber.
- A loss value is specified for non-reflective events. There is no reflectance specified for this type of event.
- If you set thresholds, the application indicates a non-reflective fault in the events table, whenever a value exceeds the loss threshold (see *Setting Pass/Fail Thresholds* on page 80).

Description of Event Types

Reflective Event

Reflective Event ▮

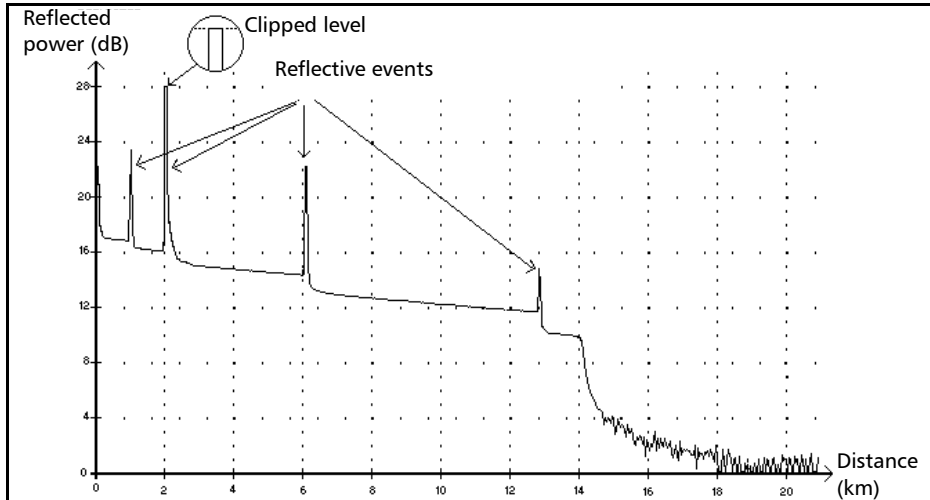

Reflective events appear as spikes in the fiber trace. They are caused by an abrupt discontinuity in the index of refraction.

- Reflective events cause a significant portion of the energy initially launched into the fiber to be reflected back toward the source.
- Reflective events may indicate the presence of connectors, mechanical splices, or even poor-quality fusion splices or cracks.
- Normally, loss and reflectance values are specified for reflective events.
- When the reflective spike reaches the maximum level, its top may be clipped due to the saturation of the detector. As a result, the dead zone (minimum distance for making a detection or attenuation measurement between this event and a second nearby) may be increased.
- If you set thresholds, the application indicates a reflective fault in the events table, whenever a value exceeds reflectance or connector loss thresholds (see *Setting Pass/Fail Thresholds* on page 80).

Positive Event

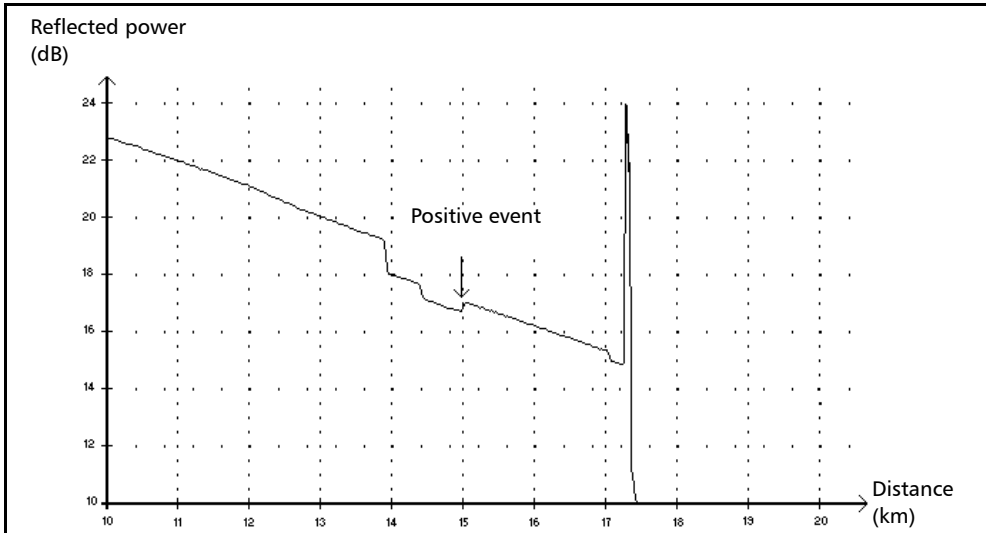

This event indicates a splice with an apparent gain, due to the junction of two fiber sections having different fiber backscatter characteristics (backscatter and backscatter capture coefficients).

- A loss value is specified for positive events. The loss specified does not indicate the true loss of the event.
- The true loss has to be measured by performing bidirectional fiber measurements and bidirectional analysis.

Description of Event Types

Launch Level

Launch Level →

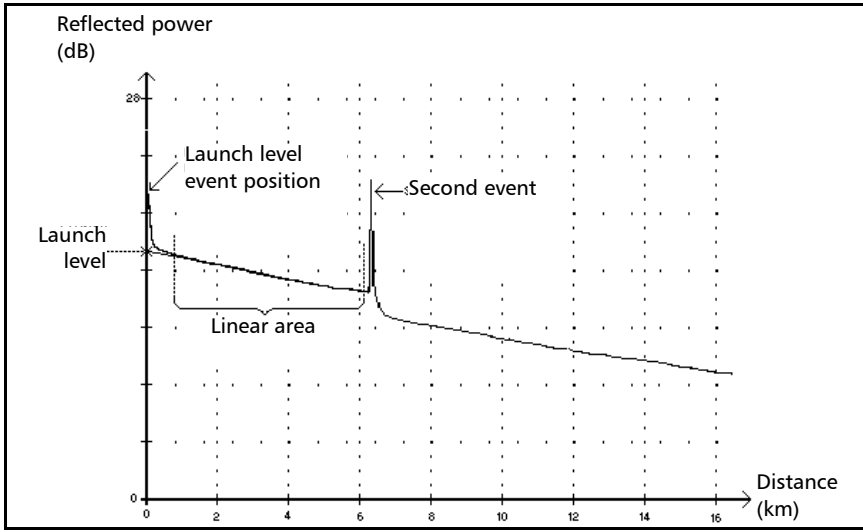

This event indicates the level of the signal launched into the fiber.

- The figure above shows how the launch level is measured.

A straight line is plotted using least-square approximation to fit all trace points in the linear area between the first and second detected events.

The straight line is projected toward the Y-axis (dB) until it crosses the axis.

The crossing point indicates the launch level.

- <<<< in the events table indicates that the launch level is too low.

Fiber Section

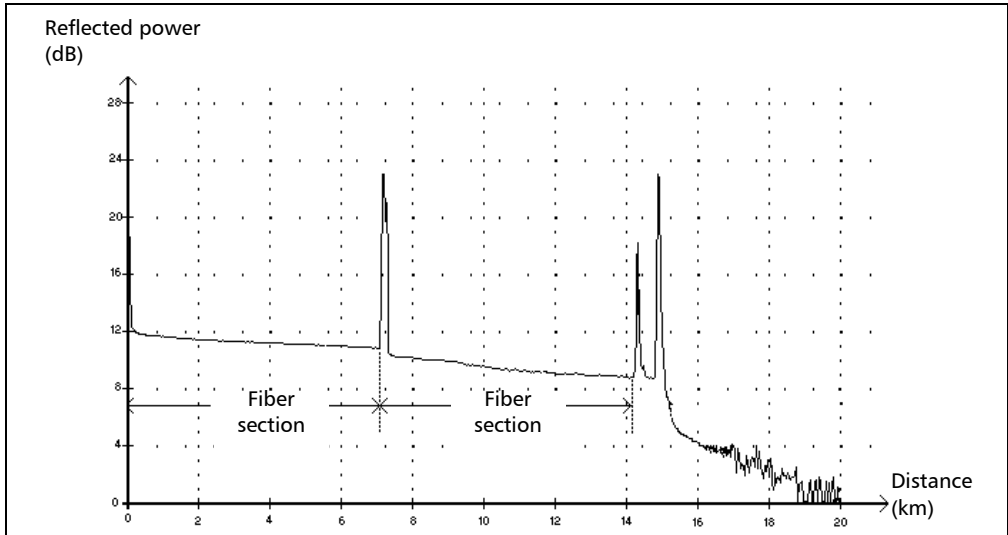

This symbol denotes a fiber section with no event.

- The sum of all fiber sections contained in an entire fiber trace equals the total fiber length. Detected events are distinct even if they cover more than one point on the trace.
- A loss value is specified for fiber section events. No reflectance is specified for this type of event.
- The attenuation (dB/distance in kilometers) is obtained by dividing the loss by the fiber section length.

Description of Event Types

Merged Reflective Event

Merged Reflective Event Σ

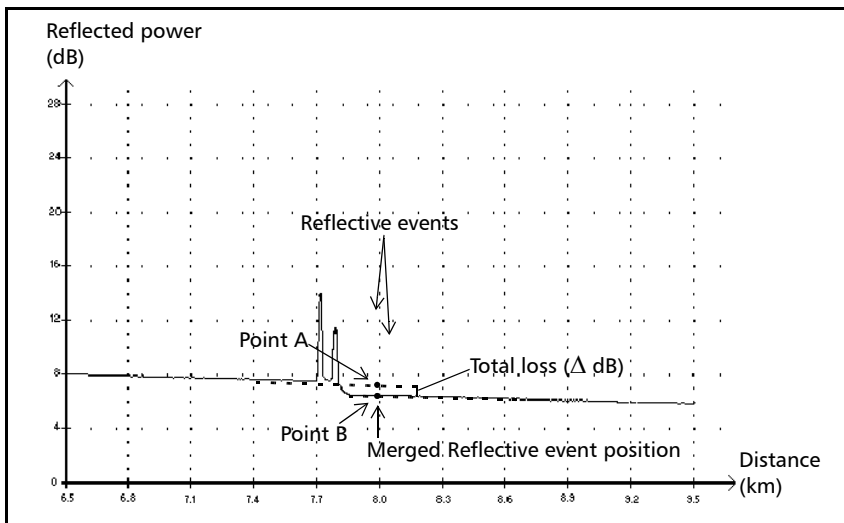

This symbol denotes a reflective event combined with one or more other reflective events. It also indicates the total loss produced by the merged reflective events following it in the events table.

- A Merged Reflective Event is composed of reflective events. Only the Merged Reflective Event is attributed a number in the events table, not the reflective subevents composing it, if they are displayed.
- Reflective events may indicate the presence of connectors, mechanical splices, or poor-quality fusion splices or cracks.
- A reflectance value is specified for all merged reflective events and indicates the maximum reflectance for the merged event. A reflectance value is also displayed for each subevent composing the Merged Reflective Event.

- The total loss (Δ dB) produced by the events is measured by plotting two straight lines.
 - The first line is plotted by fitting, through least-square approximation, trace points in the linear area preceding the first event.
 - The second line is plotted by fitting, through least-square approximation, trace points in the linear area following the second event. If there were more than two merged events, this line would be plotted in the linear area following the last merged event. This line is then projected toward the first merged event.
 - The total loss (Δ dB) equals the power difference between the point where the first event begins (point A) and the point on the projected straight line located just below the first event (point B).
 - No loss value can be specified for the subevents.

Description of Event Types

Echo

Echo Π_{nr}

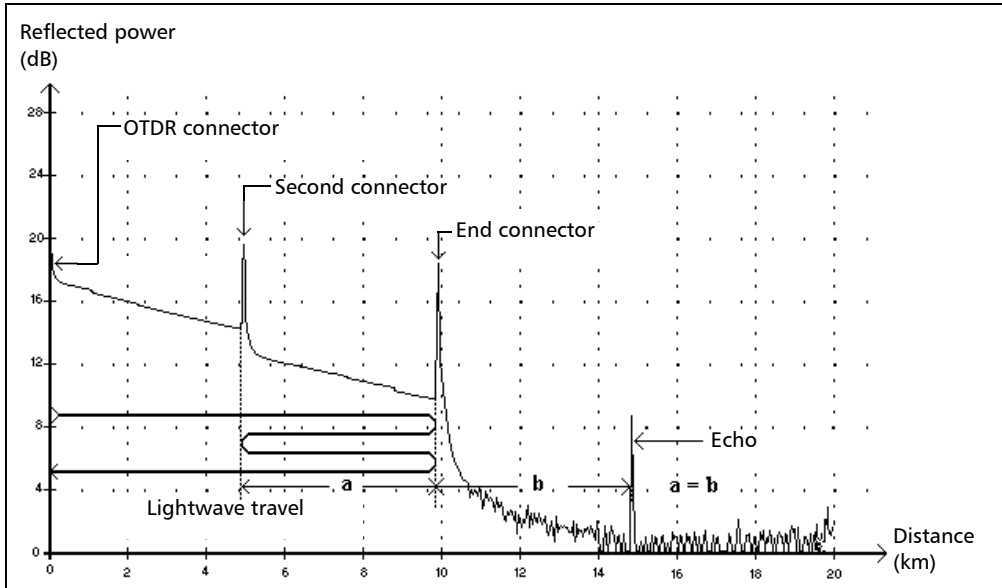

This symbol indicates that a reflective event has been detected after the end of the fiber.

- In the example above, the launched pulse travels up to the end connector and is reflected back toward the OTDR. Then, it reaches the second connector and is reflected again toward the end connector. It is then reflected back to the OTDR.
- The application interprets this new reflection as an echo because of its characteristics (reflectance and particular position with respect to other reflections).
- The distance between the second connector reflection and the end connector reflection is equal to the distance between the end connector reflection and the echo.
- There is no loss specified for echo events.

Reflective Event (Possible Echo)

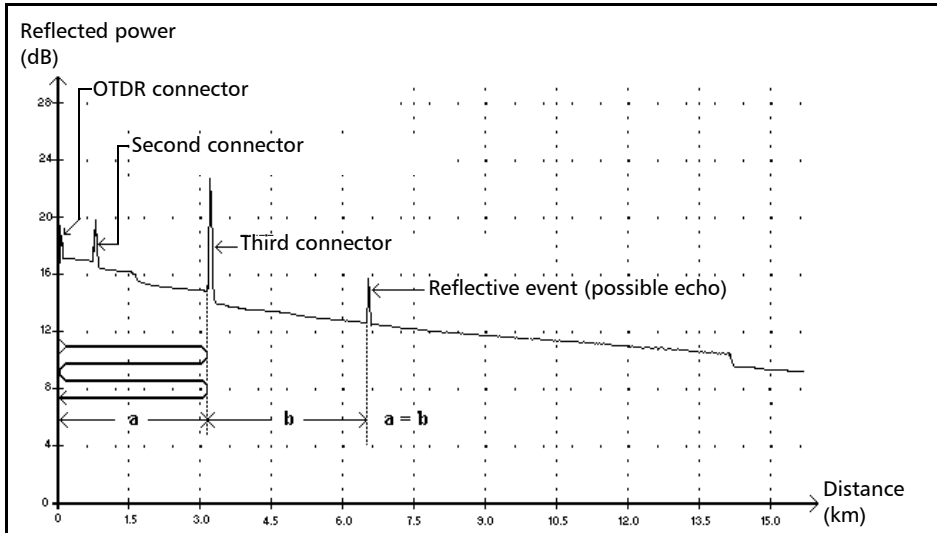

This symbol indicates a reflective event that can be a real reflection or an echo produced by another stronger reflection located closer to the source.

- In the example above, the launched pulse hits the third connector, is reflected back to the OTDR and reflected again into the fiber. It then reaches the third connector a second time and is reflected once more to the OTDR.

The application would therefore detect a reflective event located at twice the distance of the third connector. Since this event is almost null (no loss), and since its distance is a multiple of the third connector distance, The application would interpret it as a possible echo.

- A reflectance value is specified for reflective events (possible echo).

C **SCPI Command Reference**

This appendix presents detailed information on the commands and queries supplied with your FTB-7000 Series OTDR.



IMPORTANT

Since the FTB-400 can house many instruments, you must explicitly specify which instrument you want to remotely control.

You must add the following mnemonic *at the beginning of any command or query* that you send to an instrument:

LINstrument<LogicalInstrumentPos>:

where *<LogicalInstrumentPos>* corresponds to the identification number of the instrument.

FTB-400 backplane identification number

|

1Y

|

Instrument slot number:

2-slot backplane: 0 or 1;

7-slot backplane: 0 to 6

For information on modifying unit identification, refer to your platform user guide.

SCPI Command Reference

Quick Reference Command Tree

Quick Reference Command Tree

Command					Parameter(s)	P.
ABORt[1..n]						316
CALCulate[1..n]	ANALysis	[UNIDirectional]			TRC1 TRC2 TRC3 TRC4	317
	ATTenuation?				TRC1 TRC2 TRC3 TRC4,<MarkerA>,<MarkerB>	318
	CLValue?				TRC1 TRC2 TRC3 TRC4,<MarkerA>	320
	EVENT?				TRC1 TRC2 TRC3 TRC4,<EventIndex>	322
	EVENT	COUN?			TRC1 TRC2 TRC3 TRC4	325
	HFACTor				TRC1 TRC2 TRC3 TRC4,<HelixFactor>	327
	HFACTor?				TRC1 TRC2 TRC3 TRC4	329
	IORefraction				TRC1 TRC2 TRC3 TRC4,<IOR>	331
	IORefraction?				TRC1 TRC2 TRC3 TRC4	333
	LOSS?				TRC1 TRC2 TRC3 TRC4,<MarkerA>,<MarkerB>	335
	ORL?				TRC1 TRC2 TRC3 TRC4,<MarkerA>,<MarkerB>	337
	REFlectance?				TRC1 TRC2 TRC3 TRC4,<SubMarkerA>,<MarkerA>,<MarkerB>	339
	RBScatter				TRC1 TRC2 TRC3 TRC4,<RBS>	342
	RBScatter?				TRC1 TRC2 TRC3 TRC4	344
	SLOSs?				TRC1 TRC2 TRC3 TRC4,<SubMarkerA>,<MarkerA>,<MarkerB>,<SubMarkerB>	346

SCPI Command Reference

Quick Reference Command Tree

Command					Parameter(s)	P.
	THReshold	EOFiber			TRC1 TRC2 TRC3 TRC4,<End-of-Fiber>	349
		EOFiber?			TRC1 TRC2 TRC3 TRC4	351
		REFlectance			TRC1 TRC2 TRC3 TRC4,<Reflectance>	352
		REFlectance?			TRC1 TRC2 TRC3 TRC4	354
		SLOSs			TRC1 TRC2 TRC3 TRC4,<Splice Loss>	356
		SLOSs?			TRC1 TRC2 TRC3 TRC4	358
		TORL?			TRC1 TRC2 TRC3 TRC4	359
CONFigure 1..n	ACQuisition				<Wavelength>,<Range>,<Pulse>	361
		DURation			<Duration> MAXimum MINimum DEfault	363
		DURation?			[MINimum MAXimum DEfault]	364
		HRESolution			<HighResolution>	366
		HRESolution?				367
		MODE			ACQuisition ASEtting CFConnector REAltime	368
		MODE?				370
		PULSe?				371
		PULSe	LIST?		<Wavelength>,<Range>	372
		RANGE?				374
		RANGE	LIMit	HIGH?	<Wavelength>	375
				LOW?	<Wavelength>	376
			LIST?		<Wavelength>	377

SCPI Command Reference

Quick Reference Command Tree

Command					Parameter(s)	P.
		WAVelength?				378
		WAVelength	LIST?			379
	ANAlysis	HFACTOR			<HelixFactor> MAXimum MINimum DEFault	380
		HFACTOR?			[MINimum MAXimum DEFault]	381
		IORefraction			<IOR> MAXimum MINimum DEFault	382
		IORefraction?			[MINimum MAXimum DEFault]	383
		RBSscatter			<RBS> MAXimum MINimum DEFault	384
		RBSscatter?			[MINimum MAXimum DEFault]	385
		THReshold	EOFiber		<End-of-Fiber> MAXimum MINimum DEFault	386
			EOFiber?		[MINimum MAXimum DEFault]	387
			REFlectance		<Reflectance> MAXimum MINimum DEFault	388
			REFlectance?		[MINimum MAXimum DEFault]	389
			SLOSS		<Splice Loss> MAXimum MINimum DEFault	390
			SLOSS?		[MINimum MAXimum DEFault]	391
ERRor[1..n]?						392
FETCH[1..n]	ASETting	DURATION?				394
		PULSE?				395
		RANGE?				396
	CFConnector?					397
	DURATION?				TRC1 TRC2 TRC3 TRC4	398

SCPI Command Reference

Quick Reference Command Tree

Command						Parameter(s)	P.
	HRESolution?					TRC1 TRC2 TRC3 TRC4	399
	LFIBer?						400
	PULSe?					TRC1 TRC2 TRC3 TRC4	401
	RANGe?					TRC1 TRC2 TRC3 TRC4	402
	STEP?					TRC1 TRC2 TRC3 TRC4	403
	TRACe[1..n]	[DATA]?					404
		POINts?					405
	WAVelength?					TRC1 TRC2 TRC3 TRC4	406
INITiate[1..n]	[IMMediate]						407
	STATe?						408
MMEMory[1..n]	DATA	TYPE				BINary ASCii BELLcore	409
		TYPE?					410
	LOAD	NAME?					411
		TRACe				<FileName>	412
	STORe	TRACe				<FileName>	413
			OVERwrite			<Overwrite>	414
			OVERwrite?				416
SOURce[1..n]	FREQuency	BURSt				<BurstFrequency> MAXimum MINimum DEFAult	417
		BURSt?				[MINimum MAXimum DEFAult]	419
		BURSt	STATe			<State>	421
			STATe?				422

SCPI Command Reference

Quick Reference Command Tree

Command					Parameter(s)	P.
		PRF			<PulsedRepetitionFrequency> MAXimum MINimum DEFault	423
		PRF?			[MINimum MAXimum DEFault]	425
		PRF	STATE		<State>	427
			STATE?			428
	POWer	STATE			<State>	429
		STATE?				430
		STATE	TIME		<Duration>	431
			TIME?			432
	VFLocator	AM	INternal	FREQuency	<Frequency> MAXimum MINimum DEFault	433
				FREQuency?	[MINimum MAXimum DEFault]	435
			STATE		<State>	437
			STATE?			438
		POWER	STATE		<State>	439
			STATE?			440
			STATE	TIME	<Duration> MAXimum MINimum DEFault	441
				TIME?	[MINimum MAXimum DEFault]	443
	WAVelength				<Wavelength> MAXimum MINimum DEFault	445
	WAVelength?				[MINimum MAXimum DEFault]	446
	WAVelength	LIST?				448

SCPI Command Reference

Quick Reference Command Tree

Command						Parameter(s)	P.
TRACe[1..n]	[DATA]?					TRC1 TRC2 TRC3 TRC4	449
	CATalog?						451
	POINts?					TRC1 TRC2 TRC3 TRC4	452

Product-Specific Commands—Description

:ABORt[1..n]

Description

This command is used to stop the scan, measurement or acquisition in progress.

This command is an event and, therefore, has no associated *RST condition or query form. However, on *RST, the equivalent of an ABORt command is performed on any acquisition in progress.

*RST does not affect this command.

Syntax

:ABORt[1..n]

Parameter(s)

None

Example(s)

INIT
ABOR

See Also

INITiate[1..n]:STATe?
ERRor[1..n]?

:CALCulate[1..n]:ANALysis [:UNIDirectional]

Description	<p>This command performs a unidirectional analysis. It creates or modifies the event table for the specified trace index acquisition data.</p> <p>For this command to be accepted, at least one acquisition must be performed.</p> <p>*RST does not affect this command.</p>
Syntax	:CALCulate[1..n]:ANALysis[:UNIDirectional] <wsp> >TRC1 TRC2 TRC3 TRC4
Parameter(s)	<p><i>Label:</i></p> <p>The program data syntax for the first parameter is defined as a <CHARACTER PROGRAM DATA> element. The allowed <CHARACTER PROGRAM DATA> elements for this parameter are: TRC1 TRC2 TRC3 TRC4.</p> <p>Trace index of the available wavelengths.</p>
Example(s)	<pre>CONF:ACQ:MODE ACQUISITION INIT INIT:STAT? Returns 0 when acquisition is complete. CALC:ANA TRC1</pre>
See Also	<pre>CALCulate[1..n]:EVENT:COUNT? CALCulate[1..n]:EVENT? MMEORY[1..n]:LOAD:TRACe TRACe[1..n]:CATalog?</pre>

:CALCulate[1..n]:ATTenuation?

Description	<p>This query returns the value of the attenuation measured between two markers, for the trace corresponding to the specified trace index.</p> <p>*RST clears this setting.</p>
Syntax	<p>:CALCulate[1..n]:ATTenuation?<wsp>TRC1 TRC2 TRC3 TRC4,<MarkerA>,<MarkerB></p>
Parameter(s)	<p>➤ <i>Label:</i></p> <p>The program data syntax for the first parameter is defined as a <CHARACTER PROGRAM DATA> element. The allowed <CHARACTER PROGRAM DATA> elements for this parameter are: TRC1 TRC2 TRC3 TRC4.</p> <p>Trace index of the available wavelengths.</p> <p>➤ <i>MarkerA:</i></p> <p>The program data syntax for <MarkerA> is defined as a <DECIMAL NUMERIC PROGRAM DATA> element.</p> <p>Specifies the marker A position, in meters.</p> <p>➤ <i>MarkerB:</i></p> <p>The program data syntax for <MarkerB> is defined as a <DECIMAL NUMERIC PROGRAM DATA> element.</p> <p>Specifies the marker B position, in meters.</p>
Response Syntax	<p><Attenuation></p>

:CALCulate[1..n]:ATTenuation?

Response(s)

Attenuation:

The response data syntax for <Attenuation> is defined as a <NR3 NUMERIC RESPONSE DATA> element.

Returns the attenuation value in dB/meter, between marker A and marker B.

Example(s)

CONF:ACQ:MODE ACQUISITION
INIT

INIT:STAT? Returns 0 when acquisition is complete.

CALC:ATT? TRC1,0,102.6 Ex.: Returns 1.963

CALC:ATT? TRC1,0 M,0.1026 KM Ex.: Returns 1.963

CALC:ATT? TRC1,0 KM,102.6 M Ex.: Returns 1.963

See Also

MMEMemory[1..n]:LOAD:TRACe
TRACe[1..n]:CATalog?

:CALCulate[1..n]:CLValue?

Description	<p>This query returns the curve level value at a specific position, for the trace corresponding to the specified trace index.</p> <p>*RST clears this setting.</p>
Syntax	<p>:CALCulate[1..n]:CLValue? <wsp>TRC1 TRC2 TRC3 TRC4,<MarkerA></p>
Parameter(s)	<p>➤ <i>Label:</i></p> <p>The program data syntax for the first parameter is defined as a <CHARACTER PROGRAM DATA> element. The allowed <CHARACTER PROGRAM DATA> elements for this parameter are: TRC1 TRC2 TRC3 TRC4.</p> <p>Trace index of the available wavelengths.</p> <p>➤ <i>MarkerA:</i></p> <p>The program data syntax for <MarkerA> is defined as a <DECIMAL NUMERIC PROGRAM DATA> element.</p> <p>Specifies the marker A position, in meters.</p>
Response Syntax	<p><Current Level Value></p>

:CALCulate[1..n]:CLValue?

Response(s)

Current Level Value:

The response data syntax for <Current Level Value> is defined as a <NR3 NUMERIC RESPONSE DATA> element.

Returns the curve level value in dB, at the position specified by marker A.

Example(s)

CONF:ACQ:MODE ACQUISITION
INIT

INIT:STAT? Returns 0 when acquisition is complete.

CALC:CLV? TRC1,100.3 Ex.: Returns -20.371

CALC:CLV? TRC1,0.1003 KM Ex.: Returns -20.371

CALC:CLV? TRC1,100.3 M Ex.: Returns -20.371

See Also

CALCulate[1..n]:ANALysis:[UNIDirectional]
CALCulate[1..n]:EVENT:COUNT?
CALCulate[1..n]:EVENT?
MMEMory[1..n]:LOAD:TRACe
TRACe[1..n]:CATalog?

:CALCulate[1..n]:EVENT?

Description	<p>This query returns an event from the event table after performing an analysis on the trace corresponding to the specified trace index. You must supply the index of the event that you want to retrieve.</p> <p>*RST clears the event table.</p>
Syntax	<p>:CALCulate[1..n]:EVENT?<wsp>TRC1 TRC2 TRC3 TRC4,<EventIndex></p>
Parameter(s)	<p>► <i>Label:</i></p> <p>The program data syntax for the first parameter is defined as a <CHARACTER PROGRAM DATA> element. The allowed <CHARACTER PROGRAM DATA> elements for this parameter are: TRC1 TRC2 TRC3 TRC4.</p> <p>Trace index of the available wavelengths.</p> <p>► <i>EventIndex:</i></p> <p>The program data syntax for <EventIndex> is defined as a <DECIMAL NUMERIC PROGRAM DATA> element.</p> <p>Sets the event index. This value must be between 1 and the total number of events.</p>
Response Syntax	<p><Event></p>

:CALCulate[1..n]:EVENT?

Response(s)

Event:

The response data syntax for <Event> is defined as a <DEFINITE LENGTH ARBITRARY BLOCK RESPONSE DATA> element.

Returns the event from the event table corresponding to the specified trace index.

Event structure is in A, B, C, D, E format, where:
 A = Location (always in meters) <NR3 NUMERIC RESPONSE DATA>
 B = EventType <NR1 NUMERIC RESPONSE DATA>
 C = Loss (always in dB) <NR3 NUMERIC RESPONSE DATA>

:CALCulate[1..n]:EVENT?

D = Reflectance (always in dB) <NR3 NUMERIC RESPONSE DATA>

E = Cumulative (always in dB) <NR3 NUMERIC RESPONSE DATA>

Here is the list of all possible event types:

1 = Positive splice

2 = Negative splice

3 = Reflection

4 = End of analysis

The End of analysis event does not necessarily correspond to the last event of a fiber link. It indicates that the analysis has stopped before the end of the link because the instrument has reached the limit of its dynamic range.

In most cases, the OTDR analysis will return the type of the last event as being either reflective or non-reflective (event type 3 or 2).

Example(s)

```
CONF:ACQ:MODE ACQUISITION  
INIT
```

INIT:STAT? Returns 0 when acquisition is complete.

```
CALC:ANA TRC1
```

CALC:EVEN:COUN? TRC1 Ex.: Returns 4 (corresponding to 4 events).

CALC:EVEN? TRC1,1 (where 1 is the event number. Values 1 to 4 are valid). Returns the event corresponding to the specified number.

See Also

```
MMEMemory[1..n]:LOAD:TRACe  
TRACe[1..n]:CATALog?
```

:CALCulate[1..n]:EVENT:COUNT?

Description

This query returns the number of events after performing an analysis on the trace corresponding to the specified trace index.

Since *RST clears the event table, the number of events will be 0.

Syntax

:CALCulate[1..n]:EVENT:COUNT? <wsp>TRC1 | TRC2 | TRC3 | TRC4

Parameter(s)

Label:

The program data syntax for the first parameter is defined as a <CHARACTER PROGRAM DATA> element. The allowed <CHARACTER PROGRAM DATA> elements for this parameter are: TRC1 | TRC2 | TRC3 | TRC4.

Trace index of the available wavelengths.

:CALCulate[1..n]:EVENT:COUNT?

Response Syntax <EventCount>

Response(s) *EventCount:*

The response data syntax for <EventCount> is defined as a <NR1 NUMERIC RESPONSE DATA> element.

Returns the number of available events for the specified trace index.

Example(s)

CONF:ACQ:MODE ACQUISITION

INIT

INIT:STAT? Returns 0 when acquisition is complete.

CALC:ANA TRC1

CALC:EVEN:COUN? TRC1 Ex.: Returns 4 (corresponding to 4 events).

CALC:EVEN? TRC1,1 (where 1 is the event number. Values 1 to 4 are valid). Returns the event corresponding to the specified number.

:CALCulate[1..n]:HFACTOR**Description**

This command sets the helix factor that will be used for the specified trace index. Using this command will recalculate the event table automatically.

*RST clears this setting.

Syntax

:CALCulate[1..n]:HFACTOR<wsp>TRC1|TRC2|TRC3|TRC4,<HelixFactor>

:CALCulate[1..n]:HFACtor

Parameter(s)	<p>➤ <i>Label:</i></p> <p>The program data syntax for the first parameter is defined as a <CHARACTER PROGRAM DATA> element. The allowed <CHARACTER PROGRAM DATA> elements for this parameter are: TRC1 TRC2 TRC3 TRC4.</p> <p>Trace index of the available wavelengths.</p> <p>➤ <i>HelixFactor:</i></p> <p>The program data syntax for <HelixFactor> is defined as a <DECIMAL NUMERIC PROGRAM DATA> element.</p> <p>Sets the helix factor.</p>
Example(s)	<pre>CONF:ANA:HFAC 0 CONF:ACQ:MODE ACQUISITION INIT INIT:STAT? Returns 0 when acquisition is complete. CALC:HFAC? TRC1 Returns 0 CALC:HFAC TRC1,2 CALC:HFAC? TRC1 Returns 2</pre>
See Also	<pre>CALCulate[1..n]:ANALysis:[UNIDirectional] CALCulate[1..n]:EVENT:COUNT? CALCulate[1..n]:EVENT? MMEMory[1..n]:LOAD:TRACe TRACe[1..n]:CATalog?</pre>

:CALCulate[1..n]:HFACtor?

Description	<p>This query returns the helix factor used for the specified trace index.</p> <p>Since *RST clears the helix factor value, the returned value will be 0.</p>
Syntax	:CALCulate[1..n]:HFACtor? <wsp>TRC1 TRC2 TRC3 TRC4
Parameter(s)	<p><i>Label:</i></p> <p>The program data syntax for the first parameter is defined as a <CHARACTER PROGRAM DATA> element. The allowed <CHARACTER PROGRAM DATA> elements for this parameter are: TRC1 TRC2 TRC3 TRC4.</p> <p>Trace index of the available wavelengths.</p>
Response Syntax	<HelixFactor>

SCPI Command Reference

Product-Specific Commands—Description

:CALCulate[1..n]:HFACtor?

Response(s)	<i>HelixFactor:</i> The response data syntax for <HelixFactor> is defined as a <NR3 NUMERIC RESPONSE DATA> element. Returns the helix factor used by the trace corresponding to the specified trace index.
Example(s)	CONF:ANA:HFAC 2 CONF:ACQ:MODE ACQUISITION INIT INIT:STAT? Returns 0 when acquisition is complete. CALC:HFAC? TRC1 Returns 2
See Also	MMEMory[1..n]:LOAD:TRACe TRACe[1..n]:CATalog?

:CALCulate[1..n]:IORefraction

Description

This command sets the index of refraction that will be used for the trace corresponding to the specified trace index. Using this command will recalculate the event table automatically.

*RST clears this setting.

Syntax

:CALCulate[1..n]:IORefraction <wsp> TRC1 | TRC2 | TRC3 | TRC4, <IOR>

:CALCulate[1..n]:IORefraction

Parameter(s)	<p>► <i>Label:</i></p> <p>The program data syntax for the first parameter is defined as a <CHARACTER PROGRAM DATA> element. The allowed <CHARACTER PROGRAM DATA> elements for this parameter are: TRC1 TRC2 TRC3 TRC4.</p> <p>Trace index of the available wavelengths.</p> <p>► <i>IOR:</i></p> <p>The program data syntax for <IOR> is defined as a <DECIMAL NUMERIC PROGRAM DATA> element.</p> <p>Sets the index of refraction.</p>
Example(s)	<pre>CONF:ANA:IOR 1.4677 CONF:ACQ:MODE ACQUISITION INIT INIT:STAT? Returns 0 when acquisition is complete. CALC:IOR? Returns 1.4677 CALC:IOR 1.5 CALC:IOR? Returns 1.5</pre>
See Also	<pre>CALCulate[1..n]:ANALysis:[UNIDirectional] CALCulate[1..n]:EVENT:COUNT? CALCulate[1..n]:EVENT? MMEMory[1..n]:LOAD:TRACe TRACe[1..n]:CATalog?</pre>

:CALCulate[1..n]:IORefraction?

Description	<p>This query returns the index of refraction used for the trace corresponding to the specified trace index.</p> <p>Since *RST clears the index of refraction value, the returned value will be 0.</p>
Syntax	:CALCulate[1..n]:IORefraction? <wsp>TRC1 TRC2 TRC3 TRC4
Parameter(s)	<p><i>Label:</i></p> <p>The program data syntax for the first parameter is defined as a <CHARACTER PROGRAM DATA> element. The allowed <CHARACTER PROGRAM DATA> elements for this parameter are: TRC1 TRC2 TRC3 TRC4.</p> <p>Trace index of the available wavelengths.</p>
Response Syntax	<IOR>

SCPI Command Reference

Product-Specific Commands—Description

:CALCulate[1..n]:IOrefraction?

Response(s)

IOR:

The response data syntax for <IOR> is defined as a <NR3 NUMERIC RESPONSE DATA> element.

Returns the index of refraction used by the trace corresponding to the specified trace index.

Example(s)

```
CONF:ANA:IOR 1.5
CONF:ACQ:MODE ACQUISITION
INIT
INIT:STAT? Returns 0 when acquisition is
complete.
CALC:IOR? TRC1 Returns 1.5
```

See Also

```
MMEMemory[1..n]:LOAD:TRACe
TRACe[1..n]:CATalog?
```

:CALCulate[1..n]:LOSS?

Description	<p>This query returns the loss between two markers measured by least-square approximation, for the trace corresponding to the specified trace index.</p> <p>*RST clears this value.</p>
Syntax	:CALCulate[1..n]:LOSS? <wsp> TRC1 TRC2 TRC3 TRC4, <MarkerA>, <MarkerB>
Parameter(s)	<p>➤ <i>Label:</i></p> <p>The program data syntax for the first parameter is defined as a <CHARACTER PROGRAM DATA> element. The allowed <CHARACTER PROGRAM DATA> elements for this parameter are: TRC1 TRC2 TRC3 TRC4.</p> <p>Trace index of the available wavelengths.</p> <p>➤ <i>MarkerA:</i></p> <p>The program data syntax for <MarkerA> is defined as a <DECIMAL NUMERIC PROGRAM DATA> element.</p> <p>Specifies the marker A position, in meters.</p> <p>➤ <i>MarkerB:</i></p> <p>The program data syntax for <MarkerB> is defined as a <DECIMAL NUMERIC PROGRAM DATA> element.</p> <p>Specifies the marker B position, in meters.</p>
Response Syntax	<Loss>

:CALCulate[1..n]:LOSS?

Response(s)

Loss:

The response data syntax for <Loss> is defined as a <NR3 NUMERIC RESPONSE DATA> element.

Returns the loss value in dB, between marker A and marker B.

Example(s)

CONF:ACQ:MODE ACQUISITION

INIT

INIT:STAT? Returns 0 when acquisition is complete.

CALC:LOSS? TRC1,10,104 Ex.: Returns 0.458

CALC:LOSS? TRC1,10 M,0.104 KM Ex.: Returns 0.458

CALC:LOSS? TRC1,0.01 KM,104 M Ex.: Returns 0.458

See Also

MMEMemory[1..n]:LOAD:TRACe

TRACe[1..n]:CATalog?

:CALCulate[1..n]:ORL?

Description This query returns the value of the Optical Return Loss measured between two markers, for the trace corresponding to the specified trace index.

*RST clears this value.

Syntax :CALCulate[1..n]:ORL?<wsp>TRC1|TRC2|TRC3|TRC4,<MarkerA>,<MarkerB>

Parameter(s) **➤ Label:**
 The program data syntax for the first parameter is defined as a <CHARACTER PROGRAM DATA> element. The allowed <CHARACTER PROGRAM DATA> elements for this parameter are: TRC1|TRC2|TRC3|TRC4.

Trace index of the available wavelengths.

➤ MarkerA:
 The program data syntax for <MarkerA> is defined as a <DECIMAL NUMERIC PROGRAM DATA> element.

Specifies the marker A position, in meters.

➤ MarkerB:
 The program data syntax for <MarkerB> is defined as a <DECIMAL NUMERIC PROGRAM DATA> element.

Specifies the marker B position, in meters.

SCPI Command Reference

Product-Specific Commands—Description

:CALCulate[1..n]:ORL?

Response Syntax	<ORL>
Response(s)	<i>ORL:</i> The response data syntax for <ORL> is defined as a <NR3 NUMERIC RESPONSE DATA> element.
Example(s)	Returns the Optical Return Loss value in dB, between marker A and marker B. CONF:ACQ:MODE ACQUISITION INIT INIT:STAT? Returns 0 when acquisition is complete. CALC:ORL? TRC1,10,100 Ex.: Returns 30.305 CALC:ORL? TRC1,10 M, 0.100 KM Ex.: Returns 30.305 CALC:ORL? TRC1,0.01 KM,100 M Ex.: Returns 30.305
See Also	MMEMory[1..n]:LOAD:TRACe TRACe[1..n]:CATalog?

:CALCulate[1..n]:REFlectance?

Description

This query returns the reflectance value measured between two markers, for the trace corresponding to the specified trace index.

*RST clears this value.

Syntax

:CALCulate[1..n]:REFlectance?<wsp>TRC1|TRC2|TRC3|TRC4,<SubMarkerA>,<MarkerA>,<MarkerB>

:CALCulate[1..n]:REFlectance?

Parameter(s)

► *Label:*

The program data syntax for the first parameter is defined as a <CHARACTER PROGRAM DATA> element. The allowed <CHARACTER PROGRAM DATA> elements for this parameter are: TRC1|TRC2|TRC3|TRC4.

Trace index of the available wavelengths.

► *SubMarkerA:*

The program data syntax for <SubMarkerA> is defined as a <DECIMAL NUMERIC PROGRAM DATA> element.

Specifies the submarker A position, in meters.

► *MarkerA:*

The program data syntax for <MarkerA> is defined as a <DECIMAL NUMERIC PROGRAM DATA> element.

Specifies the marker A position, in meters.

► *MarkerB:*

The program data syntax for <MarkerB> is defined as a <DECIMAL NUMERIC PROGRAM DATA> element.

Specifies the marker B position, in meters.

Response Syntax

<Reflectance>

:CALCulate[1..n]:REFlectance?

Response(s)

Reflectance:

The response data syntax for <Reflectance> is defined as a <NR3 NUMERIC RESPONSE DATA> element.

Returns the reflectance value in dB, calculated using all three markers.

Example(s)

CONF:ACQ:MODE ACQUISITION

INIT

INIT:STAT? Returns 0 when acquisition is complete.

CALC:REF? TRC1,0,0.1 KM,200 Ex.: Returns –24.549

CALC:REF? TRC1,0 M,100,200 M Ex.: Returns –24.549

CALC:REF? TRC1,0 KM,100 M, 0.2 KM Ex.: Returns –24.549

Notes

See the section on reflectance measurement in the FTB-7000 Optical Time Domain Reflectometer user guide.

See Also

CALCulate[1..n]:ANALysis:[UNIDirectional]

CALCulate[1..n]:EVENT:COUNT?

CALCulate[1..n]:EVENT?

MMEMory[1..n]:LOAD:TRACe

TRACe[1..n]:CATalog?

SCPI Command Reference

Product-Specific Commands—Description

:CALCulate[1..n]:RBScatter

Description

This command sets the Rayleigh backscatter that will be used for the trace corresponding to the specified trace index. Using this command will recalculate the event table automatically.

*RST clears this setting.

Syntax

:CALCulate[1..n]:RBScatter<wsp>TRC1|TRC2|TRC3|TRC4,<RBS>

:CALCulate[1..n]:RBScatter

Parameter(s)

► *Label:*

The program data syntax for the first parameter is defined as a <CHARACTER PROGRAM DATA> element. The allowed <CHARACTER PROGRAM DATA> elements for this parameter are: TRC1|TRC2|TRC3|TRC4.

Trace index of the available wavelengths.

► *RBS:*

The program data syntax for <RBS> is defined as a <DECIMAL NUMERIC PROGRAM DATA> element.

Sets the Rayleigh backscatter.

Example(s)

```
CONF:ANA:RBS -79.5
CONF:ACQ:MODE ACQUISITION
INIT
INIT:STAT? Returns 0 when acquisition is
complete.
CALC:RBS? TRC1 Returns -79.5
CALC:RBS TRC1,-80
CALC:RBS? TRC1 Returns -80
```

See Also

```
CALCulate[1..n]:ANALysis:[UNIDirectional]
CALCulate[1..n]:EVENT:COUNT?
CALCulate[1..n]:EVENT?
MMEMory[1..n]:LOAD:TRACe
TRACe[1..n]:CATalog?
```

:CALCulate[1..n]:RBScatter?

Description	<p>This query returns the Rayleigh backscatter used for the trace corresponding to the specified trace index.</p> <p>Since *RST clears the RBS value, the returned value will be 0.</p>
Syntax	:CALCulate[1..n]:RBScatter?<wsp>TRC1 TRC2 TRC3 TRC4
Parameter(s)	<p><i>Label:</i></p> <p>The program data syntax for the first parameter is defined as a <CHARACTER PROGRAM DATA> element. The allowed <CHARACTER PROGRAM DATA> elements for this parameter are: TRC1 TRC2 TRC3 TRC4.</p> <p>Trace index of the available wavelengths.</p>
Response Syntax	<RBS>
Response(s)	<p><i>RBS:</i></p> <p>The response data syntax for <RBS> is defined as a <NR3 NUMERIC RESPONSE DATA> element.</p> <p>Returns the Rayleigh backscatter used by the trace corresponding to the specified trace index.</p>

:CALCulate[1..n]:RBScatter?

Example(s)	<p>CONF:ANA:RBS -80 CONF:ACQ:MODE ACQUISITION INIT INIT:STAT? Returns 0 when acquisition is complete. CALC:RBS? TRC1 Returns -80</p>
Notes	<p>Reset to a new default value when wavelength and range change.</p>
See Also	<p>MMEMory[1..n]:LOAD:TRACe TRACe[1..n]:CATalog?</p>

SCPI Command Reference

Product-Specific Commands—Description

:CALCulate[1..n]:SLOSs?

Description This query returns the value of the measured loss for a given splice identified using four markers, for the trace corresponding to the specified trace index.

*RST clears this value.

Syntax :CALCulate[1..n]:SLOSs? <wsp> TRC1 | TRC2 | TRC3 | TRC4, <SubMarkerA>, <MarkerA>, <MarkerB>, <SubMarkerB>

:CALCulate[1..n]:SLOs?

Parameter(s)

➤ *Label:*

The program data syntax for the first parameter is defined as a <CHARACTER PROGRAM DATA> element. The allowed <CHARACTER PROGRAM DATA> elements for this parameter are:
TRC1|TRC2|TRC3|TRC4.

Trace index of the available wavelengths.

➤ *SubMarkerA:*

The program data syntax for <SubMarkerA> is defined as a <DECIMAL NUMERIC PROGRAM DATA> element.

Specifies the submarker A position, in meters.

➤ *MarkerA:*

The program data syntax for <MarkerA> is defined as a <DECIMAL NUMERIC PROGRAM DATA> element.

Specifies the marker A position, in meters.

➤ *MarkerB:*

The program data syntax for <MarkerB> is defined as a <DECIMAL NUMERIC PROGRAM DATA> element.

Specifies the marker B position, in meters.

➤ *SubMarkerB:*

The program data syntax for <SubMarkerB> is defined as a <DECIMAL NUMERIC PROGRAM DATA> element.

Specifies the submarker B position, in meters.

Returns the splice loss value, calculated using all four markers.

:CALCulate[1..n]:SLOSs?

Response Syntax	<Splice Loss>
Response(s)	<i>Splice Loss</i> : The response data syntax for <Splice Loss> is defined as a <NR3 NUMERIC RESPONSE DATA> element. Return the splice loss value, calculated using all four markers.
Example(s)	CONF:ACQ:MODE ACQUISITION INIT INIT:STAT? Returns 0 when acquisition is complete. CALC:SLOS? TRC1,10,100,200,300 Ex.: Returns 0.058 CALC:SLOS? TRC1,0.01 KM,100 M, 0.2 KM,300 Ex.: Returns 0.058 CALC:SLOS? TRC1,10 M,100 M,200 M,300 M Ex.: Returns 0.058 CALC:SLOS? TRC1,0.01 KM, 0.1 KM, 0.2 KM,0.3 KM Ex.: Returns 0.058
Notes	See the section on loss measurement in the FTB-7000 Optical Time Domain Reflectometer user guide.
See Also	CALCulate[1..n]:ANALysis:[UNIDirectional] CALCulate[1..n]:EVENT:COUNT? CALCulate[1..n]:EVENT? MMEMory[1..n]:LOAD:TRACe TRACe[1..n]:CATalog?

:CALCulate[1..n]:THReshold:EOFiber

Description

This command sets the end-of-fiber threshold that will be used for the specified trace index. Using this command will regenerate the event table automatically.

*RST clears this setting.

Syntax

:CALCulate[1..n]:THReshold:EOFiber<wsp>TRC
1|TRC2|TRC3|TRC4,<End-of-Fiber>

:CALCulate[1..n]:THReshold:EOFiber

Parameter(s)	<p>➤ <i>Label:</i></p> <p>The program data syntax for the first parameter is defined as a <CHARACTER PROGRAM DATA> element. The allowed <CHARACTER PROGRAM DATA> elements for this parameter are: TRC1 TRC2 TRC3 TRC4.</p> <p>Trace index of the available wavelengths.</p> <p>➤ <i>End-of-Fiber:</i></p> <p>The program data syntax for <End-of-Fiber> is defined as a <DECIMAL NUMERIC PROGRAM DATA> element.</p> <p>Sets the end-of-fiber threshold.</p>
Example(s)	<pre>CONF:ANA:THR:EOF 5.1 CONF:ACQ:MODE ACQ INIT INIT:STAT? Returns 0 when acquisition is complete. CALC:THR:EOF? TRC1 Returns 5.1 CALC:THR:EOF TRC1,5.2 CALC:THR:EOF? TRC1 Returns 5.2</pre>
See Also	<pre>CALCulate[1..n]:ANALysis:[UNIDirectional] CALCulate[1..n]:EVENT:COUNT? CALCulate[1..n]:EVENT? MMEMory[1..n]:LOAD:TRACe TRACe[1..n]:CATalog?</pre>

:CALCulate[1..n]:THReshold:EOFiber?

Description	<p>This query returns the end-of-fiber threshold used for the specified trace index.</p> <p>*RST clears this value.</p>
Syntax	:CALCulate[1..n]:THReshold:EOFiber? <wsp>TRC1 TRC2 TRC3 TRC4
Parameter(s)	<p><i>Label:</i></p> <p>The program data syntax for the first parameter is defined as a <CHARACTER PROGRAM DATA> element. The allowed <CHARACTER PROGRAM DATA> elements for this parameter are: TRC1 TRC2 TRC3 TRC4.</p> <p>Trace index of the available wavelengths.</p>
Response Syntax	<End-of-Fiber>
Response(s)	<p><i>End-of-Fiber:</i></p> <p>The response data syntax for <End-of-Fiber> is defined as a <NR3 NUMERIC RESPONSE DATA> element.</p> <p>Returns the end-of-fiber threshold used by the trace corresponding to the specified trace index.</p>
Example(s)	<pre>CONF:ANA:THR:EOF 5.1 CONF:ACQ:MODE ACQ INIT INIT:STAT? Returns 0 when acquisition is complete. CALC:THR:EOF? TRC1 Returns 5.1</pre>
See Also	<p>MMEMOry[1..n]:LOAD:TRACe TRACe[1..n]:CATalog?</p>

:CALCulate[1..n]:THReshold: REFlectance

Description

This command sets the reflectance threshold that will be used for the specified trace index. Using this command will regenerate the event table automatically.

*RST clears this setting.

Syntax

:CALCulate[1..n]:THReshold:REFlectance<wsp
>TRC1|TRC2|TRC3|TRC4,<Reflectance>

:CALCulate[1..n]:THReshold: REFlectance

Parameter(s)

➤ *Label:*

The program data syntax for the first parameter is defined as a <CHARACTER PROGRAM DATA> element. The allowed <CHARACTER PROGRAM DATA> elements for this parameter are: TRC1|TRC2|TRC3|TRC4.

Trace index of the available wavelengths.

➤ *Reflectance:*

The program data syntax for <Reflectance> is defined as a <DECIMAL NUMERIC PROGRAM DATA> element.

Sets the reflectance threshold.

Example(s)

```
CONF:ANA:THR:REFL -72.1
CONF:ACQ:MODE ACQ
INIT
INIT:STAT? Returns 0 when acquisition is
complete.
CALC:THR:REFL? TRC1 Returns -72.1
CALC:THR:REFL TRC1,-72.2
CALC:THR:REFL? TRC1 Returns -72.2
```

See Also

```
CALCulate[1..n]:ANALysis:[UNIDirectional]
CALCulate[1..n]:EVENT:COUNT?
CALCulate[1..n]:EVENT?
MMEMory[1..n]:LOAD:TRACe
TRACe[1..n]:CATalog?
```

:CALCulate[1..n]:THReshold:REFlectance?

Description	This query returns the reflectance threshold used for the specified trace index. *RST clears this value.
Syntax	:CALCulate[1..n]:THReshold:REFlectance?<wsp>TRC1 TRC2 TRC3 TRC4
Parameter(s)	<i>Label:</i> The program data syntax for the first parameter is defined as a <CHARACTER PROGRAM DATA> element. The allowed <CHARACTER PROGRAM DATA> elements for this parameter are: TRC1 TRC2 TRC3 TRC4. Trace index of the available wavelengths.
Response Syntax	<Reflectance>

:CALCulate[1..n]:THReshold: REFlectance?

Response(s)	<p><i>Reflectance:</i></p> <p>The response data syntax for <Reflectance> is defined as a <NR3 NUMERIC RESPONSE DATA> element.</p> <p>Returns the reflectance threshold used by the trace corresponding to the specified trace index.</p>
Example(s)	<pre>CONF:ANA:THR:REFL -72.1 CONF:ACQ:MODE ACQ INIT INIT:STAT? Returns 0 when acquisition is complete. CALC:THR:REFL? TRC1 Returns -72.1</pre>
See Also	<pre>MMEMory[1..n]:LOAD:TRACe TRACe[1..n]:CATalog?</pre>

SCPI Command Reference

Product-Specific Commands—Description

:CALCulate[1..n]:THReshold:SLOSs

Description This command sets the splice loss threshold that will be used for the specified trace index. Using this command will regenerate the event table automatically.

*RST clears this setting.

Syntax :CALCulate[1..n]:THReshold:SLOSs <wsp> TRC1
|TRC2|TRC3|TRC4,<Splice Loss>

:CALCulate[1..n]:THReshold:SLOs

Parameter(s)

► *Label:*

The program data syntax for the first parameter is defined as a <CHARACTER PROGRAM DATA> element. The allowed <CHARACTER PROGRAM DATA> elements for this parameter are: TRC1|TRC2|TRC3|TRC4.

Trace index of the available wavelengths.

► *Splice Loss:*

The program data syntax for <Splice Loss> is defined as a <DECIMAL NUMERIC PROGRAM DATA> element.

Sets the splice loss threshold.

Example(s)

```
CONF:ANA:THR:SLOS 0.03
CONF:ACQ:MODE ACQ
INIT
INIT:STAT? Returns 0 when acquisition is
complete.
CALC:THR:SLOS? TRC1 Returns 0.03
CALC:THR:SLOS TRC1,0.04
CALC:THR:SLOS? TRC1 Returns 0.04
```

See Also

```
CALCulate[1..n]:ANALysis:[UNIDirectional]
CALCulate[1..n]:EVENT:COUNT?
CALCulate[1..n]:EVENT?
MMEMory[1..n]:LOAD:TRACe
TRACe[1..n]:CATalog?
```

:CALCulate[1..n]:THReshold:SLOSs?

Description	<p>This query returns the splice loss threshold used for the specified trace index.</p> <p>*RST clears this value.</p>
Syntax	<code>:CALCulate[1..n]:THReshold:SLOSs?<wsp>TRC1 TRC2 TRC3 TRC4</code>
Parameter(s)	<p><i>Label:</i></p> <p>The program data syntax for the first parameter is defined as a <CHARACTER PROGRAM DATA> element. The allowed <CHARACTER PROGRAM DATA> elements for this parameter are: TRC1 TRC2 TRC3 TRC4.</p> <p>Trace index of the available wavelengths.</p>
Response Syntax	<code><Splice Loss></code>
Response(s)	<p><i>Splice Loss:</i></p> <p>The response data syntax for <Splice Loss> is defined as a <NR3 NUMERIC RESPONSE DATA> element.</p> <p>Returns the splice loss threshold used by the trace corresponding to the specified trace index.</p>
Example(s)	<pre>CONF:ANA:THR:SLOS 0.03 CONF:ACQ:MODE ACQ INIT INIT:STAT? Returns 0 when acquisition is complete. CALC:THR:SLOS? TRC1 Returns 0.03</pre>
See Also	<code>MMEMory[1..n]:LOAD:TRACe</code> <code>TRACe[1..n]:CATalog?</code>

:CALCulate[1..n]:TORL?

Description This query returns the sum of all optical return loss (ORL) values measured on the total fiber length, for the trace corresponding to the specified trace index. This total ORL value does not include the launch reflection. A negative total value indicates that the real value is smaller.

*RST clears this value.

Syntax :CALCulate[1..n]:TORL?<wsp>TRC1|TRC2|TRC3|TRC4

Parameter(s) *Label:*
 The program data syntax for the first parameter is defined as a <CHARACTER PROGRAM DATA> element. The allowed <CHARACTER PROGRAM DATA> elements for this parameter are: TRC1|TRC2|TRC3|TRC4.

Trace index of the available wavelengths.

Response Syntax <TotalOrl>

SCPI Command Reference

Product-Specific Commands—Description

:CALCulate[1..n]:TORL?

Response(s)	<i>TotalOrl</i> : The response data syntax for <TotalOrl> is defined as a <NR3 NUMERIC RESPONSE DATA> element.
Example(s)	Returns the total ORL value, in dB. CONF:ACQ:MODE ACQUISITION INIT INIT:STAT? Returns 0 when acquisition is complete. CALC:ANA TRC1 CALC:TORL? TRC1 Ex.: Returns 20.416
See Also	MMEMory[1..n]:LOAD:TRACe TRACe[1..n]:CATalog?

:CONFigure[1..n]:ACQuisition

Description	<p>This command specifies the wavelength, range and pulse that will be used for the next acquisition.</p> <p>*RST does not affect this command.</p>
Syntax	:CONFigure[1..n]:ACQuisition<wsp> <Wavelength>, <Range>, <Pulse>
Parameter(s)	<p>➤ <i>Wavelength:</i></p> <p>The program data syntax for <Wavelength> is defined as a <DECIMAL NUMERIC PROGRAM DATA> element.</p> <p>Sets the wavelength, in meters.</p> <p>➤ <i>Range:</i></p> <p>The program data syntax for <Range> is defined as a <DECIMAL NUMERIC PROGRAM DATA> element.</p> <p>Sets the range, in meters. Range value depends on the wavelength parameter.</p> <p>➤ <i>Pulse:</i></p> <p>The program data syntax for <Pulse> is defined as a <DECIMAL NUMERIC PROGRAM DATA> element.</p> <p>Sets the pulse, in seconds. Pulse value depends on the range parameter.</p>

:CONFigure[1..n]:ACQuisition

Example(s)

CONF:ACQ:WAV:LIST? Returns the available wavelength list
CONF:ACQ:RANG:LIST? 1310 NM Returns the available range list (where 1310 is an item of CONF:ACQ:WAV:LIST?)

CONF:ACQ:PULS:LIST? 1310 NM,1250 M Returns the available pulse list (where 1250 is an item of CONF:ACQ:RANG:LIST?)
CONF:ACQ 1310 NM,1250 M,10 NS (where 10 is an item of CONF:ACQ:PULS:LIST?)

See Also

CONFigure[1..n]:ACQuisition:WAVelength?
CONFigure[1..n]:ACQuisition:RANGe?
CONFigure[1..n]:ACQuisition:PULSe?

:CONFigure[1..n]:ACQuisition: DURation

Description	<p>This command specifies the duration that will be used for the next acquisition.</p> <p>*RST reverts this setting to default value.</p>
Syntax	<pre>:CONFigure[1..n]:ACQuisition:DURation<wsp> <Duration> MAXimum MINimum DEFault</pre>
Parameter(s)	<p><i>Duration:</i></p> <p>The program data syntax for <Duration> is defined as a <numeric_value> element. The <Duration> special forms MINimum, MAXimum and DEFault are accepted on input.</p> <p>MINimum allows to set the instrument to the lowest supported value. MAXimum allows to set the instrument to the highest supported value. DEFault allows the instrument to select a value for the <Duration> parameter.</p> <p>Sets the acquisition duration, in seconds.</p>
Example(s)	<pre>CONF:ACQ:DUR? Ex.: Returns 15 CONF:ACQ:DUR 10 CONF:ACQ:DUR? Returns 10</pre>
See Also	<pre>FETCh[1..n]:DURation? FETCh[1..n]:ASETting:DURation?</pre>

:CONFigure[1..n]:ACQuisition: DURation?

Description	<p>This query returns the current duration setting.</p> <p>*RST reverts this setting to default value.</p>
Syntax	<p>:CONFigure[1..n]:ACQuisition:DURation?[<wsp >MINimum MAXimum DEFault]</p>
Parameter(s)	<p><i>Parameter 1:</i></p> <p>The program data syntax for the first parameter is defined as a <CHARACTER PROGRAM DATA> element. The allowed <CHARACTER PROGRAM DATA> elements for this parameter are: MINimum MAXimum DEFault.</p> <p>MINimum is used to retrieve the instrument's lowest supported value. MAXimum is used to retrieve the instrument's highest supported value. DEFault is used to retrieve the instrument's default value.</p>
Response Syntax	<p><Duration></p>

:CONFigure[1..n]:ACQuisition: DURation?

Response(s)

Duration:

The response data syntax for <Duration> is defined as a <NR1 NUMERIC RESPONSE DATA> element.

Returns the duration, in seconds.

Example(s)

CONF:ACQ:DUR 10
CONF:ACQ:DUR? Returns 10

See Also

FETCh[1..n]:DURation?
FETCh[1..n]:ASETting:DURation?

:CONFigure[1..n]:ACQuisition: HRESolution

Description	<p>This command enables the high-resolution feature that allows you to obtain more data points per acquisition (greater distance resolution for the trace).</p> <p>*RST reverts this setting to default value.</p>
Syntax	<pre>:CONFigure[1..n]:ACQuisition:HRESolution <wsp> > <HighResolution></pre>
Parameter(s)	<p><i>HighResolution:</i></p> <p>The program data syntax for <HighResolution> is defined as a <Boolean Program Data> element. The <HighResolution> special forms ON and OFF are accepted on input for increased readability. ON corresponds to 1 and OFF corresponds to 0.</p> <p>Enables or disables the high-resolution feature.</p>
Example(s)	<pre>CONF:ACQ:HRES 1</pre> <p>The acquisition will be performed using high resolution.</p>
See Also	<pre>CONFigure[1..n]:ACQuisition:HRESolution? FETCh[1..n]:HRESolution?</pre>

:CONFigure[1..n]:ACQuisition: HRESolution?

Description	<p>This query returns a value indicating if the high-resolution feature is enabled for the next acquisition.</p> <p>*RST reverts this setting to default value.</p>
Syntax	:CONFigure[1..n]:ACQuisition:HRESolution?
Parameter(s)	None
Response Syntax	<HighResolution>
Response(s)	<p><i>HighResolution:</i></p> <p>The response data syntax for <HighResolution> is defined as a <NR1 NUMERIC RESPONSE DATA> element.</p> <p>Indicates if the high-resolution feature is enabled or not for the next acquisition.</p>
Example(s)	CONF:ACQ:HRES? Returns 1 if the high resolution is enabled.
See Also	CONFigure[1..n]:ACQuisition:HRESolution FETCh[1..n]:HRESolution?

:CONFigure[1..n]:ACQuisition:MODE

Description

This command specifies the mode that will be used for the next acquisition.

Acquisition: Allows the OTDR to perform a standard acquisition.

Auto Setting: Lets the OTDR evaluate the length of the fiber and find the appropriate range and pulse width.

Check First Connector: Used to detect a low injection level.

Real Time: Used to view sudden changes in the fiber under test. In this mode, measurements are not allowed.

*RST sets the current acquisition mode to ACQUISITION.

Syntax

:CONFigure[1..n]:ACQuisition:MODE<wsp>ACQuisition|ASETting|CFConnector|REALtime

Parameter(s)

Mode:

The program data syntax for the first parameter is defined as a <CHARACTER PROGRAM DATA> element. The allowed <CHARACTER PROGRAM DATA> elements for this parameter are: ACQuisition|ASETting|CFConnector|REALtime.

:CONFigure[1..n]:ACQuisition:MODE

Sets the acquisition mode.

Example(s)

CONF:ACQ:MODE? Ex.: Returns ASETTING
CONF:ACQ:MODE ACQ
CONF:ACQ:MODE? Returns ACQUISITION

See Also

INITiate[1..n][:IMMediate]
ABORt[1..n]

:CONFigure[1..n]:ACQquisition:MODE?

Description	This query returns the current acquisition mode. *RST sets the current acquisition mode to ACQUISITION.
Syntax	:CONFigure[1..n]:ACQquisition:MODE?
Parameter(s)	None
Response Syntax	<Mode>
Response(s)	<i>Mode:</i> The response data syntax for <Mode> is defined as a <CHARACTER RESPONSE DATA> element. Returns the current acquisition mode.
Example(s)	CONF:ACQ:MODE ACQ CONF:ACQ:MODE? Returns ACQUISITION

:CONFigure[1..n]:ACQuisition:PULSe?

Description	This query returns the current pulse setting. *RST reverts this setting to default value.
Syntax	:CONFigure[1..n]:ACQuisition:PULSe?
Parameter(s)	None
Response Syntax	<Pulse>
Response(s)	<i>Pulse:</i> The response data syntax for <Pulse> is defined as a <NR3 NUMERIC RESPONSE DATA> element. Returns the pulse, in seconds.
Example(s)	CONF:ACQ 1310 NM,1250 M,10 NS CONF:ACQ:PULS? Returns 1E-8
See Also	CONFigure[1..n]:ACQuisition:WAVelength:LIST? CONFigure[1..n]:ACQuisition:RANGe:LIST? CONFigure[1..n]:ACQuisition:PULSe:LIST?

:CONFigure[1..n]:ACQuisition:PULSe:LIST?

Description	<p>This query returns the list of available pulses for the specified wavelength and range.</p> <p>*RST does not affect this command.</p>
Syntax	<p>:CONFigure[1..n]:ACQuisition:PULSe:LIST?<wsp><Wavelength>,<Range></p>
Parameter(s)	<p>➤ <i>Wavelength:</i></p> <p>The program data syntax for <Wavelength> is defined as a <DECIMAL NUMERIC PROGRAM DATA> element.</p> <p>Specifies the wavelength, in meters, that filters out invalid pulses from all pulses.</p> <p>➤ <i>Range:</i></p> <p>The program data syntax for <Range> is defined as a <DECIMAL NUMERIC PROGRAM DATA> element.</p> <p>Specifies the range, in meters, related to the wavelength, in meters, that filters out invalid pulses from all pulses.</p>
Response Syntax	<p><PulseList></p>

:CONFigure[1..n]:ACQuisition:PULSe: LIST?

Response(s)	<p><i>PulseList:</i></p> <p>The response data syntax for <PulseList> is defined as a <DEFINITE LENGTH ARBITRARY BLOCK RESPONSE DATA> element.</p> <p>Returns the list of valid pulses, in seconds.</p>
Example(s)	<p>CONF:ACQ:WAV:LIST? Returns a wavelength list.</p> <p>CONF:ACQ:RANG:LIST? 1310 NM Returns a range list (where 1310 is an item of CONF:ACQ:WAV:LIST?)</p> <p>CONF:ACQ:PULS:LIST? 1310 NM,1250 M Returns a pulse list (where 1250 is an item of CONF:ACQ:RANG:LIST?)</p>
See Also	<p>CONFigure[1..n]:ACQuisition:PULSe?</p> <p>CONFigure[1..n]:ACQuisition</p>

:CONFigure[1..n]:ACQquisition:RANGe?

Description	This query returns the current range setting. *RST reverts this setting to default value.
Syntax	:CONFigure[1..n]:ACQquisition:RANGe?
Parameter(s)	None
Response Syntax	<Range>
Response(s)	<i>Range:</i> The response data syntax for <Range> is defined as a <NR3 NUMERIC RESPONSE DATA> element. Returns the range, in meters.
Example(s)	CONF:ACQ 1310 NM,1250 M,10 NS CONF:ACQ:RANG? Returns 1.25E+3
See Also	CONFigure[1..n]:ACQquisition:WAVelength:LIST? CONFigure[1..n]:ACQquisition:RANGe:LIST? CONFigure[1..n]:ACQquisition:PULSe:LIST?

:CONFigure[1..n]:ACQuisition:RANGe: LIMit:HIGH?

Description	<p>This query returns the highest possible value for the acquisition range, at the specified wavelength.</p> <p>*RST does not affect this command.</p>
Syntax	:CONFigure[1..n]:ACQuisition:RANGe:LIMit:HIGH? <wsp> <Wavelength>
Parameter(s)	<p><i>Wavelength:</i></p> <p>The program data syntax for <Wavelength> is defined as a <DECIMAL NUMERIC PROGRAM DATA> element.</p> <p>Wavelength for which you want to know the maximum value allowed for the acquisition range.</p>
Response Syntax	<Range>
Response(s)	<p><i>Range:</i></p> <p>The response data syntax for <Range> is defined as a <NR3 NUMERIC RESPONSE DATA> element.</p> <p>Maximum value allowed for the acquisition range at the specified wavelength, in meters.</p>
Example(s)	CONF:ACQ:RANG:LIM:HIGH? 1310 NM Returns 1.25E+3
See Also	CONFigure[1..n]:ACQuisition:RANGe:LIMit:LOW?

:CONFigure[1..n]:ACQuisition:RANGe: LIMit:LOW?

Description	<p>This query returns the lowest possible value for the acquisition range, at the specified wavelength.</p> <p>*RST does not affect this command.</p>
Syntax	<p>:CONFigure[1..n]:ACQuisition:RANGe:LIMit:LOW? <wsp><Wavelength></p>
Parameter(s)	<p><i>Wavelength:</i></p> <p>The program data syntax for <Wavelength> is defined as a <DECIMAL NUMERIC PROGRAM DATA> element.</p> <p>Wavelength for which you want to know the minimum value allowed for the acquisition range.</p>
Response Syntax	<p><Range></p>
Response(s)	<p><i>Range:</i></p> <p>The response data syntax for <Range> is defined as a <NR3 NUMERIC RESPONSE DATA> element.</p> <p>Minimum value allowed for the acquisition range at the specified wavelength, in meters.</p>
Example(s)	<p>CONF:ACQ:RANG:LIM:LOW? 1310 NM Returns 2.5+2</p>
See Also	<p>CONFigure[1..n]:ACQuisition:RANGe:LIMit:HIGH?</p>

:CONFigure[1..n]:ACQuisition:RANGe: LIST?

Description	<p>This query returns the list of available ranges for the specified wavelength.</p> <p>*RST does not affect this command.</p>
Syntax	:CONFigure[1..n]:ACQuisition:RANGe:LIST? <wsp> <Wavelength>
Parameter(s)	<p><i>Wavelength:</i></p> <p>The program data syntax for <Wavelength> is defined as a <DECIMAL NUMERIC PROGRAM DATA> element.</p> <p>Specifies the wavelength, in meters, that filters out invalid ranges from all ranges.</p>
Response Syntax	<RangeList>
Response(s)	<p><i>RangeList:</i></p> <p>The response data syntax for <RangeList> is defined as a <DEFINITE LENGTH ARBITRARY BLOCK RESPONSE DATA> element.</p> <p>Returns the list of valid ranges, in meters.</p>
Example(s)	<p>CONF:ACQ:WAV:LIST? Returns a wavelength list.</p> <p>CONF:ACQ:RANG:LIST? 1310 NM Returns a range list (where 1310 is an item of CONF:ACQ:WAV:LIST?)</p>
See Also	<p>CONFigure[1..n]:ACQuisition:RANGe?</p> <p>CONFigure[1..n]:ACQuisition</p>

:CONFigure[1..n]:ACQuisition: WAVelength?

Description	<p>This query returns the current wavelength setting.</p> <p>*RST reverts this setting to default value.</p>
Syntax	:CONFigure[1..n]:ACQuisition:WAVelength?
Parameter(s)	None
Response Syntax	<Wavelength>
Response(s)	<p><i>Wavelength:</i></p> <p>The response data syntax for <Wavelength> is defined as a <NR3 NUMERIC RESPONSE DATA> element.</p> <p>Returns the wavelength, in meters.</p>
Example(s)	<p>CONF:ACQ 1310 NM,1250 M,10 NS CONF:ACQ:WAV? Returns 1.31E-6</p>
See Also	<p>CONFigure[1..n]:ACQuisition:WAVelength:LIST? CONFigure[1..n]:ACQuisition:RANGe:LIST? CONFigure[1..n]:ACQuisition:PULSe:LIST?</p>

:CONFigure[1..n]:ACQuisition: WAVelength:LIST?

Description	<p>This query returns the list of all available wavelengths.</p> <p>*RST does not affect this command.</p>
Syntax	:CONFigure[1..n]:ACQuisition:WAVelength:LIST?
Parameter(s)	None
Response Syntax	<WavelengthList>
Response(s)	<p><i>WavelengthList</i>:</p> <p>The response data syntax for <WavelengthList> is defined as a <DEFINITE LENGTH ARBITRARY BLOCK RESPONSE DATA> element.</p> <p>Returns the list of all available wavelengths, in meters.</p>
Example(s)	CONF:ACQ:WAV:LIST? Returns a wavelength list.
See Also	CONFigure[1..n]:ACQuisition:WAVelength? CONFigure[1..n]:ACQuisition

:CONFigure[1..n]:ANALysis:HFACtor

Description	<p>This command sets the helix factor that will be used for the next acquisition.</p> <p>*RST returns this setting to default value.</p>
Syntax	<p>:CONFigure[1..n]:ANALysis:HFACtor<wsp><HelixFactor> MAXimum MINimum DEFault</p>
Parameter(s)	<p><i>HelixFactor:</i></p> <p>The program data syntax for <HelixFactor> is defined as a <numeric_value> element. The <HelixFactor> special forms MINimum, MAXimum and DEFault are accepted on input.</p> <p>MINimum allows to set the instrument to the lowest supported value. MAXimum allows to set the instrument to the highest supported value. DEFault allows the instrument to select a value for the <HelixFactor> parameter.</p> <p>Sets the helix factor.</p>
Example(s)	<p>CONF:ANA:HFAC? Ex.: Returns 0 CONF:ANA:HFAC 2 CONF:ANA:HFAC? Returns 2</p>

:CONFigure[1..n]:ANALysis:HFACTOR?

Description	<p>This query returns the helix factor that will be used for the next acquisition.</p> <p>*RST reverts this setting to default value.</p>
Syntax	:CONFigure[1..n]:ANALysis:HFACTOR?[<wsp>MINimum MAXimum DEFAULT]
Parameter(s)	<p><i>Parameter 1:</i></p> <p>The program data syntax for the first parameter is defined as a <CHARACTER PROGRAM DATA> element. The allowed <CHARACTER PROGRAM DATA> elements for this parameter are: MINimum MAXimum DEFAULT.</p> <p>MINimum is used to retrieve the instrument's lowest supported value. MAXimum is used to retrieve the instrument's highest supported value. DEFAULT is used to retrieve the instrument's default value.</p>
Response Syntax	<HelixFactor>
Response(s)	<p><i>HelixFactor:</i></p> <p>The response data syntax for <HelixFactor> is defined as a <NR3 NUMERIC RESPONSE DATA> element.</p> <p>Returns the helix factor.</p>
Example(s)	<p>CONF:ANA:HFAC 2 CONF:ANA:HFAC? Returns 2</p>

:CONFigure[1..n]:ANALysis: IORefractioN

Description	<p>This command sets the index of refraction that will be used for the next acquisition.</p> <p>*RST reverts this setting to default value.</p>
Syntax	<pre>:CONFigure[1..n]:ANALysis:IORefractioN<wsp> <IOR> MAXimum MINimum DEFault</pre>
Parameter(s)	<p><i>IOR:</i></p> <p>The program data syntax for <IOR> is defined as a <numeric_value> element. The <IOR> special forms MINimum, MAXimum and DEFault are accepted on input.</p> <p>MINimum allows to set the instrument to the lowest supported value. MAXimum allows to set the instrument to the highest supported value. DEFault allows the instrument to select a value for the <IOR> parameter.</p> <p>Sets the index of refraction.</p>
Example(s)	<pre>CONF:ANA:IOR? Ex.: Returns 1.4677 CONF:ANA:IOR 1.5 CONF:ANA:IOR? Returns 1.5</pre>

:CONFigure[1..n]:ANALysis: IORefractioN?

Description	<p>This query returns the index of refraction that will be used for the next acquisition.</p> <p>*RST reverts this setting to default value.</p>
Syntax	:CONFigure[1..n]:ANALysis:IORefractioN?[<wsp>MINimum MAXimum DEFault]
Parameter(s)	<p><i>Parameter 1:</i></p> <p>The program data syntax for the first parameter is defined as a <CHARACTER PROGRAM DATA> element. The allowed <CHARACTER PROGRAM DATA> elements for this parameter are: MINimum MAXimum DEFault.</p> <p>MINimum is used to retrieve the instrument's lowest supported value. MAXimum is used to retrieve the instrument's highest supported value. DEFault is used to retrieve the instrument's default value.</p>
Response Syntax	<IOR>
Response(s)	<p><i>IOR:</i></p> <p>The response data syntax for <IOR> is defined as a <NR3 NUMERIC RESPONSE DATA> element.</p> <p>Returns the index of refraction.</p>
Example(s)	<p>CONF:ANA:IOR 1.5 CONF:ANA:IOR? Returns 1.5</p>

:CONFigure[1..n]:ANALysis:RBScatter

Description	<p>This command sets the Rayleigh backscatter that will be used for the next acquisition.</p> <p>*RST reverts this setting to default value.</p>
Syntax	<p>:CONFigure[1..n]:ANALysis:RBScatter<wsp><RBS> MAXimum MINimum DEFault</p>
Parameter(s)	<p><i>RBS:</i></p> <p>The program data syntax for <RBS> is defined as a <numeric_value> element. The <RBS> special forms MINimum, MAXimum and DEFault are accepted on input.</p> <p>MINimum allows to set the instrument to the lowest supported value. MAXimum allows to set the instrument to the highest supported value. DEFault allows the instrument to select a value for the <RBS> parameter.</p> <p>Sets the Rayleigh backscatter.</p>
Example(s)	<p>CONF:ANA:RBS? Ex.: Returns -79.5 CONF:ANA:RBS -80 CONF:ANA:RBS? Returns -80</p>

:CONFigure[1..n]:ANALysis: RBSscatter?

Description	<p>This query returns the Rayleigh backscatter that will be used for the next acquisition.</p> <p>*RST reverts this setting to default value.</p>
Syntax	:CONFigure[1..n]:ANALysis:RBSscatter?[<wsp>MINimum MAXimum DEFault]
Parameter(s)	<p><i>Parameter 1:</i></p> <p>The program data syntax for the first parameter is defined as a <CHARACTER PROGRAM DATA> element. The allowed <CHARACTER PROGRAM DATA> elements for this parameter are: MINimum MAXimum DEFault.</p> <p>MINimum is used to retrieve the instrument's lowest supported value. MAXimum is used to retrieve the instrument's highest supported value. DEFault is used to retrieve the instrument's default value.</p>
Response Syntax	<RBS>
Response(s)	<p><i>RBS:</i></p> <p>The response data syntax for <RBS> is defined as a <NR3 NUMERIC RESPONSE DATA> element.</p> <p>Returns the Rayleigh backscatter.</p>
Example(s)	<p>CONF:ANA:RBS -80 CONF:ANA:RBS? Returns -80</p>

:CONFigure[1..n]:ANALysis:THReshold: EOFiber

Description	<p>This command sets the end-of-fiber threshold that will be used for the next acquisition.</p> <p>*RST returns this setting to default value.</p>
Syntax	<p>:CONFigure[1..n]:ANALysis:THReshold:EOFiber <wsp> <End-of-Fiber> MAXimum MINimum DEFault</p>
Parameter(s)	<p><i>End-of-Fiber:</i></p> <p>The program data syntax for <End-of-Fiber> is defined as a <numeric_value> element. The <End-of-Fiber> special forms MINimum, MAXimum and DEFault are accepted on input.</p> <p>MINimum allows to set the instrument to the lowest supported value. MAXimum allows to set the instrument to the highest supported value. DEFAULT allows the instrument to select a value for the <End-of-Fiber> parameter.</p> <p>Sets the end-of-fiber threshold.</p>
Example(s)	<p>CONF:ANA:THR:EOF? Ex.: Returns 5.0 CONF:ANA:THR:EOF 5.5 CONF:ANA:THR:EOF? Returns 5.5</p>

:CONFigure[1..n]:ANALysis:THReshold: EOFiber?

Description	<p>This query returns the end-of-fiber threshold that will be used for the next acquisition.</p> <p>*RST reverts this setting to default value.</p>
Syntax	:CONFigure[1..n]:ANALysis:THReshold:EOFiber? [<wsp>MINimum MAXimum DEFault]
Parameter(s)	<p><i>Parameter 1:</i></p> <p>The program data syntax for the first parameter is defined as a <CHARACTER PROGRAM DATA> element. The allowed <CHARACTER PROGRAM DATA> elements for this parameter are: MINimum MAXimum DEFault.</p> <p>MINimum is used to retrieve the instrument's lowest supported value. MAXimum is used to retrieve the instrument's highest supported value. DEFault is used to retrieve the instrument's default value.</p>
Response Syntax	<End-of-Fiber>
Response(s)	<p><i>End-of-Fiber:</i></p> <p>The response data syntax for <End-of-Fiber> is defined as a <NR3 NUMERIC RESPONSE DATA> element.</p> <p>Returns the end-of-fiber threshold.</p>
Example(s)	<p>CONF:ANA:THR:EOF 5.5 CONF:ANA:THR:EOF? Returns 5.5</p>

:CONFigure[1..n]:ANALysis:THReshold:REFlectance

Description	<p>This command sets the reflectance threshold that will be used for the next acquisition.</p> <p>*RST returns this setting to default value.</p>
Syntax	<p>:CONFigure[1..n]:ANALysis:THReshold:REFlectance <wsp> <Reflectance> MAXimum MINimum DEFault</p>
Parameter(s)	<p><i>Reflectance:</i></p> <p>The program data syntax for <Reflectance> is defined as a <numeric_value> element. The <Reflectance> special forms MINimum, MAXimum and DEFault are accepted on input.</p> <p>MINimum allows to set the instrument to the lowest supported value. MAXimum allows to set the instrument to the highest supported value. DEFault allows the instrument to select a value for the <Reflectance> parameter.</p> <p>Sets the reflectance threshold.</p>
Example(s)	<p>CONF:ANA:THR:REFL? Ex.: Returns -72.0 CONF:ANA:THR:REFL -72.5 CONF:ANA:THR:REFL? Returns -72.5</p>

:CONFigure[1..n]:ANALysis:THReshold: REFlectance?

Description	<p>This query returns the reflectance threshold that will be used for the next acquisition.</p> <p>*RST reverts this setting to default value.</p>
Syntax	:CONFigure[1..n]:ANALysis:THReshold:REFlectance? [<wsp>MINimum MAXimum DEFault]
Parameter(s)	<p><i>Parameter 1:</i></p> <p>The program data syntax for the first parameter is defined as a <CHARACTER PROGRAM DATA> element. The allowed <CHARACTER PROGRAM DATA> elements for this parameter are: MINimum MAXimum DEFault.</p> <p>MINimum is used to retrieve the instrument's lowest supported value. MAXimum is used to retrieve the instrument's highest supported value. DEFault is used to retrieve the instrument's default value.</p>
Response Syntax	<Reflectance>
Response(s)	<p><i>Reflectance:</i></p> <p>The response data syntax for <Reflectance> is defined as a <NR3 NUMERIC RESPONSE DATA> element.</p> <p>Returns the reflectance threshold.</p>
Example(s)	<p>CONF:ANA:THR:REFL -72.5 CONF:ANA:THR:REFL? Returns -72.5</p>

:CONFigure[1..n]:ANALysis:THReshold: SLOSs

Description	<p>This command sets the splice loss threshold that will be used for the next acquisition.</p> <p>*RST returns this setting to default value.</p>
Syntax	<pre>:CONFigure[1..n]:ANALysis:THReshold:SLOSs<w sp><Splice Loss> MAXimum MINimum DEFault</pre>
Parameter(s)	<p><i>Splice Loss:</i></p> <p>The program data syntax for <Splice Loss> is defined as a <numeric_value> element. The <Splice Loss> special forms MINimum, MAXimum and DEFault are accepted on input.</p> <p>MINimum allows to set the instrument to the lowest supported value. MAXimum allows to set the instrument to the highest supported value. DEFault allows the instrument to select a value for the <Splice Loss> parameter.</p> <p>Sets the splice loss threshold.</p>
Example(s)	<pre>CONF:ANA:THR:SLOS? Ex.: Returns 0.02 CONF:ANA:THR:SLOS 0.03 CONF:ANA:THR:SLOS? Returns 0.03</pre>

:CONFigure[1..n]:ANALysis:THReshold: SLOSs?

Description	<p>This query returns the splice loss threshold that will be used for the next acquisition.</p> <p>*RST reverts this setting to default value.</p>
Syntax	:CONFigure[1..n]:ANALysis:THReshold:SLOSs?[<wsp>MINimum MAXimum DEFault]
Parameter(s)	<p><i>Parameter 1:</i></p> <p>The program data syntax for the first parameter is defined as a <CHARACTER PROGRAM DATA> element. The allowed <CHARACTER PROGRAM DATA> elements for this parameter are: MINimum MAXimum DEFault.</p> <p>MINimum is used to retrieve the instrument's lowest supported value. MAXimum is used to retrieve the instrument's highest supported value. DEFault is used to retrieve the instrument's default value.</p>
Response Syntax	<Splice Loss>
Response(s)	<p><i>Splice Loss:</i></p> <p>The response data syntax for <Splice Loss> is defined as a <NR3 NUMERIC RESPONSE DATA> element.</p> <p>Returns the splice loss threshold.</p>
Example(s)	<p>CONF:ANA:THR:SLOS 0.03 CONF:ANA:THR:SLOS? Returns 0.03</p>

SCPI Command Reference

Product-Specific Commands—Description

:ERRor[1..n]?

Description	This command queries the last error or event. *RST does not affect this query.
Syntax	:ERRor[1..n]?
Parameter(s)	None
Response Syntax	<Error>
Response(s)	<i>Error:</i> The response data syntax for <Error> is defined as a <DEFINITE LENGTH ARBITRARY BLOCK RESPONSE DATA> element. Returns the specified error. A zero value in the number field indicates that no error or event has occurred. Error structure is in A, B, C, D, E, F, G format, where: A = Source <STRING RESPONSE DATA> B = Number <NRI NUMERIC RESPONSE DATA> C = Description <STRING RESPONSE DATA>

:ERRor[1..n]?

D = HelpFile <STRING RESPONSE DATA>
 E = HelpContext <NR1 NUMERIC RESPONSE DATA>
 F = Interface <STRING RESPONSE DATA>
 G = AdditionalInfo <STRING RESPONSE DATA>

Example(s)

ERR? Ex.: Returns: "#10", if no error
 ERE? Ex.: Returns:
 #3126Exfo.Instrument7000.Instrument7000.1,-10
 73471488,"An offset error occured in the
 module.",,,"{...}","Instrument7000:Initialize"

Notes

{...} means GUID

:FETCh[1..n]:ASETting:DURation?

Description	<p>This query returns the duration found after an initiate (INIT) command. Note that acquisition mode (CONF:ACQ:MODE) must be set to ASETting.</p> <p>Since *RST clears the duration value, the returned value will be 0.</p>
Syntax	:FETCh[1..n]:ASETting:DURation?
Parameter(s)	None
Response Syntax	<Duration>
Response(s)	<p><i>Duration:</i></p> <p>The response data syntax for <Duration> is defined as a <NR1 NUMERIC RESPONSE DATA> element.</p> <p>Returns the duration, in seconds.</p>
Example(s)	<pre>CONF:ACQ:MODE ASET INIT INIT:STAT? Returns 0 when acquisition is complete. FETC:ASET:DUR? Ex.: Returns 15</pre>
See Also	CONFigure[1..n]:ACQquisition:DURation?

:FETCh[1..n]:ASETting:PULSe?

Description	<p>This query returns the pulse found after an initiate (INIT) command. Note that acquisition mode (CONF:ACQ:MODE) must be set to ASETting.</p> <p>Since *RST clears the pulse value, the returned value will be 0.</p>
Syntax	:FETCh[1..n]:ASETting:PULSe?
Parameter(s)	None
Response Syntax	<Pulse>
Response(s)	<p><i>Pulse:</i></p> <p>The response data syntax for <Pulse> is defined as a <NR3 NUMERIC RESPONSE DATA> element.</p> <p>Returns the pulse, in meters.</p>
Example(s)	<pre>CONF:ACQ:MODE ASET INIT INIT:STAT? Returns 0 when acquisition is complete. FETC:ASET:PULS? Ex.: Returns 1E-8</pre>
See Also	<pre>CONFigure[1..n]:ACQuisition:RANGe? CONFigure[1..n]:ACQuisition:PULSe? CONFigure[1..n]:ACQuisition:DURation? CONFigure[1..n]:ACQuisition:WAVelength:LIST? CONFigure[1..n]:ACQuisition:RANGe:LIST? CONFigure[1..n]:ACQuisition:PULSe:LIST? CONFigure[1..n]:ACQuisition</pre>

:FETCh[1..n]:ASETting:RANGe?

Description	<p>This query returns the range found after an initiate (INIT) command. Note that acquisition mode (CONF:ACQ:MODE) must be set to ASETting.</p> <p>Since *RST clears the range value, the returned value will be 0.</p>
Syntax	:FETCh[1..n]:ASETting:RANGe?
Parameter(s)	None
Response Syntax	<Range>
Response(s)	<p><i>Range:</i></p> <p>The response data syntax for <Range> is defined as a <NR3 NUMERIC RESPONSE DATA> element.</p> <p>Returns the range, in meters.</p>
Example(s)	<pre>CONF:ACQ:MODE ASET INIT INIT:STAT? Returns 0 when acquisition is complete. FETC:ASET:RANG? Ex.: Returns 1.25E+3</pre>
See Also	<pre>CONFigure[1..n]:ACQuisition:RANGe? CONFigure[1..n]:ACQuisition:PULSe? CONFigure[1..n]:ACQuisition:DURation? CONFigure[1..n]:ACQuisition:WAVelength:LIST? CONFigure[1..n]:ACQuisition:RANGe:LIST? CONFigure[1..n]:ACQuisition:PULSe:LIST? CONFigure[1..n]:ACQuisition</pre>

:FETCh[1..n]:CFConnector?

Description	<p>This query returns a state indicating whether the first connector has been found or not, after an initiate (INIT) command. Note that acquisition mode (CONF:ACQ:MODE) must be set to CFConnector.</p> <p>*RST clears this setting.</p>
Syntax	:FETCh[1..n]:CFConnector?
Parameter(s)	None
Response Syntax	<CheckFirstConnectorState>
Response(s)	<p><i>CheckFirstConnectorState:</i></p> <p>The response data syntax for <CheckFirstConnectorState> is defined as a <NR1 NUMERIC RESPONSE DATA> element.</p> <p>The current <CheckFirstConnectorState>, where:</p> <p>1 - (TRUE) connector was found. 0 - (FALSE) connector was not found.</p>
Example(s)	<p>CONF:ACQ:MODE CFC INIT INIT:STAT? Returns 0 when acquisition is complete. FETC:CFC? Returns 1 if state is "Pass".</p>

:FETCh[1..n]:DURation?

Description	<p>This query returns the duration for the trace corresponding to the specified trace index.</p> <p>*RST clears this setting.</p>
Syntax	<p>:FETCh[1..n]:DURation?<wsp>TRC1 TRC2 TRC3 TRC4</p>
Parameter(s)	<p><i>Label:</i></p> <p>The program data syntax for the first parameter is defined as a <CHARACTER PROGRAM DATA> element. The allowed <CHARACTER PROGRAM DATA> elements for this parameter are: TRC1 TRC2 TRC3 TRC4.</p> <p>Trace index of the available wavelengths.</p>
Response Syntax	<p><Duration></p>
Response(s)	<p><i>Duration:</i></p> <p>The response data syntax for <Duration> is defined as a <NR1 NUMERIC RESPONSE DATA> element.</p> <p>Returns the duration.</p>
Example(s)	<p>CONF:ACQ:DUR 15 CONF:ACQ:MODE ACQ INIT INIT:STAT? Returns 0 when acquisition is complete. FETC:DUR? Returns 15</p>
See Also	<p>FETCh[1..n]:ASETting:DURation? MMEMory[1..n]:LOAD:TRACe TRACe[1..n]:CATalog?</p>

:FETCh[1..n]:HRESolution?

Description	<p>This query returns a value indicating if the high-resolution feature was enabled for the current trace.</p> <p>*RST clears this setting.</p>
Syntax	:FETCh[1..n]:HRESolution?<wsp>TRC1 TRC2 TRC3 TRC4
Parameter(s)	<p><i>Label:</i></p> <p>The program data syntax for the first parameter is defined as a <CHARACTER PROGRAM DATA> element. The allowed <CHARACTER PROGRAM DATA> elements for this parameter are: TRC1 TRC2 TRC3 TRC4.</p> <p>Trace index of the available wavelengths.</p>
Response Syntax	<HighResolution>
Response(s)	<p><i>HighResolution:</i></p> <p>The response data syntax for <HighResolution> is defined as a <NR1 NUMERIC RESPONSE DATA> element.</p> <p>Indicates if the high-resolution feature was enabled or not for the current trace.</p>
Example(s)	FETC:HRES? Returns 1 if the high-resolution feature was enabled for the current trace.
See Also	CONFigure[1..n]:ACQuisition:HRESolution

SCPI Command Reference

Product-Specific Commands—Description

:FETCh[1..n]:LFIBer?

Description	This query returns a state indicating whether live activity has been found on the fiber, after an initiate (INIT) command. This is valid for all acquisition modes. *RST clears this setting.
Syntax	:FETCh[1..n]:LFIBer?
Parameter(s)	None
Response Syntax	<LiveFiberState>
Response(s)	<i>LiveFiberState:</i> The response data syntax for <LiveFiberState> is defined as a <NR1 NUMERIC RESPONSE DATA> element. The current <LiveFiberState>, where: 1 - (TRUE) a live activity was found on fiber. 0 - (FALSE) no live activity found on fiber.
Example(s)	INIT INIT:STAT? Returns 0 when acquisition is complete. FETC:LFIB? Returns 1 if a live activity was found on fiber.

:FETCh[1..n]:PULSe?

Description	<p>This query returns the pulse for the specified trace index.</p> <p>*RST clears this setting.</p>
Syntax	:FETCh[1..n]:PULSe? <wsp>TRC1 TRC2 TRC3 TRC4
Parameter(s)	<p><i>Label:</i></p> <p>The program data syntax for the first parameter is defined as a <CHARACTER PROGRAM DATA> element. The allowed <CHARACTER PROGRAM DATA> elements for this parameter are: TRC1 TRC2 TRC3 TRC4.</p> <p>Trace index of the available wavelengths.</p>
Response Syntax	<Pulse>
Response(s)	<p><i>Pulse:</i></p> <p>The response data syntax for <Pulse> is defined as a <NR3 NUMERIC RESPONSE DATA> element.</p> <p>Returns the pulse, in seconds.</p>
Example(s)	<p>CONF:ACQ 1310,NM1250,M10 NS CONF:ACQ:MODE ACQ INIT INIT:STAT? Returns 0 when acquisition is complete. FETC:PULS? Returns 1E-8</p>
See Also	<p>FETCh[1..n]:ASETting:PULSe? MMEMory[1..n]:LOAD:TRACe TRACe[1..n]:CATalog?</p>

SCPI Command Reference

Product-Specific Commands—Description

:FETCh[1..n]:RANGe?

Description	<p>This query returns the range for the trace corresponding to the specified trace index.</p> <p>*RST clears this setting.</p>
Syntax	<code>:FETCh[1..n]:RANGe?<wsp>TRC1 TRC2 TRC3 TRC4</code>
Parameter(s)	<p><i>Label:</i></p> <p>The program data syntax for the first parameter is defined as a <CHARACTER PROGRAM DATA> element. The allowed <CHARACTER PROGRAM DATA> elements for this parameter are: TRC1 TRC2 TRC3 TRC4.</p> <p>Trace index of the available wavelengths.</p>
Response Syntax	<code><Range></code>
Response(s)	<p><i>Range:</i></p> <p>The response data syntax for <Range> is defined as a <NR3 NUMERIC RESPONSE DATA> element.</p> <p>Returns the range, in meters.</p>
Example(s)	<pre>CONF:ACQ 1310,NM1250,M10 NS CONF:ACQ:MODE ACQ INIT INIT:STAT? Returns 0 when acquisition is complete. FETC:RANG? TRC1 Returns 1.25E+3</pre>
See Also	<code>FETCh[1..n]:ASETting:RANGe?</code> <code>MMEMory[1..n]:LOAD:TRACe</code> <code>TRACe[1..n]:CATalog?</code>

:FETCh[1..n]:STEP?

Description	<p>This query returns the step between each point of the trace corresponding to the specified trace index.</p> <p>*RST clears this setting.</p>
Syntax	:FETCh[1..n]:STEP? <wsp> TRC1 TRC2 TRC3 TRC4
Parameter(s)	<p><i>Label:</i></p> <p>The program data syntax for the first parameter is defined as a <CHARACTER PROGRAM DATA> element. The allowed <CHARACTER PROGRAM DATA> elements for this parameter are: TRC1 TRC2 TRC3 TRC4.</p> <p>Trace index of the available wavelengths.</p>
Response Syntax	<Step>
Response(s)	<p><i>Step:</i></p> <p>The response data syntax for <Step> is defined as a <NR3 NUMERIC RESPONSE DATA> element.</p> <p>Returns the step value, in meters.</p>
Example(s)	<p>CONF:ACQ:MODE ACQ INIT INIT:STAT? Returns 0 when acquisition is complete. FETC:STEP? Ex.: Returns 0.07979</p>
See Also	<p>MMEMoRY[1..n]:LOAD:TRACe TRACe[1..n]:CATalog?</p>

:FETCh[1..n]:TRACe[1..n][:DATA]?

Description	<p>This query returns all the points of a trace. It can be used with already-completed acquisitions or acquisitions in progress.</p> <p>*RST clears this setting.</p>
Syntax	:FETCh[1..n]:TRACe[1..n][:DATA]?
Parameter(s)	None
Response Syntax	<Data>
Response(s)	<p><i>Data:</i></p> <p>The response data syntax for <Data> is defined as a <DEFINITE LENGTH ARBITRARY BLOCK RESPONSE DATA> element.</p> <p>Returns a list of power values representing the trace.</p> <p>Each power value represents a point of the trace and is always returned in dB as a <NR3 NUMERIC RESPONSE DATA> type.</p>
Example(s)	<pre>CONF:ACQ:MODE ACQ INIT INIT:STAT? Returns 1 when acquisition is in progress FETC:TRAC? Returns a trace, while acquisition is in progress or complete</pre>
See Also	<pre>FETCh[1..n]:TRACe[1..n]:POIN? TRACe[1..n]:CATalog?</pre>

:FETCh[1..n]:TRACe[1..n]:POINts?

Description	<p>This query returns the number of points of the trace. It can be used with already-completed acquisitions or acquisitions in progress.</p> <p>*RST clears this setting.</p>
Syntax	:FETCh[1..n]:TRACe[1..n]:POINts?
Parameter(s)	None
Response Syntax	<PointsCount>
Response(s)	<p><i>PointsCount:</i></p> <p>The response data syntax for <PointsCount> is defined as a <NR1 NUMERIC RESPONSE DATA> element.</p>
Example(s)	<p>Returns the number of points.</p> <pre>CONF:ACQ:MODE ACQ INIT INIT:STAT? Returns 1 when acquisition is in progress FETC:TRAC:POIN? Returns the number of points of the current FETC:TRAC?</pre>
See Also	FETCh[1..n]:TRACe[1..n][:DATA]?

:FETCh[1..n]:WAVelength?

Description	<p>This query returns the wavelength for the trace corresponding to the specified trace index.</p> <p>*RST clears this setting.</p>
Syntax	<pre>:FETCh[1..n]:WAVelength? <wsp> TRC1 TRC2 TRC3 TRC4</pre>
Parameter(s)	<p><i>Label:</i></p> <p>The program data syntax for the first parameter is defined as a <CHARACTER PROGRAM DATA> element. The allowed <CHARACTER PROGRAM DATA> elements for this parameter are: TRC1 TRC2 TRC3 TRC4.</p> <p>Trace index of the available wavelengths.</p>
Response Syntax	<pre><Wavelength></pre>
Response(s)	<p><i>Wavelength:</i></p> <p>The response data syntax for <Wavelength> is defined as a <NR3 NUMERIC RESPONSE DATA> element.</p> <p>Returns the wavelength, in meters.</p>
Example(s)	<pre>CONF:ACQ 1310,NM1250,M10 NS CONF:ACQ:MODE ACQ INIT INIT:STAT? Returns 0 when acquisition is complete. FETC:WAV? TRC1 Returns 1.31E-6</pre>
See Also	<pre>MMEMory[1..n]:LOAD:TRACe TRACe[1..n]:CATalog?</pre>

:INITiate[1..n][:IMMediate]

Description

This command starts the acquisition according to the active acquisition mode.

Acquisition mode:

ACQuisition: Acquisition stops after the duration value has elapsed.

REALtime: Acquisition is in progress until an abort event is sent.

CFConnector: Acquisition stops after determining the injection level at the first connector.

ASETting: Acquisition stops after determining the adequate range and pulse values.

This command is asynchronous.

This command is an event and, therefore, has no associated *RST condition or query form.

However, on *RST, the equivalent of an ABORt command is performed on any acquisition in progress.

Syntax

:INITiate[1..n][:IMMediate]

Parameter(s)

None

Example(s)

INIT

See Also

CONFigure[1..n]:ACQuisition:MODE
 INITiate[1..n]:STATe?
 ABORt[1..n]

SCPI Command Reference

Product-Specific Commands—Description

:INITiate[1..n]:STATE?

Description	This query returns a state indicating whether an acquisition is in progress or stopped (ABORT). *RST sets state to OFF (all acquisitions are stopped).
Syntax	:INITiate[1..n]:STATE?
Parameter(s)	None
Response Syntax	<AcquisitionState>
Response(s)	<i>AcquisitionState</i> : The response data syntax for <AcquisitionState> is defined as a <NR1 NUMERIC RESPONSE DATA> element. The current acquisition <AcquisitionState>, where: 1 - (TRUE) acquisition is in progress. 0 - (FALSE) acquisition is complete.
Example(s)	INIT INIT:STAT? Returns 0 or 1
See Also	CONFigure[1..n]:ACQquisition:MODE ABORt[1..n]

:MMEMory[1..n]:DATA:TYPE

Description	<p>This command sets file format for a trace to be saved in a file.</p> <p>*RST sets type to BINARY.</p>
Syntax	:MMEMory[1..n]:DATA:TYPE<wsp>BINary ASCii BELLcore
Parameter(s)	<p><i>FileType:</i></p> <p>The program data syntax for the first parameter is defined as a <CHARACTER PROGRAM DATA> element. The allowed <CHARACTER PROGRAM DATA> elements for this parameter are: BINary ASCii BELLcore.</p> <p>Sets the file format.</p>
Example(s)	<p>MMEM:DATA:TYPE? Ex.: Returns BINARY</p> <p>MMEM:DATA:TYPE ASC</p> <p>MMEM:DATA:TYPE? Returns ASCII</p>
See Also	<p>CONFigure[1..n]:ACQuisition:MODE</p> <p>INITiate[1..n][:IMMediate]</p> <p>MMEMory[1..n]:STORe:TRACe</p> <p>MMEMory[1..n]:LOAD:TRACe</p>

SCPI Command Reference

Product-Specific Commands—Description

:MMEMory[1..n]:DATA:TYPE?

Description	This query returns the current file format. *RST sets type to BINARY.
Syntax	:MMEMory[1..n]:DATA:TYPE?
Parameter(s)	None
Response Syntax	<FileType>
Response(s)	<i>FileType</i> : The response data syntax for <FileType> is defined as a <CHARACTER RESPONSE DATA> element.
Example(s)	Returns the file format. MMEM:DATA:TYPE ASC MMEM:DATA:TYPE? Returns ASCII
Notes	Will not change if a different file type is loaded.
See Also	MMEMory[1..n]:LOAD:TRACe

:MMEMory[1..n]:LOAD:NAME?

Description	This query returns the name of the current loaded file. *RST clears this setting.
Syntax	:MMEMory[1..n]:LOAD:NAME?
Parameter(s)	None
Response Syntax	<FileName>
Response(s)	<i>FileName:</i> The response data syntax for <FileName> is defined as a <STRING RESPONSE DATA> element. Returns the loaded file name.
Example(s)	MMEM:LOAD:TRAC "Trace1.trc" MMEM:LOAD:NAME? Returns "Trace1.trc"
See Also	MMEMory[1..n]:LOAD:TRACe MMEMory[1..n]:STORE:TRACe

:MMEMory[1..n]:LOAD:TRACe

Description	<p>This command is used to load traces from a file.</p> <p>*RST does not affect this command.</p>
Syntax	<p>:MMEMory[1..n]:LOAD:TRACe<wsp><FileName></p>
Parameter(s)	<p><i>FileName:</i></p> <p>The program data syntax for <FileName> is defined as a <STRING PROGRAM DATA> element.</p> <p>The <FileName> parameter can either be only the filename or the filename and its path.</p> <p>If no path is specified, the default path is used. The default path name depends on the location of the installation directory.</p>
Example(s)	<p>MMEM:LOAD:TRAC "Trace1.trc"</p>
Notes	<p>No effect on MMEM:DATA:TYPE?</p>
See Also	<p>MMEMory[1..n]:DATA:TYPE? CONFigure[1..n]:ACQuisition:MODE NITiate[1..n][:IMMediate] MMEMory[1..n]:STORe:TRACe</p>

:MMEMory[1..n]:STORE:TRACe

Description	<p>This command is used to store traces to a file.</p> <p>*RST does not affect this command.</p>
Syntax	:MMEMory[1..n]:STORE:TRACe<wsp><FileName>
Parameter(s)	<p><i>FileName:</i></p> <p>The program data syntax for <FileName> is defined as a <STRING PROGRAM DATA> element.</p> <p>The <FileName> parameter can either be only the filename or the filename and its path.</p> <p>If no path is specified, the default path is used. The default path name depends on the location of the installation directory.</p>
Example(s)	<pre>CONF:ACQ:MODE ACQ INIT INIT:STAT? Returns 0 when acquisition is complete. MMEM:STOR:TRAC "Trace2.trc"</pre>
See Also	<pre>MMEMory[1..n]:LOAD:TRACe MMEMory[1..n]:DATA:TYPE MMEM:STORE:TRACe:OVERwrite</pre>

:MMEMory[1..n]:STORE:TRACe: OVERwrite

Description

This command specifies if an existing file can be overwritten without generating an error when the MMEMory:STORE:TRACe command is used. Attempting to save a new file under the name of an existing file will generate an error if the value is set to OFF.

*RST sets overwrite to OFF.

Syntax

:MMEMory[1..n]:STORE:TRACe:OVERwrite <wsp>
> <Overwrite>

Parameter(s)

Overwrite:

The program data syntax for <Overwrite> is defined as a <Boolean Program Data> element. The <Overwrite> special forms ON and OFF are accepted on input for increased readability. ON corresponds to 1 and OFF corresponds to 0.

:MMEMory[1..n]:STORE:TRACe: OVERwrite

Enables or disables the right to overwrite an existing file.

Example(s)

CONF:ACQ:MODE ACQ

INIT

INIT:STAT? Returns 0 when acquisition is complete.

MMEM:STOR:TRAC:OVER? Ex.: Returns 0

MMEM:STOR:TRAC "Trace3.trc" If file already exists, an error occurs.

MMEM:STOR:TRAC:OVER 1

MMEM:STOR:TRAC "Trace3.trc" File will save without generating errors.

:MMEMory[1..n]:STORE:TRACe:OVERwrite?

Description	This query indicates if an existing file can be overwritten. *RST sets overwrite to OFF.
Syntax	:MMEMory[1..n]:STORE:TRACe:OVERwrite?
Parameter(s)	None
Response Syntax	<Overwrite>
Response(s)	<i>Overwrite:</i> The response data syntax for <Overwrite> is defined as a <NR1 NUMERIC RESPONSE DATA> element. Overwrite state. 1 - (TRUE) Always overwrites file. 0 - (FALSE) Does not overwrite file if it already exists.
Example(s)	MMEM:STOR:TRAC:OVER 1 MMEM:STOR:TRAC:OVER? Returns 1

:SOURce[1..n]:FREQuency:BURSt

Description	<p>This command sets the frequency of the source's ON-OFF modulated signal during its ON period (modulation for fiber identification). This signal is referred to as "burst signal" .</p> <p>*RST reverts this setting to its default value.</p>
Syntax	<p>:SOURce[1..n]:FREQuency:BURSt<wsp><Burst Frequency> MAXimum MINimum DEFault</p>
Parameter(s)	<p><i>BurstFrequency:</i></p> <p>The program data syntax for <BurstFrequency> is defined as a <numeric_value> element. The <BurstFrequency> special forms MINimum, MAXimum and DEFault are accepted on input.</p>

:SOURce[1..n]:FREQuency:BURSt

MINimum allows to set the instrument to the lowest supported value.

MAXimum allows to set the instrument to the highest supported value.

DEFault allows the instrument to select a value for the <BurstFrequency> parameter.

Frequency of the source's burst signal, in hertz.

Example(s)

```
SOUR:FREQ:BURS 1000
SOUR:FREQ:BURS:STAT ON
SOUR:POW:STAT:TIME 60
SOUR:POW:STAT ON
```

See Also

```
SOURce[1..n]:FREQuency:BURSt?
SOURce[1..n]:FREQuency:BURSt:STATe
SOURce[1..n]:FREQuency:PRF
SOURce[1..n]:FREQuency:PRF:STATe
SOURce[1..n]:POWER:STATE
SOURce[1..n]:POWER:STATE:TIME
```

:SOURce[1..n]:FREQuency:BURSt?

Description This query returns the frequency of the source's ON-OFF modulated signal during its ON period (modulation for fiber identification). This signal is referred to as "burst signal" .

*RST reverts this setting to its default value.

Syntax :SOURce[1..n]:FREQuency:BURSt?[<wsp>MINimum | MAXimum | DEFault]

Parameter(s) *Parameter 1:*
 The program data syntax for the first parameter is defined as a <CHARACTER PROGRAM DATA> element. The allowed <CHARACTER PROGRAM DATA> elements for this parameter are: MINimum | MAXimum | DEFault.

MINimum is used to retrieve the instrument's lowest supported value.

MAXimum is used to retrieve the instrument's highest supported value.

DEFault is used to retrieve the instrument's default value.

Response Syntax <BurstFrequency>

SCPI Command Reference

Product-Specific Commands—Description

:SOURce[1..n]:FREQuency:BURSt?

Response(s)	<i>BurstFrequency:</i> The response data syntax for <BurstFrequency> is defined as a <NR3 NUMERIC RESPONSE DATA> element. Frequency of the source's burst signal, in hertz.
Example(s)	SOUR:FREQ:BURS 1000 SOUR:FREQ:BURS? Returns 1.000000e+3
See Also	SOURce[1..n]:FREQuency:BURSt SOURce[1..n]:FREQuency:BURSt:STATe SOURce[1..n]:FREQuency:PRF SOURce[1..n]:FREQuency:PRF:STATe SOURce[1..n]:POWer:STATe SOURce[1..n]:POWer:STATe:TIME

:SOURce[1..n]:FREQUency:BURSt:STATe

Description	<p>This command turns on or off the burst signal of the source (modulation for fiber identification).</p> <p>At *RST, the burst signal state of the source is set to OFF (source emits in continuous output- CW).</p>
Syntax	:SOURce[1..n]:FREQUency:BURSt:STATe<wsp><State>
Parameter(s)	<p><i>State:</i></p> <p>The program data syntax for <State> is defined as a <Boolean Program Data> element. The <State> special forms ON and OFF are accepted on input for increased readability. ON corresponds to 1 and OFF corresponds to 0.</p> <p>Burst signal state of the source (on or off). ON: Modulation for fiber identification OFF: CW (continuous output)</p>
Example(s)	<pre>SOUR:FREQ:BURS 1000 SOUR:FREQ:BURS:STAT ON SOUR:POW:STAT:TIME 60 SOUR:POW:STAT ON</pre>
See Also	<pre>SOURce[1..n]:FREQUency:BURSt SOURce[1..n]:FREQUency:BURSt:STATe? SOURce[1..n]:FREQUency:PRF SOURce[1..n]:FREQUency:PRF:STATe SOURce[1..n]:POWer:STATe SOURce[1..n]:POWer:STATe:TIME</pre>

:SOURce[1..n]:FREQuency:BURSt:STATe?

Description	<p>This query returns a value indicating the current state of the source's burst signal.</p> <p>At *RST, the burst signal state of the source is set to OFF (source emits in continuous output- CW).</p>
Syntax	:SOURce[1..n]:FREQuency:BURSt:STATe?
Parameter(s)	None
Response Syntax	<State>
Response(s)	<p><i>State:</i></p> <p>The response data syntax for <State> is defined as a <NR1 NUMERIC RESPONSE DATA> element.</p> <p>Burst signal state of the source (on or off). ON: Modulation for fiber identification OFF: CW (continuous output)</p>
Example(s)	<p>SOUR:FREQ:BURS:STAT ON SOUR:FREQ:BURS:STAT? Returns 1</p>
See Also	<p>SOURce[1..n]:FREQuency:BURSt SOURce[1..n]:FREQuency:BURSt:STATe SOURce[1..n]:FREQuency:PRF SOURce[1..n]:FREQuency:PRF:STATe SOURce[1..n]:POWEr:STATe SOURce[1..n]:POWEr:STATe:TIME</p>

:SOURce[1..n]:FREQuency:PRF

Description

This command sets the repetition frequency of the on-off modulation of the source signal that is periodically switched on and off (flashing pattern). This characteristic is referred to as "Pulsed Repetition Frequency" (PRF).

*RST reverts this setting to its default value.

Syntax

:SOURce[1..n]:FREQuency:PRF <wsp> <Pulsed Repetition Frequency> | MAXimum | MINimum | DEFault

Parameter(s)

PulsedRepetitionFrequency:

The program data syntax for <PulsedRepetitionFrequency> is defined as a <numeric_value> element. The <PulsedRepetitionFrequency> special forms MINimum, MAXimum and DEFault are accepted on input.

MINimum allows to set the instrument to the lowest supported value.

MAXimum allows to set the instrument to the highest supported value.

DEFault allows the instrument to select a value for the <PulsedRepetitionFrequency> parameter.

Pulsed Repetition Frequency (PRF) of the source's signal.

SCPI Command Reference

Product-Specific Commands—Description

:SOURce[1..n]:FREQuency:PRF

Example(s)	SOUR:FREQ:PRF 1000 SOUR:FREQ:PRF:STAT ON SOUR:POW:STAT:TIME 60 SOUR:POW:STAT ON
Notes	Using a flashing pattern makes fiber identification easier. In a flashing pattern, the modulated signal will be sent for 1 second, then will be off for the next second, then will be sent again for 1 second, and so on.
See Also	SOURce[1..n]:FREQuency:PRF? SOURce[1..n]:FREQuency:PRF:STATe SOURce[1..n]:FREQuency:BURSt SOURce[1..n]:FREQuency:BURSt:STATe SOURce[1..n]:POWer:STATe SOURce[1..n]:POWer:STATe:TIME

:SOURce[1..n]:FREQuency:PRF?

Description

This query returns the repetition frequency of the on-off modulation of the source signal that is periodically switched on and off (flashing pattern). This characteristic is referred to as "Pulsed Repetition Frequency" (PRF).

*RST reverts this setting to its default value.

Syntax

:SOURce[1..n]:FREQuency:PRF?[<wsp>MINimum|MAXimum|DEFault]

Parameter(s)

Parameter 1:

The program data syntax for the first parameter is defined as a <CHARACTER PROGRAM DATA> element. The allowed <CHARACTER PROGRAM DATA> elements for this parameter are: MINimum|MAXimum|DEFault.

MINimum is used to retrieve the instrument's lowest supported value.

MAXimum is used to retrieve the instrument's highest supported value.

DEFault is used to retrieve the instrument's default value.

Response Syntax

<PulsedRepetitionFrequency>

SCPI Command Reference

Product-Specific Commands—Description

:SOURce[1..n]:FREQuency:PRF?

Response(s)	<p><i>PulsedRepetitionFrequency:</i></p> <p>The response data syntax for <PulsedRepetitionFrequency> is defined as a <NR3 NUMERIC RESPONSE DATA> element.</p> <p>Pulsed Repetition Frequency (PRF) of the source's signal.</p>
Example(s)	<p>SOUR:FREQ:PRF 1000</p> <p>SOUR:FREQ:PRF? Returns 1.000000e+3</p>
See Also	<p>SOURce[1..n]:FREQuency:PRF</p> <p>SOURce[1..n]:FREQuency:PRF:STATe</p> <p>SOURce[1..n]:FREQuency:BURSt</p> <p>SOURce[1..n]:FREQuency:BURSt:STATe</p> <p>SOURce[1..n]:POWer:STATe</p> <p>SOURce[1..n]:POWer:STATe:TIME</p>

:SOURce[1..n]:FREQuency:PRF:STATe

Description	<p>This command is used to turn on or off the pulsed repetition frequency (PRF) of the source (enable or disable the flashing pattern).</p> <p>At *RST, the PRF signal state is set to OFF.</p>
Syntax	:SOURce[1..n]:FREQuency:PRF:STATe<wsp><State>
Parameter(s)	<p><i>State:</i></p> <p>The program data syntax for <State> is defined as a <Boolean Program Data> element. The <State> special forms ON and OFF are accepted on input for increased readability. ON corresponds to 1 and OFF corresponds to 0.</p> <p>State of the source's PRF signal.</p>
Example(s)	<pre>SOUR:FREQ:PRF 1000 SOUR:FREQ:PRF:STAT ON SOUR:POW:STAT:TIME 60 SOUR:POW:STAT ON</pre>
See Also	<pre>SOURce[1..n]:FREQuency:PRF:STATe? SOURce[1..n]:FREQuency:PRF SOURce[1..n]:FREQuency:BURSt SOURce[1..n]:FREQuency:BURSt:STATe SOURce[1..n]:POWer:STATe SOURce[1..n]:POWer:STATe:TIME</pre>

:SOURce[1..n]:FREQuency:PRF:STATe?

Description	<p>This query returns a value indicating the current state of the source's pulsed repetition frequency (PRF) signal (flashing pattern enabled or disabled).</p> <p>At *RST, the PRF signal state is set to OFF.</p>
Syntax	:SOURce[1..n]:FREQuency:PRF:STATe?
Parameter(s)	None
Response Syntax	<State>
Response(s)	<p><i>State:</i></p> <p>The response data syntax for <State> is defined as a <NR1 NUMERIC RESPONSE DATA> element.</p> <p>State of the source's PRF signal.</p>
Example(s)	<p>SOUR:FREQ:PRF:STAT ON SOUR:FREQ:PRF:STAT? Returns 1</p>
See Also	<p>SOURce[1..n]:FREQuency:PRF SOURce[1..n]:FREQuency:PRF:STATe SOURce[1..n]:FREQuency:BURSt SOURce[1..n]:FREQuency:BURSt:STATe SOURce[1..n]:POWer:STATe SOURce[1..n]:POWer:STATe:TIME</p>

:SOURce[1..n]:POWer:STATe

Description	This command turns the source on or off. *RST sets the source to OFF.
Syntax	:SOURce[1..n]:POWer:STATe<wsp> <State>
Parameter(s)	<i>State:</i> The program data syntax for <State> is defined as a <Boolean Program Data> element. The <State> special forms ON and OFF are accepted on input for increased readability. ON corresponds to 1 and OFF corresponds to 0. New power state of the source. 1 or ON, turns the source on. 0 or OFF, turns the source off.
Example(s)	SOUR:POW:STAT:TIME 60 SOUR:POW:STAT ON
See Also	SOURce[1..n]:POWer:STATe? SOURce[1..n]:POWer:STATe:TIME SOURce[1..n]:FREQuency:PRF SOURce[1..n]:FREQuency:PRF:STATe SOURce[1..n]:FREQuency:BURSt SOURce[1..n]:FREQuency:BURSt:STATe

:SOURce[1..n]:POWER:STATe?

Description	This query returns a value indicating the state of the source (on or off). *RST sets the source to OFF.
Syntax	:SOURce[1..n]:POWER:STATe?
Parameter(s)	None
Response Syntax	<State>
Response(s)	<i>State:</i> The response data syntax for <State> is defined as a <NR1 NUMERIC RESPONSE DATA> element. State of the source power. 0: Source is off. 1: Source is on.
Example(s)	SOUR:POW:STAT ON SOUR:POW:STAT? Returns 1
See Also	SOURce[1..n]:POWER:STATe SOURce[1..n]:POWER:STATe:TIME SOURce[1..n]:FREQuency:PRF SOURce[1..n]:FREQuency:PRF:STATe SOURce[1..n]:FREQuency:BURSt SOURce[1..n]:FREQuency:BURSt:STATe

:SOURce[1..n]:POWER:STATe:TIME

Description	<p>This command sets the duration after which the source will stop emitting light automatically (auto-off feature). Note that this command does not turn the source on.</p> <p>*RST sets this value to 600 seconds.</p>
Syntax	:SOURce[1..n]:POWER:STATe:TIME<wsp> <Duration>
Parameter(s)	<p><i>Duration:</i></p> <p>The program data syntax for <Duration> is defined as a <DECIMAL NUMERIC PROGRAM DATA> element.</p> <p>Duration after which the source will stop emitting light automatically, in seconds.</p>
Example(s)	<pre>SOUR:POW:STAT:TIME 60 SOUR:POW:STAT ON</pre>
See Also	<pre>SOURce[1..n]:POWER:STATe:TIME? SOURce[1..n]:POWER:STATe SOURce[1..n]:FREQuency:PRF SOURce[1..n]:FREQuency:PRF:STATe SOURce[1..n]:FREQuency:BURSt SOURce[1..n]:FREQuency:BURSt:STATe</pre>

:SOURce[1..n]:POWER:STATe:TIME?

Description	<p>This query returns a value indicating the duration after which the source will stop emitting light automatically (auto-off feature).</p> <p>*RST sets this value to 600 seconds.</p>
Syntax	:SOURce[1..n]:POWER:STATe:TIME?
Parameter(s)	None
Response Syntax	<Duration>
Response(s)	<p><i>Duration:</i></p> <p>The response data syntax for <Duration> is defined as a <NR3 NUMERIC RESPONSE DATA> element.</p> <p>Duration after which the source will stop emitting light automatically, in seconds.</p>
Example(s)	<p>SOUR:POW:STAT:TIME 60 SOUR:POW:STAT:TIME? Returns 60</p>
See Also	<p>SOURce[1..n]:POWER:STATe:TIME SOURce[1..n]:POWER:STATe SOURce[1..n]:FREQuency:PRF SOURce[1..n]:FREQuency:PRF:STATe SOURce[1..n]:FREQuency:BURSt SOURce[1..n]:FREQuency:BURSt:STATe</p>

:SOURce[1..n]:VFLocator:AM:INTernal: FREQUENCY

Description	<p>This command selects the internal modulation frequency of the visual fault locator (VFL). The internal modulation corresponds to 50 % of the duty cycle at the selected frequency.</p> <p>*RST sets the modulation frequency to 0 Hz (CW).</p>
Syntax	<p>:SOURce[1..n]:VFLocator:AM:INTernal:FREQUENCY<wsp><Frequency> MAXimum MINimum DEFault</p>
Parameter(s)	<p><i>Frequency:</i></p> <p>The program data syntax for <Frequency> is defined as a <numeric_value> element. The <Frequency> special forms MINimum, MAXimum and DEFault are accepted on input.</p>

:SOURce[1..n]:VFLocator:AM:INTernal: FREQuency

MINimum allows to set the instrument to the lowest supported value.

MAXimum allows to set the instrument to the highest supported value.

DEFault allows the instrument to select a value for the <Frequency> parameter.

New modulation frequency: 1 or 0 (CW).

Example(s)

```
SOUR:VFL:AM:INT:FREQ 1  
SOUR:VFL:AM:STAT ON  
SOUR:VFL:POW:STAT ON
```

See Also

```
SOURce[1..n]:VFLocator:AM:INTernal:FREQuency?  
SOURce[1..n]:VFLocator:AM:STATe  
SOURce[1..n]:VFLocator:POWer:STATe  
SOURce[1..n]:VFLocator:POWer:STATe:TIME
```

:SOURce[1..n]:VFLocator:AM:INTernal: FREQUency?

Description	<p>This query returns a value indicating the current internal modulation frequency. If the visual fault locator (VFL) is in CW mode, the function will return 0.</p> <p>*RST sets the modulation frequency to 0 Hz (CW).</p>
Syntax	:SOURce[1..n]:VFLocator:AM:INTernal:FREQUency? [<wsp>MINimum MAXimum DEFault]
Parameter(s)	<p><i>Parameter 1:</i></p> <p>The program data syntax for the first parameter is defined as a <CHARACTER PROGRAM DATA> element. The allowed <CHARACTER PROGRAM DATA> elements for this parameter are: MINimum MAXimum DEFault.</p> <p>MINimum is used to retrieve the instrument's lowest supported value. MAXimum is used to retrieve the instrument's highest supported value. DEFault is used to retrieve the instrument's default value.</p>
Response Syntax	<Frequency>

:SOURce[1..n]:VFLocator:AM:INTernal: FREQuency?

Response(s)	<p><i>Frequency:</i></p> <p>The response data syntax for <Frequency> is defined as a <NR3 NUMERIC RESPONSE DATA> element.</p> <p>The <Frequency> response corresponds to the internal modulation frequency of the VFL, in Hz. If the VFL is in CW mode, the returned value is 0.</p>
Example(s)	<p>SOUR:VFL:AM:INT:FREQ 1 SOUR:VFL:AM:INT:FREQ? Returns 1</p>
See Also	<p>SOURce[1..n]:VFLocator:AM:INTernal:FREQuency SOURce[1..n]:VFLocator:AM:STATe SOURce[1..n]:VFLocator:POWer:STATe SOURce[1..n]:VFLocator:POWer:STATe:TIME</p>

:SOURce[1..n]:VFLocator:AM:STATE

Description	<p>This command turns ON or OFF the amplitude modulation of the visual fault locator (VFL).</p> <p>At *RST, this value is set to OFF.</p>
Syntax	:SOURce[1..n]:VFLocator:AM:STATe <wsp> <State>
Parameter(s)	<p><i>State:</i></p> <p>The program data syntax for <State> is defined as a <Boolean Program Data> element. The <State> special forms ON and OFF are accepted on input for increased readability. ON corresponds to 1 and OFF corresponds to 0.</p> <p>The <State> parameter corresponds to the amplitude modulation state of the VFL.</p>
Example(s)	<pre>SOUR:VFL:AM:INT:FREQ 1 SOUR:VFL:POW:STAT:TIME 60 SOUR:VFL:AM:STAT ON SOUR:VFL:POW:STAT ON</pre>
See Also	<pre>SOURce[1..n]:VFLocator:AM:STATE? SOURce[1..n]:VFLocator:AM:INTernal:FREQuency SOURce[1..n]:VFLocator:POWer:STATE SOURce[1..n]:VFLocator:POWer:STATE:TIME</pre>

:SOURce[1..n]:VFLocator:AM:STATe?

Description	<p>This query returns a value indicating the current state of the amplitude modulation (on or off) of the visual fault locator (VFL).</p> <p>At *RST, the amplitude modulation state is set to OFF.</p>
Syntax	:SOURce[1..n]:VFLocator:AM:STATe?
Parameter(s)	None
Response Syntax	<State>
Response(s)	<p><i>State:</i></p> <p>The response data syntax for <State> is defined as a <NR1 NUMERIC RESPONSE DATA> element.</p> <p>Amplitude modulation state of the VFL. ON: Signal is modulated. OFF: Signal is continuous (CW).</p>
Example(s)	<p>SOUR:VFL:AM:STAT ON SOUR:VFL:AM:STAT? Returns 1</p>
See Also	<p>SOURce[1..n]:VFLocator:AM:STATe SOURce[1..n]:VFLocator:AM:INTErnal:FREQUency SOURce[1..n]:VFLocator:POWEr:STATe SOURce[1..n]:VFLocator:POWEr:STATe:TIME</p>

:SOURce[1..n]:VFLocator:POWer:STATe

Description	<p>This command turns the visual fault locator (VFL) on or off.</p> <p>*RST sets the visual fault locator to OFF.</p>
Syntax	:SOURce[1..n]:VFLocator:POWer:STATe<wsp><State>
Parameter(s)	<p><i>State:</i></p> <p>The program data syntax for <State> is defined as a <Boolean Program Data> element. The <State> special forms ON and OFF are accepted on input for increased readability. ON corresponds to 1 and OFF corresponds to 0.</p>
Example(s)	<p>New power state of the VFL.</p> <pre>SOUR:VFL:AM:INT:FREQ 1 SOUR:VFL:POW:STAT:TIME 60 SOUR:VFL:AM:STAT ON SOUR:VFL:POW:STAT ON</pre>
See Also	<pre>SOURce[1..n]:VFLocator:POWer:STATe? SOURce[1..n]:VFLocator:POWer:STATe:TIME SOURce[1..n]:VFLocator:AM:STATe? SOURce[1..n]:VFLocator:AM:INTernal:FREQuency</pre>

:SOURce[1..n]:VFLocator:POWer:STATe?

Description	This query returns a value indicating if the visual fault locator (VFL) is on or off. *RST sets the VFL to OFF.
Syntax	:SOURce[1..n]:VFLocator:POWer:STATe?
Parameter(s)	None
Response Syntax	<State>
Response(s)	<i>State:</i> The response data syntax for <State> is defined as a <NR1 NUMERIC RESPONSE DATA> element. Power state of the VFL (on or off).
Example(s)	SOUR:VFL:POW:STAT ON SOUR:VFL:POW:STAT? Returns 1
See Also	SOURce[1..n]:VFLocator:POWer:STATe SOURce[1..n]:VFLocator:POWer:STATe:TIME SOURce[1..n]:VFLocator:AM:STATe? SOURce[1..n]:VFLocator:AM:INTernal:FREQuency

:SOURce[1..n]:VFLocator:POWer:STATe:TIME

Description	<p>This command sets the duration after which the visual fault locator (VFL) will stop emitting light automatically (auto-off feature). Note that this command does not turn the VFL on.</p> <p>*RST sets this value to 600 seconds.</p>
Syntax	<p>:SOURce[1..n]:VFLocator:POWer:STATe:TIME<wsp> <Duration> MAXimum MINimum DEFault</p>
Parameter(s)	<p><i>Duration:</i></p> <p>The program data syntax for <Duration> is defined as a <numeric_value> element. The <Duration> special forms MINimum, MAXimum and DEFault are accepted on input.</p>

:SOURce[1..n]:VFLocator:POWer:STATe: TIME

MINimum allows to set the instrument to the lowest supported value.

MAXimum allows to set the instrument to the highest supported value.

DEFault allows the instrument to select a value for the <Duration> parameter.

Duration after which the laser will stop emitting light automatically, in seconds.

Example(s)

```
SOUR:VFL:AM:INT:FREQ 1
SOUR:VFL:POW:STAT:TIME 60
SOUR:VFL:AM:STAT ON
SOUR:VFL:POW:STAT ON
```

See Also

```
SOURce[1..n]:VFLocator:POWer:STATe:TIME?
SOURce[1..n]:VFLocator:POWer:STATe
SOURce[1..n]:VFLocator:AM:STATe?
SOURce[1..n]:VFLocator:AM:INTernal:FREQuency
```

:SOURce[1..n]:VFLocator:POWer:STATe:TIME?

Description	<p>This query returns a value indicating the duration after which the visual fault locator (VFL) will stop emitting light automatically (auto-off feature).</p> <p>*RST sets this value to 600 seconds.</p>
Syntax	<p>:SOURce[1..n]:VFLocator:POWer:STATe:TIME?[<wsp>MINimum MAXimum DEFault]</p>
Parameter(s)	<p><i>Parameter 1:</i></p> <p>The program data syntax for the first parameter is defined as a <CHARACTER PROGRAM DATA> element. The allowed <CHARACTER PROGRAM DATA> elements for this parameter are: MINimum MAXimum DEFault.</p> <p>MINimum is used to retrieve the instrument's lowest supported value. MAXimum is used to retrieve the instrument's highest supported value. DEFault is used to retrieve the instrument's default value.</p>
Response Syntax	<p><Duration></p>

:SOURce[1..n]:VFLocator:POWer:STATe: TIME?

Response(s)	<i>Duration:</i> The response data syntax for <Duration> is defined as a <NR3 NUMERIC RESPONSE DATA> element. Duration after which the laser will stop emitting light automatically, in seconds.
Example(s)	SOUR:VFL:POW:STAT:TIME 60 SOUR:VFL:POW:STAT:TIME? Returns 60
See Also	SOURce[1..n]:VFLocator:POWer:STATe:TIME SOURce[1..n]:VFLocator:POWer:STATe SOURce[1..n]:VFLocator:AM:STATe? SOURce[1..n]:VFLocator:AM:INTernal: FREQuency

:SOURce[1..n]:WAVelength

Description	<p>This command selects the wavelength of the source, in meters.</p> <p>At *RST, the wavelength that will be selected depends on the instrument you have.</p>
Syntax	:SOURce[1..n]:WAVelength<wsp><Wavelength> MAXimum MINimum DEFAULT
Parameter(s)	<p><i>Wavelength:</i></p> <p>The program data syntax for <Wavelength> is defined as a <numeric_value> element. The <Wavelength> special forms MINimum, MAXimum and DEFAULT are accepted on input.</p> <p>MINimum allows to set the instrument to the lowest supported value. MAXimum allows to set the instrument to the highest supported value. DEFAULT allows the instrument to select a value for the <Wavelength> parameter.</p> <p>Spectrum value in meters or in hertz.</p>
Example(s)	<pre>SOUR:WAV 1550.0E-9m SOUR:POW:STAT:TIME 60 SOUR:POW:STAT ON</pre>
See Also	<p>SOURce[1..n]:WAVelength? SOURce[1..n]:WAVelength:LIST?</p>

:SOURce[1..n]:WAVelength?

Description	<p>This query returns the output wavelength of the currently selected source, in meters.</p> <p>At *RST, the wavelength that will be selected depends on the instrument you have.</p>
Syntax	<p>:SOURce[1..n]:WAVelength?[<wsp>MINimum MAXimum DEFault]</p>
Parameter(s)	<p><i>Parameter 1:</i></p> <p>The program data syntax for the first parameter is defined as a <CHARACTER PROGRAM DATA> element. The allowed <CHARACTER PROGRAM DATA> elements for this parameter are: MINimum MAXimum DEFault.</p> <p>MINimum is used to retrieve the instrument's lowest supported value. MAXimum is used to retrieve the instrument's highest supported value. DEFault is used to retrieve the instrument's default value.</p>
Response Syntax	<p><Wavelength></p>

:SOURce[1..n]:WAVelength?

Response(s)	<p><i>Wavelength:</i></p> <p>The response data syntax for <Wavelength> is defined as a <NR3 NUMERIC RESPONSE DATA> element.</p> <p>Current wavelength, in meters.</p>
Example(s)	<p>SOUR:WAV 1550.0E-9</p> <p>SOUR:WAV? Returns 1550.0E-9</p>
See Also	<p>SOURce[1..n]:WAVelength</p> <p>SOURce[1..n]:WAVelength:LIST?</p>

:SOURce[1..n]:WAVelength:LIST?

Description	This query returns the list of all available wavelengths. *RST does not affect this command.
Syntax	:SOURce[1..n]:WAVelength:LIST?
Parameter(s)	None
Response Syntax	<WavelengthList>
Response(s)	<i>WavelengthList</i> : The response data syntax for <WavelengthList> is defined as a <DEFINITE LENGTH ARBITRARY BLOCK RESPONSE DATA> element. Returns the list of all available wavelengths, in meters.
Example(s)	SOUR:WAV:LIST? Returns a wavelength list.
See Also	SOURce[1..n]:WAVelength

:TRACe[1..n][:DATA]?

Description	<p>This query returns all points of the trace corresponding to the specified trace index. The trace is the result of a complete acquisition cycle or a loaded file.</p> <p>*RST clears this setting.</p>
Syntax	:TRACe[1..n][:DATA]?<wsp>TRC1 TRC2 TRC3 TRC4
Parameter(s)	<p><i>Label:</i></p> <p>The program data syntax for the first parameter is defined as a <CHARACTER PROGRAM DATA> element. The allowed <CHARACTER PROGRAM DATA> elements for this parameter are: TRC1 TRC2 TRC3 TRC4.</p> <p>Trace index of the available wavelengths.</p>
Response Syntax	<Data>

:TRACe[1..n][:DATA]?

Response(s)

Data:

The response data syntax for <Data> is defined as a <DEFINITE LENGTH ARBITRARY BLOCK RESPONSE DATA> element.

Returns a list of power values representing the trace.

Each power value represents a point in the trace and is always returned in dB as a <NR3 NUMERIC RESPONSE DATA> type.

Example(s)

CONF:ACQ:MODE ACQ

INIT

INIT:STAT? Returns 0 when acquisition is complete.

TRAC? TRC1 Returns a trace

See Also

MMEMory[1..n]:LOAD:TRACe

TRACe[1..n]:POINts?

MMEMory[1..n]:LOAD:TRACe

:TRACe[1..n]:CATalog?

Description	This query returns all the available labels associated to a trace, at a given wavelength. *RST clears this setting.
Syntax	:TRACe[1..n]:CATalog?
Parameter(s)	None
Response Syntax	<Catalog>
Response(s)	<i>Catalog:</i> The response data syntax for <Catalog> is defined as a <DEFINITE LENGTH ARBITRARY BLOCK RESPONSE DATA> element. Returns a list of labels corresponding to the acquired or loaded wavelengths.
Example(s)	MMEM:LOAD:TRAC "Trace1.trc" (Where "Trace1.trc" is an existing file) TRAC:CAT? Returns "TRC1,TRC2,TRC3,TRC4" if 4 acquisitions at different wavelength values are in the loaded file.

SCPI Command Reference

Product-Specific Commands—Description

:TRACe[1..n]:POINTs?

Description	<p>This query returns the number of points of the trace corresponding to the specified trace index. The trace is the result of a complete acquisition cycle or a loaded file.</p> <p>*RST clears this setting.</p>
Syntax	<code>:TRACe[1..n]:POINTs?<wsp>TRC1 TRC2 TRC3 TRC4</code>
Parameter(s)	<p><i>Label:</i></p> <p>The program data syntax for the first parameter is defined as a <CHARACTER PROGRAM DATA> element. The allowed <CHARACTER PROGRAM DATA> elements for this parameter are: TRC1 TRC2 TRC3 TRC4.</p> <p>Trace index of the available wavelengths.</p>
Response Syntax	<code><PointsCount></code>

:TRACe[1..n]:POINts?

Response(s)	<p><i>PointsCount:</i></p> <p>The response data syntax for <PointsCount> is defined as a <NR1 NUMERIC RESPONSE DATA> element.</p> <p>Returns the number of points.</p>
Example(s)	<p>CONF:ACQ:MODE ACQ INIT INIT:STAT? Returns 0 when acquisition is complete. TRAC:POIN? TRC1 Returns the number of points.</p>
See Also	<p>MMEMory[1..n]:LOAD:TRACe TRACe[1..n][:DATA]? MMEMory[1..n]:LOAD:TRACe</p>

Index

- **** indication 200
- A**
- About button 287
- accuracy, trace 77
- acquiring traces
- Advanced mode..... 65, 75, 122
 - Auto mode 61
 - real time 94
 - Template mode..... 101
- acquisition
- automatic, in Advanced mode..... 65
 - Advanced mode..... 65
 - Auto mode 59
 - custom time values..... 122
 - date..... 215
 - duration..... 156, 250
 - interrupting 59, 66
 - setting analysis detection thresholds... 170
 - Template mode..... 95, 101
 - time, autorange 70
 - wavelength used 156
- acquisition time
- auto-time mode..... 75
 - real-time mode 94
- active trace selection 150
- Advanced mode
- acquiring traces 65
 - acquisition-specific fiber parameters ... 155
 - setting the autorange acquisition time.. 70
 - testing 65
- after-sales service 286
- analysis
- after acquisition..... 79, 98, 173
 - fiber span 175
 - thresholds, detection... 155, 157, 170, 251
 - thresholds, pass/fail 80
- analyzing a trace. see analysis, after acquisition
- analyzing traces..... 178
- application
- contacting EXFO support from 287
 - exiting 21
 - main window (first time used) 234
 - starting, single-module 18
- ASCII trace format 203
- Att. column in events table..... 135
- attenuation
- fiber-section threshold 80
 - LSA measurement method..... 198
 - measurement..... 198
 - reflectance 200
 - two-point measurement method 198
- Auto mode
- acquiring traces 61
 - selecting test wavelength 59, 65
 - setting fiber parameters..... 63
 - testing 59
- automatic acquisition time. see autorange acquisition time
- autonaming function..... 49
- autorange acquisition time..... 70
- average loss in Trace Info. tab 156, 250
- average splice loss in Trace Info. tab 250
- B**
- basic OTDR theory 6
- Bellcore. see Telcordia (Bellcore) trace format
- bidirectional analysis
- acquisition-specific fiber parameters... 249
 - automatic event insertion 248
 - events table, effect of event change 248
 - general description 233
 - installation 233
 - of fiber span 243
 - opening multiwavelength trace file 236

Index

- opening single-wavelength trace file ... 236
- percentage of events aligned..... 244
- printing traces 256
- purpose 233
- restrictions..... 233, 236
- starting..... 234
- bidirectional trace
 - discarding the original files..... 254
 - file content 254
 - saving 254
- Busy, module status 20
- buttons
 - trace editing, in events table 136
 - buttons, zoom. see controls, zoom

C

- cable
 - identification data 27
 - manufacturer information 44
 - parameters 26
- calibration
 - certificate..... 276
 - interval 276
- caution
 - of personal hazard..... 8
 - of product hazard..... 8
- certification information viii
- channel configuration, setting 90
- cleaning
 - EUI connectors..... 266
 - fiber ends 24
 - front panel 265
- clearing traces from the display 151
- clearing traces from the display (OTDR) 151
- code, color 36
- color code
 - adding a color name..... 42
 - creating 36
 - deleting 37
 - deleting a color name..... 43
 - exporting 38

- importing..... 40
- inserting a color name 42
- ITU default 34
- modifying a color name 43
- color identification data. see color code
- comments
 - about events, inserting 144
 - entering 46, 182
- connector loss, threshold 80
- connectors, cleaning 266
- contact information, EXFO 287
- controls, zoom 139
- conventions, safety..... 8
- Cumul. column in events table 135
- cumulative loss..... 135
- customer service..... 287, 291
- customizing report 217

D

- data points 77
- date of trace acquisition..... 215
- default tolerance in Bidir. Info. tab..... 250
- default trace name 49
- definition of the OTDR..... 1
- deleting events 166
- delimiting fiber span 144
- description of event types 295
- detecting module 14
- detection, reflective events 178
- dial
 - Distance 74
 - moving 76
 - Pulse 74
 - Time..... 74
- disappearing marker..... 191
- displaying
 - fiber sections 144
 - injection level in events table 145
 - merged events 144
 - pass/fail messages..... 116
 - traces 149

- distance
- between events 192
 - equation 6
 - range 74
- E**
- end-of-fiber
- detection threshold 155, 157, 170, 251
 - event 296
- entering comments 182
- equation of distance 6
- equipment returns 291
- error messages 282
- EUI
- baseplate 23
 - connector adapter 23
 - dust cap 23
- EUI connectors, cleaning 266
- event
- automatic insertion 248
 - comments, inserting 144
 - deleting 166
 - description of types 295
 - difference with fault 6
 - distance measurement 192
 - effect of setting as span start/end 85, 177, 243
 - fault notification 81
 - insertion 164
 - location 135, 136
 - loss. *see* event loss
 - marking fault in events table 81
 - name, displaying 134
 - non-reflective, averaged loss 157, 250
 - number 135
 - reflectance 135
 - threshold, pass/fail 80
 - thresholds, pass/fail message 81
 - tolerance interval (bidir. analysis) 249
 - unchangeable 160
 - undeletable 166
- event loss
- average, in Trace Info. tab 156, 250
 - in events table 135
 - in Trace Info. tab 250
 - measurement 193
 - total, in Trace Info. tab 156
- event types
- description 295
 - continuous fiber 297
 - echo 306
 - end of analysis 298
 - end-of-fiber 296
 - fiber section 303
 - launch level 302
 - merged reflective event 304
 - non-reflective event 299
 - positive event 301
 - reflective event 300
 - reflective event (possible echo) 307
 - short fiber 296
 - span end 296
 - span start 296
- events table
- changing 248
 - description 132
 - effect of changes on the Bidir. table 248
 - locating event 136
 - trace editing buttons 136
- EXFO support e-mail 287
- EXFO trace format 203
- EXFO universal interface. *see* EUI
- EXFO Web site 287
- exiting application 21
- F**
- failed events, flagging 81
- fault
- marking in events table 81
 - notification, for events 81
- fiber
- attenuation 135

Index

color identification 34
identification data 30
identifying by name 49, 212
identifying visually 229
sections display 144
type in Trace Info. tab 156
type information 45
see also fiber span 85
fiber ends, cleaning 24
fiber parameters, setting
 acquisition-specific (Advanced) 155
 acquisition-specific (Bidirectional) 249
fiber parameters, setting default values 71
fiber section attenuation threshold 80
fiber span
 analysis 175
 average loss in Trace Info. tab 156
 average splice loss in Trace Info. tab 250
 bidirectional analysis 243
 delimitation 144
 end location on bidir. trace 243
 length in Trace Info. tab 85, 156, 250
 setting 85
 span loss in Trace Info. tab 156, 250
 start location on bidir. trace 243
file. see trace
firmware version, module 287
first connector check 54
flagging failed events 81
forced selection of test wavelength 62, 69
four-point measurement method vs. LSA.. 193
Fresnel reflection 7
front panel, cleaning 265
FTB-300 trace format 203

G

General tab 142
grid display 142

H

Helix factor

 in Trace Info. tab 157, 251
 modification 155, 249
helix factor
 admissible values 72
 setting 71
help. see online user guide
hiding traces 149
high-resolution feature 77

I

identification label 286
identification, slot 20
identifying fiber under test 229
incrementation 30
initialization error messages 282
injection level, in events table 145
injection level, too low 54
inserting a module 11
IOR
 in Trace Info. tab 157, 251
 modification 155, 249
 obtaining 72
 setting 71
ITU default color code 34

L

label, identification 286
laser safety information 9, 10
laser, using OTDR as source 229
launch level 269
least-square approximation. see LSA
level of injection, warning 54
light source
 accessing 229
 operating 229
live changes on fiber link 94
Loc. in events table 135
locating events 136
location information 28
loss
 average for fiber span 156

- average splice 250
 - connector, threshold 80
 - cumulative for fiber span 156, 250
 - in events table 135
 - measurement 193
 - measurement, positioning markers 197
 - modification 160
 - non-reflective events average 157, 250
 - span threshold 80
 - splice, threshold 80
 - LSA measurement method
 - definition 198
 - vs. four-point 193
 - vs. two-point 198
- M**
- maintenance
 - EUI connectors 266
 - front panel 265
 - general information 265
 - manual trace modification 96
 - marker
 - disappearing on zoom 191
 - location calculation 161
 - too close to one another 191
 - measurement
 - attenuation (two-point and LSA) 198
 - event distance 192
 - event loss 193
 - event RBS level 192
 - ORL 201
 - units 118
 - merged events 144
 - Modify OTDR Setup 128
 - module
 - detection 14
 - insertion 11
 - removal 11
 - status 20
 - module information
 - firmware version number 287
 - module identification number 287
 - serial number 287
 - module position 20
 - mounting EUI connector adapter 23
 - multiwavelength trace file
 - bidirectional analysis 236
 - multiwavelength trace file, displaying 149
- N**
- naming
 - reference trace 100
 - trace automatically 49
 - native trace format 203
 - noise area, searching 178
 - non-reflective event, averaged loss 157, 250
 - number
 - in events table 135
 - of the event 135
- O**
- offline vs online 98
 - online user guide 285
 - online vs offline 98
 - opening
 - a single-wavelength trace file 236
 - multiwavelength trace file 236
 - reference trace file 187
 - opening trace file 183
 - operating light source 229
 - optical return loss. see ORL
 - optical switch
 - setting parameters 90
 - test results table 92, 138
 - ORL threshold 80
 - ORL, module required for calculations 201
 - OTDR
 - basic theory 6
 - configuration 127
 - definition 1
 - internal components 7
 - setup 127

Index

- using as laser source..... 229
- OTDR software
 - error messages 282
 - file compatibility between versions..... 208
 - launch level..... 269

P

- parameters
 - Advanced mode..... 70
 - cable..... 26
 - helix factor..... 71
 - IOR 71
 - Rayleigh backscatter coefficient..... 71
 - Template mode 96
 - trace display 142
- pass/fail test
 - disabling..... 81
 - enabling 81
 - message 116, 174
 - when to perform 81
- PDF. see online user guide
- photodetector 6
- ports, order of..... 90
- position, module..... 20
- precision, trace..... 77
- printing traces..... 256
- processing traces..... 98
- product
 - identification label..... 286
 - specifications..... 293
- pulse
 - setting width 74
 - width unit..... 147
- pulse/time in Trace Info. tab..... 156, 250

R

- RBS (Rayleigh backscatter)
 - description..... 7
 - in Trace Info. tab 157, 251
 - modification 155, 249
 - obtaining..... 72

- setting 71
- RBS level measurement event..... 192
- Ready, module status 20
- real-time mode..... 94
- re-analyzing a trace 173
- recalibration 276
- recalling files or traces. see reloading
- reference trace
 - naming 100
 - opening file..... 187
 - parameters..... 96
- Refl. column in events table 135
- reflectance
 - attenuation 200
 - detection threshold..... 155, 157, 170, 251
 - modification 160
 - of event 135
 - of non-reflective events 200
 - source of inaccurate measurements..... 73
 - threshold 80
- reflective ends of fiber..... 178
- reflective events, detecting..... 178
- removing a module 11
- report
 - creation 256
 - customizing 217
 - layout..... 218
 - of trace 212
 - printing..... 226
 - window..... 215
- resetting fiber parameters, Auto mode 63
- restrictions Ref. Creation/Template mode 96
- restrictions, bidirectional analysis utility ... 233, 236
- return merchandise authorization (RMA) .. 291

S

- safety
 - caution 8
 - conventions 8
 - warning 8

- same pulse and time for all wavelengths 75
- saving
- bidirectional traces 254
 - changing default trace name..... 49
 - format, ASCII 203
 - format, EXFO 203
 - format, FTB-300..... 203
 - format, native..... 203
 - format, Telcordia (Bellcore)..... 203
 - trace autonaming 49
 - traces..... 247
- saving traces in different formats..... 203
- selecting
- active trace 150
 - Automatic OTDR test wavelength 59, 65
 - OTDR setup..... 127
 - test wavelength, automatically..... 62, 69
 - wavelength in Auto mode 59, 65
- serial number, module 287
- service and repairs..... 291
- service centers 292
- setting
- channel configuration 90
 - event tolerance interval 249
 - fiber span 85, 243
 - pass/fail thresholds 80
 - report layout..... 218
 - window height 19
- setup, actual and saved..... 127
- shipping to EXFO 291
- signal-to-noise ratio 75
- single-wavelength trace file, bidir. analysis 236
- slot number..... 20
- software. see application
- source see *also* laser
- source, function overview 229
- span
- length threshold 80
 - loss threshold 80
- span end
- changing, bidirectional analysis..... 243
 - description..... 296
 - effect of setting on events table ... 85, 177, 243
 - setting in memory..... 87
- span position, updating 175
- span start
- changing, bidirectional analysis 243
 - description 296
 - effect of setting on events table ... 85, 177, 243
 - setting in memory..... 87
- specifications, product 293
- splice loss
- average, in Trace Info. tab 157, 250
 - detection threshold..... 155, 157, 170, 251
 - threshold 80
- split bar 19
- status bar 20
- stopping trace acquisition 59, 66
- storage requirements 265
- storing files or traces.see saving
- subset identification data 30
- switch configuration..... 90
- symbols, safety..... 8

T

- technical specifications..... 293
- technical support..... 286, 287
- Telcordia (Bellcore) trace format200, 203, 212, 216
- temperature for storage 265
- Template mode
- acquiring the reference trace 99
 - acquiring traces 101
 - applying parameters to other traces..... 96
 - comments 96
 - completing the report..... 96
 - description 95
 - entering comments..... 96
 - manual trace modification 96
 - modifying acquisition parameters..... 101
 - modifying fiber parameters 101

Index

- naming the reference trace..... 100
- reference trace naming..... 100
- report 96
- restrictions..... 96
- setting parameters..... 96
- template trace appearance..... 104
- testing 95
- working with traces..... 98
- template trace appearance..... 104
- test wavelength, forced selection..... 62, 69
- testing
 - Advanced mode..... 65
 - Auto mode 59
 - Template mode 95
- theory, OTDR..... 6
- thresholds
 - analysis detection 155, 170
 - connector loss 80
 - detection 251
 - end-of-fiber detection 155, 170, 249
 - fault notification..... 81
 - fiber-section attenuation 80
 - ORL..... 80
 - pass, fail, warning 116
 - pass/fail message..... 81
 - reflectance 80
 - reflectance detection ... 155, 157, 170, 251
 - setting pass/fail..... 80
 - span length 80
 - span loss..... 80
 - splice loss 80
 - splice loss detection..... 155, 157, 170, 251
 - trace analysis 80
- Time dial
 - auto-time mode..... 75
 - custom-time mode 122
- time in Trace Info. tab..... 156, 250
- time mode
 - auto..... 75
 - real time 94
- time, custom values 122
- timer 21
- title bar..... 20
- tolerance
 - in Bidir. Info. tab..... 250
 - setting interval for events 249
- total loss in Trace Info. tab 156
- trace
 - accuracy..... 77
 - acquisition in Advanced mode..... 65
 - acquisition in Auto mode..... 61
 - acquisition in Template mode..... 101
 - analysis 173
 - analysis detection thresholds155, 170, 249
 - autonaming 49
 - changing default name..... 49
 - compatibility between ToolBox versions208
 - editing buttons 136
 - export formats 203
 - opening file..... 183
 - pass/fail analysis threshold..... 80
 - processing..... 98
 - re-analyzing 173
 - stopping the acquisition 59, 66
 - storage, in different formats 203
- trace display
 - behavior on zoom..... 139
 - clearing traces..... 151
 - description..... 132
 - mode, complete trace 148
 - mode, markers..... 148
 - mode, optimum..... 148
 - parameters..... 142
- trace formats
 - ASCII 203
 - FTB-300..... 203
 - native..... 203
 - Telcordia 200, 203, 212, 216
- Trace Info. tab
 - average loss 156
 - average splice loss 250
 - Backscatter..... 157, 251
 - default tolerance (Bidir. Info.) 250
 - displaying traces 149

end-of-fiber threshold	157, 251
fiber type used.....	156
Helix factor	157, 251
hiding traces.....	149
IOR.....	157, 251
length.....	156, 250
reflectance threshold	157, 251
splice loss threshold.....	157, 251
time.....	156, 250
tolerance (Bidir. Info.).....	250
total loss.....	156
total/average loss.....	250
wavelength.....	156
trace name, changing default	49
trace report	
creating	212
printing	226
storage location.....	215
transportation requirements	265, 288
two-point	
attenuation.....	198
measurement method vs. LSA	198
measurement method, definition	198
type	
in events table	135
of event	135

U

unchangeable events	160
undeletable events	166
unit recalibration.....	276
UPC connectors, detecting	178
updating span position	175
user guide. see online user guide	
using light source.....	229

V

VFL	
continuous wave output.....	232
using.....	229
viewing changes on fiber link.....	94

visual fault locator. see VFL

W

warning thresholds.....	116
warranty	
certification.....	290
exclusions	290
general.....	289
liability.....	290
null and void.....	289
wavelength	
indication in Trace Info. tab	156
selecting, in Auto mode	59, 65
window height, setting	19
working with traces.....	98

Z

zoom	
controls.....	139
window display.....	142

NOTICE

通告

CHINESE REGULATION ON RESTRICTION OF HAZARDOUS SUBSTANCES

中国关于有害物质限制的规定

NAMES AND CONTENTS OF THE TOXIC OR HAZARDOUS SUBSTANCES OR ELEMENTS CONTAINED IN THIS EXFO PRODUCT



包含在本 EXFO 产品中的有毒有害物质或元素的名称和含量

O	Indicates that this toxic or hazardous substance contained in all of the homogeneous materials for this part is below the limit requirement in SJ/T11363-2006 表示该有毒有害物质在该部件所有均质材料中的含量均在 SJ/T11363-2006 标准规定的限量要求以下。
X	Indicates that this toxic or hazardous substance contained in at least one of the homogeneous materials used for this part is above the limit requirement in SJ/T11363-2006 表示该有毒有害物质至少在该部件的某一均质材料中的含量超出 SJ/T11363-2006 标准规定的限量要求。

Part Name 部件名称	Toxic or hazardous Substances and Elements 有毒有害物质和元素					
	Lead 铅 (Pb)	Mercury 汞 (Hg)	Cadmium 镉 (Cd)	Hexavalent Chromium 六价铬 (Cr VI)	Polybrominated biphenyls 多溴联苯 (PBB)	Polybrominated diphenyl ethers 多溴二苯醚 (PBDE)
Enclosure 外壳	O	O	O	O	O	O
Electronic and electrical sub-assembly 电子和电子组件	X	O	X	O	X	X
Optical sub-assembly ^a 光学组件 ^a	X	O	O	O	O	O
Mechanical sub-assembly ^a 机械组件 ^a	O	O	O	O	O	O

- a. If applicable.
聞種矽杉羽塞粒粒。

MARKING REQUIREMENTS
标注要求

Product 产品	Environmental protection use period (years) 环境保护使用期限 (年)	Logo 标志
This Exfo product 本 EXFO 产品	10	
Battery ^a 电池 ^a	5	

- a. If applicable.
閻種殆衫翎塞粒。

P/N: 1054935

www.EXFO.com · info@exfo.com

CORPORATE HEADQUARTERS	400 Godin Avenue	Quebec (Quebec) G1M 2K2 CANADA Tel.: 1 418 683-0211 · Fax: 1 418 683-2170
EXFO AMERICA	3701 Plano Parkway, Suite 160	Plano TX, 75075 USA Tel.: 1 972 907-1505 · Fax: 1 972 836-0164
EXFO EUROPE	Omega Enterprise Park, Electron Way	Chandlers Ford, Hampshire S053 4SE ENGLAND Tel.: +44 2380 246810 · Fax: +44 2380 246801
EXFO ASIA-PACIFIC	151 Chin Swee Road #03-29, Manhattan House	SINGAPORE 169876 Tel.: +65 6333 8241 · Fax: +65 6333 8242
EXFO CHINA	No. 88 Fuhua First Road, Central Tower, Room 801, Futian District Beijing New Century Hotel Office Tower, Room 1754-1755, No. 6 Southern Capital Gym Road	Shenzhen 518048 P. R. CHINA Tel.: +86 (755) 8203 2300 · Fax: +86 (755) 8203 2306 Beijing 100044 P. R. CHINA Tel.: +86 (10) 6849 2738 · Fax: +86 (10) 6849 2662