IQS-600

Integrated Qualification System



Copyright © 2008–2015 EXFO Inc. All rights reserved. No part of this publication may be reproduced, stored in a retrieval system or transmitted in any form, be it electronically, mechanically, or by any other means such as photocopying, recording or otherwise, without the prior written permission of EXFO Inc. (EXFO).

Information provided by EXFO is believed to be accurate and reliable. However, no responsibility is assumed by EXFO for its use nor for any infringements of patents or other rights of third parties that may result from its use. No license is granted by implication or otherwise under any patent rights of EXFO.

EXFO's Commerce And Government Entities (CAGE) code under the North Atlantic Treaty Organization (NATO) is 0L8C3.

The information contained in this publication is subject to change without notice.

Trademarks

EXFO's trademarks have been identified as such. However, the presence or absence of such identification does not affect the legal status of any trademark.

Units of Measurement

Units of measurement in this publication conform to SI standards and practices.

Version number: 5.0.3.1

Contents

Certification Information	vii
1 Introducing the IQS-600 Integrated Qualification System	1
Main Features	1
Available Models	3
Understanding the LEDs	8
Understanding the Hardware Buttons and Selection Dial (IQS-605P-HS)	10
Locating Integrated Qualification System Synchronization Ports	11
Dual Hard Disk Drive	12
Conventions	13
2 Safety Information	15
Laser Safety Information	15
Electrical Safety Information	16
Other Safety Symbols on Your Unit	19
3 Getting Started with Your Integrated Qualification System	21
Installing Your Controller and Expansion Units in a Rackmount	22
Connecting One or More Expansion Units to a Controller Unit	26
Inserting and Removing Test Modules	30
Safeguarding Units with the Interlock	36
Turning the Integrated Qualification System On and Off	38
Configuring Your Unit At First Startup	39
Working with Windows 8.1 Pro	41
Using the On-Screen (Virtual) Keyboards	43
Installing or Upgrading the Applications	46
Activating Software Options	49
Protecting your Unit with an Antivirus Software	53
Accessing IQS Manager	54
Exiting IQS Manager	55
Installing EXFO LabVIEW Drivers	56
Connecting an External Monitor	59
Connecting an External Keyboard	61
Connecting a Mouse	62
Connecting a Tape, CD, or DVD Player	63
Connecting a Headset or a Speaker	64
Connecting a Microphone	65
Connecting a Printer	66

4	Setting Up Your Integrated Qualification System	67
	Calibrating Your Touchscreen (IQS-605P-HS)	67
	Adjusting Microphone and Speaker Volume	68
	Changing the Backlight Level (IQS-605P-HS)	69
	Deactivating the LED Display	70
	Selecting the Language of Operation	71
	Setting Date and Time Formats	81
	Adjusting the Date, Time and Time Zone	83
	Selecting the Startup Interface	84
	Customizing Access Levels	85
	Setting Up Auto Logon for Windows	87
	Setting Communication Parameters	89
	Adjusting the Fan Speed	90
	Saving and Opening Configurations	92
	Saving the Configuration on Exiting	94
	Changing Unit and Module Identification	95
	Reverting to Factory Settings	97
5	Using the IQS Manager Interface	99
	Accessing Current Modules	99
	Accessing Integrated Applications	102
	Working on Test Results (Offline Mode)	103
	Creating an Integrated Data Display	104
	Viewing PDF Files	106
	Locating Units	107
	Accessing Utilities from IQS Manager	108
	Accessing Utilities from Windows	108
6	Accessing your IQS-600 Remotely	109
	Working with Remote Desktop	110
	Allowing User with Limited Accounts to Use Remote Desktop	112
	Working with TightVNC	118
7	Preparing for Automation	125
	Configuring Your Integrated Qualification System for Working with GPIB	129
	Preparing Hardware for GPIB Control	136
	Linking Units with the GPIB Port	138
	Linking Units with the Ethernet Port	138
	Linking Units with the Serial Port	139
	Getting Optimum Performance from Your Integrated Qualification System	139
	Changing Communication Settings	142
	Configuring DCOM Access to Your Unit	147
	Preparing to Control Modules with a Dedicated Application	171

8 Using IQS Products in an Automated Test Environment	175
Managing the States of Your IQS-600 Integrated Qualification System	176
Message Management	180
Standard Status Data Structure	183
SCPI Command Structure	187
Consulting Data Types	192
Writing Remote Control Code	192
Error Message Format	194
Working with EXFO LabVIEW Drivers	195
Using the EXFO Getting Started Applications	197
Building and Using Custom VIs	202
Monitoring Remote Commands	209
9 Maintenance	213
Cleaning the Touchscreen (IQS-605P-HS)	213
Replacing the Fuse	214
Managing Windows Updates	214
Recycling and Disposal (Applies to European Union Only)	216
10 Troubleshooting	217
Solving Common Problems	217
Restoring Your Controller Unit to Normal Operation	220
Viewing Online Documentation	237
Contacting the Technical Support Group	238
Viewing System Information	239
Transportation	243
11 Warranty	245
General Information	245
Liability	245
Exclusions	246
Certification	246
Service and Repairs	247
EXFO Service Centers Worldwide	248
A Technical Specifications	249
B SCPI-Based Errors	251
C Data Types	267
Applicable Data Types for Input—IEEE 488.2	268
Applicable Data Types for Output —IEEE 488.2	277
Applicable Data Types for Input—SCPI	287
Special Numeric Values Received on Output	288

D IEEE 488.2 and Specific Commands	289
IEEE 488.2 Commands—Quick Reference	289
IEEE 488.2 Required Commands	290
Specific Commands—Quick Reference	310
Specific Commands	311
E COM Properties and Events	329
ActiveX (COM/DCOM)—Quick Reference	330
Properties	331
Events	338
F Communicating Through TCP/IP over Telnet	339
Introducing TCP/IP over Telnet	339
Features	340
Activating TCP/IP over Telnet	341
Executing SCPI Commands Over Telnet	342
Releasing Modules	348
Internal Commands of the TCP/IP over Telnet Protocol	349
G Using the IQS-9600 Utility Module	357
Index	361

Certification Information

North America Regulatory Statement

This unit was certified by an agency approved in both Canada and the United States of America. It has been evaluated according to applicable North American approved standards for product safety for use in Canada and the United States.

Electronic test and measurement equipment is exempt from FCC part 15, subpart B compliance in the United States of America and from ICES-003 compliance in Canada. However, EXFO Inc. makes reasonable efforts to ensure compliance to the applicable standards.

The limits set by these standards are designed to provide reasonable protection against harmful interference when the equipment is operated in a commercial environment. This equipment generates, uses, and can radiate radio frequency energy and, if not installed and used in accordance with the user guide, may cause harmful interference to radio communications. Operation of this equipment in a residential area is likely to cause harmful interference in which case the user will be required to correct the interference at his own expense.

Modifications not expressly approved by the manufacturer could void the user's authority to operate the equipment.



IMPORTANT

Use of shielded remote I/O cables, with properly grounded shields and metal connectors, is recommended in order to reduce radio frequency interference that may emanate from these cables.

European Community Declaration of Conformity

An electronic version of the declaration of conformity for your product is available on our website at www.exfo.com. Refer to the product's page on the Web site for details.

1 Introducing the IQS-600 Integrated Qualification System

Main Features

The IQS-600 Integrated Qualification System is a platform designed for scientific and industrial applications. It is composed of one IQS-605P-HS or IQS-610P-HS controller unit and up to nine optional IQS-610E-HS expansion units.



IMPORTANT

- The high-speed units bear the “HS” inscription on their front panels, while the standard IQS-600 units do not.
- You can link both high-speed and standard units that you may already have. However, to benefit from the high-speed feature, you must chain the units in a specific order: all the high-speed units first, followed by all the standard units.
- When several high-speed units are linked, the high-speed capability is available for the *first three high-speed units only*.
- High-speed modules only work with high-speed units. For this reason, ensure that you insert such modules into *one of the first three high-speed units*. Otherwise, you will not be able to work with the modules.
There is no risk of damaging your high-speed modules by inserting them into a standard unit.
High-speed modules are identified as such in their user documentation.
- Most of the standard modules will work either in high-speed or standard units.
- Use only accessories designed for your unit and approved by EXFO. For a complete list of accessories available for your unit, see the technical specification sheet.

Introducing the IQS-600 Integrated Qualification System

Main Features

Both controller and expansion units are designed to work with IQS modules, including the utility module (for which you will find more information in *Using the IQS-9600 Utility Module* on page 357). The controller and expansion units also allow you to work with most IQ modules if you have previously purchased any. For a complete list of supported modules, go to the EXFO Web site.

The IQS-600 Integrated Qualification System runs under Microsoft Windows 8.1 Pro with the IQS Manager software. Your controller unit features several possibilities, such as trigger and remote control ports, interlock terminals, as well as standard computer ports.

The IQS-600 Integrated Qualification System supports local control (via the IQS Manager software) and remote control (through GPIB, RS-232 or Ethernet TCP/IP—using SCPI commands or the provided LabVIEW drivers).

Available Models

Below are diagrams to locate the components on your controller and expansion units.

IQS-605P-HS Controller Unit

The front of the IQS-605P-HS controller unit is where you perform basic operations such as turning your unit on or off, consulting LED indicators, and using data-related peripherals (for example: the USB ports).

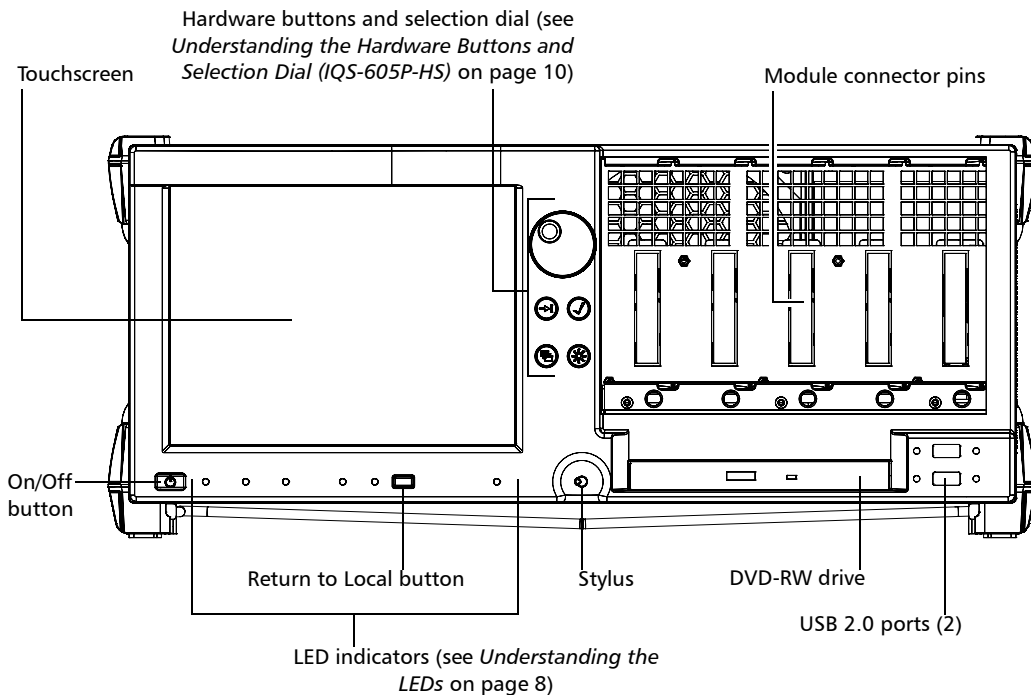

Introducing the IQS-600 Integrated Qualification System

Available Models

The back of the IQS-605P-HS controller unit is where you find the peripheral connectors, as well as the power outlets and connectors to link expansion units to your controller unit.

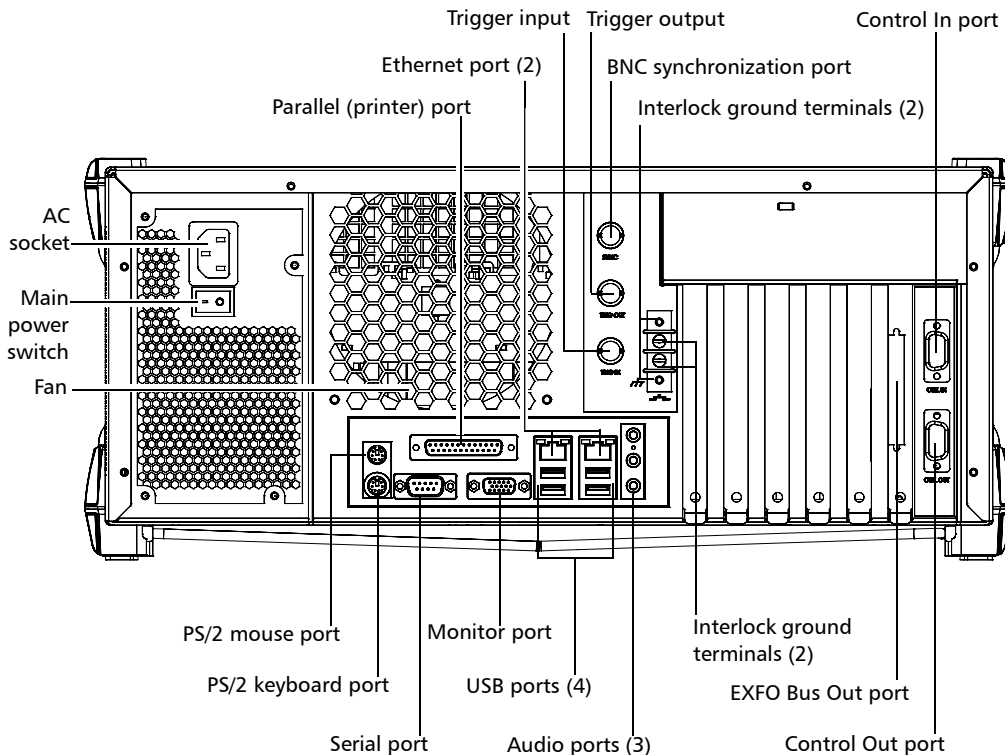

IQS-610P-HS Controller Unit

The front of the IQS-610P-HS controller unit is where you perform basic operations such as turning your unit on or off, consulting LED indicators and using data-related peripherals (for example: the USB ports and the DVD-RW drive).

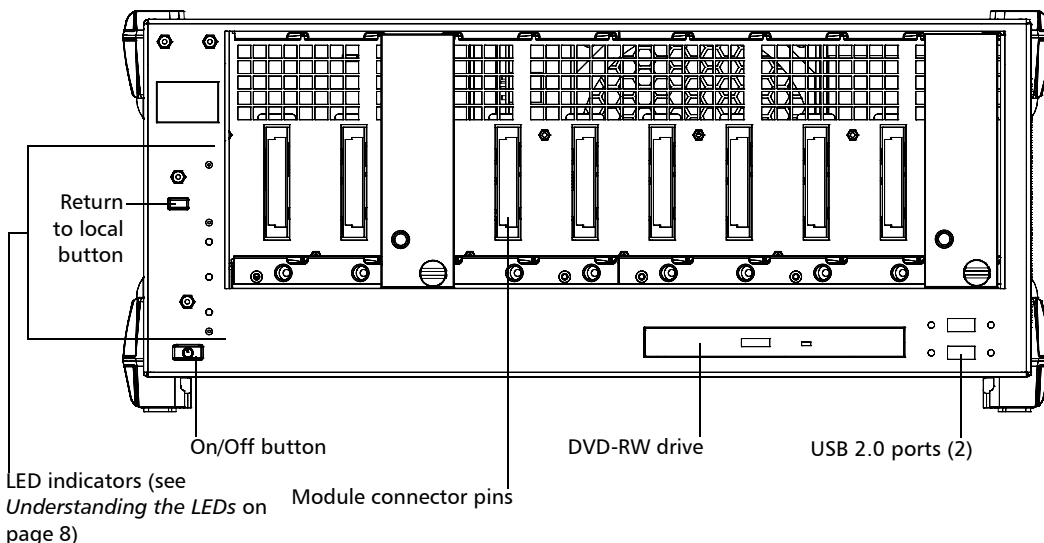

Introducing the IQS-600 Integrated Qualification System

Available Models

The back of the IQS-610P-HS controller unit is where you find the peripheral connectors, as well as the power outlets and connectors to link expansion units to your controller unit.

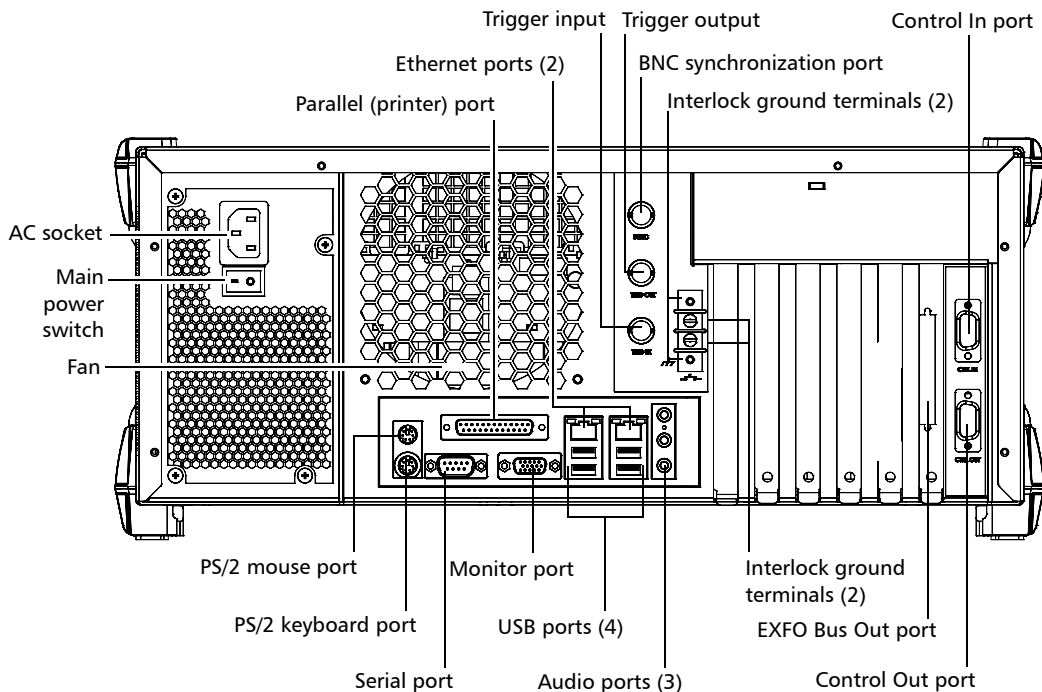

IQS-610E-HS Expansion Unit

The front of the IQS-610E-HS expansion unit is where you perform basic operations such as turning your unit on or off and consulting LED indicators.

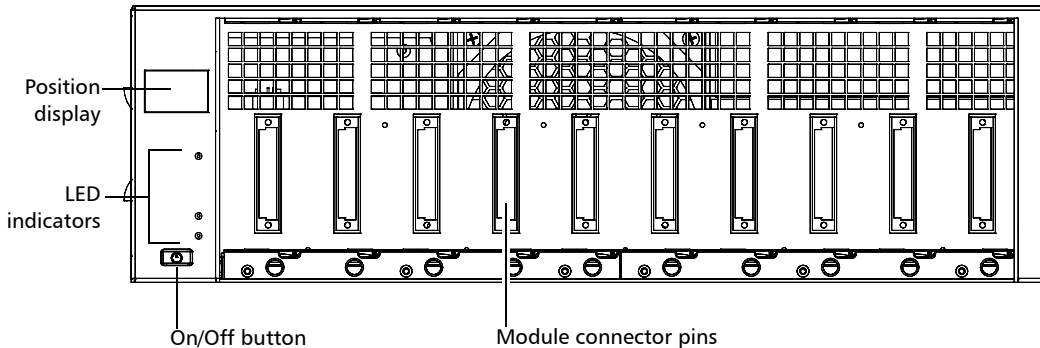

The back of the IQS-610E-HS expansion unit is where you find the power outlets and connectors to link your expansion units to your controller unit.

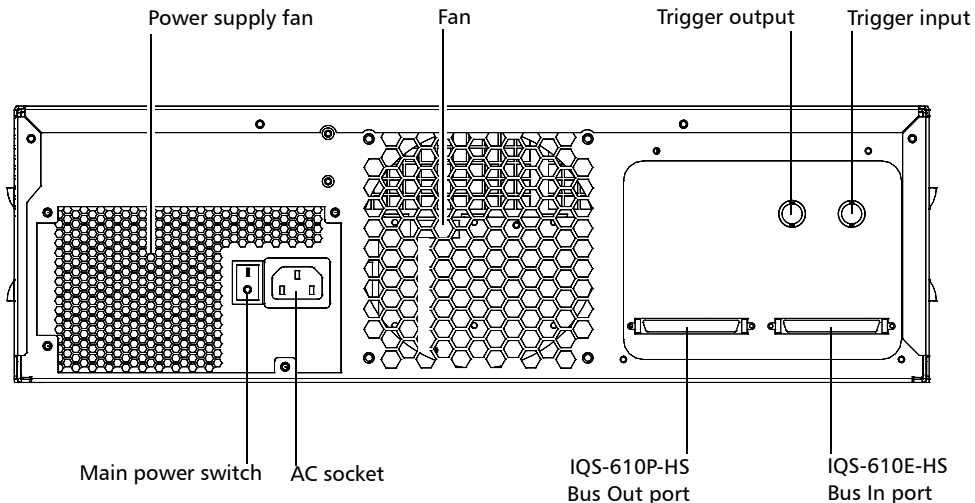

Introducing the IQS-600 Integrated Qualification System

Understanding the LEDs

Understanding the LEDs

The LEDs on your Integrated Qualification System help you determine the current status of your unit.

IQS-605P-HS

Alarm indicator LED

When lit on the controller unit, it indicates a problem.

When lit on an expansion unit, the latter is not linked to the controller directly or through a chain.

Lock LED

When lit, the unit is in Lockout mode; you can only disable this mode by sending the corresponding remote command.

Interlock LED

When lit, it indicates that the Interlock is open (no current is passing through) and that the lasers in your unit are deactivated.

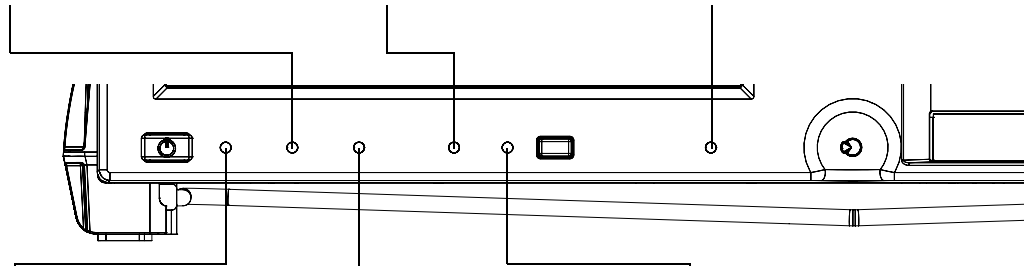

On/Off LED

When lit, it indicates that the unit is currently on.

Hard drive activity LED

When blinking, it indicates current hard drive activity.

Remote LED

When lit, the unit is in Remote mode and the local peripherals such as the keyboard, selection dial and mouse are disabled.

IQS-610P-HS

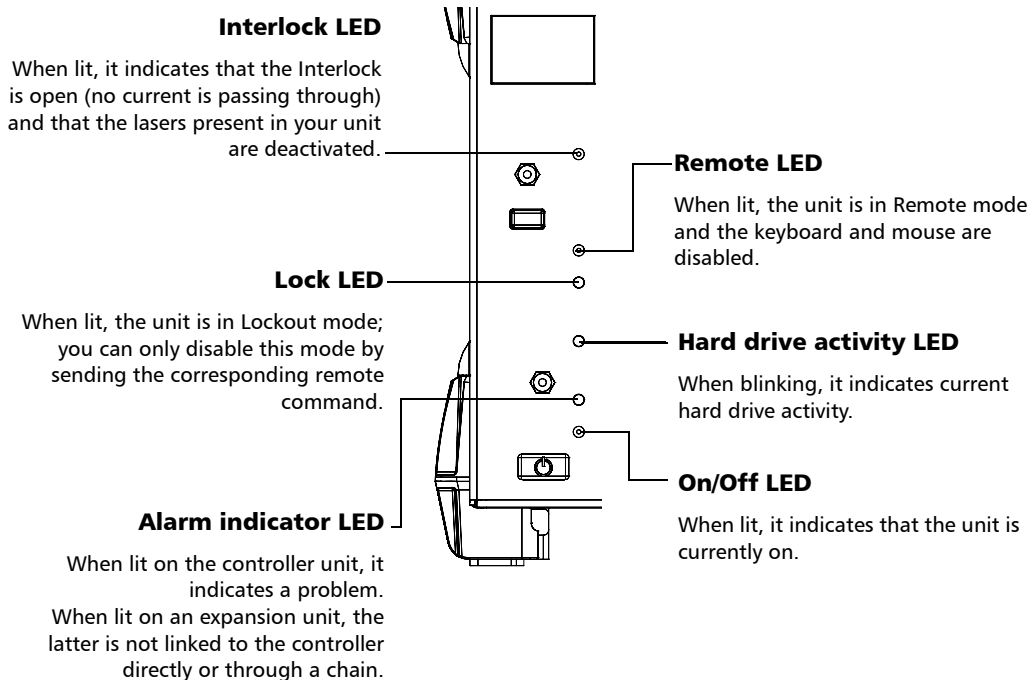

Introducing the IQS-600 Integrated Qualification System

Understanding the Hardware Buttons and Selection Dial (IQS-605P-HS)

Understanding the Hardware Buttons and Selection Dial (IQS-605P-HS)

The hardware buttons and selection dial on your Integrated Qualification System allow you to perform various tasks.

Selection Dial

Turn it to scroll up or down in lists, or to move slider.
Push it to select the item you have highlighted in the list.

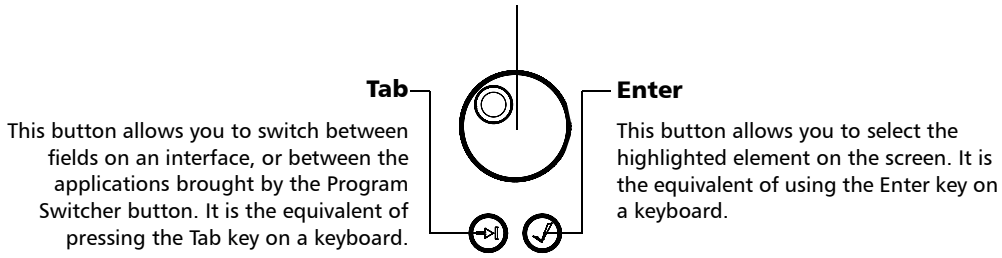

Program Switcher

This button allows you to show the taskbar, from which you can switch among running applications, select a keyboard, view the time and date, etc.



Backlight

This button allows you to set the display brightness level.

Locating Integrated Qualification System Synchronization Ports

The synchronization and trigger ports are not currently supported by the IQS-600 Integrated Qualification System. The ports located at the back of the unit are reserved for future use only.

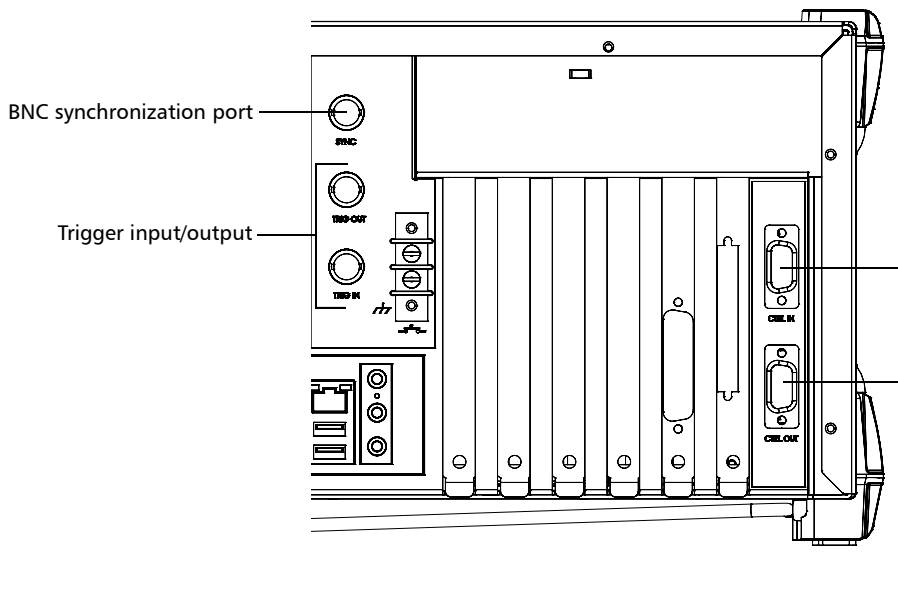

Control In/Out ports

Used to connect specific EXFO units together.
Reserved for EXFO.

Dual Hard Disk Drive

The optional RAID 1 dual hard disk drive performs real-time mirroring of all data. A safety against hard drive failure, the RAID 1 hard disk drive configuration provides a live backup of all test data.

RAID 1 dual hard disk drives are installed at the factory. They cannot be installed in the field. To retrofit your IQS-600 with this option, return your unit to EXFO.

Windows will notify you of any malfunction with your RAID 1 hard drive. Should this happen, your data is no longer protected from a single hard drive failure. Contact EXFO's Technical Support.

Conventions

Before using the product described in this guide, you should understand the following conventions:



WARNING

Indicates a potentially hazardous situation which, if not avoided, could result in *death or serious injury*. Do not proceed unless you understand and meet the required conditions.



CAUTION

Indicates a potentially hazardous situation which, if not avoided, may result in *minor or moderate injury*. Do not proceed unless you understand and meet the required conditions.



CAUTION

Indicates a potentially hazardous situation which, if not avoided, may result in *component damage*. Do not proceed unless you understand and meet the required conditions.



IMPORTANT

Refers to information about this product you should not overlook.

2 **Safety Information**



WARNING

Do not install or terminate fibers while a light source is active. Never look directly into a live fiber and ensure that your eyes are protected at all times.



WARNING

The use of controls, adjustments and procedures, namely for operation and maintenance, other than those specified herein may result in hazardous radiation exposure or impair the protection provided by this unit.



IMPORTANT

When you see the following symbol on your unit , make sure that you refer to the instructions provided in your user documentation. Ensure that you understand and meet the required conditions before using your product.



IMPORTANT

Other safety instructions relevant for your product are located throughout this documentation, depending on the action to perform. Make sure to read them carefully when they apply to your situation.

Laser Safety Information

Your IQS-600 Integrated Qualification System does not include laser components in itself. However, your modules may do so. Refer to your modules' user guides for information on their respective laser classes, and further laser safety details and instructions.

Safety Information

Electrical Safety Information

Electrical Safety Information

This unit uses an international safety standard three-wire power cable. This cable serves as a ground when connected to an appropriate AC power outlet.

Note: *If you need to ensure that the unit is completely turned off, disconnect the power cable.*



WARNING

- Insert the power cable plug into a power outlet with a protective ground contact. Do not use an extension cord without a protective conductor.
- Before turning on the unit, connect all grounding terminals and extension cords to a protective ground via a ground socket. Any interruption of the protective grounding is a potential shock hazard and may cause personal injury. Whenever the ground protection is impaired, do not use the unit and secure it against any accidental operation.
- Do not tamper with the protective ground terminal.
- Use only the certified power cord that is suitably rated for the country where the unit is sold.
- Replacing detachable MAINS supply cords by inadequately RATED cords may result of overheating of the cord and create a risk of fire.

The color coding used in the electric cable depends on the cable. New plugs should meet the local safety requirements and include:

- adequate load-carrying capacity
- ground connection
- cable clamp



WARNING

- Use this unit indoors only.
- Position the unit so that the air can circulate freely around it.
- Do not remove unit covers during operation.
- Operation of any electrical instrument around flammable gases or fumes constitutes a major safety hazard.
- To avoid electrical shock, do not operate the unit if any part of the outer surface (covers, panels, etc.) is damaged.
- Only authorized personnel should carry out adjustments, maintenance or repair of opened units under voltage. A person qualified in first aid must also be present. Do not replace any components while the power cable is connected.
- Capacitors inside the unit may be charged even if the unit has been disconnected from its electrical supply.

Safety Information

Electrical Safety Information

Equipment Ratings	
Temperature	
➤ Operation	➤ 0 °C to 40 °C (32 °F to 104 °F)
➤ Storage	➤ -40 °C to 70 °C (-40 °F to 158 °F)
Relative humidity ^a	0 % to 80 % non-condensing
Maximum operation altitude	2000 m (6562 ft)
Pollution degree	2
Overvoltage category	II
Measurement category	Not rated for measurement categories II, III, or IV
Input power ^b	unit: ~ 100 - 240 V; 50/60 Hz; 550 VA

- a. Measured in 0 °C to 31 °C (32 °F to 87.8 °F) range, decreasing linearly to 50 % at 40 °C (104 °F).
b. Not exceeding ± 10 % of the nominal voltage.



CAUTION

The use of voltages higher than those indicated on the label affixed to your unit may damage the unit.











IMPORTANT

The operation and storage temperatures of some modules may differ from the temperatures specified for your platform. In this case, always ensure that you comply with the most restrictive conditions (either module or platform).

Other Safety Symbols on Your Unit

One or more of the following symbols may also appear on your unit.

Symbol	Meaning
	Direct current
	Alternating current
	The unit is equipped with an earth (ground) terminal.
	The unit is equipped with a protective conductor terminal.
	The unit is equipped with a frame or chassis terminal.
	On (Power)
	Off (Power)
	On/Off (Power)
	Fuse

3 Getting Started with Your Integrated Qualification System

You can either use your IQS-600 Integrated Qualification System as a benchtop unit, or you can install your units in a rackmount.



CAUTION

If you are using your Integrated Qualification System as a benchtop unit, do not turn it on its side. The platforms and modules were not designed to function in this position and, therefore, would either be damaged or provide inaccurate measurements.

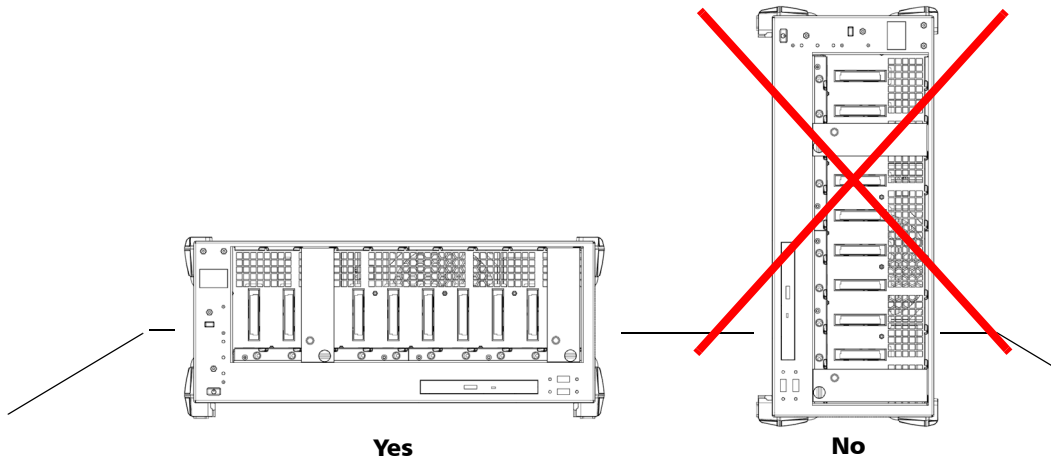

You can adjust the angle of your IQS-605P-HS controller unit in order to have a better view of the screen. Use the stand located under the front part of the unit and pull it down and forward.

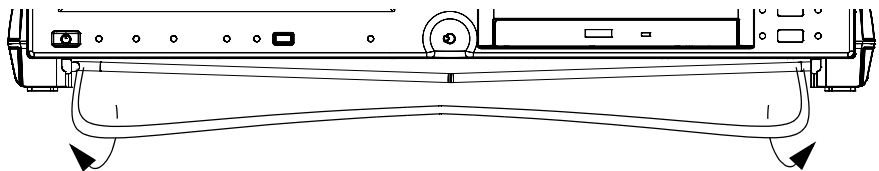

Installing Your Controller and Expansion Units in a Rackmount

Your controller and expansion units were designed to be installed in 19-inch rackmounts only. They will not fit into 23-inch racks.

Each unit has a side fan and a rear cooling fan. Mount or position your units so that air can circulate freely around them. When operating the units, select a location that provides at least:

- 75 mm (3 in.) of rear clearance
- 25 mm (1 in.) of side clearance (left and right)



CAUTION

Failure to provide adequate cooling clearance may result in an excessive internal temperature, thus reducing the reliability of your units.

Note: *There is no need to leave an empty slot between units when you stack them one on top of the other inside a rackmount.*

Install your controller and expansion units into a rackmount kit before inserting them into a rack.



IMPORTANT

- High-speed units bear the “HS” inscription on their front panels, while the standard units do not.
- You can link both high-speed and standard units. However, to benefit from the high-speed feature, you must chain the units in a specific order: all the high-speed units first, followed by all the standard units.

Getting Started with Your Integrated Qualification System

Installing Your Controller and Expansion Units in a Rackmount

To prepare your unit for rackmount use:

1. Ensure that your unit is turned off.
2. Remove the bumpers of your controller unit by unscrewing the top and bottom screws.



CAUTION

You should remove all your modules before installing your unit into a rackmount. Otherwise, they could be damaged or their calibration could be affected.

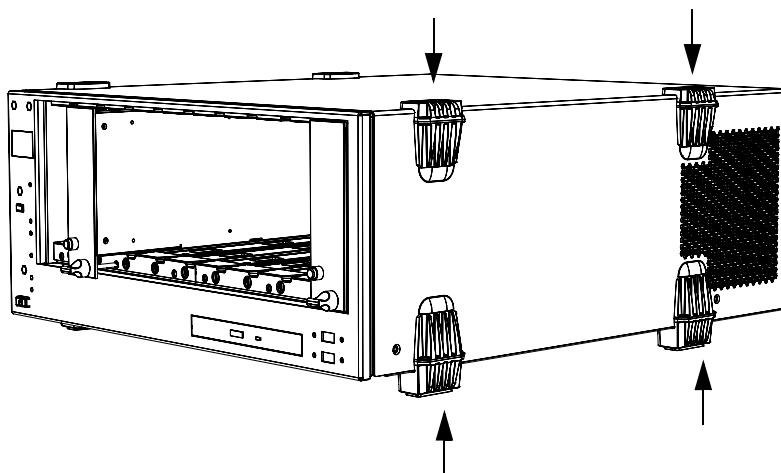

Getting Started with Your Integrated Qualification System

Installing Your Controller and Expansion Units in a Rackmount

3. Assemble the rackmount kit panels using the supplied screws.

The screws used for the bumpers will not work to secure the rackmount kit panels. You must use the screws supplied with the kit.

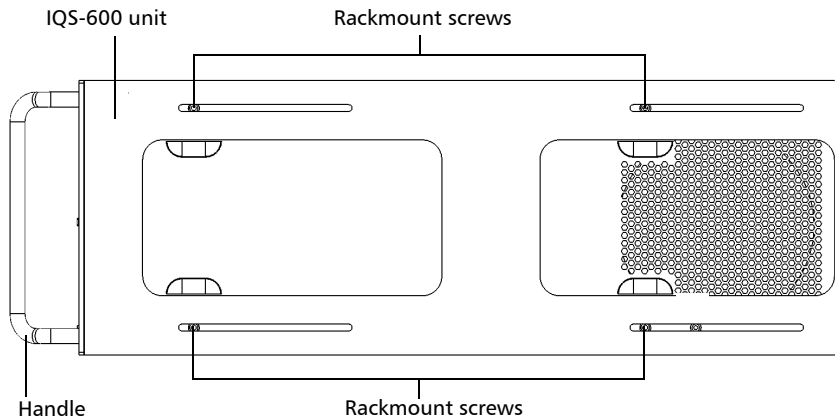

Getting Started with Your Integrated Qualification System

Installing Your Controller and Expansion Units in a Rackmount

4. Insert the rackmounted unit into the cabinet as shown below and secure it in place using the hardware supplied with the rack.

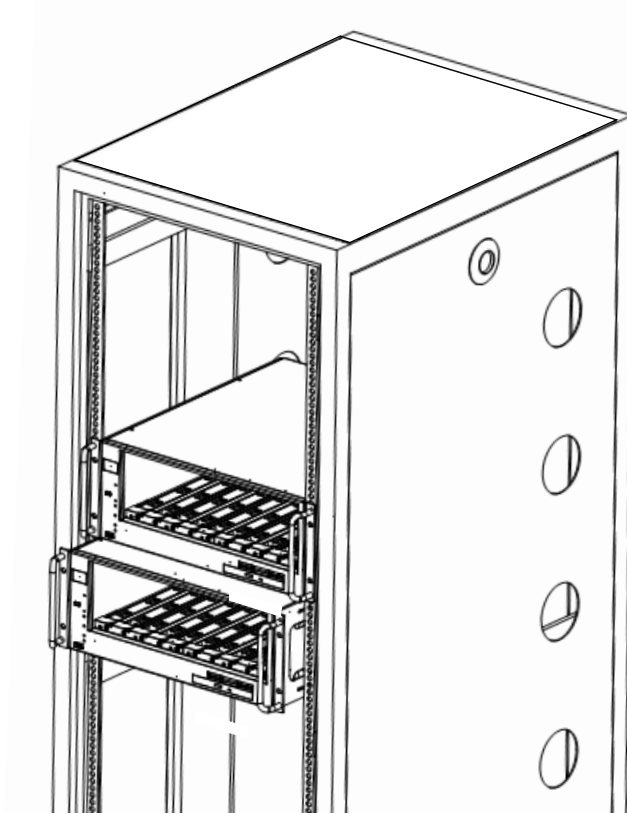

5. Repeat steps 1 through 3 for each unit being installed in the rackmount.

If you want to move a unit forward or backward in the rackmount, untighten the screws on each side of the rackmount kit slightly and slide the unit forward or backward. Retighten the screws afterwards.

Connecting One or More Expansion Units to a Controller Unit

It is possible to connect expansion units to your controller unit. You can either stack your units on a desk or install them in a rackmount (see *Installing Your Controller and Expansion Units in a Rackmount* on page 22 for instructions).

Note: *As your expansion units are daisy chained, the position is indicated by a number displayed on the unit's position display.*



IMPORTANT

- High-speed units bear the "HS" inscription on their front panels, while the standard units do not.
- You can link both high-speed and standard units. However, to benefit from the high-speed feature, you must chain the units in a specific order: all the high-speed units first, followed by all the standard units.

Getting Started with Your Integrated Qualification System

Connecting One or More Expansion Units to a Controller Unit

To connect an Expansion Unit to a Controller Unit:

1. Connect the provided cable to the EXFO Bus Out port located at the back of your controller unit.

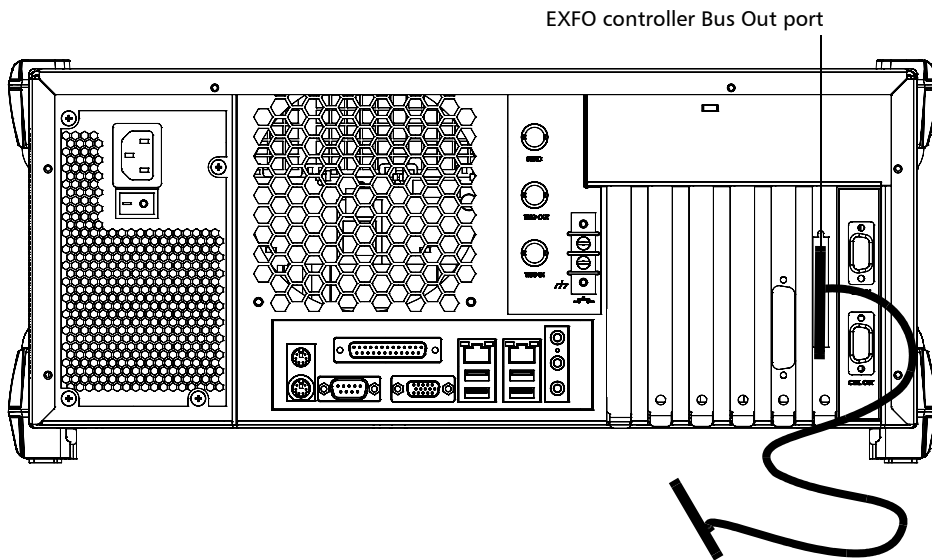

IMPORTANT

To ensure that your cable is properly connected, firmly push the IQS interface cable into the port until it clicks twice. An improper connection might cause operation problems.

Getting Started with Your Integrated Qualification System

Connecting One or More Expansion Units to a Controller Unit

2. Connect the other end of the cable to the EXFO Bus In port located at the back of your expansion unit.

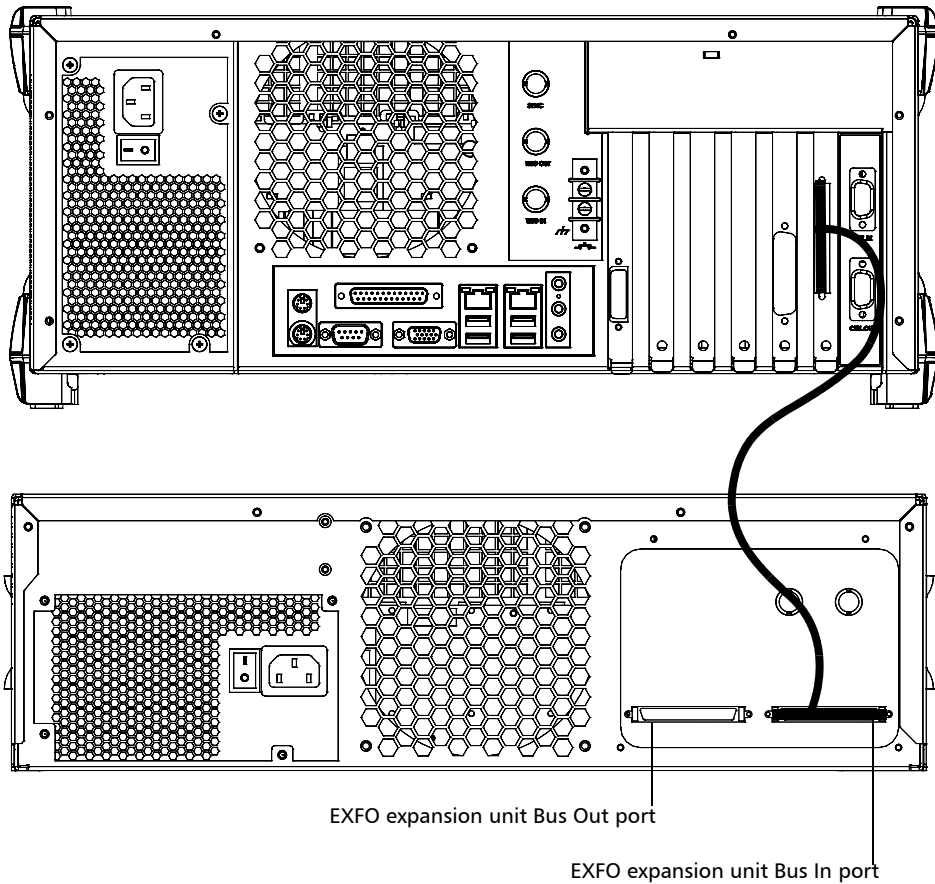

Getting Started with Your Integrated Qualification System

Connecting One or More Expansion Units to a Controller Unit

3. To connect additional IQS-610E-HS expansion units to your system, use another cable to connect the EXFO Bus Out port of the first unit to the EXFO Bus In port of the second unit.

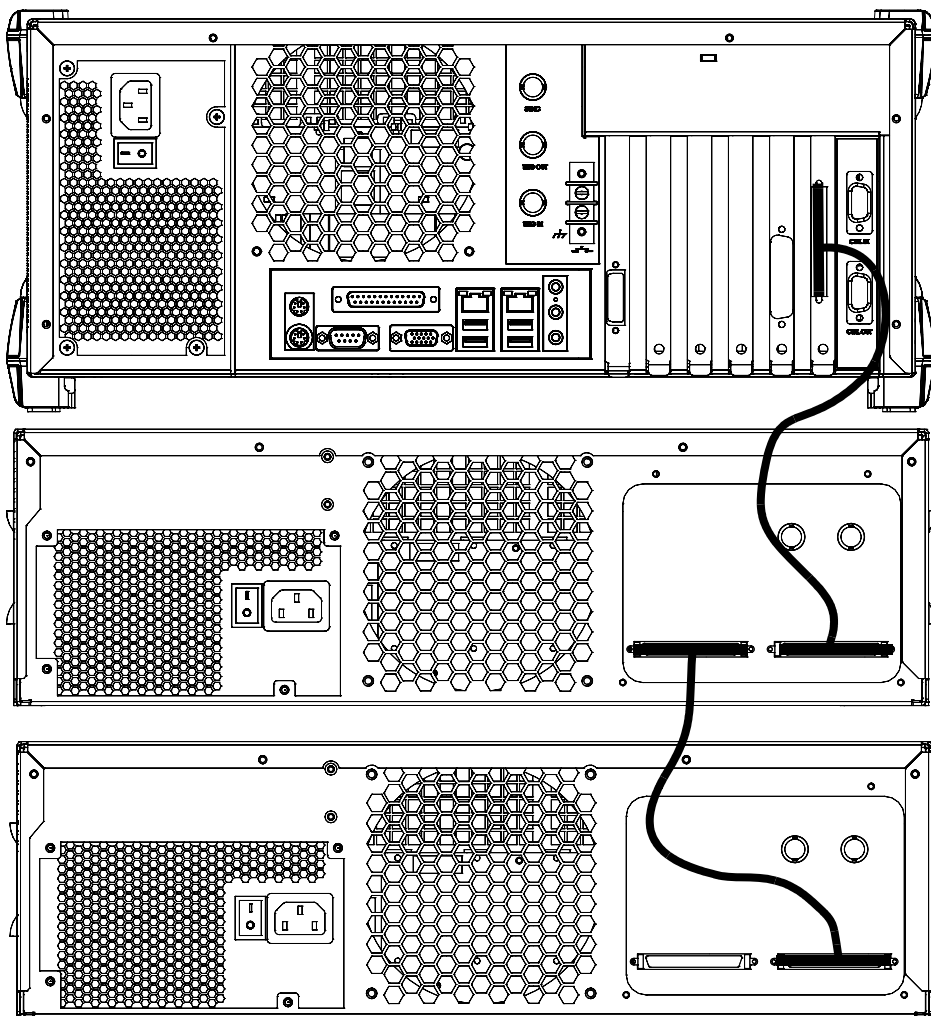

4. Repeat the previous steps for each additional unit you want to connect.

Inserting and Removing Test Modules



CAUTION

Never insert or remove a module while the controller unit and its expansion units are turned on. This will result in immediate and irreparable damage to both the module and unit.



CAUTION

To avoid damaging your unit, use it only with modules approved by EXFO.

Getting Started with Your Integrated Qualification System

Inserting and Removing Test Modules

To insert a module into the controller or expansion unit:

- 1.** Exit IQS Manager and turn off all your units.
- 2.** Remove the protective cover from the desired unused module slot.
 - 2a.** Pull the retaining screw knob firmly towards you and release the bottom of the cover.
 - 2b.** Gently pull the top of the protective cover downwards, to remove it from the unit grooves.

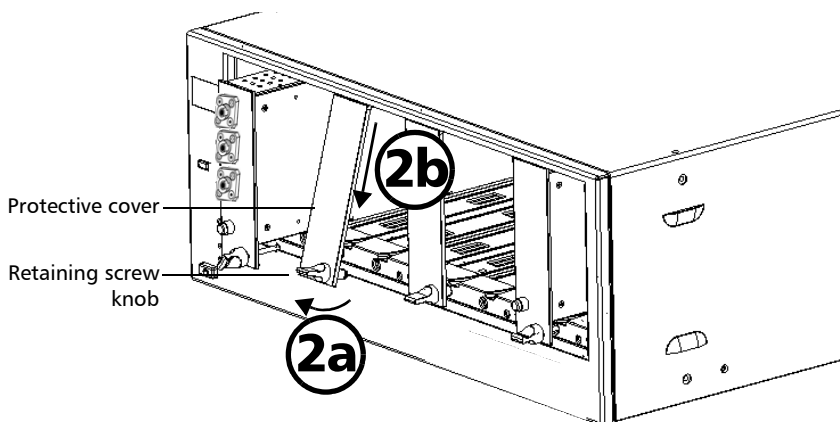

- 3.** Position the module so that its front panel is facing you and the top and bottom protruding edges are to your right.

Getting Started with Your Integrated Qualification System

Inserting and Removing Test Modules

4. Insert the protruding edges of the module into the grooves of the unit's module slot.

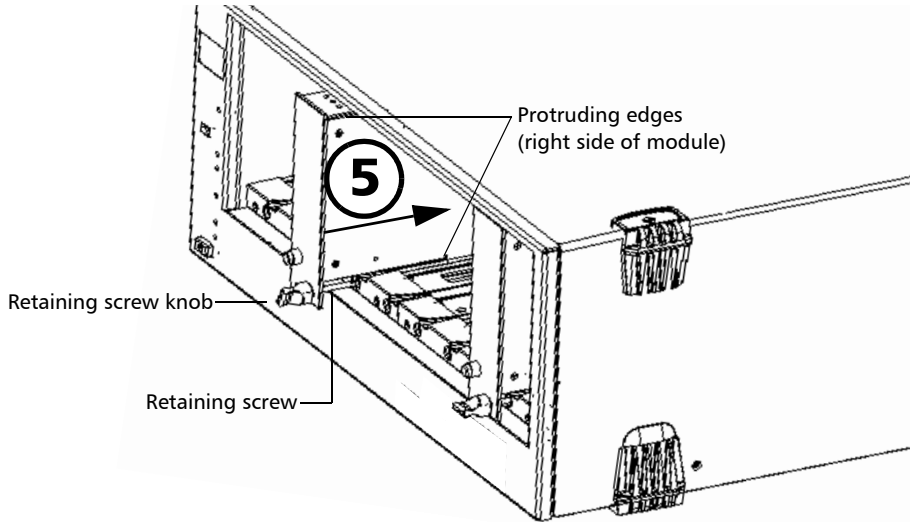

5. Push the module all the way to the back of the slot, until the retaining screw makes contact with the unit casing.
6. While applying slight pressure to the module, turn the retaining screw knob (located at the bottom of the panel) clockwise until the knob is horizontal.

This will secure the module into its “seated” position.

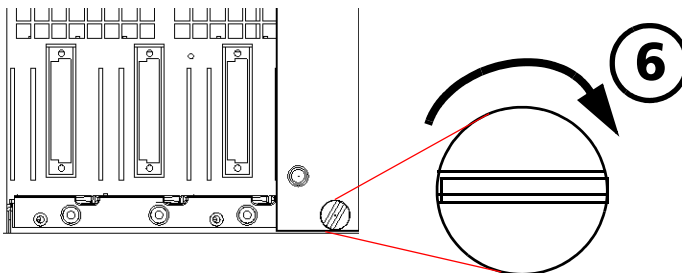

Getting Started with Your Integrated Qualification System

Inserting and Removing Test Modules

The module is correctly inserted when its front panel is flush with the front panel of the controller or expansion unit.

When you turn on the controller unit, the startup sequence will automatically detect your module.

Note: *You can insert IQ modules into your controller or expansion unit; the IQS Manager software will recognize them. However, the IQS-600 locking mechanism (retaining screw) will not work for IQ modules.*

To remove a module from your controller or expansion unit:

1. While pulling gently on the knob, turn it counterclockwise until it stops.

The module will slowly be released from the slot.

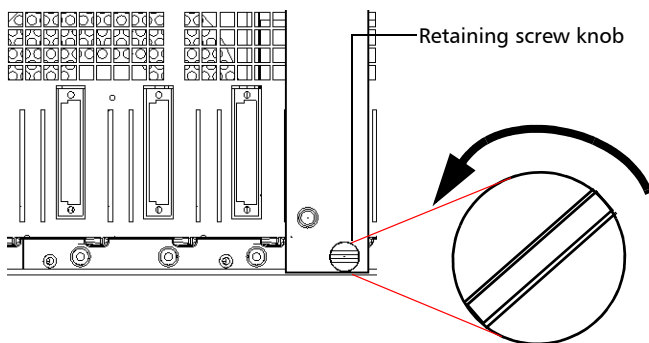

2. Place your fingers underneath the module or hold it by the retaining screw knob (*NOT by the connector*) and pull it out.

Getting Started with Your Integrated Qualification System

Inserting and Removing Test Modules

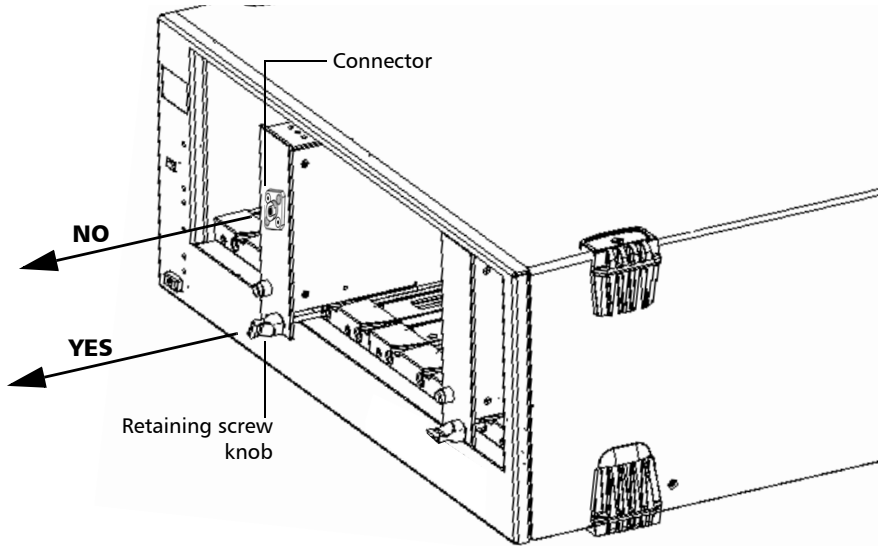

CAUTION

Pulling out a module by a connector could seriously damage both the module and connector. Always pull out a module by the retaining screw knob.

3. Cover empty slots with the supplied protective covers.
 - 3a. Slide the top of the protective cover into the upper grooves of the unit.
 - 3b. Snap the cover into place by pushing the retaining screw knob.



CAUTION

Failure to reinstall protective covers over empty slots will result in ventilation problems.

Since IQ modules do not have retaining screw knobs to help you remove them, EXFO provided you with a special tool to facilitate the operation.

To remove IQ modules:

- 1.** Slide the tool's end between the module front panel and the unit.
- 2.** Using the bumper as the pivot point, push down the tool to release the module.

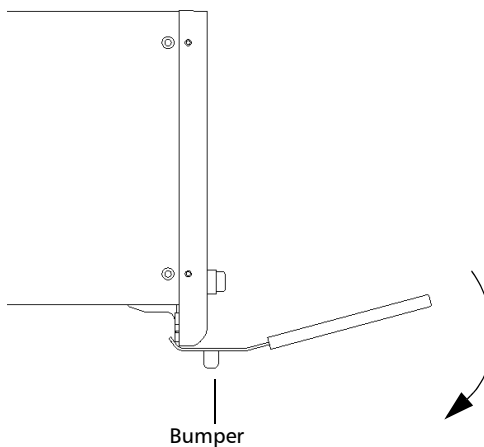

- 3.** Pull the module out.

Use the same precautions regarding module protective covers as you would for your IQS modules.

Safeguarding Units with the Interlock

EXFO's more powerful and potentially harmful modules, such as laser sources, are equipped with an interlock system that prevents accidental power ups.

If your module is equipped with an interlock system, you might have to link the terminals, located at the back of your IQS-610P-HS controller unit, with the provided connectors.

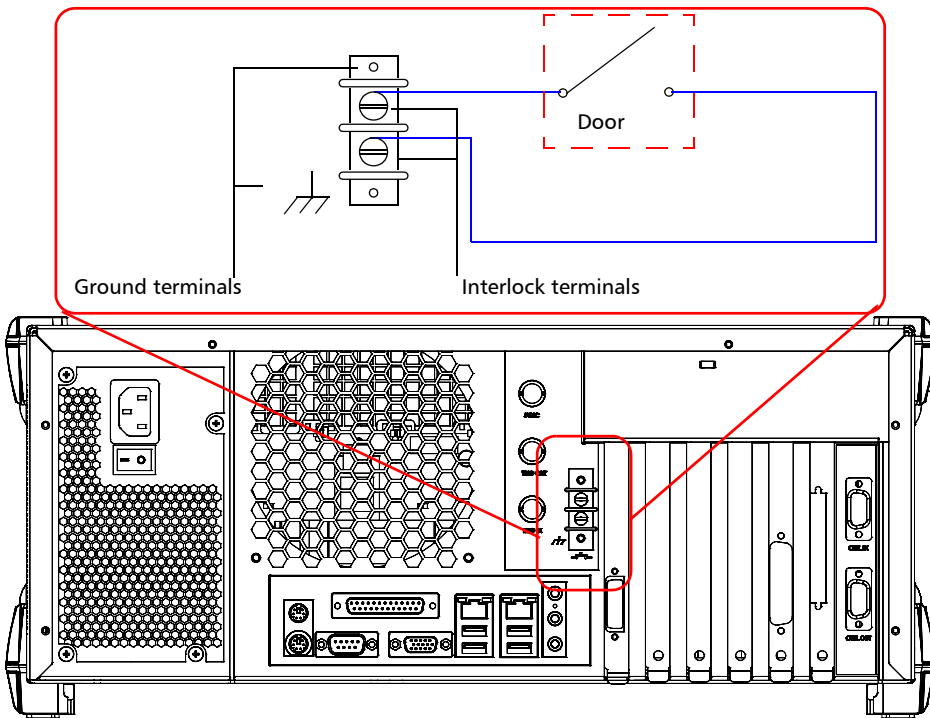

You can connect your interlock terminals to an external safety device using either your own connectors or the connectors provided by EXFO.

Note: *If you are using shielded cables to connect your interlock terminals, use either ground terminal to secure your connection.*



CAUTION

The Interlock ground is **NOT** intended to ground the whole unit. It is used for the interlock cable shielding connection only.

If you use modules featuring an interlock, these terminals must communicate, whether it is directly or via the external security device. Otherwise, your modules will not function properly.

The output voltage is 5 V. Do not apply any voltage to the interlock terminals, since only a mechanical contact is needed.



IMPORTANT

Some modules have an interlock located on the front panel. Use the front interlock instead of the one located at the back of your controller unit, as the latter will not offer you any protection.

For more information about the type of interlock system to use with the module you are working with, refer to the corresponding user guide.

Turning the Integrated Qualification System On and Off



CAUTION

If the controller unit is stored at a temperature outside of the specified operating temperature range, let the controller unit reach operating temperature before turning it on.

To turn your controller or expansion unit on, use the button located on the lower left-hand part at the front of the unit. To ensure that your IQS-600 controller unit detects the expansion units, use a proper starting sequence. First turn on the expansion units, and then turn on your IQS-600 controller unit. Failure to use proper starting sequence may lead to malfunction.

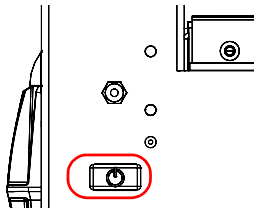

Note: If you have more than one expansion units linked together, the order in which you turn them on does not matter.

Ensure to turn on the main power switch located at the back of each unit.

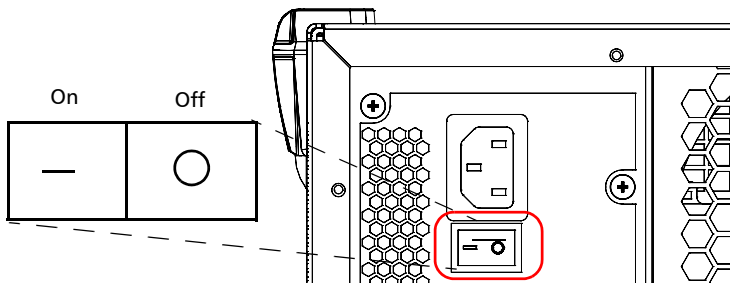

Configuring Your Unit At First Startup

The first time you turn on the unit, a Windows configuration wizard is displayed, enabling you to set all the regional and language settings such as the country and operation language.



IMPORTANT

The operation language that you select at the first startup (labelled "App language") becomes the default system language, that is the language that will be available at logon.

During the configuration process, you will also be asked to read and accept the Microsoft end-user license agreement (EULA).

Once the configuration is complete in Windows, an EXFO wizard will be displayed, allowing you to read the user documentation for important safety information, and to read and accept the EULA related to your unit and instruments.

Note: *To be able to work with the unit, you must accept all the EULA (from Microsoft and EXFO), and confirm that you have read the security information.*

To configure your unit at first startup:

1. If it is not already done, turn on the unit (see *Turning the Integrated Qualification System On and Off* on page 38).
2. When the Windows wizard is displayed, set the parameters according to your needs.
3. Read and accept the Microsoft EULA.
The configuration of Windows parameters may take several minutes.

Getting Started with Your Integrated Qualification System

Configuring Your Unit At First Startup

4. When the EXFO wizard is displayed, follow the on-screen instructions.

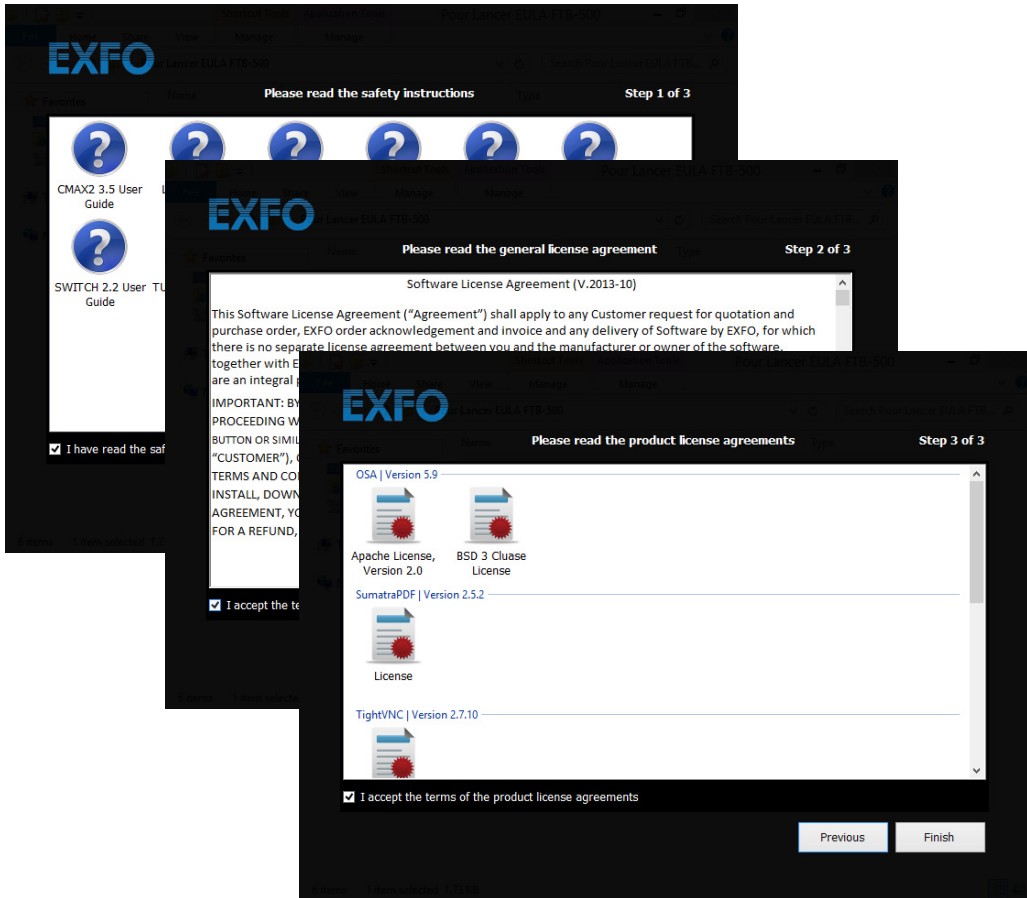

5. Click **Finish** to close the wizard and start working.

Working with Windows 8.1 Pro

If you are not familiar with Windows 8.1 Pro, you may want to visit Microsoft Web site for tutorials as well as detailed information on the features and concepts brought by this operating system.

One of the new features is the use of touchscreen gestures to perform certain tasks (IQS-605P-HS).

Note: *For an optimal accuracy with the touchscreen, use the stylus provided with your unit.*

Note: *To show the taskbar, press the  button from the front panel of the unit.*

Getting Started with Your Integrated Qualification System

Working with Windows 8.1 Pro

Here is an overview of the gestures that you may use the most with your IQS-605P unit.

- Tap and double-tap: Equivalent of a click and double-click with a mouse.
- Swipe right: To return to the last used application. From the left edge of the screen, swipe towards the right.

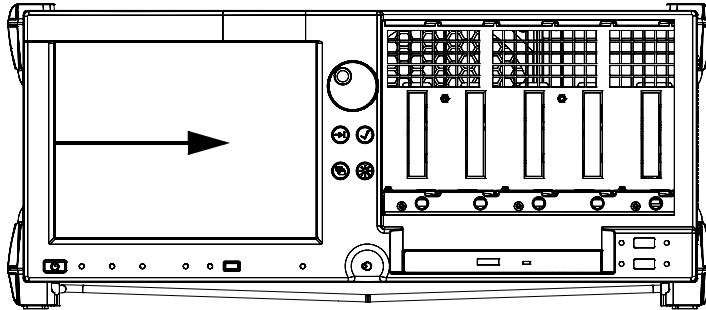

- Swipe left: To display the Charm bar, which is a special toolbar that gives you access to many tools and settings. From the right edge of the screen, swipe towards the left.

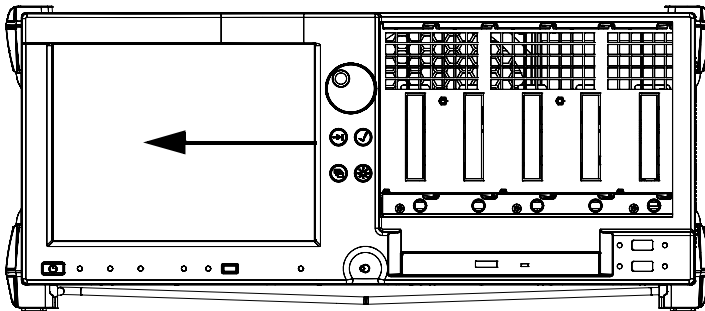

Using the On-Screen (Virtual) Keyboards

Whenever you need to enter alphanumeric data, you can either use the keyboard that is integrated to IQS Manager (for legacy applications inside IQS Manager), or the Windows on-screen keyboard (for applications inside IQS Manager or in Windows).

Note: *The Windows on-screen keyboard supports multilingual features, and functions according to the keyboard settings set in Windows.*

To use the Windows on-screen keyboard:

1. From the taskbar, tap the on-screen keyboard icon (located to the left of the clock).

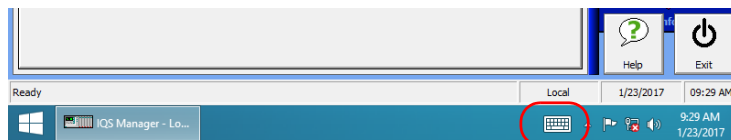

2. Select the location where you want to enter text.
3. Enter the data as required.
4. Close the keyboard when you are done entering data.

Getting Started with Your Integrated Qualification System

Using the On-Screen (Virtual) Keyboards

To activate the IQS Manager on-screen keyboard:

1. In the main window, select the **Utilities** function tab, then the **System** tab.
2. Click the **Settings** button.
3. Under **Keyboard**, select the **Use On-Screen Keyboard** option box.

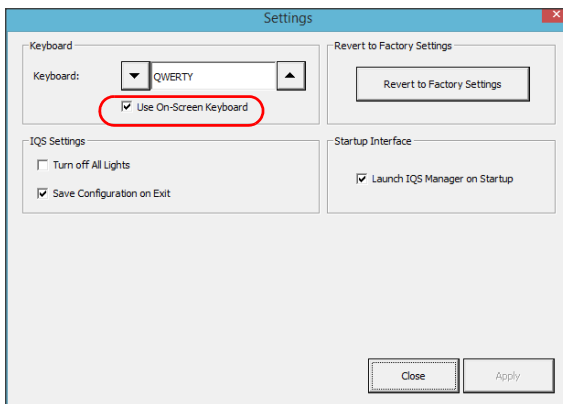

The next time you need to enter data, a keyboard appears and you can type using your mouse.

IQS Manager was designed to adapt to various on-screen keyboard types according to your preferences.

Note: *These settings do not affect your external keyboard or the Windows on-screen keyboard.*

Getting Started with Your Integrated Qualification System

Using the On-Screen (Virtual) Keyboards

To select the keyboard type:

- 1.** In the main window, select the **Utilities** function tab, then the **System** tab.
- 2.** Click the **Settings** button.
- 3.** Under **Keyboard**, use the up and down arrow buttons to select your keyboard type in the **Keyboard** box.

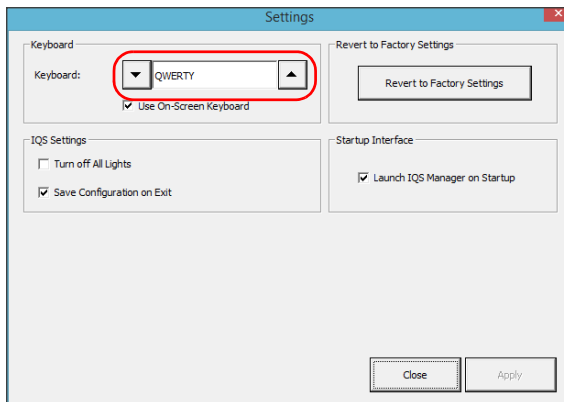

- 4.** Click **Apply** to use the new settings.

OR

Click **Close** to exit without using the new settings.

Installing or Upgrading the Applications

All the necessary applications have been preinstalled and configured at the factory. However, you may have to upgrade some applications when new versions become available or to reinstall them.

Note: *Only administrator-level users can install software under Windows.*

Each time you purchase a new module, it could be a good idea to verify that the most recent Update Manager application is installed on your unit.

When updates are available for an application, you will need to download them from Internet, either directly on your unit or on a computer. The update files must be copied to the location that has been specified for the deployment packages in Update Manager.

For the installation or upgrade, you will need:

- your unit
- a computer equipped with a USB port; Windows must be installed on the computer
- a USB memory key

Note: *The computer and USB key are only necessary if you do not wish to download the files directly on your unit.*

Note: *For more information on the installation, refer to the Update Manager online help.*

To update or reinstall Update Manager:

- 1.** If necessary, retrieve the desired installation files from the Internet.
If you do not intend to download files directly on your unit, connect a USB memory key to one of the USB ports of the computer and copy the installation files to this USB key.
- 2.** If it is not already done, turn on your unit.
- 3.** Exit IQS Manager and the modules' applications.
- 4.** If you want to install Update Manager using the USB key, disconnect it from the computer and connect it to one of the USB ports of your unit.
- 5.** On your unit, create a folder on the Windows desktop.
- 6.** Copy the installation files (from the USB key) to the newly created folder.
- 7.** From the newly created folder, tap the *Setup.exe* file to start the installation.
- 8.** Follow the on-screen instructions.
- 9.** When the installation is complete, simply disconnect the USB memory key.

Getting Started with Your Integrated Qualification System

Installing or Upgrading the Applications

To install or upgrade the applications:

- 1.** If necessary, retrieve the desired installation files from the Internet.

If you do not intend to download files directly on your unit, connect a USB memory key to one of the USB ports of the computer and copy the installation files to this USB key.
- 2.** If it is not already done, turn on your unit.
- 3.** Exit IQS Manager and the modules' applications.
- 4.** If you want to install or update applications using the USB key, disconnect it from the computer and connect it to one of the USB ports of your unit.
- 5.** Copy the installation files (from the USB key) to the folder containing the update and installation packages on your unit. By default, Update Manager will search for files in the default folder, which is C:\Users\Public\Documents\SoftwareUpdate. For more information, refer to the Update Manager online help.
- 6.** On your unit, from Windows desktop, double-tap the **Update Manager** icon to start the corresponding application. For more information on how to install or upgrade applications, refer to the Update Manager online help.
- 7.** When the installation is complete, simply disconnect the USB memory key.

Activating Software Options

The software options purchased at the same time as your unit have been activated for you already. However, if you purchase options afterwards, you will have to activate them yourself.



IMPORTANT

If you want to activate software options for *modules of the IQS-81XX Series or the IQS-85XX Series (except for the IQS-85100G model)*, refer to the user guide of your product for the specific activation instructions.

In all other cases, you can follow the instructions presented in this section.

Before being able to activate options, you need to contact EXFO with the following information:

- Purchase order number of the newly purchased options
- Module or platform serial number (depending on whether the software options were purchased for a module or the platform)
- Customer's name
- Customer's company name
- Customer's phone number
- Customer's e-mail address
- Module or platform on which the option will be installed

You will receive a single key (.key) file with which you will be able to unlock all the new options that you have purchased.

Getting Started with Your Integrated Qualification System

Activating Software Options

To activate the options for your unit:

1. Connect a USB memory key to one of the USB ports of your computer.
2. Copy the key file to the USB memory key.
3. Disconnect the USB key from the computer and connect it to your unit.
4. From IQS Manager, select the **Utilities** function tab, then the **System** tab.

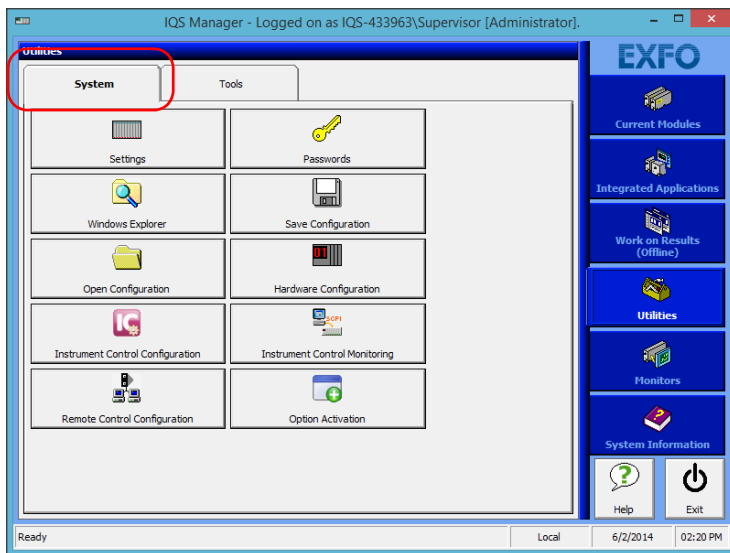

5. Select **Option Activation**.

6. In the **Platform Options** tab, use the **Browse** button to locate the key file that you want to use.

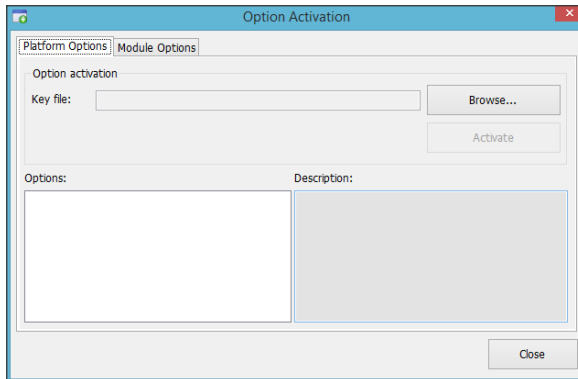

7. Click **Activate**.

The option indicator will turn into a green check mark to confirm that the option is now active.

8. Click **OK** to close the confirmation message, and then **Close** to exit.

Note: *At this point, if you have used a USB key to copy your key file, you can remove it as it is not required to use your new options.*

Getting Started with Your Integrated Qualification System

Activating Software Options

To activate software options for your module:

1. Connect a USB memory key to one of the USB ports of your computer.
2. Copy the key file to the USB memory key.
3. Disconnect the USB key from the computer and connect it to your unit.
4. From IQS Manager, select the **Utilities** function tab, then the **System** tab.

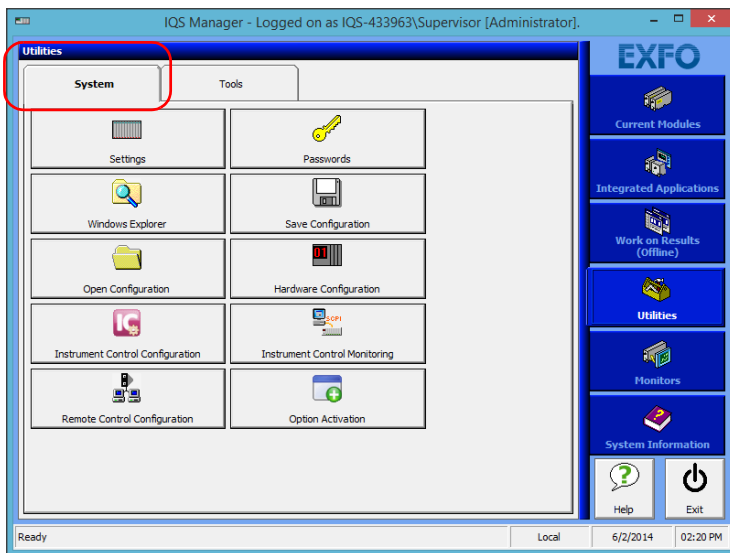

5. Select **Option Activation**.

Getting Started with Your Integrated Qualification System

Protecting your Unit with an Antivirus Software

6. In the **Module Options** tab, use the **Browse** button to locate the key file that you want to use.

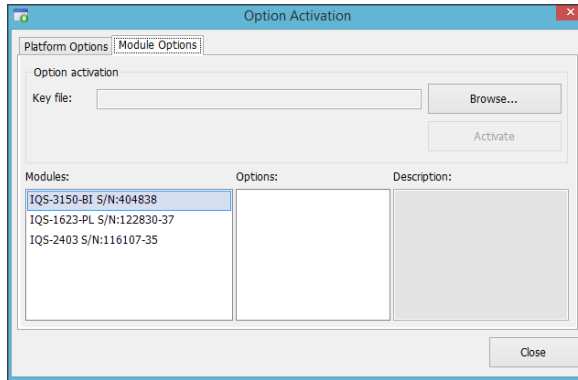

7. Click **Activate**.

The option indicator will turn into a green check mark to confirm that the option is now active.

Note: You can see the supported options for the module in the **Options** list.

8. Click **OK** to close the confirmation message, and then **Close** to exit.

Note: At this point, if you have used a USB key to copy your key file, you can remove it as it is not required to use your new options.

Protecting your Unit with an Antivirus Software

By default, your unit is protected with the Windows Defender antivirus software. However, you can apply your own security standards and antivirus strategy.

Accessing IQS Manager

When your IQS-600 Integrated Qualification System comes out of the factory, it is set to start automatically with Windows 8.1 Pro.

However, if you want to start it automatically with IQS Manager, see *Selecting the Startup Interface* on page 84.

To access IQS Manager when in the Windows environment:

- Click the **IQS Manager** icon on your desktop.
- OR
- Click the Windows button (), then under EXFO, select **IQS Manager**.

The main window is used to control your platform:

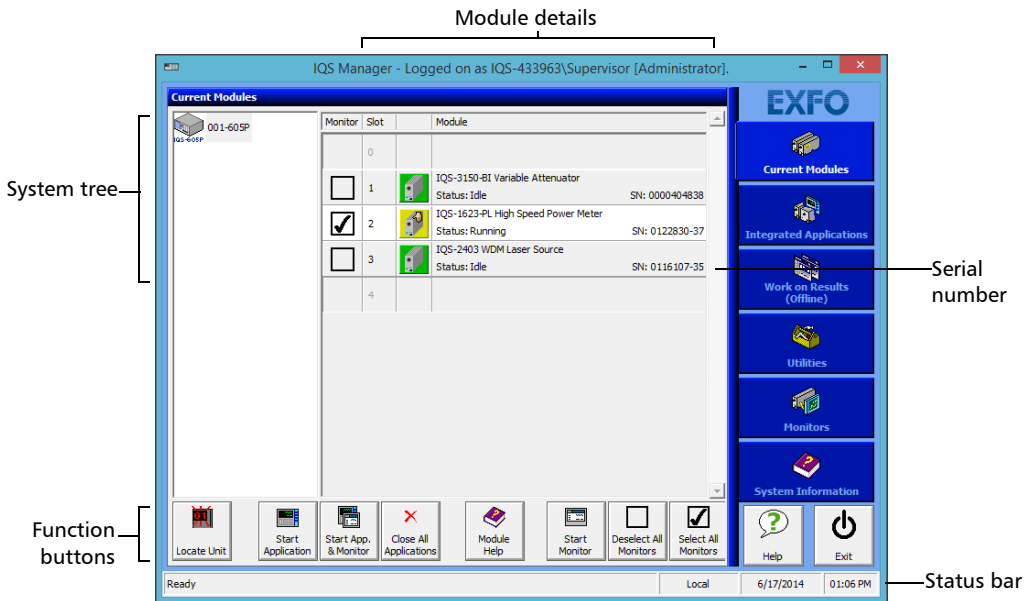

Exiting IQS Manager

To exit IQS Manager:

1. Click the **Exit** button, located on the lower right-hand side of the main window.

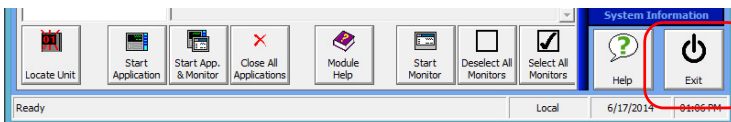

2. Select the appropriate option among the three choices below:
 - **Exit IQS Manager:** to close IQS Manager and return to Windows.
 - **Log off Windows:** to close IQS Manager and log off your Windows session so another user may log on.
 - **Turn off IQS:** to completely shut down the IQS-600 controller unit.
3. Click **OK** to confirm your choice, or **Cancel** to return to IQS Manager.



IMPORTANT

Your platform was set up with the Windows power management plan set to High Performance so that it does not enter the Sleep or Hibernate modes. Do not change this power management plan, as those modes are not compatible with IQS Manager.



IMPORTANT

To ensure proper operation of your Integrated Qualification System, follow this shut down procedure:

- First, turn off your IQS-600 controller, and then
- Turn off all expansion units.

Note: *Expansion units are shut down manually by pressing on the On/Off button located on the front lower left-hand part of each unit.*

Installing EXFO LabVIEW Drivers

Before being able to work with EXFO LabVIEW drivers, you must install the following elements on your computer or on your IQS-600 Integrated Qualification System:

- National Instruments LabVIEW software and the corresponding patches.
- EXFO LabVIEW drivers (including demo applications to help you get started with the drivers).



You can find the LabVIEW drivers on the DVD that came with your unit, on the EXFO Web site at www.exfo.com, or on the National Instrument Web Site at www.ni.com.

For more details, see *Working with EXFO LabVIEW Drivers* on page 195.

Note: *Only administrator-level users can install software under Windows.*

To install the LabVIEW software:

1. Insert the *LabVIEW* CD in the CD-ROM drive of your unit or computer.
2. The installation process should start automatically. If not, or if you have downloaded the files from the National Instruments Web site, start it manually as follows:
 - 2a. Open the File Explorer ( icon in the taskbar under Windows 8.1 Pro).

Note: *To access the File Explorer on your unit, from the front panel, press the  button to show the taskbar (IQS-605P units). From the lower left corner of the screen, click the **Start** button () and then click the **File Explorer** tile.*



- 2b. Locate the autorun.exe file, then double-click on it to start the installation procedure and follow the on-screen instructions.

You should keep the default names and paths suggested by the installation program.

3. Once the software installation is complete, install the patches available for your LabVIEW version.

If the patches are not included on your LabVIEW CD, you may download them from National Instruments' Web site at www.ni.com.

- 3a. Open the File Explorer ( icon in the taskbar under Windows 8.1 Pro).

Note: *To access the File Explorer on your unit, from the front panel, press the  button to show the taskbar (IQS-605P units). From the lower left corner of the screen, click the **Start** button () and then click the **File Explorer** tile.*



- 3b. Locate the Updates\setup.exe file, then double-click on it to start the installation procedure, and follow the on-screen instructions.

Getting Started with Your Integrated Qualification System

Installing EXFO LabVIEW Drivers

To install the EXFO LabVIEW drivers:

1. Insert the installation CD in the CD-ROM drive if needed, unless you have downloaded the drivers from the National Instruments Web site.
2. Start the installation process as follows:
 - 2a. Open the File Explorer ( icon in the taskbar under Windows 8.1 Pro).

Note: To access the File Explorer on your unit, from the front panel, press the  button to show the taskbar (IQS-605P units). From the lower left corner of the screen, click the **Start** button () and then click the **File Explorer** tile.

- 2b. Locate the Labview Drivers\setup.exe file, then double-click on it to start the installation procedure and follow the on-screen instructions.

For easier use, the drivers will be installed in LabVIEW's default instrument library folder:

C:\Program Files\National Instruments\LabVIEW 2012\instr.lib.

Connecting an External Monitor

A controller unit can be connected to an external monitor. Connect your monitor to the standard computer connector located at the back of the unit.

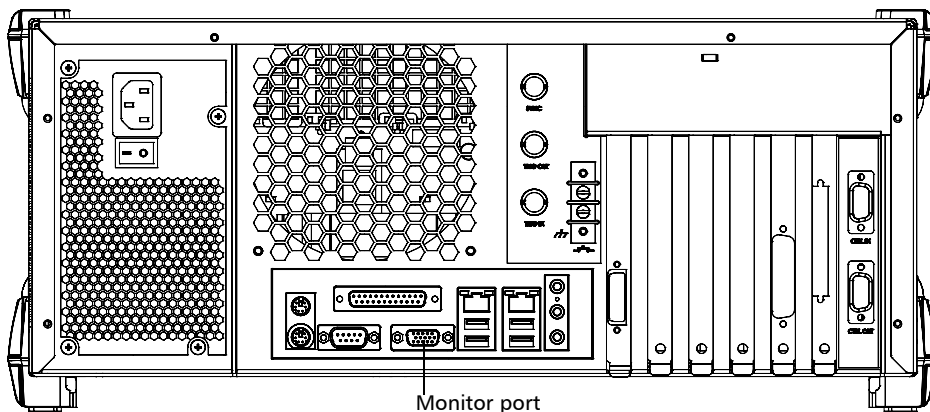

Note: Use the Windows Control Panel to configure the display settings of your external monitor.

Note: You cannot set the screen resolution to 800 x 600 using the Windows screen resolution utility. You must use the Intel GMA driver utility in the Windows Control Panel to change it to that specific setting.

Getting Started with Your Integrated Qualification System

Connecting an External Monitor



CAUTION

Do not put the monitor directly on the front part of your units. This would press on the front opening, thus preventing you from inserting or removing modules correctly.

Ensure that the monitor:

- ▶ is at least 8 inches away from the front of the unit;
- ▶ does not rest on the 12-inch wide area across the front opening.

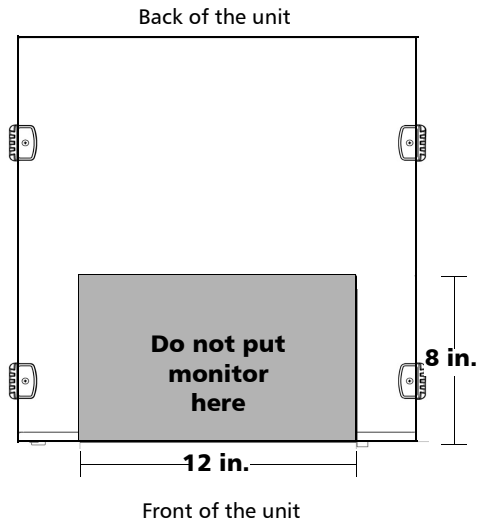

Connecting an External Keyboard

Your IQS-600 Integrated Qualification System can be used with either a USB or a PS/2 keyboard.

To connect a keyboard to the unit:

Use any of the USB ports located both at the front and back of the unit.

OR

Use the PS/2 keyboard port located at the back of the unit.

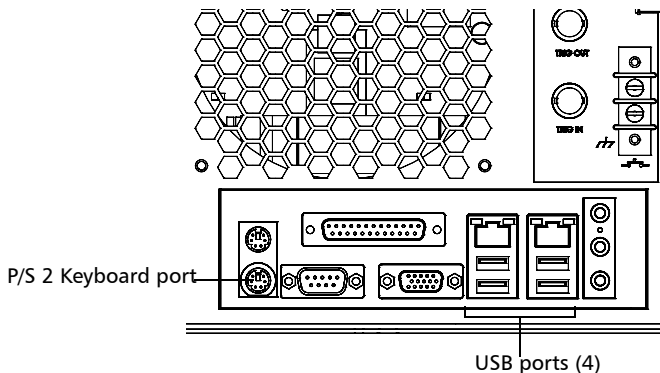

Refer to your keyboard's documentation for instructions on how to install the corresponding drivers, if needed.

Connecting a Mouse

Your IQS-600 Integrated Qualification System can be used with either a USB or PS/2 mouse.

To connect a mouse to the unit:

Use any of the USB ports located both at the front and back of the unit.

OR

Use the PS/2 mouse port located at the back of the unit.

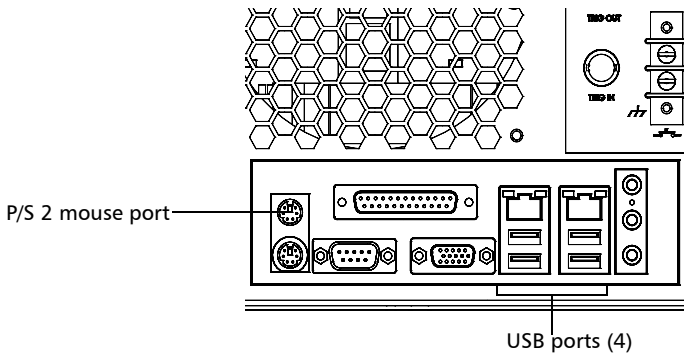

Your USB mouse is automatically recognized and immediately usable (provided that it uses the drivers already available on your unit. Otherwise, refer to your mouse's documentation for instructions on how to install the corresponding drivers, if needed.

Connecting a Tape, CD, or DVD Player

Your IQS-600 Integrated Qualification System can be used with an external tape, CD, or DVD player.

To connect a tape, CD, or DVD player to the unit:

Use the Line In port located at the back of the unit.

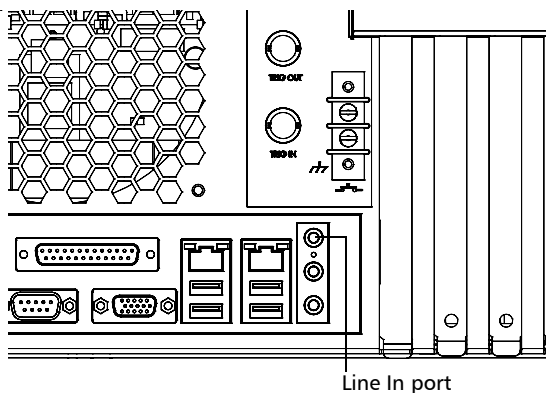

Connecting a Headset or a Speaker

Your IQS-600 Integrated Qualification System can be used with either a headset or speaker.

To connect a headset or speaker to the unit:

Use the Line Out port located at the back of the unit.

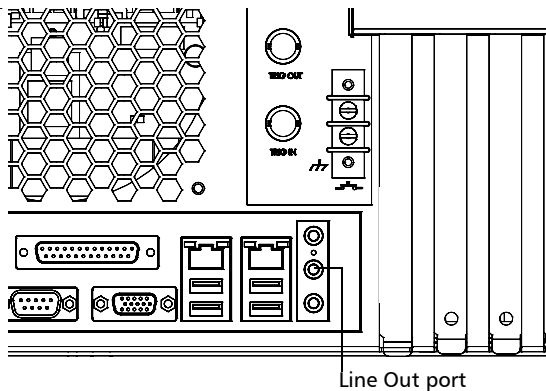

Connecting a Microphone

Your IQS-600 Integrated Qualification System can be used with a microphone.

To connect a microphone to the unit:

Use the microphone port located at the back of the unit.

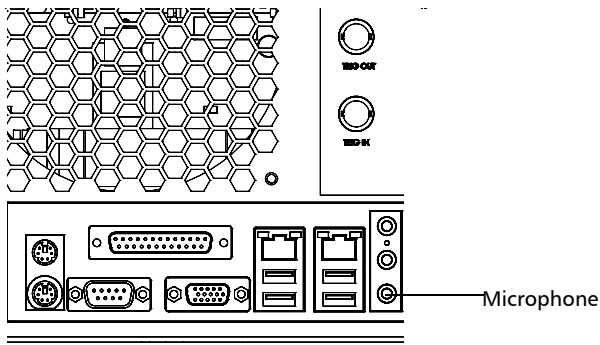

Connecting a Printer

Your IQS-600 Integrated Qualification System can be used with a printer.

To connect a printer to the unit:

Use any of the USB ports located both at the front and back of the unit.

OR

Use the parallel port located at the back of the unit.

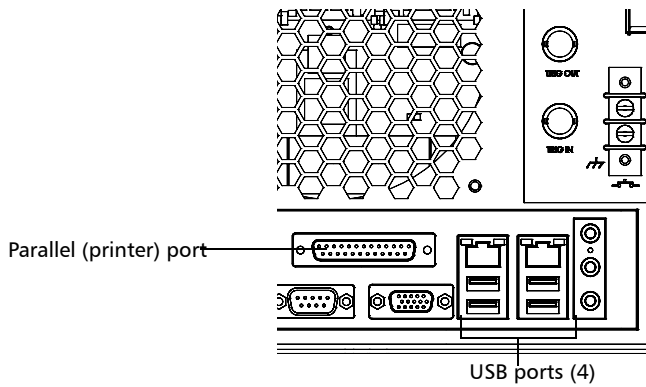

Refer to your printer’s documentation for instructions on how to install the corresponding drivers.

4 Setting Up Your Integrated Qualification System

Calibrating Your Touchscreen (IQS-605P-HS)

The touchscreen simplifies and accelerates testing procedures by providing immediate access to commands. It detects the position of the finger or any other blunt pointing device used to activate a command, a function, or a button.

Note: *Some features, such as the touchscreen and selection dial, may not be available depending on the version of the software you are using.*

The IQS-605P-HS controller unit comes equipped with a stylus to use with your touchscreen. The stylus is located in the lower right corner of the screen. Pull it out of its storage location to use it.

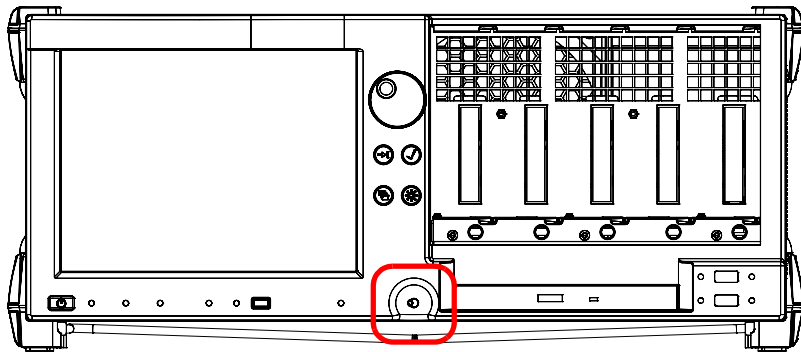



You can customize the touchscreen behavior to improve response to touches. To better see what is on the screen, you can also change the brightness of the screen backlight, as explained in *Changing the Backlight Level (IQS-605P-HS)* on page 69.

When you receive your IQS-605P-HS controller unit, calibrate the touchscreen to ensure that it behaves in the way that suits you best.

Setting Up Your Integrated Qualification System

Adjusting Microphone and Speaker Volume

To calibrate your touchscreen:

1. From the front panel of the unit, press the  button to show the taskbar (IQS-605P units).
2. Point the lower left corner of the screen, and then click the **Start** button ().
3. In the **Apps** section, under **UPDD**, select **Calibrate**.
4. Follow the calibration procedure described on the corresponding tab.

Adjusting Microphone and Speaker Volume

Different working environments call for different sound settings. If you have connected a headset or an external speaker to your unit, you can adjust the volume to better suit your needs.

To adjust the volume:

1. On your platform, put the mouse cursor on the upper or lower right corners of the window to display the Charm bar.

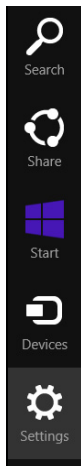

2. Click **Settings**, then the  icon.

3. Move the slider until the sound level is to your liking.

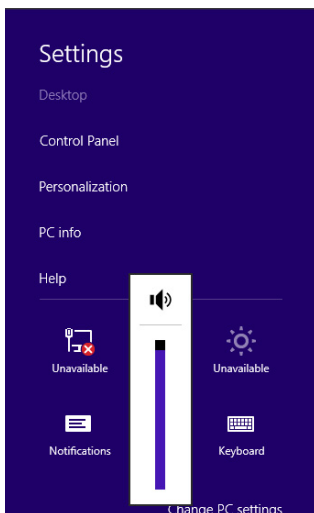

Note: You can also access the sound level slider by using the  icon from the taskbar.

Changing the Backlight Level (IQS-605P-HS)

The backlight has four brightness levels: Off, Low, Medium, and High. Pressing  on the front of your unit enables you to switch between these levels.

Setting Up Your Integrated Qualification System

Deactivating the LED Display

Deactivating the LED Display

Note: This feature is not available in offline mode.

Your testing environment may require total darkness and you do not want any LED or light activity that could compromise your test results.

Note: The backlight does not automatically turn off. You must adjust it as explained above.

To deactivate the LED display:

1. Select the **Utilities** function tab, and then select the **System** tab.
2. Click the **Settings** button.
3. Under **IQS Settings**, select **Turn off All Lights**.

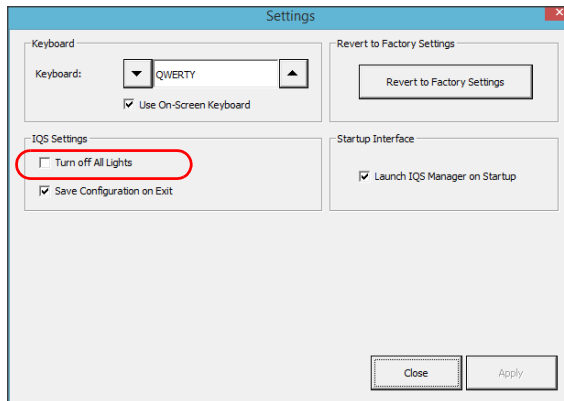

4. Click **Apply** to confirm, or **Close** to exit and discard the new settings.

Selecting the Language of Operation

You may display the user interface in one of the available languages. If you select another language than those available for your platform, English will be used.

When you change the interface language, the corresponding keyboard is automatically added to the list of available keyboards. You can then enter text in a specific language (either on-screen or using a hardware keyboard). Once the keyboards are added, you can switch easily from one input language to another.

Values are kept in memory even when you turn your unit off.

To select a new interface language:

1. From the Windows Desktop, right-click on the Start () button, then select **Control Panel**.
2. Under **Clock, Language, and Region**, select **Add a language**.

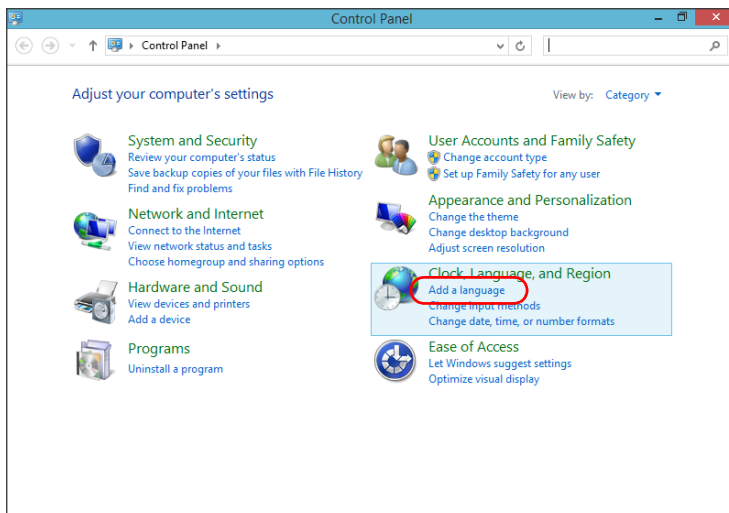

Setting Up Your Integrated Qualification System

Selecting the Language of Operation

3. Select the desired language from the list.

Note: *If the language you want is not in the list of available languages, you must install the corresponding language pack through the Internet.*

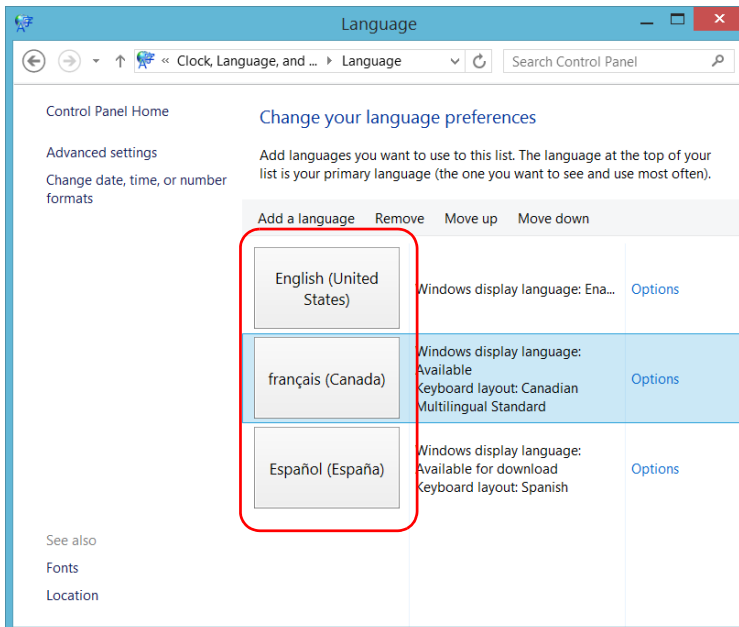

4. Click **Options**.

Setting Up Your Integrated Qualification System

Selecting the Language of Operation

5. If you want to select another keyboard layout than the one that has been added by default, proceed as follows:

- 5a. Under **Input method**, click **Add input method**.

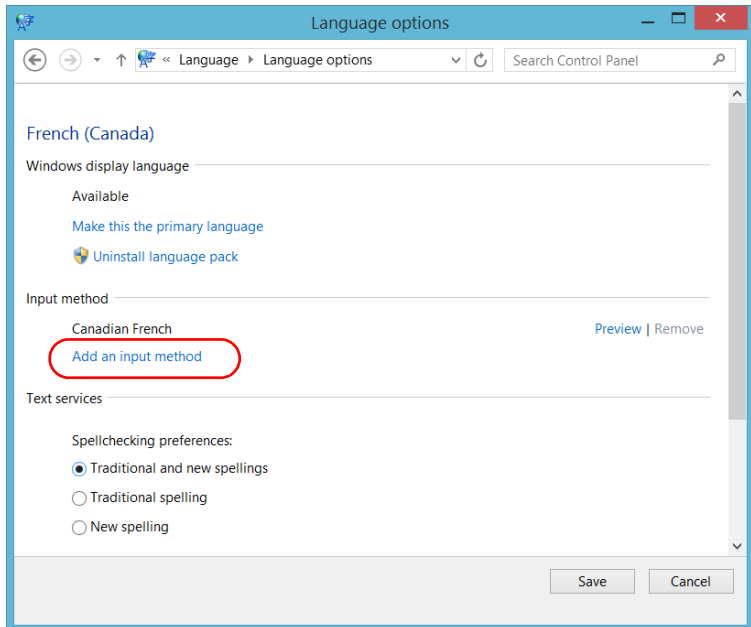

Setting Up Your Integrated Qualification System

Selecting the Language of Operation

5b. Select the desired keyboard layout, then click **Add**.

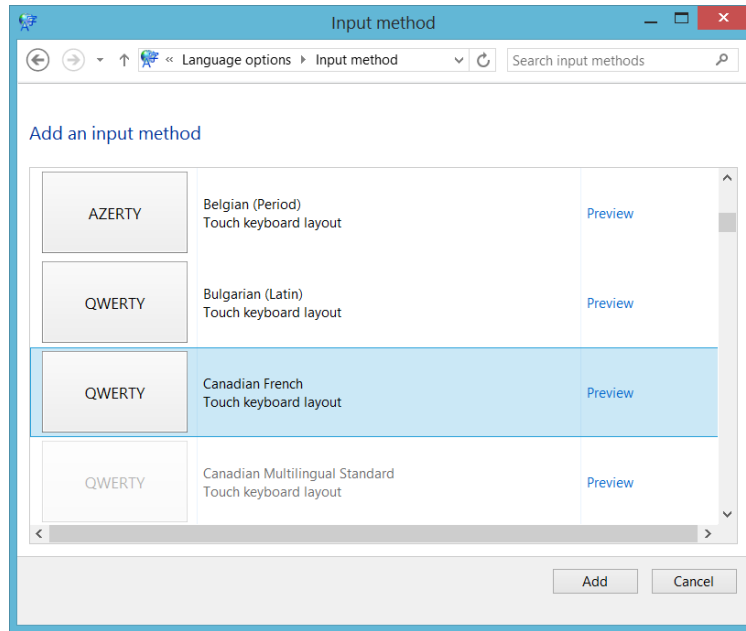

6. Under **Windows display language**, click **Make this the primary language**.

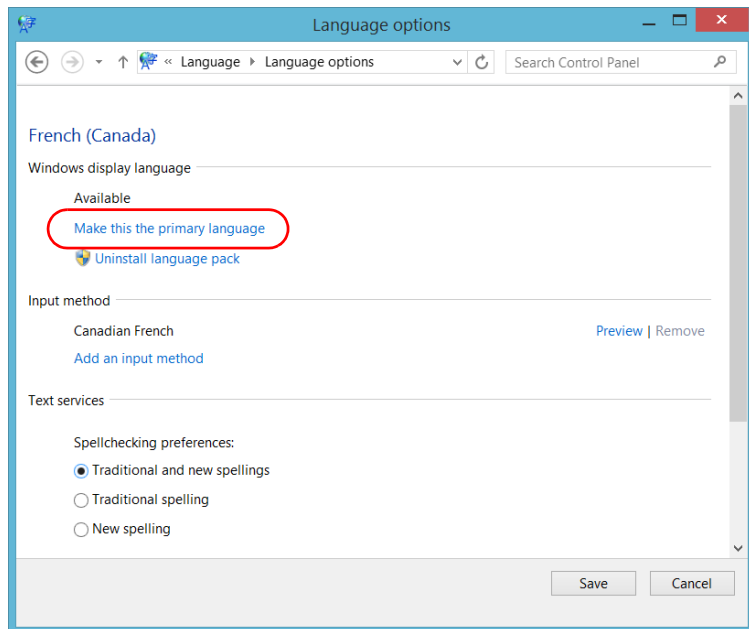

7. When the application prompts you to log off, select **Log off now**.
8. Once you see the lock screen, log in your user account.

The new language is now selected and you are able to switch from one input language to another.

Setting Up Your Integrated Qualification System

Selecting the Language of Operation

To download language packs:

1. Ensure that your unit has access to the Internet.
2. From the Windows Desktop, right-click on the Start () button, then select **Control Panel**.
3. Under **Clock, Language, and Region**, select **Add a language**.

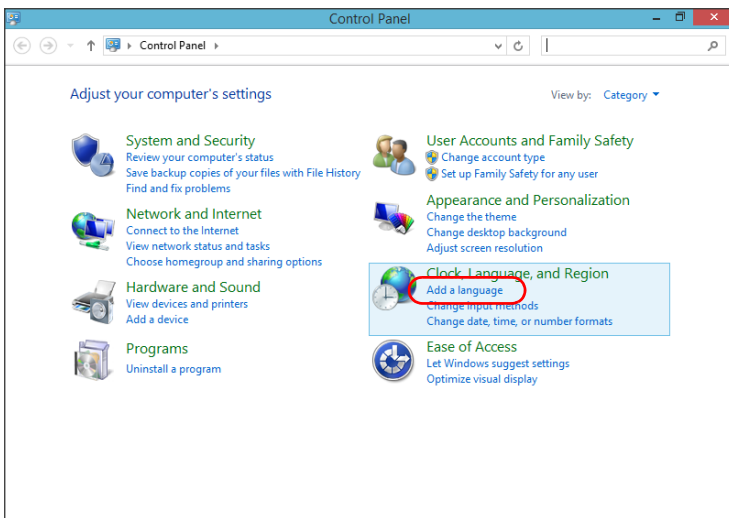

Setting Up Your Integrated Qualification System

Selecting the Language of Operation

4. Click **Add a language**.

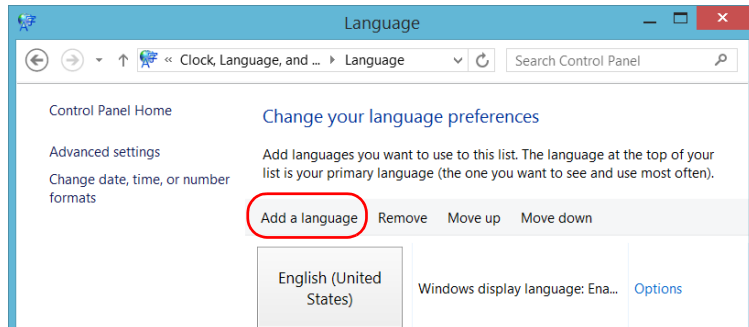

5. Browse the list of languages, and then select the one that you want to use.

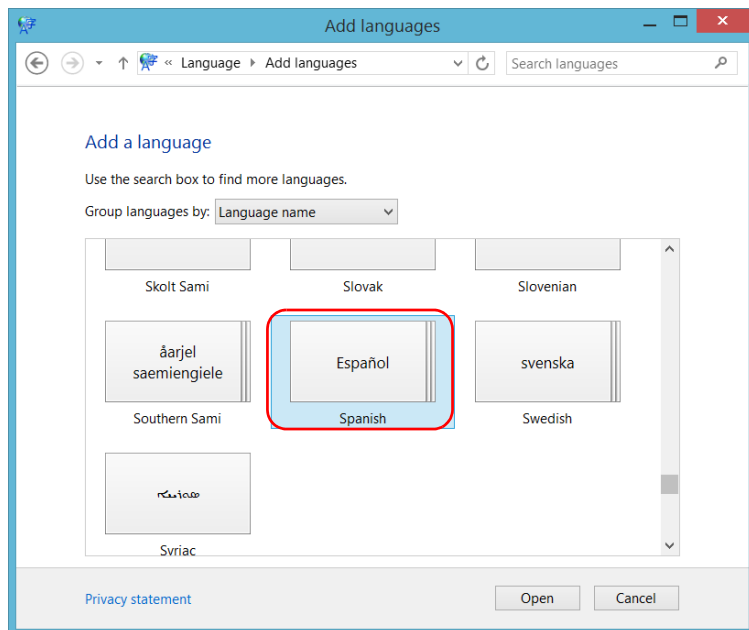

6. Click **Open** to access the list of sub-languages.

Setting Up Your Integrated Qualification System

Selecting the Language of Operation

7. Select the desired sub-language, and then click **Add**.

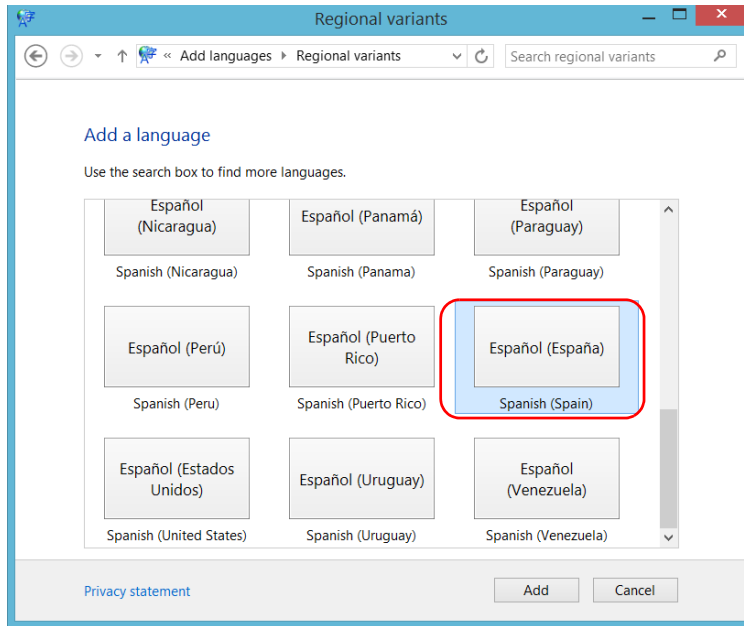

Setting Up Your Integrated Qualification System

Selecting the Language of Operation

8. Select the desired language from the list.

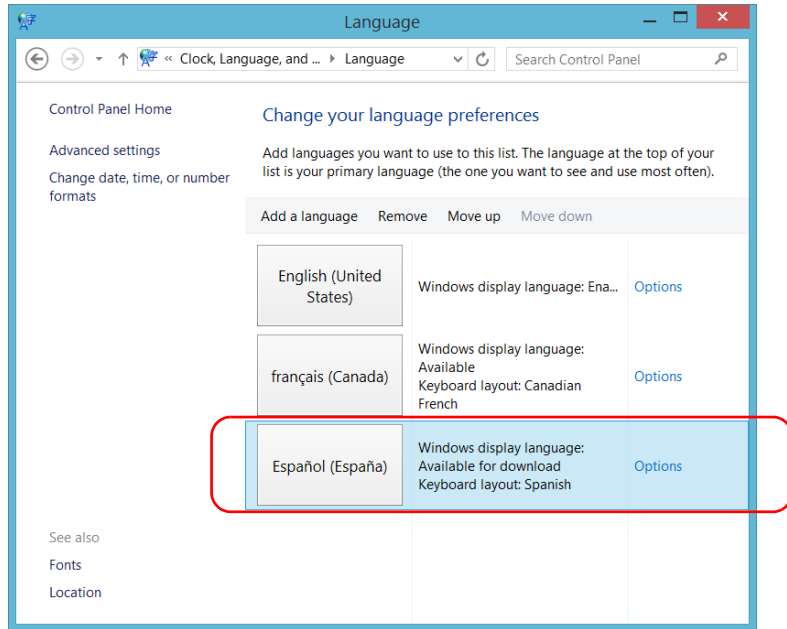

9. Click **Options**.

Setting Up Your Integrated Qualification System

Selecting the Language of Operation

10. Click **Download and install language pack**.

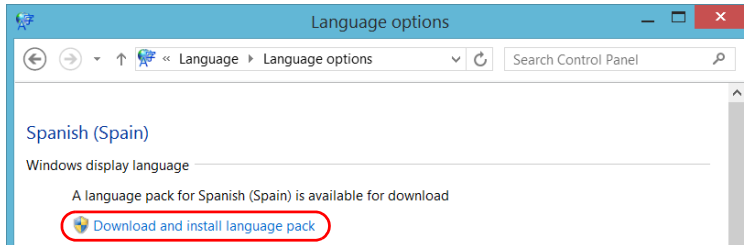

11. When the application prompts you to allow the installation, Click **Yes**.
The installation may take a few minutes.

12. When the installation is complete, restart your unit.

To switch from one input language to another:

1. From the taskbar, click the language code to display the list of available input languages.



2. From the list of languages, select the desired one.

You are now ready to start entering text in the selected input language.

Note: *Modifying the input language does not modify the language of the interface.*

Setting Date and Time Formats

By default, the dates (short and long) and time are displayed in the formats associated with the global language format (locale). The time can be expressed with a 12- or 24-hour notation. You can modify the way dates and time are displayed if the default values do not suit your needs.

For information on how to adjust the date, the time and the time zone, see *Adjusting the Date, Time and Time Zone* on page 83.

To set date and time formats:

1. From the Windows Desktop, right-click on the Start () button, then select **Control Panel**.
2. Under **Clock, Language, and Region**, click **Change date, time, or number formats**.

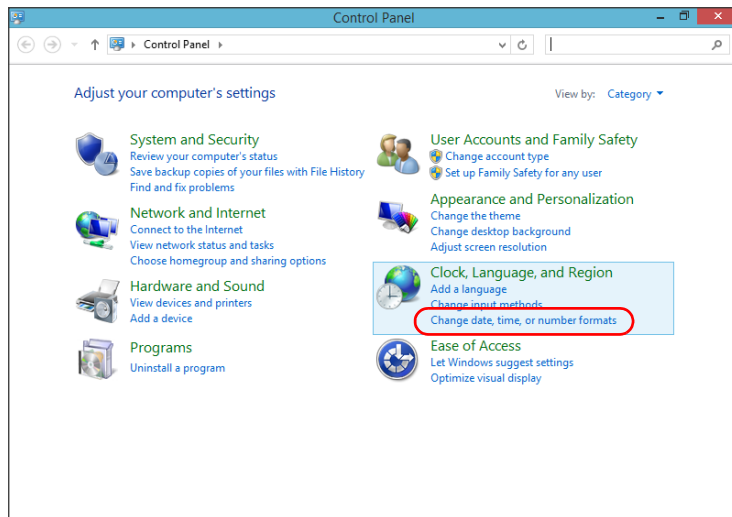

Setting Up Your Integrated Qualification System

Setting Date and Time Formats

3. Refine the settings according to your needs.

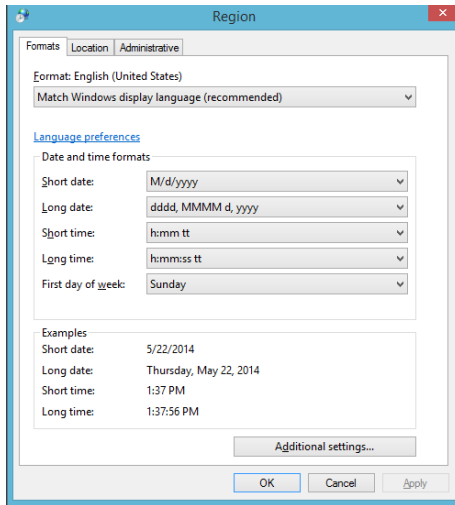

4. Click **Apply** to confirm, and then **OK** to close the window.

The values are taken into account immediately.

Adjusting the Date, Time and Time Zone

Note: Only administrator-level users can adjust the date and time. All users can modify the time zone.

The current date and time are displayed at the bottom of the main window. When saving results, the unit also saves the corresponding date and time.

For information on how to modify the format in which the date and time are displayed, see *Setting Date and Time Formats* on page 81.

To adjust the date, time or time zone:

1. From the main window, click the date and time displayed in the lower right corner of the screen.
2. Click **Change date and time settings**.

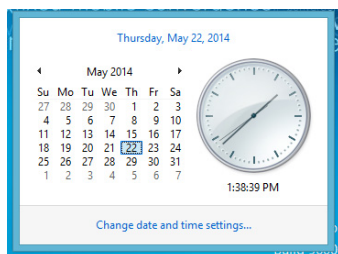

3. Modify the settings according to your needs.
4. Click **Apply** to confirm, and then **OK** to close the window.

The new values are taken into account immediately.

Setting Up Your Integrated Qualification System

Selecting the Startup Interface

Selecting the Startup Interface

You can select whether or not IQS Manager automatically starts when you turn the unit on.

To select the startup interface:

1. Select the **Utilities** function tab, and then select the **System** tab.
2. Click the **Settings** button.
3. Select the **Launch IQS Manager on Startup** check box.

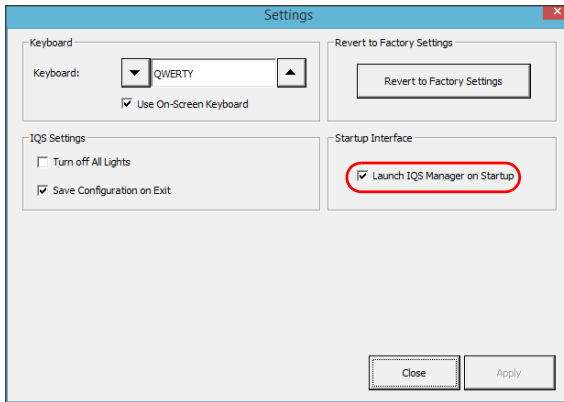

4. Click **Apply** to confirm your choice, then **Close** to return to the **Utilities** function tab.

Your choice of interface will be used on your next startup. If the option is not selected, the system will start with Windows.

Customizing Access Levels

You cannot set passwords in IQS Manager itself. It uses the same security levels and accesses as Windows. This means that if you are logged in Windows as an Administrator, you have access to everything on IQS Manager.

Your Integrated Qualification System is set at the factory to automatically start IQS Manager in Administrator level mode. If you want to set passwords for other user types, refer to the Windows online help, under “Passwords”.

Power-User and Standard-User levels have limited access to IQS Manager functions, while Administrator level users can give specific access rights to power users and standard users.

Note: *Despite these settings, Windows security could prompt you to confirm some of the configuration-changing actions such as changing the fan speed, as they are allowed for supervisor-level users only. To change the settings for those specific requests, follow the on-screen instructions.*

Setting Up Your Integrated Qualification System

Customizing Access Levels

To customize access levels:

1. In the main window, select the **Utilities** function tab, then the **System** tab.
2. Click **Passwords**.
3. Ensure that **Apply Security Access Control** selected.

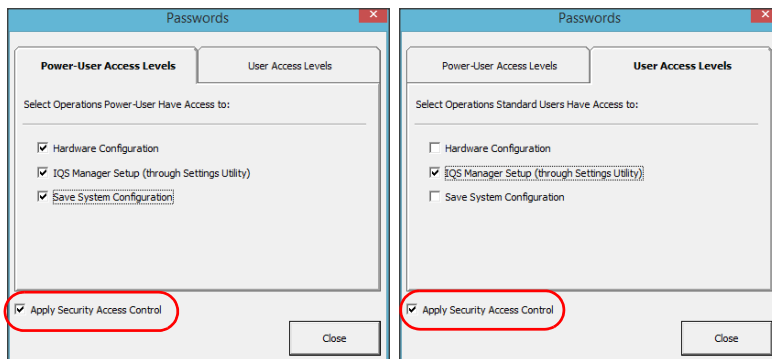

4. Click the tab of the user level for which you want to set accesses.
5. Select the items you want the users to access by checking the corresponding boxes.
 - **Hardware Configuration:** to rename hardware.
 - **IQS Manager Setup:** to change items in the **Settings** section of the **Utilities** function tab.
 - **Save System Configuration:** to save configurations on your IQS-600.
6. Click **Close** to accept your changes.

The changes will take effect upon the next logon.

Note: *In order for the access levels to take effect, you must select the **Apply Security Access Control** check box in the **Passwords** dialog box. If the box is cleared, IQS Manager operates in Administrator level.*

Setting Up Auto Logon for Windows

Note: Only administrator-level users can enable or disable the automatic logon feature.

You can set Windows to automatically log on when you start your unit (no need to select a user and enter a password).

Note: Keep in mind that you should not enable auto logon if you need privacy for any file on your unit. If you need to maintain privacy, create separate user accounts for each user, and have every user protect their account with a password.

For security reasons, by default, the automatic logon is not enabled. Once it is enabled, if you want to modify the password of the user account for which the automatic logon is enabled, you will have to disable the feature first, then enable it again once the new password is defined.

If you want to modify the account used for the automatic logon, you will also have to disable the feature first, and then enable it again for the new account.



IMPORTANT

The user name and password that you specify for the automatic logon must correspond to those of an existing user account.

You can create user accounts or modify passwords from the Accounts window (Charm bar > Settings > Change PC settings > Accounts).

Setting Up Your Integrated Qualification System

Setting Up Auto Logon for Windows

To automatically log on to Windows upon startup:

1. Start Windows.
2. On the taskbar of the computer, click the start () button, then under **Windows System**, select **Run**.
3. In the **Run** box, type *control userpasswords2*, then select **OK**.

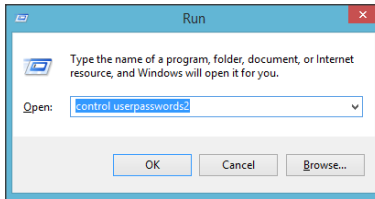

4. Clear the **Users must enter a user name and password to use this computer** option box. Select **OK**.

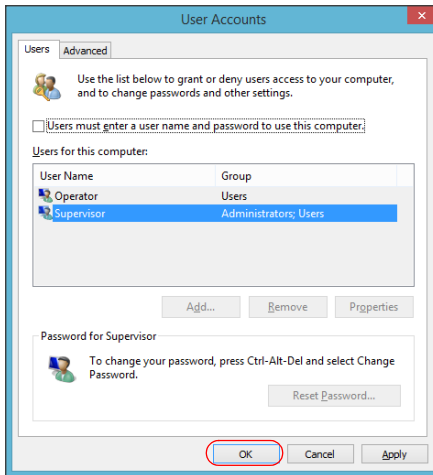

5. Select the **User name** box, type the user name that was displayed on the **start** menu in step 1. If you normally type a password to log on, type your password in both the **Password** and **Confirm Password** boxes. Otherwise, leave these boxes blank.

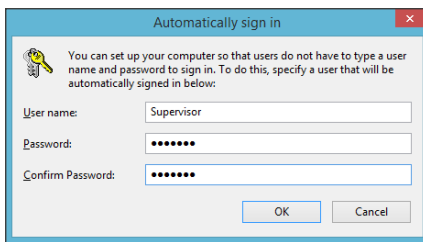

6. Select **OK**.

Auto logon now allows anyone to start and use your computer without typing a password.

Setting Communication Parameters

For information on communication settings for remote control, see *Preparing for Automation* on page 125.

Adjusting the Fan Speed

By default, the fan speed of the IQS-600 controller unit and expansion units is set to maximum. If you prefer, the application can also adjust the fan speed to a safe minimum. In this case, it determines the most appropriate fan speed according to the type and number of modules included in your units.

Note: *The fan speed is the same for the IQS-600 controller unit and its expansion units.*

Note: *Depending on your test configuration, it is possible that the minimum safe value corresponds to full speed.*

Note: *The specifications of the IQS modules are based on maximum fan speed. Using a lower fan speed can increase the measurement uncertainty. To ensure optimal performance from your unit, use maximum fan speed.*



CAUTION

Before inserting or removing modules, always ensure that **ALL** controller and expansion units are turned off, not only the unit in which (or from which) you want to insert (or remove) modules.

Otherwise, the application is not able to determine the appropriate fan speed and your modules will be irreparably damaged.

To adjust the fan speed:

1. In the main window, select the **Utilities** function tab.
2. Select the **Tools** tab, then **Fan Speed Setup**.

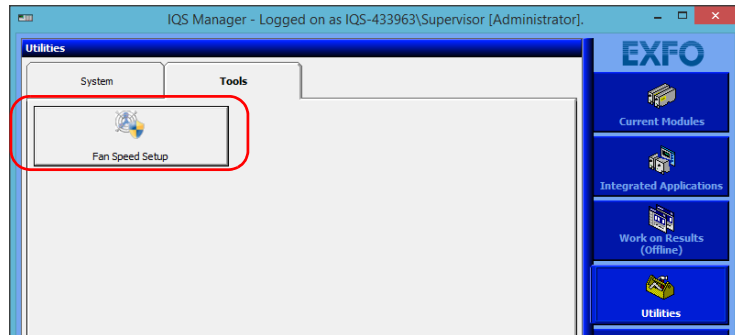

3. Select the desired option.

Current fan speed (indicated only if different from full speed)

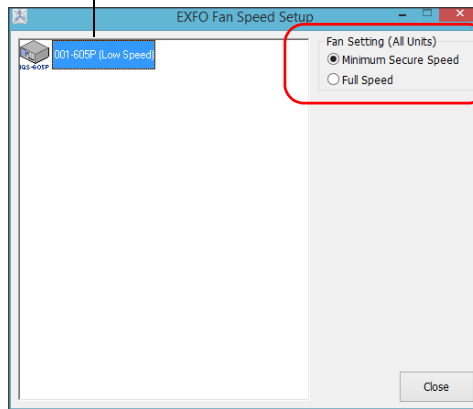

4. Click **Close** to save and apply your fan speed selection.

Saving and Opening Configurations

It is possible to save as many configurations as you want. This is particularly useful if users need to work with different configurations.

The configuration file includes:

- active modules
- settings under the **Settings** button

Once a configuration is saved, you can use it on any other IQS-610P-HS controller unit, providing you are using the same type of modules in both.

To save a configuration:

1. Select the **Utilities** function tab, and then select the **System** tab.
2. Click **Save Configuration**.

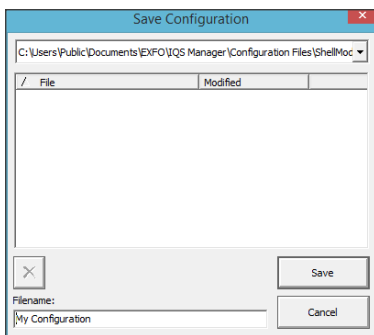

3. In the list at the top of the **Save Configuration** dialog box, select a folder in which to save your configurations.
4. In the **Filename** box, type the configuration name and click **Save**.

To load a configuration:

- 1.** Select the **Utilities** function tab, and then select the **System** tab.
- 2.** Click **Load Configuration**.

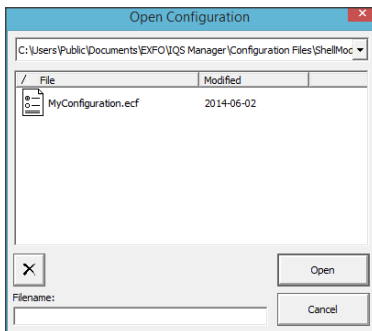

- 3.** In the list at the top of the **Open Configuration** dialog box, select the configuration to use and click **Open**.

Saving the Configuration on Exiting

IQS Manager offers you the possibility of saving your configuration as you exit. This allows you to continue where you left off when starting a new session.

To save your configuration when you exit IQS Manager:

1. Select the **Utilities** function tab, and then select the **System** tab.
2. Click the **Settings** button.
3. Select the **Save Configuration on Exit** check box.

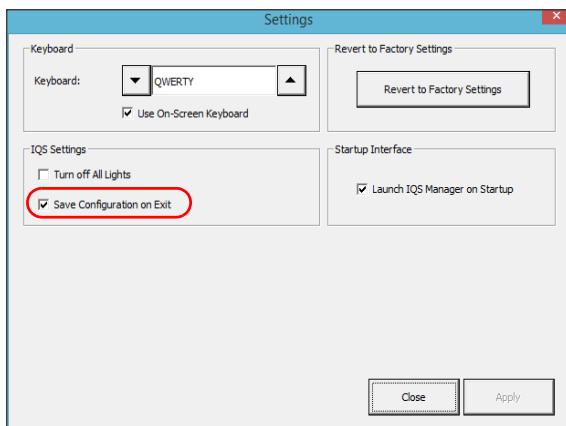

4. Click **Apply** to confirm your choice, then **Close** to return to the **Utilities** function tab.

Each time you exit IQS Manager using the **Exit** button, the current configuration is saved and recalled upon a new logon.

Note: *This function does not work if you log off Windows using the Start () button while IQS Manager is still running. You must first close IQS Manager to save the configuration.*

Changing Unit and Module Identification

Note: This feature is not available in Offline mode.

You can change the identification of your units and modules for easier hardware management.

To change the identification for your unit or module:

1. Select the **Utilities** function tab, and then select the **System** tab.
2. Click **Hardware Configuration**.

IQS Manager prompts you to close all applications before changing the hardware configuration. Click **Yes** to proceed.

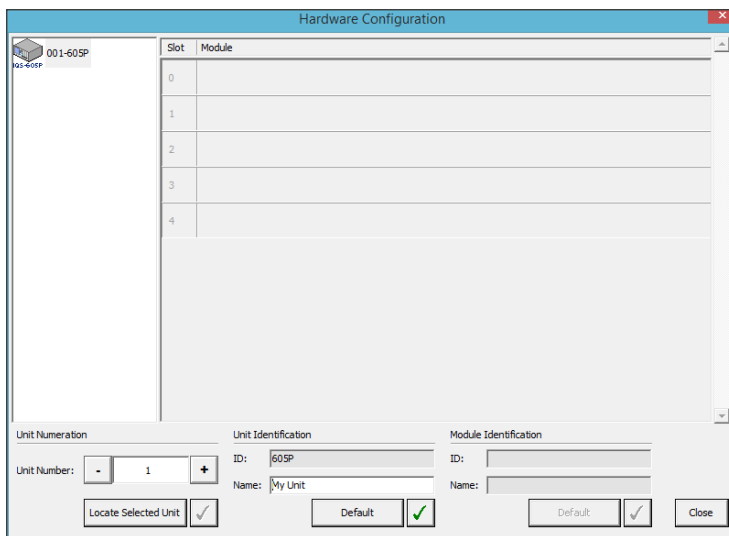

Setting Up Your Integrated Qualification System

Changing Unit and Module Identification

3. Click the unit or module you want to configure (it will turn white to indicate that it is selected).
4. Change the unit or module name and number as desired, using the corresponding fields. Click  next to the field to enter your new settings.
5. To revert to the default identification of the unit or module, click the corresponding **Default** button.
6. Click **Close** to return to IQS Manager.

Reverting to Factory Settings

You might need to revert to the factory settings, such as keyboard configuration or startup interface.



IMPORTANT

This action cannot be undone.

Note: You can only use the Revert to Factory function if you are logged on as an Administrator level user. The button is unavailable for the other user levels.

To revert to the factory settings:

1. Select the **Utilities** function tab, and then select the **System** tab.
2. Click the **Settings** button.
3. Under **Revert to Factory Settings**, click the corresponding button.

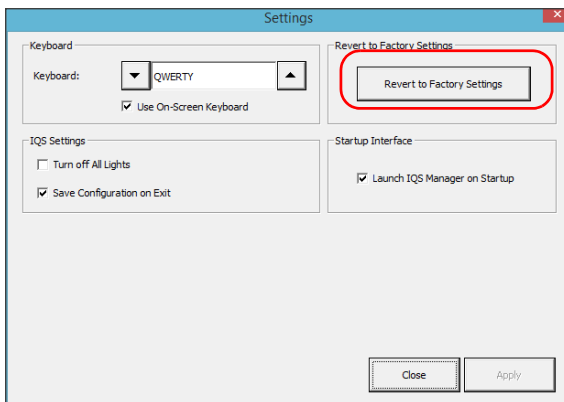

Note: These changes only affect parameters in the **Settings** window.

5 Using the IQS Manager Interface

This section helps you to work with the IQS Manager interface.

Accessing Current Modules

Note: This feature is not available in Offline mode.

If you did not select the **Save Configuration on Exit** option on the **Systems** tab of the **Settings** dialog box, the **Current Modules** function tab appears each time you start a new IQS Manager session.

The **Current Modules** function tab is divided into four sections.

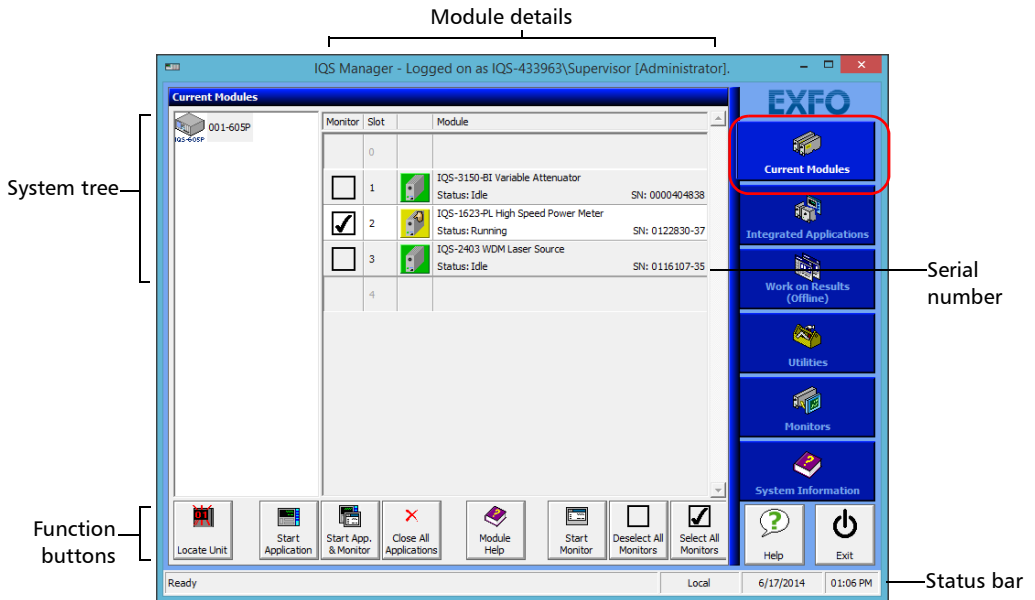

The system tree section allows you to see your units, as they are connected. The IQS-610P-HS controller unit appears on top, with any connected IQS-610E-HS expansion unit underneath.

Using the IQS Manager Interface

Accessing Current Modules

The name, current status and serial number of each module installed on the unit you have selected in the system tree appear besides the module's icon.

- A green icon means that the module is ready for you to use.
- A yellow icon means that your module is in use.
- If the icon bears a question mark, your controller or expansion unit does not recognize the module you have installed.

The function buttons section allows you to perform tasks on the modules currently in your system such as starting a single-module application.

Status Bar

The status bar, located at the bottom of the main window, identifies the operational status of the IQS-600 Integrated Qualification System.

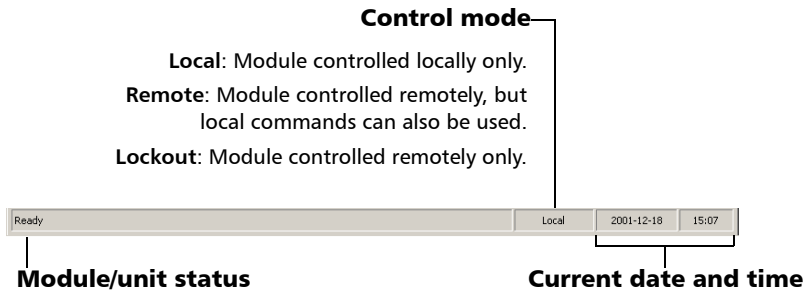

For more information about automating or remotely controlling the IQS-600 Integrated Qualification System, see the corresponding sections in this user guide.

If you are currently in **Remote** mode and wish to revert to **Local** mode, press on the LOCAL button on the front of your controller unit.

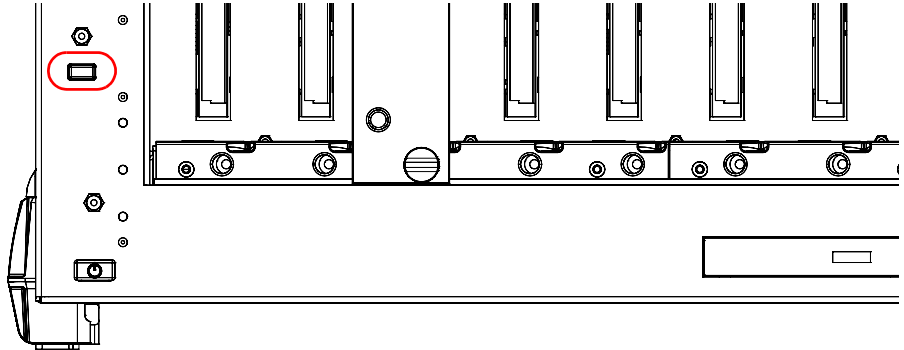

This button is ineffective if you are in **Lockout** mode.

For detailed instructions on how to start the single-module application related to your specific IQS module, refer to the corresponding user guide.

Using the IQS Manager Interface

Accessing Integrated Applications

Accessing Integrated Applications

The **Integrated Applications** function tab is where you can start applications requiring or affecting more than one module at the same time.

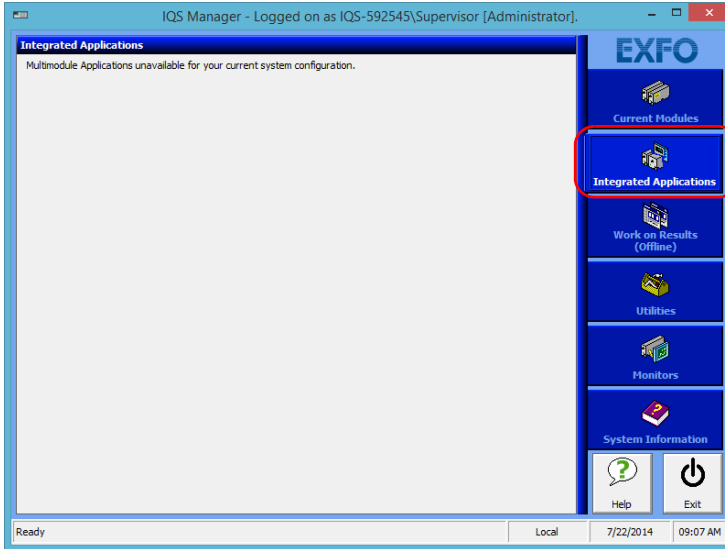

The multimodule applications allow you to control several modules of *the same kind* through a single interface. It is particularly useful to synchronize similar modules in larger systems.

Note: *The display varies depending on which modules are installed in your controller or expansion units.*

For detailed instructions on how to operate the multimodule application of your IQS module, refer to the user guide for your system.

Working on Test Results (Offline Mode)

Your IQS-600 Integrated Qualification System includes an application for data processing. This can be accessed through the **Work on Results (Offline)** function tab. It allows you to perform jobs on acquisitions or tests that have already been taken. This is also known as *Offline* mode.

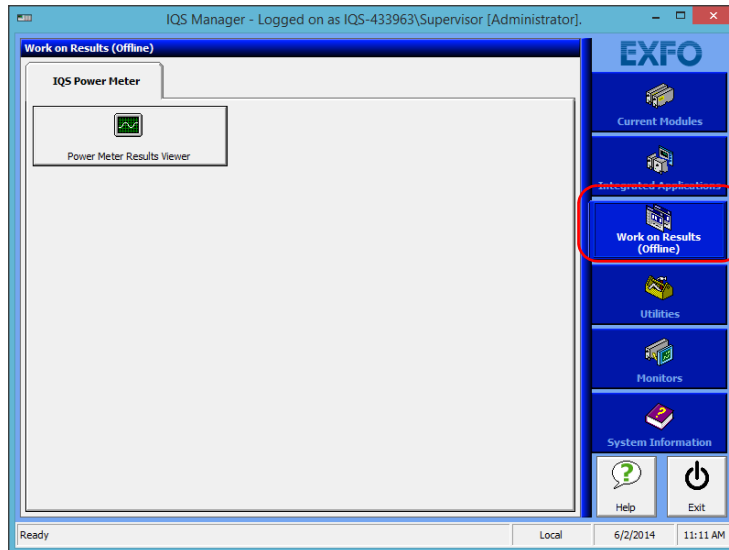

Each module has its own tab, which contains related applications. It is not necessary for the module to be physically inside the controller or expansion unit, but the corresponding software must be installed.

For more information about installing and updating IQS Manager, see *Installing or Upgrading the Applications* on page 46.

Note: *You cannot perform acquisitions or tests in this mode. You must use either the **Current Modules** or the **Integrated Applications** function tabs.*

Creating an Integrated Data Display

Note: This feature is not available in Offline mode.

When using one or more IQS modules in a test setup, you can view module data and status using monitor windows in IQS Manager. To do so, select the **Monitors** function tab.

Monitor windows display basic data about modules. Using a combination of resizable monitor windows allows you to create an integrated data display.

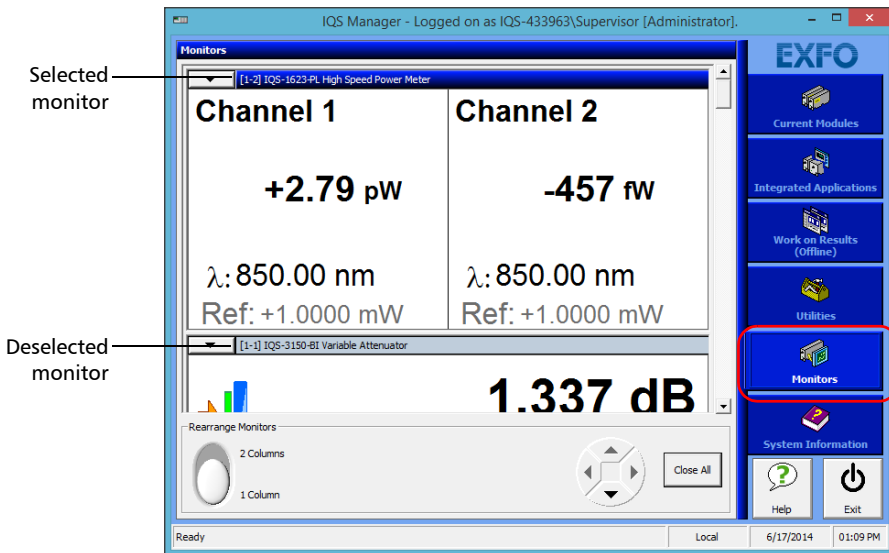

The **Monitors** function tab displays up to four complete monitor windows at a time, even if you are monitoring more than four applications.

You can customize the display so that the windows you need to see the most often are within easy view.

To move monitor windows:

1. To select the monitor window you want to move, click once on its title bar. The window title bar changes color to indicate that it is selected.
2. Move the monitor window using the arrow buttons. The window either moves to the empty space in the chosen direction, or swaps with the window currently there.

You can also display only one column of monitor windows instead of two by using the button located on the lower left-hand corner of the window.

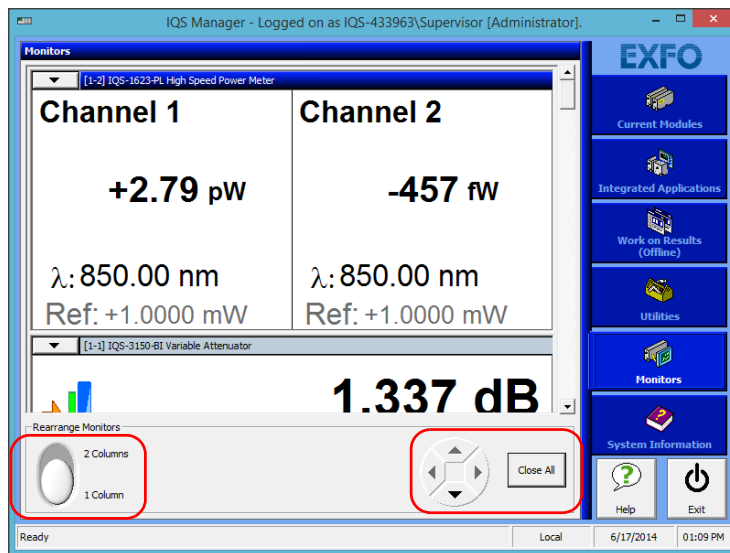

If you want to close all monitor windows, use the **Close All** button located on the lower right-hand part of the **Monitors** function tab.

Note: Closing all monitor windows using the **Close All** button does not close the corresponding module applications.

For instructions on how to use the monitor window features of your IQS module, refer to the module's user guide.

Viewing PDF Files

You can view PDF files directly from your unit using the SumatraPDF reader. For more information on the available features for this reader, refer to the SumatraPDF online help.

To view PDF files:

1. From the **Utilities** function tab, select **Windows Explorer**.

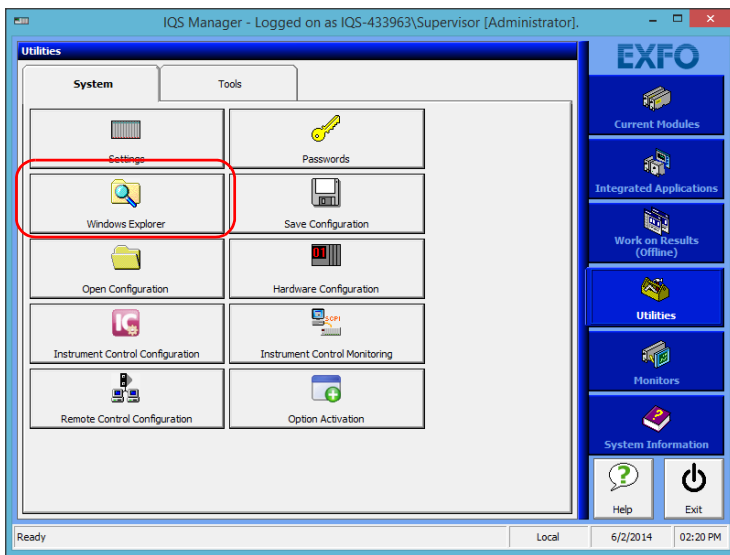

2. Browse through the folders to find the desired PDF file.
3. Double-click the file.
4. The file opens automatically in the SumatraPDF application.

Note: You can access the online help directly from the **Help** menu of the SumatraPDF application. You will need a connection to the Internet to view the online help.

Locating Units

Note: This feature is not available in Offline mode.

Since you can connect many IQS-610E-HS expansion units to your IQS-610P-HS controller unit, it may become difficult to find a particular module.

To help you locate units, click **Locate Unit** in the **Current Modules** function tab. The corresponding module position display blinks for ten seconds, allowing you to locate your module.

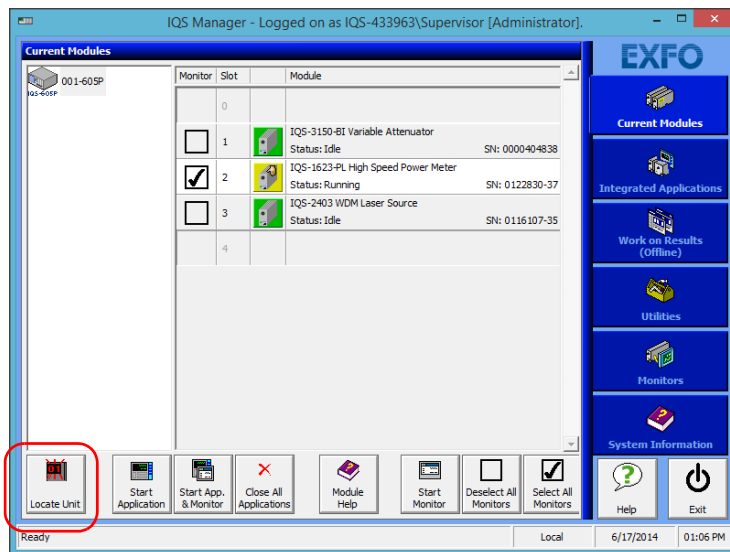

The first two digits indicate its position in the chain, while the third digit indicates the unit's number. You can personalize the unit numbers as explained in *Changing Unit and Module Identification* on page 95.

Using the IQS Manager Interface

Accessing Utilities from IQS Manager

Accessing Utilities from IQS Manager

Various utilities are located on the **Utilities** function tab.

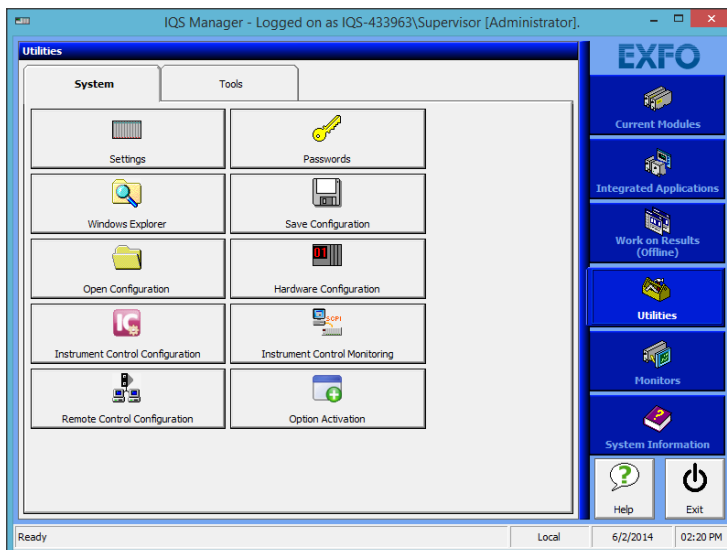

Accessing Utilities from Windows

Your unit comes with free tools such as Wireshark to help you troubleshoot networks. For more information, refer to the online help provided with these tools.

To access Windows utilities other than Windows Explorer and the provided tools, do so directly from Windows in the  menu.

6 Accessing your IQS-600 Remotely

You can access your unit remotely from a computer using either the Remote Desktop Connection or TightVNC Client applications.

This could be particularly useful if you do not intend to perform automation tasks on your platform. If you want to perform automation tasks on your platform and modules, see *Using IQS Products in an Automated Test Environment* on page 175.

The table below presents the differences between the Remote Desktop Connection and TightVNC Client applications.

Characteristic	Remote Desktop Connection	TightVNC Client
Connection type	Direct between the unit and the computer; only one user can be connected to the unit at a time.	Not exclusive; several users can be connected to the unit at the same time (sharing the same session).
Windows user rights	Taken into account.	Not taken into account.
Password-protected	Yes; mandatory. The user name and password are the same as those used to connect to the unit. By default, all of the accounts with administrator and supervisor rights can use Remote Desktop Connection. If you want the operators to be able to use Remote Desktop, you must specifically grant them access rights.	Yes; mandatory. The password is defined on the TightVNC Server, the first time you start the server. This password is not related to the one used to connect to the unit. By default, all people that use TightVNC Client will enter the same password (as defined on the server). Each user to whom you provide the password will be able to connect to the unit via TightVNC.

Working with Remote Desktop

By default, all the accounts with administrator rights can use Remote Desktop. If you want accounts with limited rights to be able to use Remote Desktop as well, you must specifically grant them access.

You can also configure the unit to prevent users from accessing it remotely.

Accessing Your Unit with Remote Desktop

To be able to connect to the unit using Remote Desktop, you must:

- Know the IP address of the unit and provide it in the connection settings on the computer.
- Use an account that is secured by a password. Remote Desktop will not allow any connection with empty passwords.
- Enter the appropriate user name when Remote Desktop application prompts you. Usually, this user name must correspond to the user name of the person currently logged on the unit. Otherwise, you will disconnect the person that was already connected.

To access your IQS-600 remotely:

- 1.** Connect both the computer and your unit to the same network and make sure they can “see” each other as network restrictions might prevent them from communicating.
- 2.** Turn on both the computer and the unit.
- 3.** On the taskbar of the computer, click the start () button, then under **Windows Accessories**, select **Remote Desktop Connection**.
- 4.** In the **Connecting to Remote Desktop** window, in the **Computer** list, type the TCP/IP address of the unit you want to access.

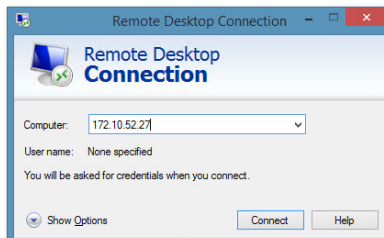

- 5.** Click **Connect**.
- 6.** When the application prompts you, enter your user name and password.
- 7.** Click **OK** to start the session.

Accessing your IQS-600 Remotely

Allowing User with Limited Accounts to Use Remote Desktop

Allowing User with Limited Accounts to Use Remote Desktop

By default, only the accounts with administrator rights can use Remote Desktop. However, you can assign extra user rights to accounts with limited rights so that they can also use Remote Desktop.

To allow an operator to access the Remote Desktop Connection:

1. From the Windows Desktop, right-click on the Start () button, then select **Control Panel**.
2. Select **System and Security**

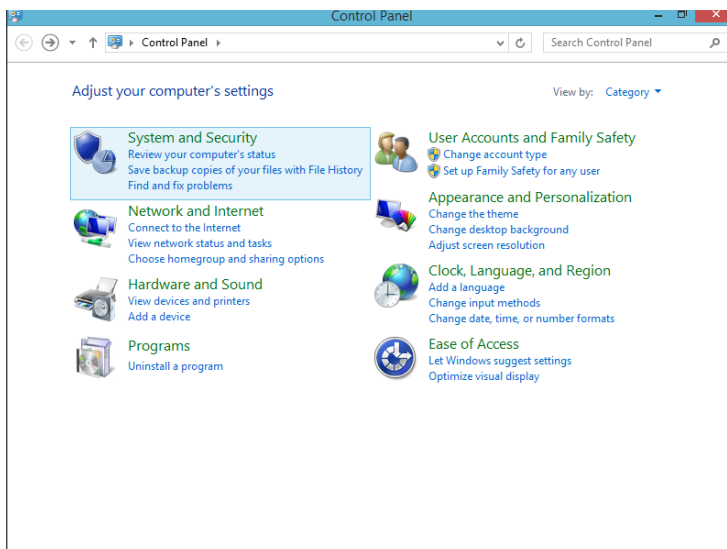

3. Under **System**, select **Allow remote access**.

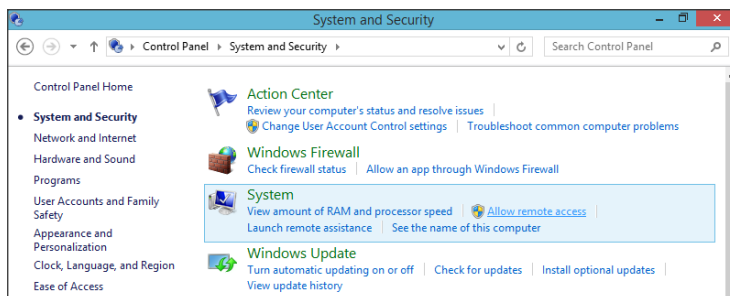

4. Under **Remote Desktop**, select **Allow remote connections to this computer**.

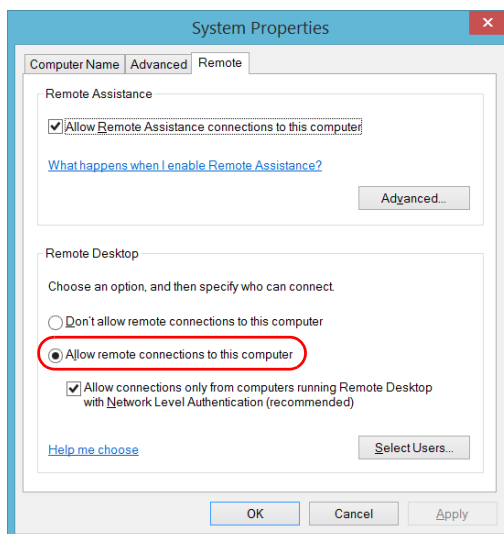

5. Click **Select Users**.

Accessing your IQS-600 Remotely

Allowing User with Limited Accounts to Use Remote Desktop

6. From the **Remote Desktop Users** dialog box, click **Add**.

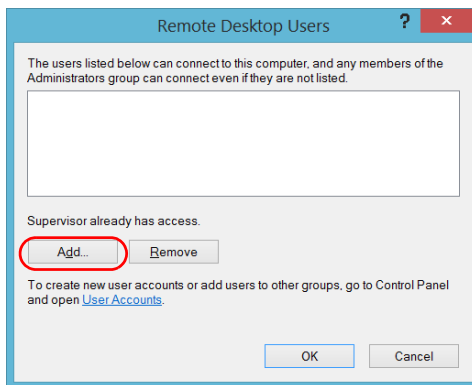

7. From the **Select Users** dialog box, click **Advanced**.

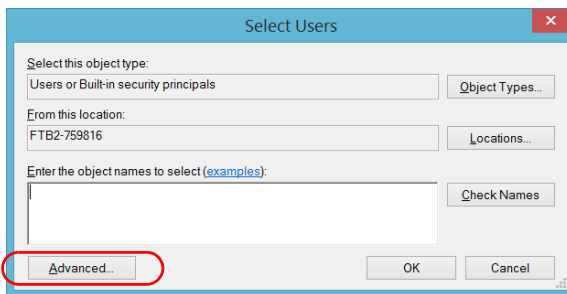

Accessing your IQS-600 Remotely

Allowing User with Limited Accounts to Use Remote Desktop

8. Click **Find Now** to let the system find and display the list of users.

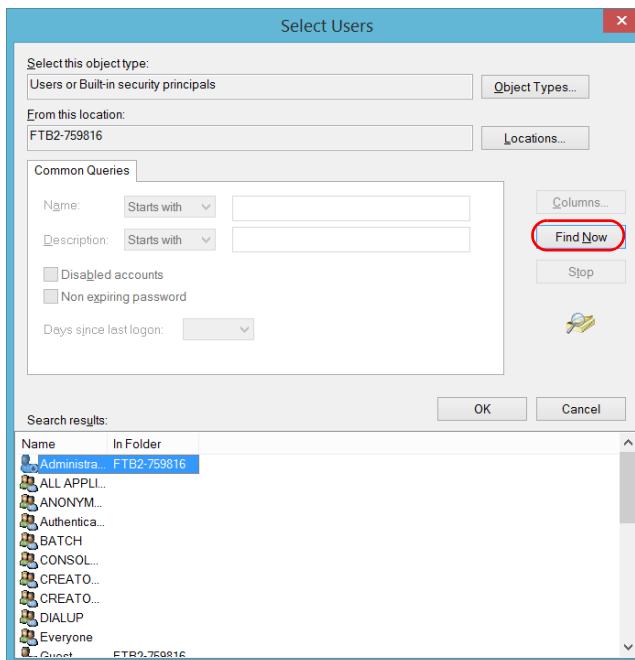

9. Select the user to which you want to grant access rights, and then click **OK**.

Accessing your IQS-600 Remotely

Allowing User with Limited Accounts to Use Remote Desktop

10. From the list of users, select the user that you have just added, and then click **OK**.

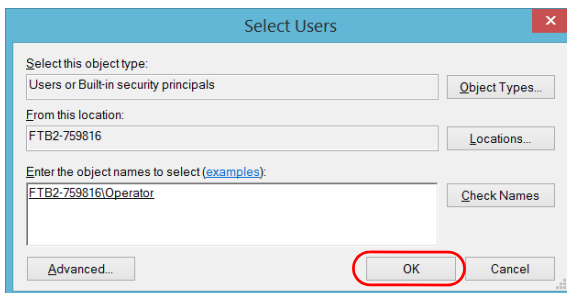

11. Repeat steps 8 to 10 with all the users to which you want to grant access rights.
12. From the **Remote Desktop Users** dialog box, click **OK**.
13. From the **System Properties** dialog box, click **OK** to confirm the changes and return to the **System Settings** window.

Restarting or Turning Off Your Unit While Working with Remote Desktop

In some cases, you may need to restart or shutdown your unit while you are controlling it remotely.

To restart or turn off your unit with Remote Desktop:

1. Close all applications, including IQS Manager.
2. On the taskbar of the computer, click the start () button, then under **Windows System**, select **Run**.
3. If you want to restart your unit, in the **Open** box, enter *Shutdown -r*.

OR

If you want to turn off your unit, in the **Open** box, enter *Shutdown -s*.

Working with TightVNC

The control of your unit with TightVNC requires the TightVNC Server (already installed on your unit) and the TightVNC Client Viewer (that you must install on your computer).

The first time you start the TightVNC Server on your unit, the application will prompt you to define passwords. Once these passwords are defined, you are now ready to connect to your unit using the TightVNC Client (on your computer).



CAUTION

Be very careful if you use TightVNC to transfer files between a computer and your unit (TightVNC Server).

- *Transfer from a computer to your unit:* If the transfer is interrupted, all files on your unit having the same name as those on the computer **WILL BE DELETED**. However, the files on the computer will remain available.
- *Transfer from your unit to a computer:* If the transfer is interrupted, all files on the computer having the same name as those on your unit **WILL BE DELETED**. However, the files on your unit will remain available.

To be able to connect to the unit using TightVNC, you must:



- Know the IP address of the unit and provide it in the connection settings on the computer.
- Know the password (same for all users by default).

This section provides you with the basic information to control your unit with TightVNC. For more information, refer to the TightVNC online help.

Configuring the TightVNC Server

The TightVNC Server is already installed on your unit. You must configure passwords before establishing a connection between a computer and your unit.

To configure the TightVNC Server:

1. On the taskbar of the computer, click the start () button, then under **Tight VNC**, select **Run TightVNC Server**.
2. On the taskbar, click the  icon to access the configuration window.
3. Under the **Incoming Viewer Connections**, select **Accept incoming connections**, and adjust the main server port as needed.

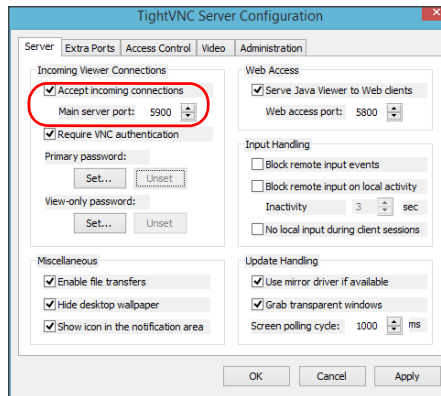

Accessing your IQS-600 Remotely

Working with TightVNC

4. To require a password from both the primary users and the view-only users, click **Set**, then enter and confirm the appropriate passwords.

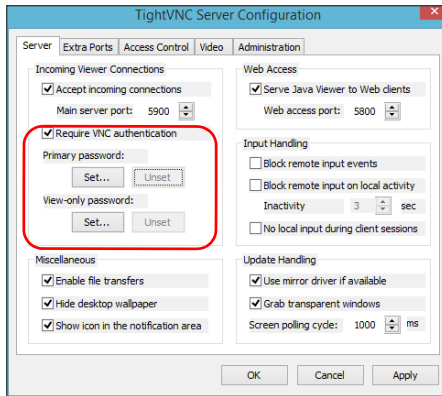

Note: *The two passwords are independent of each other. They do not have to be identical.*

5. Click **Apply**, and then **OK**.



IMPORTANT

Once the VNC server is installed and configured, you should use the same network adaptor and not change it if you reconnect it. The VNC server must use the same network adaptor on the platform to be able to operate properly.

Using the TightVNC Viewer

The TightVNC Viewer is used to control another computer or the IQS-600. It is already installed on your unit. However, if you need to install it on another computer or unit, download it from the TightVNC Web site.

Note: *EXFO recommends to make a shortcut on your desktop once your TightVNC Viewer is downloaded.*

To start the TightVNC Viewer on a computer or unit:

1. On the taskbar of the computer, click the start () button, then under **Tight VNC**, select **TightVNC Viewer**.
2. In the **Remote Host** list, type the IP address of the unit you want to connect to.

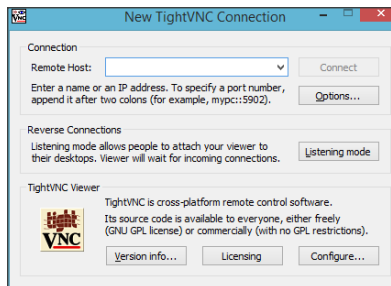

3. Click **Connect**.

Accessing your IQS-600 Remotely

Working with TightVNC

Using a Web Server as a Viewer

You can access to the TightVNC Server via a Web browser such as Microsoft Internet Explorer.

The TightVNC server contains a small Web server. When you connect to it by using your Internet search engine, the Java applet for the viewer is downloaded automatically. It allows you to access the remote desktop.



IMPORTANT

Your Web browser must support Java applets. In addition, you should not use a proxy in order to let the java applets access the remote server directly.

To connect remotely by using a Web browser:

1. From the computer Web browser, enter an appropriate IP address, following the example below:

http://172.16.76.20:5800

colon
|
TCP port
|
IP Address

2. In the **VNC Authentication** dialog box, in the **Password** box, type your password.

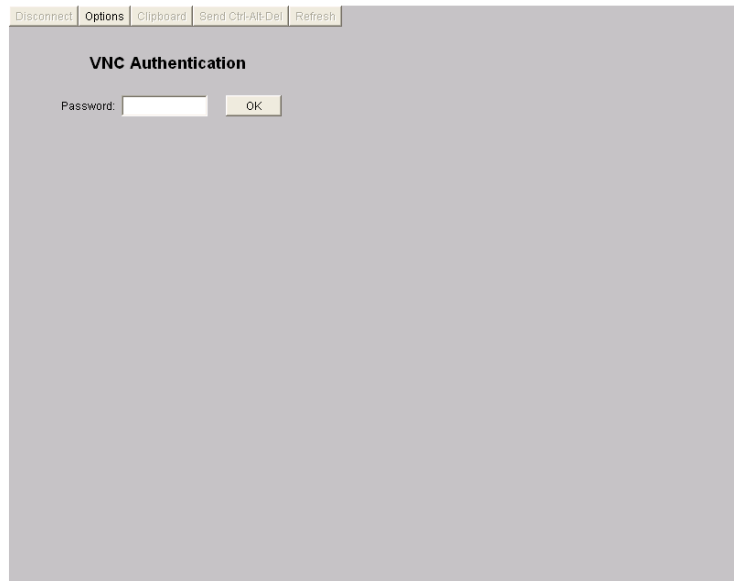

www.TightVNC.com

3. Click **OK** to access the IQS-600.

7 *Preparing for Automation*

The IQS-600 Integrated Qualification System was designed to meet the requirements of automation and to facilitate its integration with your test environment.

An IQS-600 Integrated Qualification System always requires a controller unit (IQS-605P-HS or IQS-610P-HS) to drive the instruments (optical as well as Transport and Datacom).

Since IQS controller units are built around an Intel processor and are based on Windows architecture, such a controller can:

- act as the system controller of an automated test setup (possibly including third-party instruments)
- control another IQS-600 controller over an Ethernet network
- act as a PXI controller (by integrating special third-party PCI cards)

Preparing for Automation

EXFO supplies commands that follow the guidelines determined by the SCPI consortium and LabVIEW drivers for all available instruments. EXFO also supplies COM properties and events allowing you to build your own application. The instruments can be controlled either locally or remotely via the following technologies:

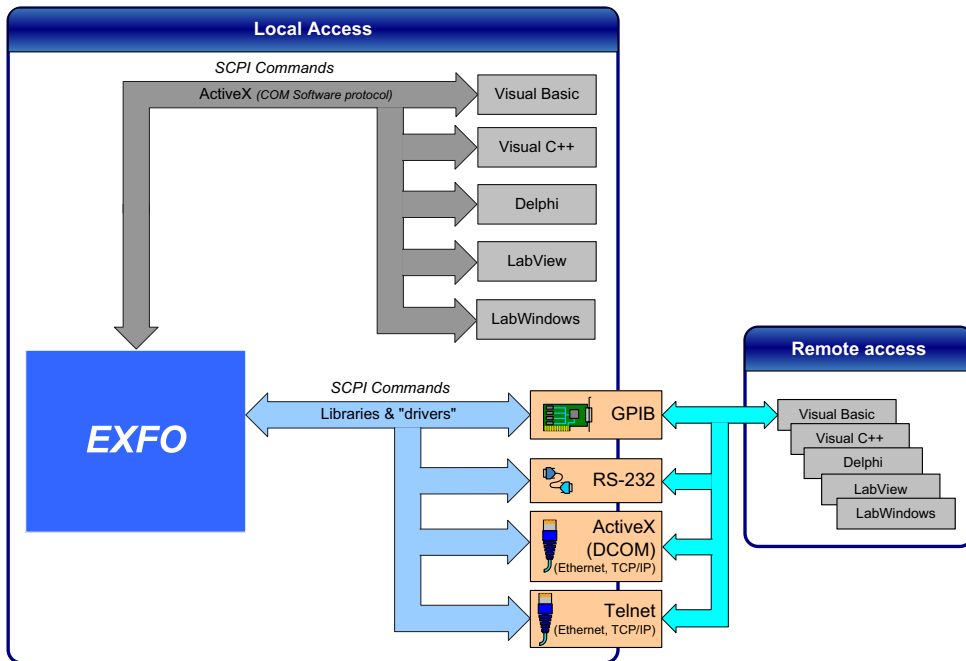

The choice of a technology depends on your particular needs.

Control	Technology	Characteristics
Local	ActiveX (COM)	<ul style="list-style-type: none"> ➤ Allows you to develop an application that will run locally on the IQS controller unit within Windows ➤ Best approach when speed is your top priority (no physical connection that slows down the process) ➤ Supported by most development software ➤ Lower cost
Remote	ActiveX (DCOM) (Ethernet, TCP/IP)	<ul style="list-style-type: none"> ➤ IQS controller unit can be directly connected to a Local Area Network (LAN) or Wide Area Network (WAN) via its 10/100/1000 Base-T interface ➤ No need for a GPIB card ➤ Allows the sharing of network resources ➤ Allows you to develop computer-based applications to directly communicate with the IQS controller unit
Remote	GPIB	<ul style="list-style-type: none"> ➤ IQS controller unit must be equipped with the GPIB option ➤ IQS controller unit can be used as a device in a GPIB chain (it meets the IEEE 488.2 standard) ➤ A single GPIB address allows you to control up to 100 logical optical instruments ➤ Most commonly used interface to simultaneously control many instruments
Remote	RS-232	<ul style="list-style-type: none"> ➤ Null-modem cable required to establish connection between the computer and the IQS controller unit ➤ For increased speed and performance, run the application locally on the IQS controller unit through ActiveX instead of using RS-232

Preparing for Automation

Control	Technology	Characteristics
Remote	Telnet (Ethernet, TCP/IP)	<ul style="list-style-type: none"><li data-bbox="505 264 1145 358">▶ IQS controller unit can be directly connected to a Local Area Network (LAN) or Wide Area Network (WAN) via its 10/100/1000 Base-T interface<li data-bbox="505 367 844 399">▶ No need for a GPIB card<li data-bbox="505 407 1032 440">▶ Allows the sharing of network resources<li data-bbox="505 448 1130 542">▶ Allows you to develop computer-based applications very easily to directly communicate with the IQS controller unit

For more information on programming aspects, see the section on using your product in an automated test environment.

Configuring Your Integrated Qualification System for Working with GPIB

If you have purchased the corresponding option, your IQS-600 is equipped with a GPIB card, and the drivers and software are installed by default. Your unit can both be used as a controller or a device.

Should you need to reinstall the corresponding drivers and software, you can do so easily through the National Instrument Web site.



IMPORTANT

Do not remove the GPIB card from the IQS controller unit.



IMPORTANT

If you have not previously selected the GPIB option and now wish to purchase a GPIB card, contact EXFO. Purchasing your new GPIB card from EXFO will ensure compatibility with your IQS-600.

Preparing for Automation

Configuring Your Integrated Qualification System for Working with GPIB

To install the GPIB software and drivers for your GPIB card:

1. Go on the National Instrument Web site at the following location <http://www.ni.com/download/ni-488.2-3.1.2/4360/en/>, and download the installation kit.
2. Double-click on the executable file you have downloaded to start the installation process. Confirm that the archive will create the installation image by clicking **OK**.

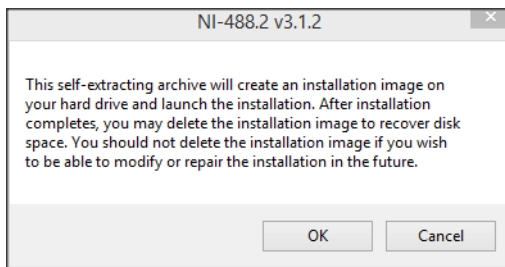

3. Click **Unzip** to extract the files to the indicated location.

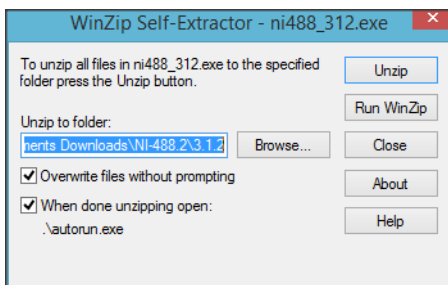

4. In the installation wizard Welcome window, select **Install Software**. Confirm that you want to proceed with the installation by clicking **Yes**.



5. Confirm the location where the software will be installed. EXFO recommends that you do not change the location. Click **Next** to continue.

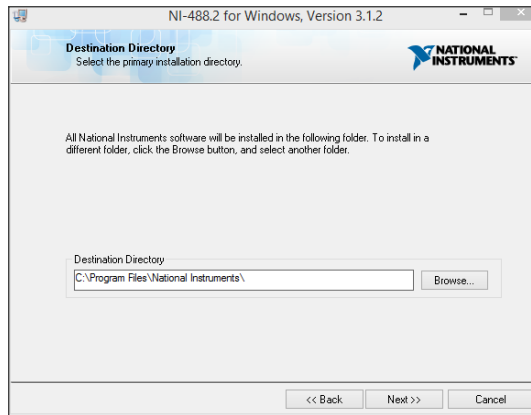

Preparing for Automation

Configuring Your Integrated Qualification System for Working with GPIB

6. Confirm which items will be installed on your unit. EXFO recommends that you do not change the list. Click **Next** to continue.

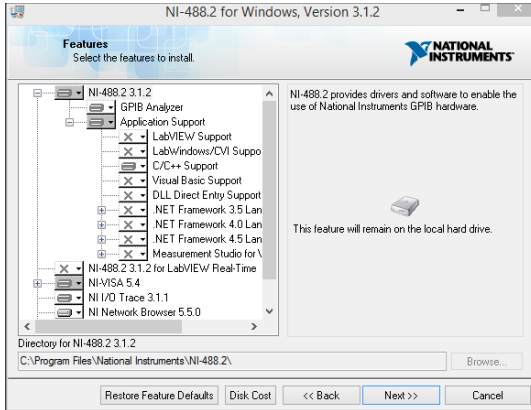

7. If you want to look for updates for your software, you can have the wizard search the National Instruments site at this point. This step is optional. Click **Next** to proceed.

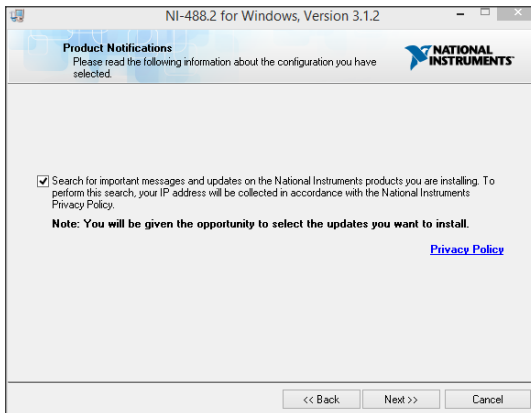

8. Read the license agreement, then confirm that you accept the terms; click **Next** to continue.

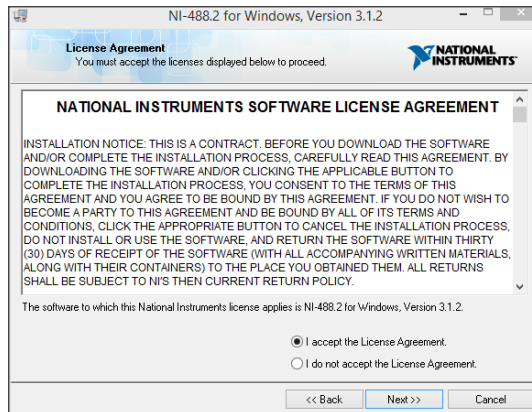

9. Review which items will be installed or updated, then click **Next** to start the installation. Once the installation is complete, click **Next** again to proceed with the registration process.

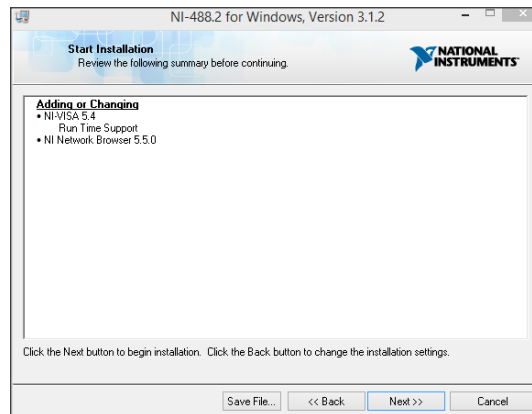

Preparing for Automation

Configuring Your Integrated Qualification System for Working with GPIB

10. If you already have a user profile at National Instruments, you can use it to register your product directly from the Web. Otherwise, select the option to register your product without an NI profile. Click **Next** to continue.

National Instruments Registration Wizard

NI Product Registration

Please register my NI products to receive:

- Important product and driver updates
- Calibration reminders to keep my hardware in compliance
- Notifications about warranty expiration
- Simplified asset management for all my NI products on ni.com

Register using my ni.com User Profile
Allows immediate access to ni.com asset management

Username: [Create a User Profile online](#)

Password: [Forgot your password?](#)

Register without using an ni.com User Profile

<< Back Next >> Cancel

11. If you have selected to register without a profile, enter your information in the corresponding boxes.

National Instruments Registration Wizard

NI Product Registration

Please provide the following information.

First Name*:

Last Name*:

Company*:

Email*:

Country*:

Address*:

City*:

State*:

Zip Code*:

Phone:

* Required field

<< Back Next >> Cancel

12. Select which items you want registered. Click **Register** to confirm your choice.

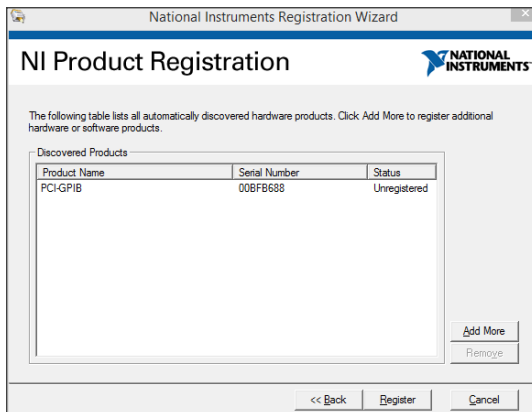

13. Once the registration is complete, click **Finish** to close the wizard.

Preparing Hardware for GPIB Control

If you intend to use GPIB to remotely control your instruments, your controller must have been equipped with the optional GPIB card.

To ensure the optimum efficiency of your system, EXFO recommends that you follow these restrictions:

For the IEEE 488.1 protocol:

- Maximum of 15 devices physically connected to each GPIB bus.
- Maximum separation of 4 m between two devices and an average separation of 2 m over the entire range (bus).
- Maximum total cable length used in the system is 20 m.
- At least two-thirds of the connected devices must be turned on.

For the HS488 protocol:

- Maximum of 15 devices physically connected to each GPIB bus.
- Maximum total cable length used in the system is 15 m (that is, 1 m per device physically connected to the GPIB bus).
- All connected devices must be turned on.
- For each meter of cable used in the system, there must be a device connected to it or an equivalent device load.

The IQS-600 Integrated Qualification System configuration complies with the IEEE 488.1 (also known as IEC60625.1) and the IEEE 488.2 (also known as IEC60625.2) standards to the extent shown in the following table.

Mnemonic	Function
SHE1 ^a	Complete source handshake extended capability
AHE1 ^b	Complete acceptor handshake extended capability
T6	Basic talker with serial poll; unaddressed to talk if addressed to listen
L4	Basic listener; unaddressed to listen if addressed to talk
SR1	Complete service request capability
RL2	No local lockout capability
PP0	No parallel poll capability
DC1	Complete Device Clear capability
DT0	No Device Trigger capability
C0	No controller capability
E2	Three-state driver capability

- a. SHE1 corresponds to the extended capability of SH1, defined in the IEEE 488.1 standard. This extended capability is made possible by the device capability to use the HS488 high-speed protocol.
- b. AHE1 corresponds to the extended capability of AH1, defined in the IEEE 488.1 standard. This extended capability is made possible by the device capability to use the HS488 high-speed protocol.

Preparing for Automation

Linking Units with the GPIB Port

Linking Units with the GPIB Port

If your IQS-600 Integrated Qualification System is equipped with a GPIB card, use the provided cable to link it to the other unit with which you want to perform remote control. For more information about your GPIB card, refer to the documentation provided with it.

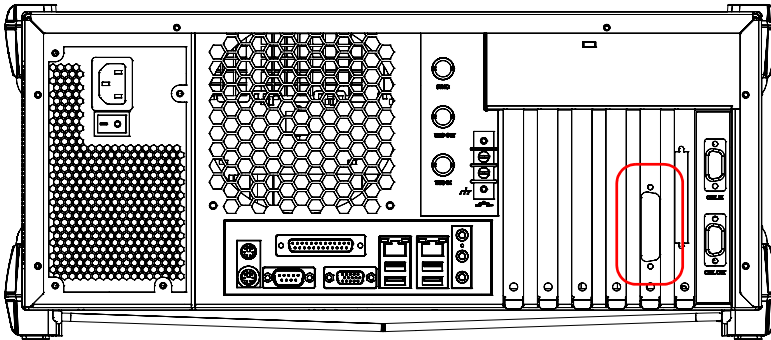

Linking Units with the Ethernet Port

Your IQS-600 Integrated Qualification System is equipped with an Ethernet port to send and receive data. Refer to the Windows documentation for information about Ethernet port settings and possibilities.

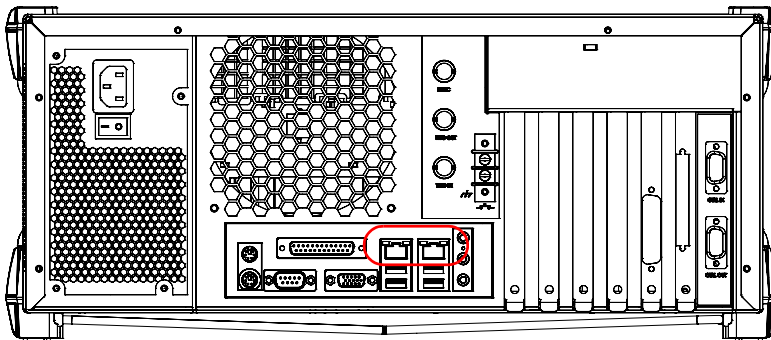

Linking Units with the Serial Port

Your IQS-600 Integrated Qualification System is equipped with a serial (RS-232) port to send and receive data. Refer to the Microsoft Windows documentation for information about serial port settings and possibilities.

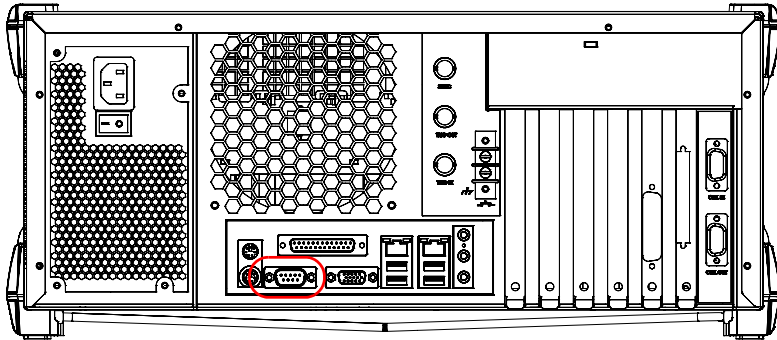

Getting Optimum Performance from Your Integrated Qualification System

Several factors influence the data transfer rate of an IQS controller unit. The information presented hereafter will help you get the best transfer rate possible.

- *Protocol (GPIB control only):* You can use the IEEE 488.1 (standard) or the HS488 (high-speed) protocol. Both protocols can co-exist in the same system; communication between devices can then be achieved using the IEEE 488.1 protocol.

HS488 is a non-interlocked handshake protocol that allows data transmission between devices at higher rates (six to seven times faster for small systems) than those possible with the IEEE 488.1 protocol. Higher transfer rates are particularly interesting in systems containing devices that return long data blocks. However, the transfer rate is affected by the physical limitations of the cables used in the system.

Preparing for Automation

Getting Optimum Performance from Your Integrated Qualification System

For information on cabling, see *Preparing Hardware for GPIB Control* on page 136.

- *Bus timing (GPIB control only)*: Required if you intend to work with IEEE 488.1, for it affects the handshake rate of this protocol. It indicates the minimum amount of time a GPIB controller waits, once data is placed on the bus, before setting the data valid bus line (DAV) to true.

The possible bus timings are:

Mode	Bus timing delay
Normal	1100 ns
High speed	500 ns
Very high speed	350 ns

If your setup supports it, select the very-high-speed timing to get the best performance.

- *Output unit (GPIB, RS-232, ActiveX and TCP/IP)*: The IQS controller unit can return results in
 - linear units (for example, watts)
 - log units (for example, dBm)

Since internal units are linear, you will get optimal performance by using linear units for output (no need for an internal conversion to log).

Note: *You must make the choice of output unit for each instrument offering such a feature. Refer to the user guide of each optical instrument for a list of available commands and queries.*

- *Output format (GPIB, RS-232, ActiveX and TCP/IP):* The IQS controller unit provides the following output formats for measurement results:
 - ASCII
 - PACKed

Generally, the PACKed format allows to pass three to four times more information than the ASCII format for the same transfer rate. Often, the PACKed format is also more efficient since it reduces the IQS controller unit's CPU work load (no need for an internal conversion to ASCII format).

Note: *The PACKed format will only be applied to <DEFINITE LENGTH ARBITRARY BLOCK RESPONSE DATA> and <INDEFINITE LENGTH ARBITRARY BLOCK RESPONSE DATA>.*

Note: *The choice of data format cannot be made directly via the IQS Managersoftware.*

For more information on how to set the output format and data types, see *:FORMat[:DATA](IEEE 488.2 and specific commands appendix)*, *Read* and *ReadBinary* (COM properties and events appendix), and the data types appendix.

Changing Communication Settings

Communication settings cannot be modified without turning on your IQS-600 Integrated Qualification System and starting IQS Manager.

To change communication settings:

1. From the **Utilities** function tab, select **Instrument Control Configuration**.

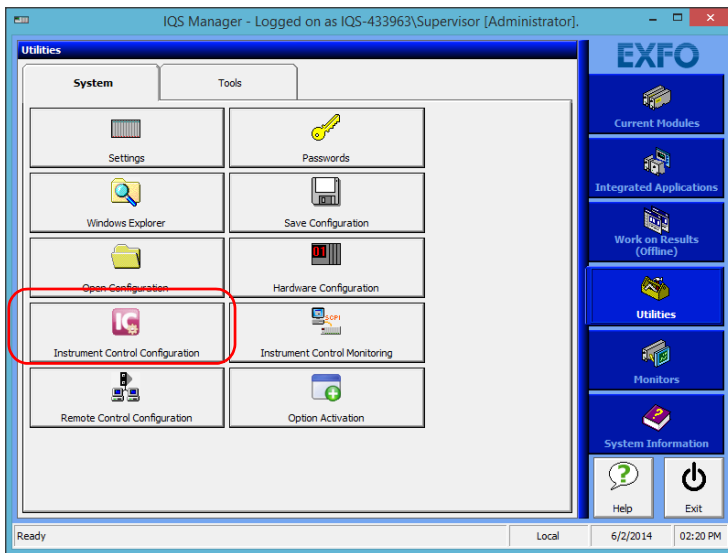

2. Click **Change settings**, and then, when the application prompts you to authorize the changes to your unit (identified as “computer”), click **Yes**.

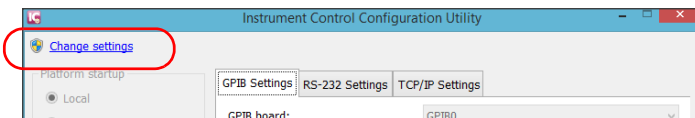

- Under **Platform Startup**, determine whether your module applications will be started locally or remotely by clicking the corresponding option.
 - If **Local** mode is selected, you will not be able to send remote commands to your IQS controller or expansion units.
 - If **Remote** mode is selected, all modules in your IQS controller and expansion units will be initialized upon startup so you are ready to send remote commands.

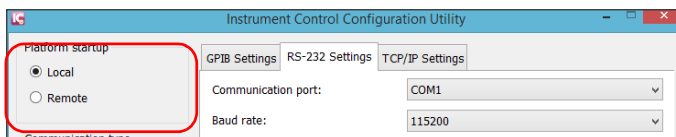

If you selected **Local** mode, you can go directly to step 6.

- Under **Communication Type**, select **GPIB**, **ActiveX**, **RS-232**, or **TCP/IP**.

For more information on the choice of a particular type, see the table on page 126.

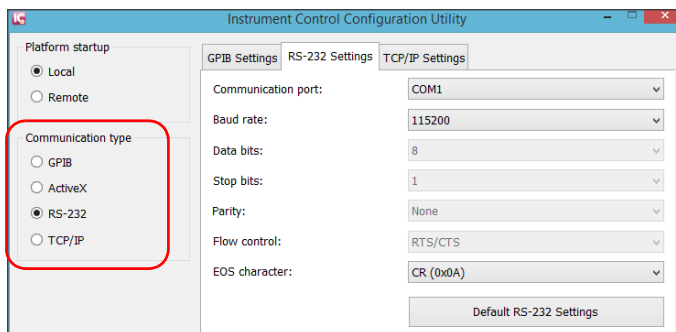

Note: *If the selected communication type does not match the protocol that will actually be used, an error message is displayed when attempting to control the instruments.*

Preparing for Automation

Changing Communication Settings

5. According to the communication type you have selected, customize the corresponding parameters as shown below.

➤ For GPIB

The selected address must not already be used by the GPIB bus controller or any other device connected to the GPIB bus. Default value is 12.

IQS controller and expansion units can have up to four GPIB cards. Default value is GPIB0.

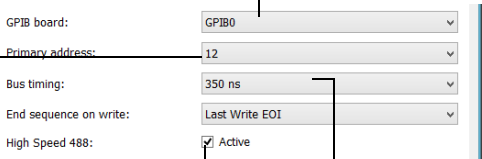

Annotations for the GPIB settings interface:

- Primary address:** 12
- Bus timing:** 350 ns
- End sequence on write:** Last Write EOI
- High Speed 488:** Active

Select the check box to enable the high-speed mode.

Bus timing (in ns)

For information on bus timing or on high-speed mode, see the section pertaining to obtaining an optimum performance from your unit.

➤ For RS-232

Serial port—used to connect the RS-232 cable.

Determines the speed at which data is sent between the unit and a computer, in bits per second (b/s).

End-of-string (EOS) character—used to indicate the end of a data string (when sending or receiving data).

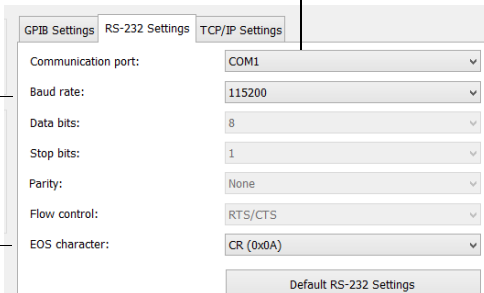

Annotations for the RS-232 settings interface:

- Communication port:** COM1
- Baud rate:** 115200
- Data bits:** 8
- Stop bits:** 1
- Parity:** None
- Flow control:** RTS/CTS
- EOS character:** CR (0x0A)

Default RS-232 Settings

➤ For TCP/IP

TCP/IP port 5024—used to connect over Telnet.

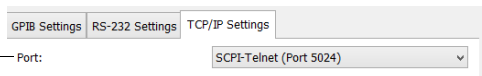

For information on communicating with TCP/IP over Telnet, see the section pertaining to communication through TCP/IP over Telnet.

6. Click **Apply** to confirm your changes.
7. To close the **Communication Settings** function tab, click **Exit**.

To revert to default general settings:

1. Click the **Restore Default Settings** button.

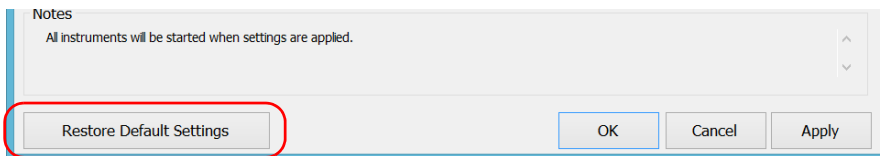

2. Click **Apply** to confirm your changes.

To revert to default GPIB settings:

1. Click the **Default GPIB Settings** button.

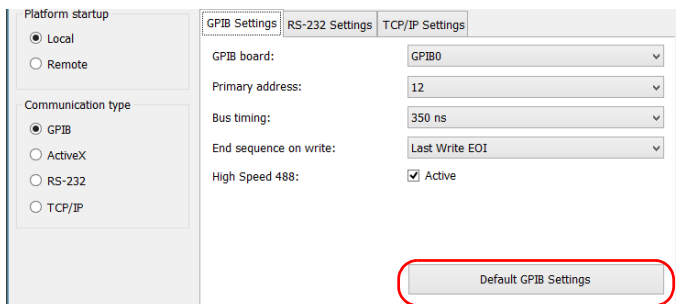

2. Click **Apply** to confirm your changes.

Preparing for Automation

Changing Communication Settings

To revert to default RS-232 settings:

1. Click the **Default RS-232 Settings** button.

The screenshot shows a dialog box for configuring communication settings. On the left, there are four radio buttons: GPIB, ActiveX, RS-232 (selected), and TCF/IP. The main area contains several dropdown menus: Data bits (8), Stop bits (1), Parity (None), Flow control (RTS/CTS), and EOS character (CR (0x0A)). A button labeled 'Default RS-232 Settings' is highlighted with a red circle. At the bottom, there are buttons for 'Restore Default Settings', 'OK', 'Cancel', and 'Apply'. A 'Notes' section is visible at the bottom left of the main area.

2. Click **Apply** to confirm your changes.

Configuring DCOM Access to Your Unit

DCOM technology allows to control devices and optical instruments via Ethernet. The EXFO IcSCPIAccess Class component provided with your IQS-600 Integrated Qualification System acts as a communication link between a client application and EXFO's Instrument Control.

DCOM ensures communication between the client application and Instrument Control via your local network. Since each network has its own configuration, you need to be familiar with network security, users, groups, domain management, etc. Basic programming skills are also required to work with DCOM. For more information, you can refer to the Microsoft MSDN Help feature, which provides exhaustive technical documentation on all DCOM issues.

The example presented in the following pages illustrates how to make the EXFO IcSCPIAccess Class component available to all users of a local network under Windows 8.1 Pro. The example provided below is for guidance only; it may not work properly with all networks and interfaces may slightly differ depending on the operating system used.

To enable DCOM access to your IQS-600 Integrated Qualification System, you must:

- set the general security parameters
- customize the specific security parameters
- register callback events.

Preparing for Automation

Configuring DCOM Access to Your Unit

Setting the General Security Parameters

Note: To modify the security parameters, you need administrator access rights.

To set the general security parameters:

1. Start Windows.
2. From the main window, click the **System Settings** button.
3. Click **Control Panel**.
4. Click **System and Security > Administrative Tools**.
5. Double-click **Component Services**.
6. In the **Component Services** dialog box, go to **Console Root > Component Services > Computers**.

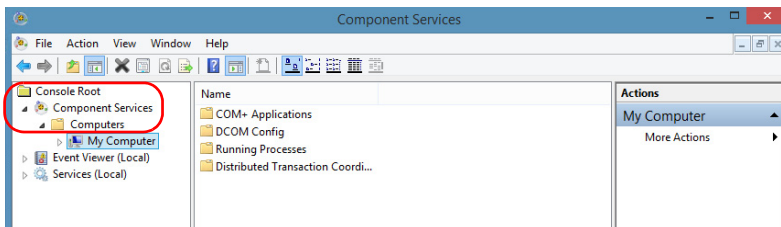

7. Right-click **My Computer**, and then select **Properties**.

8. In the **My Computer Properties** dialog box, click the **COM Security** tab.
9. Under **Access Permissions**, click **Edit Limits**.

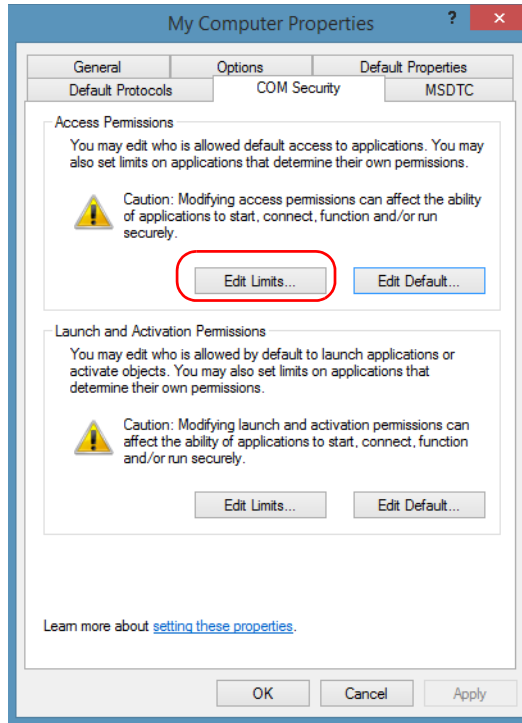

Preparing for Automation

Configuring DCOM Access to Your Unit

10. In the **Access Permission** dialog box, ensure that the **Distributed COM Users** appears in the **Group or user names** list.

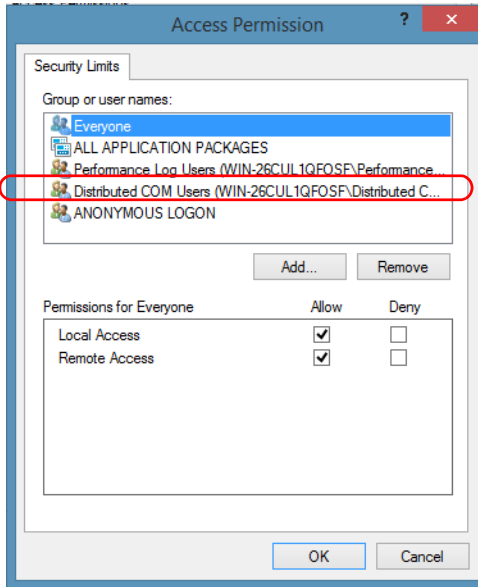

11. Click **OK**.
12. In the **My Computer Properties** dialog box, click the **COM Security** tab.

13. Under Launch and Activation Permissions, click Edit Limits.

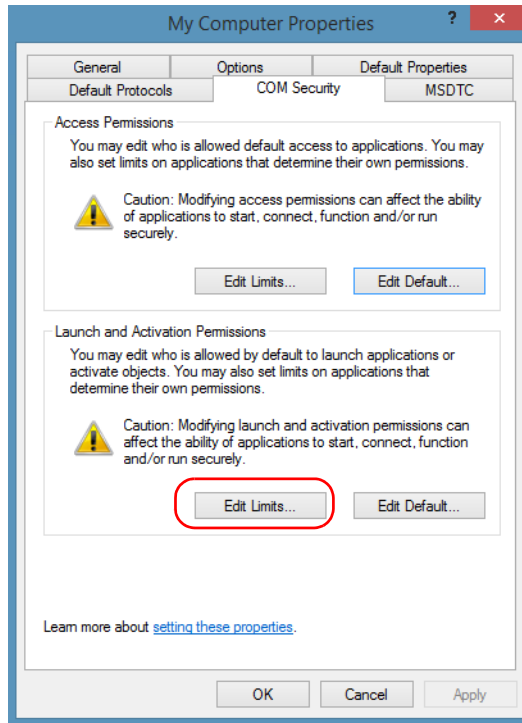

Preparing for Automation

Configuring DCOM Access to Your Unit

- 14.** In the **Access Permission** dialog box, ensure that the **Distributed COM Users** appears in the **Group or user names** list.

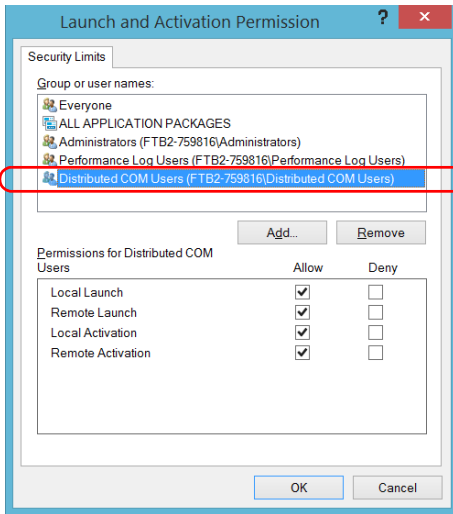

You can now allow users to access general DCOM services on your unit. You can either:

- Add a user to the **Distributed COM Users** group (refer to Microsoft help).
- OR
- Add a user explicitly and define both, access and launch permissions (see procedure below).

Note: *If you add a user explicitly, ensure to give remote access rights to the new user.*

To add a user explicitly:

1. In the **My Computer Properties** dialog box, click the **COM Security** tab.
2. Under **Access Permission**, click **Edit Limits**.
3. In the **Access Permission** dialog box, click **Add**.

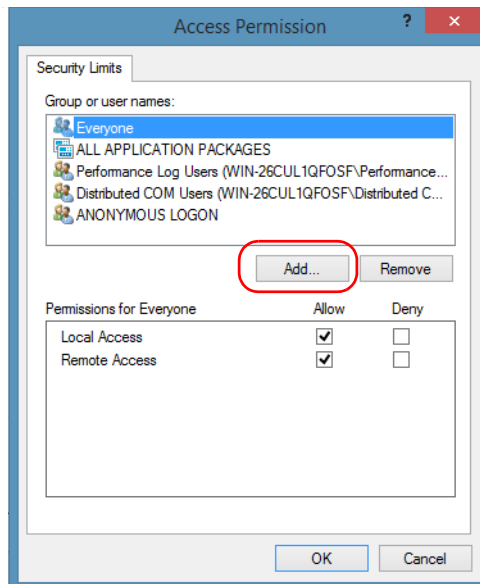

Preparing for Automation

Configuring DCOM Access to Your Unit

4. In the **Select Users or Groups** dialog box, under **Enter the object names to select**, type the name of the user to whom you want to give access rights.

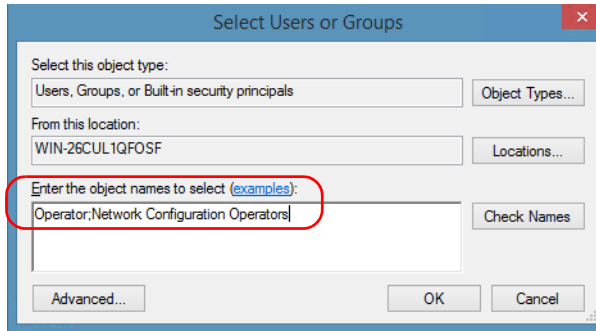

5. Click **OK**.

6. Confirm the newly added user has remote access permission as follows:
 - 6a. In the **Access Permission** dialog box, select the name of the new user.

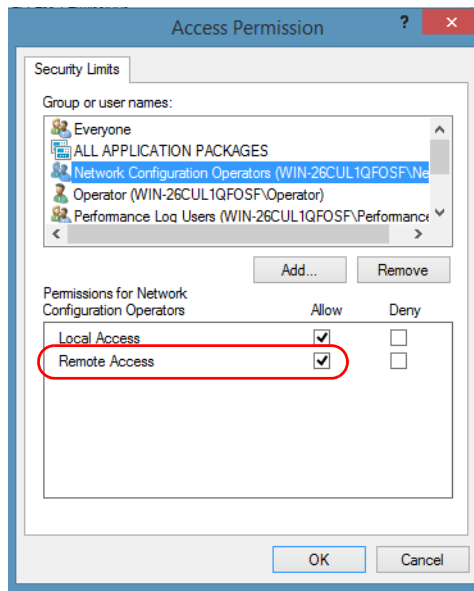

- 6b. Under **Permissions for** (new user), ensure **Allow** is selected for **Remote Access**.
 - 6c. Click **OK**.
7. In the **My Computer Properties** dialog box, click the **COM Security** tab.
8. Under **Launch and Activation Permissions**, click **Edit Limits**.

Preparing for Automation

Configuring DCOM Access to Your Unit

9. In the **Launch and Activation Permission** dialog box, click **Add**.

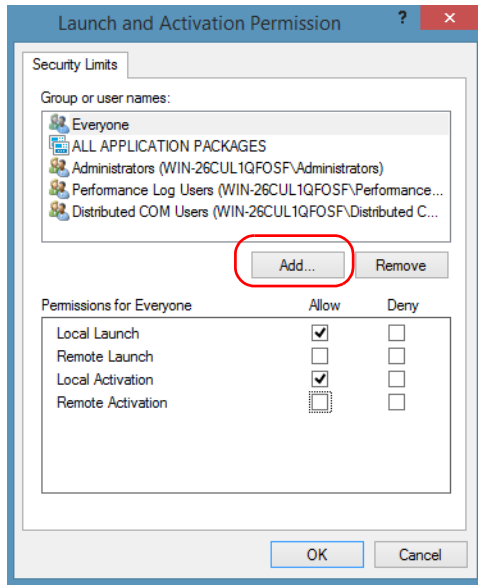

10. In the **Select Users or Groups** dialog box, under **Enter the object names to select**, type the name of the user to whom you want to give start and activation access rights.

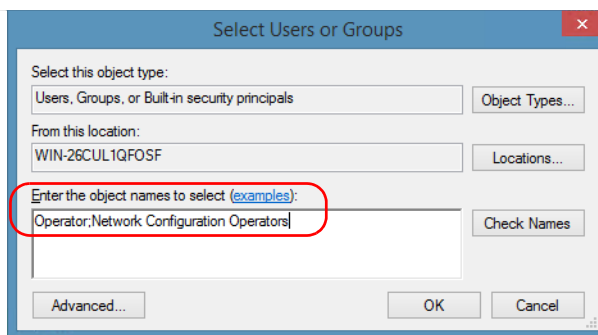

11. Click **OK**.

12. Confirm the newly added user has **Remote Launch** and **Remote Activation** permissions as follows:

12a. In the **Launch Permission** dialog box, select the name of the new user.

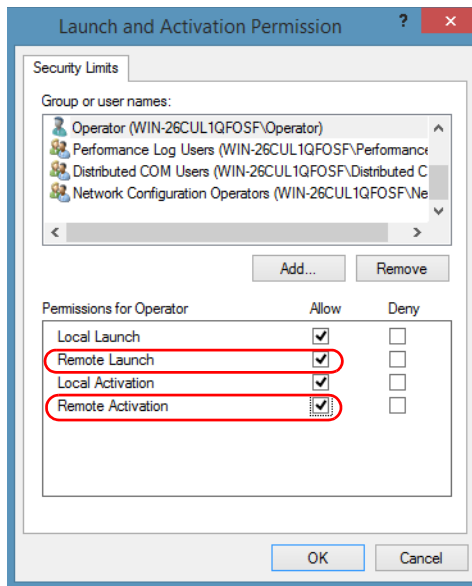

12b. Under **Permissions for** (new user), ensure **Allow** is selected for both **Remote Launch** and **Remote Activation**.

12c. Click **OK**.

Preparing for Automation

Configuring DCOM Access to Your Unit

Customizing the Specific Security Parameters

Once you have defined the general security parameters, you can define the specific security parameters.

To customize the specific security parameters:

1. From the **Component Services** window, select: **Console Root > Component Services > Computers > My Computer > DCOM Config** to show the contents of the **DCOM Config** folder.

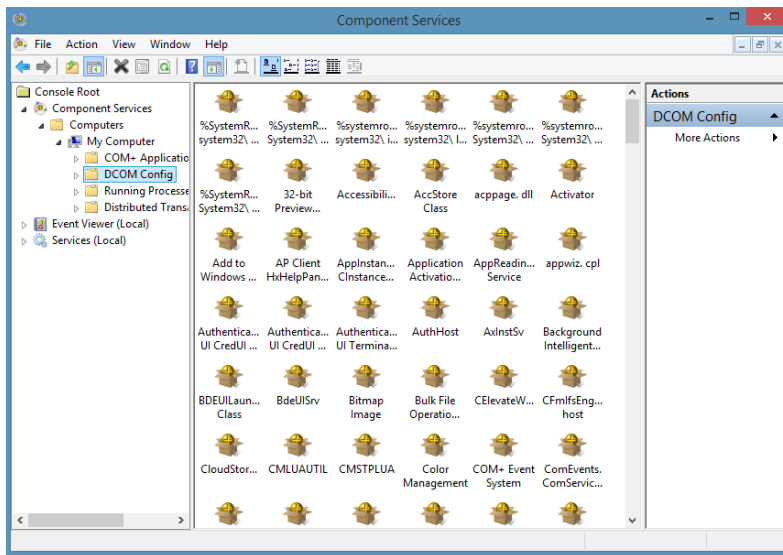

2. From **DCOM Config**, right-click **EXFO KernosHost**, and select **Properties**.
3. Click the **General** tab.

4. In the **Authentication Level** list, select **Default**.

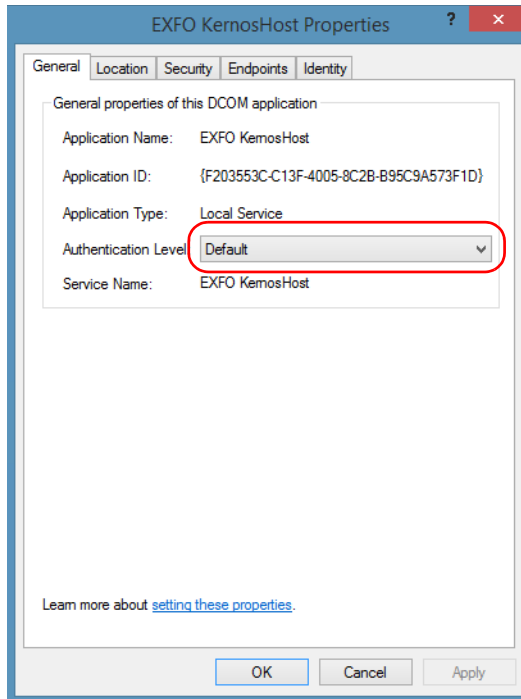

Preparing for Automation

Configuring DCOM Access to Your Unit

5. In the **EXFO KernosHost Properties** dialog box, click the **Security** tab.
6. Under **Launch and Activation Permissions**, select **Customize**, and then click **Edit** to edit the list of allowed users.

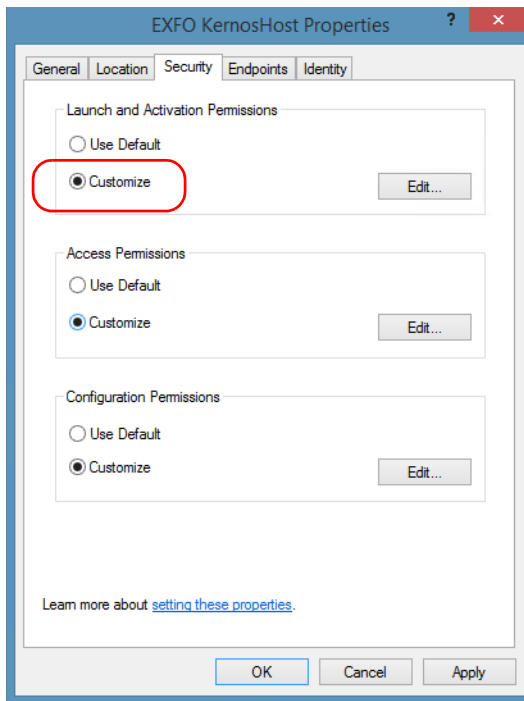

IMPORTANT

Customizing access rights sets both remote AND local permissions. As a result, you will have to specify every user who must have local access to the system (see *Setting the General Security Parameters* on page 148).

If you do not specify local access rights, no user will be able to access EXFO KernosHost and, therefore, no user will be able to start IQS Manager.

- 7.** In the **Launch and Activation Permission** dialog box, click **Add**.

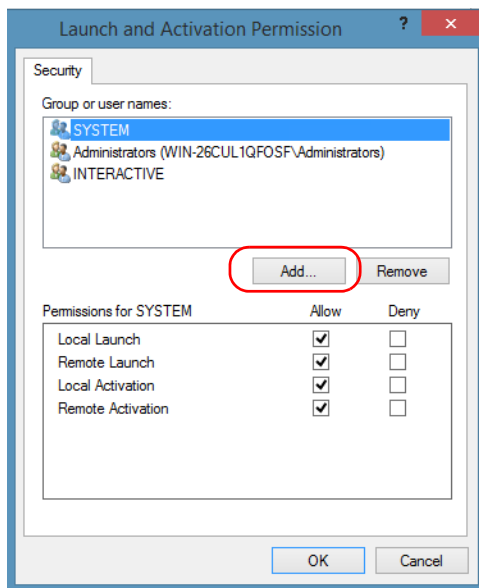

- 8.** In the **Select Users or Groups** dialog box, under **Enter the object names to select**, type the name of the user to whom you want to give start and activation permissions for remote access.

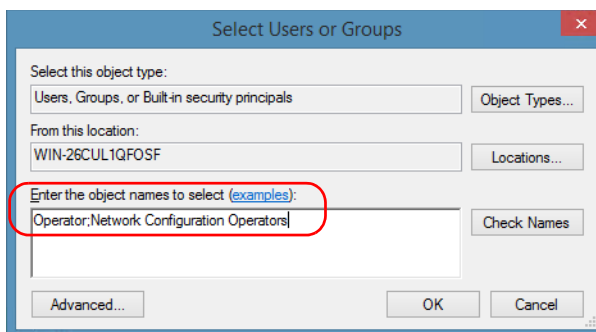

- 9.** Click **OK**.

Preparing for Automation

Configuring DCOM Access to Your Unit

- 10.** In the **Launch and Activation Permission** dialog box, select a user.
- 11.** To allow this user to start and activate the IQS-600 remotely, select **Allow** for all four permission choices.

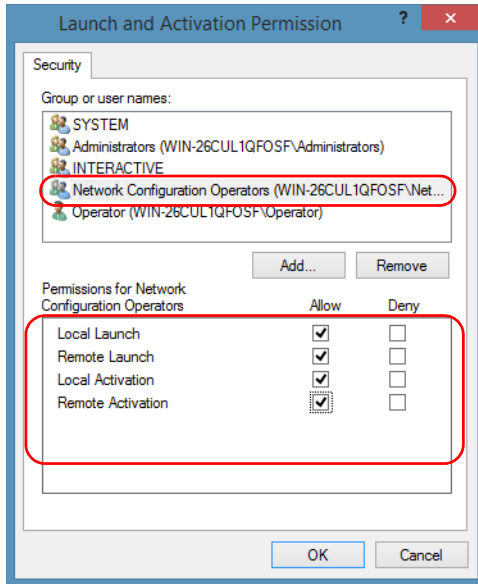

- 12.** Repeat steps 10 and 11 for each newly added user.
- 13.** Click **OK**.

14. In the **EXFO KernosHost Properties** dialog box, click the **Security** tab.
15. Under **Access Permissions**, select **Customize**, and click **Edit** to edit the list of allowed users.

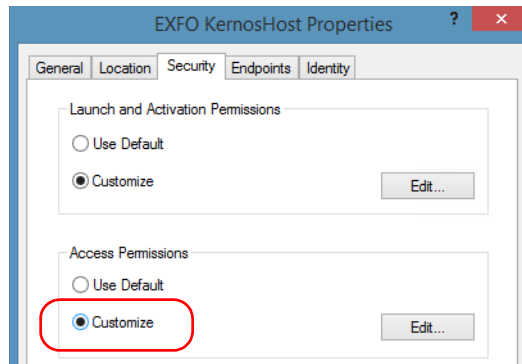

IMPORTANT

Customizing access rights sets both remote AND local permissions. As a result, you will have to specify every user who must have local access to the system (see *Setting the General Security Parameters* on page 148).

If you do not specify local access rights, no user will be able to access EXFO KernosHost and, therefore, no user will be able to start IQS Manager.

16. In the **Access Permission** dialog box, click **Add**.

Preparing for Automation

Configuring DCOM Access to Your Unit

17. In the **Select Users or Groups** dialog box, under **Enter the object names to select**, type the name of the user to whom you want to give access permissions for remote access.

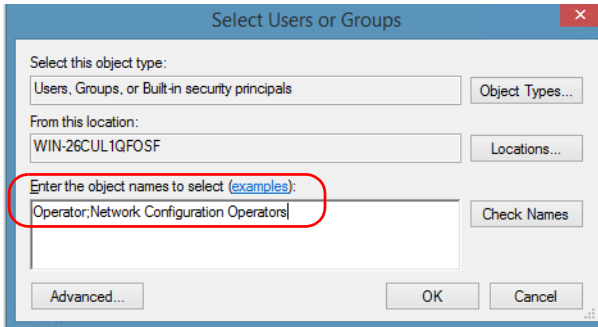

18. Click **OK**.
19. In the **Access Permission** dialog box, select a user.

- 20.** To allow this user to access the IQS-600 remotely, select **Allow** for both permission choices.

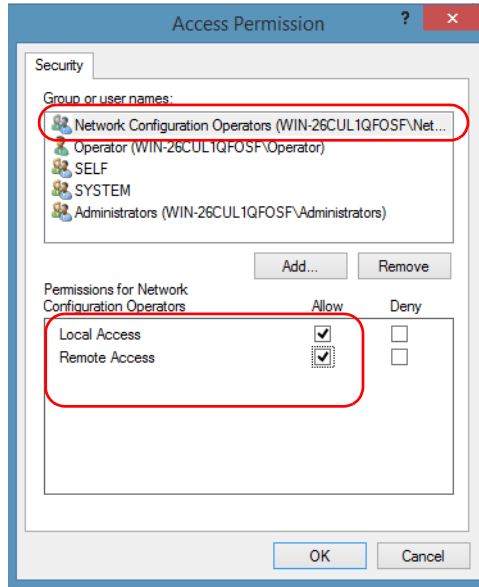

Note: You can also deny connection permission for specific users.

- 21.** Repeat steps 19 and 20 for each newly added user.
- 22.** Click **OK** to close the **Access Permission** dialog box.
- 23.** Click **OK** to close the **EXFO KernosHost Properties** dialog box.
- 24.** Restart your IQS-600.

The EXFO IScPIAccess Class component, located on your IQS-600 Integrated Qualification System, can now be accessed with DCOM.

Preparing for Automation

Configuring DCOM Access to Your Unit

Enabling DCOM on Client Computer

Note: To run *DCOMCNFG.EXE*, you need Administrator access rights.

If you want to subscribe to EXFO ICSPIAccess Class component events, you need to set security parameters on the client computer.

To enable DCOM on the client computer:

1. Start Windows, on the taskbar, click **Start** (Start button () under Windows 8.1) and select **Run**.
2. In the **Open** box, type “DCOMCNFG.EXE” and click **OK**.
3. In the **Component Services** dialog box, select: **Console Root** > **Component Services** > **Computers** to show available computers.

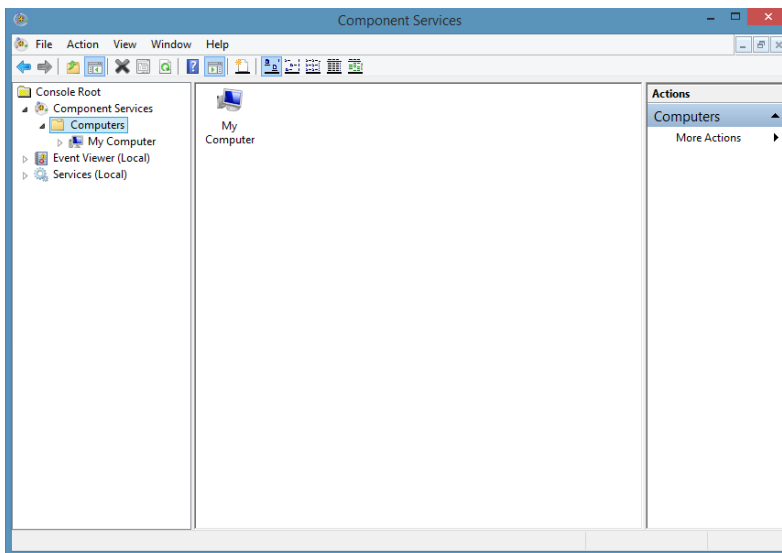

4. Right-click **My Computer**, and then select **Properties**.
5. In the **My Computer Properties** dialog box, click the **Default Properties** tab.
6. Select **Enable Distributed COM on this computer**.

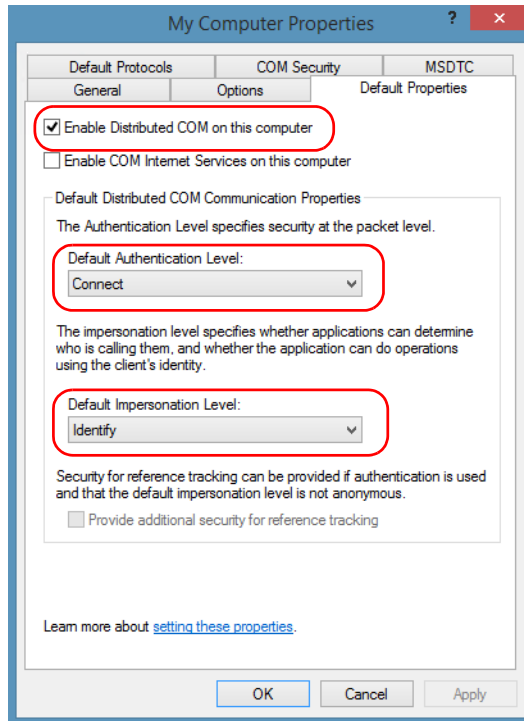

7. Under **Default Distributed COM Communication Properties**, in the **Default Authentication Level** list, select **Connect**.
8. In the **Default Impersonation Level** list, select **Identify**.
9. Click **Apply**.

Preparing for Automation

Configuring DCOM Access to Your Unit

10. Click the **COM Security** tab and, under **Access Permissions**, click **Edit Limits**.

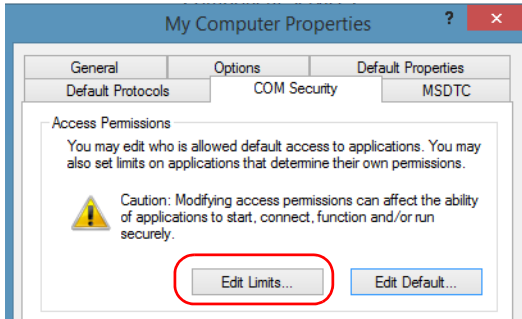

11. In the Access Permission dialog box, ensure that, for **ANONYMOUS LOGON**, local and remote accesses are allowed.

If **ANONYMOUS LOGON** is not listed under Group or user names, click **Add** to add it.

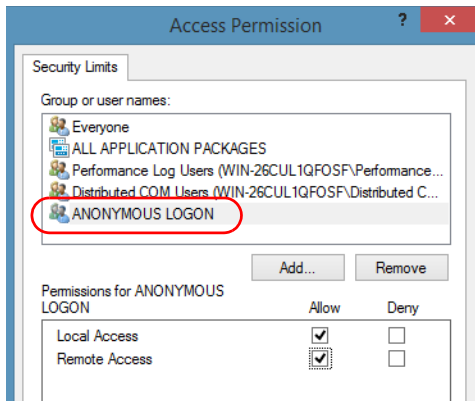

For more information on enabling events with DCOM, refer to *AppId Key* in MSDN Documentation.

Disabling DCOM Access to Your IQS-600

Note: To change the DCOM access to your unit, you need Administrator access rights.

If you no longer want client computers to access your IQS-600 using DCOM, you can disable this access.

To disable DCOM access to your IQS-600:

1. From the main window, tap the **System Settings** button.
2. Tap **Control Panel**.
3. Tap **System and Security > Administrative Tools**.
4. Double-click **Component Services**.
5. From the **Component Services** window, select: **Console Root > Component Services > Computers > My Computer > DCOM Config** to show the contents of the **DCOM Config** folder.

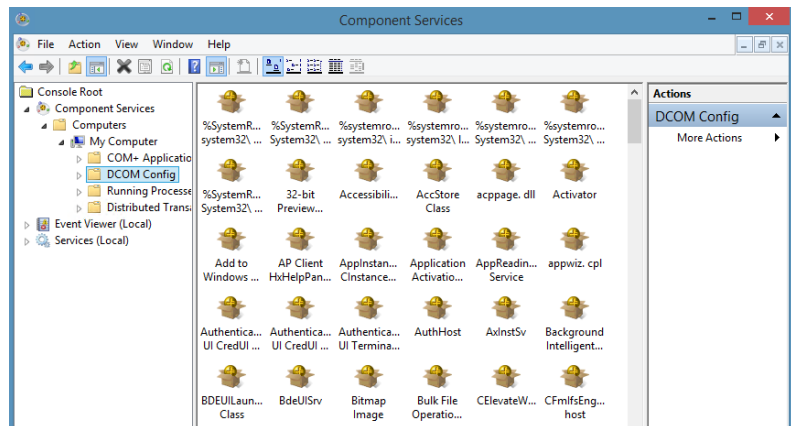

6. From **DCOM Config**, right-click **EXFO KernosHost**, and select **Properties**.

Preparing for Automation

Configuring DCOM Access to Your Unit

7. In the **EXFO KernosHost Properties** dialog box, click the **Security** tab.
8. Under **Launch and Activation Permissions** and **Access Permissions**, select **Use Default**.

This ensures the EXFO IcSCPIAccess Class component uses the default lists instead of the customized lists.

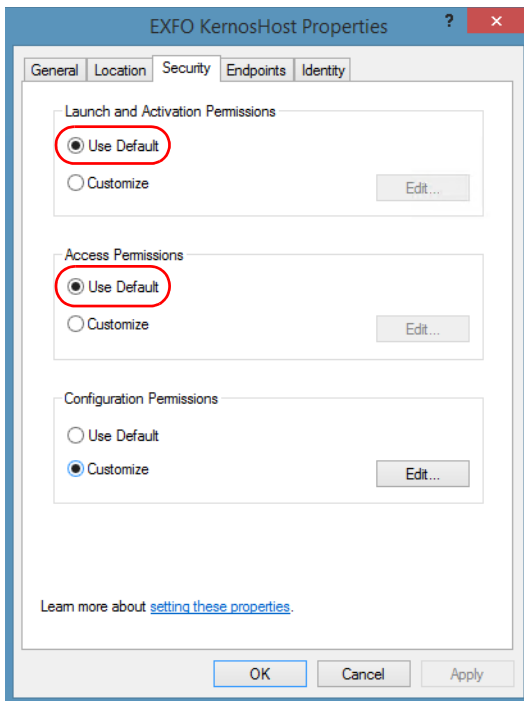

9. Click **OK**.
10. Restart your IQS-600 Integrated Qualification System controller unit.

The EXFO IcSCPIAccess Class component, located on your IQS-600 Integrated Qualification System, *cannot* be accessed with DCOM.

Preparing to Control Modules with a Dedicated Application

Some modules come with a dedicated application designed to control them remotely from a computer. The main characteristic of this application is that it lets another user control the module exactly as if he had it close at hand.

To control the module remotely, you must configure it on the unit containing the module, including a description that can help you identify it. The user controlling the module from a computer must install the dedicated application (for more information on the installation, refer to the application documentation).

- The module can be controlled both remotely and locally at the same time.
- You will have to configure your remote control again in the following cases:
 - you inserted the module in another slot
 - you applied changes on applications while the module is not inserted in its slot.

Note: *Some modules do not support the remote control.*



IMPORTANT

If there is a network failure or a problem with your remotely-controlled module, you can shut down the latter without closing all the other applications. The local and remote module session will then be closed.

Preparing for Automation

Preparing to Control Modules with a Dedicated Application

To activate or deactivate remote control:

1. From the **Utilities** function tab, select the **System** tab.

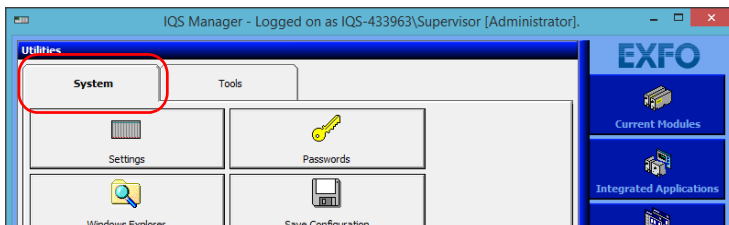

2. Select **Remote Control Configuration**.

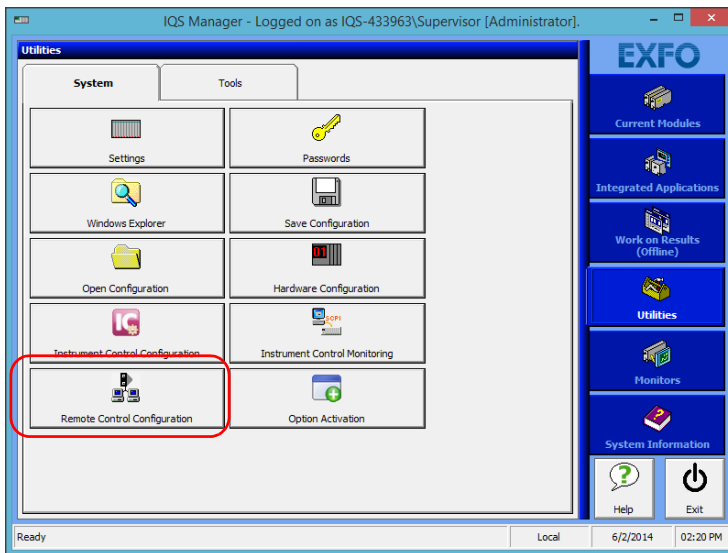

Preparing for Automation

Preparing to Control Modules with a Dedicated Application

3. From the **Remote Control Configuration** window you will see all the inserted modules. Select the module for which you want to have a remote access.

Note: *Modules for which remote control is not supported are identified as unrecognized.*

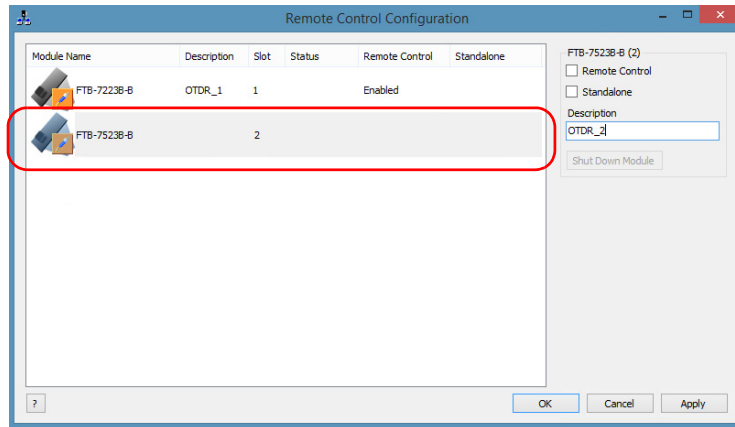

4. Set the parameters:
 - Select **Remote Control** to let another user control the module from a computer.
 - Select **Standalone** to leave the module active even if all users close their dedicated applications.

Preparing for Automation

Preparing to Control Modules with a Dedicated Application

5. Under **Description**, type a relevant description (test interface ID, for example).

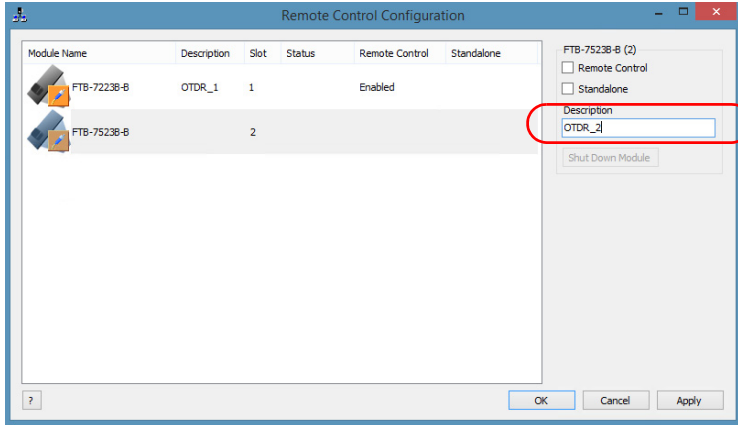

Note: You can enter up to 10 characters. The description corresponds to the test interface ID or any other relevant description.

6. Click **Apply** to confirm your changes or **OK** to apply your changes and close the window.

Note: This information will be updated the next time you start the module application and appear in the title bar if the module application allows it. Refer to the corresponding module documentation for more details.

To shut down the remotely-controlled module:

Click **Shut Down Module**.

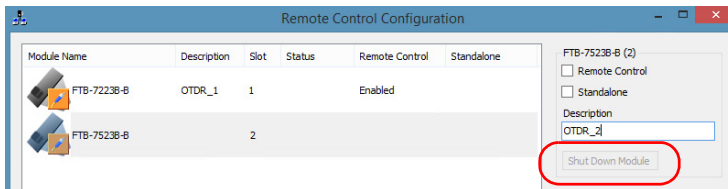

8 *Using IQS Products in an Automated Test Environment*

EXFO supplies commands that follow the guidelines determined by the SCPI consortium and LabVIEW drivers for all available instruments. EXFO also supplies COM properties and events allowing you to build your own application.

Your application can be developed using LabVIEW, Visual C++, .NET, Visual Basic or any other language that runs under Windows 8.1 Pro.

The present chapter gives you information to help you use the provided commands, drivers, as well as COM properties and events to remotely control your instruments.

If you need information on how to prepare your IQS-600 Integrated Qualification System for remote control, see the corresponding section in this documentation.

Managing the States of Your IQS-600 Integrated Qualification System

Your IQS-600 Integrated Qualification System can be in one of the following states:

State	Characteristics
Local	<ul style="list-style-type: none">▶ Front-panel keys of the IQS controller unit and peripherals are all functional▶ Default state at unit turn on
Remote	<ul style="list-style-type: none">▶ Front-panel keys of the IQS controller unit and peripherals are <i>not</i> functional except for the LOCAL key and the power switch▶ The REMOTE LED of the IQS controller unit is lit
Local with lockout	<ul style="list-style-type: none">▶ Return to Local mode only possible via commands sent from the system controller▶ Pressing the front-panel LOCAL key causes an URQ message (see <i>Standard Status Data Structure</i> on page 183)▶ In GPIB, this state is not available when the device has the RL2 capability (see the section on preparing the hardware for GPIB control for details.)▶ The LOCK LED of the IQS controller unit is lit

Using IQS Products in an Automated Test Environment

Managing the States of Your IQS-600 Integrated Qualification System

State	Characteristics
Remote with lockout	<ul style="list-style-type: none"><li data-bbox="569 266 1239 358">▶ Front-panel keys of the IQS controller unit and peripherals are <i>not</i> functional except for the power button<li data-bbox="569 370 1239 431">▶ Return to Local mode only possible via commands sent from the system controller<li data-bbox="569 443 1239 535">▶ Pressing the front-panel LOCAL key causes an URQ message (see <i>Standard Status Data Structure</i> on page 183)<li data-bbox="569 547 1239 639">▶ In GPIB, this state is not available when the device has the RL2 capability (see the section on preparing the hardware for GPIB control for details.)<li data-bbox="569 651 1239 712">▶ Both the REMOTE and LOCK LEDs of the IQS controller unit are lit

Note: *The current state is displayed in the IQS Manager status bar.*

Using IQS Products in an Automated Test Environment

Managing the States of Your IQS-600 Integrated Qualification System

The following diagram shows the possible transitions between the different states.

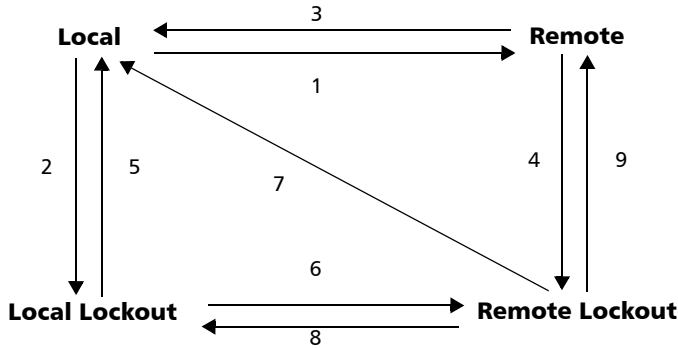

No.	Possible in GPIB if:	Possible in ActiveX by setting:
1	<ul style="list-style-type: none"> ➤ The remote interface message (REM) is set to True. ➤ The device is addressed to listen (MLA). ➤ The return to local interface message (rtl) is set to False. 	The <i>RemoteState</i> property to True.
2	<ul style="list-style-type: none"> ➤ The remote interface message (REM bus line) is set to True. ➤ The local lockout interface message (LLO) is set to True. 	The <i>LockoutState</i> property to True.
3	One of the following conditions is true: <ul style="list-style-type: none"> ➤ The go to local interface message (GTL) is received and the device is addressed to listen (MLA). ➤ The Clear Lockout/Set Local message is received (the REM bus line is set to False). ➤ The return to local interface message (rtl) is set to True and the local lockout interface message (LLO) is set to False. 	The <i>RemoteState</i> property to False.

Using IQS Products in an Automated Test Environment

Managing the States of Your IQS-600 Integrated Qualification System

No.	Possible in GPIB if:	Possible in ActiveX by setting:
4	The local lockout interface message (LLO) is set to True.	The <i>LockoutState</i> property to True.
5	The Clear Lockout/Set Local message is received from the controller (the REM bus line is set to False).	The <i>LockoutState</i> property to False.
6	The device is addressed to listen (MLA).	The <i>RemoteState</i> property to True.
7	The Clear Lockout/Set Local message is received from the controller (the REM bus line is set to False).	-----
8	The go to local interface message (GTL) is received.	The <i>RemoteState</i> property to False.
9	-----	The <i>LockoutState</i> property to False.

Note: See the appendix on COM properties and events for more information.

Note: You can also return to local state by turning the device off and on again. However, this operation will cause the controller to lose control of the system (no more local lockout state). All settings made on the device by the controller will be lost (reset of device configuration when turning on).

Message Management

Each device that is physically connected to the GPIB link has its own input buffer, output queue and error/event queue. These data structures allow storage of incoming messages (single or compound commands that are sent to an instrument), responses from queries, errors and events that may occur.

Data structure	Characteristics	Clearing
Input buffer	<ul style="list-style-type: none"> ➤ Consists of a First-In, First-Out (FIFO) data structure. ➤ Stores Data Bytes (DABs) and END messages. ➤ Delivers messages to the parser in the order that they were received from the I/O control. ➤ Maximum message length: unlimited in DABs (the input buffer size is only limited to the total size of the device memory). ➤ An incoming byte empties the output queue. An error will be raised if the output queue contained data. Consequently, it clears the Message AVailable bit (bit number 4 –MAV from the Status Byte register). 	<p>The buffer will be cleared by:</p> <ul style="list-style-type: none"> ➤ Turning off the power. ➤ Sending a Device Clear (DCL) message to the instrument. ➤ Sending a Selected Device Clear (SDC) message to the instrument.

Data structure	Characteristics	Clearing
	<ul style="list-style-type: none"> ➤ Except for the string and binary block contents, the following transformations are made on the incoming data: character conversion from lower case to upper case. conversion of “<wsp>” characters to spaces. conversion of multiple blanks to a single blank. ➤ Parser begins to process messages when the <PROGRAM MESSAGE TERMINATOR> is received or if the input buffer is full. 	
Output queue	<ul style="list-style-type: none"> ➤ Consists of a First-In, First-Out (FIFO) data structure. ➤ When the instrument acts as a talker, it sends response messages (from the output queue) to the controller. Response messages all end with a <RESPONSE MESSAGE TERMINATOR>, see the appendix on data types. ➤ Total storage capacity: only limited to the device’s memory. ➤ As soon as there is data in the output queue, the Message AVailable bit (bit number 4 –MAV from the Status Byte register) is set to 1. ➤ Remains empty if no query is received or if the query contains an error. 	<p>The Output queue will be cleared by:</p> <ul style="list-style-type: none"> ➤ Reading all the items it contains. ➤ Turning off the power. ➤ Sending a Device Clear (DCL) message to the instrument. ➤ Sending a Selected Device Clear (SDC) message to the instrument. ➤ Attempting to send a command before reading the responses to previous queries (an error will also be raised).

Using IQS Products in an Automated Test Environment

Message Management

Data structure	Characteristics	Clearing
Error/Event queue	<ul style="list-style-type: none"> ➤ Consists of a First-In, First-Out (FIFO) data structure. ➤ Total storage capacity: 50 errors or events. ➤ Errors or events can be retrieved, one at a time, with <code>:SYSTem:ERRor[:NEXT]?</code>. ➤ When an error or event occurs and the Error/Event queue is full, the last item in the queue (the most recent) is removed and the Queue overflow error (error -350) is added. No new items will be stored into the queue until there will be room available. ➤ As soon as there is data in the output queue, the Error Available bit (bit number 2 –EAV from the Status Byte register) is set to 1. 	<p>The Error/Event queue will be cleared when:</p> <ul style="list-style-type: none"> ➤ Reading all the items it contains. ➤ Turning off the power. ➤ Sending a Device Clear (DCL) message to the instrument. ➤ Sending a Selected Device Clear (SDC) message to the instrument. ➤ Using the *CLS command.

Standard Status Data Structure

Each device that is physically connected to the GPIB bus has four status registers with a structure complying with the IEEE 488.2 standard. These registers allow the controller to monitor events and get useful information on the status of the devices it controls.

- Standard Event Status Register (ESR)
- Standard Event Status Enable Register (ESE)
- Status Byte Register (STB)
- Service Request Enable Register (SRE)

ESR and ESE

The standard event status register and status enable register information is presented in the following table.

Bits	Mnemonics	Bit Value
7	Power On (PON)	128
6	User Request (URQ)	64
5	Command Error (CME)	32
4	Execution Error (EXE)	16
3	Device-Dependent Error (DDE)	8
2	Query Error (QYE)	4
1	Not Used (N.U.)	0
0	Operation Complete (OPC)	1

Using IQS Products in an Automated Test Environment

Standard Status Data Structure

The following table presents a summary of the possible operations on ESR and ESE registers.

Register	Read	Write	Clear
ESR	Use *ESR?.	Impossible to write.	<ul style="list-style-type: none">➤ Use *CLS.➤ Read the register.
ESE	Use *ESE?.	Use *ESE.	<ul style="list-style-type: none">➤ Use *ESE with a value equal to 0.➤ At IQS Manager startup, the register is set to 0. Use *ESE with a value equal to 0.

STB and SRE

The status byte register and service request enable register information is presented in the following table.

Bits	Mnemonics	Bit Value
7	Not Used (N.U.)	0
6	Master Summary Status (MSS)/ Service Request (RQS)	64
5	Event Summary Bit (ESB)	32
4	Message Available (MAV)	16
3	Not Used (N.U.)	0
2	Error Available (EAV)	4
1	Not Used (N.U.)	0
0	Not Used (N.U.)	0

The following table presents a summary of the possible operations on STB and SRE registers.

Register	Read	Write	Clear
STB	<ul style="list-style-type: none"> ➤ Use *STB?. ➤ Use serial poll (GPIB bus sequence that allows retrieval of the value without interrupting the current process). 	Impossible to write; the register content is only modified when the Event registers or Queues are modified.	Use *CLS before sending a query (to clear the Event registers and Queues and by the same token clear the STB register).
SRE	Use *SRE?.	Use *SRE with a value equal to 0 to disable the register or with a value equal to 1 to enable it.	<ul style="list-style-type: none"> ➤ Use *SRE with a value equal to 0. ➤ At IQS Manager startup, the register is set to 0.

The diagram displayed on the next page is a useful aid in understanding the general commands and how a service request (SRQ) is generated.

Using a service request, a device notifies the controller that an event requiring special attention occurred. The controller will then find which device generated a SRQ (its RQS bit is set) and the causes of it.

Using IQS Products in an Automated Test Environment

Standard Status Data Structure

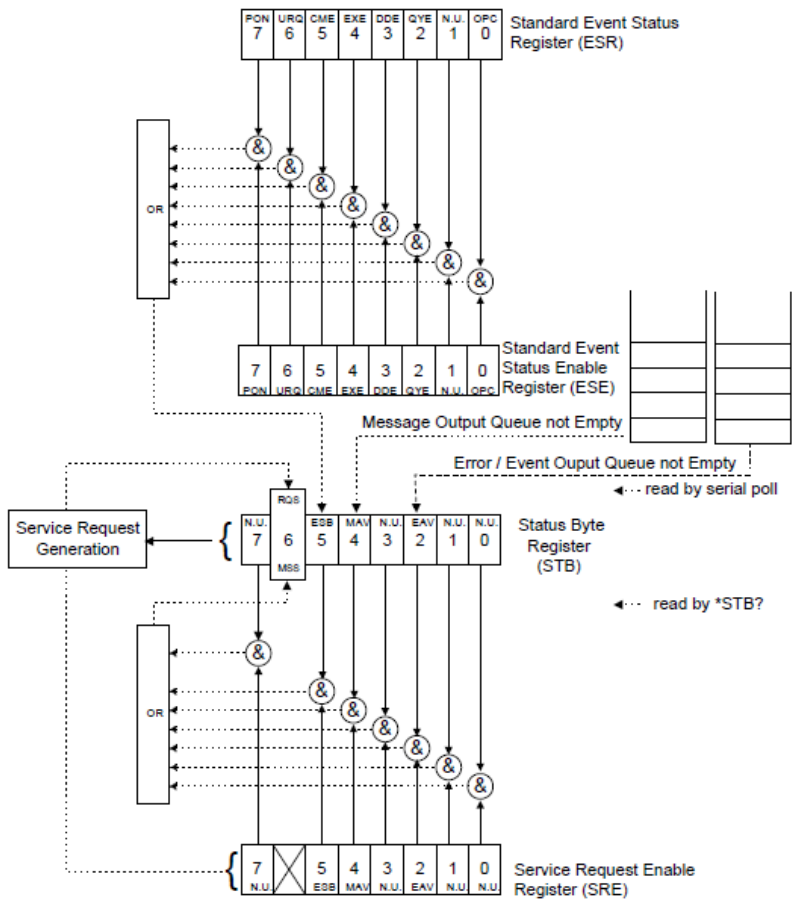

SCPI Command Structure

The information presented in this section provides an overview of SCPI programming. If you need detailed information, refer to:

- The International Institute of Electrical and Electronics Engineers. *IEEE Standard 488.1-1987, IEEE Standard Digital Interface for Programmable Instrumentation*. New York, 1987.
- The International Institute of Electrical and Electronics Engineers. *IEEE Standard 488.2-1992, IEEE Standard Codes, Formats, Protocols and Common Commands For Use with ANSI/IEEE Std. 488.1-1987*. New York, 1992.
- *Standard Commands for Programmable Instruments (SCPI). Volume 1: Syntax and Style*. Vers. 1999.0 May, U.S.A., 1999.

The provided commands follow the guidelines determined by the Standard Commands for Programmable Instruments (SCPI) consortium. A *program message* consists of one or more commands (and/or queries) with their appropriate parameters.

For example, a program message could contain a command used to activate or deactivate a source. The corresponding command syntax would be:

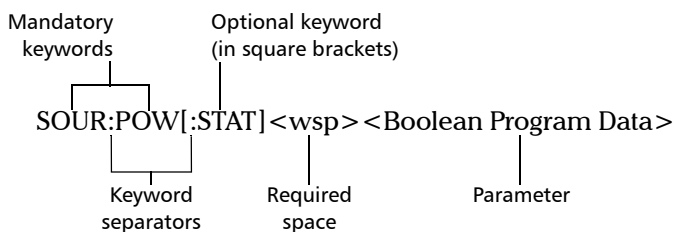

When sending a message containing the previous command, you would actually type: SOUR:POW ON.

Using IQS Products in an Automated Test Environment

SCPI Command Structure

The following table shows elements that are commonly used in the commands or queries syntax.

Item	Meaning
[]	Enclose optional keywords or parameters. <i>Do not include square brackets in your program message.</i>
[1..n]	Indicates that the instrument provides multiple capabilities and that you have to specify which one you want to use. If you omit the value, the command will take effect on the first capability. Multiple capabilities can be found at any branch of the command tree (root, intermediate node or terminal node). Example: If the command is :SENSE[1..n]:CORREction:COLLect:ZERO and you want it to take effect on the second SENSE (sensor) capability of the instrument, you may send this: :SENSe2:CORREction:COLLect:ZERO. <i>Do not include square brackets in your program message; simply enter the number.</i>
<wsp>	Indicates that a space is required (“wsp” stands for “white space”). Corresponds to ASCII character codes (0 to 9 and 11 to 32, in decimal). <i>Do not include “<wsp>” in your program message; simply type a space.</i>
<digit>	Element used in the construction of various numeric data types. Can take any value between 0 and 9 inclusively (corresponds to ASCII character codes 48 to 57, in decimal).

Item	Meaning
<mnemonic>	<p>Element used in the construction of certain data types and program messages.</p> <div data-bbox="542 354 1076 574" data-label="Diagram"> </div> <p>In the diagram above,</p> <ul style="list-style-type: none"> ➤ “<Upper/lower case alpha>” corresponds to ASCII character codes (65 to 90 and 97 to 122, in decimal). ➤ “_” corresponds to an underscore character (code 95, in decimal).
< >	<p>Text appearing between angled brackets specifies the command parameter to be sent or the response you will receive from an instrument.</p> <p><i>Do not include angled brackets in your program message.</i></p>
	<p>Indicates that one, and only one, value must be selected from the available choices.</p> <p>Example: If the list is 0 1, you can only select 0 or 1.</p> <p><i>Do not include the pipe character in your program message.</i></p>
{ }	<p>Indicate that the enclosed parameters can appear 0 to n times when the command is used.</p> <p><i>Do not include braces in your program message.</i></p>
:	<p>Mandatory to separate keywords. Can be omitted at the beginning of a program message. For example, you can use either :SYST:ERR or SYST:ERR.</p>

Using IQS Products in an Automated Test Environment

SCPI Command Structure

Item	Meaning
;	<ul style="list-style-type: none"> ➤ Mandatory to separate the different commands of a program message when more than one command is sent at a time. In this case, it is called <i><PROGRAM MESSAGE UNIT SEPARATOR></i>. ➤ Also used to separate responses when multiple queries were sent in a single program message. In this case, it is called <i><RESPONSE MESSAGE UNIT SEPARATOR></i>.
,	<ul style="list-style-type: none"> ➤ Mandatory to separate parameters in a command or a query. In this case, it is called <i><PROGRAM DATA SEPARATOR></i>. ➤ Also used to separate the various responses from a query. In this case, it is called <i><RESPONSE DATA SEPARATOR></i>.

There are also several conventions regarding command syntax:

- Spelling errors will cancel the command or query.
- Commands and queries are not case-sensitive. You can type your program messages using either lower-case or upper-case letters.
- The command or query can be written using only the three- or four-letter shortcuts, only full words, or a combination of both.

The example below shows the long and the short forms of a same query.

```

:SYSTem:ERRor?  ——— Long form
:SYST:ERR?     ]
:syst:err?     ]——— Short form (small words
                  represented by the capital letters
                  of the long form)
    
```

- For readability reasons, you can use extra spaces in your program messages but they will not be taken into account. For more information, see *Message Management* on page 180.

- You can build program messages allowing you to send more than one command at a time. Sometimes, you can omit the leading *<mnemonic>* path to simplify the program messages and speed up the search time (the parser saves the last position in the command tree).

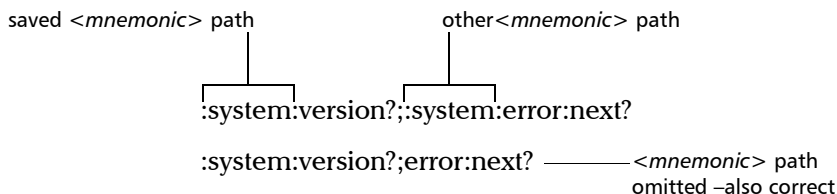

Paths cannot be omitted in all cases. The example below would cause an error.

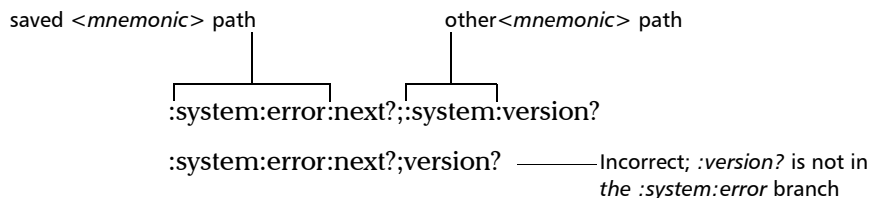

IEEE 488.2 required commands or queries (beginning with a *) that are part of the program message have no effect on the paths.

Example:

*:system:version?;*idn?;:system:error:next?* is equivalent to

*:system:version?;*idn?;error:next?*

Note: *Omitting the leading <mnemonic> path is only possible when you have more than one command or query in the program message that you send.*

Consulting Data Types

If you need information about data types used in EXFO's documentation, see the appendix on data types.

Writing Remote Control Code

Complex measurement programs may be written using any programming environment that supports GPIB communication. GPIB development kits are available for most of the popular commercial programming languages.

The IQS-600 Integrated Qualification System offers many commands permitting complete remote control of all the IQS components. These commands adhere to the SCPI standard.

You can find all the commands and queries supported by the IQS controller unit in the *IEEE 488.2 and Specific Commands* appendix. For information on commands specific to particular instruments, refer to the instrument's user guide.

When you write code, you must follow these rules on message reception and transmission:

- The controller must have sent a complete message to the instrument (including the message terminator) before retrieving a response.
- The controller must retrieve all the responses from previous queries (including the response terminator) before sending a new message to an instrument.
- The controller must not try to retrieve a response from an instrument if the corresponding query has not been previously sent to the instrument.
- You must pay special attention to queries that return an indefinite ASCII response. To avoid any confusion, the IEEE 488.2 standard requires that this data type be immediately followed by a response termination character. For this reason, when working with compound queries, you must ensure that a query sending an indefinite ASCII response is the last query of the series.
- Be careful when sending program messages containing multiple queries that return large amounts of data. Since the controller can only retrieve data when the instrument has finished processing the queries, it could result in problems ranging from a saturation of the output queue to the complete blocking of the whole system.

Error Message Format

System and device-specific errors are managed by the IQS-600 Integrated Qualification System. The generic format for error messages is illustrated in the following figure.



As shown in the above figure, the message contains three parts:

- error number
- error description
- device-dependent information

Error messages ending in a negative number are SCPI-based errors.

For more information on errors, see *Message Management* on page 180. For a complete list of possible errors, see the appendix on SCPI-based errors.

If you want to work in remote mode, see the section on configuring DCOM access for your unit in this user guide.

Working with EXFO LabVIEW Drivers

EXFO provides you with custom drivers that you can use to program commands for your inspection instruments.



IMPORTANT

You need to be familiar with the LabVIEW environment and programming methods to work with EXFO drivers.

Regardless of whether you work with the provided Getting Started applications or your own VIs (using EXFO drivers), the steps remain the same.

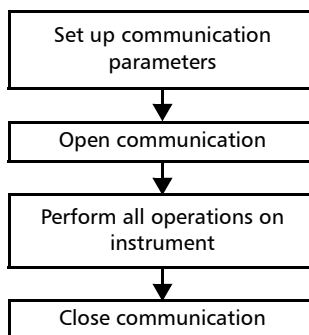

Before configuring the communication parameters via LabVIEW (provided applications or new VI), you must configure the IQS-600 Integrated Qualification System for remote control. For more information, see the section on preparing your unit for automation in this user guide.



IMPORTANT

Ensure that the communication type that you will set in LabVIEW matches the one selected for the IQS-600 Integrated Qualification System.

Using IQS Products in an Automated Test Environment

Working with EXFO LabVIEW Drivers

The following table presents the possible settings for communication parameters. These parameters must be set from LabVIEW for each instrument.

Parameter	Active X (local)	Active X (remote)	RS-232 (remote)	GPIB (remote)
Communication type	ActiveX	ActiveX	RS232	GPIB
VISA resource name	N/A	N/A	Select the serial port from the list	Select the GPIB device from the list
IQS slot number	Concatenation of the IQS controller or expansion unit number and the instrument's slot number	Concatenation of the IQS controller or expansion unit number and the instrument's slot number	Concatenation of the IQS controller or expansion unit number and the instrument's slot number	Concatenation of the IQS controller or expansion unit number and the instrument's slot number
Machine name	localhost	Ethernet address, that is IP address or machine name of your IQS controller unit	N/A	N/A

Note: *If you have modified the identification number of your IQS controller unit, use this number to form the IQS slot number. For example, for a controller unit configured as “999”, the IQS slot number will correspond to 999, immediately followed by the number of the slot (0 to 9) where the instrument has been inserted.*

Note: *When you are working with platform or IEEE 488.2 commands, you can leave the slot number at its current value.*

Using the EXFO Getting Started Applications

Once the LabVIEW drivers are installed, the Getting Started demo applications are available to demonstrate the following:

- How to open and close the communication link between the remote computer and the device.
- Some of the available functions (by loading the necessary *.vi* files).

All the *.vi* files related to an instrument are presented in the same folder. By default, they are found under the location where your LabVIEW files were installed.

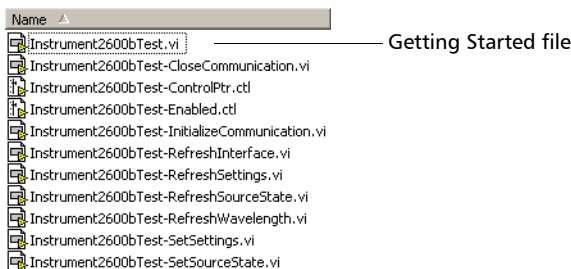

All Getting Started filenames follow this pattern: *InstrumentxxxxTest.vi* (where xxxx corresponds to the product code).

Each Getting Started application offers a user interface (called Front Panel) and a design view (called Block Diagram).

Note: *The look of the interface may change slightly depending on the operating system you are using.*

Using IQS Products in an Automated Test Environment

Using the EXFO Getting Started Applications

On the Front Panel, you can set communication parameters between the IQS controller unit and the current instrument. It also offers various controls and buttons to use the instrument easily. In fact, the application performs the necessary calls to the instrument's drivers so it is transparent to the user.

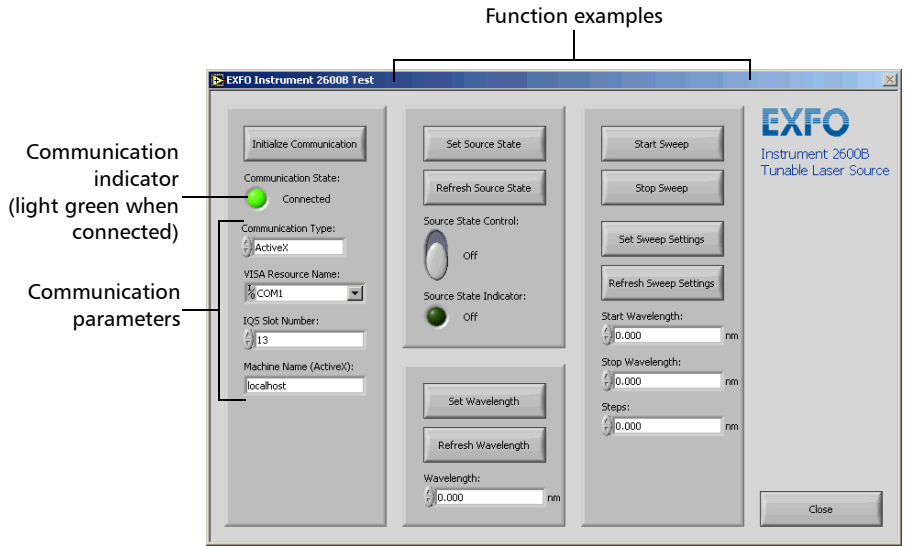

The application state (called State Machine) changes whenever an action is performed on the instrument. If you toggle to Block Diagram view, you can see the list of possible states. The application is always in one of the predefined states.

Using IQS Products in an Automated Test Environment

Using the EXFO Getting Started Applications

The following figure illustrates the State Machine after the user has clicked on the button allowing you to set the source state (from the Front Panel). When the State Machine changes to “SetSourceState”, the application calls “Instrument2600bTest_SetSourceState.vi”, which, in turn, calls the “SourcePowerState_GSet.vi” sub VI that will perform the appropriate action on the instrument.

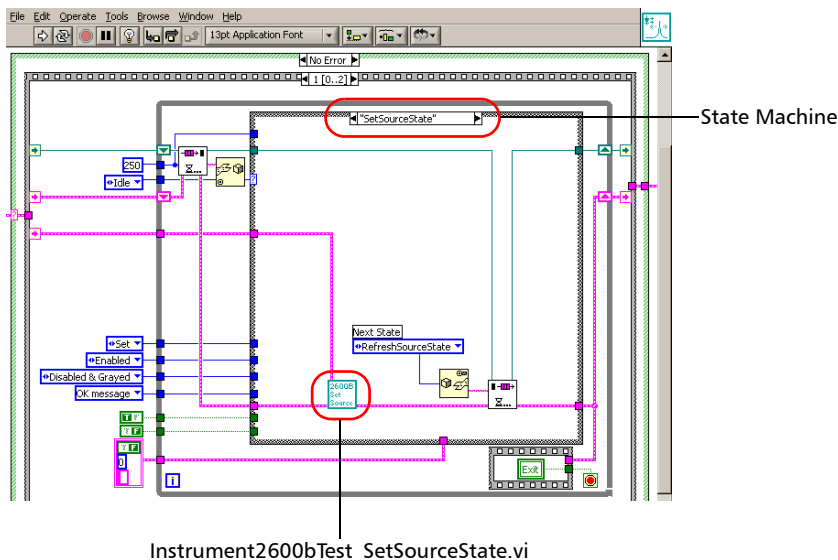

Using IQS Products in an Automated Test Environment

Using the EXFO Getting Started Applications

The detail of this sub VI gives precious information on how to call an instrument driver VI.

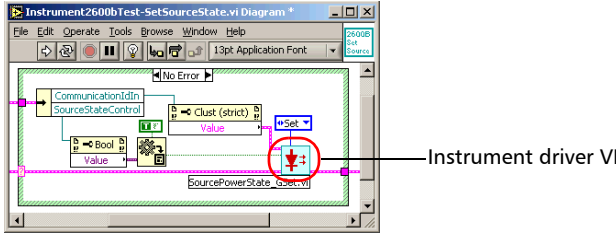

To use a Getting Started application:

1. Turn on the IQS controller unit, start IQS Manager, and ensure that all the remote-control parameters are set correctly.
2. Open the desired Getting Started application and run it from LabVIEW.
3. From the application's Front Panel, set the communication parameters.
For information on communication parameters, see *Working with EXFO LabVIEW Drivers* on page 195.
4. Once the parameters are configured, click **Initialize Communication**.

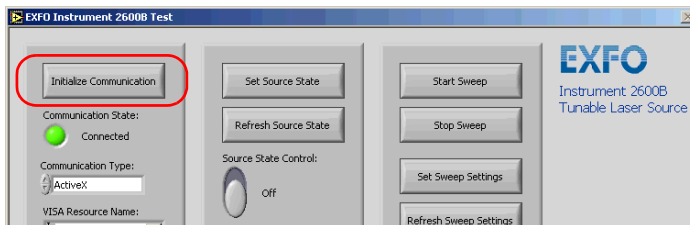

5. Using the provided buttons and controls, perform the desired actions.

6. When you are finished, select **Close** to end the communication.

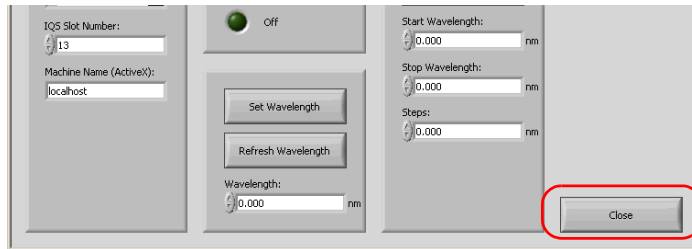

7. Close LabVIEW.



IMPORTANT

To avoid losing the original version of the Getting Started applications, do not save changes when prompted by LabVIEW.

Building and Using Custom VIs

EXFO LabVIEW drivers have been designed to let you control the various instruments according to your needs, by building your own VIs in LabVIEW.

You can access EXFO drivers

- directly from
C:\Program Files\National Instruments\LabVIEW 6\instr.lib\EXFO
- from the LabVIEW function palettes

Each icon of the EXFO palette corresponds to a set of drivers that allow you to either

- communicate with EXFO instruments that support remote control
- open and close communication links with instruments
- send IEEE 488.2 (common) commands
- send platform commands (specific to IQS controller unit)

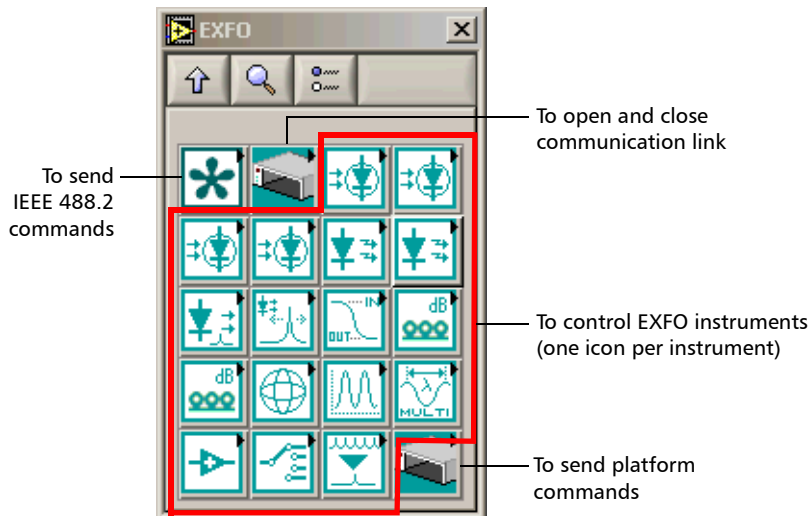

Using IQS Products in an Automated Test Environment

Building and Using Custom VIs

When you click an icon in the EXFO palette, the corresponding sub-palette opens, giving you access to the different functions.

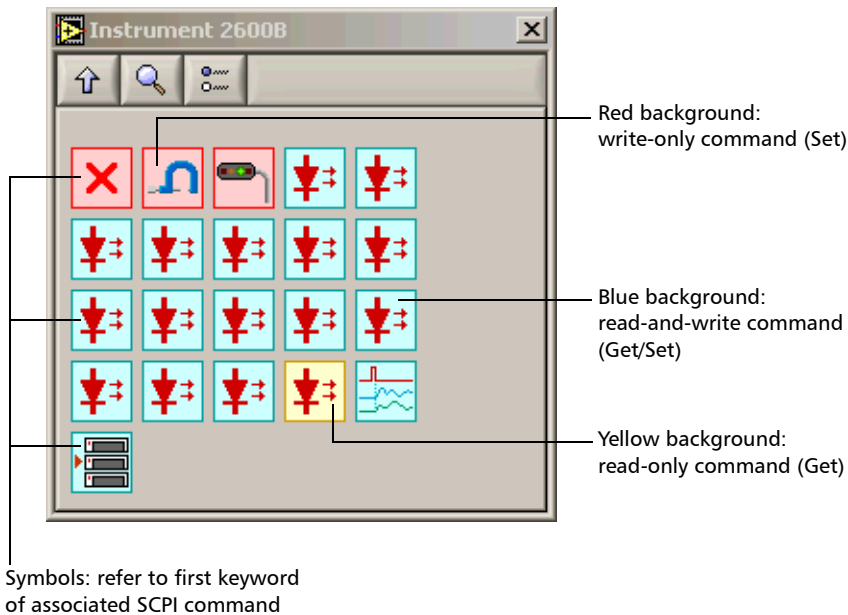

Using IQS Products in an Automated Test Environment

Building and Using Custom VIs

To build a custom VI:

1. Start LabVIEW and create a new VI.
2. Open the **EXFO** palette.
 - 2a. From LabVIEW, open the Diagram Block view.
 - 2b. Display the **Functions** palette and select **Instrument I/O**.

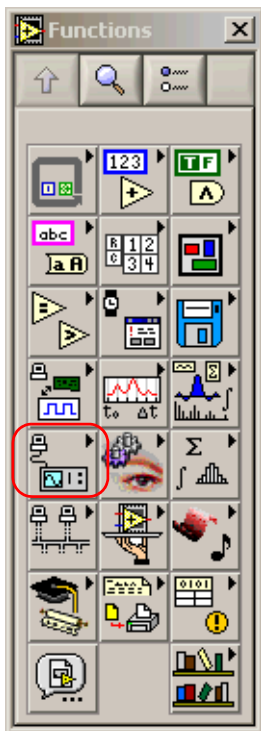

- 2c.** From the **Instrument I/O** palette, select **Instrument Drivers**.

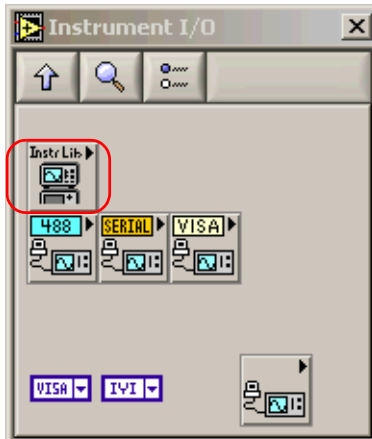

- 2d.** From the **Instrument Drivers** palette, select **EXFO**.



Using IQS Products in an Automated Test Environment

Building and Using Custom VIs

3. Select **EXFO IQS Base**.

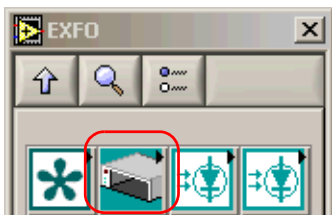

4. From the **EXFO IQS Base** palette, select *EXIQSBASE_OpenComm.vi* and add it to your new VI.

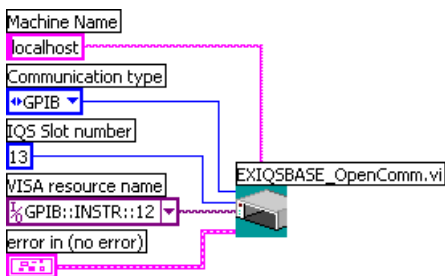

5. Set the communication parameters. For information on communication parameters, see *Working with EXFO LabVIEW Drivers* on page 195.
6. From the EXFO palette, select the desired instrument.
7. From the instrument's palette, select the function you need and add the corresponding driver to your VI.

8. Set the required parameters and connect the instrument *Communication ID in* parameter to the *Communication ID out* parameter from EXIQSBASE_OpenComm.vi.

The example below shows how to configure the SourcePowerState_GSet.vi to turn on the IQS-2600B tunable laser source. In this example, *Set* was chosen and the *PowerState* parameter was set to *True*.

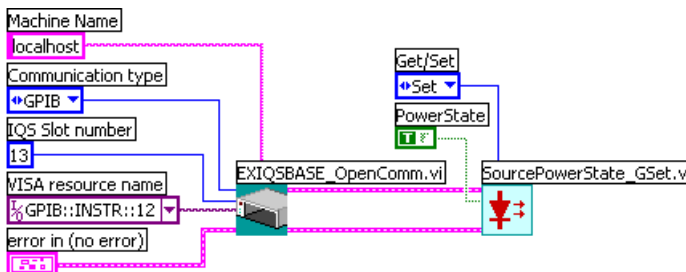

9. Repeat steps 7 and 8 for each of the functions you want to use.

However, you have to link *Communication ID in* of the new driver to *Communication ID out* of the preceding driver.

Note: If you want to use platform or IEEE 488.2 commands, add the desired driver to your VI and configure its parameters exactly as you would do with any instrument function.

Using IQS Products in an Automated Test Environment

Building and Using Custom VIs

10. When you are finished, add *EXIQSBASE_CloseComm.vi* to your VI.

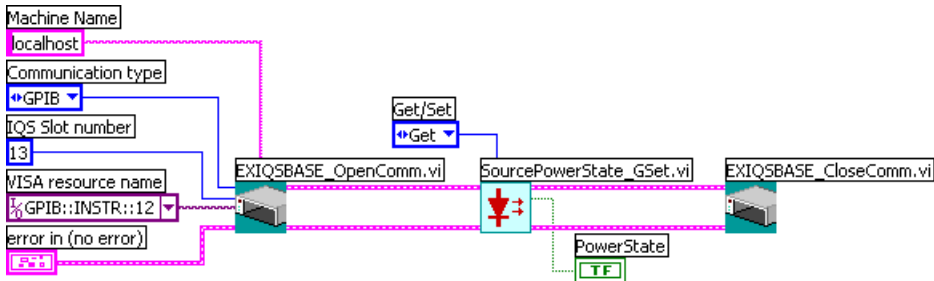

Connect the *Communication ID out* parameter of the last function to the *Communication ID in* parameter of *EXIQSBASE_CloseComm.vi*.

Note: You only have to open communication once at the beginning, and close it when all of the desired functions will have been added.

11. Save your work.

To use your new VI:

1. Turn on the IQS controller unit, start IQS Manager, and ensure that all the remote-control parameters are set correctly.
2. From LabVIEW, run the VI.

Monitoring Remote Commands

IQS Manager allows you to monitor remote commands sent to your units, if desired.

To monitor remote commands:

1. Click the **Utilities** function tab.

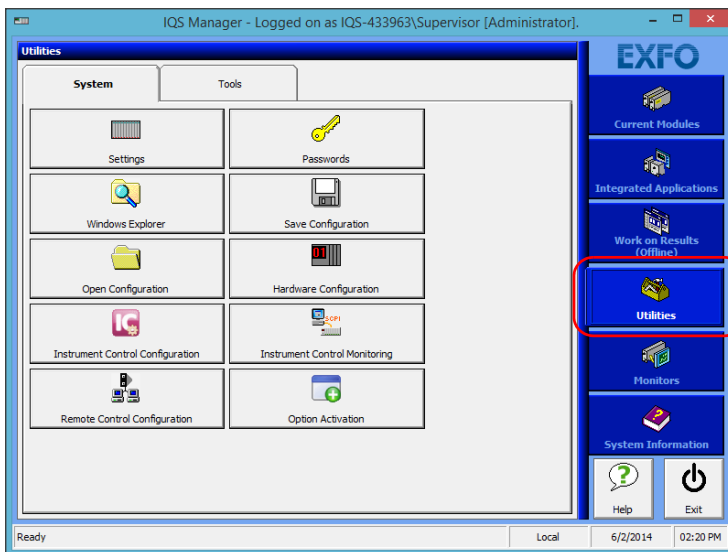

2. Click **Instrument Control Monitoring** to access the corresponding utility.

Using IQS Products in an Automated Test Environment

Monitoring Remote Commands

- 3. Do one of the following:
 - ▶ If monitoring using GPIB, ActiveX or RS-232, click **Connect to IC**.

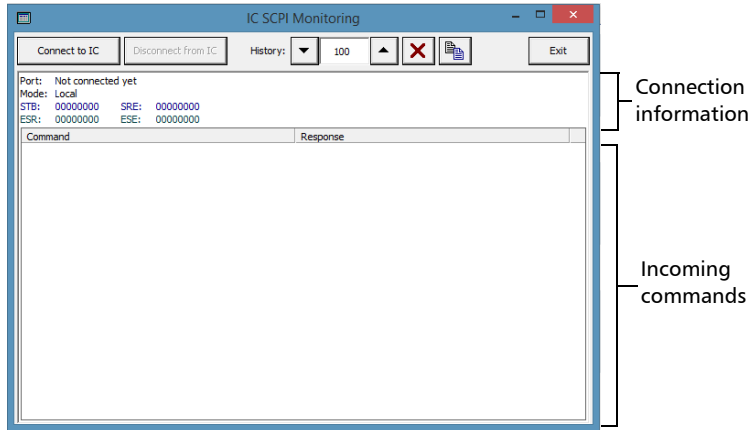

You are automatically connected to the monitoring system. The **Disconnect from IC** button becomes available for you when you are ready to disconnect.

Once connected, your current connection information will appear in the upper part of the window, and the commands will appear as a list in the lower part of the window.

With the **History** parameter, you determine how many commands you want to keep in the list. You can change the number by using the arrow buttons on each side of the list.

To clear the history, click .

To view the list in any word processor, click  to copy it to the clipboard, and then paste it in your document. You can use any program, as the list is copied in text format.

To exit the monitoring utility, click **Exit**.

For more information, see the section on using your unit in an automated test environment.

- If monitoring using TCP/IP, which provides sending SCPI commands over TCP/IP through Telnet from the EXFO Instrument Control, you are automatically connected to the monitoring system.

Note: Port 5024 is designated for sending SCPI commands in the Telnet protocol.

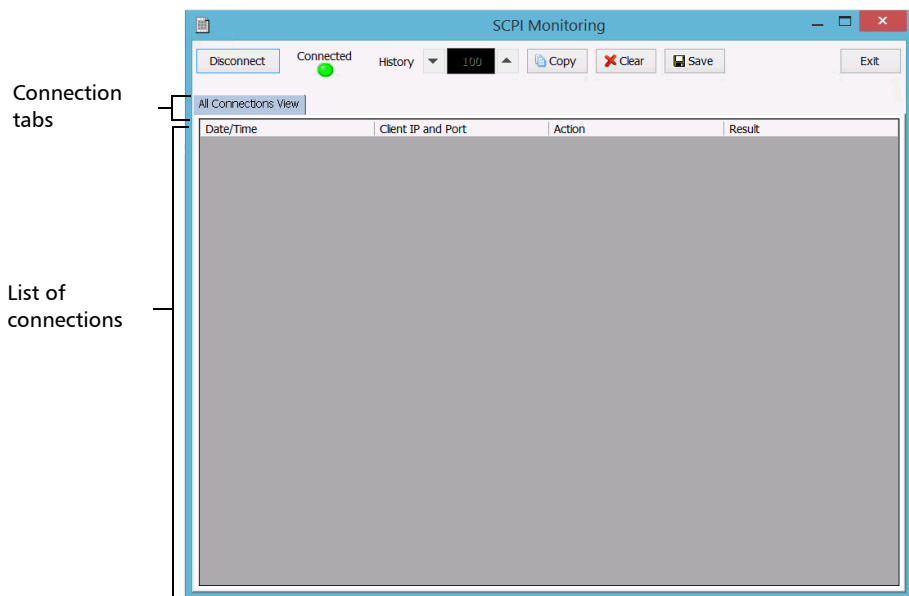

Once connected, your current connection information will appear in the **All Connections View** tab, and the commands will appear as a list in the lower part of the window.

The **Disconnect** button becomes available for you to click when you are ready to disconnect.

Connection information is also displayed in a separate tab, identified by its IP address, from where you can monitor the commands and other actions sent through TCP/IP over Telnet, as well as the results.

Using IQS Products in an Automated Test Environment

Monitoring Remote Commands

With the **History** parameter, you determine how many commands you want to keep in the list. You can increase or decrease the number by using the arrow buttons on each side of the list.

To clear the history, click **Clear**.

To view the list in any word processor, click **Copy** to copy it to the clipboard, and then paste it in your document. You can use any program, as the list is copied in text format.

To save the list as a file, click **Save**.

To exit the monitoring utility, click **Exit**.

For more information, refer to the user documentation about communication through TCP/IP over Telnet.

9 **Maintenance**

To help ensure long, trouble-free operation:

- Always inspect fiber-optic connectors before using them and clean them if necessary.
- Keep the unit free of dust.
- Clean the unit casing and front panel with a cloth slightly dampened with water.
- Store unit at room temperature in a clean and dry area. Keep the unit out of direct sunlight.
- Avoid high humidity or significant temperature fluctuations.
- Avoid unnecessary shocks and vibrations.
- If any liquids are spilled on or into the unit, turn off the power immediately, disconnect from any external power source and let the unit dry completely.



WARNING

The use of controls, adjustments and procedures, namely for operation and maintenance, other than those specified herein may result in hazardous radiation exposure or impair the protection provided by this unit.

Cleaning the Touchscreen (IQS-605P-HS)

Clean the touchscreen with a soft, non-abrasive cloth dampened with glass cleaner.

Replacing the Fuse

The IQS-600 Integrated Qualification System contains a 10 A, L250 V, fast blow, low breaking capacity fuse. However, this fuse is not user-serviceable. If you ever encounter problems with the fuse, contact EXFO for assistance.

Managing Windows Updates

By default, your unit is not configured to check for updates, but to let you choose whether you want to download and install them or not.

However, if you prefer, you can configure your unit to automatically search and install Windows updates to ensure that you benefit from the latest versions of the Windows applications. Your unit will need an Internet access for the updates.

Only the applications from Microsoft will be updated with the automatic Windows update feature. If you want to update EXFO applications, see *Installing or Upgrading the Applications* on page 46. The third-party applications will need to be updated manually.

To manage the updates for Windows applications:

1. From the Windows Desktop, right-click on the Start () button, then select **Control Panel**.
2. Click **System and Security**.

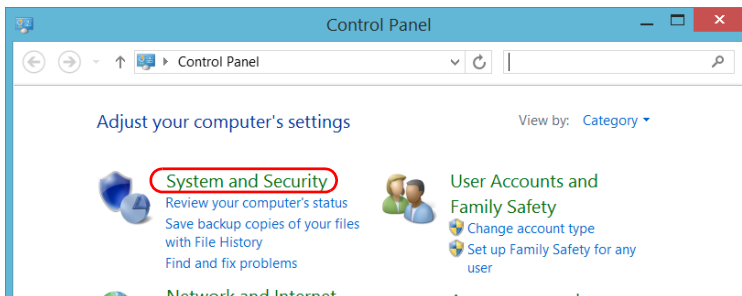

3. Under Windows Update, click Turn automatic updating on or off.

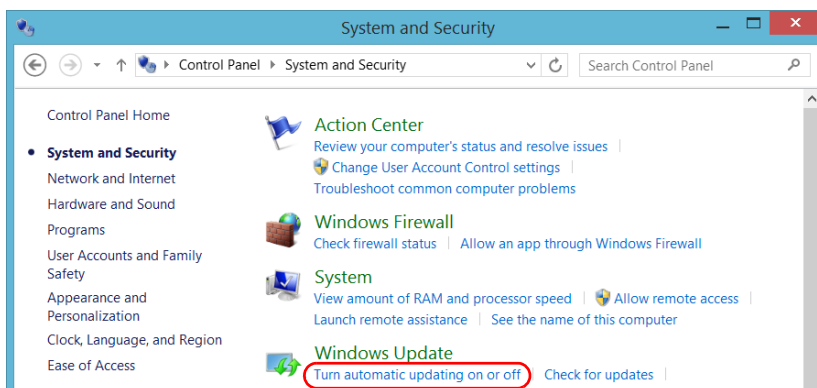

4. Select the update options that best suit your needs.

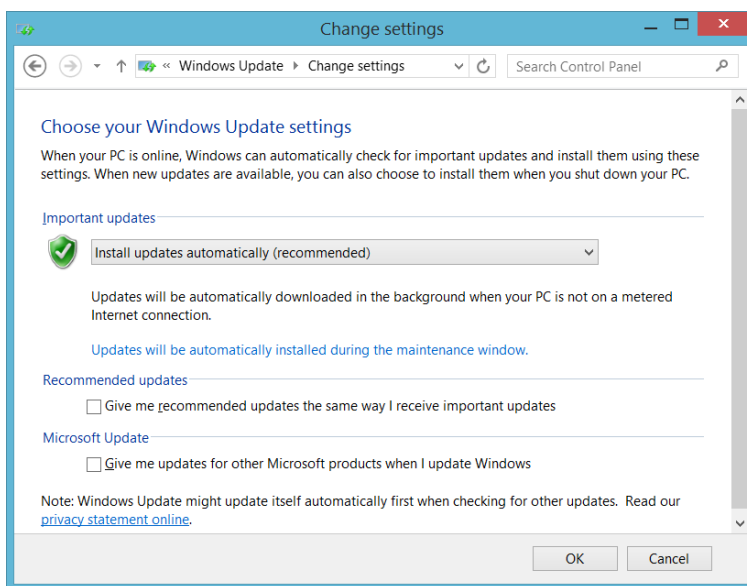

5. Click OK to confirm your changes and return to Control Panel.

Maintenance

Recycling and Disposal (Applies to European Union Only)

Recycling and Disposal (Applies to European Union Only)

For complete recycling/disposal information as per European Directive WEEE 2012/19/UE, visit the EXFO Web site at www.exfo.com/recycle.

10 Troubleshooting

Solving Common Problems

Problem	Probable Cause	Recommended Action
IQS-600 module does not turn on.	<ul style="list-style-type: none">➤ AC power not applied.➤ Main power switch not at “On” position.➤ AC current has been interrupted.➤ Fuse blown.	<ul style="list-style-type: none">➤ Verify AC power cord connection, then power unit back on.➤ Turn main power switch on.➤ Press on the front On/Off button twice to turn the unit on.➤ Contact EXFO.
Unit is on, but screen remains black.	External monitor not properly connected.	Verify external monitor connection.
I cannot set my screen resolution to 600 x 800.	This setting is not allowed by the Windows screen resolution utility.	Use the GMA driver utility in the Windows Control Panel.
External keyboard, printer and/or mouse do not seem to function.	No communication between peripheral and unit or peripheral in wrong connector.	Ensure that the peripheral is connected properly and that the corresponding drivers are installed.

Troubleshooting

Solving Common Problems

Problem	Probable Cause	Recommended Action
The controller unit does not detect the IQS modules in your expansion unit.	<ul style="list-style-type: none">➤ The expansion unit is not turned on.➤ The modules are not properly inserted into the expansion unit.➤ The IQS interface cable is not properly connected.➤ Non-compatible modules are inserted into a high-speed expansion unit (bearing the “HS” inscription on its front panel).	<ul style="list-style-type: none">➤ Turn on the expansion unit.➤ Ensure that the modules are properly inserted into the unit (remember to turn off your unit first).➤ Ensure that the cable linking your expansion unit with the main unit is properly connected.➤ Ensure that the modules are compatible with high-speed units. For a complete list of supported modules, contact the technical support team (see <i>Contacting the Technical Support Group</i> on page 238).
The standard module inserted into your high-speed controller or expansion unit is not detected.	The module is probably not compatible with high-speed units (bearing the “HS” inscription on their front panels).	Ensure that the module is compatible with high-speed units. For a complete list of supported modules, contact the technical support team (see <i>Contacting the Technical Support Group</i> on page 238).

Problem	Probable Cause	Recommended Action
<p>You receive an error message indicating that you must insert your high-speed module into a high-speed unit even though the module is already inserted into a high-speed unit.</p>	<ul style="list-style-type: none"> ▶ At least one standard unit is connected before the high-speed unit housing the high-speed module. ▶ The high-speed module is not inserted into one of the first three high-speed units. 	<ul style="list-style-type: none"> ▶ The units must be chained in a specific order. Ensure that all high-speed units are connected <i>before</i> all standard units. ▶ Ensure that the high-speed module is inserted in one of the first three high-speed units.
<p>A USB device is not functioning.</p>	<p>The USB device was not recognized by the system.</p>	<p>Disconnect, then reconnect the USB device.</p>
<p>SCPI commands are not displayed in the IC SCPI Monitoring window.</p>	<p>Communication has not been established from this window.</p>	<p>Establish connection by clicking the Connect to IC button.</p>
	<p>Communication has not been established on the GPIB or Ethernet port.</p>	<ul style="list-style-type: none"> ▶ Ensure that all cables are properly connected. ▶ Ensure that the Remote option is selected and that all parameters are properly set.
<p>This message is displayed on Windows desktop: RAID Volume Degraded.</p>	<p>Malfunctioning hard drive.</p>	<ul style="list-style-type: none"> ▶ Contact EXFO.

Troubleshooting

Restoring Your Controller Unit to Normal Operation

Restoring Your Controller Unit to Normal Operation

If you ever encounter major problems with your unit (for example, the unit does not behave the way it used to), you can revert it to a previous state. You can revert your unit either to its initial state (as it was at time of purchase), or to a specific state with a backup image (WIM file) created previously.

Note: *For current updates, use Update Manager.*

You can create your own WIM files directly from your unit and store them on a USB key for future use.



IMPORTANT

The WIM files that you create are based on the serial number of your unit. This means that the WIM files created on one unit are only valid to restore this particular unit.

When you want to restore your unit, there are several options. The table below gives an overview of the possibilities.

Method	Description
Refresh	<ul style="list-style-type: none">➤ The unit will be reverted to its initial state.➤ All data files that were saved to the default personal folders (Documents, Pictures, etc.) will still be available once the operation is complete.➤ If you have installed products and updates since you purchased your unit, you will have to reinstall them.➤ Refer to Microsoft documentation for more information.
Reset	<ul style="list-style-type: none">➤ The unit will be reverted to its initial state.➤ All data files will be lost once the operation is complete.➤ If you have installed products and updates since you purchased your unit, you will have to reinstall them.➤ Refer to Microsoft documentation for more information.
Restore	<ul style="list-style-type: none">➤ The unit will be reverted to the state in which it was when the WIM file was created.➤ All data files will be lost once the operation is complete.➤ If you have installed products and updates since the WIM file was created, you will have to reinstall them.

Troubleshooting

Restoring Your Controller Unit to Normal Operation



CAUTION

- Before starting one of the recovery operations, connect your unit to a power outlet using the provided AC adapter/charger.
- **DO NOT TURN OFF** your unit while the recovery operation is underway. Doing so may severely damage your unit. Damaged units will need to be sent back to EXFO for repairs.



IMPORTANT

- **Refresh operation:** All the data that is stored in the default personal folders will still be available once the operation is complete. However, any data stored in other folders will be lost. You may want to back up this data before refreshing your unit.
- **Reset and restore operations:** To avoid losing the data that is stored on your unit, you may want to back it up before resetting or restoring your unit. Otherwise, all your files will be lost.

To revert your unit to a previous state:

- 1.** Ensure that your unit will remain powered on during the operation by connecting it to a power outlet using the provided AC adapter/charger.
- 2.** If desired, back up your data.
- 3.** On your platform, put the mouse cursor on the upper or lower right corners of the window to display the Charm bar.

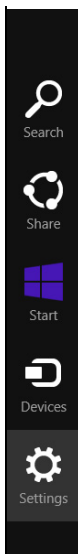

Troubleshooting

Restoring Your Controller Unit to Normal Operation

4. Click **Settings > Change PC settings.**

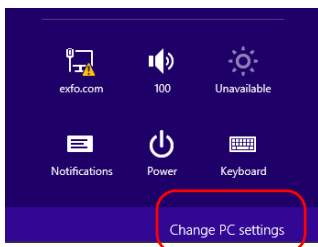

5. Click **Update and recovery.**

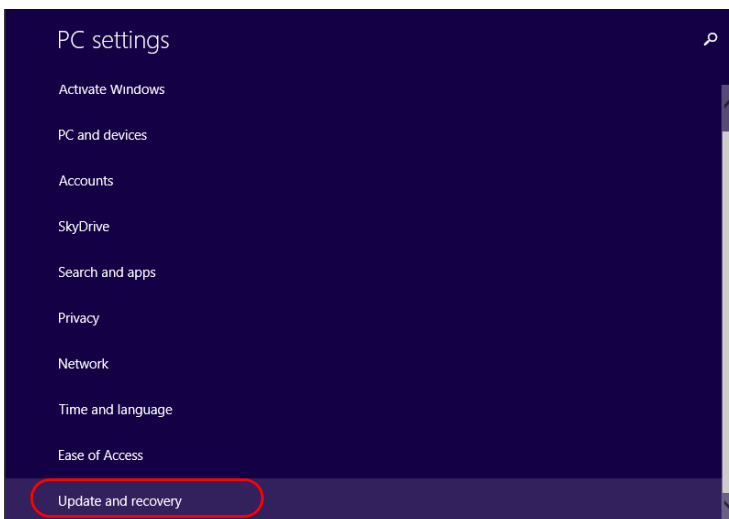

6. Click **Recovery**.

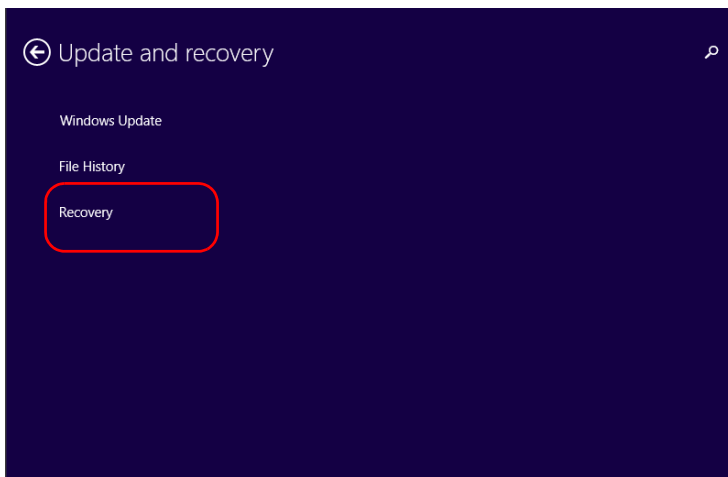

7. If you want to refresh or reset your unit, proceed as follows:

7a. Select the **Get started** button corresponding to your choice.

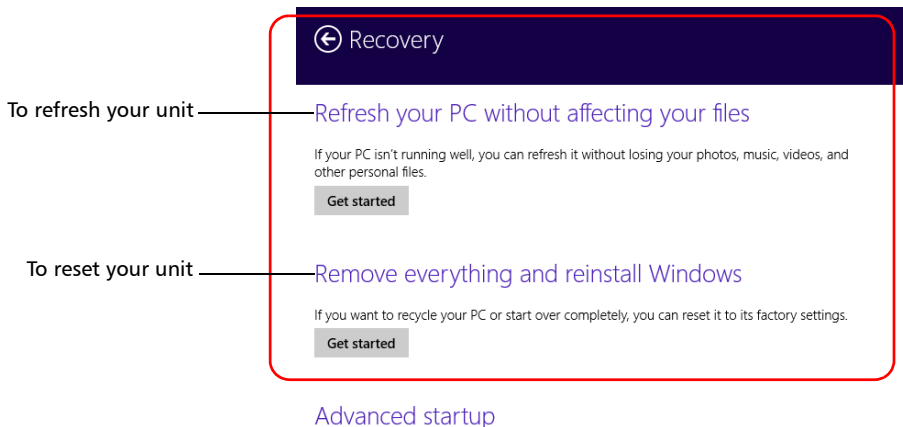

7b. Follow the on-screen instructions.

Troubleshooting

Restoring Your Controller Unit to Normal Operation

8. If you want to restore your unit (with a WIM file), proceed as follows:

8a. Under **Advanced Startup**, click **Restart now**.

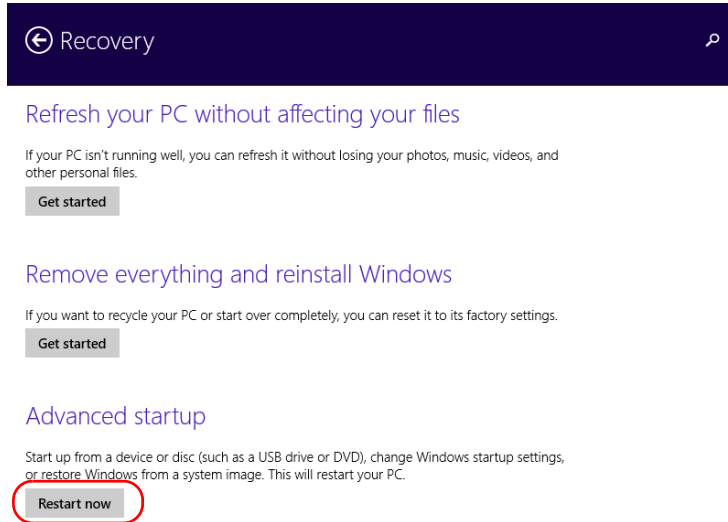

8b. Under **Choose an option**, click **Troubleshoot**.

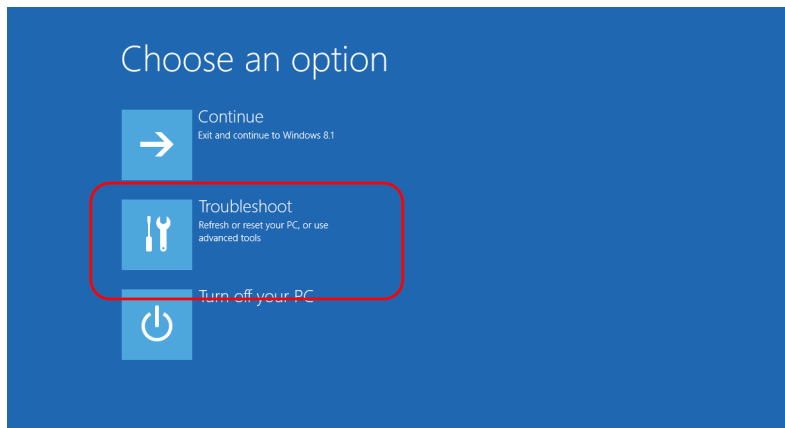

- 8c.** Click **Platform Imaging Utility** to display the corresponding application.

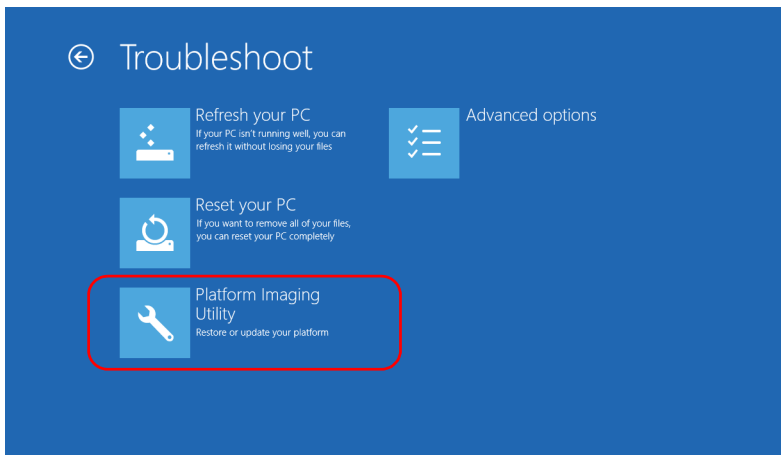

- 8d.** Connect the USB key with the desired WIM file to your unit.

Troubleshooting

Restoring Your Controller Unit to Normal Operation

- 8e.** From the Platform Servicing and Imaging Utility wizard, select **Restore unit from a WIM file**, and then click **Next**.

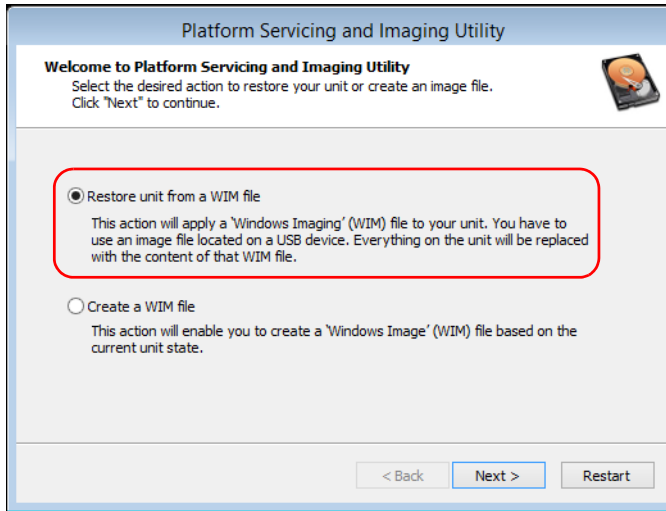

- 8f.** Click **Browse**.

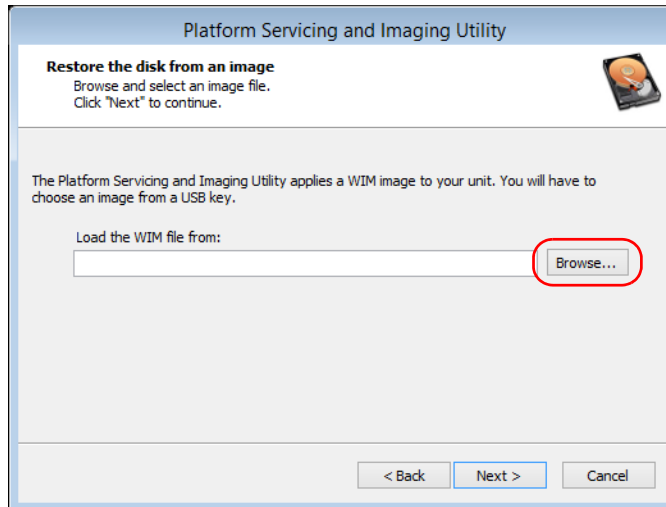

- 8g.** Locate the USB key, and then double-click its identifier to access the contents.
- 8h.** Select the desired WIM file.
- 8i.** Click **Next**.

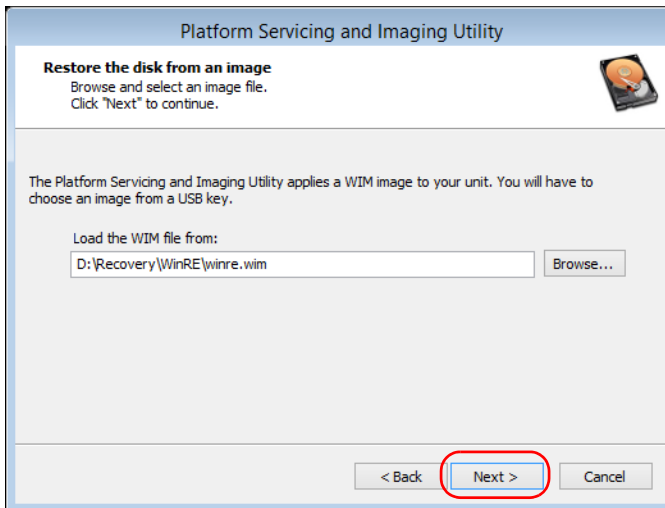

- 8j.** Read the warning, and then click **Start** to restore the unit with the selected image.
- 8k.** When the operation is complete and the application prompts you, disconnect the USB key, and then click **OK**.
The unit will restart.

Troubleshooting

Restoring Your Controller Unit to Normal Operation



IMPORTANT

The creation of a WIM file implies a compression of the files that are currently installed on your unit. The size of the files after compression cannot be estimated beforehand.

For this reason, the application **WILL NOT PROMPT YOU AT THE BEGINNING** of the operation if the storage capacity (or the file system) of your USB key is not appropriate.

To avoid problems, always use a USB key with an NTFS file system, and a minimum of 16 GB of free disk space.

To create a WIM file for your unit:

1. On your platform, put the mouse cursor on the upper or lower right corners of the window to display the Charm bar.

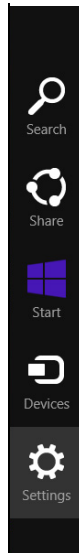

2. Click **Settings > Change PC settings**.

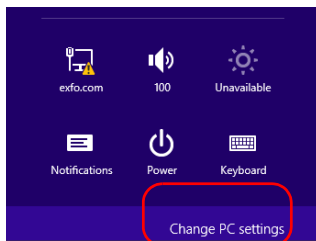

3. Click **Update and recovery**.

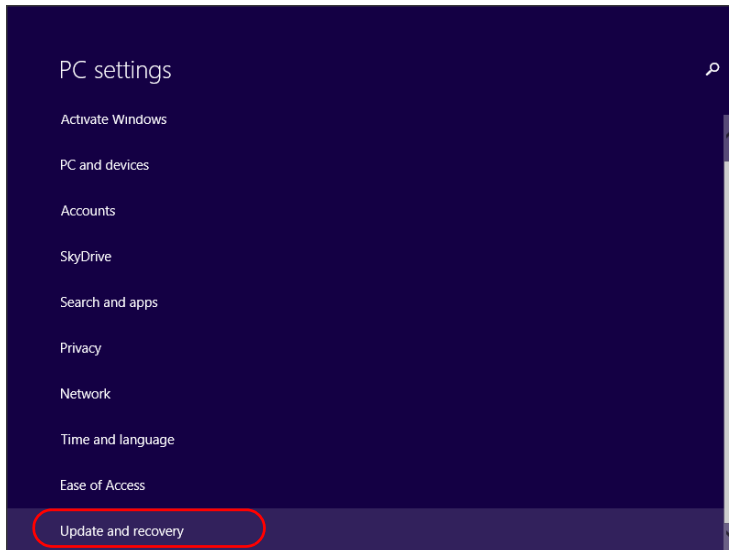

Troubleshooting

Restoring Your Controller Unit to Normal Operation

4. Click **Recovery.**

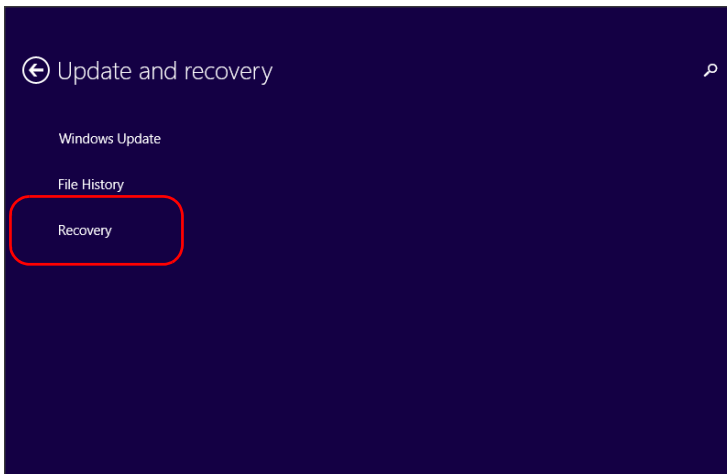

5. Under **Advanced Startup, click **Restart now**.**

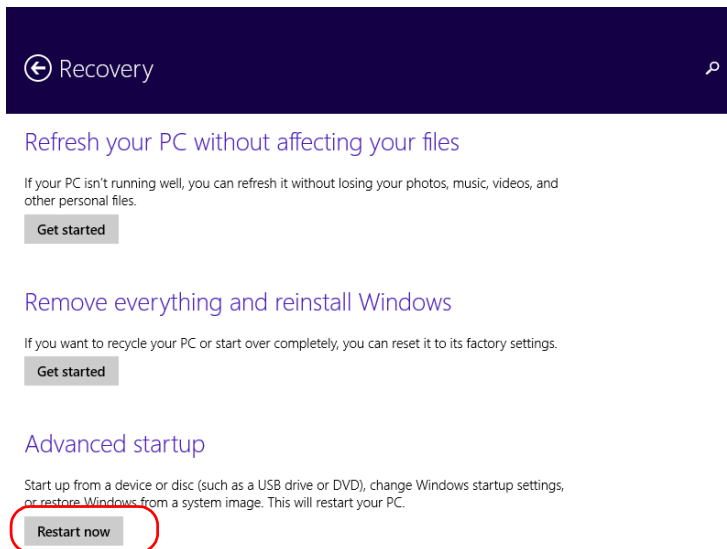

- Under **Choose an option**, click **Troubleshoot**.

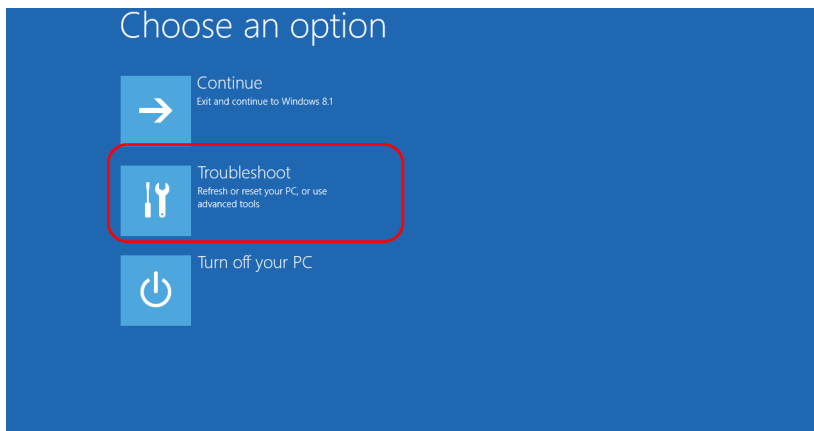

- Click **Platform Imaging Utility** to display the corresponding application.

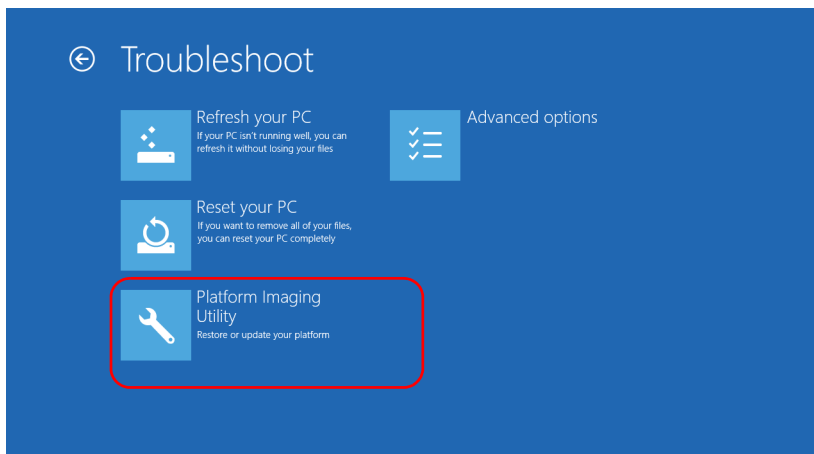

Troubleshooting

Restoring Your Controller Unit to Normal Operation

8. Connect a USB key to your unit.
9. From the Platform Servicing and Imaging Utility wizard, select **Create a WIM file**, and then click **Next**.

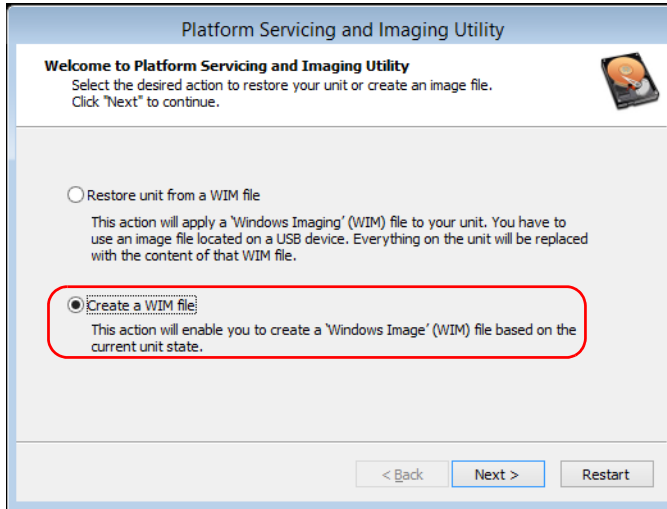

10. Click **Browse**.

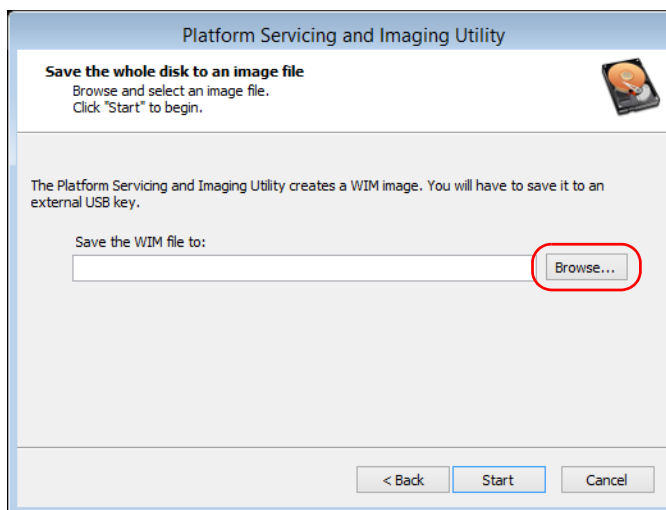

11. Locate the USB key, and then double-click its identifier to access the contents.

12. Select the desired folder.

13. Enter a file name, and then click **Save**.

Troubleshooting

Restoring Your Controller Unit to Normal Operation

14. Click Start.

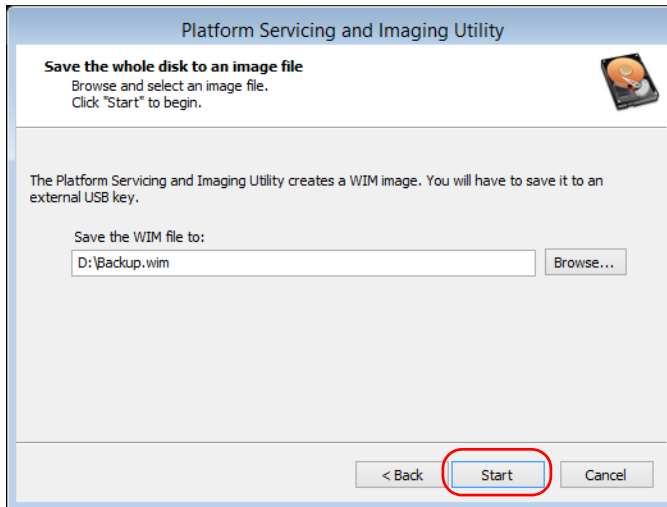

Note: *The time required to create the image varies with the configuration of your unit.*

15. When the operation is complete and the application prompts you, click **OK**.

16. Disconnect the USB key.

Viewing Online Documentation

An online version of the IQS-600 Integrated Qualification System user guide is available at all times from the application.

To access the online user guide:

Click **Help** in the function bar.

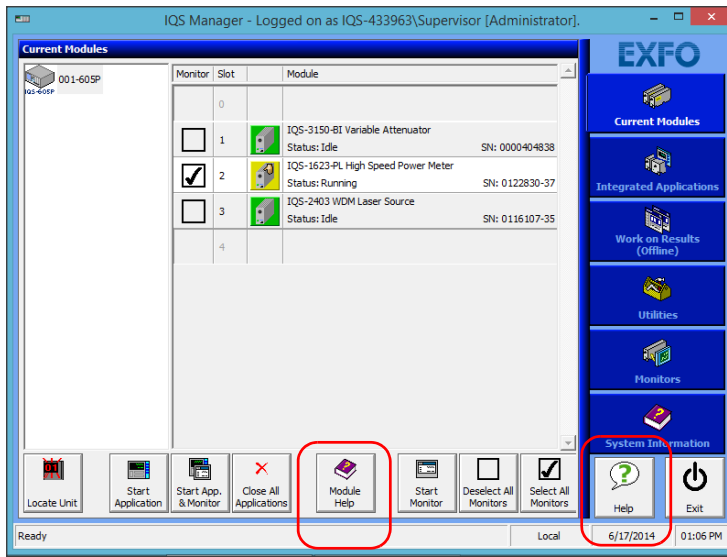

You can also open the online help of the current module by selecting the module and clicking **Module Help**.

Troubleshooting

Contacting the Technical Support Group

Contacting the Technical Support Group

To obtain after-sales service or technical support for this product, contact EXFO at one of the following numbers. The Technical Support Group is available to take your calls from Monday to Friday, 8:00 a.m. to 7:00 p.m. (Eastern Time in North America).

Technical Support Group

400 Godin Avenue
Quebec (Quebec) G1M 2K2
CANADA

1 866 683-0155 (USA and Canada)
Tel.: 1 418 683-5498
Fax: 1 418 683-9224
support@exfo.com

For detailed information about technical support, and for a list of other worldwide locations, visit the EXFO Web site at www.exfo.com.

If you have comments or suggestions about this user documentation, you can send them to customer.feedback.manual@exfo.com.

To accelerate the process, please have information such as the name and the serial number (see the product identification label), as well as a description of your problem, close at hand.

Viewing System Information

The **System Information** function tab contains important information about your system such as installed kits, components, and part number. To access the **System Information** function tab, click the corresponding tab on the right side of the screen.

Consulting the About Tab

The **About** tab contains information on how to contact EXFO.

To access the About tab:

1. From the main window, select the **System Information** function tab.

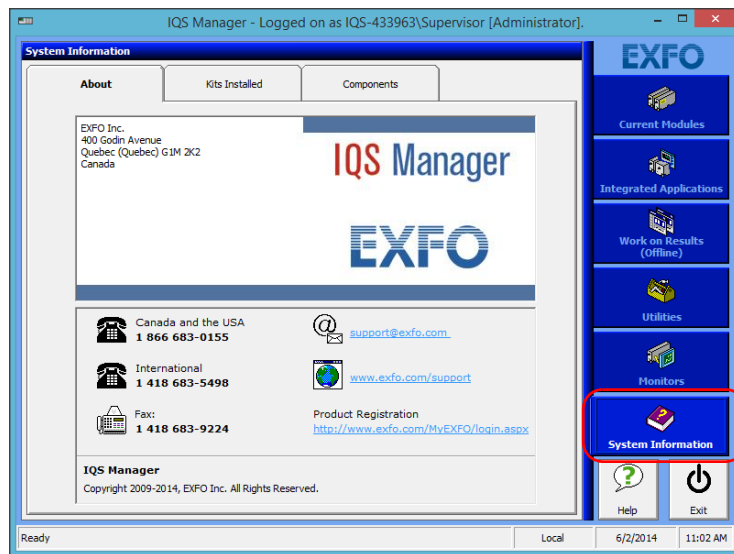

2. Select the **About** tab to view contact details.

Troubleshooting

Viewing System Information

Consulting the Kits Installed Tab

The **Kits Installed** tab allows you to view which kits are installed on your unit. Examples of kits are IQS Manager itself or any integrated application installed on the unit.

To access the Kits Installed tab:

1. From the main window, select the **System Information** function tab.

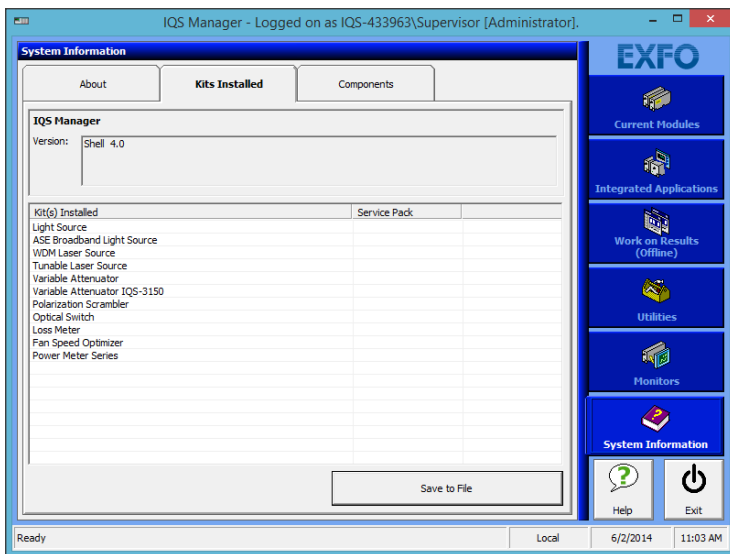

2. Select **Kits Installed** to view which kits are installed on your unit.

The first column represents a description of every installed item, the second gives you the item version, and the third column gives you the serial number.

The last two columns are particularly important if you are contacting EXFO's Technical Support group, as the version and serial numbers helps to pinpoint and solve your problem more rapidly.

To save a text format (.TXT) of the installed kit list, click **Save to File**. The list is automatically saved as *EXFO Kits Installed List.TXT* in *C:\Users\Public\Documents\EXFO\IQS Manager\User Files*. Click **OK** to acknowledge and close the pop-up window.

Note: *You cannot change the filename for this list. If you save the list a second time, the first list will be overwritten. To avoid this, you must go to C:\Users\Public\Documents\EXFO\IQS Manager\User Files and rename the first list.*

Troubleshooting

Viewing System Information

Consulting the Components Tab

The **Components** tab provides a list of all the applications installed on your unit.

To access the Components tab:

In the **System Information** window, select the **Components** function tab to see a list of the applications on your system.



You can also see which version of the applications you have, their type, and their location on your drive.

To save a text format (.TXT) of the component list, click **Save to File**. The list is automatically saved as *EXFO Components List.TXT* on C:\Users\Public\Documents\EXFO\IQS Manager\User Files. Click **OK** to acknowledge and exit the pop-up window.

Note: *You cannot change the filename for this list. If you save the list a second time, the first list will be overwritten. To avoid this, you must go to C:\Users\Public\Documents\EXFO\IQS Manager\User Files and rename the first list.*

Transportation

Maintain a temperature range within specifications when transporting the unit. Transportation damage can occur from improper handling. The following steps are recommended to minimize the possibility of damage:

- Pack the unit in its original packing material when shipping.
- Avoid high humidity or large temperature fluctuations.
- Keep the unit out of direct sunlight.
- Avoid unnecessary shocks and vibrations.

11 **Warranty**

General Information

EXFO Inc. (EXFO) warrants this equipment against defects in material and workmanship for a period of two years from the date of original shipment. EXFO also warrants that this equipment will meet applicable specifications under normal use.

During the warranty period, EXFO will, at its discretion, repair, replace, or issue credit for any defective product, as well as verify and adjust the product free of charge should the equipment need to be repaired or if the original calibration is erroneous. If the equipment is sent back for verification of calibration during the warranty period and found to meet all published specifications, EXFO will charge standard calibration fees.

THIS WARRANTY IS IN LIEU OF ALL OTHER WARRANTIES EXPRESSED, IMPLIED, OR STATUTORY, INCLUDING, BUT NOT LIMITED TO, THE IMPLIED WARRANTIES OF MERCHANTABILITY AND FITNESS FOR A PARTICULAR PURPOSE. IN NO EVENT SHALL EXFO BE LIABLE FOR SPECIAL, INCIDENTAL, OR CONSEQUENTIAL DAMAGES.

Liability

EXFO shall not be liable for damages resulting from the use of the product, nor shall be responsible for any failure in the performance of other items to which the product is connected or the operation of any system of which the product may be a part.

EXFO shall not be liable for damages resulting from improper usage or unauthorized modification of the product, its accompanying accessories and software.

Warranty

Exclusions

Exclusions

EXFO reserves the right to make changes in the design or construction of any of its products at any time without incurring obligation to make any changes whatsoever on units purchased. Accessories, including but not limited to fuses, pilot lamps, batteries and universal interfaces (EUI) used with EXFO products are not covered by this warranty.

This warranty excludes failure resulting from: improper use or installation, normal wear and tear, accident, abuse, neglect, fire, water, lightning or other acts of nature, causes external to the product or other factors beyond the control of EXFO.

Certification

EXFO certifies that this equipment met its published specifications at the time of shipment from the factory.

Service and Repairs

EXFO commits to providing product service and repair for five years following the date of purchase.

To send any equipment for service or repair:

- 1.** Call one of EXFO's authorized service centers (see *EXFO Service Centers Worldwide* on page 248). Support personnel will determine if the equipment requires service, repair, or calibration.
- 2.** If equipment must be returned to EXFO or an authorized service center, support personnel will issue a Return Merchandise Authorization (RMA) number and provide an address for return.
- 3.** If possible, back up your data before sending the unit for repair.
- 4.** Pack the equipment in its original shipping material. Be sure to include a statement or report fully detailing the defect and the conditions under which it was observed.
- 5.** Return the equipment, prepaid, to the address given to you by support personnel. Be sure to write the RMA number on the shipping slip. *EXFO will refuse and return any package that does not bear an RMA number.*

Note: *A test setup fee will apply to any returned unit that, after test, is found to meet the applicable specifications.*

After repair, the equipment will be returned with a repair report. If the equipment is not under warranty, you will be invoiced for the cost appearing on this report. EXFO will pay return-to-customer shipping costs for equipment under warranty. Shipping insurance is at your expense.

Routine recalibration is not included in any of the warranty plans. Since calibrations/verifications are not covered by the basic or extended warranties, you may elect to purchase FlexCare Calibration/Verification Packages for a definite period of time. Contact an authorized service center (see *EXFO Service Centers Worldwide* on page 248).

Warranty

EXFO Service Centers Worldwide

EXFO Service Centers Worldwide

If your product requires servicing, contact your nearest authorized service center.

EXFO Headquarters Service Center

400 Godin Avenue
Quebec (Quebec) G1M 2K2
CANADA

1 866 683-0155 (USA and Canada)
Tel.: 1 418 683-5498
Fax: 1 418 683-9224
support@exfo.com

EXFO Europe Service Center

Winchester House, School Lane
Chandlers Ford, Hampshire S053 4DG
ENGLAND

Tel.: +44 2380 246800
Fax: +44 2380 246801
support.europe@exfo.com

EXFO Telecom Equipment (Shenzhen) Ltd.

3rd Floor, Building 10,
Yu Sheng Industrial Park (Gu Shu
Crossing), No. 467,
National Highway 107,
Xixiang, Bao An District,
Shenzhen, China, 518126

Tel: +86 (755) 2955 3100
Fax: +86 (755) 2955 3101
support.asia@exfo.com

To view EXFO's network of partner-operated Certified Service Centers nearest you, please consult EXFO's corporate website for the complete list of service partners:

<http://www.exfo.com/support/services/instrument-services/exfo-service-centers>.

A *Technical Specifications*

Note: *The IQS-600 Integrated Qualification System is intended for indoor use only.*



IMPORTANT

The following technical specifications can change without notice. The information presented in this section is provided as a reference only. To obtain this product's most recent technical specifications, visit the EXFO Web site at www.exfo.com.

SPECIFICATIONS	
IQS-605P-HS and IQS-610P-HS	Industrial motherboard, dual-core processor, 2 GB RAM
CPU	Industrial motherboard, dual-core processor, 2 GB RAM
Display (IQS-605P-HS only)	8.4 in touchscreen, 800 x 600 color TFT
Interfaces	Dual 10/100/1000 Base-T Ethernet Serial RS-232 Parallel port External monitor port Six USB ports External keyboard/mouse EXFO bus III output
Storage	Internal 160 GB hard drive (minimum) Internal DVD+RW
Size (H x W x D)	
IQS-610P-HS	177 mm x 439 mm x 495 mm (7 in x 17 ¼ in x 19 ½ in)
IQS-605P-HS	177 mm x 439 mm x 495 mm (7 in x 17 ¼ in x 19 ½ in)
Weight	
IQS-610P-HS	16.6 kg (36.7 lb)
IQS-605P-HS	16.5 kg (36.3 lb)
Temperature	
Operating	0 °C to 40 °C (32 °F to 104 °F)
Storage	-40 °C to 70 °C (-40 °F to 158 °F)
Relative humidity	0 % to 80 % non-condensing at 40 °C
IQS-610E-HS	
Interface	EXFO bus III input/output
Power	100 V to 240 V, 50/60 Hz
Size (H x W x D)	133 mm x 439 mm x 495 mm (5 ¼ in x 17 ¼ in x 19 ½ in)
Weight	13.0 kg (28.8 lb)
Temperature	
Operating	0 °C to 40 °C (32 °F to 104 °F)
Storage	-40 °C to 70 °C (-40 °F to 158 °F)
Relative humidity	0 % to 80 % non-condensing at 40 °C

Technical Specifications

Software and drivers	
Operating system ^b	Windows 8.1 Pro
EXFO software	IQS Manager
Local control	ActiveX/COM library using SCPI commands ^a LabVIEW drivers using ActiveX/COM library
Remote control	
Ethernet	ActiveX/COM library using SCPI commands ^a LabVIEW drivers using ActiveX/COM library
GPIB	SCPI commands or LabVIEW drivers
RS-232	SCPI commands or LabVIEW drivers

ACCESSORIES			
GP-130	GPIB cable (2 m/6 ft)	GP-3004	IQS blank plate
GP-228	0.8 m/2.5 ft interface cable	GP-3013	Rackmount brackets for IQS-600 controllers (kit of 2)
GP-229	1.5 m/5 ft interface cable	GP-3023	Rackmount brackets for IQS-610E (kit of 2)
GP-3000	Carrying case for one IQS-600 platform (platform only, no space available for modules)	GP-3024	USB mouse
GP-3001	Carrying case for 10 modules (modules only, no space available for platform)	GP-3025	External USB keyboard
GP-3003	GPIB master/slave card		

Notes

- a. Compatible with Microsoft .NET "T&M Programmers' Tool Kit".
- b. Some IQS-605P functionalities will not be supported with Windows 8.1 Pro.

B *SCPI-Based Errors*

Error Number	Description	Probable Cause
-100	“Command error”	This is the generic syntax error for devices that cannot detect more specific errors. This code indicates only that a Command Error as defined in IEEE 488.2, 11.5.1.1.4 has occurred.
-101	“Invalid character”	A syntactic element contains a character which is invalid for that type; for example, a header containing an ampersand, SETUP&. This error might be used in place of errors -114, -121, -141, and perhaps some others.
-102	“Syntax error”	An unrecognized command or data type was encountered; for example, a string was received when the device does not accept strings.
-103	“Invalid separator”	The parser was expecting a separator and encountered an illegal character; for example, the semicolon was omitted after a program message unit, *EMC 1:CH1:VOLTS 5.
-104	“Data type error”	The parser recognized a data element different than one allowed; for example, numeric or string data was expected but block data was encountered.
-105	“GET not allowed”	A Group Execute Trigger was received within a program message (see IEEE 488.2, 7.7).
-108	“Parameter not allowed”	More parameters were received than expected for the header; for example, the *EMC common command only accepts one parameter, so receiving *EMC 0,1 is not allowed.
-109	“Missing parameter”	Fewer parameters were received than required for the header; for example, the *EMC common command requires one parameter, so receiving *EMC is not allowed.

SCPI-Based Errors

Error Number	Description	Probable Cause
-110	“Command header error”	An error was detected in the header. This error message should be used when the device cannot detect the more specific errors described for errors -111 through -119.
-111	“Header separator error”	A character which is not a legal header separator was encountered while parsing the header; for example, no white space followed the header, thus *GMC"MACRO" is an error.
-112	“Program mnemonic too long”	The header contains more than twelve characters (see IEEE 488.2, 7.6.1.4.1).
-113	“Undefined header”	The header is syntactically correct, but it is undefined for this specific device; for example, *XYZ is not defined for any device.
-114	“Header suffix out of range”	The value of a numeric suffix attached to a program mnemonic makes the header invalid.
-115	“Unexpected number of parameters”	The number of parameters received does not correspond to the number of parameters expected. This is typically due to an inconsistency with the number of instruments in the selected group (see section on INSTRUMENT:DEFine:GROup).
-120	“Numeric data error”	This error, as well as errors -121 through -129, are generated when parsing a data element which appears to be numeric, including the non-decimal numeric types. This particular error message should be used if the device cannot detect a more specific error.
-121	“Invalid character in number”	An invalid character for the data type being parsed was encountered; for example, an alpha in a decimal numeric or a “9” in octal data.

Error Number	Description	Probable Cause
-123	“Exponent too large”	The magnitude of the exponent was larger than 32000 (see IEEE 488.2, 7.7.2.4.1).
-124	“Too many digits”	The mantissa of a decimal numeric data element contained more than 255 digits, excluding leading zeros (see IEEE 488.2, 7.7.2.4.1).
-128	“Numeric data not allowed”	A legal numeric data element was received, but the device does not accept one in this position for the header.
-130	“Suffix error”	This error, as well as errors -131 through -139, are generated when parsing a suffix. This particular error message should be used if the device cannot detect a more specific error.
-131	“Invalid suffix”	The suffix does not follow the syntax described in IEEE 488.2, 7.7.3.2, or the suffix is inappropriate for this device.
-134	“Suffix too long”	The suffix contained more than 12 characters (see IEEE 488.2, 7.7.3.4).
-138	“Suffix not allowed”	A suffix was encountered after a numeric element which does not allow suffixes.
-140	“Character data error”	This error, as well as errors -141 through -149, are generated when parsing a character data element. This particular error message should be used if the device cannot detect a more specific error.
-141	“Invalid character data”	Either the character data element contains an invalid character, or the particular element received is not valid for the header.
-144	“Character data too long”	The character data element contains more than twelve characters (see IEEE 488.2, 7.7.1.4).
-148	“Character data not allowed”	A legal character data element was encountered where prohibited by the device.

SCPI-Based Errors

Error Number	Description	Probable Cause
-150	“String data error”	This error, as well as errors –151 through –159, are generated when parsing a string data element. This particular error message should be used if the device cannot detect a more specific error.
-151	“Invalid string data”	A string data element was expected, but was invalid for some reason (see IEEE 488.2, 7.7.5.2); for example, an END message was received before the terminal quote character.
-158	“String data not allowed”	A string data element was encountered but was not allowed by the device at this point in parsing.
-160	“Block data error”	This error, as well as errors –161 through –169, are generated when parsing a block data element. This particular error message should be used if the device cannot detect a more specific error.
-161	“Invalid block data”	A block data element was expected, but was invalid for some reason (see IEEE 488.2, 7.7.6.2); for example, an END message was received before the length was satisfied.
-168	“Block data not allowed”	A legal block data element was encountered but was not allowed by the device at this point in parsing.
-170	“Expression error”	This error, as well as errors –171 through –179, are generated when parsing an expression data element. This particular error message should be used if the device cannot detect a more specific error.
-171	“Invalid expression”	The expression data element was invalid (see IEEE 488.2, 7.7.7.2); for example, unmatched parentheses or an illegal character.
-178	“Expression data not allowed”	A legal expression data was encountered but was not allowed by the device at this point in parsing.

Error Number	Description	Probable Cause
-180	"Macro error"	This error, as well as errors -181 through -189, are generated when defining a macro or executing a macro. This particular error message should be used if the device cannot detect a more specific error.
-181	"Invalid outside macro definition"	Indicates that a macro parameter placeholder ($\$<number>$) was encountered outside of a macro definition.
-183	"Invalid inside macro definition"	Indicates that the program message unit sequence, sent with a *DDT or *DMC command, is syntactically invalid (see IEEE 488.2, 10.7.6.3).
-184	"Macro parameter error"	Indicates that a command inside the macro definition had the wrong number or type of parameters.
-200	"Execution error"	This is the generic syntax error for devices that cannot detect more specific errors. This code indicates only that an Execution Error as defined in IEEE 488.2, 11.5.1.1.5 has occurred.
-201	"Invalid while in local"	Indicates that a command is not executable while the device is in local due to a hard local control (see IEEE 488.2, 5.6.1.5); for example, a device with a rotary switch receives a message which would change the switches state, but the device is in local so the message can not be executed.
-202	"Settings lost due to rtl"	Indicates that a setting associated with a hard local control (see IEEE 488.2, 5.6.1.5) was lost when the device changed to LOCS from REMS or to LWLS from RWLS.
-203	"Command protected"	Indicates that a legal password-protected program command or query could not be executed because the command was disabled.

SCPI-Based Errors

Error Number	Description	Probable Cause
-210	“Trigger error”	-----
-211	“Trigger ignored”	Indicates that a GET, *TRG, or triggering signal was received and recognized by the device but was ignored because of device timing considerations; for example, the device was not ready to respond. Note: a DT0 device always ignores GET and treats *TRG as a Command Error.
-212	“Arm ignored”	Indicates that an arming signal was received and recognized by the device but was ignored.
-213	“Init ignored”	Indicates that a request for a measurement initiation was ignored as another measurement was already in progress.
-214	“Trigger deadlock”	Indicates that the trigger source for the initiation of a measurement is set to GET and subsequent measurement query is received. The measurement cannot be started until a GET is received, but the GET would cause an INTERRUPTED error.
-215	“Arm deadlock”	Indicates that the arm source for the initiation of a measurement is set to GET and subsequent measurement query is received. The measurement cannot be started until a GET is received, but the GET would cause an INTERRUPTED error.
-220	“Parameter error”	Indicates that a program data element related error occurred. This error message should be used when the device cannot detect the more specific errors described for errors -221 through -229.
-221	“Settings conflict”	Indicates that a legal program data element was parsed but could not be executed due to the current device state (see IEEE 488.2, 6.4.5.3 and 11.5.1.1.5.)

Error Number	Description	Probable Cause
-222	"Data out of range"	Indicates that a legal program data element was parsed but could not be executed because the interpreted value was outside the legal range as defined by the device (see IEEE 488.2, 11.5.1.1.5.)
-223	"Too much data"	Indicates that a legal program data element of block, expression, or string type was received and contained more data than the device could handle due to memory or related device-specific requirements.
-224	"Illegal parameter value"	Used where an exact value, from a list of possible choices, was expected.
-225	"Out of memory"	The device has insufficient memory to perform the requested operation.
-226	"Lists not same length"	Attempted to use LIST structure having individual LIST's of unequal lengths.
-230	"Data corrupt or stale"	Possibly invalid data; new reading started but not completed since last access.
-231	"Data questionable"	Indicates that measurement accuracy is suspicious.
-232	"Invalid format"	Indicates that a legal program data element was parsed but could not be executed because the data format or structure is inappropriate. For example when loading memory tables or when sending a SYSTEM:SET parameter from an unknown instrument.

SCPI-Based Errors

Error Number	Description	Probable Cause
-233	“Invalid version”	Indicates that a legal program data element was parsed but could not be executed because the version of the data is incorrect to the device. This particular error should be used when file or block data formats are recognized by the instrument but cannot be executed for reasons of version incompatibility. For example, file or instrument version that are not supported.
-240	“Hardware error”	Indicates that a legal program command or query could not be executed because of a hardware problem in the device. The definition of what constitutes a hardware problem is completely device-specific. This error message should be used when the device cannot detect the more specific errors described for errors -241 through -249.
-241	“Hardware missing”	Indicates that a legal program command or query could not be executed because of missing device hardware; for example, an option was not installed. The definition of what constitutes missing hardware is completely device-specific.
-250	“Mass storage error”	Indicates that a mass storage error occurred. This error message should be used when the device cannot detect the more specific errors described for errors -251 through -259.
-251	“Missing mass storage”	Indicates that a legal program command or query could not be executed because of missing mass storage; for example, an option that was not installed. The definition of what constitutes missing mass storage is device-specific.
-252	“Missing media”	Indicates that a legal program command or query could not be executed because of a missing media; for example, no disk. The definition of what constitutes missing media is device-specific.

Error Number	Description	Probable Cause
-253	"Corrupt media"	Indicates that a legal program command or query could not be executed because of corrupt media; for example, bad disk or wrong format. The definition of what constitutes corrupt media is device-specific.
-254	"Media full"	Indicates that a legal program command or query could not be executed because the media was full; for example, there is no room on the disk. The definition of what constitutes a full media is device-specific.
-255	"Directory full"	Indicates that a legal program command or query could not be executed because the media directory was full. The definition of what constitutes a full media directory is device-specific.
-256	"File name not found"	Indicates that a legal program command or query could not be executed because the file name on the device media was not found; for example, an attempt was made to read or copy a nonexistent file. The definition of what constitutes a file not being found is device-specific.
-257	"File name error"	Indicates that a legal program command or query could not be executed because the file name on the device media was in error; for example, an attempt was made to copy to a duplicate file name. The definition of what constitutes a file name error is device-specific.
-258	"Media protected"	Indicates that a legal program command or query could not be executed because the media was protected; for example, the write-protect tab on a disk was present. The definition of what constitutes protected media is device-specific.

SCPI-Based Errors

Error Number	Description	Probable Cause
-260	“Expression error”	Indicates that an expression program data element related error occurred. This error message should be used when the device cannot detect the more specific errors described for errors -261 through -269.
-261	“Math error in expression”	Indicates that a syntactically legal expression program data element could not be executed due to a math error; for example, a divide-by-zero was attempted. The definition of math error is device-specific.
-270	“Macro error”	Indicates that a macro-related execution error occurred. This error message should be used when the device cannot detect the more specific errors described for errors -271 through -279.
-271	“Macro syntax error”	Indicates that a syntactically legal macro program data sequence, according to IEEE 488.2, 10.7.2, could not be executed due to a syntax error within the macro definition (see IEEE 488.2, 10.7.6.3.)
-272	“Macro execution error”	Indicates that a syntactically legal macro program data sequence could not be executed due to some error in the macro definition (see IEEE 488.2, 10.7.6.3.)
-273	“Illegal macro label”	Indicates that the macro label defined in the *DMC command was a legal string syntax, but could not be accepted by the device (see IEEE 488.2, 10.7.3 and 10.7.6.2); for example, the label was too long, the same as a common command header, or contained invalid header syntax.
-274	“Macro parameter error”	Indicates that the macro definition improperly used a macro parameter placeholder (see IEEE 488.2, 10.7.3).

Error Number	Description	Probable Cause
-275	“Macro definition too long”	Indicates that a syntactically legal macro program data sequence could not be executed because the string or block contents was too long for the device to handle (see IEEE 488.2, 10.7.6.1).
-276	“Macro recursion error”	Indicates that a syntactically legal macro program data sequence could not be executed because the device found it to be recursive (see IEEE 488.2, 10.7.6.6).
-277	“Macro redefinition not allowed”	Indicates that a syntactically legal macro label in the *DMC command could not be executed because the macro label was already defined (see IEEE 488.2, 10.7.6.4).
-278	“Macro header not found”	Indicates that a syntactically legal macro label in the *GMC? query could not be executed because the header was not previously defined.
-280	“Program error”	Indicates that a downloaded program-related execution error occurred. This error message should be used when the device cannot detect the more specific errors described for errors -281 through -289. A downloaded program is used to add algorithmic capability to a device. The syntax used in the program and the mechanism for downloading a program is device-specific.
-281	“Cannot create program”	Indicates that an attempt to create a program was unsuccessful. A reason for the failure might include insufficient memory.
-282	“”Illegal program name	The name used to reference a program was invalid; for example, redefining an existing program, deleting a nonexistent program, or in general, referencing a nonexistent program.
-283	“Illegal variable name”	An attempt was made to reference a nonexistent variable in a program.

SCPI-Based Errors

Error Number	Description	Probable Cause
-284	“Program currently running”	Certain operations dealing with programs may be illegal while the program is running; for example, deleting a running program might not be possible.
-285	“Program syntax error”	Indicates that a syntax error appears in a downloaded program. The syntax used when parsing the downloaded program is device-specific.
-286	“Program runtime error”	-----
-290	“Memory use error”	Indicates that a user request has directly or indirectly caused an error related to memory or <data_handle>, this is not the same as “bad” memory.
-291	“Out of memory”	-----
-292	“Referenced name does not exist”	-----
-293	“Referenced name already exist”	-----
-294	“Incompatible type”	Indicates that the type or structure of a memory item is inadequate.
-300	“Device-specific error”	This is the generic device-dependent error for devices that cannot detect more specific errors. This code indicates only that a Device-Dependent Error as defined in IEEE 488.2, 11.5.1.1.6 has occurred.
-310	“System error”	Indicates that some error, termed “system error” by the device, has occurred. This code is device-dependent.
-311	“Memory error”	Indicates some physical fault in the device's memory, such as parity error.

Error Number	Description	Probable Cause
-312	“PUD memory lost”	Indicates that the protected user data saved by the *PUD command has been lost.
-313	“Calibration memory lost”	Indicates that nonvolatile calibration data used by the *CAL? command has been lost.
-314	“Save/Recall memory lost”	Indicates that the nonvolatile data saved by the *SAV? command has been lost.
-315	“Configuration memory lost”	Indicates that nonvolatile configuration data saved by the device has been lost. The meaning of this error is device-specific.
-320	“Storage fault”	Indicates that the firmware detected a fault when using data storage. This error is not an indication of physical damage or failure of any mass storage element.
-321	“Out of memory”	An internal operation required more memory than was available.
-330	“Self-test failed”	-----
-340	“Calibration failed”	-----
-350	“Queue overflow”	A specific code entered into the queue in lieu of the code that caused the error. This code indicates that there is no room in the queue and an error occurred but was not recorded.
-360	“Communication error”	This is the generic communication error for devices that cannot detect the more specific errors described for errors -361 through -363.
-361	“Parity error in program message”	Parity bit not correct when data received, for example, on a serial port.
-362	“Framing error in program message”	A stop bit was not detected when data was received for example, on a serial port (for example, a baud rate mismatch).

SCPI-Based Errors

Error Number	Description	Probable Cause
-363	“Input buffer overrun”	Software or hardware input buffer on serial port overflows with data caused by improper or nonexistent pacing.
-365	“Time out error”	This is a generic device-dependent error.
-400	“Query error”	This is the generic query error for devices that cannot detect more specific errors. This code indicates only that a Query Error as defined in IEEE 488.2, 11.5.1.1.7 and 6.3 has occurred.
-410	“Query INTERRUPTED”	Indicates that a condition causing an INTERRUPTED Query error occurred (see IEEE 488.2, 6.3.2.3); for example, a query followed by DAB or GET before a response was completely sent.
-420	“Query UNTERMINATED”	Indicates that a condition causing an UNTERMINATED Query error occurred (see IEEE 488.2, 6.3.2.2); for example, the device was addressed to talk and an incomplete program message was received.
-430	“Query DEADLOCKED”	Indicates that a condition causing an DEADLOCKED Query error occurred (see IEEE 488.2, 6.3.1.7); for example, both input and output buffers are full and the device cannot continue.
-440	“Query UNTERMINATED after indefinite response”	Indicates that a query was received in the same program message after an query requesting an indefinite response was executed (see IEEE 488.2, 6.5.7.5).
-500	“Power on”	The instrument has detected an off to on transition in its power supply.
-600	“User request”	The instrument has detected the activation of a user request local control

Error Number	Description	Probable Cause
-700	"Request control"	The instrument requested to become the active IEEE 488.1 controller-in-charge.
-800	"Operation complete"	The instrument has completed all selected pending operations in accordance with the IEEE 488.2, 12.5.2 synchronization protocol.

C Data Types

The following section provides an overview of the most common data types that may appear in EXFO's documentation on commands and queries. The information is supplied for guidance purposes only.

For more detailed information, please refer to IEEE 488.2 and SCPI standards. Additional reference sources are listed in *SCPI Command Structure* on page 187.

Data types are divided into two groups: <PROGRAM DATA> for the types that are used when you want to send messages to a device and <RESPONSE DATA> for the types that are used when a device sends responses to the controller unit.

The data types are presented in graphics often referred to as "railroad diagrams". The following example illustrates how to interpret such diagrams.

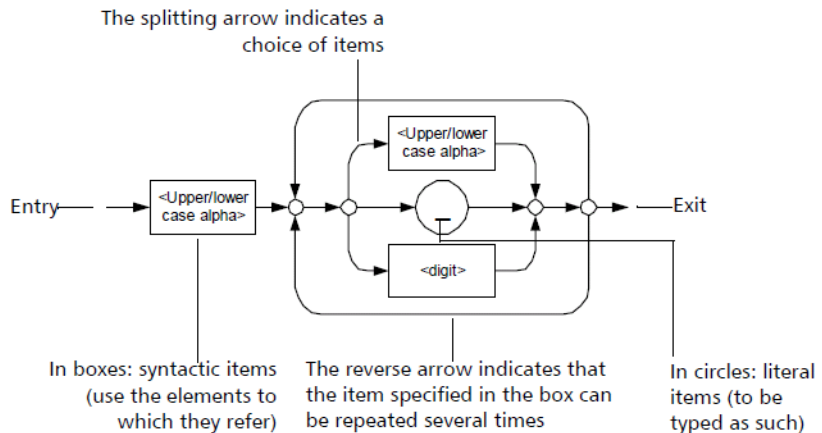

Data Types

Applicable Data Types for Input—IEEE 488.2

Applicable Data Types for Input—IEEE 488.2

- <PROGRAM MESSAGE TERMINATOR>

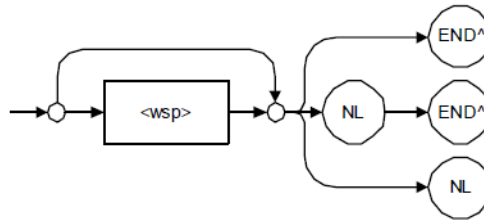

In the diagram above,

- “NL” corresponds to ASCII character code 10, in decimal (0A in binary)
- “END ^” corresponds to the last data byte of the message sent with EOI = True and ATN = False

➤ **<CHARACTER PROGRAM DATA>**

This data type is used to send short mnemonics when a *<DECIMAL NUMERIC PROGRAM DATA>* cannot be used.

Examples: TRIANGLEWAVE, NCONTINUOUS

➤ **<DECIMAL NUMERIC PROGRAM DATA>** (or **<NRf>**)

This data type includes **<NR1>**, **<NR2>** and **<NR3>** data types. It is used for decimal fractions with or without an exponent. Instruments adapt the values they receive to fit their degree of precision. For example, if an instrument has a precision of two digits after the decimal point and the incoming value is 12.048, this value is rounded off to 12.05.



The second diagram below illustrates the **<mantissa>** syntax.

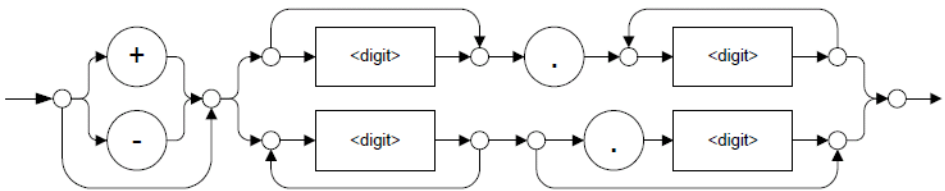

The third diagram illustrates the **<exponent>** syntax.

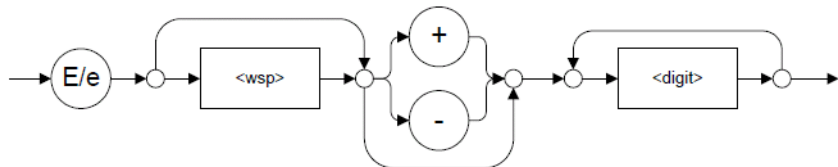

Examples: +2.0 e5, -.56E+4, 6.5e-10

Data Types

Applicable Data Types for Input—IEEE 488.2

➤ <NON-DECIMAL NUMERIC PROGRAM DATA>

This data type is used for integer representation in hexadecimal (base 16), octal (base 8) or binary (base 2). The numeric representations begin with “#H” for hexadecimal, “#Q” for octal and “#B” for binary.

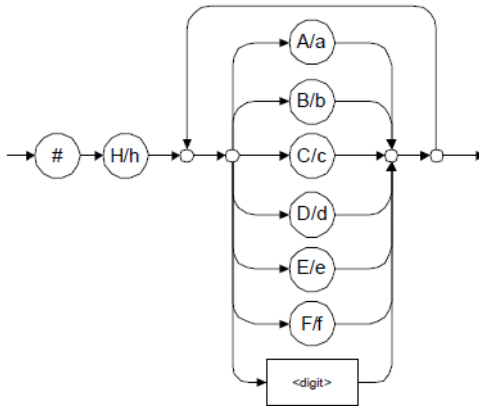

Examples: #Hf3bc015d, #h01a4, #hfe

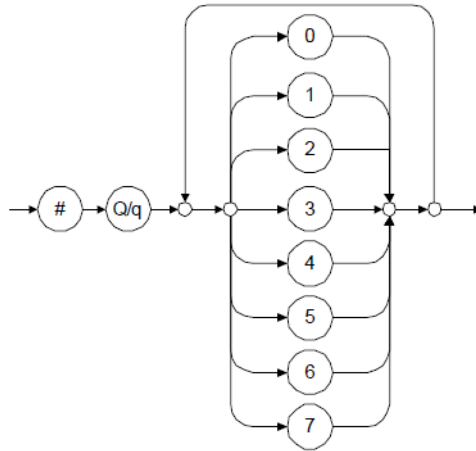

Examples: #Q1234567, #q1275, #q07

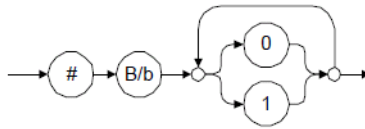

Examples: #B10010111, #b10110, #b1100

Data Types

Applicable Data Types for Input—IEEE 488.2

➤ <STRING PROGRAM DATA>

This data type is used for strings containing 7-bit ASCII characters that have to be enclosed in either single- or double-quotes delimiters.

If a string needs to contain a character that is exactly the same as the delimiter, make sure to double the character to avoid syntax errors.

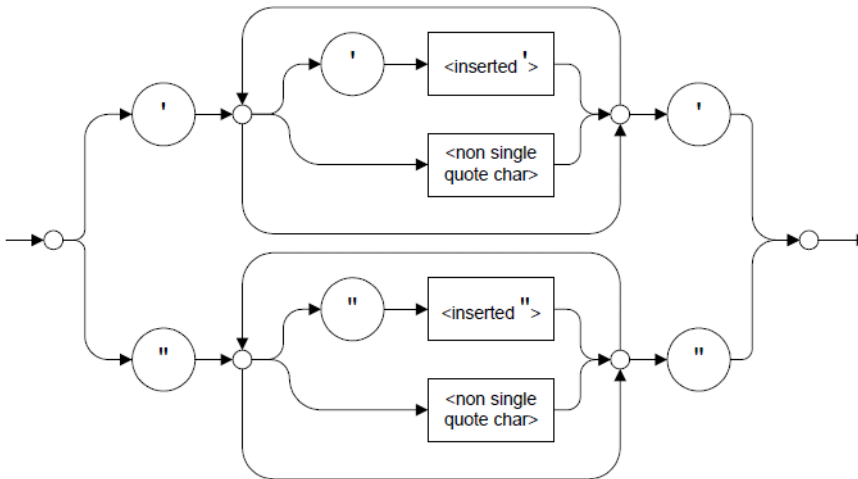

Examples: "SCPI Commands", 'SCPI Commands', "SCPI 'Commands'",
'SCPI "Commands"', "SCPI ""Commands""", 'SCPI '''Commands'''

➤ <ARBITRARY BLOCK PROGRAM DATA>

This data type is used to send blocks of arbitrary 8-bit information when you need to work with large amounts of data.

The actual length of the data that you send has the following structure:

- The first byte contains the # character.
- The byte that immediately follows contains the number of subsequent bytes that you have to check to obtain the total length.

Note: *If you use a zero as the first digit (#0), it has to be followed by a <PROGRAM MESSAGE TERMINATOR> to allow the device to detect the end of the <ARBITRARY BLOCK PROGRAM DATA>. This also triggers immediate termination of the message.*

For example, if you send the following data (here, values are expressed in decimal instead of binary for easier readability):

2 1 3 7 6 8 9 2 ...

The byte that immediately follows the # contains 2, which means that you would have to read the two following bytes to know the length (in bytes) of the retrieved data. The bytes indicate 1 and 3. The length is then 13 bytes. The actual response begins at byte number 5, in this case.

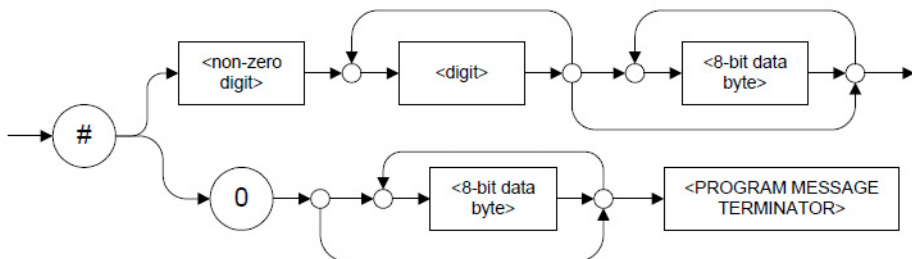

Data Types

Applicable Data Types for Input—IEEE 488.2

► <SUFFIX PROGRAM DATA>

This data type is used when units and multipliers have to be sent.

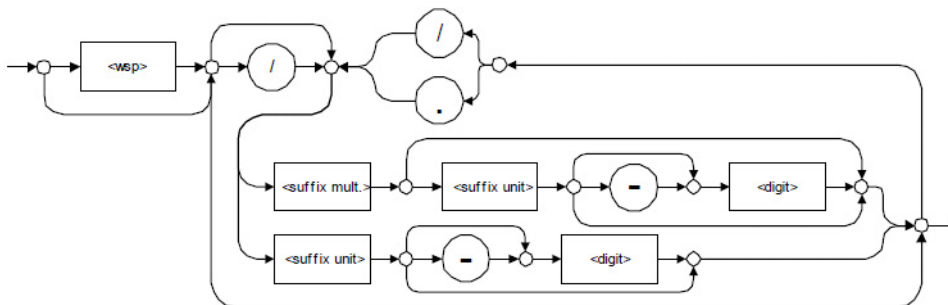

Examples: nm, kHz, km/s², uW

A relative unit (dB) can be referenced to an absolute level, as shown on the following diagram.

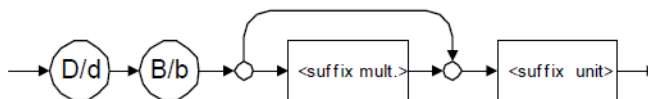

Examples: db, dbm, dBW

The table below illustrates the possible forms for <suffix mult.>:

Name	Value	Mnemonic
Exa	1E18	EX
Peta	1E15	PE
Tera	1E12	T
Giga	1E9	G
Mega	1E6	MA
Kilo	1E3	K
Milli	1E-3	M
Micro	1E-6	U
Nano	1E-9	N
Pico	1E-12	P
Femto	1E-15	F
Atto	1E-18	A

Data Types

Applicable Data Types for Input—IEEE 488.2

The table below gives the possible forms for <suffix unit> :

Reference Unit	Suffix Unit
Degrees	DEG
Radians	RAD
Amperes	A
Volts	V
Hertz	HZ
Meters	M
Watts	W
DBs ref to 1mW	DBM
Decibels	DB
Degrees Celsius	CEL
Degrees Fahrenheit	FAR
Kelvins	K
Seconds	S
Hours	HR
Minutes	MIN

Applicable Data Types for Output —IEEE 488.2

- <RESPONSE MESSAGE TERMINATOR>

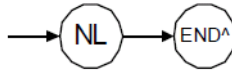

In the diagram above,

- “NL” corresponds to ASCII character code 10, in decimal (0A in binary)
- “END ^” corresponds to the last data byte of the message sent with EOI = True and ATN = False
- <CHARACTER RESPONSE DATA>

This data type is used by a device to return short mnemonics when a <DECIMAL NUMERIC PROGRAM DATA> cannot be used. The returned information is sent in the long form and in upper case.

Examples: TRIANGLEWAVE, NCONTINUOUS

Data Types

Applicable Data Types for Output —IEEE 488.2

- <NR1 NUMERIC RESPONSE DATA> (or <NR1>)

This data type is used by a device to return positive or negative integers.

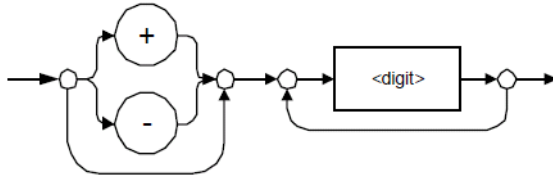

Examples: 4, -23, 90

- <NR2 NUMERIC RESPONSE DATA> (or <NR2>)

This data type is used by a device to return positive or negative real numbers (fixed-point numbers).

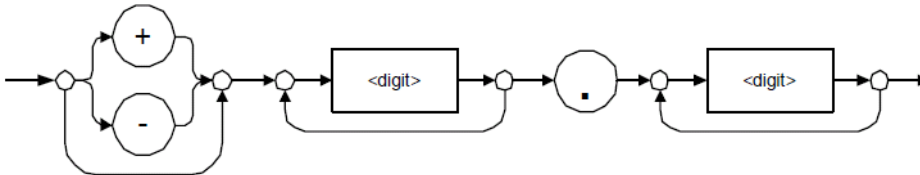

Examples: 23.45, 1.22, -4.55

➤ <NR3 NUMERIC RESPONSE DATA> (or <NR3>)

This data type is used by a device to return positive or negative exponential numbers (floating-point numbers).

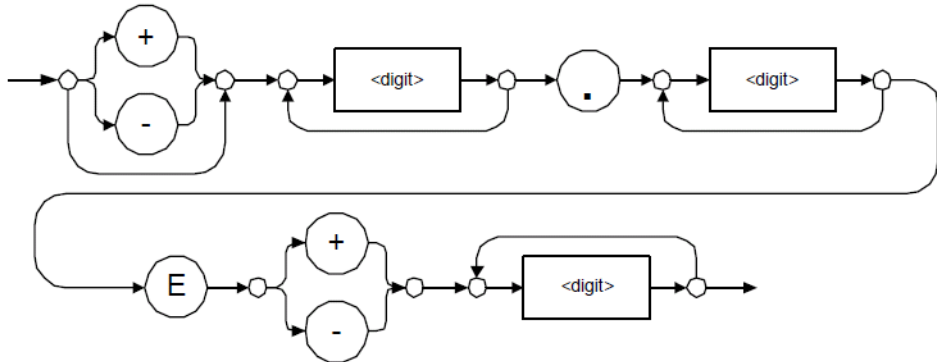

Examples: 4.3E-3, -8.9456E8, 123E-5

Data Types

Applicable Data Types for Output —IEEE 488.2

➤ **Special Numeric Values Received on Output**

In some cases, an instrument may send values indicating that an unusual event has occurred. The following tables present the possible values.

Value is	ASCII 4 bytes	PACKED 4 bytes
Under range	2143289345.000000	7FC00001
Over range	2143289346.000000	7FC00002
Invalid	2143289347.000000	7FC00003
Inactive	2143289348.000000	7FC00004

Value is	ASCII 8 bytes	PACKED 8 bytes
Under range	9221120237577961472	7FF8000020000000
Over range	9221120238114832384	7FF8000040000000
Invalid	9221120238651703296	7FF8000060000000
Inactive	9221120239188574208	7FF8000080000000

➤ <HEXADECIMAL NUMERIC RESPONSE DATA>

This data type is used by a device to return integer representations in hexadecimal (base 16).

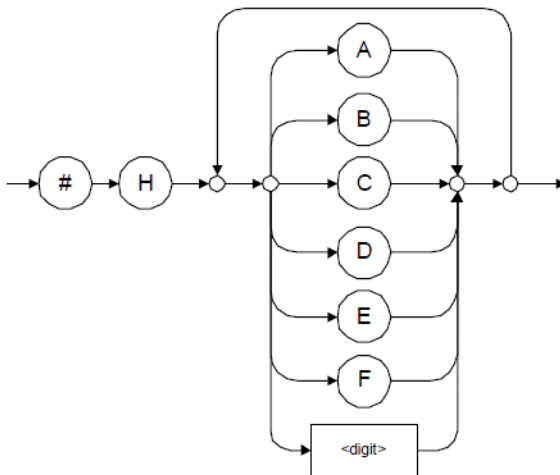

Examples: #HA3C5, #H0123C, #H010F

Data Types

Applicable Data Types for Output —IEEE 488.2

➤ <OCTAL NUMERIC RESPONSE DATA>

This data type is used by a device to return integer representations in octal (base 8).

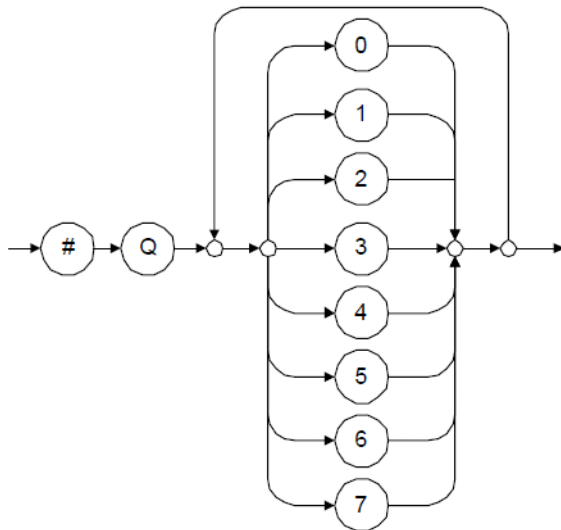

Examples: #Q753214, #Q0124, #Q0725

➤ <BINARY NUMERIC RESPONSE DATA>

This data type is used by a device to return integer representations in binary (base 2).

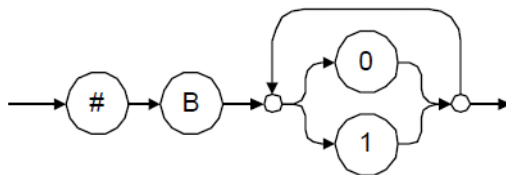

Examples: #B11011110101, #B110100, #B0100

➤ <STRING RESPONSE DATA>

This data type is used by a device to return strings containing 7-bit ASCII characters and especially when text has to be displayed since even the non-printable characters are also returned.

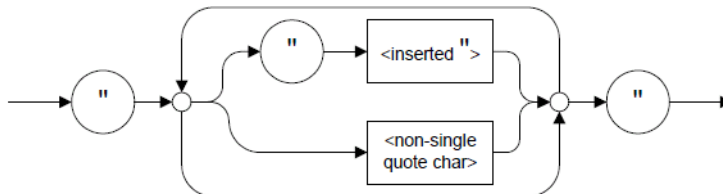

Examples: "SCPI Commands", "SCPI ""Commands""

Data Types

Applicable Data Types for Output —IEEE 488.2

➤ <DEFINITE LENGTH ARBITRARY BLOCK RESPONSE DATA>

This data type is used by a device to return blocks of 8-bit binary information with a fixed and predetermined length.

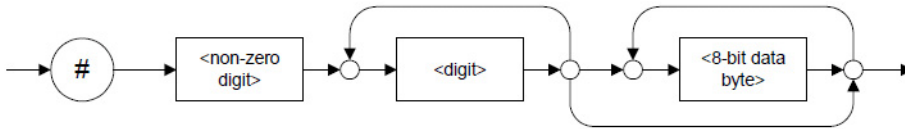

The actual length of the retrieved data has the following structure:

- The first byte contains the # character.
- The byte that immediately follows contains the number of subsequent bytes that you have to check to know the total length.

For example, if you receive this response (here, values are expressed in decimal instead of binary for easier readability):

2 1 3 7 6 8 9 2 ...

The byte that immediately follows the # contains 2, which means that you have to read the two following bytes to know the length (in bytes) of the retrieved data. The bytes indicate 1 and 3. The length is then be 13 bytes. The actual response begins at byte number 5, in this case.

Examples: #14<DAB> <DAB> <DAB> <DAB> ,
#3004<DAB> <DAB> <DAB> <DAB>

where “<DAB>” stands for data byte.

➤ <INDEFINITE LENGTH ARBITRARY BLOCK RESPONSE DATA>

This data type is used by a device to return blocks of 8-bit binary information when the block length was not predefined or when data has to be computed later.

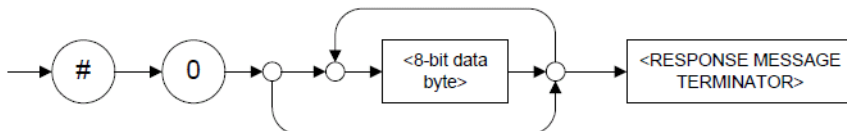

Note: *If you receive a zero as the first digit (#0), it is necessarily followed by a <RESPONSE PROGRAM MESSAGE TERMINATOR> to allow you to detect the end of the <INDEFINITE LENGTH ARBITRARY BLOCK RESPONSE DATA>.*

Example: #0<DAB><DAB><DAB><DAB><terminator> where “<DAB>” stands for data byte.

Data Types

Applicable Data Types for Output —IEEE 488.2

➤ <SUFFIX RESPONSE DATA>

This data type is used by a device to return units and multipliers.

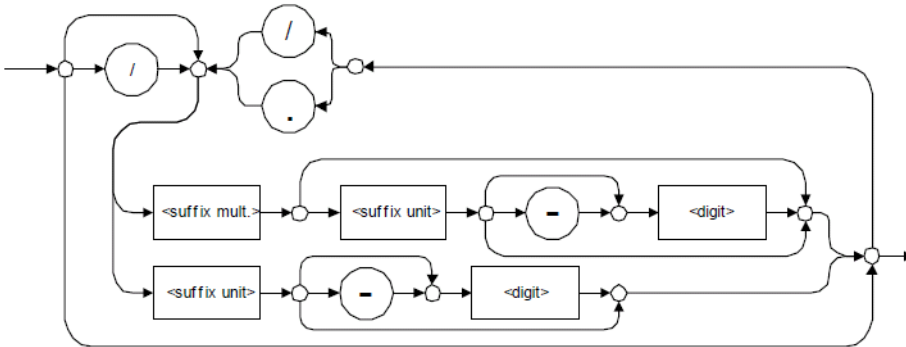

Examples: DBW, W, KHZ

➤ <ARBITRARY ASCII RESPONSE DATA>

This data type is used by a device to return information when it is impossible to use any other data type.

Example: To the *IDN? query, the device returns this response in an arbitrary ASCII bytes format:

EXFO INC., IQS-610P,125-2A55,1.0.1.97

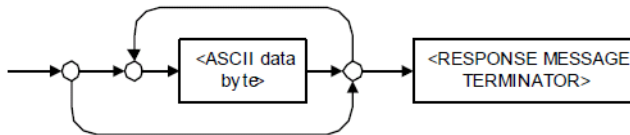

Applicable Data Types for Input—SCPI

SCPI data types include the IEEE 488.2 data types (see *Applicable Data Types for Input—IEEE 488.2* on page 268) with certain additional restrictions.

- **<numeric_value>**: abbreviated form of the decimal numeric element. It differs from the **<DECIMAL NUMERIC PROGRAM DATA>** “<NRf>” described in IEEE 488.2.

Several forms of **<CHARACTER PROGRAM DATA>** are defined as special forms of numbers. These are: **MINimum**, **MAXimum**, **DEFault**, **UP**, **DOWN**, **Not A Number (NAN)**, **INFinity** and **Negative INFinity (NINF)**. The following special forms are likely to be used by EXFO’s instruments in certain commands or queries:

- **DEFault**: This special **<numeric_value>** parameter forces the instrument to select a value, which is deemed to be convenient to the user.
- **MINimum|MAXimum**: These special **<numeric_value>** parameters refer to the instrument’s limit values. **MINimum** corresponds to the value closest to negative infinity that the function can accept. **MAXimum** corresponds to the largest value that the function can accept.
- **<Boolean Program Data>**: This form is often used as a shorthand of the **<DECIMAL NUMERIC PROGRAM DATA>ON|OFF** form.

<Boolean Program Data> parameters have a value of 0 or 1 and are not followed by any unit.

On input, an **<NRf>** is rounded to an integer.

A non-zero result is interpreted as 1.

ON and **OFF** are accepted on input for readability purposes. They correspond respectively to 1 and 0. However, on output, they appear as 1 or 0, never **ON** or **OFF**.

Data Types

Special Numeric Values Received on Output

Special Numeric Values Received on Output

It is possible that an instrument returns unusual values in certain cases. For information on these values, see Applicable Data Types for Output —IEEE 488.2 *on page 277*.

D **IEEE 488.2 and Specific Commands**

This chapter presents detailed information about the commands and queries supplied with your IQS-600 Integrated Qualification System.

IEEE 488.2 Commands–Quick Reference

The IQS-600 Integrated Qualification System recognizes the required commands identified in IEEE 488.2. The table below summarizes these commands. These commands are fully explained on the following pages.

Command	Function
*CLS	Clear status command (See *CLS on page 290)
*ESE	Standard event status enable command (See *ESE on page 291)
*ESE?	Standard event status enable query (See *ESE? on page 293)
*ESR?	Standard event status register query (See *ESR? on page 295)
*IDN?	Identification query (See *IDN? on page 297)
*OPC	Operation complete command (See *OPC on page 299)
*OPC?	Operation complete query (See *OPC? on page 300)
*RST	Reset command (See *RST on page 301)

IEEE 488.2 and Specific Commands

IEEE 488.2 Required Commands

Command	Function
*SRE	Service request enable command (See *SRE on page 302)
*SRE?	Service request enable query (See *SRE? on page 304)
*STB?	Read status byte query (See *STB? on page 306)
*TST?	Self-test query (See *TST? on page 308)
*WAI	Wait for pending operations to be completed (See *WAI on page 309)

IEEE 488.2 Required Commands

*CLS	
Description	The *CLS command clears the Standard Event Status Register and the Error/Event Queue.
Syntax	*CLS
Parameter(s)	None

ESE*Description**

The *ESE command sets the Standard Event Status Enable Register bits, as defined in the table below. This register contains a mask value for the bits to be enabled in the Standard Event Status Register.

MSB	Standard Event Status Enable Register							LSB
PON	URQ	CME	EXE	DDE	QYE	N.U	OPC	

Syntax

*ESE<wsp> <RegisterValue>

Parameter(s)

RegisterValue:

The program data syntax for <RegisterValue> is defined as a <DECIMAL NUMERIC PROGRAM DATA> element.

The <RegisterValue>, expressed in base 2, represents the bit values of the Standard Event Status Enable Register.

IEEE 488.2 and Specific Commands

IEEE 488.2 Required Commands

***ESE**

The table below shows the contents of this register.

Bit	Weight	Meaning
PON	128	Turn On Enable
URQ	64	User ReQuest Enable
CMD	32	CoMmanD Error Enable
EXE	16	Execution Error Enable
DDE	8	Device Dependent Error Enable
QRY	4	QueRry Error Enable
N.U.	2	Not used
OPC	1	Operation Complete Enable

A value of 1 in the Enable Register enables the corresponding bit in the Status Register, a value of 0 disables the bit. The value of the <RegisterValue> shall be in the range of 0 through 255.

Example(s)

*ESE 25
where 25 = (bit EXE, bit DDE and bit OPC)

*ESE 0
clears the content of the Standard Event Status Enable register

See Also

*ESE?
*ESR?

***ESE?**

Description The *ESE? query allows the programmer to determine the current contents of the Standard Event Status Enable Register. See the contents of this register below.

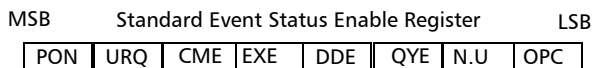

Syntax *ESE?

Parameter(s) None

Response Syntax <RegisterValue>

IEEE 488.2 and Specific Commands

IEEE 488.2 Required Commands

***ESE?**

Response(s)

RegisterValue:

The response data syntax for <RegisterValue> is defined as a <NR1 NUMERIC RESPONSE DATA> element.

The <RegisterValue> ranges from 0 through 255.

The <RegisterValue> value expressed in base 2 (binary) represents the bit values of the Standard Event Status Enable register. See below.

Bit	Weight	Meaning
PON	128	Turn On Enable
URQ	64	User ReQuest Enable
CMD	32	CoMmanD Error Enable
EXE	16	Execution Error Enable
DDE	8	Device Dependent Error Enable
QRY	4	QueRry Error Enable
N.U.	2	Not used
OPC	1	Operation Complete Enable

Example(s)

*ESE? returns 133
where 133 = (bit PON, bit QYE and bit OPC)

See Also

*ESE
*ESR?

***ESR?**

Description The *ESR? query allows the programmer to determine the current contents of the Standard Event Status Register. Reading the Standard Event Status Register clears it. See the contents of this register below.

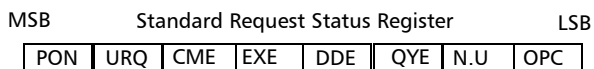

Syntax *ESR?

Parameter(s) None

Response Syntax <RegisterValue>

IEEE 488.2 and Specific Commands

IEEE 488.2 Required Commands

*ESR?

Response(s)

RegisterValue:

The response data syntax for <RegisterValue> is defined as a <NR1 NUMERIC RESPONSE DATA> element.

The <RegisterValue> ranges from 0 through 255.

The <RegisterValue> value expressed in base 2 (binary) represents the bit values of the Standard Event Status register. See below.

Bit	Weight	Meaning
PON	128	Power ON Enable
URQ	64	User ReQuest Enable
CMD	32	CoMmanD Error Enable
EXE	16	Execution Error Enable
DDE	8	Device Dependent Error Enable
QRY	4	QueRry Error Enable
N.U.	2	Not used
OPC	1	Operation Complete Enable

Example(s)

*ESR? returns 33
where 33 = (bit CME and bit OPC)

See Also

*ESE
*ESE?

***IDN?**

Description	The intent of the *IDN? query is for the unique identification of devices over the system interface.
Syntax	*IDN?
Parameter(s)	None
Response Syntax	<Identification>
Response(s)	<p><i>Identification:</i></p> <p>The response data syntax for <Identification> is defined as an <ARBITRARY ASCII RESPONSE DATA> element.</p>

The response syntax for the *IDN? query, <Identification> is defined as an <ARBITRARY ASCII RESPONSE DATA> element. This implies that the *IDN? query should be the last <QUERY MESSAGE UNIT> in a <TERMINATED PROGRAM MESSAGE>.

The response is organized into four fields separated by commas. The field definitions are as follows:

Field 1 (Manufacturer): EXFO Inc.

Field 2 (Model): Instrument Model

IEEE 488.2 and Specific Commands

IEEE 488.2 Required Commands

***IDN?**

Field 3 (Serial number): ASCII character (0 if not available)

Field 4 (Firmware level): ASCII character (0 if not available)

ASCII character 0 represents a single ASCII-encoded byte with a value of 30 (48 decimal).

The presence of data in all fields is mandatory. If either field 3 or 4 is not available, the ASCII character 0 shall be returned for that field. A field may contain any 7-bit ASCII-encoded bytes in the range of 20 through 7E (32 through 126 decimal) except commas (2C, 44 decimal) and semicolons (3B, 59 decimal).

Example(s)

*IDN? returns EXFO E.O.
Engineering,IQS-610P,125-2A55,1.0.1.97

Notes

The overall length of the *IDN? response is less than or equal to 72 characters.

***OPC**

Description	The *OPC command allows synchronization between the instrument and an external controller unit. The *OPC command causes the instrument to set bit 0 (Operation Complete) in the Standard Event Status Register to the TRUE (logic 1) state when the instrument completes all pending operations. Detection of the Operation Complete message can be accomplished by continuous polling of the Standard Event Status Register using the *ESR? common query command. However, using a service request eliminates the need to poll the Standard Event Status Register thereby freeing the controller unit to do other useful work.
Syntax	*OPC
Parameter(s)	None
See Also	*OPC? *WAI

*OPC?

Description	The *OPC? query allows synchronization between the instrument and an external controller unit by reading the Output Queue or by waiting for a service request on the Message Available (MAV) bit in the Status Byte Register. The *OPC? query causes the instrument to place an ASCII character, 1, into its Output Queue when the device completes all pending operations. A consequence of this action is that the MAV bit in the Status Byte Register is set to state 1.
Syntax	*OPC?
Parameter(s)	None
Response Syntax	<Acknowledge>
Response(s)	<i>Acknowledge:</i> The response data syntax for <Acknowledge> is defined as a <NR1 NUMERIC RESPONSE DATA> element. The <Acknowledge> response is a single ASCII-encoded byte corresponding to 1. The receipt of an <Acknowledge> response indicates that all pending selected device operations have been completed.
Example(s)	*OPC? Return 1
See Also	*OPC *WAI

RST*Description**

The *RST command performs a device reset. This command is the third reset level in a three-level reset strategy. The Reset command shall do the following:

- a) Sets the device-specific functions to a known state that is independent of the past-use history of the device.
- b) Forces the device into OCIS state (Operation complete Command Idle State).
- c) Forces the device into OQIS state (Operation complete Query Idle State).

The Reset command explicitly DOES NOT affect the following:

- a) The state of the Communication interface.
- b) The Output Queue.
- c) Any Event Enable Register setting, including the Standard Event Status Enable Register setting.
- d) Any Event Register setting, including the Standard Event Status Register settings.
- e) Calibration data that affects device specifications.
- f) The Service Request Enable Register setting.

Syntax

*RST

Parameter(s)

None

IEEE 488.2 and Specific Commands

IEEE 488.2 Required Commands

*SRE

Description

The *SRE command sets the Service Request Enable Register bits. See the contents of this register below. This register contains a mask value to enable the bits in the Status Byte Register.

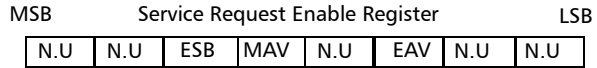

Syntax

*SRE<wsp> <RegisterValue>

Parameter(s)

RegisterValue:

The program data syntax for <RegisterValue> is defined as a <DECIMAL NUMERIC PROGRAM DATA> element.

The <RegisterValue> value ranges from 0 through 255.

The <RegisterValue>, expressed in base 2 (binary), represents the bit values of the Service Request Enable Register.

***SRE**

See the contents of this register below.

Bit	Weight	Meaning
N.U.	128	Not used
N.U.	64	Not used
ESB	32	Event Summary Bit Enable
MAV	16	Message AVailable Enable
N.U.	8	Not used
EAV	4	Error / Event AVailable Enable
N.U.	2	Not used
N.U.	1	Not used

A bit value of zero shall indicate a disabled condition.

Example(s)

*SRE 52
where 52 = (bit ESB, bit MAV and bit EAV)

See Also

*SRE?
*STB?

IEEE 488.2 and Specific Commands

IEEE 488.2 Required Commands

*SRE?

Description

The *SRE? query allows the programmer to determine the current contents of the Service Request Enable Register. See the contents of this register below.

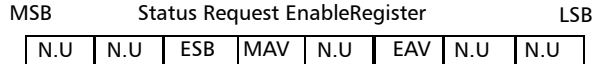

Bit	Weight	Meaning
N.U.	128	Not used
N.U.	64	Not used
ESB	32	Event Summary Bit Enable
MAV	16	Message Available Enable
N.U.	8	Not used
EAV	4	Error / Event Available Enable
N.U.	2	Not used
N.U.	1	Not used

Syntax

*SRE?

Parameter(s)

None

Response Syntax

<RegisterValue>

SRE?*Response(s)***RegisterValue:*

The response data syntax for <RegisterValue> is defined as a <NR1 NUMERIC RESPONSE DATA> element.

The <RegisterValue> ranges from 0 through 255.

When converted to binary (base 2), the <RegisterValue> represents the current bit values of the Service Request Enable Register.

Example(s)

*SRE Return 32 (bit ESB)

See Also

*SRE
*STB?

IEEE 488.2 and Specific Commands

IEEE 488.2 Required Commands

*STB?

Description The *STB? query allows the programmer to read the status byte and Master Summary Status bit. See the content of this register below.

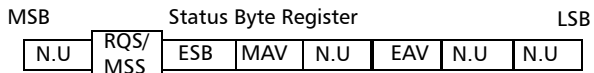

Syntax *STB?

Parameter(s) None

Response Syntax <RegisterValue>

STB?*Response(s)***RegisterValue:*

The response data syntax for <RegisterValue> is defined as a <NR1 NUMERIC RESPONSE DATA> element.

The <RegisterValue> ranges from 0 through 255.

The <RegisterValue> value, expressed in base 2 (binary) represents the bit values of the Status Byte Register. See the contents of this register below.

Bit	Weight	Meaning
N.U.	128	Not used
RQS/ MSS	64	ReQuest Service (read by serial polling)/MaSter Summary bit (read by *STB?)
ESB	32	Event Summary Bit Enable
MAV	16	Message AVailable Enable
N.U.	8	Not used
EAV	4	Error / Event AVailable Enable
N.U.	2	Not used
N.U.	1	Not used

Example(s)

*STB? Return 68
where 68 = (bit MSS and bit EAV)

See Also

*SRE
*SRE?

IEEE 488.2 and Specific Commands

IEEE 488.2 Required Commands

*TST?	
Description	The *TST? query causes an internal self-test and places a response into the Output Queue indicating whether or not the device completed the self-test without any detected errors. Upon successful completion of *TST?, the device settings is restored to their values prior to the *TST?.
Syntax	*TST?
Parameter(s)	None
Response Syntax	<Result>
Response(s)	<p><i>Result:</i></p> <p>The response data syntax for <Result> is defined as a <NR1 NUMERIC RESPONSE DATA> element.</p> <p>The <Result> value ranges from -32767 through +32767.</p> <p>A <Result> with a value of zero indicates that the self-test has been completed without errors detected. A <Result> with a value not equal to zero indicates that the self-test was not completed or was completed with errors detected.</p>
Example(s)	*TST? Return 0 (self-test was completed with success)

***WAI**

Description	The *WAI command shall prevent the device from executing any further commands or queries until the no-operation-pending flag becomes TRUE.
Syntax	*WAI
Parameter(s)	None
Example(s)	*WAI
See Also	*OPC *OPC?

Specific Commands—Quick Reference

The table below contains a summary of the IQS-600 Integrated Qualification System specific commands. These commands are fully explained on the following pages.

Command						Parameter(s)
FORMat	[DATA]					ASCI PACKed[,<Length>]
	[DATA]?					
INSTRument	CATalog?					
	CATalog	FULL?				
SYSTem	DATE					<Year>,<Month>,<Day>
	DATE?					
	ERRor	[NEXT]?				
	TIME					<Hour>,<Minute>,<Seconds>
	TIME?					
	VERSion?					

Specific Commands

:FORMat[:DATA]

Description

The FORMat[:DATA] command selects the data format and <Length>. The <Length> parameter is optional for all data format, its meaning is dependent on the data format selected.

If PACKed type is selected, the data is transferred in a <DEFINITE BLOCK RESPONSE DATA>. The ASCii-type data is automatically identified by its syntax. Therefore, in these cases, the FORMat subsystem is only necessary to determine the output format.

At *RST, ASCii is selected as the default data format and the <Length> is set to 0.

Syntax

:FORMat[:DATA] <wsp>ASCii|PACKed[, <Length>]

Parameter(s)

► *Type:*

The program data syntax for the first parameter is defined as a <CHARACTER PROGRAM DATA> element. The allowed <CHARACTER PROGRAM DATA> elements for this parameter are: ASCii|PACKed.

:FORMat[:DATA]

In ASCii format, the numeric data is transferred to ASCii bytes in <NR1 NUMERIC RESPONSE DATA>, <NR2 NUMERIC RESPONSE DATA> or <NR3 NUMERIC RESPONSE DATA> representation, as appropriate.

In PACKed format, data is transferred to a <DEFINITE BLOCK RESPONSE DATA>, in a manner specified in the device documentation.

► *Length:*

The program data syntax for <Length> is defined as a <DECIMAL NUMERIC PROGRAM DATA> element.

When ASCii data format is selected, the optional <Length> parameter specifies the number of significant digits to be returned. A <Length> value of zero indicates that the device selects the number of significant digits to be returned. When a <Length> of zero has been specified, the FORMat[:DATA]? query returns zero as its second parameter.

When the PACKed data format is selected, the optional parameter <Length> it not used.

Example(s)

FORM ASC
FORM ASC,6
FORM:DATA PACKED

See Also

FORMat[:DATA]?

:FORMat[:DATA]?

Description	<p>The FORMat[:DATA]? query returns the data format and the <Length>.</p> <p>At *RST, ASCii is selected as the default data format and the <Length> is set to 0.</p>
Syntax	:FORMat[:DATA]?
Parameter(s)	None
Response Syntax	<Type>,<Length>
Response(s)	<p>➤ <i>Type:</i></p> <p>The response data syntax for <Type> is defined as a <CHARACTER RESPONSE DATA> element.</p> <p>The ASCII <Type> is returned when numeric data is transferred to ASCII bytes in <NR1 NUMERIC RESPONSE DATA>, <NR2 NUMERIC RESPONSE DATA> or <NR3 NUMERIC RESPONSE DATA> representation, as appropriate.</p> <p>The PACKED <Type> is returned when data is transferred to a <DEFINITE BLOCK RESPONSE DATA>, as specified in the device documentation.</p> <p>➤ <i>Length:</i></p> <p>The response data syntax for <Length> is defined as a <NR1 NUMERIC RESPONSE DATA> element.</p>

:FORMat[:DATA]?

When the data is returned in ASCII, the <Length> is the number of significant digits to be returned. A <Length> value of zero indicates that the device selects the number of significant digits to be returned.

When the data is returned in PACKED <Type>, the <Length> is not used and always returns 0.

Example(s)

FORM? Return ASCII,6
FORM? Return PACKED,0

See Also

FORMat[:DATA]?

:INSTrument:CATalog?

Description	The INSTrument:CATalog? query returns a comma-separated list of <STRING RESPONSE DATA>, which contains the names of all logical instruments and groups. If no logical instruments are defined, a single null <STRING RESPONSE DATA> is returned.
	This is not affected by a *RST command.
Syntax	:INSTrument:CATalog?
Parameter(s)	None
Response Syntax	<Catalog>
Response(s)	<i>Catalog:</i> The response data syntax for <Catalog> is defined as a <STRING RESPONSE DATA> element.
	The list of <STRING PROGRAM DATA> contains the names of all logical instruments and groups.
Example(s)	INST:CAT? returns "IQS-2403 WDM Laser Source", "IQS-2403 WDM Laser Source"
See Also	INSTrument:CATalog:FULL?

:INSTrument:CATalog:FULL?

Description	<p>The INSTrument:CATalog:FULL? returns a list of <STRING RESPONSE DATA> - <NR1 NUMERIC RESPONSE DATA> pairs. The <STRING RESPONSE DATA> contains the name of the logical instrument. The immediately following <NR1 NUMERIC RESPONSE DATA> formatted number is its associated logical instrument number. All response data elements are separated by commas. If no logical instrument is defined, a null <STRING RESPONSE DATA> value followed by a zero is returned.</p> <p>This is not affected by a *RST command.</p>
Syntax	:INSTrument:CATalog:FULL?
Parameter(s)	None
Response Syntax	<Catalog>
Response(s)	<p><i>Catalog:</i></p> <p>The response data syntax for <Catalog> is defined as a <STRING RESPONSE DATA> element.</p> <p>The list of <STRING RESPONSE DATA> contains the names of all logical instruments and groups. The immediately following <NR1 NUMERIC RESPONSE DATA> formatted number is its associated logical instrument number.</p>
Example(s)	INST:CAT:FULL? return "IQS-2403 WDM Laser Source",10,"IQS-2403 WDM Laser Source",11
See Also	INSTrument:CATalog?.

:SYSTem:DATE

Description	<p>The SYSTem:DATE command is used to set the device's internal calendar.</p> <p>This is not affected by a *RST command.</p>
Syntax	:SYSTem:DATE<wsp><Year>,<Month>,<Day> >
Parameter(s)	<p>➤ <i>Year:</i></p> <p>The program data syntax for <Year> is defined as a <DECIMAL NUMERIC PROGRAM DATA> element.</p> <p>The <Year> is rounded to the nearest integer. Its range is limited by the capability of the device. The year shall be entered as a four-digit number, including century and millennium information.</p> <p>➤ <i>Month:</i></p> <p>The program data syntax for <Month> is defined as a <DECIMAL NUMERIC PROGRAM DATA> element.</p> <p>The <Month> is rounded to the nearest integer. Its range is 1 to 12 inclusive. The number 1 corresponds to January, 2 to February, and so on.</p>

:SYSTem:DATE

➤ *Day:*

The program data syntax for <Day> is defined as a <DECIMAL NUMERIC PROGRAM DATA> element.

The <Day> is rounded to the nearest integer. It ranges from 1 to the number of days in the month from the previous parameter. This command keeps track of the number of days in each month, accounting for leap years through the range of years that it accepts.

Example(s)

SYST:DATE 2001,11,29

See Also

SYSTem:DATE?

:SYSTem:DATE?

Description	The SYSTem:DATE query returns the instrument's internal calendar. This is not affected by a *RST command.
Syntax	:SYSTem:DATE?
Parameter(s)	None
Response Syntax	<Year>,<Month>,<Day>

:SYSTem:DATE?

Response(s)

➤ *Year:*

The response data syntax for <Year> is defined as a <NR1 NUMERIC RESPONSE DATA> element.

The <Year> is a four-digit number, including century and millennium information.

➤ *Month:*

The response data syntax for <Month> is defined as a <NR1 NUMERIC RESPONSE DATA> element.

The <Month> ranges from 1 to 12, inclusively. The number 1 corresponds to January, 2 to February, and so on.

➤ *Day:*

The response data syntax for <Day> is defined as a <NR1 NUMERIC RESPONSE DATA> element.

The <Day> ranges from 1 to the number of days in the month from the previous field. This command keeps track of the number of days in each month, accounting for leap years through the range of years that it accepts.

Example(s)

SYST:DATE? returns 2001,11,29

See Also

SYSTem:DATE

:SYSTem:ERRor[:NEXT]?

Description	<p>The SYSTem:ERRor[:NEXT]? queries the error/event queue for the next item and removes it from the queue. The response message consists of two fields separated by commas <Code>,<Description[,Info]>.</p> <p>SYSTem:ERRor[:NEXT]? is a query only and, therefore, does not have an associated *RST state.</p>
Syntax	:SYSTem:ERRor[:NEXT]?
Parameter(s)	None
Response Syntax	<Code>,<Description[,Info]>
Response(s)	<p>► <i>Code:</i></p> <p>The response data syntax for <Code> is defined as a <NR1 NUMERIC RESPONSE DATA> element.</p> <p>The <Code> is a unique integer in the range [-32768, 32767]. All positive numbers are instrument-dependent. All negative numbers are reserved by the SCPI standard with certain standard error/event codes described in an appendix of this document. The zero value is also used to indicate that no error or event has occurred.</p> <p>► <i>Description[,Info]:</i></p> <p>The response data syntax for <Description[,Info]> is defined as a <STRING RESPONSE DATA> element.</p>

:SYSTem:ERRor[:NEXT]?

The <Description[,Info]> parameter of the full response is a quoted string containing a description followed by information text [,Info]. Each <Code> has a unique and fixed <Description> associated with it. The <Date> and <Time> are appended to the [,info] separated by a semi-colon using the following format:

<Date><wsp><Time> where

<Date> = Year/Month/Day

<Time> = Hour,Minute,Second (24 hour time)

The maximum length of <Description[,Info]> is 255 characters. For standard defined error/event <Codes>, the <Description> is sent exactly as indicated in the appendix of this document.

Example(s)

SYST:ERR:NEXT? returns -222,"Data out of range"
SYST:ERR:NEXT? returns -222,"Data out of range,instrument monomodule 2100, 2001/11/29 14:56:16.259"

:SYSTem:TIME

Description	<p>This device has an internal clock and implements the SYSTem:TIME command to set the clock time over the interface.</p> <p>This is not affected by a *RST command.</p>
Syntax	:SYSTem:TIME<wsp><Hour>,<Minute>,<Seconds>
Parameter(s)	<p>➤ <i>Hour:</i></p> <p>The program data syntax for <Hour> is defined as a <DECIMAL NUMERIC PROGRAM DATA> element.</p> <p>The <Hour> is always rounded to the nearest integer. It ranges from 0 to 23 inclusively. The device accepts hour information in 24-hour format.</p> <p>➤ <i>Minute:</i></p> <p>The program data syntax for <Minute> is defined as a <DECIMAL NUMERIC PROGRAM DATA> element.</p> <p>The <Minute> is always rounded to the nearest integer. It ranges from 0 to 59 inclusively.</p>

:SYSTem:TIME

➤ *Seconds:*

The program data syntax for <Seconds> is defined as a <DECIMAL NUMERIC PROGRAM DATA> element.

The <Second> is rounded to the resolution of the clock. It ranges from 0 to 60. A value of 60 is allowed since rounding may cause a number greater than 59.5 to be rounded to 60. When this element is rounded to 60 it shall be set to 0 and the minute value incremented. Any other carries shall be rippled through the date.

Example(s)

SYST:TIME 12,47,29

See Also

SYSTem:TIME?

:SYSTem:TIME?

Description	This device has an internal clock and implements the SYSTem:DATE? query to get the clock time over the interface. This is not affected by a *RST command.
Syntax	:SYSTem:TIME?
Parameter(s)	None
Response Syntax	<Hour>,<Minute>,<Second>

:SYSTem:TIME?

Response(s)

► *Hour:*

The response data syntax for <Hour> is defined as a <NR1 NUMERIC RESPONSE DATA> element.

The <Hour> ranges from 0 to 23. The instruments returns hour information in 24-hour format.

► *Minute:*

The response data syntax for <Minute> is defined as a <NR1 NUMERIC RESPONSE DATA> element.

The <Minute> ranges from 0 to 59.

► *Second:*

The response data syntax for <Second> is defined as a <NR1 NUMERIC RESPONSE DATA> element.

The <Second> ranges from 0 to 59. The resolution of the clock is the second.

Example(s)

SYST:TIME? returns 16,55,38

See Also

SYSTem:TIME

:SYSTem:VERSion?

Description	<p>The SYSTem:VERSion? query returns a value corresponding to the SCPI version number to which the device complies.</p> <p>The SYSTem:VERSion? is a query only and, therefore, does not have an associated *RST state.</p>
Syntax	:SYSTem:VERSion?
Parameter(s)	None
Response Syntax	<Version>
Response(s)	<p><i>Version:</i></p> <p>The response data syntax for <Version> is defined as a <NR2 NUMERIC RESPONSE DATA> element.</p> <p>The <Version> is shown in the form Year.Revision, where Year represents the year-version (for example 1990) and Revision represents an approved revision number for that year. If no approved revisions are claimed, then this extension is 0.</p>
Example(s)	SYSTem:VERSion? returns 1999.0 (no approved revisions are claimed)

E **COM Properties and Events**

The IQS-600 Integrated Qualification System also provides objects based on Microsoft Component Object Model (COM). COM defines a common way to access and create software components and services.

COM promotes the integration and the reuse of software components, as well as interoperability. In order to interoperate, components developed in different languages must adhere to a binary structure specified by Microsoft.

OLE and ActiveX are based on COM. Also, programming languages such as C, C++, Smalltalk, Pascal, Ada, Java, and LabVIEW can create and use COM components.

You can build your own programs using the provided properties and events via the IcSCPIAccess interface. For information on how to configure your IQS-600 Integrated Qualification System for DCOM control, see *Configuring DCOM Access to Your Unit* on page 147.

ActiveX (COM/DCOM)—Quick Reference

The following diagram illustrates the different properties and events available.

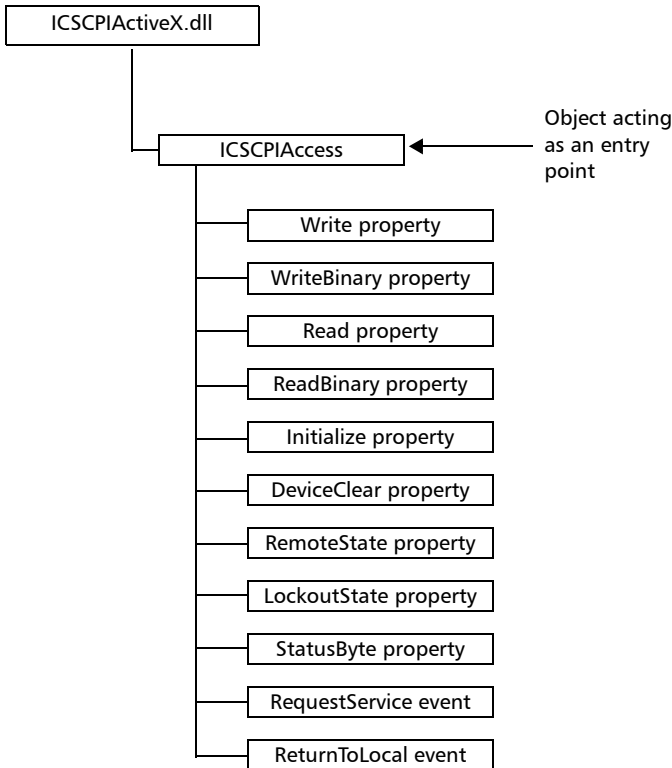

These properties and events are fully explained in the following pages.

Properties

Write

Description	This method allows you to send a program message (single command or compound of commands) to the device input buffer.
Syntax	object. <i>Write</i> (<i>Message</i>)
Parameter(s)	<i>Message</i> : Required. A string value corresponding to the program message to be sent.
Possible error(s)	<i>Timeout</i> : This error occurs if the operation could not be completed within the allowed delay. For information on timeout setting, see <i>Initialize</i> on page 335.

WriteBinary

Description	This method allows you to send a program message (single command or compound of commands) as an array of bytes into the device input buffer.
Syntax	<code>object.Write (BinaryArray)</code>
Parameter(s)	<i>BinaryArray</i> : Required. An array of bytes corresponding to the program message to be sent.
Notes	Use this method instead of the <i>Write</i> method if you need to send commands in binary (COM is UNICODE).
Possible error(s)	<i>Timeout</i> : This error occurs if the operation could not be completed within the allowed delay. For information on timeout setting, see <i>Initialize</i> on page 335.



IMPORTANT

Before you retrieve data with the *Read* or *ReadBinary* methods, EXFO recommends that you specify the format in which the information must be returned. Details on how to correctly set the format can be found hereafter.

Read

Description	This method allows you to retrieve all the data from the device output queue in a UNICODE format.
Syntax	<code>object.Read</code>
Parameter(s)	None.
Response(s)	A string value (in UNICODE format).
Notes	<p>This method must be used in conjunction with the <i>Write</i> method. Always ensure that a query has been previously sent before attempting to read a response from the output queue.</p> <p>To properly set the data format, send the following command (using the <i>Write</i> method): FORM:DATA<wsp>ASCII <number_of_digits> where <number_of_digits> corresponds to the number of digits after the decimal point that you require.</p> <p>Remember that the retrieved data must be converted to a numeric format before you can use it in calculations, for example.</p>
Possible error(s)	<p><i>Timeout</i>: This error occurs if the allowed delay has expired before the preceding <i>Write</i> operation could send a response to the output queue. For information on timeout setting, see <i>Initialize</i> on page 335.</p> <p><i>QueryUnterminated</i>: This error occurs if the output queue is empty (for example, no query has been made previously).</p>

ReadBinary

Description	This method allows you to retrieve data from the device output queue in a binary format.
Syntax	<code>object.ReadBinary</code>
Parameter(s)	None.
Response(s)	An array of bytes.
Notes	<p>This method must be used in conjunction with the <i>Write</i> method. Always ensure that a query has been previously sent before attempting to read a response from the output queue.</p> <p>To properly set the data format, send the following command (using the <i>Write</i> method): FORM:DATA<wsp>PACKED</p> <p>The retrieved data <i>does not</i> need to be converted to a numeric format before you can use it in calculations, for example.</p> <p>To help you know the actual length of the retrieved data, keep the following structure in mind:</p> <ul style="list-style-type: none">➤ The first byte contains the # character.➤ The byte that immediately follows contains the number of subsequent bytes that you have to check to know the total length.

ReadBinary

For example, if you receive this response (here, values are expressed in decimal instead of binary for easier readability):

```
# 2 1 3 7 5 8 9 2 ...
```

The byte that immediately follows the # contains 2, which means that you have to read the two following bytes to know the length (in bytes) of the retrieved data. The bytes indicate 1 and 3. The length is then 13 bytes. The actual response begins at byte number 5, in this case.

Possible error(s)

Timeout: This error occurs if the allowed delay has expired before the preceding *Write* operation could send a response to the output queue. For information on timeout setting, see *Initialize* on page 335.

QueryUnterminated: This error occurs if the output queue is empty (that is, if no query has been made previously).

Initialize

Description

This method allows you to configure the timeout value, that is, the allowed delay for Read and Write operations, in milliseconds.

Syntax

```
object.Initialize(Timeout)
```

Parameter(s)

Timeout: Required. A numeric value corresponding to the delay in milliseconds.

Notes

If the *Initialize* method is not invoked, the default value is 10 000 milliseconds.

COM Properties and Events

Properties

DeviceClear	
Description	This method performs a <i>Device Clear</i> operation as specified in the IEEE 488.1 standard.
Syntax	<code>object.DeviceClear</code>
Parameter(s)	None.

RemoteState	
Description	This property returns or sets the device's remote state.
Syntax	<code>object.RemoteState</code> (to retrieve the state) <code>object.RemoteState=State</code> (to set the state) <i>State</i> : a Boolean value corresponding to: True: Remote False: Local
Parameter(s)	None.
Response(s)	If the property is used to get the device's remote state, the property returns a Boolean value.
Access	Get/Set

LockoutState

Description	This property returns or sets the device's lockout state.
Syntax	<p><code>object.LockoutState</code> (to retrieve the state)</p> <p><code>object.LockoutState=State</code> (to set the state)</p> <p><i>State</i>: a Boolean value corresponding to:</p> <p style="padding-left: 40px;">True: Lockout</p> <p style="padding-left: 40px;">False: No lockout</p>
Parameter(s)	None.
Response(s)	If the property is used to get the device's lockout state, the property returns a Boolean value.
Access	Get/Set

StatusByte

Description	This read-only property returns the device's status byte. Refer to IEEE 488.2 standard for status byte description.
Syntax	<code>object.StatusByte</code>
Parameter(s)	None.
Response(s)	A value corresponding to the device's status byte.
Notes	This property can be used in conjunction with <i>RequestService</i> event (see <i>RequestService</i> on page 338) to find out why the device caused a Service Request (SRQ).
Access	Get

Events

RequestService	
Description	This event is triggered whenever the device causes a Service Request (SRQ).
Parameter(s)	None.
Notes	<p>It is your responsibility to configure the different registers (*SRE, *ESE) as stated in the IEEE 488.2 standard to receive SRQ.</p> <p>When used in conjunction with <i>StatusByte</i> property (see <i>StatusByte</i> on page 337), this event allows you to determine the cause of the SRQ.</p>

ReturnToLocal	
Description	This event is triggered when you press the Local button from the front panel of the controller unit when the device is in Remote state.
Parameter(s)	None.

F **Communicating Through TCP/IP over Telnet**

Introducing TCP/IP over Telnet

The EXFO Instrument Control provides SCPI automation or remote control over Telnet through TCP/IP as a Windows Service that continuously listens to a port from a Telnet server (FTB/IQS) on which modules to be tested are connected.

TCP/IP protocols are used for communication.

Note: *Port 5024 is designated for sending SCPI commands in the Telnet protocol.*

All Windows versions include the Telnet client and the Telnet server components. With these components, you can create a remote command console session on a remote computer.

Commands can be executed simply by logging on the server using the Telnet interface.

There are two types of commands that can be sent over Telnet: SCPI commands and internal protocol commands of the TCP/IP over Telnet service. The internal commands allow you to perform certain actions such as send SCPI commands as a script instead of one by one, force the disconnection of an active session, view the status of modules and of connected clients, etc.

Features

- A client from any operating system (Windows, Linux, or Unix) can use the freely available Telnet components to connect to the service.
- A client can connect to multiple modules at a time.
- A user can connect to multiple modules through single/multiple sessions.
- A client can execute single commands or a batch of commands.
- A user can disconnect any client/session that is already connected.

Activating TCP/IP over Telnet

The TCP/IP over Telnet Service, which is part of the EXFO Instrument Control, is a mediator between the Telnet client and the test instrument.

Any request from the Telnet client will be transferred to IcExecutive. IcExecutive then passes the request to the appropriate instrument. The instrument executes the request and returns the response to IcExecutive and to TCP/IP over Telnet accordingly.

To activate TCP/IP over Telnet:

1. Access the Instrument Control Configuration utility:
 - On an IQS-600: From IQS Manager, click the **Utilities** function tab, and then click **Instrument Control Configuration**.
 - On an FTB-500: From ToolBox, tap the **System Settings** button, then tap **Instrument Control Configuration**.
 - On an FTB-2 or FTB-2 Pro: From ToolBox X, tap the **System Settings** button, then tap **Instrument Control Configuration**.
2. If necessary, click or tap **Change settings**, and then, when the application prompts you to authorize the changes to your unit (identified as “computer”), select **Yes**.

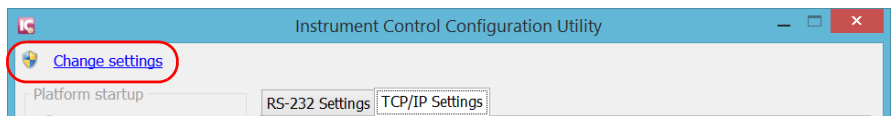

3. Under **Platform Startup**, select **Remote**.

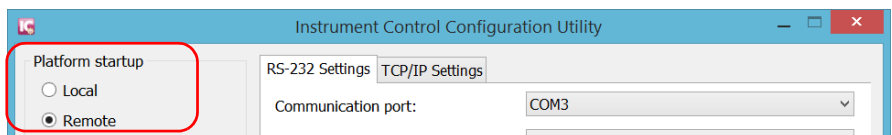

Communicating Through TCP/IP over Telnet

Executing SCPI Commands Over Telnet

4. Under **Communication Type**, select **TCP/IP**.

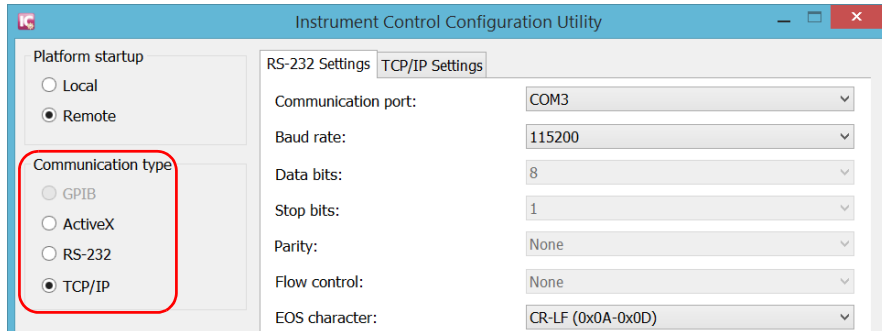

5. Click or tap **Apply**, and then **OK**.
6. Depending on the unit you are using, restart either IQS Manager, ToolBox, or ToolBox X.

Executing SCPI Commands Over Telnet

You can remotely control the modules by executing SCPI commands through TCP/IP over Telnet. The commands are sent remotely from the Telnet client (on a computer) to the Telnet server (in this case, the IQS or FTB unit).

To execute a single SCPI command, you can type or paste the command directly in the Telnet editor window.

To execute multiple SCPI commands (script), you must enclose them within a BEGIN and END block in the Telnet editor window.

You can connect from a remote Windows client or a Linux (or Unix) remote client.

Note: *The Telnet client is available on the FTB-500, FTB-2 Pro, and IQS-600 controller if you intend to use these units as computers to connect to a Telnet server. However, on an FTB-2, the Telnet client is not available. You must use the PuTTY application to establish communication.*

To connect through TCP/IP over Telnet from a remote Windows client:

1. From your computer, start Windows.
2. On the taskbar, click **Start** (Start button () under Windows 8.1) and select **Run**.
3. In the **Open** box, type *telnet*, and then click **OK**.

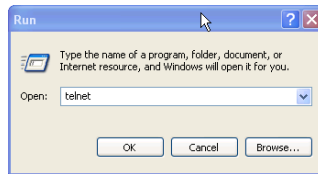

Note: *If you receive an error message, it probably means that the Telnet client is not already activated on your computer. In this case, in the **Open** box, type `pkgmgr /iu:TelnetClient`, and then click **OK** to enable the client. Once it is done, perform step 3 again.*

Communicating Through TCP/IP over Telnet

Executing SCPI Commands Over Telnet

4. In the displayed Telnet editor window, type the `OPEN <IP_ADDRESS_OF_TELNET_SERVER> <PORT>` command to connect to the TCP/IP Telnet Service.

Example: `open 10.192.2.45 5024`

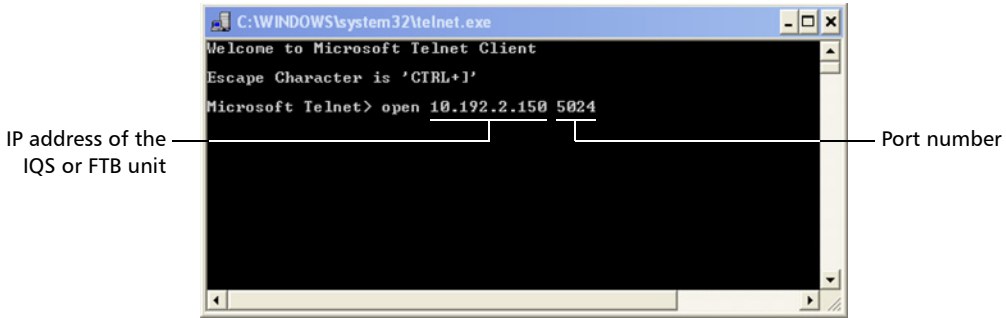

Note: Port 5024 is designated for sending SCPI commands in the Telnet protocol.

5. Press ENTER to establish a connection with the Service.

Once the connection is established, the `READY>` prompt is displayed in the Telnet editor window.

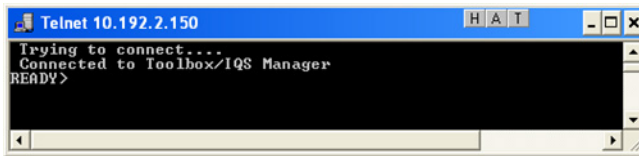

Note: If the connection cannot be established, the *Connection to host lost* message is displayed instead.

6. Enter the desired SCPI commands as follows:

- For a single SCPI command: Type or copy the desired command in the Telnet editor window, and then press ENTER to execute it.

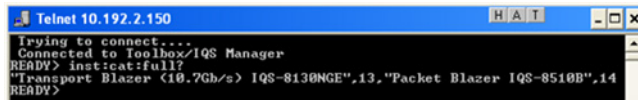

```
Telnet 10.192.2.150
Trying to connect....
Connected to Toolbox/IQS Manager
READY> inst:cat:full?
Transport Blazer (10.7Gb/s) IQS-8130NGE",13,"Packet Blazer IQS-8510B",14
READY>
```

- For multiple SCPI commands: Copy the desired commands from any script file, enclose them in a BEGIN and END block in the Telnet editor window, and then press ENTER. For more information, see *Internal Commands of the TCP/IP over Telnet Protocol* on page 349.

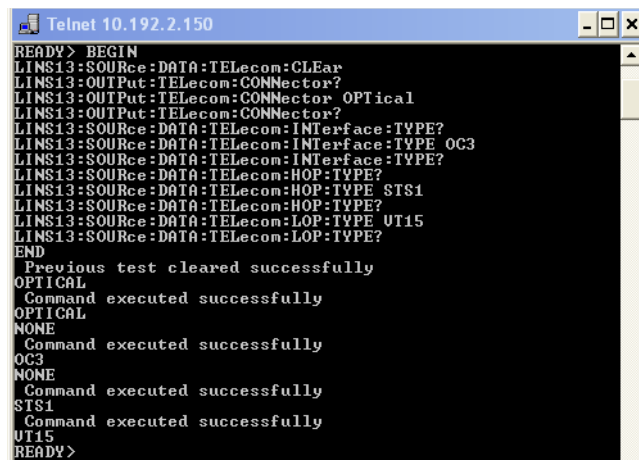

```
Telnet 10.192.2.150
READY> BEGIN
LINS13:SOURce:DATA:TELecon:CLEAr
LINS13:OUTPut:TELecon:CONNector?
LINS13:OUTPut:TELecon:CONNector OPTIcal
LINS13:OUTPut:TELecon:CONNector?
LINS13:SOURce:DATA:TELecon:INTErface:TYPE?
LINS13:SOURce:DATA:TELecon:INTErface:TYPE OC3
LINS13:SOURce:DATA:TELecon:INTErface:TYPE?
LINS13:SOURce:DATA:TELecon:HOP:TYPE?
LINS13:SOURce:DATA:TELecon:HOP:TYPE STS1
LINS13:SOURce:DATA:TELecon:HOP:TYPE?
LINS13:SOURce:DATA:TELecon:LOP:TYPE UT15
LINS13:SOURce:DATA:TELecon:LOP:TYPE?
END
Previous test cleared successfully
OPTICAL
Command executed successfully
OPTICAL
NONE
Command executed successfully
OC3
NONE
Command executed successfully
STS1
Command executed successfully
UT15
READY>
```

Note: Multiple commands that are not enclosed in BEGIN...END blocks will be executed, but problems may occur (results of one command mixed with the results of another one, skipped commands, etc.).

Once at least one valid command is executed, the module is blocked for any other sessions until the module is released. For more information, see *Releasing Modules* on page 348.

Communicating Through TCP/IP over Telnet

Executing SCPI Commands Over Telnet

7. Click  to close the session.

To connect through TCP/IP over Telnet from a remote Linux client:

1. From your computer, right-click on the desktop, and then click **Open Terminal**.

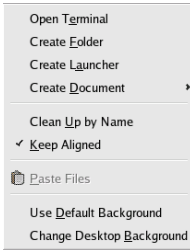

The command prompt is displayed in the Telnet editor window.

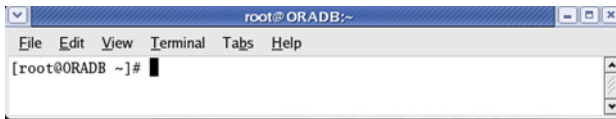

2. Connect to the TCP/IP Telnet Service by typing the *OPEN <IP_ADDRESS_OF_TELNET_SERVER> <PORT>* command:

Example: *open 10.192.2.45 5024*

Note: *Port 5024 is designated for sending SCPI commands in the Telnet protocol.*

The connection is established when the message **Connected to Toolbox/IQS Manager** is displayed in the Telnet editor window.

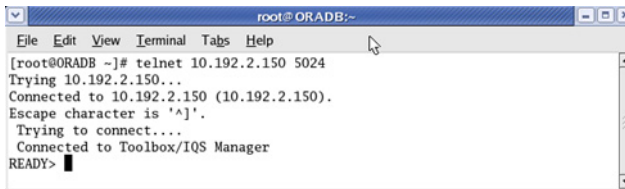

3. Enter the desired SCPI commands as follows:

- For a single SCPI command: Type or copy the desired command in the Telnet editor window, and then press ENTER to execute it.

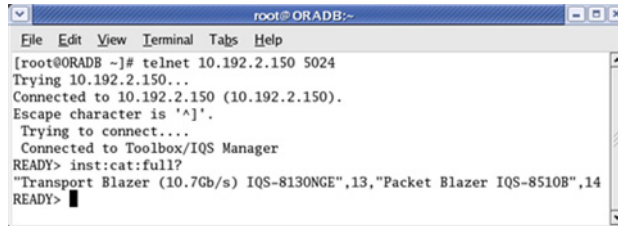

```
root@ORADB:~  
File Edit View Terminal Tabs Help  
[root@ORADB ~]# telnet 10.192.2.150 5024  
Trying 10.192.2.150...  
Connected to 10.192.2.150 (10.192.2.150).  
Escape character is '^]'.  
Trying to connect...  
Connected to Toolbox/IQS Manager  
READY> inst:cat:full?  
"Transport Blazer (10.7Gb/s) IQS-8130NGE",13,"Packet Blazer IQS-8510B",14  
READY> █
```

- For multiple SCPI commands: Copy the desired commands from any script file, enclose them in a BEGIN and END block in the Telnet editor window, and then press ENTER. For more information, see *Internal Commands of the TCP/IP over Telnet Protocol* on page 349.

Note: *Multiple commands that are not enclosed in BEGIN...END blocks will be executed, but problems may occur (results of one command mixed with the results of another one, skipped commands, etc.).*

Once at least one valid command is executed, the module is blocked for any other sessions until the module is released. For more information, see *Releasing Modules* on page 348.

4. Click  to close the session.

Releasing Modules

A module is blocked as soon as a connection is established from any user session executing the internal command `CONNECT LINS`, or a valid instrument (SCPI) command.

For example, when the SCPI command `LINS10:SOURce:DATA:TELEcom:CLEAr` command is executed for the first time by client session 10.192.2.155:1364, the module is blocked for any other client/session until you release it.

A module is released by one of the following actions:

- Executing the `CLOSE LINS` command to disconnect the link with the module. For more information, see *CLOSE LINS* on page 352.
- Executing the `CLOSE` command to end the current session once the execution of all the desired commands has been completed. For more information, see *CLOSE* on page 351.
- Closing the current session by clicking the Close button on the Telnet editor windows' title bar.
- Shutting down and restarting the client computer.
- A network interruption.

A module can also be released when you terminate the communication by using the `KILL LINS` command. For more information, see *KILL LINS* on page 354.

Internal Commands of the TCP/IP over Telnet Protocol

The internal commands allow you to perform certain actions such as send SCPI commands as a script instead of one by one, force the disconnection of an active session, view the status of modules and of connected clients, etc. The internal commands are not case-sensitive.

By default, log files are generated both for client and server (all logs are kept on your unit). You can delete them with the CLEAR LOGS command (see *CLEAR LOGS* on page 351), or manually via the file explorer. The client and sever logs are kept respectively in the *C:\ProgramData\EXFO\SCPI Over TCP/IP Logs\Client log* and in the *C:\ProgramData\EXFO\SCPI Over TCP/IP Logs\Server log* folders.

ABORT BEGIN

Syntax: ABORT BEGIN

The ABORT BEGIN command stops the execution of the SCPI commands that are enclosed in a BEGIN and END block, and returns to the READY> prompt in the Telnet editor window.

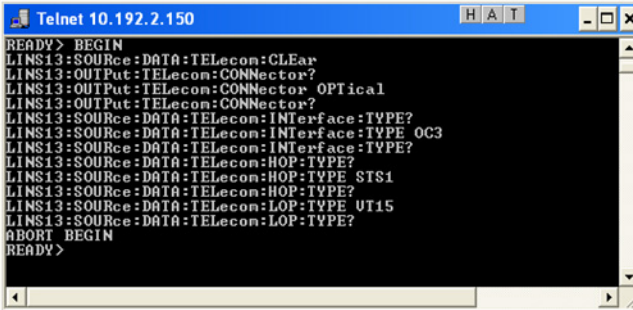

```
Telnet 10.192.2.150  H A T  _ _ X
READY> BEGIN
LINS13:SOURce:DATA:TELecon:CLear
LINS13:OUTPut:TELecon:CONNector?
LINS13:OUTPut:TELecon:CONNector OPTical
LINS13:OUTPut:TELecon:CONNector?
LINS13:SOURce:DATA:TELecon:INTErface:TYPE?
LINS13:SOURce:DATA:TELecon:INTErface:TYPE OC3
LINS13:SOURce:DATA:TELecon:INTErface:TYPE?
LINS13:SOURce:DATA:TELecon:HOP:TYPE?
LINS13:SOURce:DATA:TELecon:HOP:TYPE STS1
LINS13:SOURce:DATA:TELecon:HOP:TYPE?
LINS13:SOURce:DATA:TELecon:LOP:TYPE UT15
LINS13:SOURce:DATA:TELecon:LOP:TYPE?
^BORT BEGIN
READY>
```

Communicating Through TCP/IP over Telnet

Internal Commands of the TCP/IP over Telnet Protocol

BEGIN and END

To execute multiple SCPI commands, you must enclose them in BEGIN and END blocks in a Telnet editor window.

Note: *To execute a single command, simply type or paste the command in the Telnet editor window.*

Note: *You cannot enclose internal commands in a BEGIN and END block, except the ABORT BEGIN command.*

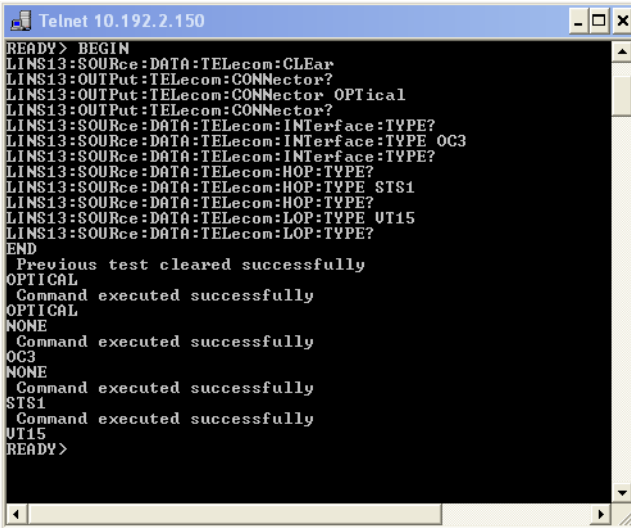

```
Telnet 10.192.2.150
READY> BEGIN
LINS13:SOURce:DATA:TELEcom:CLEAr
LINS13:OUTPut:TELEcom:CONNector?
LINS13:OUTPut:TELEcom:CONNector OPTical
LINS13:OUTPut:TELEcom:CONNector?
LINS13:SOURce:DATA:TELEcom:INterface:TYPE?
LINS13:SOURce:DATA:TELEcom:INterface:TYPE OC3
LINS13:SOURce:DATA:TELEcom:INterface:TYPE?
LINS13:SOURce:DATA:TELEcom:HOP:TYPE?
LINS13:SOURce:DATA:TELEcom:HOP:TYPE STS1
LINS13:SOURce:DATA:TELEcom:HOP:TYPE?
LINS13:SOURce:DATA:TELEcom:LOP:TYPE UT15
LINS13:SOURce:DATA:TELEcom:LOP:TYPE?
END
Previous test cleared successfully
OPTICAL
Command executed successfully
OPTICAL
NONE
Command executed successfully
OC3
NONE
Command executed successfully
STS1
Command executed successfully
UT15
READY>
```

CLEAR LOGS

Syntax: CLEAR LOGS

This command clears all the client and server log files that are older than 36 hours (default value) from the time you execute the command.

```
Trying to connect...
Connected to Toolbox/IQS Manager.
READY> clear logs
Clearing log files older then 1 hours was not success
READY>
```

Note: You can also delete the logs manually via the file explorer. The client and sever logs are kept respectively in the C:\ProgramData\EXFO\SCPI Over TCPIP Logs\Client log and in the C:\ProgramData\EXFO\SCPI Over TCPIP Logs\Server log folders.

CLOSE

Syntax: CLOSE

The CLOSE command terminates the current Telnet session.

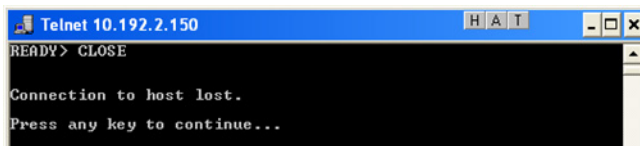

```
Telnet 10.192.2.150 H A T
READY> CLOSE
Connection to host lost.
Press any key to continue...
```

Communicating Through TCP/IP over Telnet

Internal Commands of the TCP/IP over Telnet Protocol

CLOSE LINS

Syntax: CLOSE LINS<Unit_Number> <Module_Slot_Number>

You must specify the unit number and the slot number identifying the module for which you want to close the connections.

This command allows to close active connections. You can send this command to close all client's connections with any module, including the current connection.

If the command is not executed successfully, the possible reasons could be:

- The module is not present at the specified position.
- The provided information does not correspond to a valid LINS.

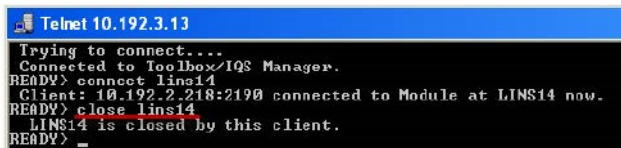

```
Telnet 10.192.3.13
Trying to connect...
Connected to Toolbox/IQS Manager.
READY> connect line14
Client: 10.192.2.218:2190 connected to Module at LINS14 now.
READY> close lins14
LINS14 is closed by this client.
READY> _
```

CONNECT LINS

Syntax: CONNECT LINS<Unit_Number><Module_Slot_Number>

You must specify the unit number and the slot number identifying the module to which the session will connect.

This command allows to connect to different modules through TCP/IP. You can connect to multiple modules from a single session.

If the command is not executed successfully, the possible reasons could be:

- The module is already connected to a different client session.
- The module is not present at the specified position.
- The provided information does not correspond to a valid LINS.

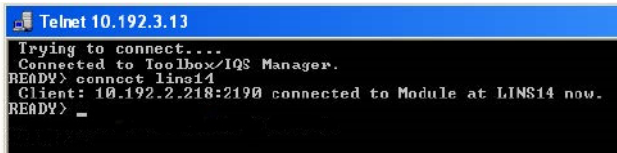

```
Telnet 10.192.3.13
Trying to connect...
Connected to Toolbox/IQS Manager.
READY> connect lins14
Client: 10.192.2.218:2190 connected to Module at LINS14 now.
READY> _
```

Note: *For backward compatibility reasons, to connect to a single module, you do not have to use the CONNECT LINS command. A valid instrument command (for example, Lins10:SOURce:DATA:TELEcom:CLEar) for a valid LINS position will work for a first module. However, you will need to use the CONNECT LINS command if you want to connect to other modules as well.*

Communicating Through TCP/IP over Telnet

Internal Commands of the TCP/IP over Telnet Protocol

KILL LINS

Syntax: KILL LINS<Unit_Number><Module_Slot_Number>

You must specify the unit number and the slot number identifying the module for which you want to terminate the session.

This command allows any user to terminate the session that contains the specified connection (LINS). This means it will terminate all active connections that belongs to a session.

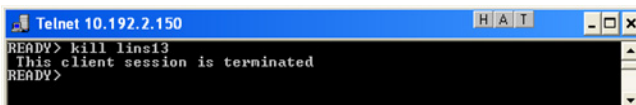

```
Telnet 10.192.2.150 H A T
READY> kill lins13
This client session is terminated
READY>
```

To know the status of the modules before terminating connections using the KILL LINS command, you can first enter the STATUS CLIENT command. For more information, see *STATUS CLIENT* on page 355.

In the example below, two modules are connected: LINS13 and LINS10.

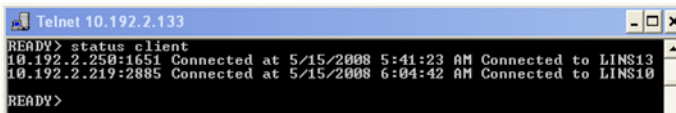

```
Telnet 10.192.2.133
READY> status client
10.192.2.250:1651 Connected at 5/15/2008 5:41:23 AM Connected to LINS13
10.192.2.219:2885 Connected at 5/15/2008 6:04:42 AM Connected to LINS10
READY>
```

To disconnect the LINS10 module used by another session, enter the *kill lins10* command. The **This client session is terminated** message is displayed once the module is disconnected.

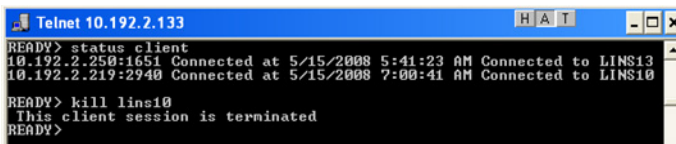

```
Telnet 10.192.2.133 H A T
READY> status client
10.192.2.250:1651 Connected at 5/15/2008 5:41:23 AM Connected to LINS13
10.192.2.219:2940 Connected at 5/15/2008 7:00:41 AM Connected to LINS10
READY> kill lins10
This client session is terminated
READY>
```

Communicating Through TCP/IP over Telnet

Internal Commands of the TCP/IP over Telnet Protocol

Enter again the STATUS CLIENT command to confirm the termination of the module (LINS10 in our example). Only the information of the remaining connected client is displayed.

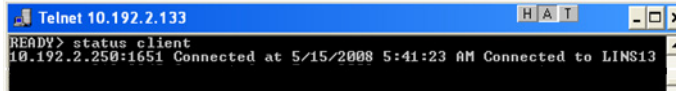

```
Telnet 10.192.2.133 H A T
READY> status client
10.192.2.250:1651 Connected at 5/15/2008 5:41:23 AM Connected to LINS13
```

STATUS CLIENT

Syntax: STATUS CLIENT

This command lists out all clients with their connection time and modules.

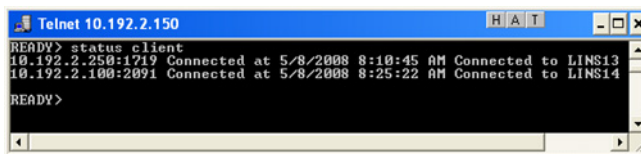

```
Telnet 10.192.2.150 H A T
READY> status client
10.192.2.250:1719 Connected at 5/8/2008 8:10:45 AM Connected to LINS13
10.192.2.100:2091 Connected at 5/8/2008 8:25:22 AM Connected to LINS14
READY>
```

STATUS CONNECTION

Syntax: STATUS CONNECTION

This command lists out all the connections with their *Idle* or *Active* status.

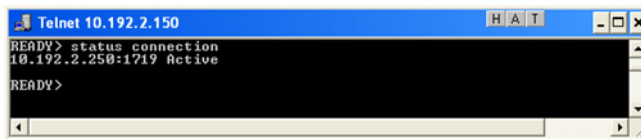

```
Telnet 10.192.2.150 H A T
READY> status connection
10.192.2.250:1719 Active
READY>
```

Note: *If any connection is idle for a certain period (5 minutes by default), the service automatically changes the status to Idle.*

Communicating Through TCP/IP over Telnet

Internal Commands of the TCP/IP over Telnet Protocol

STATUS MODULE

Syntax: STATUS MODULE

This command lists out all the modules with the slot numbers where they are located.

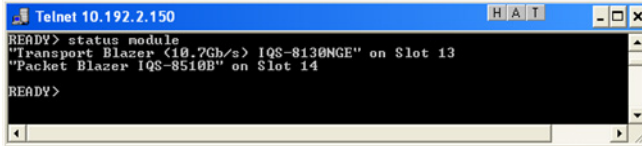

```
Telnet 10.192.2.150
READY> status module
"Transport Blazer (10.7Gb/s) IQS-8130NGE" on Slot 13
"Packet Blazer IQS-8510B" on Slot 14
READY>
```

WHO M I?

Syntax: WHO M I?

This command retrieves the IP address and the communication port of the current session.

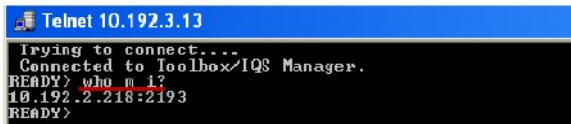

```
Telnet 10.192.3.13
Trying to connect...
Connected to Toolbox/IQS Manager.
READY> who m i?
10.192.2.218:2193
READY>
```

G *Using the IQS-9600 Utility Module*

The IQS-9600 Utility Module provides a secure, standardized way of integrating components such as couplers, isolators, filters, and Bragg gratings into the IQS-600 Integrated Qualification System. Without such a module, these passive optical elements would end up loose on your workbench, which can cause damage or affect their adjustment.

The IQS-9600 Utility Module consists of an empty IQS module casing that fits into your IQS-610P-HS controller unit or IQS-610E-HS expansion unit. The IQS-9600 Utility Module is used to house non-electrical elements only (no electrical connections are provided).

The IQS-9600 Utility Module comes in either single-slot (IQS-9601) or dual-slot (IQS-9602) size. The amount of material supplied with the utility module depends on the configuration, but it usually includes the following:

- adhesive tape
- tie wraps
- splice holder
- connectors

Use the exploded views presented in this section as a reference for disassembling and reassembling the utility modules.

Note: *The IQ-9600 Utility Module can also be used in your controller or expansion units. Both types of modules are assembled and disassembled in the same manner.*

Using the IQS-9600 Utility Module

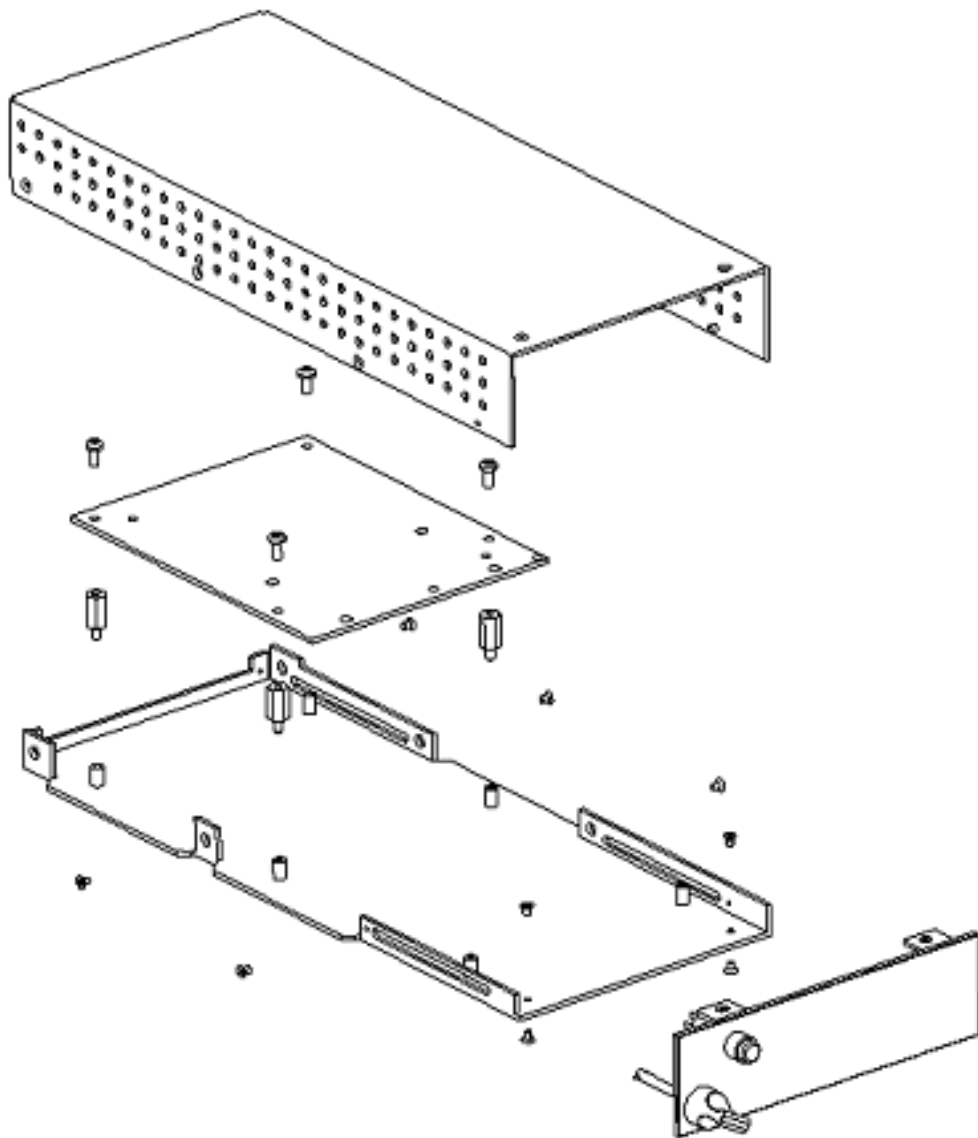

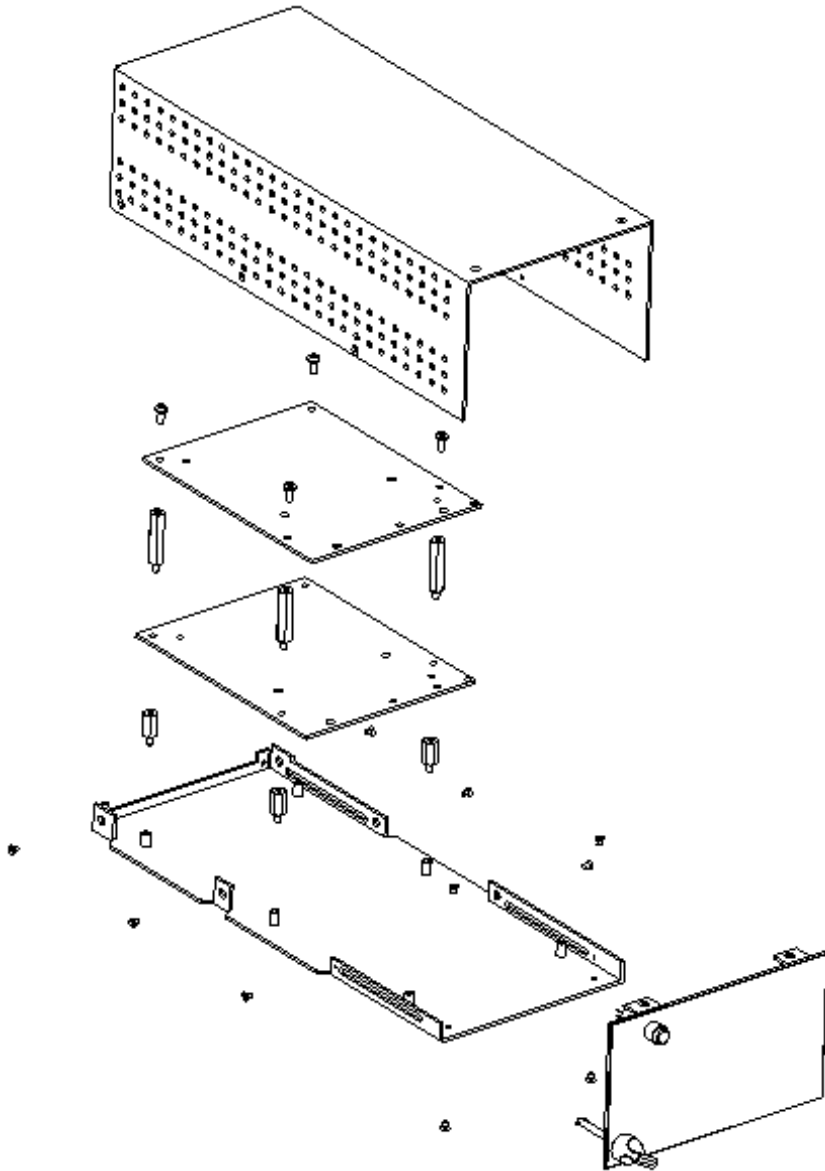

Index

- A**
- About tab 239
 - AC requirements 18
 - accesses in IQS Manager 85
 - accessing
 - IQS Manager 54
 - utilities 108
 - activating on-screen keyboard 43
 - ActiveX
 - control 127
 - linking units 138
 - output units and formats 140
 - selecting 143
 - adjusting
 - controller unit angle 21
 - display 68
 - sound 68
 - after-sales service 238
 - alarm indicator LED 10
 - angled brackets 189
 - applications
 - installing 46
 - integrated 102
 - ASCII format 141
 - automatic
 - fan speed 90
 - Windows updates 214
 - automation 125, 126
- B**
- back panel 4, 6, 7
 - backlight
 - button 10
 - level 69
 - backup 12
 - benchtop, putting units on 21
 - books, SCPI and IEEE 488.2 187
 - boot, first 39
 - braces 189
 - brackets
 - angled 189
 - square 188
 - bumpers, platform 23
 - bus timing 140
 - Busy, module status 100
 - button, on/off 5, 7
- C**
- capacitors 17
 - caution
 - of personal hazard 13
 - of product hazard 13
 - certification information vii
 - changing
 - backlight level 69
 - communication settings 142
 - status 178
 - theme color 68
 - Charm bar, display 41
 - cleaning
 - front panel 213
 - touchscreen 213
 - close window 41
 - closing IQS Manager 55
 - code writing, GPIB 192
 - codes, error 194
 - colon 189
 - columns, setting monitor windows in 104
 - COM, local control 127
 - COM/DCOM
 - events 338
 - properties 331
 - comma 190

Index

- commands
 - IEEE 488.2 290
 - SCPI 187
 - specific 311
 - TCP/IP 349–355
 - communication
 - ActiveX 127
 - changing settings 142
 - default settings 145
 - Ethernet TCP/IP 126, 127
 - GPIB 126, 127
 - RS-232 126, 127
 - TCP/IP over Telnet 128, 339–342
 - components tab 242
 - configuration
 - GPIB 136
 - loading 93
 - opening 92
 - saving 92
 - saving on exit 94
 - unit 39
 - connecting units together 26
 - connectors
 - for interlock 36
 - peripheral 4, 6
 - consulting PDF files 106
 - contact information 239
 - control
 - ActiveX 127
 - Ethernet TCP/IP 126, 127
 - GPIB 126, 127
 - remote 125
 - RS-232 127
 - TCP/IP over Telnet 128
 - controller unit stand 21
 - controlling modules 126
 - conventions, programming 187, 190, 193
 - conventions, safety 13
 - cooling fans clearance space 22
 - copying commands into
 - text document 210, 212
 - covers, unit 17
 - creating integrated data display 104
 - current modules 99
 - current, electrical 18
 - customer service 247
 - customizing
 - hardware 95
 - monitors 104
- D**
- data
 - peripherals related to 5
 - protection 12
 - types 267
 - data input
 - IEEE 488.2 268
 - SCPI 287
 - data output IEEE 488.2
 - special 280, 288
 - standard 277
 - DCOM
 - configuring computers 147
 - technology 127
 - deactivating LED display 70
 - default identification of module 95
 - dial, selection 10
 - digit 188
 - disconnecting unit 16
 - display Charm bar 41
 - door for interlock 36
 - down, swipe 41
 - drive, DVD-RW 5
 - drivers, LabVIEW 56
 - dual-boot 220
 - DVD-RW 5
- E**
- emergency system tools 220
 - Enter button 10
 - equipment returns 247
 - error messages in remote control 194
 - error/event queue 182

-
- Ethernet TCP/IP
 control 126, 127
 port 138
examples, LabVIEW 197
EXFO address 239
exiting
 and saving configuration 94
 IQS Manager 55
expansion unit connectors 4, 6
Explorer, Windows 108
external
 door for interlock 36
 keyboard, installing 61
 monitor, installing 59
extracting IQ modules 34
- F**
- factory settings, reverting to 97
fan speed 90
finding units 107
first startup 39
front panel description 5, 7
front panel, cleaning 213
function tabs 99
- G**
- gestures, touchscreen 41
GPIB
 address 127
 capability 137
 chain 127
 configuring parameters 144
 control 126, 127
 hardware configuration 136
 optimizing performance 139
 output units and formats 140
 port 138
 restrictions 136
 selecting 143
- H**
- handshake rate 140
hard drive
 activity LED 10
 RAID 1 12
hardware, customizing 95
help. see online user guide
high speed (HS488) 136, 139, 144
- I**
- identification label 238
identification, module 95
IEEE 488.1 protocol 136, 139, 140
IEEE 488.2 commands 290
indoor use 17
information about system, viewing 239
inlets 16
input
 buffer 180
 IEEE 488.2 data types 268
 SCPI data types 287
input current 18
inserting a module 30
installed kits 240
installing
 external keyboard 61
 external monitor 59
 mouse 61, 62, 66
 software 46
 unit 17
 units in rackmount 22
instrument control settings 142
integrated
 applications 102
 data display, creating 104
integrating passive components to
 system 357
interface at startup 84
interlock
 function 36
 LED 10

Index

IQ module, removing 34
IQS-600
 controller 125
 turning off 38, 55
 turning on 38

K

keyboard
 on-screen 43
 PS/2 61
keywords, SCPI 189
Kits Installed tab 240
knob, selection 10

L

label, identification 238
LabVIEW
 demo application 197
 drivers 2
 installing drivers 56
 principles 195
LAN network 127, 128
language, selecting 71
launching IQS Manager 54
LED
 deactivating display 70
 description 10
 indicators 5, 7
left, swipe 41
legs, platform 23
lights, turning off 70
linking units
 Ethernet port 138
 GPIB port 138
 serial port 139
 together 26
list of components 242
list separator 189
live backup 12
loading configuration 93
local control 127, 143

local to remote 178
locating units 107
lock LED 10
lockout status 176, 177
logging off Windows 55

M

main power switch 4, 6, 7
maintenance
 front panel 213
 general information 213
mandatory commands 290
maximum input current 18
messages, remote control 180
mnemonic, definition 189
mode, offline 103
module
 controlling 126
 current 99
 default identification 95
 detail 99
 extracting tool 34
 insertion 30
 locating 107
 name 95
 number 95
 removal 30
 status 100
monitor
 customizing windows 104
 port 59
monitoring remote commands 209
mounting rack
 cabinet 25
 installing units in 22
 kit 22
mouse
 installing 61, 62, 66
 PS/2 61, 62, 66
moving, monitor windows 104
multiple capabilities 188

- N**
- name, module 95
 - network, LAN/WAN 127, 128
 - number, module 95
- O**
- offline mode 103
 - on/off
 - button 5, 7
 - LED 10
 - online user guide 237
 - on-screen keyboard 43
 - opening
 - configuration 92
 - IQS Manager 54
 - user guides 106
 - operating system 41
 - options
 - regional and language 71
 - software 49
 - orientation of units 21
 - Out port 28
 - outlets, power 4, 6
 - output IEEE 488.2
 - special 280, 288
 - standard 277
 - output queue 181
- P**
- PACked format 141
 - panel, front 5, 7
 - passive components, integrating 357
 - passwords in IQS Manager 85
 - PDF files, viewing 106
 - PDF. see online user guide
 - peripheral
 - connectors 4, 6
 - data related 5
 - pipe character 189
- platform
- bumpers 23
 - commands 311
 - legs 23
- port
- Ethernet 138
 - GPIB 138
 - IQS-610P-HS In 26, 28
 - IQS-610P-HS Out 28
 - serial 139
- position
- display 5, 7, 107
 - of unit 26
- positioning units on benchtop 21
- power
- button 5, 7
 - cable 16
 - main switch 4, 6, 7
 - outlet 4, 6, 7
 - plug 16
 - sources 18
- product
- identification label 238
 - specifications 249
- Program Switcher button 10
- programmable instruments,
standards 126, 187
- programming, GPIB 192
- protocol
- HS488 136
 - IEEE 488.1 136
- PS/2
- keyboard 61
 - mouse 61, 62, 66
- purchased options 49
- Q**
- queue
- error/event 182
 - input 180
 - output 181

Index

R

rackmount	
cabinet	25
installing units in	22
kit for unit	22
RAID 1	12
reading PDF files	106
Ready, module status	100
receiving data	
with Ethernet port	138
with GPIB port	138
with serial port	139
regional and language settings	39, 71
register	
diagram	185, 186
ESE	183
ESR	183
SRE	183
STB	183
remote control	
ActiveX (DCOM)	127, 138
configuring	143, 147, 341
description of commands	187
error messages	194
GPIB	127, 138
limitations	136
messages	180
methods	2, 125
monitoring	209
RS-232	126, 127, 139
status	176
TCP/IP	339–355
TCP/IP over Telnet	128
remote LED	10
remote to local	178
removing a module	30, 34
repairing unit	17
reset settings	97
results, working on	103
return merchandise authorization (RMA) ..	247
returned values, setting	140

reverting to default settings	97, 145
right, swipe	41
rights in IQS Manager	85
RS-232	
communication	126
configuring parameters	144
control	127
port	139
selecting	143
rules	
programming	193
syntax	190
syntax conventions	187

S

safeguarding units	36
safety	
caution	13
conventions	13
power cable	16
warning	13
saving	
any configuration	92
configuration on exit	94
SCPI	
commands	187
data types	287
guidelines	126, 187
references	187
screen brightness	69
security levels in IQS Manager	85
selecting	
regional and language options	71
startup interface	84
selection dial	10
semicolon	190
sending data	
with Ethernet port	138
with GPIB port	138
with serial port	139
separator	189, 190

-
- service and repairs..... 247
 - service centers..... 248
 - service request enable register (SRE) 183
 - setting
 - instrument control utility..... 142
 - monitor window columns..... 104
 - shipping to EXFO 247
 - show Charm bar..... 41
 - software
 - accessing 54
 - automatic launch..... 84
 - exiting 55
 - installing..... 46
 - options 49
 - upgrading..... 46
 - using passwords 85
 - utilities..... 108
 - sound, adjusting 68
 - space..... 188
 - specific commands..... 311
 - specifications, product 249
 - speed, fan 90
 - square brackets 188
 - stand for controller unit 21
 - standard event status
 - enable register (ESE) 183
 - register (ESR) 183
 - standard status data structure
 - diagram 185, 186
 - general 183
 - startup interface, selecting..... 84
 - status
 - local..... 176
 - local with lockout 176
 - remote..... 176
 - remote with lockout 177
 - switching 178
 - status bar 100
 - status byte register (STB)..... 183
 - storage requirements 213
 - SumatraPDF reader..... 106
 - swipe..... 41
 - symbols, safety 13
 - syntax
 - rules..... 187, 190
 - SCPI..... 187
 - symbols..... 188
 - system
 - emergency tools 220
 - tree 99
 - viewing information about 239
- ## T
- TCP/IP
 - activating 341
 - commands 349–355
 - configuring parameters 144
 - connecting to Linux 346
 - connecting to Windows 342
 - control 126, 127
 - features..... 340
 - introduction..... 339
 - port number 5024 339
 - release examples 348
 - selecting 143, 342
 - technical specifications..... 249
 - technical support..... 238
 - temperature for storage 213
 - theme color, changing 68
 - tools system, emergency 220
 - touchscreen
 - calibration..... 67
 - cleaning 213
 - gestures 41
 - transportation requirements..... 213, 243
 - turning IQS-600
 - off..... 38, 55
 - on 38
 - turning lights on/off 70
 - types, data..... 267

Index

U

unit	
covers	17
disconnecting	16
first configuration	39
installing	17
locating	107
position	26
repairing	17
status	176
ventilation	17
updating	
applications	46
Windows applications	214
upgrading software	46
user guide. see online user guide	
using configuration in different units	92
utilities	
in IQS Manager	108
in Windows	108
utility module	357

V

ventilation	17, 90
vertical bar	189
viewing	
PDF files	106
system information	239
volume, adjusting	68

W

WAN network	127, 128
warranty	
certification	246
exclusions	246
general	245
liability	245
white space	188

Windows

8.1 Pro version	41
Explorer	108
security	85
update of applications	214
Wireshark	108
wizard, configuration	39
working on results	103
working with Windows	41
wsp	188

NOTICE

通告

CHINESE REGULATION ON RESTRICTION OF HAZARDOUS SUBSTANCES

中国关于有害物质限制的规定

NAMES AND CONTENTS OF THE TOXIC OR HAZARDOUS SUBSTANCES OR ELEMENTS CONTAINED IN THIS EXFO PRODUCT



包含在本 EXFO 产品中的有毒有害物质或元素的名称和含量

O	Indicates that this toxic or hazardous substance contained in all of the homogeneous materials for this part is below the limit requirement in SJ/T11363-2006 表示该有毒有害物质在该部件所有均质材料中的含量均在 SJ/T11363-2006 标准规定的限量要求以下。
X	Indicates that this toxic or hazardous substance contained in at least one of the homogeneous materials used for this part is above the limit requirement in SJ/T11363-2006 表示该有毒有害物质至少在该部件的某一均质材料中的含量超出 SJ/T11363-2006 标准规定的限量要求。

Part Name 部件名称	Toxic or hazardous Substances and Elements 有毒有害物质和元素					
	Lead 铅 (Pb)	Mercury 汞 (Hg)	Cadmium 镉 (Cd)	Hexavalent Chromium 六价铬 (Cr VI)	Polybrominated biphenyls 多溴联苯 (PBB)	Polybrominated diphenyl ethers 多溴二苯醚 (PBDE)
Enclosure 外壳	O	O	O	O	O	O
Electronic and electrical sub-assembly 电子和电子组件	X	O	X	O	X	X
Optical sub-assembly ^a 光学组件 ^a	X	O	O	O	O	O
Mechanical sub-assembly ^a 机械组件 ^a	O	O	O	O	O	O

a. If applicable.
如果适用。

MARKING REQUIREMENTS
标注要求

Product 产品	Environmental protection use period (years) 环境保护使用期限 (年)	Logo 标志
This EXFO product 本 EXFO 产品	10	
Battery ^a 电池 ^a	5	

a. If applicable.
如果适用。

P/N: 1067643

www.EXFO.com · info@exfo.com

CORPORATE HEADQUARTERS	400 Godin Avenue	Quebec (Quebec) G1M 2K2 CANADA Tel.: 1 418 683-0211 · Fax: 1 418 683-2170
EXFO AMERICA	3400 Waterview Parkway Suite 100	Richardson, TX 75080 USA Tel.: 1 972-761-9271 · Fax: 1 972-761-9067
EXFO EUROPE	Winchester House, School Lane	Chandlers Ford, Hampshire S053 4DG ENGLAND Tel.: +44 2380 246 800 · Fax: +44 2380 246 801
EXFO ASIA-PACIFIC	62 Ubi Road 1, #09-01/02 Oxley Bizhub 2	SINGAPORE 408734 Tel.: +65 6333 8241 · Fax: +65 6333 8242
EXFO CHINA	Beijing Global Trade Center, Tower C, Room 1207, 36 North Third Ring Road East, Dongcheng District	Beijing 100013 P. R. CHINA Tel.: +86 (10) 5825 7755 · Fax: +86 (10) 5825 7722
EXFO SERVICE ASSURANCE	270 Billerica Road	Chelmsford MA, 01824 USA Tel.: 1 978 367-5600 · Fax: 1 978 367-5700
EXFO FINLAND	Elektroniikkatie 2	FI-90590 Oulu, FINLAND Tel.: +358 (0) 403 010 300 · Fax: +358 (0) 8 564 5203
TOLL-FREE	(USA and Canada)	1 800 663-3936

© 2015 EXFO Inc. All rights reserved.
Printed in Canada (2015-02)

