

AXS-200/635i

Copper, VDSL2, ADSL2+ and IP
Triple-Play Test Set



Copyright © 2010–2011 EXFO Inc. All rights reserved. No part of this publication may be reproduced, stored in a retrieval system or transmitted in any form, be it electronically, mechanically, or by any other means such as photocopying, recording or otherwise, without the prior written permission of EXFO Inc. (EXFO).

Information provided by EXFO is believed to be accurate and reliable. However, no responsibility is assumed by EXFO for its use nor for any infringements of patents or other rights of third parties that may result from its use. No license is granted by implication or otherwise under any patent rights of EXFO.

EXFO's Commerce And Government Entities (CAGE) code under the North Atlantic Treaty Organization (NATO) is 0L8C3.

The information contained in this publication is subject to change without notice.

Trademarks

EXFO's trademarks have been identified as such. However, the presence or absence of such identification does not affect the legal status of any trademark.

Units of Measurement

Units of measurement in this publication conform to SI standards and practices.

Version number: 3.0.0

Contents

Certification Information	vi
1 Introducing the Copper, VDSL2, ADSL2+ and IP Triple-Play Test Set	1
Main Features	1
Cable Connections	4
LED Indicators	5
Electrical Safety Information	5
ADSL2+ Basic Principles	6
VDSL2	6
Navigating through the AXS-200/635i	7
Conventions	8
2 Getting Started with Fault Isolation Tools	9
Dialer Function	10
Regional Settings	15
Saving Results	20
Reading Saved Results	23
3 Auto Tests	25
Configuring CQ Auto Tests	25
Running CQ Auto Tests and Viewing Results	37
Inactive Pair Test	45
Configuring Inactive Pair Test	45
Running Inactive Pair Test and Viewing Results	49
Final/Active Pair Test	54
Configuring Final/Active Pair Test	54
Running Final/Active Pair Test and Viewing Results	59
Video-DSL Rate Prediction	62
Configuring Video-DSL Rate Prediction	62
Running Video-DSL Rate Prediction Tests and Viewing Results	68
4 POTS Auto Test	79
5 Multi-meter Tests	81
Multi-meter	81
In Service Pair Detection Test	90
Rectified Loop (Corrosion) Detection Test	91
Water Detection Test	91
Resistive Balance	92

Contents

6 VF Tests	95
Receive Tone (RX)	96
Send Tone (TX)	97
Tracing Tone	98
Noise Metallic	99
Impulse Noise	100
Power Influence	102
Longitudinal Balance	103
Load Coil Detection	103
7 Fault Location	105
TDR Test	106
RFL Single Pair (2 wire) Test	108
RFL Separate Good Pair (4 wire) Test	111
Loop Mapper Test	114
8 Wideband Tests	119
Receive Tone (RX)	120
Send Tone (TX)	121
PSD Noise	122
Spectral Detective Test	125
Impulse Noise Test	128
Impulse Noise Histogram	130
Attenuation Test	133
Longitudinal Balance	135
Data Rate Prediction	137
9 Getting Started with DSL and Ethernet Testing	145
DSL/IP Tests	145
Saving Results	147
Read Saved Results	149
10 Connection Setup for DSL/IP Triple-Play Verification Tests	151
Setup Profile	151
Setup Line Connection	155
11 Configure Tests for DSL/IP Triple-Play Verification	167
Configure Profile	168
Configure DSL/IP Tests	169
12 Running Manual Tests	181
Reading Results	181

13 IPTV Analysis	195
Reading Results	195
14 Data Analysis	217
Reading Results	217
15 Running a VoIP Test	231
Reading Results	231
16 Maintenance	245
General Maintenance	245
Battery Charging and Replacing	245
Recycling and Disposal (Applies to European Union Only)	246
17 Troubleshooting	247
Solving Common Problems	247
Contacting the Technical Support Group	248
Transportation	249
18 Warranty	251
General Information	251
Liability	252
Exclusions	252
Certification	252
Service and Repairs	253
EXFO Service Centers Worldwide	254
A Technical Specifications	255
Index	261

Certification Information

F.C.C. Information

Electronic test equipment is exempt from Part 15 compliance (FCC) in the United States. However, compliance verification tests are systematically performed on most EXFO equipment.

CE Information

Electronic test equipment is subject to the EMC Directive in the European Union. The EN61326 standard prescribes both emission and immunity requirements for laboratory, measurement, and control equipment. This unit has undergone extensive testing according to the European Union Directive and Standards.

CSA Information

This unit is certified by the CSA (certificate number 162451) and was evaluated according to applicable CSA and UL standards (as confirmed by “C-US” mark) as well as applicable IEC standards for use in Canada, the United States, and other countries.

EXFO **CE** **DECLARATION OF CONFORMITY**

Application of Council Directive(s):	2006/95/EC - The Low Voltage Directive 2004/108/EC - The EMC Directive And their amendments
Manufacturer's Name:	EXFO Electro-Optical Engineering Inc.
Manufacturer's Address:	400 Godin Avenue Quebec, Quebec Canada, G1M 2K2 (418) 683-0211
Equipment Type/Environment: Trade Name/Model No.:	Test & Measurement / Industrial AXS-200/635 Copper, VDSL2, ADSL2+ and IP Triple-Play Test Set

Standard(s) to which Conformity is Declared:

EN 61010-1:2001	Safety Requirements for Electrical Equipment for Measurement, Control, and Laboratory Use, Part 1: General Requirements.
EN 61326-1:2006	Electrical Equipment for Measurement, Control and Laboratory Use - EMC Requirements – Part 1: General requirements
EN 55022: 1998 +A2: 2003	Information technology equipment - Radio disturbance characteristics - Limits and methods of measurement

I, the undersigned, hereby declare that the equipment specified above conforms to the above Directive and Standards.

Manufacturer

Signature:

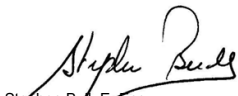

Full Name: Stephen Bull, E, Eng
Position: Vice-President Research and Development
Address: 400 Godin Avenue, Quebec (Quebec),
Canada, G1M 2K2
Date: November 04, 2008

1 **Introducing the Copper, VDSL2, ADSL2+ and IP Triple-Play Test Set**

The AXS-200/635i Copper, VDSL2, ADSL2+ and IP Triple-Play Test Set is a handheld unit that integrates the functionalities of the AXS-200/610 30 MHz Copper Test Set and the AXS-200/630 VDSL2, ADSL2+ and IP Triple-Play Test Set. The AXS-200/635i allows you to qualify and troubleshoot the copper-loop plant and triple-play services from top to bottom by using pass/fail-driven automated functionalities with one consolidated test set.

In addition to validating connectivity to the DSLAM, the AXS-200/635i provides upstream and downstream parameters such as actual data rates, attenuation and noise margin. It delivers advanced IPTV measurements: packet jitter, packet loss, PCR jitter, MDI, PID viewer, and IGMP zap time; both in Terminate (stand-alone) and Through mode operation. The AXS-200/635i also monitors residential VoIP call flow and statistics, facilitating VoIP QoS assurance.

Main Features

- Clear Auto Test results with user-definable pass/fail criteria.
- VDSL2, ADSL2+, AUTO-DSL, Ethernet and HPNA-coax tests in a single unit.
- IPTV testing over existing legacy DSLAMs (Lucent Stinger - VDSL2-STGR) and newer solutions (Alcatel 7330 - VDSL2-ALCL).
- Key IPTV qualification parameters with features such as set-top box (STB) emulation, join/leave requests, PCR jitter analysis and MDI reporting.
- Superior network testing such as ping and traceroute measurements as well as HTTP and FTP speed testing.
- 30-MHz spectrum analysis for single-ended VDSL2 pre qualification and deployments; backward-compatible to ADSL2+.
- Verification of traditional voiceband circuits

Introducing the Copper, VDSL2, ADSL2+ and IP Triple-Play Test Set

Main Features

- Spectral detective with auto identification of disturbers
- Single-ended testing – no remote device required
- LoopMapper – graphical loop depiction
- Color display with graphical analysis
- POTS and VF measurements for complete ADSL2+ and VDSL2 loop qualification
- Data rate prediction
- Analog IPTV auto test
- In-service pair, rectified loop, and water detection tests

Typical Applications

The AXS-200/635i allows you to test outside the customer premises over VDSL1.5/2, ADSL1/2/2+ or inside over Ethernet. Both modes allow you to use the Copper, VDSL2, ADSL2+ and IP Triple-Play Test Set for several applications, such as:

- IPTV analysis
- Data analysis
- VoIP analysis
- Manual tests
- Auto tests

In addition, the unit can be configured to run a series of fault isolation tools to see if the cable is suitable for carrying digital subscriber line (DSL) technologies such as:

- POTS auto test
- Multi-meter tests
- VF tests
- Fault location tests
- Wideband tests

Introducing the Copper, VDSL2, ADSL2+ and IP Triple-Play Test Set

Cable Connections

The graphic below shows the connectors on the AXS-200/635i device.

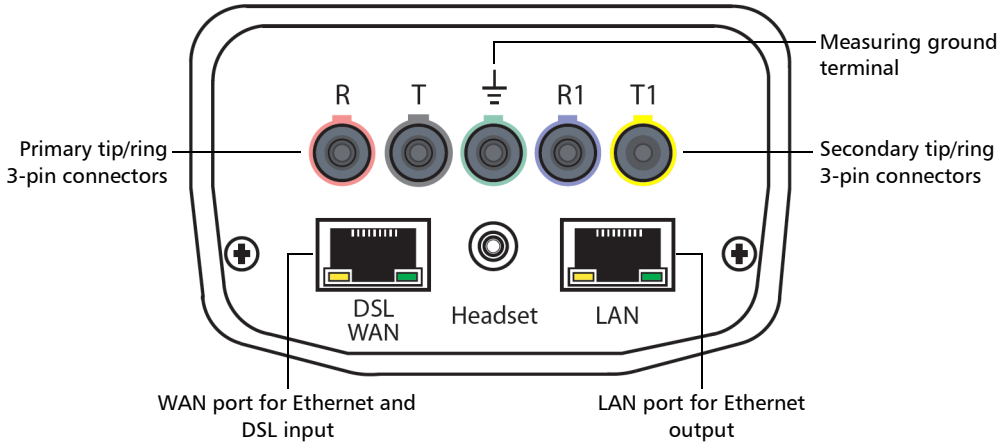

Note: When connecting a DSL cable to the WAN port, use the RJ-45 plug end of the 26AWG cable provided with the unit. There is a 1500V maximum transient voltage on telecom ports. Basic is needed for external telecom circuits.

Note: When connecting to the LAN port, use only shielded Ethernet cables during DSL testing.

LED Indicators

The graphic below illustrates the LED indicators across the top front of the AXS-200/635i unit.

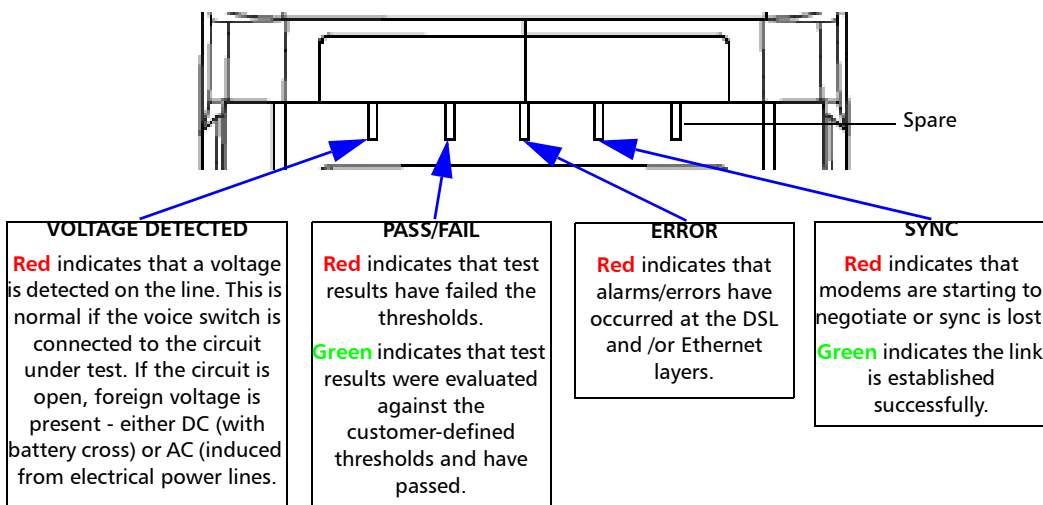

Electrical Safety Information

Do not use the unit outdoors in wet locations. For information about equipment rating for temperature, environment, and power supply, refer to the *Safety Information* chapter of the AXS-200 User Guide.

ADSL2+ Basic Principles

ADSL2+ based testing requires an ATU-C (ADSL Transceiver Unit - Central Office) that resides in a DSLAM (Digital Subscriber Line Access Multiplexer) in the Central Office/Local Exchange. At the customer premises, there is an ATU-R (ADSL Transceiver Unit - Remote) that interfaces with a user's PC.

The Copper, VDSL2, ADSL2+ and IP Triple-Play Test Set allows you to emulate the ATU-R (customer's ADSL modem). Once a connection is established with the ATU-C in the DSLAM at the service provider's central office or remote DLC, the AXS-200/635i displays the connection rates for the upstream and downstream directions of the ADSL2+ link.

VDSL2

Very high speed digital subscriber lines (VDSL) is a standard that allows extremely high speed internet access over existing copper cables. The VDSL2 standard increases the spectrum allocation up to 30 MHz for even higher performance than its predecessor VDSL1, and allows speeds up to 100 Mbps symmetrical (both up and downstream). VDSL2 also calls for support of applications such as multi-channel high definition TV (HDTV), video on demand, video-conferencing, and VoIP using the existing copper telephone line infrastructure. Along with that, it also calls for ATM, Ethernet, and IP compatibility, as well as multimode implementations to permit interoperability with existing ADSL equipment.

VDSL2 gives carriers the flexibility to start rapidly deploying VDSL2 networks and offer new broadband services including triple-play services - HDTV, VoD, high-speed data, VoIP, high-speed Internet access, video conferencing, virtual private networks (VPNs), PBX Extension, and video surveillance - to compete with cable companies.

Navigating through the AXS-200/635i

Use the following general instructions to navigate through the AXS-200/635i menus and panes:

- To navigate through the menu items use the arrow keys or press the corresponding test number on the keypad.
- To confirm a choice or open a menu item press ✓.
- Most manual tests automatically run when they are selected from the menu.
- The rotating hour glass in the title bar indicates when a test is running.

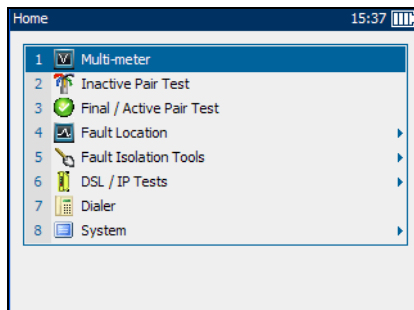

Note: For *Fault Isolation Tools*, the unit checks for an active circuit at the beginning of every manual and auto test.

- To start/stop a test, press ⏸.
- To view the contents of the panes or tabs, use the F1, F2, and F3 keys. To view any available additional tabs use the function arrow keys on either side of the F1 and F3 keys.
- To cancel an action or return to the previous item or pane, press ↶.
- To return to the home pane, press 🏠.

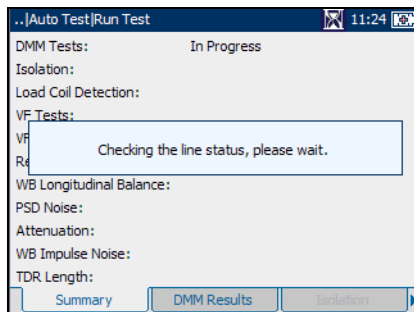

Conventions

Before using the product described in this manual, you should understand the following conventions:



WARNING

Indicates a potentially hazardous situation which, if not avoided, could result in *death or serious injury*. Do not proceed unless you understand and meet the required conditions.



CAUTION

Indicates a potentially hazardous situation which, if not avoided, may result in *minor or moderate injury*. Do not proceed unless you understand and meet the required conditions.



CAUTION

Indicates a potentially hazardous situation which, if not avoided, may result in *component damage*. Do not proceed unless you understand and meet the required conditions.



IMPORTANT

Refers to information about this product you should not overlook.

2 Getting Started with Fault Isolation Tools

The AXS-200/635i is designed to test basic twisted pair quality, identify and locate faults, perform advanced single-ended loop tests, and troubleshoot noise and signal issues all the way up to 30 MHz in support of the VDSL2 standard. These measurements offer a quick and thorough method to determine if the cable is capable of supporting xDSL technology. In addition, it utilizes noise measurements, longitudinal balance tests, and power spectral density tests to assist in the installation, maintenance, and troubleshooting of copper cables.

Note: Tests can be accessed and run directly from the Home menu.

To access/run fault isolation tools:

1. On the **Home** pane use the up/down arrow keys to highlight any one of the easy-access fault isolation tools: **Multi-meter**, **Inactive Pair Test**, **Final/Active Pair Test**, or **Fault Location**, then press **✓**.

OR

2. Select **Fault Isolation Tools** to choose from a complete list of tests.

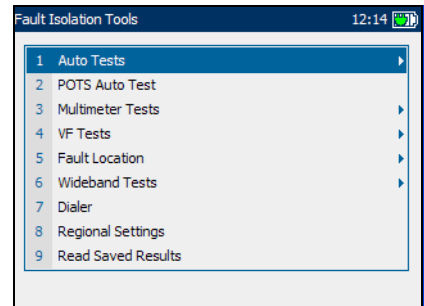
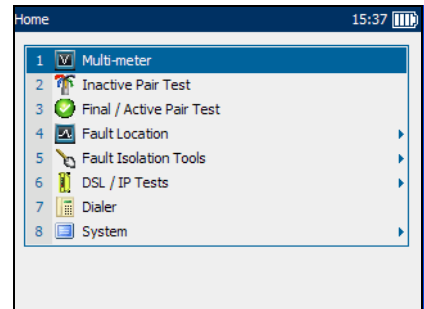

Dialer Function

The **Dialer** function provides a dial-up path from the AXS-200/635i to another tester (or quiet termination or silent switchman) through a switched circuit network. DTMF transmission is enabled via the AXS-200 keypad allowing you to place and receive POTS calls. The dialer can be accessed from the **Home** pane and is also integrated into individual test screens to give you quick access to the manual dialer function, speed dial and last dialed lists, without exiting the current test application.

Dialer

The **Dialer** menu item/tab allows you to use the unit as a telephone (with a headset) and the AXS-200 keypad as a dialer keypad when the **Dialer** is invoked, whether in the test results screens or through the separate dedicated **Dialer** application. It goes off hook immediately when entered from the menu or when switched from another tab. This allows you to quickly check if the circuit under test has dial tone or is a digital service.

Each parameter and button are described below:

- The edit box is where you enter the phone number you wish to dial. You can add this number to the **Phone Book** by pressing the **Add to Phone Book** button.
- **Dial** button is enabled whether or not there is a number present in the edit box. If there is a number, it will be dialed. If not, pressing the **Dial** button will cause the unit to go off hook and a new *placing a call* pane appears where you can manually dial a number from the keypad.

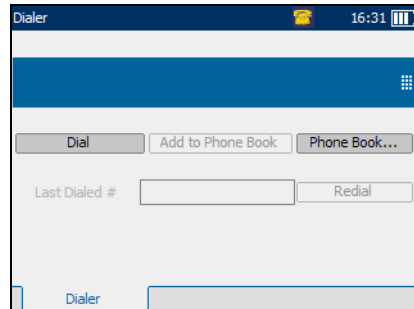

- **Dial Status** displays the progress of dialing such as **Dial Tone Detected**, **No Dial Tone**, or **Busy Tone Detected**.
- **Volume** is used to set the headset volume to **LOW** or **HIGH**.
- **Hang Up** button terminates the call and you'll be returned to the on-hook pane.
- **Phone Book...** button invokes the list of numbers to dial and supports 30 commonly called names and numbers. Names can be up to 30 characters long and numbers up to 32 digits. When returning from the **Phone Book**, the **Dialer** automatically dials the selected phone number if it is in the off-hook state.
- **Add to Phone Book** button enters the number dialed into the **Phone Book** by bringing up the *edit screen* where you can add the **Name** for the **Number** dialed and save it. After pressing either the **CANCEL** or **UPDATE** buttons, you'll be returned to the **Dialer** pane.
- **Last Dialed #** lists up to 30 last dialed numbers.
- **Redial** button dials a selected phone number from the **Last Dialed #** list.
- Icon on title bar gives a live on-screen, graphical indication of on-hook and off-hook status.

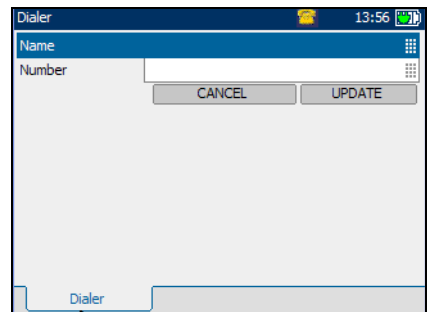
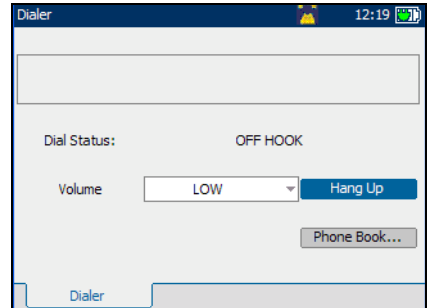

Getting Started with Fault Isolation Tools

Dialer Function

To select parameter values:

1. Press the up/down arrow keys to highlight the desired parameter.
2. Press ✓ to display the list or select the value.
3. Press the up/down arrow keys to highlight the desired value.

OR

4. Press the left arrow key to erase the existing value, and then use the alphanumeric keypad to enter a value. To cancel the entry, press ↩.
5. Press ✓ to accept the value.

Phone Book

Phone Book provides you with a list of saved names and numbers that will be part of the **Profile**.

Each parameter and button is described below:

- **Name** displays the list box of names in a **Phone Book** list.
- **Number** displays the list box of phone numbers in a **Phone Book** list.
- List Box can display up to 30 names/numbers. Once the list box reaches 30 entries the **New** button will be disabled. The **Phone Book** has 3 predefined entries: **Milliwatt Line**, **Silent Switchman**, and **Quiet Line**. These entries can be edited but not removed.

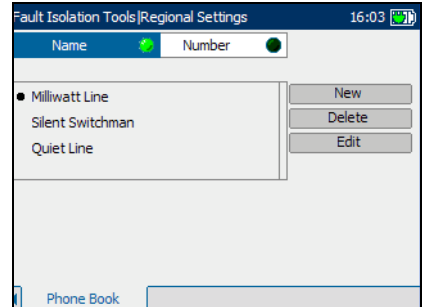

To select a name/number from the current list:

1. Press the up/down arrow keys to highlight the desired parameter.
2. Press **✓** to select the item.

This selection can be edited or removed. Once you leave this screen, the selected name/number will be used to dial. All changes are automatically saved into **Phone Book**.

- **New** invokes the edit screen where a new name and number can be entered then saved to the **Phone Book** list.
- **Delete** removes the selected entry from the **Phone Book** list.
- **Edit** invokes the edit screen where a name and number can be viewed or changed.

Getting Started with Fault Isolation Tools

Dialer Function

On the *edit screen*, the following controls are shown:

- **Name** is the name, maximum 30 characters, assigned to the phone number entered in the **Phone Book**.
- **Number** is the phone number, maximum 32 digits including #,* and comma.
- **CANCEL** button returns you to the **Phone Book** screen without saving any changes.
- **UPDATE** button stores the **Name** and **Number** entered, in the **Phone Book**.

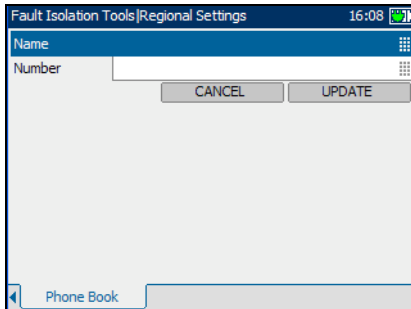

To select and edit the controls:

1. Press the up/down arrow keys to highlight the desired entry and press ✓.
2. Use the alphanumeric keypad to enter a value. To cancel the entry, press ↶.
3. Press ✓ to accept the value.
4. To return from the **Phone Book** to the **Dialer**, press the ↶. The **Dialer** automatically dials the selected phone number if it is in the off-hook state.

Regional Settings

Before executing fault isolation tools, set up the software settings and values for the cables. The AXS-200/635i allows you to save standard parameter settings to different profiles and reuse them as needed.

To access Regional Settings:

From the **Home** pane, select **Fault Isolation Tools**, then **Regional Settings**.

The following parameters are available to configure:

Select Profile

The **Select Profile** tab allows you to configure the unit with specific measurement values.

Each parameter is described below:

- **Distance Units** are the units of measurement for distances in **FEET** or **METER**.
- **Cable Gauge** is the gauge system for measuring wire sizes in **AWG** (American Wire Gauge) units or **mm** (metric wire size).
- **Profile Name** is either **Default** or a list of all available profile file names stored in the current directory.
- **Clone Profile** allows you to copy an existing profile to a new one and switch to use the new profile.

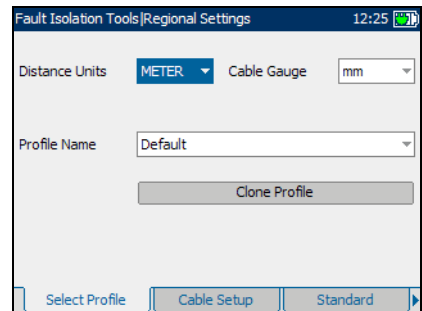

To select the parameter values:

1. Press the up/down arrow keys to highlight the desired parameter.
2. Press **✓** to display the list.
3. Use the up/down arrow keys to highlight the desired value, and press **✓** to accept the value.

Getting Started with Fault Isolation Tools

Regional Settings

When you change the selections and press  or , the following actions should be performed:

1. If **ProfileName** selection is not **Default** then save modifications (if any) into the current profile file and proceed with the selected action.
2. If **ProfileName** selection is **Default** and modification to the profile has been made then enter the new name of the profile.

At power up, all settings are read from the last current profile.

- **Enter Profile Name** is the new name of the profile.

To save modifications made to a CustomProfile:

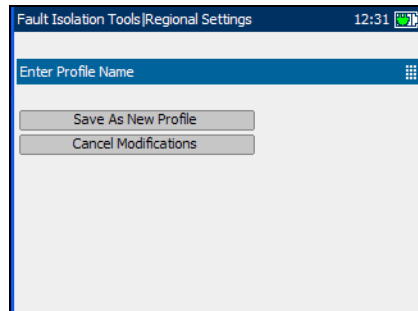

1. Select **Save as New Profile** and create and save a new **CustomProfile** name in the current directory.
2. If the file with **CustomProfile** name already exists in the current directory, you will be prompted to overwrite it.



IMPORTANT

Changes to test parameters will be lost if the unit is turned off without first saving them to a default or custom profile. The unit can also be left in suspend mode to avoid loss of test parameters.

To cancel modifications made to a CustomProfile:

1. Select **Cancel Modifications** and reload the current profile with the default profile.
2. Proceed with the previously selected action (, , ).

Cable Setup

The **Cable Setup** tab allows you to configure parameter values for the cable.

Each parameter and button is described below:

- **Cable Type** defines the gauge of the cable in use. If wire gauge is measured in American Wire Gauge (AWG) units, the available choices are: **AUTO**, **19 AWG**, **22 AWG**, **24 AWG**, or **26 AWG**. For mm gauge wire, the available choices are: **AUTO**, **0.32 mm**, **0.40 mm**, **0.50 mm**, **0.60 mm**, **0.65 mm**, **0.80 mm**, **0.90 mm**, or **1.20 mm**.
- **Cable Fill** allows you to select the type of material the cable can be filled with. Changing the selection to **AIRCORE**, **JELLY**, **PULP**, **5 PR**, or **2 PR** influences the cable capacitance per length, automatically updating the **Cap. T/R-GND** field.
- **Capacitance T-R (nF/km or nF/mi)** allows you to specify a value for the capacitance per length constant.
- **Cap. T/R-GND (nF/km or nF/mi)** allows you to specify a value for the capacitance per length to ground constant.
- **Resistance (Ohm/km or Ohm/mi)** allows you specify a value for the resistance constant of the cable.
- **Attenuation (dB/km or dB/mi)** allows you to specify a value for the reduction in signal strength or insertion loss of the cable.
- **VOP** allows you to set the velocity of propagation for the cable as a ratio of the speed of light. Enter a value between **0.400** and **0.999**.
- **Restore Defaults** allows you to reset cable parameters for the selected cable to the standard default values.

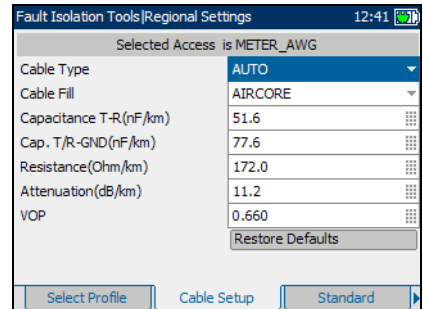

Getting Started with Fault Isolation Tools

Regional Settings

To select parameter values:

1. Press the up/down arrow keys to highlight the desired parameter.
2. Press ✓ to display the list or select the value.
3. Press the up/down arrow keys to highlight the desired value.

OR

4. Press the left arrow key to erase the existing value, and then use the alphanumeric keypad to enter a value. To cancel the entry, press ↩.
5. Press ✓ to accept the value.

To reset default cable values:

1. Press the up/down arrow keys to highlight **Cable Type**.
2. Press ✓ to display the list.
3. Press the up/down arrow keys to highlight the desired cable type, then press ✓ to accept the selection.
4. Use the up/down arrow keys to highlight the **Restore Defaults** button, then press ✓. The selected cable's default values are restored.

Standard

The **Standard** tab allows you to set unit parameter values for the selected profile composed of current **Distance Units** and **Cable Gauge**.

- **Standard** allows you to specify if the fault isolation tools should conform to the **ITU** (International Telecommunication Union) or **ANSI** (American National Standards Institute) standard.
- **Temperature** allows you to specify the units of measurement for temperature in **F** (Fahrenheit) or **C** (Celsius).
- **Connection** allows you to specify the default type of cable connections as **T-R-G** or **A-B-E**.

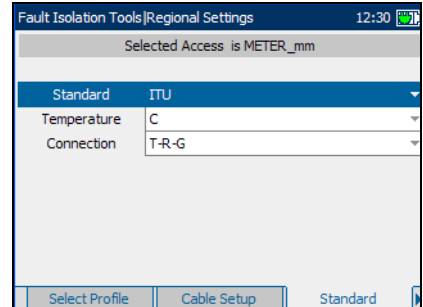

To select the parameter values:

1. Press the up/down arrow keys to highlight the desired parameter.
2. Press **✓** to display the list.
3. Use the up/down arrow keys to highlight the desired value, and press **✓** to accept the value.

Saving Results

You can save any of your results after running and viewing a test performed with the AXS-200/635i, in either text or graphical format. Each fault isolation tool includes a **Save Results** tab to do so.

Press the F1, F2, or F3 key to view this tab, or use the function arrow keys on either side of the F1 and F3 keys to access it.

Save Results

The **Save Results** tab allows you to save your test results to a file or to an HTML report.

Each entry on the pane is described as follows:

- **Save as Type** lists the following formats to save your test results:
 - **AXS200 format** is a binary file format with ext *.dat. This format can be opened only on an AXS200 unit. The **Available Graphs** list box will be unavailable in this case.
 - ***.csv** saves only graphical results. Textual results must be formatted as a comma-separated values table for easy importation to Excel. Results are saved to USB.
 - ***.gif** stands for graphics interchange format and is one of the most common file formats for graphic images on the World Wide Web. Results are saved to USB.
 - ***.bmp** saves graphical results in a bitmap file format. Results are saved to USB.
 - ***.xml** saves your data in a common language format to share on the Web. Results are saved to USB.

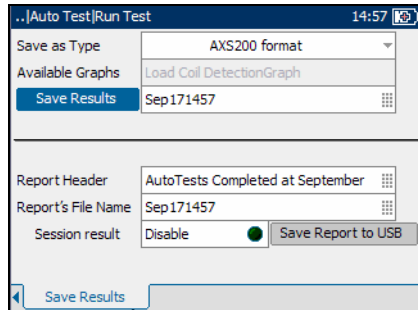



- **Available Graphs** is enabled only if the selected format under **Save as Type** is ***.gif**, ***.csv**, or ***.bmp**. The selection of graphs available are: **Load Coil Detection**, **VF Power Influence**, **PSD Noise**, **WB Spectral Detective**, **WB Impulse Noise Histogram**, **Attenuation**, **WB Long. Balance**, **Loop Mapper**, **TDR**, and **Auto Test**. For a test that does not have a graph, this list box is unavailable.
- **Save Results** button saves the test results in internal or external memory (depending on the **Save as Type** format).
- **Filename** is the current date and time stamp plus you can enter any name. If it already exists, you will be prompted to overwrite the existing file.
- **Report Header** is where you can enter any comment. The initial value is the current test followed by the date and time stamp.
- **Report's File Name** is where you can enter any name for the HTML filename. If the name already exists, you will be prompted to overwrite the existing file. The default extension is **.html**.
The default name is generated from the current time.
- **Session result** creates and saves the report for single test results when disabled, or appends multiple results in one report when enabled.
- **Save Report to USB** button saves the results to an HTML report. If a USB memory stick is not inserted, the following warning dialogue box appears: **USB device is not detected**.
- **Append to Report** button appears only if **Session result** is **Enable**, and creates an HTML report for the current test in internal memory.

Getting Started with Fault Isolation Tools

Saving Results

To set parameter values and save results:

- 1.** Press the left/right and up/down arrow keys to highlight the desired parameter.
- 2.** Press  to display the list or select the value.
- 3.** Press the up/down arrow key to highlight the desired value.
OR
- 4.** Press the left arrow key to erase the existing value, and then use the alphanumeric keypad to enter a value. To cancel the entry, press .
- 5.** Press  to accept the value.

Reading Saved Results

You can view any of your saved results with the Copper, VDSL2, ADSL2+ and IP Triple-Play Test Set, by highlighting the **Read Saved Results** menu item from the **Fault Isolation Tools** pane, and pressing ✓.

Read Saved Results

The **Read Saved Results** tab allows you to select a test type and view the results of all the files previously saved.

Select Test Type provides a list of all the fault isolation tools test types available for you to select for viewing.

To open previously saved test results:

1. Press ✓ to open the list.
2. In the list, press the up/down arrows to select the test type.
3. Press ✓ to confirm the selection.
4. Press the down arrow to activate the **Result Files** list box and press ✓ to display the list of available files.
5. Press the up/down arrows to select the desired result file.
6. Press ✓ to view the selection.

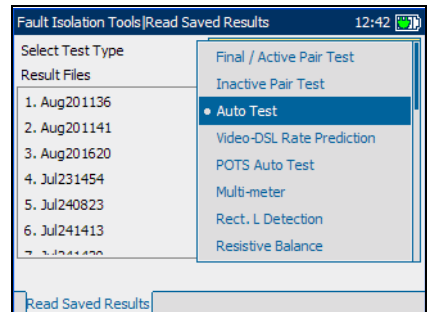

3 Auto Tests

The auto test function allows you to automatically run tests used in pre-qualification, installation, and maintenance of different circuit types from POTS to VDSL2. Auto tests include a range of different tests that compare measured results against stored threshold values to provide pass or fail results. The results are displayed in both text and graphical format.

To access Auto Tests:

1. From the **Home** pane use the up/down arrow keys to highlight **Fault Isolation Tools** and press ✓.
2. Highlight **Auto Tests** and press ✓.

The following tests are included in the auto test function:

- CQ Auto Test
- Inactive Pair Test
- Final/Active Pair Test
- Video-DSL Rate Prediction

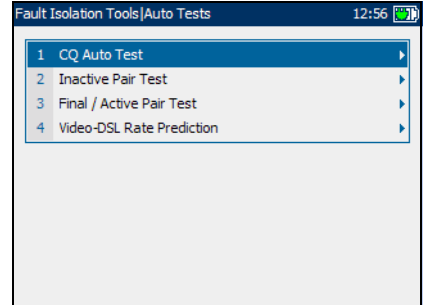

Configuring CQ Auto Tests

Parameters for auto test configuration are on the **CQ Auto Test** pane tabs.

To view CQ auto test configuration tabs:

1. From the **CQ Auto Test** pane use the up/down arrow keys to highlight **Test Configuration**, and press ✓.
2. Press the F1, F2, or F3 key to view the various tabs. To view any available additional tabs, use the function arrow keys on either side of the F1 and F3 keys.

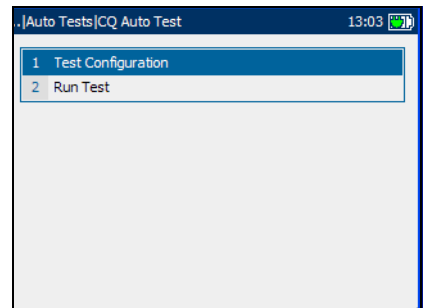

Test List 1

The **Test List 1** tab allows you to select the types of tests to include in the auto test function.

The following tests are available:

- **AC/DC Voltage** detects AC RMS and DC voltages in the line. Toggle between **Enable** and **Disable**.
- **AC/Loop Current** checks for AC RMS and loop currents in the line. Toggle between **Enable** and **Disable**.
- **Shorts Meter** measures resistances between the wires and to ground. It is also used to identify possible faults, and to measure the resistance of the twisted pair cable for estimating loop length. Toggle between **Enable** and **Disable**.
- **Opens Meter** measures the capacitance of the cable for estimating loop length. Toggle between **Enable** and **Disable**.
- **Metallic Insulation** measures the quality of insulation or sheathing for the copper pairs.
- **Load Coil Detection** detects the presence of load coils in the line. Toggle between **Enable** and **Disable**.
- **Power Influence** measures the effects that 50 Hz and 60 Hz powerline (AC Mains) interference has on the circuit under test. Toggle between **Enable** and **Disable**.
- **Longitudinal Balance** is very useful in identifying loops that will suffer from crosstalk. Toggle between **Enable** and **Disable**.
- **Noise Metallic** measures VF noise in the line. Toggle between **Enable** and **Disable**.

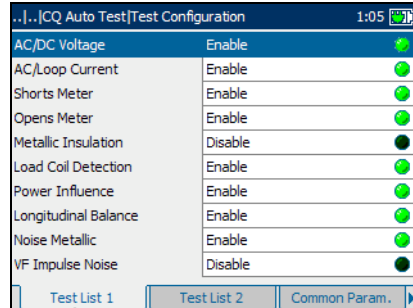

- **VF Impulse Noise** measures the random occurrences of energy spikes in the voice frequency range that have random amplitude and spectral content.

To select tests:

1. Press the up/down arrow keys to highlight a desired test.
2. Press  to toggle between **Enable** and **Disable**.
3. Select other tests as required.

Auto Tests

Configuring CQ Auto Tests

Test List 2

The **Test List 2** tab allows you to select additional tests to include in the auto test function.

The following additional tests are available:

- **VF Receive Tone** measures the level and frequency of the incoming voice signal.
- **WB Receive Tone** measures the level and frequency of the incoming wideband signal.

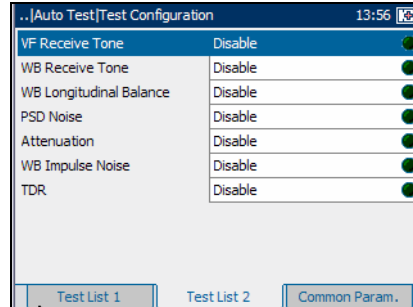

Note: *The VF and WB Receive Tone tests are mutually exclusive. When one test is enabled, the other is automatically disabled.*

- **WB Longitudinal Balance** verifies that the wideband longitudinal balance ratios comply with applicable standards.
- **PSD Noise** measures power spectral density noise.
- **Attenuation** measures the amount of reduction in signal strength.
- **WB Impulse Noise** measures the irregular occurrences of energy spikes in the wideband range that have random amplitude and spectral content.
- **TDR** test identifies and locates all types of faults as well as bridge taps (multiple appearances) and load coils.

To select tests:

1. Press the up/down arrow keys to highlight a desired test.
2. Press **✓** to toggle between **Enable** and **Disable**.
3. Select other tests as required.

Common Parameters

The **Common Param.** tab allows you to set up parameters common to all tests in the auto test function.

Each parameter is described below:

- **Cable Type** defines the gauge of the cable in use. If wire gauge is measured in AWG units, the available choices are: **AUTO**, **19 AWG**, **22 AWG**, **24 AWG**, or **26 AWG**. For mm gauge wire, the available choices are: **AUTO**, **0.32 mm**, **0.40 mm**, **0.50 mm**, **0.60 mm**, **0.80 mm**, **0.90 mm**, or **1.20 mm**.
- **Temperature** specifies the temperature of the cable under test in either **F** (Fahrenheit) or **C** (Celsius) units.
- **Isolation Test Time(sec)** specifies the duration of the isolation test.
- **Input Impedance** displays the input impedance in the loop. The available choices are: **>1 MOhm**, **100 KOhm**.

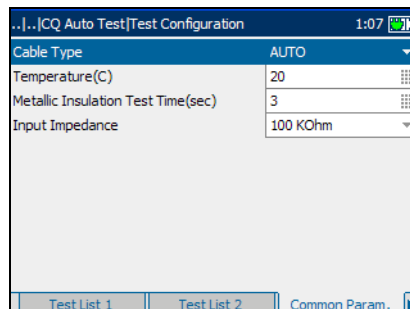

To set parameter values:

1. Press the up/down arrow keys to highlight the desired parameter.
2. Press **✓** to display the list or select the value.
3. Press the up/down arrow keys to highlight the desired value.
OR
4. Press the left arrow key to erase the existing value, and then use the alphanumeric keypad to enter a value. To cancel the entry, press **↶**.
5. Press **✓** to accept the value.

VF Test Parameters

The **VF Parameters** tab allows you to set up parameters used in the voice frequency tests.

Each parameter is described below:

- **Noise Metallic Filter** defines the level of voice frequency noise filtering. If the ANSI standard is used, the available choices are: **NONE, C-MESSAGE, C NOTCHED, 3 kHz FLAT, D-FILTER** or **15 kHz**. If the ITU standard is used, the available choices are: **NONE, PSOPHOMETRIC, P-NOTCHED, 3 kHz FLAT, D-FILTER** or **15 kHz**.
- **VF Termination** defines if the unit uses normal test impedance termination or high bridging impedance when the cable is active or terminated by other external equipment. For normal test termination select **TERMINATED**, otherwise select **BRIDGING**.
- **Imp. Noise Filter** defines the type of impulse noise filtering to use. If ANSI standard is used, the available choices are: **NONE, C-MESSAGE, C NOTCHED, 3 kHz FLAT, D-FILTER** or **15 kHz**. For the ITU standard, the choices are: **NONE, PSOPHOMETRIC, P-NOTCHED, 3 kHz FLAT, D-FILTER** or **15 kHz**.
- **Low Threshold(dBm)** defines the low threshold limits for impulse noise. Specify a value between **-40** and **0**.
- **Separation(dB)** defines the level difference (in dB) between the low, the mid and high thresholds. Specify a value between **1** and **6** dB.
- **Imp. Noise Measure. Time** defines the time duration to measure impulse noise. The available choices are: **1 minute, 5 minutes, 10 minutes, 15 minutes, 60 minutes, or 24 hours**.

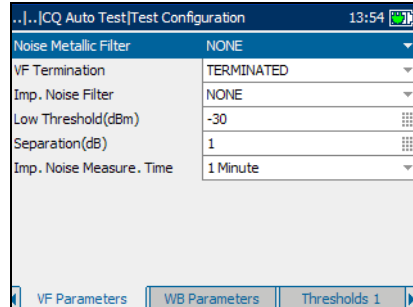

To set parameter values:

1. Press the up/down arrow keys to highlight the desired parameter.
2. Press ✓ to display the list or select the value.
3. Press the up/down arrow keys to highlight the desired value.

OR

4. Press the left arrow key to erase the existing value, and then use the alphanumeric keypad to enter a value. To cancel the entry, press ↩.
5. Press ✓ to accept the value.

WB Test Parameters

The **WB Parameters** tab allows you to set up parameters used in the wideband tests.

Each parameter is described below:

- **WB Noise Filter** defines the level of wideband noise filtering. The available choices are: **NONE**, **50 kbit**, **ISDN-E**, **HDSL-F**, **ADSL-G**, **ADSL**, **ADSL2+**, **VDSL**, **VDSL2-8**, **VDSL2-12**, **VDSL2-17**, or **VDSL2-30**.

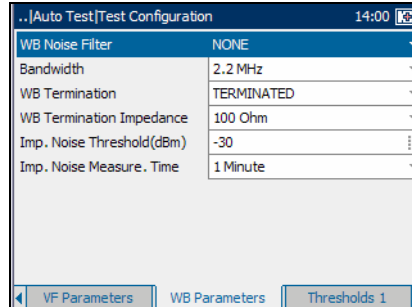

Note: *VDSL2-x filters are only available if VDSL2 is enabled in the software options.*

- **Bandwidth** specifies the frequency range for the test: **2.2 MHz**, **12 MHz**, **17 MHz**, or **30 MHz**.

Note: *Frequency bands in excess of 2.2 MHz are only displayed if VDSL2 is enabled in the software options.*

- **WB Termination** defines if the unit uses normal test impedance termination or high bridging impedance when the cable is active or terminated by other external equipment. For normal test termination select **TERMINATED**, otherwise select **BRIDGING**.
- **WB Termination Impedance** defines the impedance of the dummy load connected to the line. Select one of the following: **100 Ohm** or **135 Ohm**.
- **Imp. Noise Threshold (dBm)** is the maximum impulse noise level. Specify a value between **-50** and **0** (-40 and 0 if any filter applied).
- **Imp. Noise Measure. Time** defines the time duration to measure impulse noise. The available choices are: **1 minute**, **5 minutes**, **10 minutes**, **15 minutes**, **60 minutes**, or **24 hours**.

To set parameter values:

1. Press the up/down arrow keys to highlight the desired parameter.
2. Press ✓ to display the list or select the value.
3. Press the up/down arrow key to highlight the desired value.

OR

4. Press the left arrow key to erase the existing value, and then use the alphanumeric keypad to enter a value. To cancel the entry, press ↵.
5. Press ✓ to accept the value.

Thresholds 1

The **Thresholds 1** tab allows you to set threshold values for the auto tests.

Each parameter is described below:

- **Max. AC Voltage T-R (V)** defines the maximum AC threshold voltage for the T-R leg of the circuit. Specify a value between **1** and **30**.
- **Max. AC Voltage to GND (V)** defines the maximum AC threshold voltage to ground for the circuit. Specify a value between **1** and **30**.
- **Max. DC Voltage T-R (V)** defines the maximum DC threshold voltage for the T-R leg of the circuit. Specify a value between **1** and **400**.
- **Max. DC Voltage to GND (V)** defines the maximum DC threshold voltage to ground for the circuit. Specify a value between **1** and **400**.
- **Min. Resistance T-R(MOhm)**: defines the minimum threshold resistance for the T-R leg of the circuit. Specify a value between **0** and **999**.
- **Min. Resistance T-G(MOhm)** defines the minimum threshold resistance for the T-G leg of the circuit. Specify a value between **0** and **999**.
- **Min. Resistance R-G(MOhm)** defines the minimum threshold resistance for the R-G leg of the circuit. Specify a value between **0** and **999**.

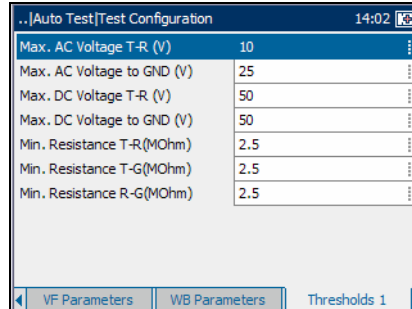

To set a *threshold value*:

1. Press the up/down arrow keys to highlight the desired parameter.
2. Press ✓ to select the value.
3. Press the left arrow key to erase the existing value, and then use the alphanumeric keypad to enter a value. To cancel the entry, press ↩.
4. Press ✓ to accept the value.

Thresholds 2

The **Thresholds 2** tab allows you to set additional threshold values.

Each parameter is described below:

- **Min. Long. Balance(dB)** defines the minimum voice frequency threshold longitudinal balance level. Specify a value between **10** and **80**.
- **Max. Noise Metallic (dBm)** defines the maximum threshold RMS noise energy level. Specify a value between **-90** and **10** if the ITU standard is used. Specify a value between **0** and **100** if the ANSI standard is used.
- **Max. VF Power Influence (dBm)** defines the maximum threshold power influence level on the circuit. Specify a value between **-90** and **20** if the ITU standard is used. Specify a value between **0** and **110** if the ANSI standard is used.
- **Min. WB Long. Balance(dB)** defines the minimum threshold wideband longitudinal balance level. Specify a value between **10** and **80**.
- **Attenuation(dB)** defines the threshold wideband attenuation level. Specify a value between **0** and **80**.

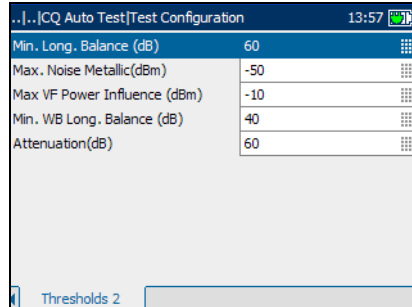

To set a threshold value:

1. Press the up/down arrow keys to highlight the desired parameter.
2. Press ✓ to select the value.
3. Press the left arrow key to erase the existing value, and then use the alphanumeric keypad to enter a value. To cancel the entry, press ↩.
4. Press ✓ to accept the value.

Running CQ Auto Tests and Viewing Results

Auto test results are located on the **CQ Auto Test** pane tabs.

To run auto tests and view results:

1. From the **CQ Auto Test** pane use the up/down arrow keys to highlight **Run Test**, and press ✓.
2. Press the F1, F2, or F3 key to view the various tabs. To view any available additional tabs, use the function arrow keys on either side of the F1 and F3 keys.

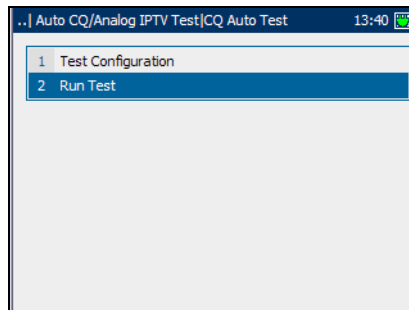

Summary

The **Summary** tab displays the overall **PASS** or **FAIL** status of all tests selected for auto testing.

A screenshot of a software window titled "Fault Isolation Tools | Read Saved Results" with a clock showing 14:08. The window displays a table of test results. The table has three columns: test name, status, and result. The results are: Multimeter Tests (Completed, PASS), Metallic Insulation (N/A), Load Coil Detection (0), VF Tests (Completed, PASS), VF Impulse Noise (N/A), Receive Tone (Completed), WB Longitudinal Balance (Completed, PASS), PSD Noise (Completed), Attenuation (Completed), WB Impulse Noise (N/A), and TDR Length (Unresolved). At the bottom, there are two tabs: "Summary" (selected) and "Multi-meter".

Multimeter Tests:	Completed	✓ PASS
Metallic Insulation:	N/A	
Load Coil Detection:	0	
VF Tests:	Completed	✓ PASS
VF Impulse Noise:	N/A	
Receive Tone:	Completed	
WB Longitudinal Balance:	Completed	✓ PASS
PSD Noise:	Completed	
Attenuation:	Completed	
WB Impulse Noise:	N/A	
TDR Length:	Unresolved	

Auto Tests

Running CQ Auto Tests and Viewing Results

Multi-meter Results

The **Multi-meter Results** tab displays the measured values and pass or fail status of each digital multi-meter test.

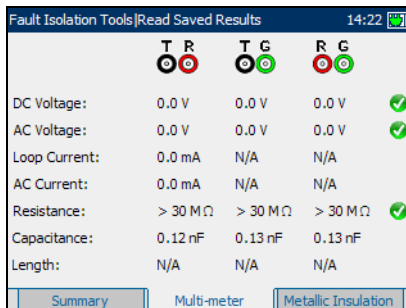

	T R	T G	R G	
DC Voltage:	0.0 V	0.0 V	0.0 V	✓
AC Voltage:	0.0 V	0.0 V	0.0 V	✓
Loop Current:	0.0 mA	N/A	N/A	
AC Current:	0.0 mA	N/A	N/A	
Resistance:	> 30 M Ω	> 30 M Ω	> 30 M Ω	✓
Capacitance:	0.12 nF	0.13 nF	0.13 nF	
Length:	N/A	N/A	N/A	

Metallic Insulation

The **Metallic Insulation** tab displays the measured **Resistance** values from the isolation test.

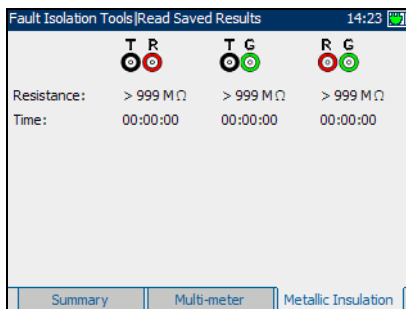

	T R	T G	R G	
Resistance:	> 999 M Ω	> 999 M Ω	> 999 M Ω	
Time:	00:00:00	00:00:00	00:00:00	

Load Coil

The **Load Coil** tab displays the number of load coils in the line, and measured values from the load coil detection test in graphical form.

To move the screen pointer:

Press the left/right arrow keys to move the screen pointer. The pointer value updates dynamically.

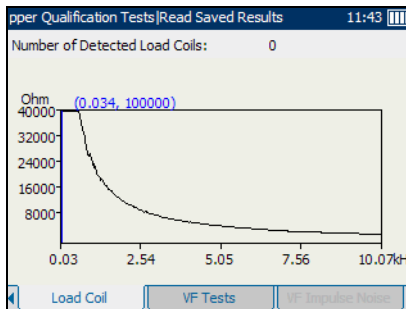

VF Tests

The **VF Tests** tab displays the measured values and **PASS** or **FAIL** status of the voice frequency tests.

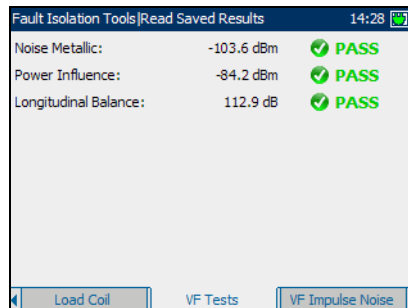

VF Impulse Noise

The **VF Impulse Noise** tab displays the measured values from the voice frequency impulse noise tests.

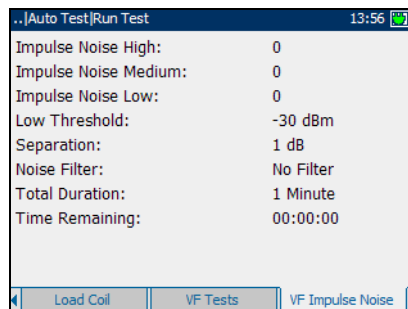

Receive Tone

The **Receive Tone** tab displays the current received frequency and level values of the received tone.

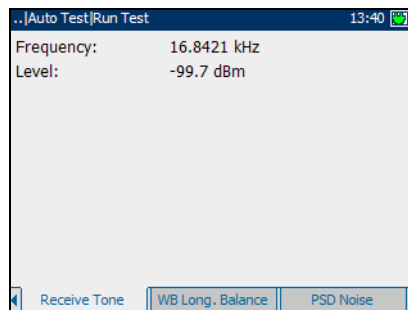

Auto Tests

Running CQ Auto Tests and Viewing Results

WB Longitudinal Balance

The **WB Long. Balance** tab displays in graphical form the measured values from the wideband longitudinal balance tests.

The list and buttons on the tab are described below:

- (Zoom function List) allows you to select the desired zoom function **Horizontal Zoom** or **Vertical Zoom**. The selected function is displayed in the box.
- **Zoom In** allows you to increase the level of zoom for the selected zoom function.
- **Zoom Out** allows you to reduce the level of zoom for the selected zoom function.

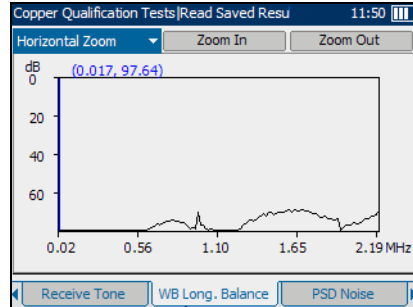

To zoom in or out:

1. Press ✓ to display a list of zoom functions.
2. Press the up/down arrow keys to highlight the desired zoom function.
3. Press ✓ to select the zoom function.
4. Use the left/right arrow keys to highlight the **Zoom In** or **Zoom Out** button as required, then press ✓.

The graphical display zooms in or out accordingly.

5. Press ✓ repeatedly to continue zooming.

To move the screen pointer:

Press the left/right arrow keys to move the screen pointer. The pointer value updates dynamically.

PSD Noise

The **PSD Noise** tab displays the **RMS Noise** value from the power spectral density (PSD) noise tests in text and graphical form.

The list and buttons on the tab are described below:

- (Zoom function List) allows you to select the desired zoom function: **Horizontal Zoom** or **Vertical Zoom**. The selected function is displayed in the box.
- **Zoom In** allows you to increase the level of zoom for the selected zoom function.
- **Zoom Out** allows you to reduce the level of zoom for the selected zoom function.

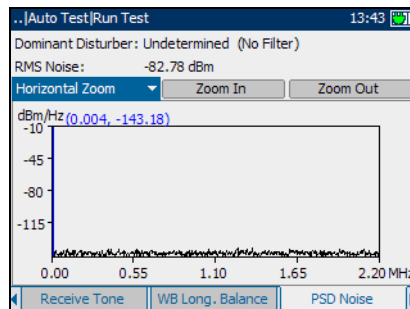

To zoom in or out:

1. Press ✓ to display a list of zoom functions.
2. Press the up/down arrow keys to highlight the desired zoom function.
3. Press ✓ to select the zoom function.
4. Use the left/right arrow keys to highlight the **Zoom In** or **Zoom Out** button as required, then press ✓.

The graphical display zooms in or out accordingly.

5. Press ✓ repeatedly to continue zooming.

To move the screen pointer:

Press the left/right arrow keys to move the screen pointer. The pointer value updates dynamically.

Auto Tests

Running CQ Auto Tests and Viewing Results

Attenuation

The **Attenuation** tab displays in graphical form the cable length value from attenuation tests.

The list and buttons on the tab are described below:

- (Zoom function List) allows you to select the desired zoom function: **Horizontal Zoom** or **Vertical Zoom**. The selected function is displayed in the box.

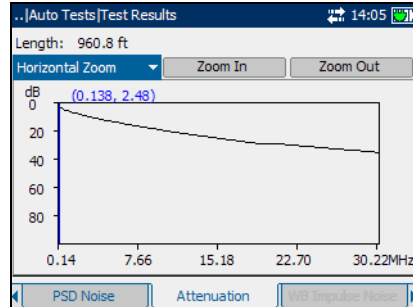

- **Zoom In** allows you to increase the level of zoom for the selected zoom function.
- **Zoom Out** allows you to reduce the level of zoom for the selected zoom function.

To zoom in or out:

1. Press ✓ to display a list of zoom functions.
2. Press the up/down arrow keys to highlight the desired zoom function.
3. Press ✓ to select the zoom function.
4. Use the left/right arrow keys to highlight the **Zoom In** or **Zoom Out** button as required, then press ✓.

The graphical display zooms in or out accordingly.

5. Press ✓ repeatedly to continue zooming.

To move the screen pointer:

Press the left/right arrow keys to move the screen pointer. The pointer value updates dynamically.

WB Impulse Noise

The **WB Impulse Noise** tab displays the measured values from the wideband impulse noise tests.

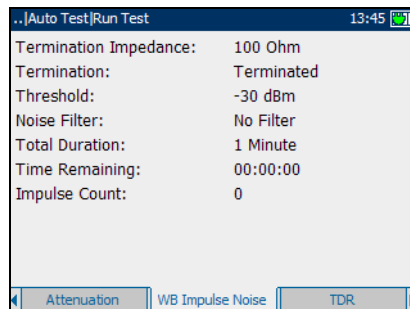

TDR

The **TDR** tab displays the current **Pulse/Gain** and measured values from the time domain reflectometry tests.

TDR first attempts to find the length of the circuit and then searches all ranges from shortest to longest for significant events. Upon completion, the test selects the nearest major event, sets the range to match, and aligns the cursor with the event.

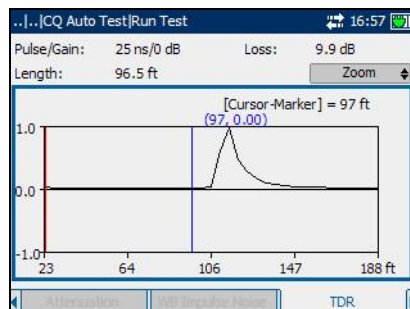

To make **TDR** adjustments via the keypad:

1. Press **✓** to change the mode button (top-right corner of the pane) and function of the up/down arrow keys.
2. Press **✓** repeatedly to cycle between:
 - **Zoom**
 - **CursorMarker** selection

Auto Tests

Running CQ Auto Tests and Viewing Results

To measure the distance/duration between reflections:

1. Press  to cycle the mode and change to **CursorMarker**.
2. Press the left/right arrow keys to position the blue cursor (indicated by the blue color of data above cursor).
3. Press the up arrow key to select the red marker.
4. Press the left/right arrow keys to position the marker.
5. The difference between the cursor and marker is continuously updated and is indicated with a triangle (delta symbol) above the graph.

To zoom in/out:

1. Press  to select the **Zoom** function. Default mode is **Zoom**.
2. Press the up/down arrow keys to increase/decrease **Zoom** function. The graphical display zooms in or out accordingly.

Inactive Pair Test

The inactive pair test is an auto-test that performs several individual measurements in sequence. It provides a pass/fail summary as well as detailed text/graphical results.

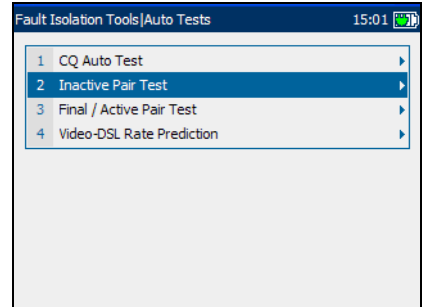

Configuring Inactive Pair Test

Parameters for auto test configuration are on the **Inactive Pair Test** pane tabs.

To view the test configuration tabs:

1. From the **Inactive Pair Test** pane use the up/down arrow keys to highlight **Test Configuration**, and press **✓**.
2. Press the F1, F2, or F3 key to view the various tabs. To view any available additional tabs, use the function arrow keys on either side of the F1 and F3 keys.

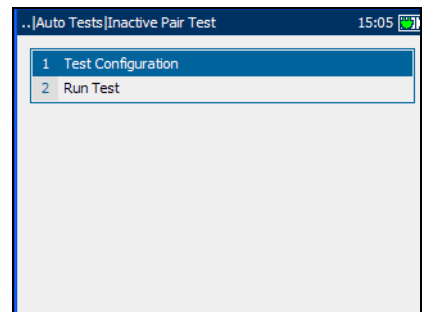

Test Setup

The **Test Setup** allows you to select/adjust the setup parameters for the Inactive Pair Test as follows:

- **Cable Type** defines the gauge of the cable in use. If wire gauge is measured in American Wire Gauge (AWG) units, the available choices are: **AUTO, 19 AWG, 22 AWG, 24 AWG, or 26 AWG**. For mm gauge wire, the available choices are: **AUTO, 0.32 mm, 0.40 mm, 0.50 mm, 0.60 mm, 0.65 mm, 0.80 mm, 0.90 mm, or 1.20 mm**.
- **Cable Fill** allows you to select the type of material the cable can be filled with. Changing the selection to **AIRCORE, JELLY, PULP, 5 PR, or 2 PR** influences the cable capacitance per length, automatically updating the **Cap. T/R-GND** field.
- **Metallic Insulation Test Time(sec)** specifies the duration of the isolation test: **1 to 99**. The default is **3** sec.
- **Input Impedance** displays the input impedance in the loop. The available choices are: **>1 MOhm, 100 KOhm**.
- **VF Termination** defines if the unit uses normal test impedance termination or high bridging impedance when the cable is active or terminated by other external equipment. For normal test termination select **TERMINATED**, otherwise select **BRIDGING**.
- **Bandwidth** specifies the frequency range for the test: **2.2 MHz, 12 MHz, 17 MHz, or 30 MHz**.

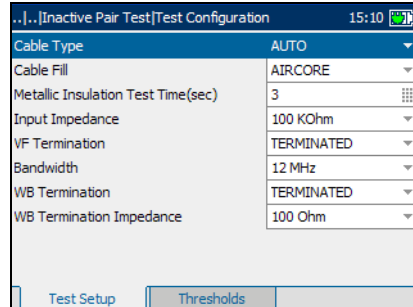

Note: *Frequency bands in excess of 2.2 MHz are only displayed if VDSL2 is enabled in the software options.*

- **WB Termination** defines if the unit uses normal test impedance termination or high bridging impedance when the cable is active or terminated by other external equipment. For normal test termination select **TERMINATED**, otherwise select **BRIDGING**.
- **WB Termination Impedance** defines the impedance of the dummy load connected to the line. Select one of the following: **100 Ohm** or **135 Ohm**.

To set parameter values:

1. Press the up/down arrow keys to highlight the desired parameter.
2. Press ✓ to display the list or select the value.
3. Press the up/down arrow key to highlight the desired value.
OR
4. Press the left arrow key to erase the existing value, and then use the alphanumeric keypad to enter a value. To cancel the entry, press ↩.
5. Press ✓ to accept the value.

Auto Tests

Configuring Inactive Pair Test

Thresholds

The **Thresholds** tab displays the threshold parameters for the Inactive Pair Test. They are part of the CQ profile and cannot be edited on this pane.

Each parameter is described below:

- **Max. AC Voltage T-R (V)** is the maximum AC threshold voltage for the T-R leg of the circuit.
- **Max. AC Voltage to GND (V)** is the maximum AC threshold voltage to ground for the circuit.
- **Max. DC Voltage T-R (V)** is the maximum DC threshold voltage for the T-R leg of the circuit.
- **Max. DC Voltage to GND (V)** is the maximum DC threshold voltage to ground for the circuit.
- **Min. Metallic Insulation (MOhm)** is the minimum threshold resistance for the circuit.
- **Max. Opens Variance (%)** is the percentage maximum capacitance balance.
- **Max. Noise Metallic (dBrnC)** is the maximum level of voice frequency noise.

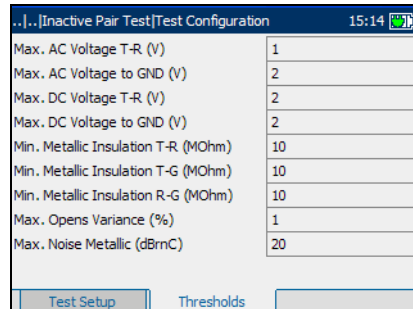

The screenshot shows a software window titled "[Inactive Pair Test] Test Configuration" with a timestamp of 15:14. The window contains a table of threshold parameters and their values. At the bottom, there are three tabs: "Test Setup", "Thresholds" (which is selected), and another unlabeled tab.

Parameter	Value
Max. AC Voltage T-R (V)	1
Max. AC Voltage to GND (V)	2
Max. DC Voltage T-R (V)	2
Max. DC Voltage to GND (V)	2
Min. Metallic Insulation T-R (MOhm)	10
Min. Metallic Insulation T-G (MOhm)	10
Min. Metallic Insulation R-G (MOhm)	10
Max. Opens Variance (%)	1
Max. Noise Metallic (dBrnC)	20

Running Inactive Pair Test and Viewing Results

Results details are located on the **Inactive Pair Test** pane tabs.

To run the tests and view results:

1. From the **Inactive Pair Test** pane use the up/down arrow keys to highlight **Run Test**, and press ✓.
2. Once the tests are completed, highlight the **Details** button from the **Result Summary** pane and press ✓ to view the results.
3. Press the F1, F2, or F3 key to view the various tabs. To view any available additional tabs, use the function arrow keys on either side of the F1 and F3 keys.

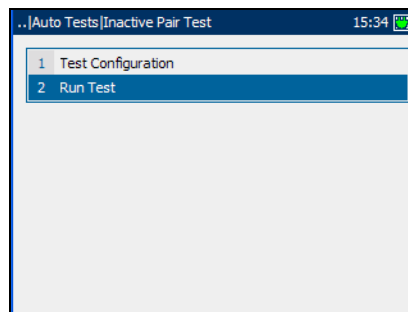

Result Summary

The **Result Summary** tab allows you to view the pass/fail status and **Details** of all tests configured for the Inactive Pair Test.

To view more information about each available test result:

1. Press the up/down arrows to highlight the **Details** button alongside the desired test result.
2. Press ✓ to select the desired **Details** button.
3. To return to the **Result Summary** pane, press ↶.

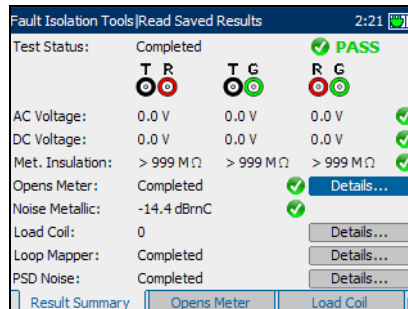

Auto Tests

Running Inactive Pair Test and Viewing Results

Opens Meter

Opens Meter is a measured value for each lead combination. The test measures the capacitance of the loop and **Opens Length**.

- **Opens Length** is calculated from the corresponding capacitance and displayed in either meter or feet, depending on the unit selection in **Regional Settings**. If the corresponding capacitance is $< 0.2 \text{ nF}$ or $> 10 \mu\text{F}$, **N/A** is displayed.
- **Opens Variance** is the percentage difference between the capacitance on T-G and R-G. If the capacitances on T-G or R-G are $< 0.2 \text{ nF}$ or $> 10 \mu\text{F}$, **N/A** is displayed and the opens variance is considered a fail status.

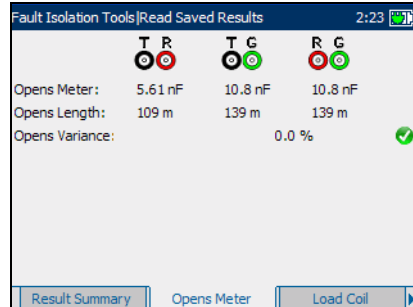

Load Coil

The **Load Coil** tab displays the number of load coils detected in the line.

- If only 1 or 2, **Probable Filter Detected** is displayed.
- **Splitter Detected** is displayed if present.

Measured values from the load coil detection test are shown in graphical form.

To move the screen pointer:

Press the left/right arrow keys to move the screen pointer. The pointer value updates dynamically.

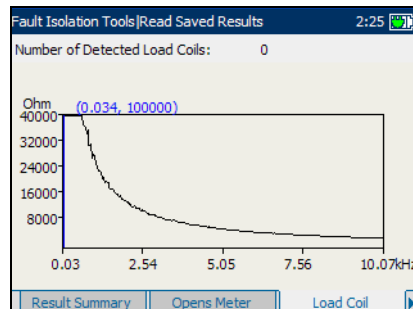

Loop Mapper

The **Loop Mapper** tab allows you to view results of the Loop Mapper test in graphical and text form.

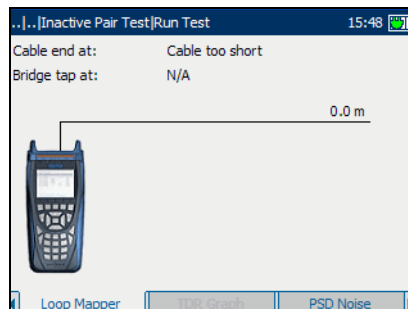

TDR Graph

The **TDR Graph** tab displays the current **Pulse/Gain** and measured values from the time domain reflectometry tests. **TDR** first attempts to find the length of the circuit and then searches all ranges from shortest to longest for significant events. Upon completion, the test selects the nearest major event, sets the range to match, and aligns the cursor with the event.

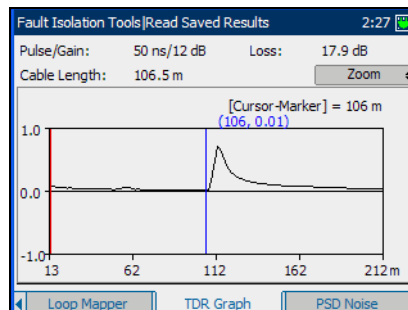

To make TDR adjustments via the keypad:

1. Press **✓** to change the mode button (top-right corner of the pane) and function of the up/down arrow keys.
2. Press **✓** repeatedly to cycle between:
 - **Zoom**
 - **CursorMarker** selection

Auto Tests

Running Inactive Pair Test and Viewing Results

To measure the distance/duration between reflections:

1. Press  to cycle the mode and change to **CursorMarker**.
2. Press the left/right arrow keys to position the blue cursor (indicated by the blue color of data above cursor).
3. Press the up arrow key to select the red marker.
4. Press the left/right arrow keys to position the marker.
5. The difference between the cursor and marker is continuously updated and is indicated with a triangle (delta symbol) above the graph.

To zoom in/out:

1. Press  to select the **Zoom** function. Default mode is **Zoom**.
2. Press the up/down arrow keys to increase/decrease **Zoom** function. The graphical display zooms in or out accordingly.

PSD Noise

The **PSD Noise** tab displays the **RMS Noise** value from the power spectral density (PSD) noise tests in text and graphical form.

The list and buttons on the tab are described below:

- (Zoom function List) allows you to select the desired zoom function: **Horizontal Zoom** or **Vertical Zoom**. The selected function is displayed in the box.
- **Zoom In** allows you to increase the level of zoom for the selected zoom function.
- **Zoom Out** allows you to reduce the level of zoom for the selected zoom function.

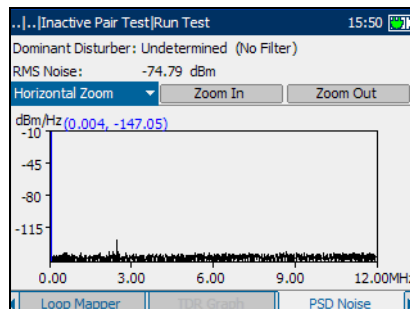

To zoom in or out:

1. Press ✓ to display a list of zoom functions.
2. Press the up/down arrow keys to highlight the desired zoom function.
3. Press ✓ to select the zoom function.
4. Use the left/right arrow keys to highlight the **Zoom In** or **Zoom Out** button as required, then press ✓.

The graphical display zooms in or out accordingly.

5. Press ✓ repeatedly to continue zooming.

To move the screen pointer:

Press the left/right arrow keys to move the screen pointer. The pointer value updates dynamically.

Final/Active Pair Test

The final/active pair test is an auto-test that performs several individual measurements in sequence. It also automatically dials a few special phone numbers in the phone book to set up the line into the various specific termination modes during the test. The test provides a pass/fail summary as well as detailed text/graphical results.

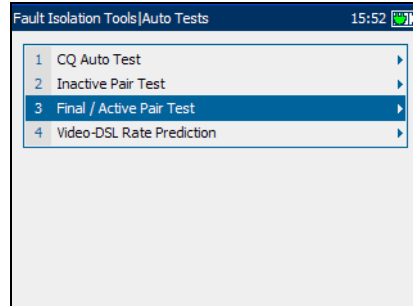

Configuring Final/Active Pair Test

Parameters for auto test configuration are on the **Final/Active Pair Test** pane tabs.

To view the test configuration tabs:

1. From the **Final/Active Pair Test** pane use the up/down arrow keys to highlight **Test Configuration**, and press **✓**.
2. Press the F1, F2, or F3 key to view the various tabs. To view any available additional tabs, use the function arrow keys on either side of the F1 and F3 keys.

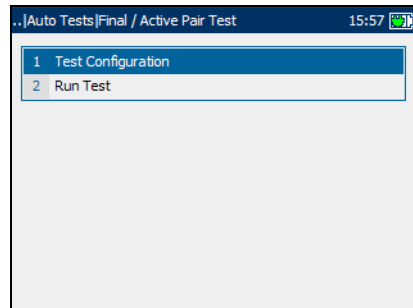

Test Setup

The **Test Setup** allows you to select/adjust the setup parameters for the Final/Active Pair Test as follows:

- **Cable Type** defines the gauge of the cable in use. If wire gauge is measured in American Wire Gauge (AWG) units, the available choices are: **AUTO, 19 AWG, 22 AWG, 24 AWG, or 26 AWG**. For mm gauge wire, the available choices are: **AUTO, 0.32 mm, 0.40 mm, 0.50 mm, 0.60 mm, 0.65 mm, 0.80 mm, 0.90 mm, or 1.20 mm**.
- **Cable Fill** allows you to select the type of material the cable can be filled with. Changing the selection to **AIRCORE, JELLY, PULP, 5 PR, or 2 PR** influences the cable capacitance per length, automatically updating the **Cap. T/R-GND** field.
- **Metallic Insulation Test Time(sec)** specifies the duration of the isolation test: **1 to 15**. The default is **3** seconds. A maximum of only 15 seconds is permitted for each connection so that all the measurements will be completed before the silent switchman times out and re-applies the battery to the line.
- **Input Impedance** displays the input impedance in the loop. The available choices are: **> 1 MOhm, 100 KOhm**.

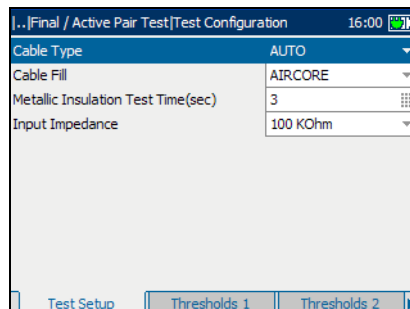

Auto Tests

Configuring Final/Active Pair Test

To set parameter values:

1. Press the up/down arrow keys to highlight the desired parameter.
2. Press ✓ to display the list or select the value.
3. Press the up/down arrow key to highlight the desired value.

OR

4. Press the left arrow key to erase the existing value, and then use the alphanumeric keypad to enter a value. To cancel the entry, press ↩.
5. Press ✓ to accept the value.

Thresholds 1

The **Thresholds 1** tab displays the threshold parameters for the Final/Active Pair Test. They are part of the CQ profile and cannot be edited on this pane.

The parameters are described below:

- **Max. On Hook AC/DC Voltage** are the maximum AC/DC threshold voltage values for the circuit.
- **Min. Loop Current (mA)** is the minimum loop current for the circuit in mA.
- **Max. Ground Resistance (Ohm)** is the maximum ground resistance in Ohm.

Parameter	Value
Max. On Hook AC Voltage T-R (V)	1
Max. On Hook AC Voltage to GND (V)	25
Max. On Hook DC Voltage T-R (V)	53
Min. On Hook DC Voltage T-R (V)	48
Max. On Hook DC Voltage T-G (V)	2
Max. On Hook DC Voltage R-G (V)	53
Min. On Hook DC Voltage R-G (V)	48
Min. Loop Current (mA)	23
Max. Ground Resistance (Ohm)	25

Note: *The Ground Resistance function only works with central offices with the tip connected to ground.*

Thresholds 2

The **Thresholds 2** tab displays the threshold parameters for the Inactive Pair Test. They are part of the CQ profile and cannot be edited on this pane.

- **Max. Loop Loss (dB)** is the maximum threshold loop loss in dB.
- **Max. Power Influence (dBrnC)** is the maximum threshold power influence level on the circuit.
- **Max. Noise Metallic (dBrnC)** is the maximum threshold noise energy level on the circuit.
- **Min. Real Balance (dB)** is the minimum difference between **Power Influence** and **Noise Metallic** when the measured **Power Influence** is > 70 dBrnC. If **Power Influence** is < 70 dBrnC, N/A is displayed.
- **Min. Long Balance (dB)** is the minimum voice frequency threshold longitudinal balance level.
- **Min. Metallic Insulation (MOhm)** are the minimum threshold resistance values for the circuit.
- **Max. Opens Variance (%)** is the maximum capacitance balance percentage.

Parameter	Value
Max. Loop Loss (dB)	8,5
Max. Power Influence (dBrnC)	80
Max. Noise Metallic (dBrnC)	20
Min. Real Balance (dB)	60
Min. Long Balance (dB)	60
Min. Metallic Insulation T-R (MOhm)	10
Min. Metallic Insulation T-G (MOhm)	10
Min. Metallic Insulation R-G (MOhm)	10
Max. Opens Variance (%)	1

At the bottom of the window, there are three tabs: 'Test Setup', 'Thresholds 1', and 'Thresholds 2' (which is currently selected).

Auto Tests

Configuring Final/Active Pair Test

Thresholds 3

The **Thresholds 3** tab displays the maximum open AC/DC voltage values for the Inactive Pair Test. They are part of the CQ profile and cannot be edited on this pane.

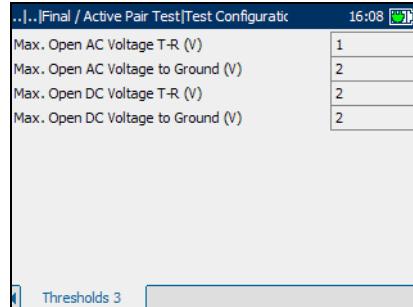

Parameter	Value
Max. Open AC Voltage T-R (V)	1
Max. Open AC Voltage to Ground (V)	2
Max. Open DC Voltage T-R (V)	2
Max. Open DC Voltage to Ground (V)	2

Running Final/Active Pair Test and Viewing Results

Results details are located on the **Final/Active Pair Test** pane tabs.

To run the tests and view results:

1. From the **Final/Active Pair Test** pane use the up/down arrow keys to highlight **Run Test**, and press **✓**.
2. Press the F1, F2, or F3 key to view the various tabs. To view any available additional tabs, use the function arrow keys on either side of the F1 and F3 keys.

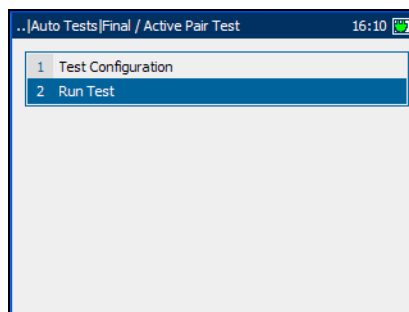

Result Summary

The **Result Summary** tab displays a summary of the measured voltage and current values, and pass/fail status of the Final/Active Pair tests.

- **Dialer Status** displays the current status of the Dialer such as **ON HOOK**, **OFF HOOK**, **DIAL TONE DETECTED**, and **DIALING**.
- **Ground Resistance** displays the measurement result value in Ohm, comparing the customer protector ground resistance to an active central office pair. If an incorrect leads connection is detected, **Check Leads** is displayed.

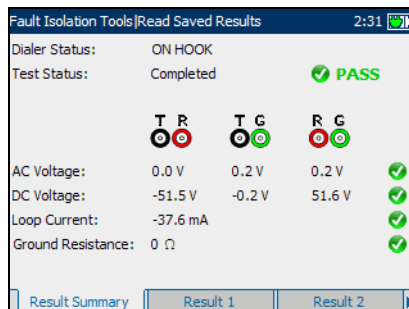

Auto Tests

Running Final/Active Pair Test and Viewing Results

Result 1

The **Result 1** tab allows you to view the results of the measured values and pass/fail status for the Final/Active Pair tests.

Measurement	Value	Status
Loop Loss:	4.0 dB	✓ PASS
Power Influence:	48.3 dBmC	✓ PASS
Noise Metallic:	8.8 dBmC	✓ PASS
Real Balance:	N/A	
Longitudinal Balance:	63.5 dB	✓ PASS

Result 2

The **Result 2** tab displays more results from the Final/Active Pair tests.

- **Met. Insulation** displays the metallic insulation values for the circuit, ranging from **0** to **999** MOhm.
- **Opens Meter** measures the capacitance of the loop in nF, for each lead combination.
- **Opens Length** displays the corresponding capacitance in either meter or feet, depending on the unit selection in **Regional Settings**. If the corresponding capacitance is < 0.2 nF or > 10 μ F, **N/A** is displayed.
- **Opens Variance** is the percentage difference between the capacitance on T-G and R-G.
- **Load Coil** displays **In Progress** while running and the number of load coils detected when the test is completed. If the number is **1** or **2**, **Probable Filter Detected** is displayed. **Splitter Detected** is displayed if present.

	T R	T G	R G	Status
Met. Insulation:	344 MΩ	257 MΩ	15.8 MΩ	✓
Opens Meter:	360 nF	432 nF	431 nF	
Opens Length:	6985 m	5572 m	5553 m	
Opens Variance:	0.0 %			✓
Load Coil:	Splitter Detected			Details...
Open AC Volts:	0.0 V	0.2 V	0.2 V	✓
Open DC Volts:	0.0 V	0.0 V	0.0 V	✓

Press the **Details** button to switch to the **Load Coil** tab.

- **Open AC/DC Volts** displays the measured values on tip, ring, and ground, and the pass/fail status of each Final/Active Pair test.

Load Coil

The **Load Coil** tab displays the number of load coils detected in the line.

- If only 1 or 2, **Probable Filter Detected** is displayed.
- **Splitter Detected** is displayed if present.

Measured values from the load coil detection test are shown in graphical form.

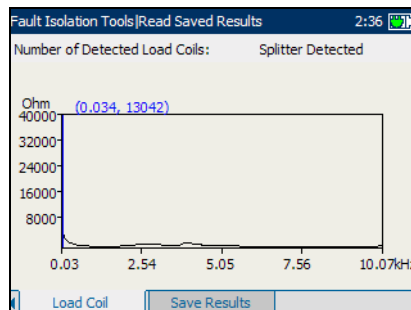

To move the screen pointer:

Press the left/right arrow keys to move the screen pointer. The pointer value updates dynamically.

Auto Tests

Video-DSL Rate Prediction

Video-DSL Rate Prediction

The video-DSL rate prediction test provides an innovative way to understand the otherwise complicated output of electrical and attenuation measurements, and noise tests as they relate to the capacity to transport IPTV video over ADSL2+ circuits. This test performs a series of loop-quality measurements before predicting the ADSL2+ data rate and Video-DSL rate.

Based on current loop conditions and user-defined technology, the video-DSL rate prediction test shows you how many streams of standard broadcast (SB) and high definition (HD) IPTV video streams the tested circuit could reliably carry.

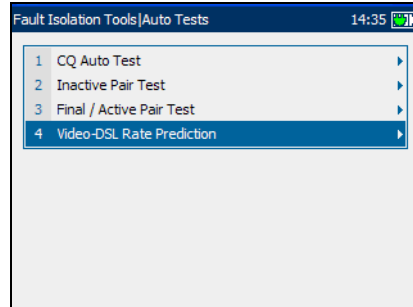

Configuring Video-DSL Rate Prediction

Parameters for auto test configuration are on the **Video-DSL Rate Prediction** pane tabs.

To view the test configuration tabs:

1. From the **Video-DSL Rate Prediction** pane use the up/down arrow keys to highlight **Test Configuration**, and press **✓**.
2. Press the F1, F2, or F3 key to view the various tabs. To view any available additional tabs, use the function arrow keys on either side of the F1 and F3 keys.

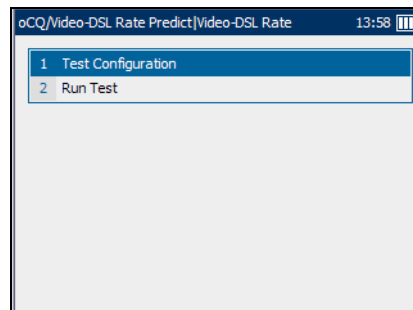

Configuration

The **Configuration** tab allows you to define the desired number of streams and allocated bit rate per stream before running the test.

Each parameter is described below:

- **No Of Streams** is the number of **High Def.** (definition) streams, ranging from 0 to 4 and **Std.** (standard) **Def.** streams ranging from 0 to 10.
- **Stream Rate (Mbps)** is the **High Def.** (HD) and **Std. Def.** (SD) stream rate before running the test, ranging from 0 to 24 Mbps. Default values are 8 Mbps for HD and 1 Mbps for SD.
- **Non-Video Data Rate (Mbps)** is a data rate of non-video data typically used by high-speed internet and VoIP services. Rates range from 0 to 24 Mbps. Default value is 1 Mbps.
- **Annex** defines the modes of available ADSL Annexes from the ITU standards.
 - **A** is ADSL service functioning over POTS.
 - **B** activates the ADSL functionality over ISDN.
 - **L Mask 1** assumes an increase in ADSL2 range/distance.
 - **L Mask 2** also extends the signal reach but can show an improvement in the upstream data rate.
 - **M** allows increased upload speeds from 1 Mbps to 3.5 Mbps. Available only for ADSL2 and ADSL2+.

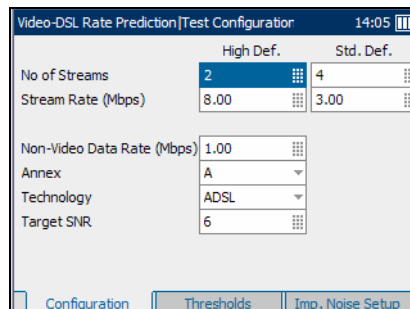

Auto Tests

Configuring Video-DSL Rate Prediction

- **Technology** lists the following values: **ADSL2+**, **ADSL2**, or **ADSL**. If **Annex L** is previously selected, **ADSL2** is automatically set. If **Annex M**, **ADSL** is not available.
- **Target SNR** is the desired signal-to-noise ratio ranging from 0 to 31 dB. Default value is 6 dB.

To set parameter values:

1. Press the up/down or left/right arrow keys to highlight the desired parameter.
2. Press ✓ to display the list or select the value.
3. Press the up/down arrow keys to highlight the desired value.
OR
4. Press the left arrow key to erase the existing value, and then use the alphanumeric keypad to enter a value. To cancel the entry, press ↩.
5. Press ✓ to accept the value.

Thresholds

The **Thresholds** tab allows you to set threshold values for the auto tests.

Each parameter is described below:

- **Max AC Voltage (V)** defines the maximum AC voltage, ranging from 1 to 20. Default value is 6.
- **Max DC Voltage (V)** defines the maximum DC voltage ranging from 1 to 20. Default value is 9.
- **Min Resistance (MOhm)** defines the minimum resistance ranging from 0.5 to 100. Default value is 3.6.
- **Max Cap. Balance (%)** defines the percentage maximum capacitance balance ranging from 0 to 20. Default value is 6.
- **Min Long Balance (dB)** defines the minimum longitudinal balance level ranging from 50 to 70. Default value is 59.

deo-DSL Rate Prediction Test Configuration		14:06
Max AC Voltage (V)	6	
Max DC Voltage (V)	9	
Min Resistance (MOhm)	3.6	
Max Cap. Balance (%)	6	
Min Long Balance (dB)	59	

Configuration Thresholds Imp. Noise Setup

To set a threshold value:

1. Press the up/down arrow keys to highlight the desired parameter.
2. Press **✓** to select the value.
3. Press the left arrow key to erase the existing value, and then use the alphanumeric keypad to enter a value. To cancel the entry, press **↶**.
4. Press **✓** to accept the value.

Impulse Noise Setup

The **Imp. Noise Setup** tab allows you to configure parameters to measure impulse noise on the circuit under test.

Each parameter on the pane is described below.

- **Termination** defines if the unit uses normal test impedance termination or high bridging impedance when the cable is active or terminated by other external equipment. For normal test termination select **TERMINATED**, otherwise select **BRIDGING**.

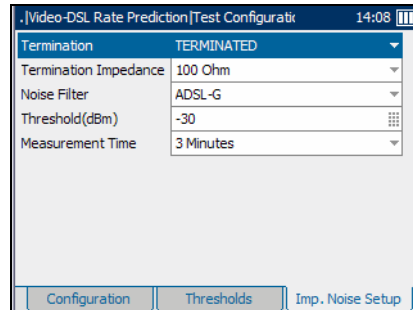

- **Termination Impedance** defines the impedance of the dummy load connected to the line. Select one of the following: **100** or **135 Ohm**.
- **Noise Filter** defines the level of wideband noise filtering. The available choices are: **NONE**, **50 kbit**, **ISDN-E**, **HDSL-F**, **ADSL-G**, **ADSL**, **ADSL2+**, **VDSL**, **VDSL2-8**, **VDSL2-12**, **VDSL2-17**, or **VDSL2-30**.

Note: *VDSL2-x filters are only available if VDSL2WB is enabled in the software options.*

- **Threshold(dBm)** is the maximum impulse noise level. Specify a value between **-50** and **0** (-40 and 0 if any filter applied). Default value is -30.
- **Measurement Time** defines the duration of the Impulse Noise test. The available choices are: **1**, **3**, **5**, **10**, **15**, or **60 Minutes**, or **24 Hours**.

To set parameter values:

1. Press the up/down arrow keys to highlight the desired parameter.
2. Press ✓ to display the list or select the value.
3. Press the up/down arrow keys to highlight the desired value.

OR

4. Press the left arrow key to erase the existing value, and then use the alphanumeric keypad to enter a value. To cancel the entry, press ↵.
5. Press ✓ to accept the value.

Common Parameters

The **Common Param.** tab allows you to set up the **Input Impedance** in the loop. The available choices are:
> 1 MOhm, 100 KOhm.

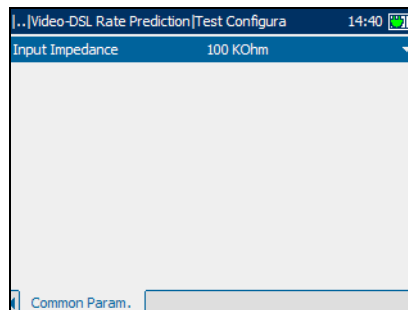

Running Video-DSL Rate Prediction Tests and Viewing Results

Details of the video-data rate prediction results are located on the **Video-DSL Rate Prediction** pane tabs.

To run the tests and view results:

1. From the **Video-DSL Rate Prediction** pane use the up/down arrow keys to highlight **Run Test**, and press **✓**.
2. Once the tests are completed, highlight the **Details** button from the **Test Summary** pane and press **✓** to view the results.
3. Press the F1, F2, or F3 key to view the various tabs. To view any available additional tabs, use the function arrow keys on either side of the F1 and F3 keys.

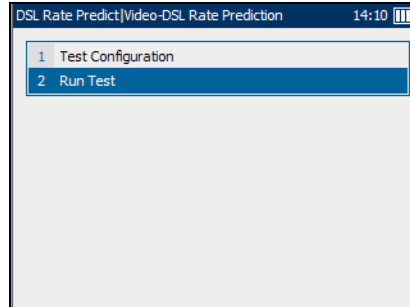

Test Summary

The **Test Summary** tab allows you to view the pass/fail status and **Details** of all tests configured for auto testing.

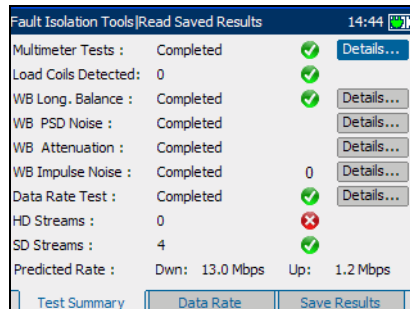

The available test results are the following:

- **Multi-meter Tests** or digital multi-meter tests detect AC/DC voltages, and measure frequency, resistance and capacitance for the copper wire connection.
- **Load Coils Detected** is the number load coils detected in the line.



- **WB Long. Balance** measures the wide band longitudinal balance of the broadband service.
- **WB PSD Noise** measures the wide band power spectral density noise on the line.
- **WB Attenuation** measures the cable length value from wide band attenuation tests.
- **WB Impulse Noise** measures values from the wideband impulse noise tests.
- **Data Rate Test** predicts the maximum bit rate achievable on the local loop based on **Annex**, **Technology**, and **Target SNR** selected.
- **HD Streams** is the number of high definition streams carried on the local loop. Again, the pass indicator is displayed only if the analyzed number of HD streams matches the number set on the **Configuration** tab. Otherwise the status is fail.
- **SD Streams** is the number of standard definition streams carried on the local loop. Here, the pass indicator is displayed only if the analyzed number of SD streams matches the number set on the **Configuration** tab. Otherwise the status is fail.
- **Predicted Rate** displays the downstream and upstream predicted data rates.
- The **Details** button navigates you to the applicable results tab which provides more information about a particular test.

To view more information about each available test result:

1. Press the up/down arrows to highlight the **Details** button alongside the desired test result.
2. Press  to select the desired **Details** button.
3. To return to the **Test Summary** pane, press .

Auto Tests

Running Video-DSL Rate Prediction Tests and Viewing Results

Video Rates

The **Video Rates** tab allows you to view the pass/fail status, details and predicted data rate of the high and standard definition streams carried on the local loop.

Configurable parameters include:

- **No of Streams** is the number of **High Def.** (definition) streams, ranging from 0 to 4 and **Std. Def.** (standard) **Def.** streams ranging from 0 to 10.
- **Stream Rate (Mbps)** is the **High Def.** (HD) and **Std. Def.** (SD) stream rate before running the test, ranging from 0 to 24 Mbps. Default values are 8 Mbps for HD and 1 Mbps for SD.
- **Technology** lists the following values: **ADSL2+**, **ADSL2**, or **ADSL**. If **Annex L** is previously selected, **ADSL2** is automatically set. If **Annex M**, **ADSL** is not available.
- **Annex** defines the modes of available ADSL Annexes from the ITU standards.
 - **A** is ADSL service functioning over POTS.
 - **B** activates the ADSL functionality over ISDN.
 - **L Mask 1** assumes an increase in ADSL2 range/distance.
 - **L Mask 2** also extends the signal reach but can show an improvement in the upstream data rate.
 - **M** allows increased upload speeds from 1 Mbps to 3.5 Mbps. Available only for ADSL2 and ADSL2+.

High Def.		Std. Def.	
No of Streams	2	4	
Stream Rate (Mbps)	8.00	3.00	
Technology	ADSL		
Annex	A		
Target SNR	6		

- **Target SNR** is the desired signal-to-noise ratio ranging from 0 to 31 dB. Default value is 6 dB.
- **Recalculate** button allows you to change the setup and re-evaluate the rates.

To re-set parameters to view different results:

1. Press the up/down or left/right arrow keys to highlight the desired parameter.
2. Press ✓ to display the list or select the value.
3. Press the up/down arrow keys to highlight the desired value.

OR

4. Press the left arrow key to erase the existing value, and then use the alphanumeric keypad to enter a value. To cancel the entry, press ↩.
5. Press ✓ to accept the value.
6. Press the up/down arrow keys to highlight the **Recalculate** button.
7. Press ✓ to recalculate rates for the new setup.

Multi-meter Tests

The multi-meter tests results pane displays the measured values on tip, ring, and ground, and the pass/fail status of each digital multi-meter test.

Copper Qualification Tests Read Saved R				18:59
	T R	T G	R G	
DC Voltage:	0.0 V	0.0 V	0.0 V	✓
AC Voltage:	0.0 V	0.0 V	0.0 V	✓
Frequency:	0 Hz	65 Hz	57 Hz	
Resistance:	653 MΩ	> 999 MΩ	> 999 MΩ	✓
Cap. Balance:	15.15 nF	15.22 nF	15.22 nF	✓
Cap.Length:	1.242 kft	648 ft	648 ft	

Auto Tests

Running Video-DSL Rate Prediction Tests and Viewing Results

WB Longitudinal Balance

The WB Long. Balance pane displays the results of the wideband longitudinal balance test in graphical form.

The buttons on the tab are described below:

- (Zoom function List) allows you to select the desired zoom function: **Horizontal Zoom** or **Vertical Zoom**. The selected function is displayed in the box.
- **Zoom In** allows you to increase the level of zoom for the selected zoom function.
- **Zoom Out** allows you to reduce the level of zoom for the selected zoom function.

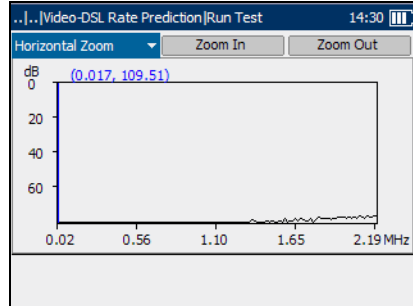

To zoom in/out:

1. Press ✓ to display a list of zoom functions.
2. Press the up/down arrow key to highlight the desired zoom function.
3. Press ✓ to select the zoom function.
4. Use the left/right arrow key to highlight the **Zoom In** or **Zoom Out** button as required, then press ✓.
5. The graphical display zooms in or out accordingly. Press ✓ repeatedly to continue zooming.

To move the screen pointer:

Press the left/right arrow key to move the screen pointer. The pointer value updates dynamically.

WB PSD Noise

The WB PSD Noise pane displays the **RMS Noise** value from the power spectral density (PSD) noise tests in text and graphical form. RMS noise voltage measures the signal-to-noise ratio of the circuit.

The list and buttons on the tab are described below:

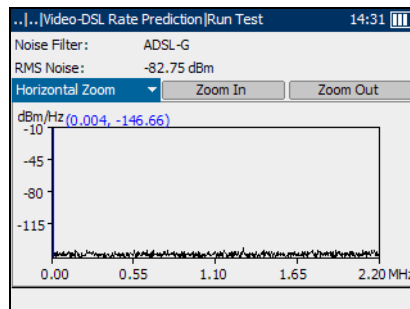

- (Zoom function List) allows you to select the desired zoom function: **Horizontal Zoom** or **Vertical Zoom**. The selected function is displayed in the box.
- **Zoom In** allows you to increase the level of zoom for the selected zoom function.
- **Zoom Out** allows you to reduce the level of zoom for the selected zoom function.

To zoom in or out:

1. Press ✓ to display a list of zoom functions.
2. Press the up/down arrow keys to highlight the desired zoom function.
3. Press ✓ to select the zoom function.
4. Use the left/right arrow keys to highlight the **Zoom In** or **Zoom Out** button as required, then press ✓.

The graphical display zooms in or out accordingly.

5. Press ✓ repeatedly to continue zooming.

To move the screen pointer:

Press the left/right arrow keys to move the screen pointer. The pointer value updates dynamically.

Auto Tests

Running Video-DSL Rate Prediction Tests and Viewing Results

WB Attenuation

The WB Attenuation pane displays the wideband attenuation test results in graphical form.

The list and buttons on the tab are described below:

- (Zoom function List) allows you to select the desired zoom function: **Horizontal Zoom** or **Vertical Zoom**. The selected function is displayed in the box.
- **Zoom In** allows you to increase the level of zoom for the selected zoom function.
- **Zoom Out** allows you to reduce the level of zoom for the selected zoom function.

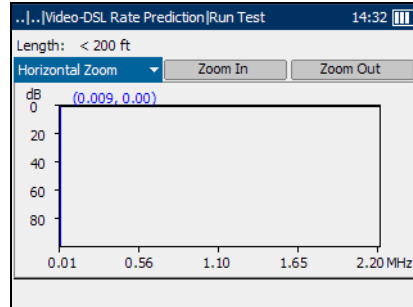

To zoom in/out:

1. Press ✓ to display a list of zoom functions.
2. Press the up/down arrow key to highlight the desired zoom function.
3. Press ✓ to select the zoom function.
4. Use the left/right arrow key to highlight the **Zoom In** or **Zoom Out** button as required, then press ✓.
5. The graphical display zooms in or out accordingly. Press ✓ repeatedly to continue zooming.

To move the screen pointer:

Press the left/right arrow key to move the screen pointer. The pointer value updates dynamically.

WB Impulse Noise

The WB Impulse Noise pane displays the measured values from the wideband impulse noise tests.

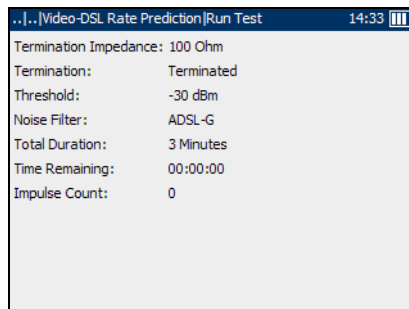

DSL Rate Tests

The **DSL Rate** tab allows you to view the down/up stream **Predicted Rate** based on measurements of PSD noise and attenuation.

Configurable parameters include:

- **Annex** lists the modes of available ADSL Annexes from the ITU standards.
 - **A** is ADSL service functioning over POTS.
 - **B** activates the ADSL functionality over ISDN.
 - **L Mask 1** assumes an increase in ADSL2 range/distance.
 - **L Mask 2** also extends the signal reach but can show an improvement in the upstream data rate.
 - **M** allows increased upload speeds from 1 Mbps to 3.5 Mbps. Available only for ADSL2 and ADSL2+.
- **Target SNR** is the desired signal-to-noise ratio ranging from 0 to 31 dB. Default value is 6 dB.

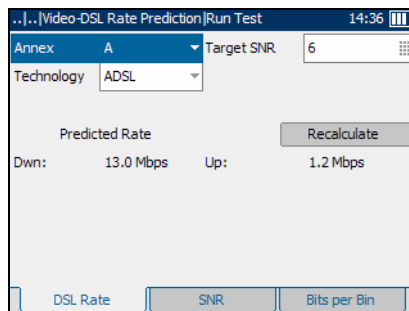

Auto Tests

Running Video-DSL Rate Prediction Tests and Viewing Results

- **Technology** lists the following values: **ADSL2+**, **ADSL2**, or **ADSL**. If **Annex L** is previously selected, **ADSL2** is automatically set. If **Annex M**, **ADSL** is not available.
- **Recalculate** button allows you to change the setup and re-evaluate the rates.

To re-set parameters to view different results:

1. Press the up/down or left/right arrow keys to highlight the desired parameter.
2. Press ✓ to display the list or select the value.
3. Press the up/down arrow keys to highlight the desired value.
OR
4. Press the left arrow key to erase the existing value, and then use the alphanumeric keypad to enter a value. To cancel the entry, press ↩.
5. Press ✓ to accept the value.
6. Press the up/down arrow keys to highlight the **Recalculate** button.
7. Press ✓ to recalculate rates for the new setup.

Signal-to-Noise Ratio

The **SNR** tab displays the signal-to-noise ratio per tone in graphical form.

The list and buttons on the tab are described below:

- (Zoom function List) allows you to select the desired zoom function: **Horizontal Zoom** or **Vertical Zoom**. The selected function is displayed in the box.

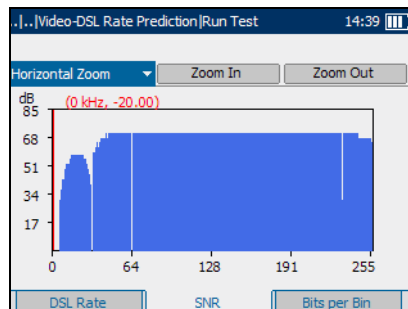

- **Zoom In** allows you to increase the level of zoom for the selected zoom function.
- **Zoom Out** allows you to reduce the level of zoom for the selected zoom function.

To zoom in or out:

1. Press **✓** to display a list of zoom functions.
2. Press the up/down arrow keys to highlight the desired zoom function.
3. Press **✓** to select the zoom function.
4. Use the left/right arrow keys to highlight the **Zoom In** or **Zoom Out** button as required, then press **✓**.

The graphical display zooms in or out accordingly.

5. Press **✓** repeatedly to continue zooming.

To move the screen pointer:

Press the left/right arrow keys to move the screen pointer. The pointer value updates dynamically.

Auto Tests

Running Video-DSL Rate Prediction Tests and Viewing Results

Bits per Bin

The **Bits per Bin** tab displays in graphical form the number of bits that can be transmitted on a particular bin representing a certain tone.

- **Zoom In** allows you to increase the level of zoom for the selected zoom function.
- **Zoom Out** allows you to reduce the level of zoom for the selected zoom function.

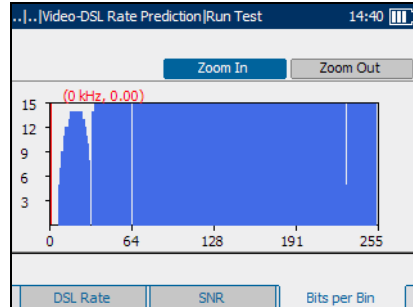

To zoom in or out:

1. Press the up or down arrow key to highlight the desired zoom function.
2. Press **✓** to select the zoom function.
3. Use the left or right arrow key to highlight the **Zoom In** or **Zoom Out** button as required, then press **✓**.

The graphical display zooms in or out accordingly.

4. Press **✓** repeatedly to continue zooming.

To move the screen pointer:

Press the left/right arrow keys to move the screen pointer. The pointer value updates dynamically.

4 POTS Auto Test

The purpose of the POTS Auto Test function is to detect the Loop Current and measure the voice frequency in a copper telephone loop. This test allows you to compare measured results against stored threshold values to provide pass or fail status results of the POTS circuit type.

To access POTS Auto Test:

1. From the **Home** pane use the up/down arrow keys to highlight **Fault Isolation Tools** and press **✓**.
2. Highlight **POTS Auto Test** and press **✓** to start the test.

To view POTS Auto Test tabs:

From the **POTS Auto Test** pane use the F1, F2, or F3 key to view the various tabs.

Thresholds



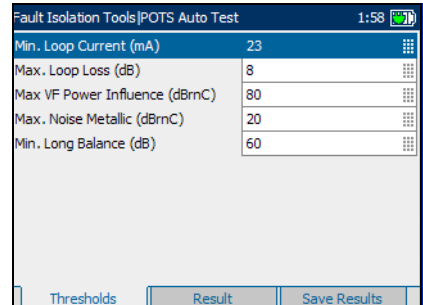

The **Thresholds** tab allows you to set threshold values for the POTS auto test.

Each parameter is described below:

- **Min Loop Current (mA)** is a value ranging from 10 to 100. Default is 23.
- **Max Loss (dB)** is a value ranging from 0 to 50. Default is 8.
- **Max VF Power Influence** is a value ranging from -90 to 10 dBm with a default of -10, if the ITU Standard is used. If ANSI Standard, the range is from 0 to 100 dBm with a default value of 80.
- **Max Noise Metallic** is a value ranging from -90 to 10 dBm with a default of -70, if the ITU Standard is used. If ANSI Standard, the range is from 0 to 100 dBm with a default value of 20.
- **Min Long Balance (dB)** is a value ranging from 0 to 100. Default is 60.



To set a threshold value and start/stop the test:

1. Press the up/down arrow keys to highlight the desired parameter.
2. Press  to select the value.
3. Press the left arrow key to erase the existing value, and then use the alphanumeric keypad to enter a value. To cancel the entry, press .
4. Press  to accept the value.
5. Select other parameters as required.
6. Press  to start/stop the test.

Result

The **Result** tab allows you to view detailed results of the **Loop Current**, voice frequency measurement values and Pass/Fail status of the POTS Auto Test.

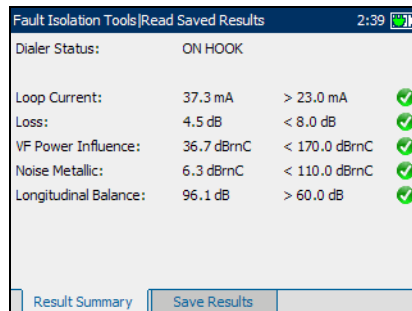

The screenshot shows a software interface titled "Fault Isolation Tools | Read Saved Results" with a timestamp of 2:39. The interface displays a list of test parameters and their results, each with a green checkmark indicating a pass status.

Parameter	Measured Value	Threshold	Status
Dialer Status:	ON HOOK		
Loop Current:	37.3 mA	> 23.0 mA	✓
Loss:	4.5 dB	< 8.0 dB	✓
VF Power Influence:	36.7 dBmC	< 170.0 dBmC	✓
Noise Metallic:	6.3 dBmC	< 110.0 dBmC	✓
Longitudinal Balance:	96.1 dB	> 60.0 dB	✓

At the bottom of the interface, there are two tabs: "Result Summary" (selected) and "Save Results".

5 **Multi-meter Tests**

The purpose of the multi-meter tests function is to detect AC/DC voltages and currents, and measure resistance and capacitance in a loop. These tests allow you to make basic electrical safety checks (AC volts), check from *crossed* or coupled battery voltages, assess basic loop continuity and quality with resistance measurements, and measure total electrical length with capacitance.

To access Multi-meter tests:

1. From the **Home** pane, highlight **Multi-meter** and press ✓ to start the test.
OR
2. From the **Home** pane use the up/down arrow keys to highlight **Fault Isolation Tools** and press ✓.
3. Highlight **Multi-meter Tests** and press ✓ to list the available tests.

The **Multi-meter Tests** menu includes the following tests:

- Multi-meter
- In-service pair, rectified loop, and water detection
- Resistive balance

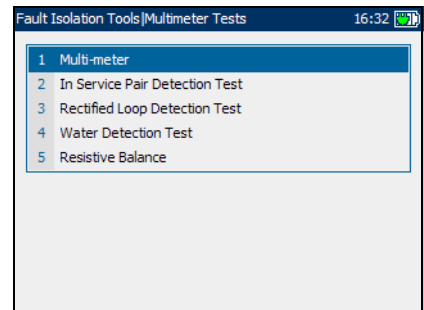

Multi-meter

The Multi-meter function allows you to perform the following tests:

- Voltage
- Ground Resistance
- Resistance (also known as shorts meter)
- Metallic
- Capacitance (also known as opens meter)
- Current

Multi-meter Tests

Multi-meter

- Noise Metallic
- Longitudinal Balance
- Dialer

To view Multi-meter test tabs:

From the **Multi-meter** pane use the F1, F2, or F3 key to view the various tabs. To view any available additional tabs, use the function arrow keys on either side of the F1 and F3 keys.

Voltage

The **Voltage** tab shows measured volts for each lead combination and allows you to measure AC/DC voltages and **Frequency** on tip, ring, and ground (A/B/Earth).

Each parameter is described below.

- **Input Impedance** displays the input impedance in the loop. The available choices are: **>1 MOhm**, **100 KOhm**.
- **Connection** defines the type of cable connection to be tested, as specified in **Regional Settings**.

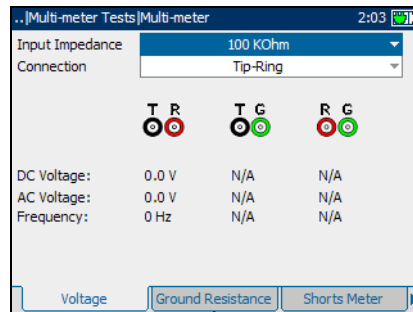

To start/stop the test:

1. Press the up/down arrow keys to highlight the desired test parameter.
2. Press ✓ to open the list.
3. Press the up/down arrow keys to highlight the desired value, then press ✓ to select it.
4. Select other parameters as required.
5. Press ⏻ to start/stop the test.

Test results are displayed on the screen as they are completed.

Ground Resistance

- The **Ground Resistance** measurement compares the customer protector ground resistance to an active central office pair. If an incorrect leads connection is detected during the measurement, **Please check wire connections** is displayed.

Note: *The Ground Resistance function only works with central offices with the tip connected to ground.*

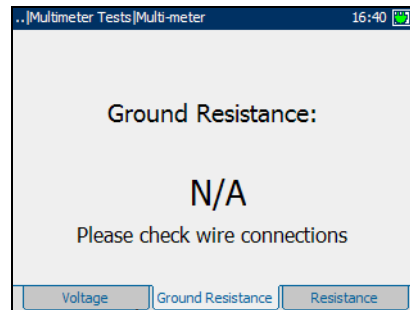

Resistance

The **Resistance** tab allows you to measure the current resistance value and cable length for the cable connection.

Note: *If the ANSI standard is used, the tab name **Resistance** changes to **Shorts Meter**.*

Each parameter is described below.

- **Cable Type** defines the gauge of the cable in use. Select the wire gauge measured as **Auto**, in AWG units, or in mm.

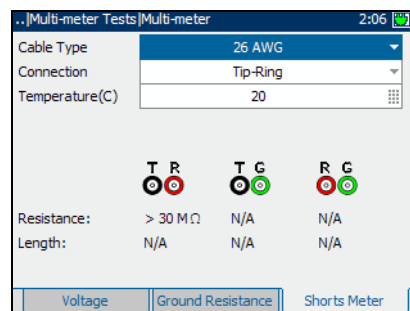
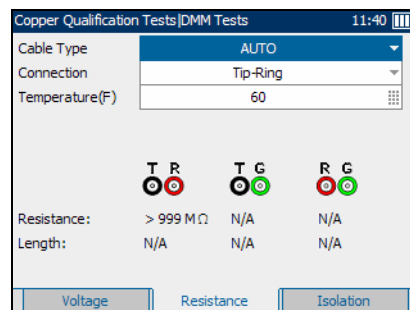

Multi-meter Tests

Multi-meter

- **Connection** defines the type of cable connection to be tested, as specified in **Regional Settings**.
- **Temperature (F/C)** is the temperature of the cable.

To start/stop the test:

1. Press the up/down arrow keys to highlight the desired test parameter.
2. Press ✓ to open the list or specify a value.
3. Press the up/down arrow keys to highlight the desired value.
OR
4. Press the left/right arrow keys to erase the existing value, and then use the alphanumeric keypad to enter a value. To cancel the entry, press ↩.
5. Press ✓ to accept the value.
6. Select other parameters as required.
7. Press ↻ to start/stop the test.



Test results are displayed on the screen as they are completed.

Metallic Insulation

The **Metallic Insulation** tab allows you to run a resistance test over a period of time to look for high-resistive faults. This method may also reveal poor wire.

Connection defines the type of cable connection to be tested, as specified in **Regional Settings**.

To start/stop the test:

1. Press the up/down arrow keys to highlight the desired test parameter.
2. Press  to open the list.
3. Press the up/down arrow keys to highlight the desired value, then press  to select it.
4. Press  to start/stop the test.

Test results are displayed on the screen as they are completed.

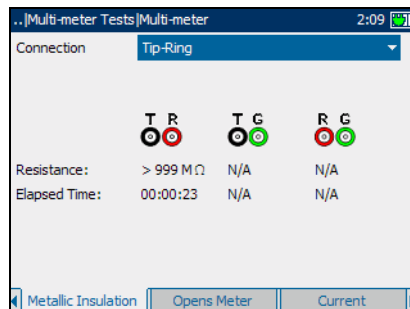

Multi-meter Tests

Multi-meter

Capacitance

The **Capacitance** tab allows you to measure the capacitance of the loop and capacitance length.

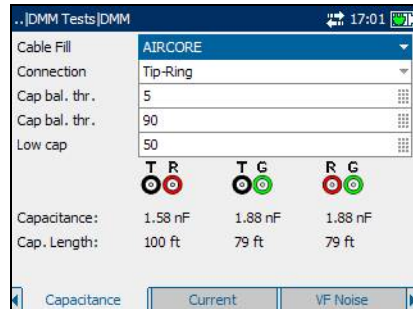

Note: If the ANSI standard is used, the tab name **Capacitance** changes to **Opens Meter**.

- **Cable Fill** allows you to select the type of material the cable can be filled with.
- **Connection** defines the type of connection to be tested.
- **Cap balance threshold (nF)** is the capacitance balance threshold ranging from 0.1 to 20 nF. If the measured capacitive balance in nF is greater than this threshold, **FAIL** is displayed. Otherwise, **PASS** is displayed.
- **Cap balance threshold (%)** is the capacitance balance threshold ranging from 50 to 100 %. If the measured capacitance balance in percentage is greater than this threshold, **PASS** is displayed. Otherwise, **FAIL** is displayed.
- **Low cap value (nF)** defines which of the above thresholds will be used to determine pass or fail. The range is 0.1 to 500 nF. If the loop capacitance is less than the **Low cap value**, the threshold in **Cap balance threshold (nF)** will be used. Otherwise, the threshold in **Cap balance threshold (%)** is used.

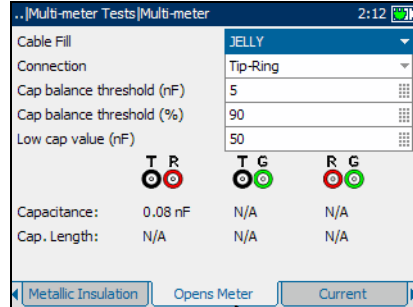

To start/stop the test:

1. Press the up/down arrow keys to highlight the desired test parameter.
2. Press ✓ to open the list.
3. Press the up/down arrow keys to highlight the desired value, then press ✓ to select it.
4. Select other parameters as required.
5. Press ↻ to start/stop the test.

Test results are displayed on the screen as they are completed.

Current

The **Current** tab allows you to measure the AC/Loop currents and frequency in the loop.

To start/stop the test:

Press ↻ to start/stop the test.

Test results are displayed on the screen as they are completed.

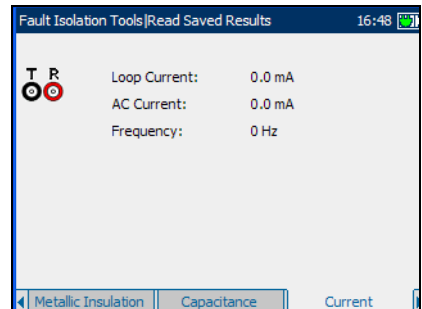

Multi-meter Tests

Multi-meter

Noise Metallic

The **Noise Metallic** test allows you to measure the amount of unwanted or disturbing energy introduced into a loop from man-made and natural sources.

Each parameter is described below.

- **Termination** is either **BRIDGING** if the unit uses high bridging impedance when the cable is active or terminated by other external equipment, or **TERMINATED** if the unit uses normal test impedance termination.
- **Noise Filter** is either **PSOPHOMETRIC** for ITU standard or **C-MESSAGE** for ANSI standard.

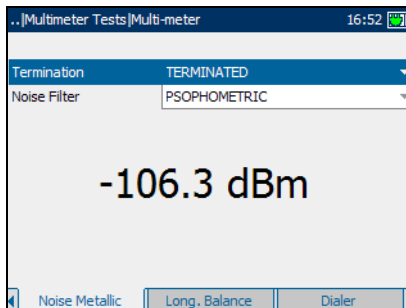

To start/stop the test:

1. Press the up/down arrow keys to highlight the desired test parameter.
2. Press ✓ to open the list.
3. Press the up/down arrow keys to highlight the desired value, then press ✓ to select it.
4. Select other parameters as required.
5. Press ↻ to start/stop the test.

Test results are displayed on the screen as they are completed.

Longitudinal Balance

The **Long. Balance** test allows you to check that the longitudinal balance ratio for the twisted pair complies with applicable standards so as to reduce the effects of common-mode voltage to ground. The better the longitudinal balance of the cable pair, the higher the dB reading.

To start/stop the test:

Press  to start/stop the test.

Test results are displayed on the screen as they are completed.

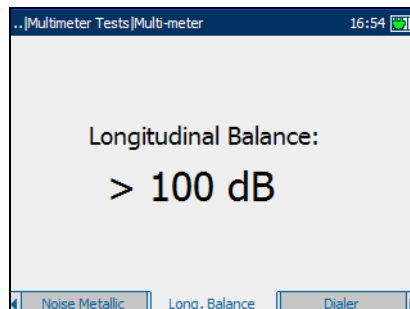

Multi-meter Tests

In Service Pair Detection Test

In Service Pair Detection Test

At the start of the In Service Pair Detection test, the unit will check for the presence of dangerous voltage and an active circuit. If dangerous voltage is detected, a dialog box will be displayed to inform you and the test will stop. If an active circuit is detected, a dialog box will be displayed to ask you whether or not to proceed with the test.

In Service

The **In Service Pair Detection Test** uses the black and green (ground) leads to quickly check if wire pairs are **in service** or available for usage. This test checks for the following:

- dangerous voltages
- high voltages
- POTS battery (>30 V)
- digital service signals
- a bad ground connection

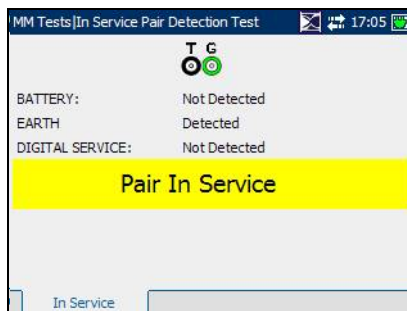

Note: *Test beeps or warns at the end of a test ‘cycle’ and to indicate you can move to another pair. The unit beeps faster, displaying a dialog box, when something (battery, earth or digital service) is detected.*

Rectified Loop (Corrosion) Detection Test

The **Rect. L Detection** tab displays a rectified loop state which often indicates the presence of corrosion on a circuit. Rectified loops can disrupt balance and make the circuit unsuitable for Broadband and other digital services.

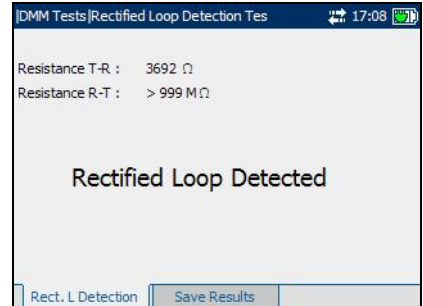

Water Detection Test

The **Water Detection Test** detects the presence of water in the circuit. Use the TDR to locate.

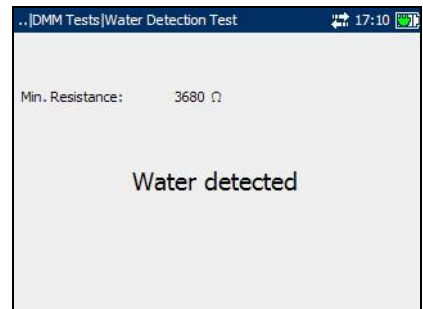

Resistive Balance

At the start of the Resistive Balance test, the unit will check for the presence of dangerous voltage and an active circuit. If dangerous voltage is detected, a dialog box will be displayed to inform you and the test will stop. If an active circuit is detected, a dialog box will be displayed to ask you whether or not to proceed with the test.

Test Setup

The Test Setup tab allows you to configure parameters for the resistive balance test.

Each parameter is described below:

- **Res. Bal. Thr. (ohm)** is the resistive balance threshold ranging from 0.1 to 20 ohm. If the measured resistive balance in ohms is greater than this threshold, the fail icon is displayed. Otherwise, the pass icon is displayed.
- **Res. Bal. Thr. (%)** is the resistive balance threshold ranging from 50 to 100 %. If the measured resistive balance in percentage is greater than this threshold, the pass icon is displayed. Otherwise, the fail icon is displayed.
- **Low Resistance Value** defines which of the above thresholds will be used to determine pass or fail. The range is 0.1 to 999.9 ohm. If the loop resistance is less than the **Low Resistance Value**, the threshold in **Res. Bal. Thr. (ohm)** will be used. Otherwise, the threshold in **Res. Bal. Thr. (%)** is used.

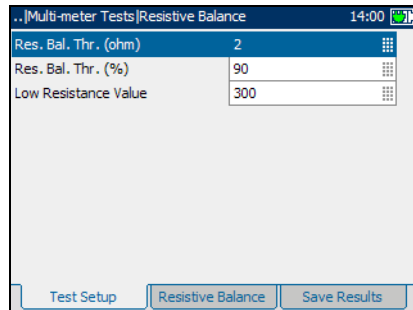

To set parameter values and start/stop the test:

1. Press the up/down arrow keys to highlight the desired parameter.
2. Press ✓ to select the value.
3. Press the left arrow key to erase the existing value, and then use the alphanumeric keypad to enter a value. To cancel the entry, press ↩.
4. Press ✓ to accept the value.
5. Select other parameters as required.
6. Press ↻ to start/stop the test.

Resistive Balance

The **Resistive Balance** test measures and compares the resistance of each leg. This test requires the T/R/G connections to be shorted together at the far end of the line under test.

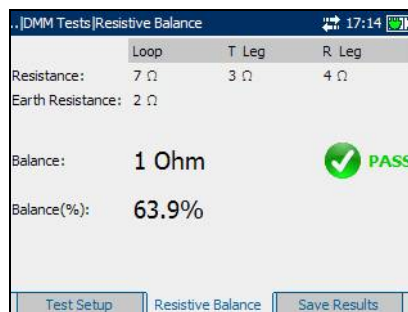

6 VF Tests

The purpose of the voice frequency (VF) tests is to perform VF band noise and level measurements, and count load coils. The AXS-200/635i uses the following types of VF tests:

- Receive tone (RX)
- Send tone (TX)
- Tracing tone
- Noise Metallic
- Impulse noise
- Power influence
- Longitudinal balance
- Load coil detection

To access VF Tests:

1. From the **Home** pane use the up/down arrow keys to highlight **Fault Isolation Tools** and press ✓.
2. Highlight **VF Tests** and press ✓ to start the test.

To view VF test panes or tabs:

1. From the **VF Tests** pane use the up or down arrow key to highlight the desired test, then press ✓.
2. Press the F1, F2, or F3 key to view available tabs. To view any available additional tabs, use the function arrow keys on either side of the F1 and F3 keys.

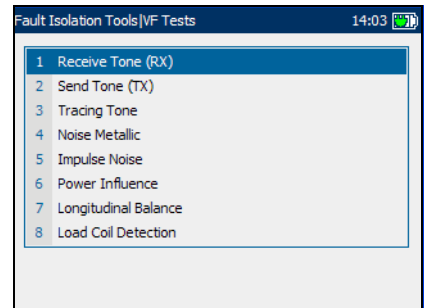

Receive Tone (RX)

The **Receive Tone (RX)** tab allows you to configure and run a receive tone test, which measures the frequency and level of incoming signals.

Select the type of **Termination**, either **BRIDGING** if the unit uses high bridging impedance when the cable is active or terminated by other external equipment, or **TERMINATED** if the unit uses normal test impedance termination.

To start/stop the test:

1. Press ✓ to open the list.
2. Press the up/down arrow keys to highlight the desired value, then press ✓ to select it.
3. Press ↻ to start/stop the test.

Test results are displayed on the screen as they are completed.

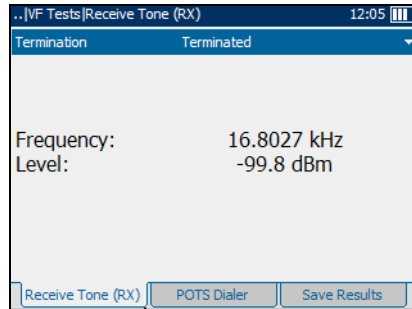

Send Tone (TX)

The VF **Send Tone (TX)** pane allows you to configure and transmit a tone to a downstream device in the loop.

Each parameter and button on the pane is described below.

- **Frequency (Hz)** is the frequency of the transmitting tone. Specify a value between **200** and **20000**. Default value is 1004 Hz.
- **Level (dBm)** is the tone level. Specify a value between **-20** and **10**.
- **Apply** is used to confirm any changes to parameter values which can be changed while the test is running.

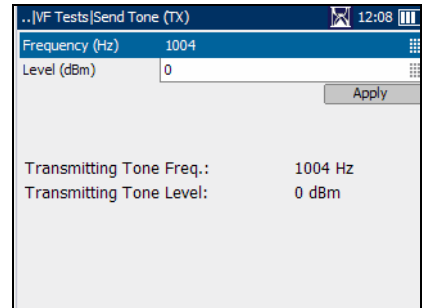

To start/stop the test:

1. Press the up/down arrow keys to highlight the desired test parameter.
2. Press ✓ to specify a value.
3. Press the left/right arrow keys to erase the existing value, and then use the alphanumeric keypad to enter a value. To cancel the entry, press ↵.
4. Press ✓ to accept the value.
5. Select other parameters as required.
6. Press ↻ to start/stop the test.

Test results are displayed on the screen as they are completed.

Tracing Tone

The **Tracing Tone** pane allows you to configure and place a pulsed tone on the line to trace a cable pair at the far end. When **Tracing Tone** is selected from the **VF Tests** menu, the tracer tone sends a 577 Hz signal for the first 80 ms, then the signal is turned off for 80 ms, turned on for another 80 ms, and off again for another 320 ms. The sequence of this tone is repeated continuously until you stop the test. Sinusoidal waveform is used to generate the 577 Hz signal.

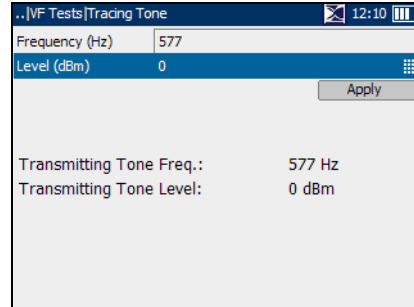

Each parameter and button on the pane is described below.

- **Frequency (Hz)** value is set to 577 Hz.
- **Level (dBm)** is the tone level. Specify a value between **-20** and **10**.
- **Apply** is used to confirm any changes to the parameter value.

To start/stop the test:

1. Press ✓ to specify a value.
2. Press the left/right arrow keys to erase the existing value, and then use the alphanumeric keypad to enter a value. To cancel the entry, press ↵.
3. Press ✓ to accept the value.
4. Press ↻ to start/stop the test.

Test results are displayed on the screen as they are completed.

Noise Metallic



The **Noise Metallic** pane allows you to configure and run a Noise Metallic test. It measures the amount of unwanted or disturbing energy introduced into a loop from man-made and natural sources.

Each parameter is described below.

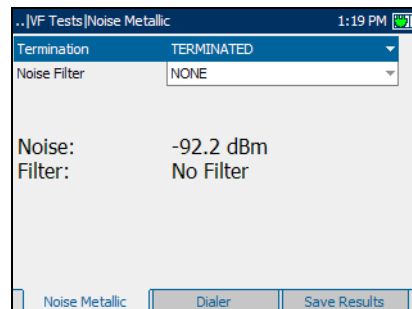
- **Termination** defines if the unit uses normal test impedance termination or high bridging impedance when the cable is active or terminated by other external equipment. For normal test termination select **TERMINATED**, otherwise select **BRIDGING**.
- **Noise Filter** defines the type of noise filtering to use. If ANSI standard is used, the available choices are: **NONE**, **C-MESSAGE**, **C-NOTCHED**, **3 kHz Flat**, **D-FILTER** or **15 kHz**. For the ITU standard, the choices are: **NONE**, **PSOPHOMETRIC**, **P-NOTCHED**, **3 kHz Flat**, **D-FILTER** or **15 kHz**.



To start/stop the test:

1. Press the up/down arrow keys to highlight the desired test parameter.
2. Press  to open the list.
3. Press the up/down arrow keys to highlight the desired value, then press  to select it.
4. Select other parameters as required.
5. Press  to start/stop the test.

Test results are displayed on the screen as they are completed.

Impulse Noise

Test Setup

The **Test Setup** tab allows you to configure parameters for the impulse noise test.

Each parameter on the pane is described below.

- **Termination** defines if the unit uses normal test impedance termination or high bridging impedance when the cable is active or terminated by other external equipment. For normal test termination select **TERMINATED**, otherwise select **BRIDGING**.
- **Noise Filter** defines the type of noise filtering in use. If ANSI standard is used, the available choices are: **NONE**, **C-MESSAGE**, **C NOTCHED**, or **D-FILTER**. For the ITU standard, the choices are: **NONE**, **PSOPHOMETRIC**, **P-NOTCHED**, or **D-FILTER**
- **Low Threshold (dBm)** defines the low threshold limits for the impulse noise test. Specify a value between **-40** and **0**.
- **Separation (dB)** defines the level difference between the low, mid and high thresholds. Specify a value between **1** and **6** dB.
- **Imp. Noise Measure. Time** defines the duration of the impulse noise test. The available choices are: **1, 5, 10, 15, 60 Minutes**, or **24 Hours**.

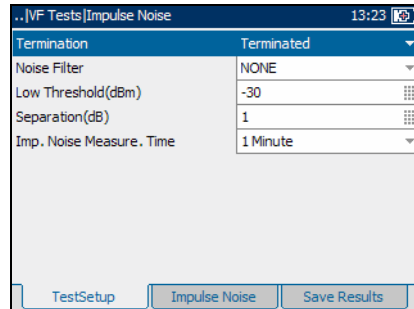

To set parameter values and start/stop the test:

1. Press the up/down arrow keys to highlight the desired parameter.
2. Press ✓ to display the list or specify the value.
3. Press the up/down arrow keys to highlight the desired value.

OR

4. Press the left arrow key to erase the existing value, and then use the alphanumeric keypad to enter a value. To cancel the entry, press ↩.
5. Press ✓ to accept the value.
6. Select other parameters as required.
7. Press ↻ to start/stop the test.

VF Tests

Power Influence

Impulse Noise

The **Impulse Noise** tab allows you to view results of the VF impulse noise test.

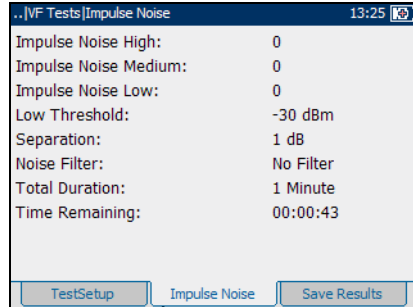

Power Influence

The **Power Influence** tab allows you to view the effects of interference from a 50 Hz or 60 Hz power line (AC mains) on the circuit under test. The results of the power influence test are in graphical form.

To move the screen pointer:

Press the left/right arrow keys to move the screen pointer. The pointer value updates dynamically.

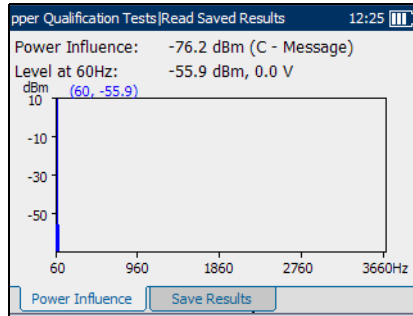

Longitudinal Balance

The **Long. Balance** test allows you to check that the VF longitudinal balance ratio for the twisted pair complies with applicable standards so as to reduce the effects of common-mode voltage to ground. The better the longitudinal balance of the cable pair, the higher the dB reading.

To start/stop the test:

Press  to start/stop the test.

Test results are displayed on the screen as they are completed.

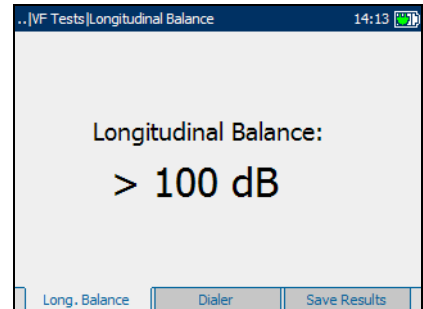

Load Coil Detection

The **Load Coil** detection test allows you to detect the presence of load coils, which are detrimental to the use of DSL technologies on the line. If a load coil is detected, use the time domain reflectometry (TDR) test to quickly locate and remove it from the cable. Test results are displayed in graphical form.

To move the screen pointer:

Press the left/right arrow key to move the screen pointer. The pointer value updates dynamically.

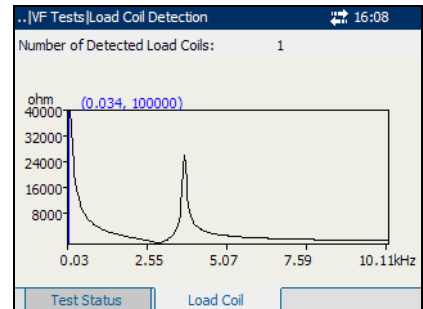

7 **Fault Location**

Fault Location is used to locate faults in the loop. The AXS-200/635i uses the following types of fault location tests:

- TDR
- RFL Single Pair (2 wire)
- RFL Separate Good Pair (4 wire)
- Loop Mapper

To access Fault Location tests:

1. From the **Home** pane, highlight **Fault Location** and press ✓ to list the available tests.

OR

2. From the **Home** pane use the up/down arrow keys to highlight **Fault Isolation Tools** and press ✓.

3. Highlight **Fault Location** and press ✓ to list the available tests.

To run and view fault location test panes or tabs:

1. From the **Fault Location** pane use the up or down arrow keys to highlight the desired test, then press ✓.

2. Press the F1, F2, or F3 key to view available tabs. To view any available additional tabs, use the function arrow keys on either side of the F1 and F3 keys.

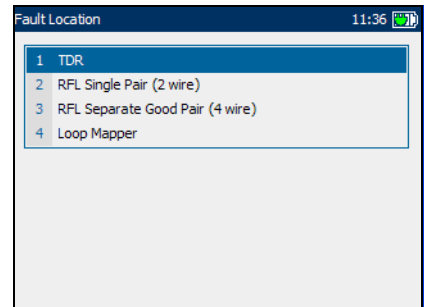

Fault Location

TDR Test

TDR Test

The TDR (time domain reflectometry) test allows you to easily locate bridge taps (multiple appearances), the end of the cable, open ends, shorted ends, splices, split pairs, and wet sections in a cable. It also allows you to estimate cable lengths.

A TDR test transmits a fast pulse along the cable, then measures the resulting reflected pulse as a function of time, and displays the results as a function of the cable length or time.

Test Setup

The **Test Setup** tab allows you to configure parameters for the TDR test. **VOP** sets the velocity of propagation for the cable as a ratio of the speed of light.

Note: *The default VOP is good for most cables; only change it when you know the correct VOP for the cable you are measuring. An incorrect VOP will cause distance errors.*

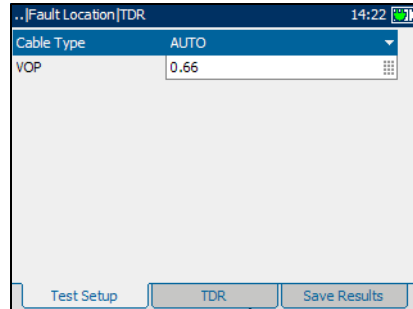

TDR

The **TDR** test first attempts to find the length of the circuit and then searches all ranges from shortest to longest for significant events. Upon completion, the test selects the nearest major event, sets the range to match, and aligns the cursor with the event.

Est is the estimated length of the circuit.

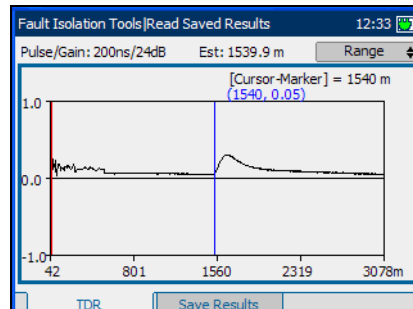

To make TDR adjustments via the keypad:

1. Press ✓ to change the mode and function of the up/down arrow keys.
2. Press ✓ repeatedly to cycle between:
 - Zoom
 - Gain
 - Pulse Gain (Pulse Width & Gain)
 - Range
 - Cursor and Marker Selection

To measure the distance/duration between reflections:

1. Press ✓ to cycle the mode and change to **CursorMarker**.
2. Press the left/right arrow keys to position the blue cursor (indicated by the blue color of data above cursor).
3. Press the up arrow key to select the red marker.
4. Press the left/right arrow keys to position the marker.
5. The difference between the cursor and marker is continuously updated and is indicated with a triangle (delta symbol) above the graph.

To zoom in/out:

1. Press ✓ to select the **Zoom** function. Default mode is **Zoom**.
2. Press the up/down arrow keys to increase/decrease **Zoom** function. The graphical display zooms in or out accordingly.

Fault Location

RFL Single Pair (2 wire) Test

Resistance fault locator (RFL) testing is a powerful means to locate shorts between tip to ring, tip to ground, or ring to ground. The RFL-2 wire test, also known as RFL single pair test, allows you to locate resistive faults between tip to ring, tip or ring to ground, or the adjacent live pair.

Note: Before performing RFL tests install a strap at the other end of the cable.

Test Setup

The **Test Setup** tab allows you to configure parameters for the RFL test.

Each parameter on the pane is described below.

- **Sect.** denotes the section number in the cable. Select to enable or disable that section of the cable.
- **Cable Type** defines the gauge of the cable in use. If wire gauge is measured in AWG units, the available choices are: **AUTO**, **19 AWG**, **22 AWG**, **24 AWG**, or **26 AWG**. For mm gauge wire, the available choices are: **AUTO**, **0.32 mm**, **0.40 mm**, **0.50 mm**, **0.60 mm**, **0.65 mm**, **0.80 mm**, **0.90 mm**, or **1.20 mm**.
- **Ohm/mi** or **Ohm/km** is the resistance constant of the cable per unit length.
- **Len.** is the length of the cable under test. Specify a maximum of four characters.
- **Temp.** is the temperature of the cable under test. Specify a maximum of three characters. Default is 60F or 20C.
- **L.Coil** specifies the presence or absence of load coil in the cable section. Select **YES** or **NO**.

Sect.	Cable Type	Ohm/km	Len.(m)	Temp.(F)	L.Coil
1	AUTO	172.0	0	68	NO
2	AUTO	172.0	0	68	NO
3	AUTO	172.0	0	68	NO
4	AUTO	172.0	0	68	NO
5	AUTO	172.0	0	68	NO

To set parameter values:

- 1.** To configure a section of cable for the test, press the up/down arrow keys to highlight the section icon then press ✓ to enable the section.
To disable a section, highlight the section icon then press ✓.
- 2.** Use the left/right arrow keys to highlight each parameter and press ✓ to open the list or select the value.
- 3.** Press the up/down arrow key to highlight the desired value.

OR

Press the left arrow key to erase the existing value, and then use the alphanumeric keypad to enter a value. To cancel the entry, press ↩.

- 4.** Press ✓ to accept the value.
- 5.** Set other parameters as necessary.
- 6.** Configure other sections of the cable as required.
- 7.** Press ↻ to start/stop the test.

Fault Location

RFL Single Pair (2 wire) Test

Connection Diagram

The **Connection Diagram** tab displays how to connect the cables to the unit.

The green lead is used as reference.

Continue button allows you to resume the test once the cables have been connected.

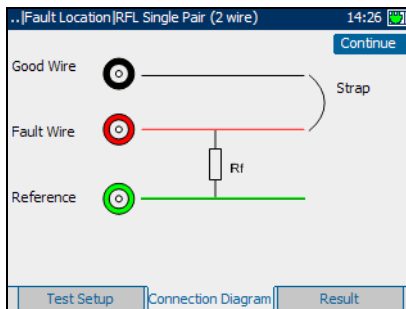

Result

The **Result** tab allows you to view detailed results of the RFL test.

The table displays the test results for an RFL-2 Wires test. It includes the following data:

RFL-2 Wires Test Results		
Distance to fault:	18.174 kft	149.7 Ω
Distance from fault to end:	57.502 kft	473.7 Ω
Distance to end:	75.676 kft	623.5 Ω
Fault located in section:	1	
Resistance at fault:	21.39 M Ω	
Voltage at fault:	0.0 V	

At the bottom, there are three tabs: 'Test Status', 'Connection Diagram', and 'Result' (which is active).

RFL Separate Good Pair (4 wire) Test

The RFL separate good pair test, allows you to determine the distance to a short, ground, or battery cross in a faulty cable pair using a separate good cable pair.

Note: Before performing RFL tests install a strap at the other end of the cable.

Test Setup

The **Test Setup** tab allows you to configure parameters for the RFL test.

Each parameter on the pane is described below.

- **Sect.** denotes the section number in the cable. Select to enable or disable that section of the cable.
- **Cable Type** defines the gauge of the cable in use. If wire gauge is measured in AWG units, the available choices are: **AUTO**, **19 AWG**, **22 AWG**, **24 AWG**, or **26 AWG**. For mm gauge wire, the available choices are: **AUTO**, **0.32 mm**, **0.40 mm**, **0.50 mm**, **0.60 mm**, **0.65 mm**, **0.80 mm**, **0.90 mm**, or **1.20 mm**.
- **Ohm/mi** or **Ohm/km** is the resistance constant of the cable per unit length. Specify maximum of five characters.
- **Len.** is the length of the cable under test. Specify a maximum of four characters.
- **Temp.** is a temperature of the cable under test. Specify a maximum of three characters. Default is 60F or 20C.
- **L.Coil** specifies the presence or absence of load coil in the cable section. The choices are **YES** or **NO**.

Sect.	Cable Type	Ohm/km	Len.(m)	Temp.(F)	L.Coil
1	AUTO	172.0	0	68	NO
2	AUTO	172.0	0	68	NO
3	AUTO	172.0	0	68	NO
4	AUTO	172.0	0	68	NO
5	AUTO	172.0	0	68	NO

Fault Location

RFL Separate Good Pair (4 wire) Test

To set parameter values:

1. To configure a section of cable for the test, press the up/down arrow keys to highlight the section icon then press ✓ to enable the section.
To disable a section, highlight the section icon then press ✓.
2. Use the left/right arrow keys to highlight each parameter and press ✓ to open the list or select the value.
3. Press the up/down arrow key to highlight the desired value.

OR

Press the left arrow key to erase the existing value, and then use the alphanumeric keypad to enter a value. To cancel the entry, press ↶.

4. Press ✓ to accept the value.
5. Set other parameters as necessary.
6. Configure other sections of the cable as required.
7. Press ↻ to start/stop the test.

Connection Diagram

The **Connection Diagram** tab displays how to connect the cables to the unit.

Continue button allows you to resume the test once the cables have been connected.

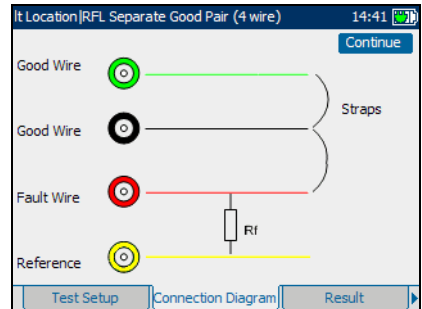

Result

The **Result** tab allows you to view detailed results of the RFL test.

RFL-4 Wires Test Results		
Distance to fault:	18.148 kft	149.5 Ω
Distance from fault to end:	12.116 kft	99.8 Ω
Distance to end:	30.264 kft	249.3 Ω
Fault located in section:	1	
Resistance at fault:	21.39 M Ω	
Voltage at fault:	-1.1 V	

Loop Mapper Test

The LoopMapper test allows you to easily identify faults in the cable with increased resolution using time domain reflectometry (TDR) and frequency domain reflectometry (FDR). This test is extremely useful in locating bridge taps and the end of the cable. Faults such as open ends and shorted ends can be easily found using the enhanced resolution of the FDR test.

Note: *This test is only available if LoopMapper is enabled in the software options.*



Test Setup

The **Test Setup** tab allows you to configure parameters for the Loop Mapper test.

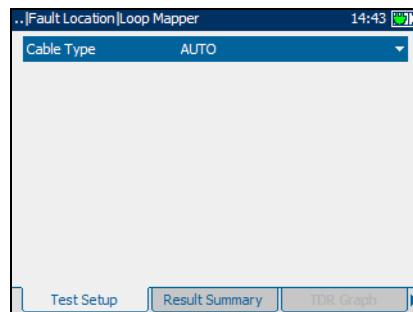
Define the **Cable Type** by selecting the gauge of the cable in use. If wire gauge is measured in AWG units, the available choices are: **AUTO, 19 AWG, 22 AWG, 24 AWG, or 26 AWG**. For mm gauge wire, the available choices are: **AUTO, 0.32 mm, 0.40 mm, 0.50 mm, 0.60 mm, 0.65 mm, 0.80 mm, 0.90 mm, or 1.20 mm**.



To set parameter values and start/stop the test:

1. Press  to display the list.
2. Use the up/down arrow key to highlight the desired value, and press  to accept the value.
3. Press  to start/stop the test.

Result Summary

The **Result Summary** tab allows you to view results of the Loop Mapper test in graphical and text form.

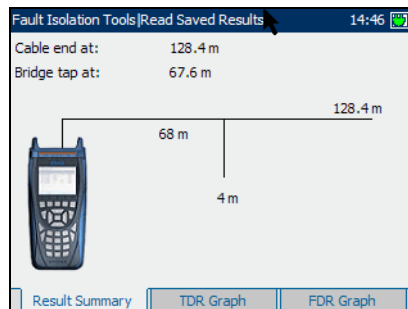

TDR Graph

The **TDR Graph** tab displays the current **Pulse/Gain** and measured values from the time domain reflectometry tests. **TDR** first attempts to find the length of the circuit and then searches all ranges from shortest to longest for significant events. Upon completion, the test selects the nearest major event, sets the range to match, and aligns the cursor with the event.

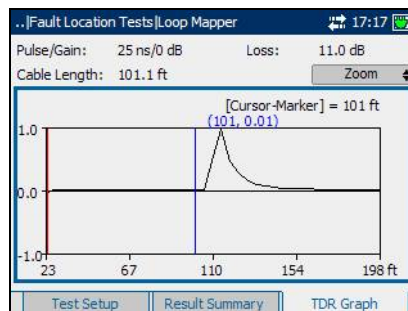

To make **TDR** adjustments via the keypad:

1. Press **✓** to change the mode button (top-right corner of the pane) and function of the up/down arrow keys.
2. Press **✓** repeatedly to cycle between:
 - **Zoom**
 - **CursorMarker** selection

Fault Location

Loop Mapper Test

To measure the distance/duration between reflections:

1. Press  to cycle the mode and change to **CursorMarker**.
2. Press the left/right arrow keys to position the blue cursor (indicated by the blue color of data above cursor).
3. Press the up arrow key to select the red marker.
4. Press the left/right arrow keys to position the marker.
5. The difference between the cursor and marker is continuously updated and is indicated with a triangle (delta symbol) above the graph.

To zoom in/out:

1. Press  to select the **Zoom** function. Default mode is **Zoom**.
2. Press the up/down arrow keys to increase/decrease **Zoom** function. The graphical display zooms in or out accordingly.

FDR Graph

The **FDR Graph** tab allows you to view results of the high resolution FDR test methodology used in the Loop Mapper test.

The list and buttons on the tab are described below:

- (Zoom function List) allows you to select the desired zoom function: **Horizontal Zoom** or **Vertical Zoom**. The selected function is displayed in the box.
- **Zoom In** allows you to increase the level of zoom for the selected zoom function.
- **Zoom Out** allows you to reduce the level of zoom for the selected zoom function.

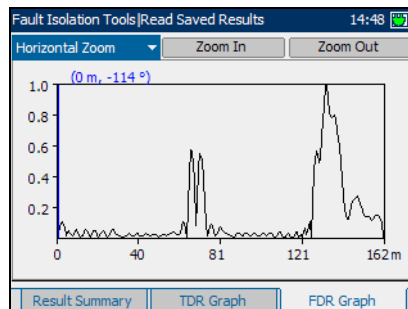

To zoom in/out:

1. Press ✓ to display a list of zoom functions.
2. Press the up/down arrow key to highlight the desired zoom function.
3. Press ✓ to select the zoom function.
4. Use the left/right arrow key to highlight the **Zoom In** or **Zoom Out** button as required, then press ✓.
5. The graphical display zooms in or out accordingly. Press ✓ repeatedly to continue zooming.

To move the screen pointer:

Press the left/right arrow key to move the screen pointer. The pointer value updates dynamically.

8 *Wideband Tests*

Wideband tests allow you to perform cable qualification checks on the circuit in the frequency range above 20 kHz. Wideband tests include the following:

- Receive tone (RX)
- Send tone (TX)
- PSD noise
- Spectral detective
- Impulse noise
- Impulse noise histogram
- Attenuation
- Longitudinal balance
- Data rate prediction

Note: Tests above 2.2 MHz are only available if VDSL2WB option is installed.

To access wideband tests:

1. From the **Home** pane use the up/down arrow keys to highlight **Fault Isolation Tools** and press ✓.
2. Highlight **Wideband Tests** and press ✓ to list the available tests.

To view the wideband test tabs:

1. From the **Wideband Tests** pane use the up or down arrow key to highlight the desired test, then press ✓.
2. Press the F1, F2, or F3 key to view available tabs. To view any available additional tabs, use the function arrow keys on either side of the F1 and F3 keys.

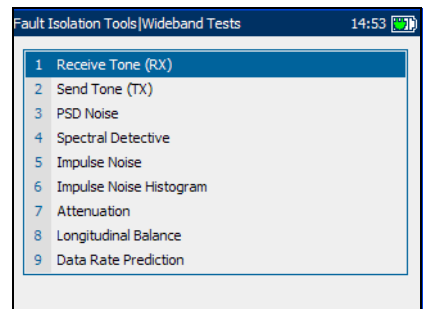

Wideband Tests

Receive Tone (RX)

Receive Tone (RX)

The wideband **Receive Tone (RX)** test allows you to configure and measure the level and frequency of incoming signals.

Each parameter is described below.

- **Termination** defines if the unit uses normal test impedance termination or high bridging impedance when the cable is active or terminated by other external equipment. For normal test termination select **TERMINATED**, otherwise select **BRIDGING**.
- **Termination Impedance** defines the impedance of the dummy load connected to the line. Select either **100 Ohms** or **135 Ohms**.

To start/stop the test:

1. Press the up/down arrow keys to highlight the desired test parameter.
2. Press **✓** to open the list.
3. Press the up/down arrow keys to highlight the desired value, then press **✓** to select it.
4. Select other parameters as required.
5. Press **↻** to start/stop the test.

Test results are displayed on the screen as they are completed.

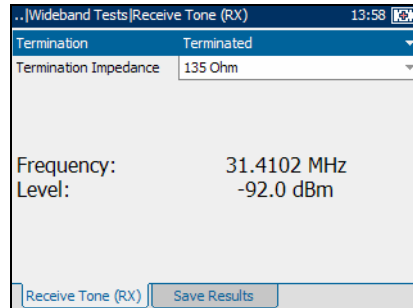

Send Tone (TX)

The wideband **Send Tone (TX)** test allows you to configure and transmit a tone to a downstream device in the loop.

Each parameter and button on the pane is described below.

- **Frequency (kHz)** is the frequency of the transmitting tone. Specify a value between **20** and **30000**.
- **Level (dBm)** is the tone level. Specify a value between **-10** and **10**.
- **Termination Impedance** defines the impedance of the dummy load connected to the line. Select either **100** or **135 Ohms**.
- **Apply** is used to confirm any changes to parameter values.

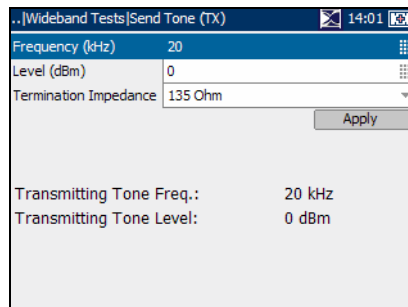

To start/stop test:

1. Press the up/down arrow keys to highlight the desired test parameter.
2. Press ✓ to select the value.
3. Press the left arrow key to erase the existing value, and then use the alphanumeric keypad to enter a value. To cancel the entry, press ↩.
4. Press ✓ to accept the value.
5. Change other parameter values as required.
6. Press the right arrow key, then use the up/down arrow key to highlight the **Apply** button. Press ✓ to confirm any changes.
7. Press ↻ to start/stop the test.

Test results are displayed on the screen as they are completed.

PSD Noise

The wideband power spectral density (PSD) noise test measures the noise energy at a point in a noise spectrum. It is expressed as power per hertz at a point in a noise spectrum.

Test Setup

The **Test Setup** tab allows you to configure the parameters for the wideband PSD noise test.

Each parameter on the pane is described below.

- **Bandwidth** specifies the frequency range for the test. Select **2.2 MHz**, **12 MHz**, **17 MHz**, or **30 MHz**.

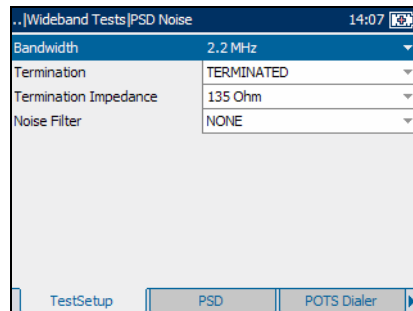

Note: *Frequency bands in excess of 2.2 MHz are only displayed if VDSL2WB is enabled in the software options.*



- **Termination** defines if the unit uses normal test impedance termination or high bridging impedance when the cable is active or terminated by other external equipment. For normal test termination select **TERMINATED**, otherwise select **BRIDGING**.
- **Termination Impedance** defines the impedance of the dummy load connected to the line. Select either **100** or **135 Ohm**.
- **Noise Filter** defines the level of wideband noise filtering. The available choices are: **NONE**, **50 kbit**, **ISDN-E**, **HDSL-F**, **ADSL-G**, **ADSL**, **ADSL2+**, **VDSL**, **VDSL2-8**, **VDSL2-12**, **VDSL2-17**, or **VDSL2-30**.

Note: *VDSL2-x filters are only available if VDSL2WB is enabled in the software options.*

To start/stop the test:

1. Press the up/down arrow keys to highlight the desired test parameter.
2. Press  to open the list.
3. Press the up/down arrow keys to highlight the desired value, then press  to select it.
4. Press  to start/stop the test.

PSD Noise

The **PSD Noise** tab allows you to view results of the wideband PSD noise test in graphical and text form.

The list and buttons on the pane are described below:

- (Zoom function List) allows you to select the desired zoom function: **Horizontal Zoom** or **Vertical Zoom**. The selected function is displayed in the box.
- **Zoom In** allows you to increase the level of zoom for the selected zoom function.
- **Zoom Out** allows you to reduce the level of zoom for the selected zoom function.
- **Peak** allows you to measure the peak PSD noise value, compare it against the previous value, and display the maximum value. This button is only available when the test is running. Toggle between **Peak** and **Normal**.

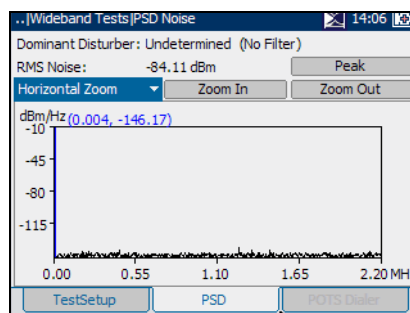

Wideband Tests

PSD Noise

To zoom in/out:

1. Press ✓ to display a list of zoom functions.
2. Press the up/down arrow key to highlight the desired zoom function.
3. Press ✓ to select the zoom function.
4. Use the left/right arrow key to highlight the **Zoom In** or **Zoom Out** button as required, then press ✓.
5. The graphical display zooms in or out accordingly. Press ✓ repeatedly to continue zooming.

To move the screen pointer:

Press the left/right arrow key to move the screen pointer. The pointer value updates dynamically.

Spectral Detective Test

The wideband spectral detective test allows you to bridge onto a live circuit to measure the PSD noise of the line. The spectral detective test measures up to 2.2 MHz (optionally up to 30 MHz with VDSL2WB option) so you can determine the xDSL technology that is being transmitted over the line, and the power associated with the transmitted technology to ensure it is not disruptive to adjacent cables and technologies.

Test Setup

The **Test Setup** tab allows you to configure parameters for the wideband spectral detective test.

Each parameter on the pane is described below.

- **Bandwidth** specifies the frequency range for the test. Select **2.2 MHz**, **12 MHz**, **17 MHz**, or **30 MHz**.

Note: *Frequency bands in excess of 2.2 MHz are only displayed if VDSL2WB is enabled in the software options.*

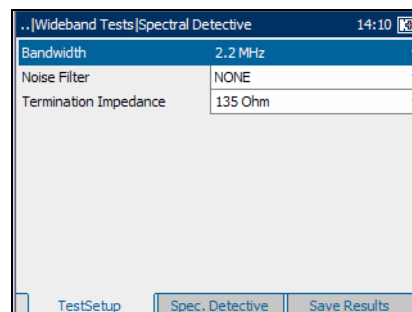

- **Noise Filter** defines the level of wideband noise filtering. The available choices are: **NONE**, **50 kbit**, **ISDN-E**, **HDSL-F**, **ADSL-G**, **ADSL**, **ADSL2+**, **VDSL**, **VDSL2-8**, **VDSL2-12**, **VDSL2-17**, or **VDSL2-30**.



Note: *VDSL2-x filters are only available if VDSL2WB is enabled in the software options.*

- **Termination Impedance** defines the resistive impedance of the dummy load connected to the line. Select one of the following: **100** or **135 Ohm**.

Wideband Tests

Spectral Detective Test

To start/stop the test:

1. Press the up/down arrow keys to highlight the desired test parameter.
2. Press  to open the list.
3. Press the up/down arrow keys to highlight the desired value, then press  to select it.
4. Press  to start/stop the test.

Spectral Detective

The **Spectral Detective** tab allows you to view results of the wideband spectral detective test in graphical and text form.

The list and buttons on the tab are described below:

- (Zoom function List) allows you to select the desired zoom function: **Horizontal Zoom** or **Vertical Zoom**. The selected function is displayed in the box.
- **Zoom In** allows you to increase the level of zoom for the selected zoom function.
- **Zoom Out** allows you to reduce the level of zoom for the selected zoom function.

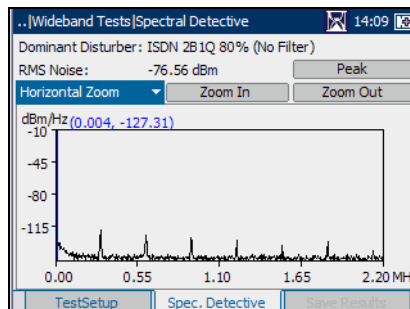

To zoom in/out:

1. Press ✓ to display a list of zoom functions.
2. Press the up/down arrow key to highlight the desired zoom function.
3. Press ✓ to select the zoom function.
4. Use the left/right arrow key to highlight the **Zoom In** or **Zoom Out** button as required, then press ✓.
5. The graphical display zooms in or out accordingly. Press ✓ repeatedly to continue zooming.

To move the screen pointer:

Press the left/right arrow key to move the screen pointer. The pointer value updates dynamically.

Impulse Noise Test

The wideband impulse noise test allows you to measure impulse noise on the circuit under test.

Test Setup

The **Test Setup** tab allows you to configure parameters for the wideband impulse noise test.

Each parameter on the pane is described below.

- **Termination** defines if the unit uses normal test impedance termination or high bridging impedance when the cable is active or terminated by other external equipment. For normal test termination select

TERMINATED, otherwise select **BRIDGING**.

- **Termination Impedance** defines the impedance of the dummy load connected to the line. Select one of the following: **100** or **135 Ohm**.
- **Noise Filter** defines the level of wideband noise filtering. The available choices are: **NONE**, **50 kbit**, **ISDN-E**, **HDSL-F**, **ADSL-G**, **ADSL**, **ADSL2+**, **VDSL**, **VDSL2-8**, **VDSL2-12**, **VDSL2-17**, or **VDSL2-30**.

Note: *VDSL2-x filters are only available if VDSL2WB is enabled in the software options.*

- **Threshold(dBm)** is the maximum impulse noise level. Specify a value between **-50** and **0** (-40 and 0 if any filter applied).
- **Measurement Time** defines the duration of the Impulse Noise test. The available choices are: **1**, **5**, **15**, or **60 Minutes**, or **24 Hours**.

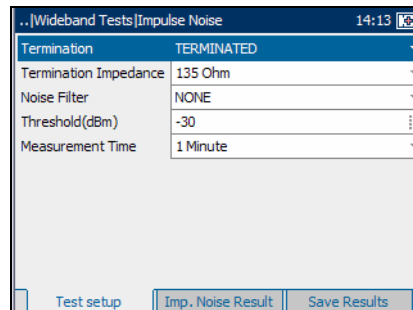

To start/stop the test:

1. Press the up/down arrow keys to highlight the desired test parameter.
2. Press ✓ to open the list or specify a value.
3. Press the up/down arrow keys to highlight the desired value.

OR

4. Press the left/right arrow keys to erase the existing value, and then use the alphanumeric keypad to enter a value. To cancel the entry, press ↵.
5. Press ✓ to accept the value.
6. Select other parameters as required.
7. Press ↻ to start/stop the test.

Impulse Noise Result

The **Imp. Noise Result** tab allows you to view results of the wideband impulse noise test in text form.

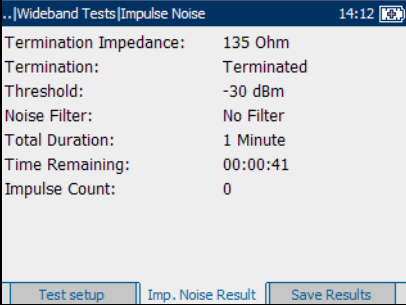

The screenshot shows a software window titled '..[Wideband Tests]Impulse Noise' with a timestamp of 14:12. The window displays the following test parameters:

Termination Impedance:	135 Ohm
Termination:	Terminated
Threshold:	-30 dBm
Noise Filter:	No Filter
Total Duration:	1 Minute
Time Remaining:	00:00:41
Impulse Count:	0

At the bottom of the window, there are three tabs: 'Test setup', 'Imp. Noise Result' (which is selected), and 'Save Results'.

Impulse Noise Histogram

The wideband impulse noise histogram test displays a plot of the impulse noise spikes over a user-defined time period.

Test Setup

The **Test Setup** tab allows you to configure parameters for the wideband impulse noise histogram test.

Each parameter on the pane is described below.

- **Termination** defines if the unit uses normal test impedance termination or high bridging impedance when the cable is active or terminated by other external equipment. For normal test termination select

TERMINATED, otherwise select **BRIDGING**.

- **Termination Impedance** defines the impedance of the dummy load connected to the line. Select either **100** or **135 Ohm**.
- **Noise Filter** defines the level of wideband noise filtering. The available choices are: **NONE**, **15 kHz**, **50 kbit**, **ISDN-E**, **HDSL-F**, **ADSL-G**, **ADSL**, **ADSL2+**, **VDSL**, **VDSL2-8**, **VDSL2-12**, **VDSL2-17**, or **VDSL2-30**.

Note: *VDSL2-x filters are only available if VDSL2WB is enabled in the software options.*

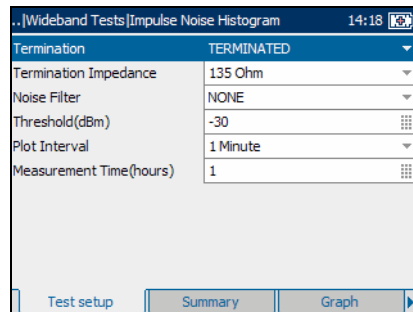

- **Threshold(dBm)** is the maximum impulse noise level. Specify a value between **-50** and **0** (-40 and 0 if any filter applied).
- **Plot Interval** defines the baseline time duration for measuring impulse noise spikes, and represents the resolution of the plot. Select one of the following: **1, 5, 15, or 60 Minutes**.
- **Measurement Time (hours)** defines the duration of the Impulse Noise Histogram test. Specify a value between **1** and **360** hours.

To start/stop the test:

1. Press the up/down arrow keys to highlight the desired test parameter.
2. Press ✓ to open the list or specify a value.
3. Press the up/down arrow keys to highlight the desired value.

OR

4. Press the left/right arrow keys to erase the existing value, and then use the alphanumeric keypad to enter a value. To cancel the entry, press ↵.
5. Press ✓ to accept the value.
6. Select other parameters as required.
7. Press ↻ to start/stop the test.

Summary

The **Summary** tab allows you to view results of the wideband impulse noise histogram test in text form.

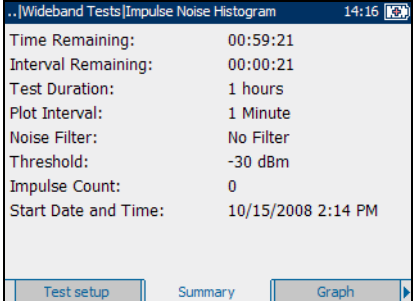

The screenshot shows a window titled "[Wideband Tests] Impulse Noise Histogram" with a timestamp of 14:16. The window contains a list of test parameters and their values. At the bottom, there are three tabs: "Test setup", "Summary", and "Graph".

Time Remaining:	00:59:21
Interval Remaining:	00:00:21
Test Duration:	1 hours
Plot Interval:	1 Minute
Noise Filter:	No Filter
Threshold:	-30 dBm
Impulse Count:	0
Start Date and Time:	10/15/2008 2:14 PM

Wideband Tests

Impulse Noise Histogram

Graph

The **Graph** tab allows you to view results of the wideband impulse noise histogram test in graphical form.

The buttons on the pane are described below:

- **Zoom In** allows you to increase the level of zoom for the selected zoom function.
- **Zoom Out** allows you to reduce the level of zoom for the selected zoom function.

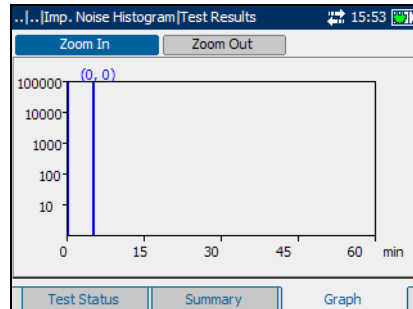

To zoom in or out:

1. Use the left or right arrow key to highlight the **Zoom In** or **Zoom Out** button as required, then press **✓**.
2. The graphical display zooms in or out accordingly. Press **✓** repeatedly to continue zooming.

To move the screen pointer:

Press the left/right arrow key to move the screen pointer. The pointer value updates dynamically.

Attenuation Test

The wideband attenuation test allows you to measure the dissipation of power of a transmitted signal as it travels over the copper line.

Test Setup

The **Test Setup** tab allows you to configure parameters for the wideband attenuation test.

Select the **Bandwidth** of the frequency range for the test:

2.2, 12, 17, or 30 MHz.

Note: *Frequency bands in excess of 2.2 MHz are only displayed if VDSL2WB is enabled in the software options.*

To start/stop the test:

1. Press ✓ to open the list.
2. Press the up/down arrow keys to highlight the desired value, then press ✓ to select it.
3. Press ↻ to start/stop the test.

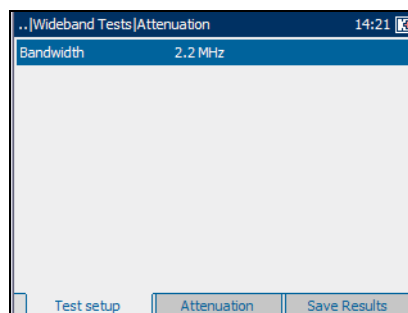

Wideband Tests

Attenuation Test

Attenuation

The **Attenuation** tab allows you to view results of the wideband attenuation test in graphical form.

The list and buttons on the tab are described below:

- (Zoom function List) allows you to select the desired zoom function: **Horizontal Zoom** or **Vertical Zoom**. The selected function is displayed in the box.

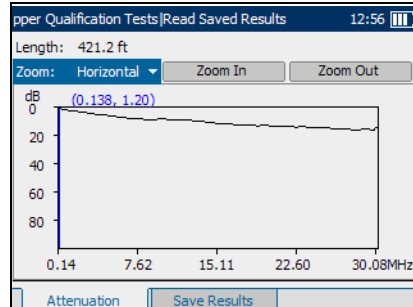

- **Zoom In** allows you to increase the level of zoom for the selected zoom function.
- **Zoom Out** allows you to reduce the level of zoom for the selected zoom function.

To zoom in/out:

1. Press ✓ to display a list of zoom functions.
2. Press the up/down arrow key to highlight the desired zoom function.
3. Press ✓ to select the zoom function.
4. Use the left/right arrow key to highlight the **Zoom In** or **Zoom Out** button as required, then press ✓.
5. The graphical display zooms in or out accordingly. Press ✓ repeatedly to continue zooming.

To move the screen pointer:

Press the left/right arrow key to move the screen pointer. The pointer value updates dynamically.

Longitudinal Balance

The wideband longitudinal balance test ensures that the longitudinal balance ratio for the twisted pair complies with applicable standards so as to reduce the effects of common-mode voltage to ground. The better the longitudinal balance of the cable pair, the higher the dB reading.

Test Setup

The **Test Setup** tab allows you to configure parameters for the wideband longitudinal balance test.

Each parameter on the pane is described below.

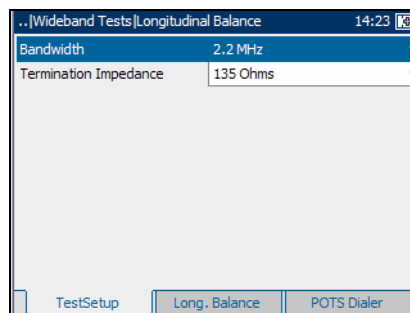

- **Bandwidth** specifies the frequency range for the test. Select **2.2 MHz**, **12 MHz**, **17 MHz**, or **30 MHz**.

Note: *Frequency bands in excess of 2.2 MHz are only displayed if VDSL2WB is enabled in the software options.*



- **Termination Impedance** defines the impedance of the dummy load connected to the line. Select one of the following: **100 Ohms** or **135 Ohms**.

To start/stop the test:

1. Press the up/down arrow keys to highlight the desired test parameter.
2. Press  to open the list.
3. Press the up/down arrow keys to highlight the desired value, then press  to select it.
4. Press  to start/stop the test.

Wideband Tests

Longitudinal Balance

Longitudinal Balance Results

The **Long. Balance** tab allows you to view results of the wideband longitudinal balance test in graphical form.

The buttons on the tab are described below:

- (Zoom function List) allows you to select the desired zoom function: **Horizontal Zoom** or **Vertical Zoom**. The selected function is displayed in the box.
- **Zoom In** allows you to increase the level of zoom for the selected zoom function.
- **Zoom Out** allows you to reduce the level of zoom for the selected zoom function.

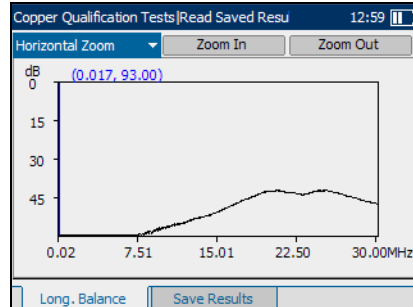

To zoom in/out:

1. Press ✓ to display a list of zoom functions.
2. Press the up/down arrow key to highlight the desired zoom function.
3. Press ✓ to select the zoom function.
4. Use the left/right arrow key to highlight the **Zoom In** or **Zoom Out** button as required, then press ✓.
5. The graphical display zooms in or out accordingly. Press ✓ repeatedly to continue zooming.

To move the screen pointer:

Press the left/right arrow key to move the screen pointer. The pointer value updates dynamically.

Data Rate Prediction

The data rate prediction test is based on measurements of PSD noise and attenuation. Considering the fact that all estimates are done from the single end of the loop, the created report will be presented as a prediction with reasonable probability.

DSL Rate

The **DSL Rate** tab allows you to configure parameters and view results for the current loop topology. The data rate prediction (DRP) test displays the calculated downstream and upstream rates.

Each parameter on the pane is described below.

- **Annex** defines the modes of available ADSL Annexes from the ITU standards.
 - **A** is ADSL service functioning over POTS.
 - **B** activates the ADSL functionality over ISDN.
 - **L Mask 1** assumes an increase in ADSL2 range/distance.
 - **L Mask 2** also extends the signal reach but can show an improvement in the upstream data rate.
 - **M** allows increased upload speeds from 1 Mbps to 3.5 Mbps. Available only for ADSL2 and ADSL2+.
- **Technology** lists the following values: **ADSL**, **ADSL2**, or **ADSL2+**. If **Annex L** is previously selected, **ADSL2** is automatically set. If **Annex M**, **ADSL** is not available.

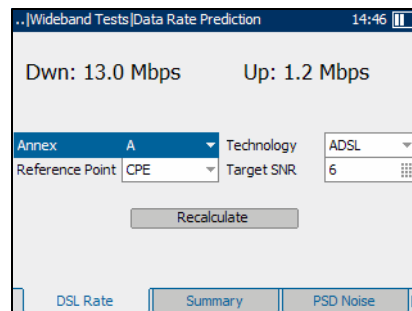

Wideband Tests

Data Rate Prediction

- **Reference Point** is either **CO** or **CPE**, allowing you to select from which end of the circuit you are running the DRP test. **CO** is located at the CO/Exchange side and you are testing towards the subscriber. **CPE** is the subscriber side and you are testing towards the CO/Exchange.
- **Target SNR** is the desired signal-to-noise ratio ranging from 0 to 31 dB. Default value is 6 dB.
- **Recalculate** button allows you to change the setup and re-evaluate the rates.

To re-set parameters to view different results:

1. Press the up/down or left/right arrow keys to highlight the desired parameter.
2. Press ✓ to display the list or select the value.
3. Press the up/down arrow keys to highlight the desired value.
OR
4. Press the left arrow key to erase the existing value, and then use the alphanumeric keypad to enter a value. To cancel the entry, press ↩.
5. Press ✓ to accept the value.
6. Press the up/down arrow keys to highlight the **Recalculate** button.
7. Press ✓ to recalculate rates for the new setup.

Summary

The **Summary** tab allows you to view results, change some of the variables and **Recalculate** the results.

Each parameter on the pane is described below.

- **Annex** defines the modes of available ADSL Annexes from the ITU standards.
 - **A** is ADSL service functioning over POTS.
 - **B** activates the ADSL functionality over ISDN.
 - **L Mask 1** assumes an increase in ADSL2 range/distance.
 - **L Mask 2** also extends the signal reach but can show an improvement in the upstream data rate.
 - **M** allows increased upload speeds from 1 Mbps to 3.5 Mbps. Available only for ADSL2 and ADSL2+.
- **Technology** lists the following values: **ADSL**, **ADSL2**, or **ADSL2+**. If **Annex L** is previously selected, **ADSL2** is automatically set. If **Annex M**, **ADSL** is not available.
- **Reference Point** is either **CO** or **CPE**, allowing you to select from which end of the circuit you are running the DRP test. **CO** is located at the CO/Exchange side and you are testing towards the subscriber. **CPE** is the subscriber side and you are testing towards the CO/Exchange.
- **Target SNR** is the desired signal-to-noise ratio ranging from 0 to 31 dB. Default value is 6 dB.
- **Recalculate** button allows you to change the setup and re-evaluate the rates.

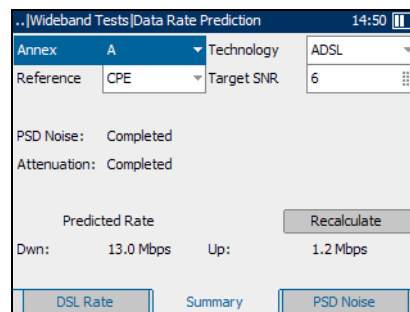

Wideband Tests

Data Rate Prediction

To re-set parameters to view different results:

1. Press the up/down or left/right arrow keys to highlight the desired parameter.
2. Press ✓ to display the list or select the value.
3. Press the up/down arrow keys to highlight the desired value.
OR
4. Press the left arrow key to erase the existing value, and then use the alphanumeric keypad to enter a value. To cancel the entry, press ↩.
5. Press ✓ to accept the value.
6. Press the up/down arrow keys to highlight the **Recalculate** button.
7. Press ✓ to recalculate rates for the new setup.

PSD Noise

The **PSD Noise** tab identifies the presence of disturber signals when no filter is selected as **Dominant Disturber** and the **RMS Noise** value from the power spectral density (PSD) noise tests in text and graphical form. RMS noise voltage measures the signal-to-noise ratio of the circuit.

The list and buttons on the tab are described below:

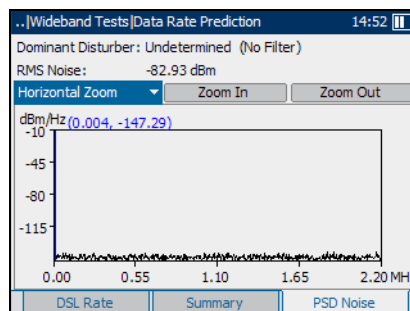

- (Zoom function List) allows you to select the desired zoom function: **Horizontal Zoom** or **Vertical Zoom**. The selected function is displayed in the box.
- **Zoom In** allows you to increase the level of zoom for the selected zoom function.
- **Zoom Out** allows you to reduce the level of zoom for the selected zoom function.

To zoom in or out:

1. Press **✓** to display a list of zoom functions.
2. Press the up/down arrow keys to highlight the desired zoom function.
3. Press **✓** to select the zoom function.
4. Use the left/right arrow keys to highlight the **Zoom In** or **Zoom Out** button as required, then press **✓**.

The graphical display zooms in or out accordingly.

5. Press **✓** repeatedly to continue zooming.

To move the screen pointer:

Press the left/right arrow keys to move the screen pointer. The pointer value updates dynamically.

Wideband Tests

Data Rate Prediction

Attenuation

The **Attenuation** tab displays the wideband attenuation test results in graphical form.

The list and buttons on the tab are described below:

- (Zoom function List) allows you to select the desired zoom function: **Horizontal Zoom** or **Vertical Zoom**. The selected function is displayed in the box.

- **Zoom In** allows you to increase the level of zoom for the selected zoom function.
- **Zoom Out** allows you to reduce the level of zoom for the selected zoom function.

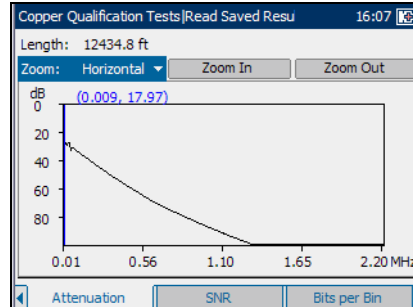

To zoom in/out:

1. Press ✓ to display a list of zoom functions.
2. Press the up/down arrow key to highlight the desired zoom function.
3. Press ✓ to select the zoom function.
4. Use the left/right arrow key to highlight the **Zoom In** or **Zoom Out** button as required, then press ✓.
5. The graphical display zooms in or out accordingly. Press ✓ repeatedly to continue zooming.

To move the screen pointer:

Press the left/right arrow key to move the screen pointer. The pointer value updates dynamically.

Signal-to-Noise Ratio

The **SNR** tab displays the signal-to-noise ratio per tone in graphical form.

The list and buttons on the tab are described below:

- (Zoom function List) allows you to select the desired zoom function:

Horizontal Zoom or **Vertical Zoom**. The selected function is displayed in the box.

- **Zoom In** allows you to increase the level of zoom for the selected zoom function.
- **Zoom Out** allows you to reduce the level of zoom for the selected zoom function.

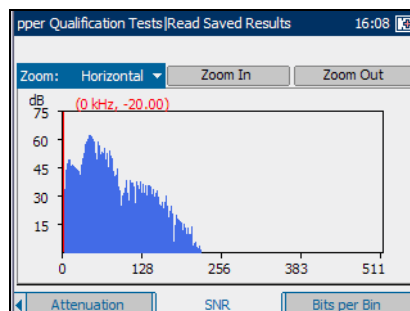

To zoom in or out:

1. Press ✓ to display a list of zoom functions.
2. Press the up/down arrow keys to highlight the desired zoom function.
3. Press ✓ to select the zoom function.
4. Use the left/right arrow keys to highlight the **Zoom In** or **Zoom Out** button as required, then press ✓.

The graphical display zooms in or out accordingly.

5. Press ✓ repeatedly to continue zooming.

To move the screen pointer:

Press the left/right arrow keys to move the screen pointer. The pointer value updates dynamically.

Bits per Bin

The **Bits per Bin** tab displays in graphical form the number of bits that can be transmitted on a particular bin representing a certain tone.

- **Zoom In** allows you to increase the level of zoom for the selected zoom function.
- **Zoom Out** allows you to reduce the level of zoom for the selected zoom function.

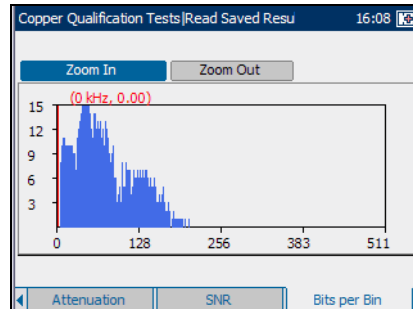

To zoom in or out:

1. Press the up or down arrow key to highlight the desired zoom function.
2. Press **✓** to select the zoom function.
3. Use the left or right arrow key to highlight the **Zoom In** or **Zoom Out** button as required, then press **✓**.

The graphical display zooms in or out accordingly.

4. Press **✓** repeatedly to continue zooming.

To move the screen pointer:

Press the left/right arrow keys to move the screen pointer. The pointer value updates dynamically.

9

Getting Started with DSL and Ethernet Testing

The AXS-200/635i not only verifies service and connectivity to the DSLAM, but also executes upstream and downstream performance measurements such as actual data rates, attenuation, and noise margin. In addition, it provides advanced IPTV measurements such as packet jitter and loss, PCR jitter, MDI, PID viewer and IGMP zap time; and also supports higher layer testing such as ping, traceroute and Web download speed.

To access DSL/IP tests:

From the **Home** pane use the up/down arrow keys to highlight **DSL/IP Tests** and press **✓**.

DSL/IP Tests

VDSL2, ADSL2+, and Ethernet tests include the Auto and Manual Test function, IPTV, data, VoIP, and HPNA analyses.

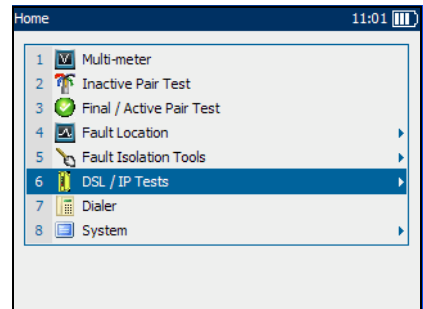

DSL/IP Tests Menu

The **DSL/IP Tests** menu pane lists all the test capabilities of the unit.

To access the DSL/IP tests:

1. From the **DSL/IP Tests** pane, highlight the desired item and press 
OR
2. press the corresponding item number.
3. When selected, each of the five tests starts, using the connection setup from the current profile.
 - **Connection Setup** allows you to setup a series of connection parameters for Auto and Manual Test, IPTV, data, and VoIP analyses beginning with the **Selected Profile** tab.
 - **Configure Tests** allows you to configure a series of test parameters to verify applications, beginning with **Auto Test**.
 - **Read Saved Result** allows you to view the **Read Results** page.

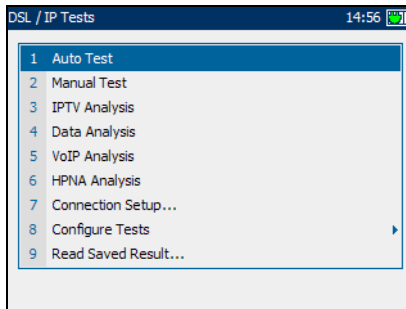

Saving Results

You can save any of your results after running and viewing a test performed with the AXS-200/635i, in either text or graphical format. Each DSL/IP test includes a **Save Results** tab to do so.

Press the F1, F2, or F3 key to view this tab, or use the function arrow keys on either side of the F1 and F3 keys to access it.

Save Result

The **Save Result** tab allows you to save your test results to a file or to an HTML report.

Each entry on the pane is described below:

- **Save as Type** lists the following formats to save your test results:
 - **AXS200 format** is a binary file format with ext *.dat. This format can be opened only on an AXS200 unit. The **Available Graphs** list box will be unavailable in this case.
 - ***.csv** saves only graphical results. Textual results must be formatted as a comma-separated values table for easy importation to Excel. Results are saved to USB.
 - ***.gif** stands for graphics interchange format and is one of the most common file formats for graphic images on the World Wide Web. Results are saved to USB.
 - ***.bmp** saves graphical results in a bitmap file format. Results are saved to USB.
 - ***.xml** saves your data in a common language format to share on the Web. Results are saved to USB.

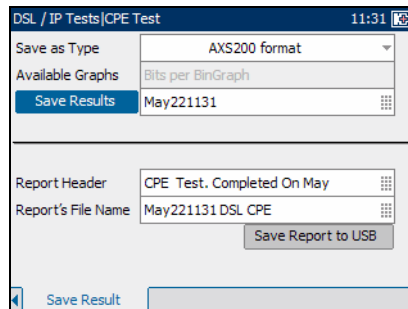

Getting Started with DSL and Ethernet Testing



Saving Results

- **Available Graphs** is enabled only if the selected format under **Save as Type** is ***.gif**, ***.csv**, or ***.bmp**. For a test that does not have a graph, this list box is unavailable.
- **Save Results** button saves the test results in internal or external memory (depending on the **Save as Type** format).
- **Filename** is the current date and time stamp plus you can enter any name. If it already exists, you will be prompted to overwrite the existing file.
- **Report Header** is where you can enter any comment. The initial value is the current test followed by the date and time stamp.
- **Report's File Name** is where you can enter any name for the HTML filename. If the name already exists, you will be prompted to overwrite the existing file. The default extension is **.html**.

The default name is generated from the current time.
- **Save Report to USB** button saves the results to an HTML report. If a USB memory stick is not inserted, the following warning dialogue box appears: **USB device is not detected**.

To set parameter values and save results:

1. Press the left/right and up/down arrow keys to highlight the desired parameter.
2. Press  to display the list or select the value.
3. Press the up/down arrow key to highlight the desired value.

OR
4. Press the left arrow key to erase the existing value, and then use the alphanumeric keypad to enter a value. To cancel the entry, press .
5. Press  to accept the value.

Read Saved Results

The **Read Results** pane tab allows you to select a test type and view the results of all the files previously saved.

Test types listed include the following **Ethernet, DSL**, and HPNA (only if software option is enabled) tests:

- manual
- IPTV
- data
- VoIP
- HPNA

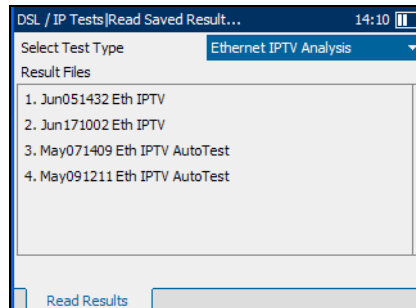

To open previously saved test results:

1. Press ✓ to open the list.
2. In the list, press the up/down arrows to select the test type.
3. Press ✓ to confirm the selection.
4. Press the down arrow to activate the **Result Files** list box and press ✓ to display the list of available files.
5. Press the up/down arrows to select the desired result file.
6. Press ✓ to view the selection.

10 **Connection Setup for DSL/IP Triple-Play Verification Tests**

The purpose of the **Connection Setup** function is to configure the unit for a series of connection parameters for Auto and Manual Test, IPTV, data, VoIP, and HPNA analyses. These parameters are accessible through the different pane tabs.

To configure the connection parameters during DSL/IP tests:

1. From the **DSL/IP Tests** pane, use the up/down arrows to select the **Connection Setup** entry.
2. Press  to confirm the selection.

To view the available tabs:

Press the left/right function arrows on each side of the F1, F2, and F3 keys.

Setup Profile

Profiles can be created and stored in the internal memory for later use. They can also be stored externally or exported to another unit via a USB memory device. You can easily load an external profile through the USB port.

Selected Profile

The **Selected Profile** tab allows you to configure and store multiple profiles containing specific setups for the unit.

- **Line Mode** lists the following selections:
 - **VDSL2-STGR** is the default selection for Lucent Stinger 9.11x Ikanos CO4 DSLAM.
 - **VDSL2-ALCL** is for generic (e.g. Alcatel) VDSL2 DSLAMs in North America.
 - **ADSL2+** is for ADSL1/2/2+, Annex L, and T1.413
 - **AUTO-DSL** maps the associated profile to the defined DSLAM sequence and measures a timeout to determine if the connection fails to sync with the current DSLAM. If timeout, the next DSLAM profile is mapped and starts the sync procedure.
 - **Ethernet** enables local area network testing.
 - **HPNA-coax** - If selected, verify that the ARU-100 HPNA test probe is connected to the WAN port of your AXS-600 series module.
- **Access Mode** displays a list of connection values. Default is **Routed PPPoE**.
- **Profile Name** is a list of all available profile files in the current directory with the first entry being **Default**. Once you open the selected profile, it remains active in the unit until a different or newer profile is selected. You can store over 100 profiles.

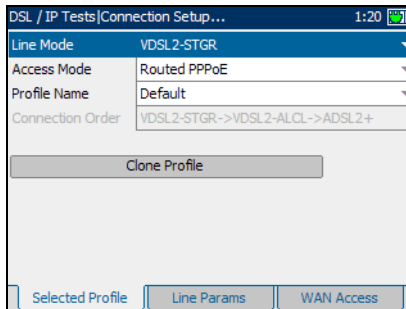

- **Connection Order** is only enabled if **Line Mode** is set to **AUTO-DSL**. This entry allows you to select the priority of the two VDSL2 modes:

VDSL2-STGR->VDSL2-ALCL->ADSL2+ (This is the default selection.)

VDSL2-ALCL->VDSL2-STGR->ADSL2+

- **Clone Profile** allows you to copy an existing profile to a new profile and switch to use the new profile.

When you change the selections and press ↩ or 🏠, the following actions should be performed:

1. If **ProfileName** selection is not **Default** then save modifications (if any) into the current profile file and proceed with the selected action.
2. If **ProfileName** selection is **Default** and modification to the profile has been made then enter the new name of the profile.

At power up, all settings are read from the last current profile.

- **Enter Profile Name** is the new name of the profile.

To save modifications made to a CustomProfile:

1. Select **Save as New Profile** and create and save a new **CustomProfile** name in the current directory.
2. If the file with **CustomProfile** name already exists in the current directory, you will be prompted to overwrite it.

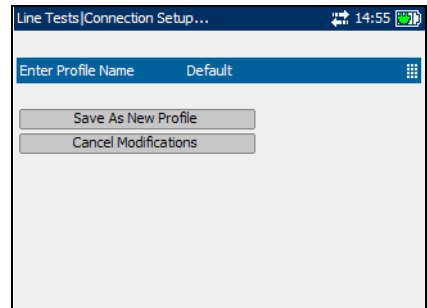



IMPORTANT

Changes to test parameters will be lost if the unit is turned off without first saving them to a default or custom profile. The unit can also be left in suspend mode to avoid loss of test parameters.

To cancel modifications made to a CustomProfile:

1. Select **Cancel Modifications** and reload the current profile with the default profile.
2. Proceed with the previously selected action (↶, 🏠, ↻).

Setup Line Connection

Line Parameters

The **Line Params** tab allows you to set the basic DSL and Ethernet negotiation modes for a **Selected Profile** composed of the current **LineMode** selections.

When the **LineMode** selection is **ADSL2+** or **AUTO-DSL**, the available parameters are the following:

- **Annex** displays a non-edit text box with **Annex A** which is ADSL service functioning over POTS. Annex L which assumes an increase in ADSL range/distance is supported by default.
- **VPI** is the virtual path identifier (VPI) ranging from 0 through 255 for the ATM connection.
- **VCI** is the virtual circuit identifier (VCI) ranging from 32 through 65535 for the ATM connection.

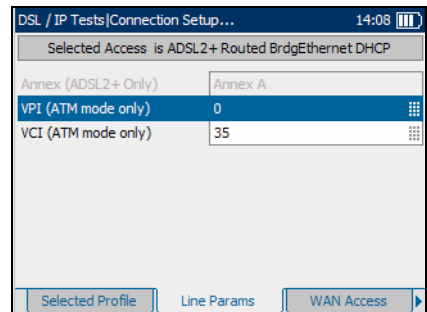

When the **LineMode** selection is **Ethernet**, the available parameters are the following:

- **Link Speed** is a choice between **AUTO** (negotiated during the link establishment), **100** or **10 Mbps**.
- **Connect Mode** is **Full-duplex** or **Half-duplex**, when **Link Speed** is set to either **100** or **10 Mbps**.

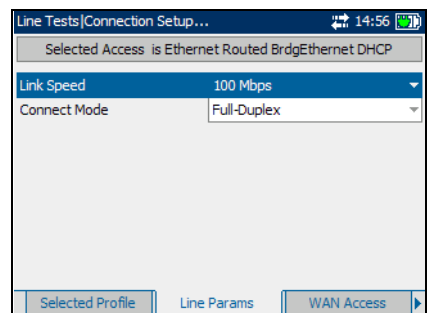

Note: When the **Line Mode** selection is **VDSL2-STGR** or **VDSL2-ALCL**, no setup is needed in the **Line Params** tab.

Connection Setup for DSL/IP Triple-Play Verification Tests

Setup Line Connection

To select the line parameters to configure:

- 1.** From the **Connection Setup** pane, press the left/right function arrows until the **Line Params** tab is displayed.
- 2.** Press the F1, F2, or F3 key located just below the tab to select it.
- 3.** Press the up/down arrows to select the desired parameter.
- 4.** Press ✓ to open the list or modify the parameter.
- 5.** In the list, press the up/down arrows to select the function or mode.

OR

Use the alphanumeric keypad to enter the value you want to specify.

- 6.** Press ✓ to confirm the selection.

WAN Access

The **WAN Access** tab allows you to configure the physical line parameters required to connect to the ISP (internet service provider). The described **Selected Profile** is composed of the current **LineMode** and **AccessMode** selections.

The available parameters are the following:

- **Encapsulation Type** depends on the network configuration and lists the ATM as **LLC**, also known as LLC-SNAP (logical link control-sub network address protocol) or **VC MUX** (virtual channel multiplex).
- **VLAN Support** enables the unit to analyze and pass VLAN tagged ethernet frames through the virtual local area network (VLAN).
- **VLAN ID** is a virtual local area network (VLAN) tag ranging from 0 through 4094.
- **VLAN Priority** sets the priority of the virtual local area network (VLAN) with a value ranging from 0 through 7.
- **NAT** is the network address translation (NAT), which either enables the unit to use a public router address for all outgoing packets, or exposes the private LAN IP address to the WAN, if disabled.
- **IGMP** displays the version of the internet group management protocol (IGMP).

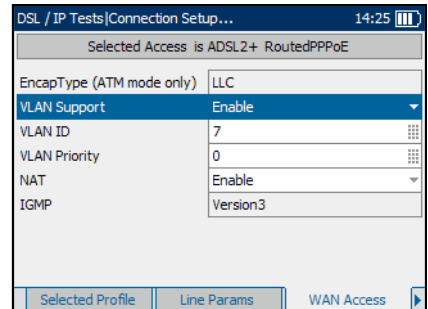

Connection Setup for DSL/IP Triple-Play Verification Tests

Setup Line Connection

To select the WAN access parameters to configure:

- 1.** From the **Connection Setup** pane, press the left/right function arrows until the **WAN Access** tab is displayed.
- 2.** Press the F1, F2, or F3 key located just below the tab to select it.
- 3.** Press the up/down arrows to select the desired parameter.
- 4.** Press ✓ to open the list or modify the parameter.
- 5.** In the list, press the up/down arrows to select the function or mode.

OR

Use the alphanumeric keypad to enter the value you want to specify.

- 6.** Press ✓ to confirm the selection.

WAN IP

The **WAN IP** tab allows you to configure the wide area network parameters required to connect to the ISP for a **Selected Profile** composed of the current **LineMode** and **AccessMode** selections.

When the **AccessMode** selection is set to **Routed BrgdEthernet DHCP**, the available parameters are the following:

- **Vendor ID** is the name of the unit, maximum 80 characters.
- **Local MAC Address** is the *internal MAC address* of the unit: either **AXS200** or **User Defined**.
- **MAC Address** is a specific **MAC address**, maximum 17 characters, if you select **User Defined** for the previous parameter.

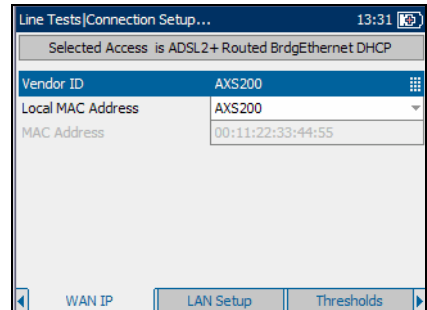

When the **AccessMode** selection is set to **Routed BrgdEthernet Static**, the available parameters are the following:

- **IP Address** is the address for the unit that is actively connected to your network or the internet at the time of login.
- **Gateway** is the IP address of the default gateway.
- **Subnet Mask** is the network address used to identify if the IP address is within the same wide area network.
- **DNS1** is the address of the *primary* domain name server to be used by the unit. If DNS is unavailable, enter 0.0.0.0.

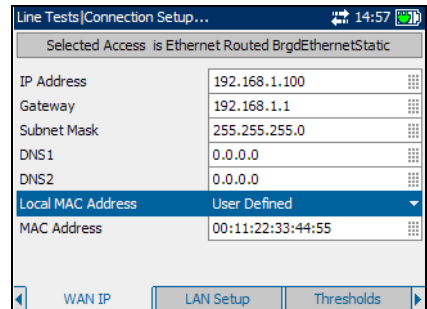

Connection Setup for DSL/IP Triple-Play Verification Tests

Setup Line Connection

- **DNS2** is the address of the *secondary* domain name server to be used by the unit. If DNS is unavailable, enter 0.0.0.0.
- **Local MAC Address** is the *internal* MAC address of the unit: either **AXS200** or **User Defined**.
- **MAC Address** is a specific MAC address, maximum 17 characters, if you select **User Defined** for the previous parameter.

When the **AccessMode** selection is set to **Routed PPPoE**, the available parameters are the following:

- **Obtain IP** is either **Dynamic** where the access concentrator or broadband remote access server assigns a temporary IP address to the unit, or **Static** where you enter the IP address of the unit.
- **Static IP** is the address of the current location assigned by the service provider. This entry is unavailable if **Obtain IP** is set to **Dynamic**.
- **Login Name** is your user ID.
- **Password** is your user password.

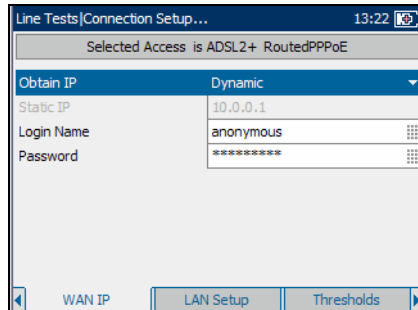

Note: *WAN IP setup is not required when Access Mode is set to Bridged. The line encapsulation setting defines the parameters required.*

To select the WAN IP parameters to configure:

1. From the **Connection Setup** pane, press the left/right function arrows until the **WAN IP** tab is displayed.
2. Press the F1, F2, or F3 key located just below the tab to select it.
3. Press the up/down arrows to select the desired parameter.
4. Press ✓ to open the list or modify the parameter.
5. In the list, press the up/down arrows to select the function or mode.

OR

Use the alphanumeric keypad to enter the value you want to specify.

6. Press ✓ to confirm the selection.

LAN Setup

The **LAN Setup** tab allows you to configure the parameters required when working in *Throughmode*, and the local area network (LAN) is connected to the ethernet interface. These parameters only apply when the WAN access mode is set to **Routed**. The described **Selected Profile** is composed of the current **LineMode** and **AccessMode** selections.

The available parameters are the following:

- **VLAN Tagging** enables the unit to recognize frames with a specified PVID. This entry is disabled if **VLAN Support** is set to **Disable** on the **WAN Access** pane.
- **LAN DHCP Server** enables the dynamic host configuration protocol (DHCP) mode for the LAN side of the connection.
- **LAN IP** is the local network IP address of the unit.
- **LAN Subnet Mask** is the network address mask used to identify if the IP address is within the same local area network.
- **ARU-100(HPNA)** enables you to be **Connected** or **Disconnected** from the HPNA test probe. **Connected** allows monitoring of **HPNA Info** in a triple-play application. The entry is only visible with the HPNA software option and if **Line Mode** selected is *not* **HPNA-coax**.

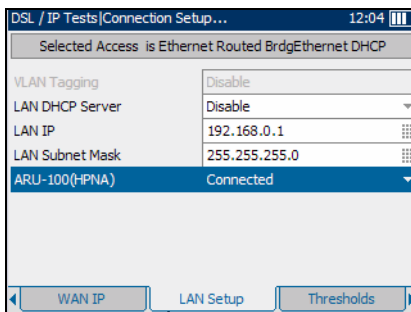

To select the LAN parameters to configure:

1. From the **Connection Setup** pane, press the left/right function arrows until the **LAN Setup** tab is displayed.
2. Press the F1, F2, or F3 key located just below the tab to select it.
3. Press the up/down arrows to select the desired parameter.
4. Press ✓ to open the list or modify the parameter.
5. In the list, press the up/down arrows to select the function or mode.

OR

Use the alphanumeric keypad to enter the value you want to specify.

6. Press ✓ to confirm the selection.

Connection Setup for DSL/IP Triple-Play Verification Tests

Setup Line Connection

Thresholds

The **Thresholds** tab allows you to specify upper and lower thresholds against which the actual measured unit/DSLAM negotiated results will be evaluated. The described **Selected Profile** is composed of the current **LineMode** and **AccessMode** selections. If **LineMode** is set to **Ethernet**, this tab is unavailable.

The available parameters are the following:

- **Min. Actual Bit Rate(kbps)** is minimum actual bit rate, **DownStream** and **UpStream**. Measured values must be greater than these limits.

For **DownStream**:

- If **LineMode** is set to **ADSL2+**, valid values are 0 through 25000, with a default value of 100.
- If **LineMode** is set to **VDSL2-STGR**, **VDSL2-ALCL**, or **Auto-DSL**, valid values are 0 through 100000, with a default value of 12000.

For **UpStream**:

- If **LineMode** is set to **ADSL2+**, valid values are 0 through 1000, with a default value of 100.
- If **LineMode** is set to **VDSL2-STGR**, **VDSL-ALCL**, or **AUTO-DSL**, valid values are 0 through 80000, with a default value of 6000.
- **Min. SNR Margin(dB)** is minimum signal-to-noise ratio margin **DownStream** and **UpStream** where valid values range from 0 through 63.5, with a default value of 5.
- **Max. Attenuation(dB)** is maximum attenuation **DownStream** and **UpStream** where valid values range from 0 through 128.0, with a default value of 10.

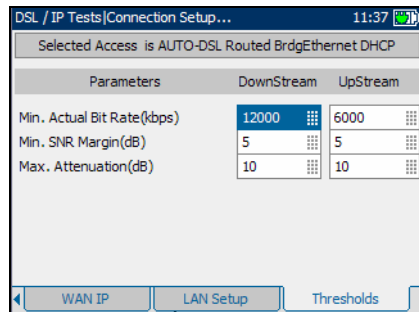

To select the thresholds parameters to configure:

- 1.** From the **Connection Setup** pane, press the left/right function arrows until the **Thresholds** tab is displayed.
- 2.** Press the F1, F2, or F3 key located just below the tab to select it.
- 3.** Press the up/down arrows to select the desired parameter.
- 4.** Press ✓ to modify the parameter.
- 5.** Use the alphanumeric keypad to enter the value you want to specify.
- 6.** Press ✓ to confirm the selection.

11 **Configure Tests for DSL/IP Triple-Play Verification**

The purpose of the **Configure Tests** function is to modify the unit to include and perform various tests for the applications to be verified. These tests are accessible through the different pane tabs.

To access the configuration panes for DSL/IP tests:

1. From the **DSL/IP Tests** menu pane, use the up/down arrows to select the **Configure Tests** entry and press **✓** to confirm the selection.
 2. Select **Configure DSL/IP Tests**
- OR
3. **Configure HPNA Analysis** if the option for HPNA is enabled. Please see the ARU-100 User Guide or Quick Reference Guide for more information.

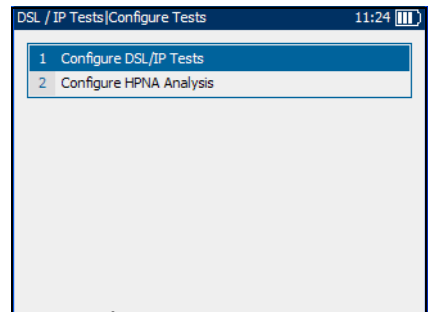

To view the available tabs:

Press the left/right function arrows on each side of the F1, F2, and F3 keys.

Configure Profile

Before configuring all the line test parameters, you can refer to previously saved profiles for both DSL/IP tests and HPNA Analysis.

Select Configuration

The **Select Config** tab in the **Configure DSL/Tests** function allows you to setup and store multiple profiles containing specific configuration parameters for the unit. At power up, all test configuration parameters are read from the last current test configuration.

- **Read from File** allows you to view a list of previously saved profiles with the first entry being **Default**.
- **Save to File** allows you to save test parameters to a default profile or a new custom file name.

To select test configuration parameters to be used during DSL/IP tests:

1. From the **Select Config** tab pane, use the up/down arrows to highlight an old or new configuration file name.
2. Press ✓ to confirm the selection.
3. Press the left arrow to highlight the **Read from File** button.
4. Press ✓ to confirm the selection.
5. Press the up/down arrows to highlight the text edit box.
6. Use the alphanumeric keypad to enter a custom profile name.
7. Press the left arrow to highlight the **Save to File** button to save the configured profile.

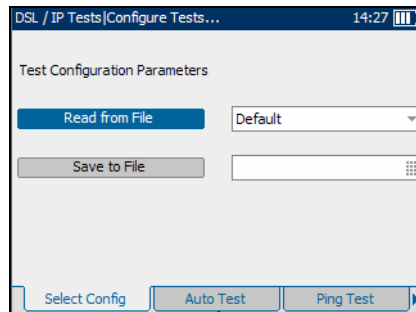

Configure DSL/IP Tests

Auto Test

The purpose of the Auto Test function is to:

- Establish a connection to the DSLAM
- Log into an ISP
- Perform a Ping test

The **Auto Test** tab allows you to select a series of tests to be configured in the Auto Test procedure.

Your choice of tests to **Enable** or **Disable** are the following:

- **IPTV Analysis** runs an auto test for video. When this entry is enabled, all other test-choice entries on the **Auto Test** pane are automatically disabled.
- **Data Analysis** runs an auto test for data by enabling the unit to act as a modem, allowing you to connect from your computer to the internet via the unit's Ethernet port. When this entry is enabled, all other test-choice entries on the **Auto Test** pane are automatically disabled.
- **VoIP Analysis** runs an auto test for voice. When this entry is enabled, all other test-choice entries on the **Auto Test** pane are automatically disabled.
- **CPE Ping Test** checks the ICMP echo request during the auto test. When this entry is enabled, **IPTV**, **Data** and **VoIP** analyses are automatically disabled.

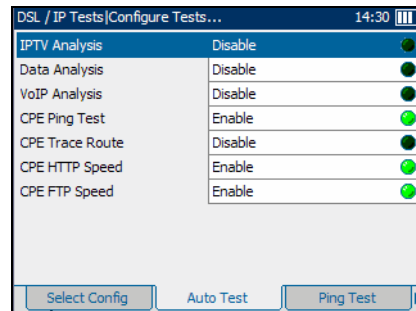

Configure Tests for DSL/IP Triple-Play Verification

Configure DSL/IP Tests

- **CPE Trace Route** reports the status of IP packets being sent to a specified IP destination, and the path and time taken to do so, in auto test. When this entry is enabled, **IPTV, Data** and **VoIP** analyses are automatically disabled.
- **CPE HTTP Speed** measures the speed of downloading Web pages, in auto test. When this entry is enabled, **IPTV, Data** and **VoIP** analyses are automatically disabled.
- **CPE FTP Speed** measures the speed of the file transfer protocol download, in auto test. When this entry is enabled, **IPTV, Data** and **VoIP** analyses are automatically disabled.

To select the tests to include:

1. Press the up/down arrows to highlight a desired test.
2. Press  to toggle between **Enable** or **Disable**.
3. Select other tests as required.

Ping Test

The **Ping Test** tab allows you to configure the parameters to perform a ping test, also known as an ICMP echo request, during the **Manual Test**.

The available parameters are the following:

- **Destination Address** lists **Gateway** (default) so that the unit can ping the gateway into auto test, or **IP Address** or **URL**.
- **URL/IP Address** is the destination IP address of the device actively connected to the network.
- **Packet Size** is a value from 32 through 1500 of the number of bytes sent in one packet. The default value is 32.
- **Total Pings** is the total number of ping packets to send out from 1 through 99. The default value is 3.
- **Timeout** is the time in seconds from 1 through 15, that the unit will wait for a response back from the destination device. The default value is 1.
- **Max hops** is the number of hops from 1 through 99, that the unit will attempt to reach a destination IP address. The default value is 32.

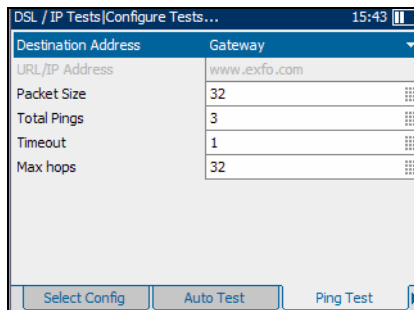

To select the ping parameters to configure:

1. Press the up/down arrows to select the desired parameter.
2. Press ✓ to open the list or modify the parameter.
3. In the list, press the up/down arrows to select the function or mode.

OR

Use the alphanumeric keypad to enter the value you want to specify.

4. Press ✓ to confirm the selection.

Configure Tests for DSL/IP Triple-Play Verification

Configure DSL/IP Tests

TraceRoute

The **TraceRoute** tab allows you to trace an IP packet from the unit (or a computer) to a specified IP destination and define how many hops the packet requires to reach the destination. This test is useful in determining where the longest delays are occurring along the network path.

The available parameters are the following:

- **Address Format** lists the address either as a **URL** or **IP Address**.
- **Destination Address** is the destination IP address.
- **Max hops** is a value from 1 through 99 specifying the maximum number of hops to be used in attempting to reach the destination IP address. The default value is 32.

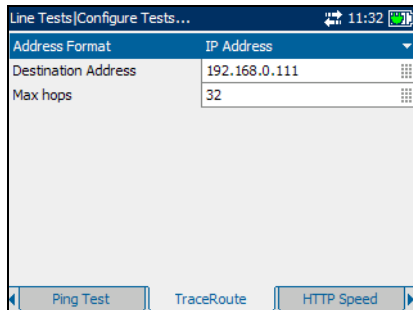

To select the traceroute parameters to configure:

1. Press the up/down arrows to select the desired parameter.
2. Press **✓** to open the list or modify the parameter.
3. In the list, press the up/down arrows to select the function or mode.

OR

Use the alphanumeric keypad to enter the value you want to specify.

4. Press **✓** to confirm the selection.

HTTP Speed

The **HTTP Speed** tab allows you to enter the **Download Address** which is the destination IP address or Web site URL to be downloaded (depending on the test selected) from the http server.

To select the download parameter to configure:

1. Press the up/down arrows to select the desired parameter.
2. Press ✓ to modify the parameter.
3. Use the alphanumeric keypad to enter the value you want to specify.
4. Press ✓ to confirm the selection.

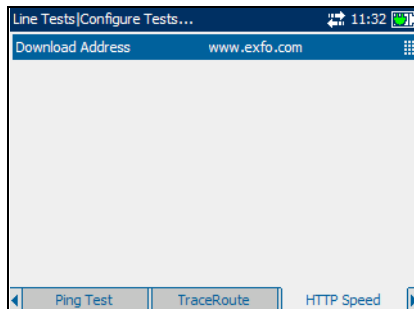

Configure Tests for DSL/IP Triple-Play Verification

Configure DSL/IP Tests

FTP Speed

The **FTP Speed** tab allows you to configure the file transfer protocol parameters for downloading and uploading files to the server.

The available parameters are the following:

- **Ftp Server Address** is the address of the file transfer protocol (FTP), maximum 72 characters.
- **Login ID** is your user name, maximum 72 characters. The default value is **anonymous**.
- **Password** is your user password, maximum 36 characters.
- **Download File Name** is the filename requested for downloading, maximum 128 characters; left blank if no download test is required.
- **Upload File Name** is the filename used for uploading, maximum 128 characters.
- **Upload File Size(Kbytes)** is the number of bytes or size of the file to be uploaded to the server. Valid values range from 1 through 65536.

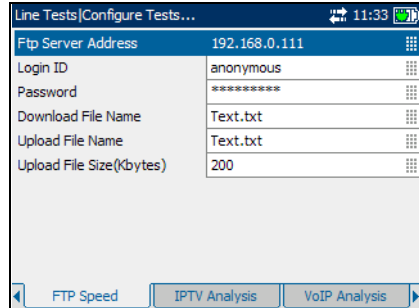

To select the FTP speed parameters to configure:

1. Press the up/down arrows to select the desired parameter.
2. Press ✓ to modify the parameter.
3. Use the alphanumeric keypad to enter the value you want to specify.
4. Press ✓ to confirm the selection.

IPTV Analysis

The **IPTV Analysis** tab allows you to configure the unit for video testing.

The parameters are the following:

- **Join Multicast Address** is the multicast address of the channel that is automatically requested to join when running the video analysis during the auto test.
- **Monitoring Interval** is a list of time interval values - **8, 16, 32, or 64 min** - to set the length of time for which data is plotted on a graph.
- **Test Thresholds** allow you to set critical quality of service (QoS) values for delivering IPTV over DSL.
 - **Max Packet Jitter (ms)** is a value in accordance with the network characteristics, ranging from 0 through 99 milliseconds, to be used as the pass or fail criteria for QoS.
 - **Max Lost Packet Ratio (%)** is a percentage of the total packet rate, ranging from 0 through 10.00, to use as pass/fail criteria for QoS.
 - **Max ZAP Time(ms)** is the time in milliseconds, ranging from 0 through 999, required for a channel change and to be considered when evaluating IPTV QoS.
 - **MAX PCR Jitter (ms)** is the short-term variation in milliseconds, ranging from 0 through 999, of the arrival of the PCR (program clock reference) information at the video decoder.
 - **Max MDI:DF (ms)** is the media delivery index (MDI) to delay factor (DF) in milliseconds, ranging from 0 through 999.
 - **Max MDI:MLR (packs/s)** is the media delivery index (MDI) to media loss rate (MLR) in packets lost per second, ranging from 0 through 999.

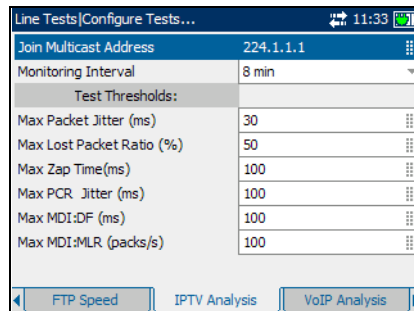

Configure Tests for DSL/IP Triple-Play Verification

Configure DSL/IP Tests

To select the IPTV analysis parameters to configure:

- 1.** Press the up/down arrows to select the desired parameter.
- 2.** Press  to open the list or modify the parameter.
- 3.** In the list, press the up/down arrows to select the function or mode.

OR

Use the alphanumeric keypad to enter the value you want to specify.

- 4.** Press  to confirm the selection.

VoIP Analysis

The **VoIP Analysis** tab allows you to configure the unit for voice over IP testing.

The parameters are the following:

- **Monitoring Interval** is a list of time interval values - **8, 16, 32, or 64 min** - to set the length of time for which data is plotted on a graph.
- **Test Thresholds** allow you to specify the thresholds against which the actual measured unit/DSLAM negotiated results will be evaluated.
 - **Max PCR Jitter (ms)** is a value in accordance with the characteristics of the network, ranging from 0 through 200 to be used as the pass or fail criteria for the quality of service (QoS).
 - **Max Lost Packet Ratio (%)** is a percentage of the total packet rate, to be used as the pass or fail criteria for the quality of service (QoS).

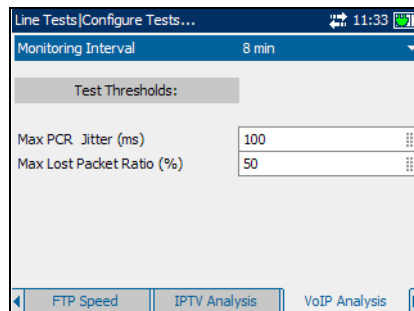

To select the VoIP analysis parameters to configure:

1. Press the up/down arrows to select the desired parameter.
2. Press **✓** to open the list or modify the parameter.
3. In the list, press the up/down arrows to select the function or mode.

OR

Use the alphanumeric keypad to enter the value you want to specify.

4. Press **✓** to confirm the selection.

Configure Tests for DSL/IP Triple-Play Verification

Configure DSL/IP Tests

Data Analysis

The **Data Analysis** tab allows you to select the **Monitoring Interval** which is a list of time interval values - **8**, **16**, **32**, or **64 min** - to set the length of time for which data is plotted on a graph.

To select the monitoring interval:

1. Press the up/down arrows to select the parameter.
2. Press ✓ to open the list.
3. In the list, press the up/down arrows to select the value.
4. Press ✓ to confirm the selection.

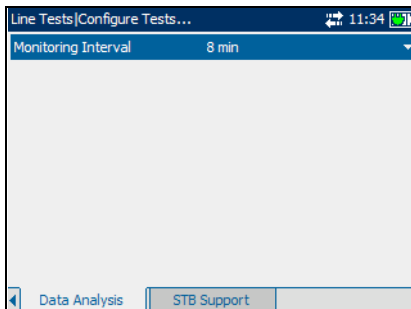

STB Support

The **STB Support** tab allows you to specify the network addresses for up to four set-top boxes to be emulated. This pane is active only for bridged access mode.

The available parameters are the following:

- **Number of STB** is the quantity of set top boxes (maximum 4) to be emulated by the unit at the testing location.
- **Obtain STB IP** is either **Dynamic** where the access concentrator or broadband remote access server assigns a temporary IP address to the set top box, or **Static** where you enter the IP address of the set top box.
- **STB Vendor ID** is the name of the set top box, maximum 80 characters. This entry is unavailable if **Obtain STB IP** is set to **Static**.
- **MAC1-4** is the MAC address for each specified set top box.
- **IP1-4** is the IP address for each set top box that has been specified.

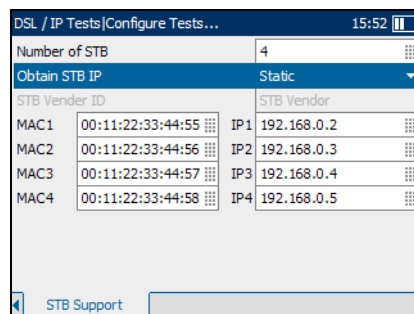

To select the STB support parameters to configure:

1. Press the up/down, left/right arrows to select the desired parameter.
2. Press ✓ to open the list or modify the parameter.
3. In the list, press the up/down arrows to select the function or mode.

OR

Use the alphanumeric keypad to enter the value you want to specify.

4. Press ✓ to confirm the selection.

12 Running Manual Tests

The purpose of the Manual Test function is to establish a connection to the DSLAM and confirm the status of the DSL line. You can then log on to an ISP to perform advanced tests, including Ping, TraceRoute, and download speed tests.

To view the available tabs:

Press the left/right function arrows on each side of the F1, F2, and F3 keys.

Reading Results

Test Summary

The **TestSummary** tab allows you to view the **PASS/FAIL** status and **Details** of a series of **Manual Test** results.

The available test results are the following:

- **Line Status** displays **Booting, Activate, Handshaking, Full Initialization to Connected** for the particular line connection under test.
- **WAN Status** displays whether the unit is **Connected** to the wide area network, or in idle mode.
- **PingTest** is also known as ICMP echo request and determines network connectivity and accessibility.
- **TraceRoute** reports the path and the time of an IP packet to reach the destination IP address.
- **HTTP Speed** allows you to evaluate the speed at which a particular Web page or URL or Web object can be downloaded by the unit.
- **FTP Speed** displays the status of whether the file transfer protocol was completed or not.

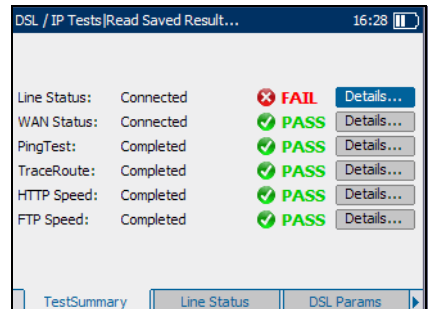

Running Manual Tests

Reading Results

- **Details** button shortcuts to the applicable tab which provides more information about a particular test result.

To view more information about each available test result:

1. Press the up/down arrows to highlight the **Details** button alongside the desired test result.
2. Press **✓** to select the desired **Details** button.

Line Status

The **Line Status** tab allows you to view the conditions of the line under test which was configured in the connection setup.

The available test results are the following:

- **Line Status** displays **Connected** when the unit and the DSLAM have successfully connected and negotiated applicable data rates for the particular connection under test. During negotiation with the DSLAM, the value changes from **Booting/Activate/Handshaking/Full Initialization** to **Connected**.
- **Operational Mode** is the DSL mode of operation as negotiated between the unit and the DSLAM.
- **CO VendorID** is a unique 4-digit alphanumeric identifier of the DSL chipset manufacturer used on the central office (CO) side.
- **CO Version** is the version number of the unique alphanumeric identifier of the DSL chipset used on the CO side.
- **Parameter** lists the **DownStream** and **UpStream** results for the following parameters:

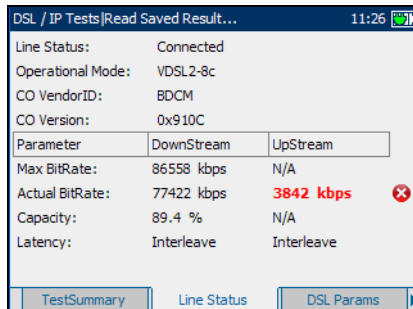

Parameter	DownStream	UpStream
Max BitRate:	86558 kbps	N/A
Actual BitRate:	77422 kbps	3842 kbps
Capacity:	89.4 %	N/A
Latency:	Interleave	Interleave

- **Max BitRate** displays the maximum attainable bit rates that the circuit can handle as determined by the remote terminal and CO during the training phase. Values can be greater than the actual bit rate.
- **Actual BitRate** displays the values at which the unit and CO are connected, as negotiated during the training phase. The values should represent what the CO was set to, unless the DSL link is being subjected to high levels of noise/crosstalk, and are typically what the DSLAM has been set to, whether interleaved or fast.
- **Capacity** is the capacity of the line as a ratio of achieved bit rate over the maximum attainable bit rate (Max BitRate) presented as a percentage (%). A high value could mean that the link is nearing its maximum capabilities while a low value could mean the link is being under utilized (sometimes intentionally – verify your local DSLAM setup).
- **Latency** is the path type, **Fast** or **Interleave**, set by the service provider at the CO. The use of the interleaved path means greater delay in the delivery of data but it is less susceptible to noise or crosstalk due to increased Reed-Solomon coding and forward error checking (FEC). The use of the fast path means little of no delay in the delivery of data but it is more susceptible to noise and crosstalk.

When set up over Ethernet, the available test results are the following:

- **Line Status** displays either **Connected** or **Disconnected** for the particular line connection under test.
- **LinkSpeed** is a choice between **AUTO** (negotiated during the link establishment), **100** or **10 Mbps**.
- **ConnectMode** is **FULL_DUP** or **HALF_DUP**, when **Link Speed** is set to either **100** or **10 Mbps**.

DSL Parameters

The **DSL Params** tab allows you to view the pass/fail status of the **DownStream** and **UpStream** parameters configured in the test setup.

The available test results are the following:

- **SNR Margin** is a value ranging from 0 through 63.5 for the minimum signal-to-noise ratio margin.
- **Attenuation** is a value ranging from 0 through 63.5 for the maximum attenuation.
- **Output Power** is the current transmit power level that is a measure of the absolute transmit power.
- **INP** is the level of impulse noise protection.
- **Interl.Depth** is interleave depth which defines the number of bits (or bytes) in each block of data.
- **Interl.Delay** is interleave delay which defines the mapping (relative spacing) between subsequent input bytes at the interleave input and their placement in the bit stream at the interleave output.

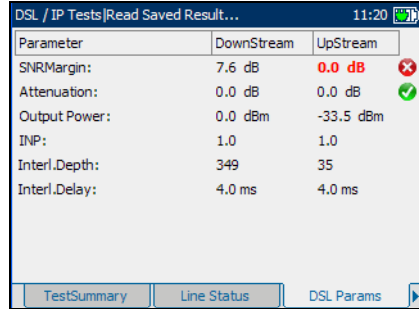

Parameter	DownStream	UpStream	
SNRMargin:	7.6 dB	0.0 dB	✘
Attenuation:	0.0 dB	0.0 dB	✔
Output Power:	0.0 dBm	-33.5 dBm	
INP:	1.0	1.0	
Interl.Depth:	349	35	
Interl.Delay:	4.0 ms	4.0 ms	

TestSummary | Line Status | DSL Params

Statistics

The **Statistics** tab allows you to view transfer mode statistics and DSL counters.

The available test results are:

- **TransportType** options include packet transfer mode (**PTM**) and asynchronous transfer mode (**ATM**).
- **SyncLostCount** is the number of times the unit lost synchronization.
- **DSL Counters** lists the **Local** and **Remote** results for the following counters:
 - **CRC** is the cyclical redundancy check (**CRC**) Interleaved/Fast counter.
 - **HEC** is the header error check (**HEC**) Interleaved/Fast counter.
 - **FEC** is the Reed Solomon forward error check (**FEC**) Interleaved/Fast counter.
 - **FEC Seconds** is the number of seconds when FEC is detected.
 - **Error Seconds** is the number of seconds when code violation is detected.
- **Reset Counters** button sets all counters to 0.

DSL / IP Tests Read Saved Result... 12:41			
TransportType:	ATM		<input type="button" value="Reset Counters"/>
SyncLostCount:	0		
ADSL Counters	Local	Remote	
CRC:	0	0	
HEC:	0	0	
FEC:	225	0	
FEC Seconds:	0	0	
Error Seconds:	0	9	
<input type="button" value="Statistics"/> <input type="button" value="VDSL Bands"/> <input type="button" value="Bits per Bin"/>			

Running Manual Tests

Reading Results

VDSL Bands

The **VDSL Bands** tab allows you to view the VDSL parameters negotiated by the unit and central office, configured in the connection setup.

The available test results are the following:

- **SNR Margin** is the measured current signal-to-noise ratio (SNR) margin across all active sub-channels, as an amount of increased noise relative to the measured noise power that the system would be able to tolerate to maintain a bit error rate of 10⁻⁷.
- **LoopAttn** is the current reduction of the line.
- **SignalAttn** is the current reduction of the signal.
- **DS0-4** button displays the downstream parameters for different VDSL bands 0 to 4.
- **US0-4** button displays the upstream parameters for different VDSL bands 0 to 4.

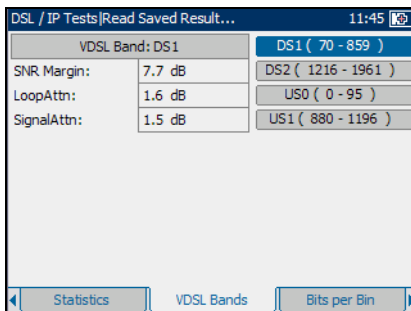

Bits per Bin

The **Bits per Bin** tab allows you to view the number of bits that can be transmitted on a particular bin representing a certain tone. The frequency of the tone equals the bin number multiplied by 4.325 kHz, except when the VDSL2 30a profile is used. For VDSL2 30a profile connection, the frequency of the tone is equal to the bin number multiplied by 8.65 kHz.

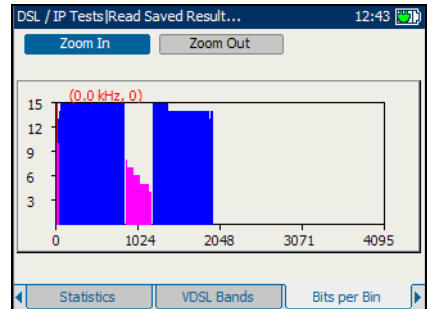

- **Zoom In** allows you to increase the level of zoom for the selected zoom function.
- **Zoom Out** allows you to reduce the level of zoom for the selected zoom function.

To zoom in or out:

1. Press the up or down arrow key to highlight the desired zoom function.
2. Press ✓ to select the zoom function.
3. Use the left or right arrow key to highlight the **Zoom In** or **Zoom Out** button as required, then press ✓.

The graphical display zooms in or out accordingly.

4. Press ✓ repeatedly to continue zooming.

WAN Status

The **WAN Status** tab allows you to view the status of the connection between the wide area network and the ISP.

The available test results are the following:

- **WAN Access** specifies the type of wide area network access, either **Bridged** or **Routed** mode.
- **Status** displays either **Connected**, **Connecting**, or **Fail** for the line connection under test.
- **Encapsulat** is the encapsulation method used by the network and consists of the following types:
 - **PPPoE** is point-to-point protocol over Ethernet.
 - **Bridged Ether DHCP** is also known as multi-protocol encapsulation over ATM (MPoA).
- **VPI** is the virtual path identifier ranging from 0 to 255 for the ATM connection. VPI is not displayed for VDSL2 connections.
- **VCI** is the virtual circuit identifier ranging from 32 to 65535 for the ATM connection. VCI is not displayed for VDSL2 connections.
- **Assigned IP** is the IP address information assigned to the unit that is actively connected to your network or the internet at the time of login.
- **Gateway** is the IP address of the default gateway.
- **Subnet Mask** is the network address used to identify if the IP address is within the same wide area network.
- **DNS1** is the address of the *primary* domain name server to be used by the unit.
- **DNS2** is the address of the *secondary* domain name server to be used by the unit.

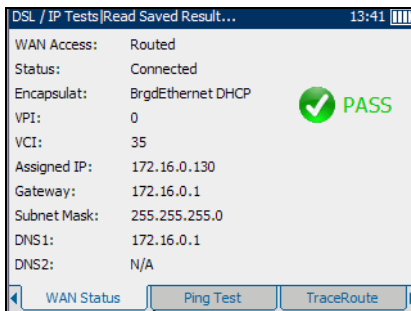

Ping Test

The **Ping Test** tab allows you to view the **PASS/FAIL** summary status of either a **Ping Address** or **Ping Gateway**.

The available test results are the following:

- **Address Format** lists either the **URL** or **IP Address** where the unit pings.
- **URL/IP Address** is the IP address (a.b.c.d) or domain name (www.abcd.com) of the destination being pinged.
- **PckSize** is the number of bytes sent in one packet ranging from 32 through 1200 (default is 32 bytes).
- **Pings** display the total number of ping requests to be sent.
- **Ping Status** is the duration in milliseconds (ms) it took the data to come back from the destination device.
- **Summary:**
 - **Packetsize** displays the size of the Ping packet as selected.
 - **Sent/Received:** shows the number of packets sent versus the number of packets received.
 - **Average round trip time** is the duration in milliseconds (ms) it took the data to reach the destination device and come back.

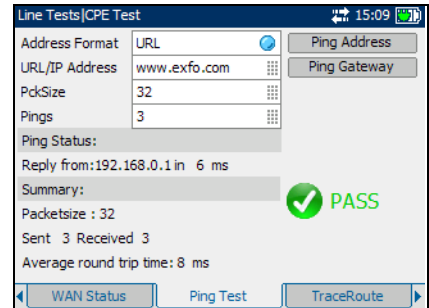

TraceRoute

The **TraceRoute** tab allows you to view the **PASS/FAIL** status of an IP packet being sent to a specified IP destination, and the path and time taken to do so.

The available test results are the following:

- **Dest.Addr.** is the destination IP or URL address.
- **Max hops** specifies the maximum number of hops used in attempting to reach the destination address.
- **Trace** button starts TraceRoute, displaying the test progress in the area below.

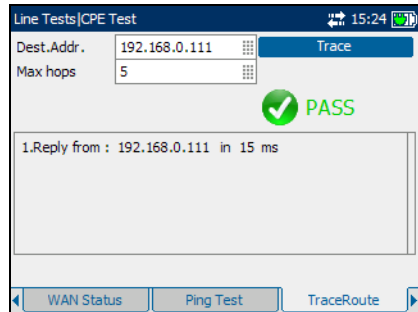

HTTP Speed

The **HTTP Speed** tab allows you to view the **PASS/FAIL** summary status of the download test configured in the **Manual Test** setup.

The available test results are the following:

- **DwnAddress** is the destination IP address or Web site that was downloaded.
- **Download** button starts the HTTP speed test, displaying the progress below.
- **Resolving Address** is the address of the **DwnAddress**.
- **Download Bytes** displays the count of bytes received.
- **Download Time** is the amount of time it took to receive the download bytes.
- **Download Speed** is the speed at which the unit is capable of downloading a Web page or content.

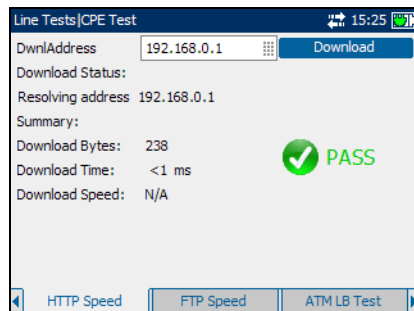

Running Manual Tests

Reading Results

FTP Speed

The **FTP Speed** tab allows you to view the **PASS/FAIL** summary status of whether or not the file transfer protocol (FTP) which was configured in the **Manual Test** setup was completed successfully or not.

The available test results are the following:

- **FTP Server** is the IP address of the connected FTP server.
- **Login Name** is your user ID.
- **Password** is your user password.
- **Download File** is the name of the file downloaded to the FTP server.

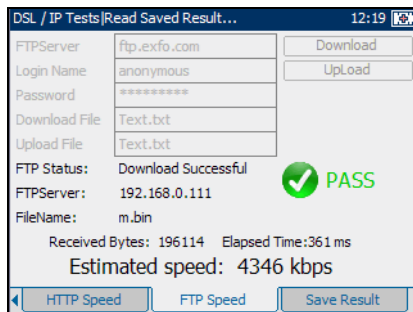

The **Download** button starts downloading the file entered here.

- **Upload File** is the name of the file uploaded to the FTP server. The file size is limited to a maximum of 64 Mb.

The **UpLoad** button starts uploading the file entered here.

- **File Name** is the name of the uploaded or downloaded file being summarized on the pane.
- **Received Bytes** displays the number of bytes that was downloaded from the FTP server.
- **Elapsed Time** is the duration in ms of downloading/uploading the file.
- **Estimated speed** is the calculated rate - number of received bytes divided by elapsed time - of downloading/uploading the file.



HPNA Info

The **HPNA Info** tab allows you to view the results of the HPNA devices detected on the network.

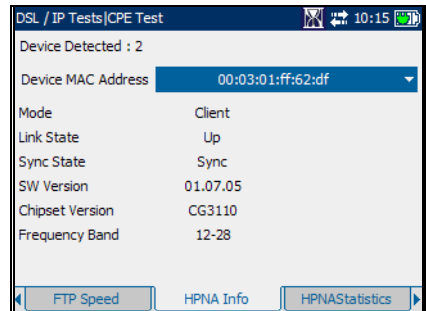
- **Device Detected** displays the total number of detected HPNA devices on the network.
- **Refresh** button allows you to rerun the DevInfo Test and update the page with new data.
- **Device MAC Address** lists all the MAC addresses for the detected HPNA devices.
- **Mode** displays **Master** or **Client** for the selected device.
- **Link State** is the **Up** to **Down** (or vice versa) routing protocol of the network link for the selected device.
- **Sync State** is the sync status of the selected device.
- **SW Version** is the software version number of the selected device.
- **Chipset Version** is the version number of the chipset for the selected device.
- **Frequency Band** displays the range of signal frequency for the selected device.



To select a detected device:

1. Press  to open the list.
2. In the list, press the up/down arrows to select the MAC address of the desired device.
3. Press  to confirm the selection and view the results.

Running Manual Tests

Reading Results

HPNA Statistics

The **HPNA Statistics** tab allows you to view counter statistics of the selected HPNA device.

- **Select Device** lists all the MAC addresses of the detected HPNA devices on the network.
- **Tx Packets** is the number of packets sent.
- **Rx Packets** is the number of packets received.
- **Tx Bytes** is the count of bytes sent.
- **Rx Bytes** is the count of bytes received.
- **Rx CRC Packets** is a count of cyclical redundancy check (CRC) errors received.
- **Tx Packets Dropped** is the number of outgoing packets dropped.
- **Rx Packets Dropped** is the number of incoming packets dropped.

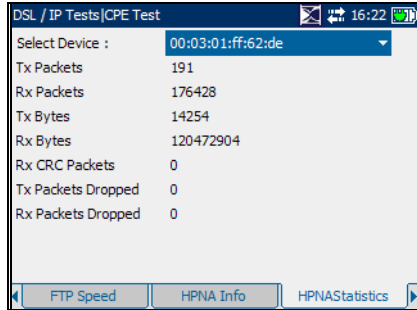

To select a MAC address:

1. Press ✓ to open the list.
2. In the list, press the up/down arrows to select the MAC address of the desired device.
3. Press ✓ to confirm the selection and view the test results.

13 IPTV Analysis

The IPTV Analysis test functionality provides all the required information for the installation, maintenance, and/or troubleshooting of video services, including IPTV, delivered over DSL.

To view the available tabs:

Press the left/right function arrows on each side of the F1, F2, and F3 keys.

Reading Results

Test Summary

The **Test Summary** tab allows you to view the **PASS/FAIL** status and **Details** of all the tests configured for the DSL and Ethernet layers over which the IPTV service is being delivered. If a measured value is out of the threshold range configured for the IPTV analysis setup, the **Test Summary** screen displays a **FAIL** message.

The available test results are the following:

- **Line Status** displays **Booting, Activate, Handshaking, Full Initialization to Connected** for the particular line connection under test.
- **WAN Status** displays whether the unit is **Connected** to the wide area network, or in idle mode.
- **IP PacketLoss** is the total number of lost video packets within the threshold range.
- **IP PacketJitter** is the variance of the real-time transport protocol (RTP) data packet inter-arrival time.

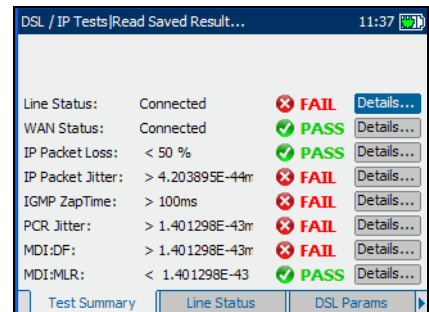

The screenshot shows a window titled "DSL / IP Tests | Read Saved Result..." with a timestamp of 11:37. It displays a table of test results with columns for the test name, the measured value, a status indicator (PASS or FAIL), and a "Details..." button.

Test Name	Value	Status	Action
Line Status:	Connected	FAIL	Details...
WAN Status:	Connected	PASS	Details...
IP Packet Loss:	< 50 %	PASS	Details...
IP Packet Jitter:	> 4.203895E-44m	FAIL	Details...
IGMP ZapTime:	> 100ms	FAIL	Details...
PCR Jitter:	> 1.401298E-43m	FAIL	Details...
MDI:DF:	> 1.401298E-43m	FAIL	Details...
MDI:MLR:	< 1.401298E-43	PASS	Details...

At the bottom of the window, there are three tabs: "Test Summary" (selected), "Line Status", and "DSL Params".

IPTV Analysis

Reading Results

- **IGMP ZAPTime** is the time required for a channel change when traffic is being transferred between the central network and STB.
- **PCR Jitter** is the short-term variation in the arrival of program clock reference (PCR) information at the video decoder.
- **MDI:DF** is the media delivery index (MDI) delay factor (DF) which monitors the amount of time the video must be delayed in the virtual buffer due to cumulative IP packet jitter and IP packetization.
- **MDI:MLR** is the media delivery index (MDI) media loss rate (MLR), which monitors the amount of media packet loss experienced per second.
- **Details** button shortcuts to the applicable tab which provides more information about a particular test result.

To view more information about each available test result:

1. Press the up/down arrows to highlight the **Details** button alongside the desired test result.
2. Press  to select the desired **Details** button.

Line Status

The **Line Status** tab allows you to view the conditions of the line under test which was configured in the connection setup.

The available test results are the following:

- **Line Status** displays **Connected** when the unit and the DSLAM have successfully connected and negotiated applicable data rates for the particular connection under test. During negotiation with the DSLAM, the value changes from **Booting/Activate/Handshaking/Full Initialization** to **Connected**.
- **Operational Mode** is the DSL mode of operation as negotiated between the unit and the DSLAM.
- **CO VendorID** is a unique 4-digit alphanumeric identifier of the DSL chipset manufacturer used on the central office (CO) side.
- **CO Version** is the version number of the unique alphanumeric identifier of the DSL chipset used on the CO side.

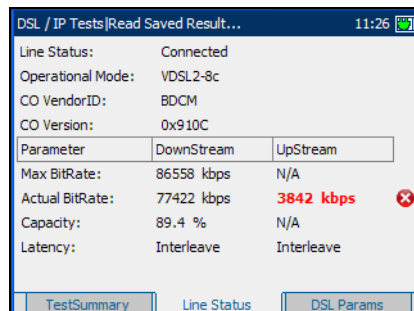

The screenshot shows a window titled "DSL / IP Tests Read Saved Result..." with a timestamp of 11:26. The window displays the following information:

Line Status:	Connected	
Operational Mode:	VDSL2-8c	
CO VendorID:	BDCM	
CO Version:	0x910C	
Parameter	DownStream	UpStream
Max BitRate:	86558 kbps	N/A
Actual BitRate:	77422 kbps	3842 kbps
Capacity:	89.4 %	N/A
Latency:	Interleave	Interleave

At the bottom of the window, there are three tabs: "TestSummary", "Line Status" (which is selected), and "DSL Params".

- **Parameter** lists the **DownStream** and **UpStream** results for the following parameters:
 - **Max BitRate** displays the maximum attainable bit rates that the circuit can handle as determined by the remote terminal and CO during the training phase. Values can be greater than the actual bit rate.
 - **Actual BitRate** displays the values at which the unit and CO are connected, as negotiated during the training phase. The values should represent what the CO was set to, unless the DSL link is being subjected to high levels of noise/crosstalk, and are typically what the DSLAM has been set to, whether interleaved or fast.
 - **Capacity** is the capacity of the line as a ratio of achieved bit rate over the maximum attainable bit rate (Max BitRate) presented as a percentage (%). A high value could mean that the link is nearing its maximum capabilities while a low value could mean the link is being under utilized (sometimes intentionally – verify your local DSLAM setup).
 - **Latency** is the path type, **Fast** or **Interleave**, set by the service provider at the CO. The use of the interleaved path means greater delay in the delivery of data but it is less susceptible to noise or crosstalk due to increased Reed-Solomon coding and forward error checking (FEC). The use of the fast path means little of no delay in the delivery of data but it is more susceptible to noise and crosstalk.

When set up over Ethernet, the available test results are the following:

- **Line Status** displays either **Connected** or **Disconnected** for the particular line connection under test.
- **LinkSpeed** is a choice between **AUTO** (negotiated during the link establishment), **100** or **10 Mbps**.
- **ConnectMode** is **FULL_DUP** or **HALF_DUP**, when **Link Speed** is set to either **100** or **10 Mbps**.

DSL Parameters

The **DSL Params** tab allows you to view the pass/fail status of the **DownStream** and **UpStream** parameters configured in the test setup.

The available test results are the following:

- **SNR Margin** is a value ranging from 0 through 63.5 for the minimum signal-to-noise ratio margin.
- **Attenuation** is a value ranging from 0 through 63.5 for the maximum attenuation.
- **Output Power** is the current transmit power level that is a measure of the absolute transmit power.
- **INP** is the level of impulse noise protection.
- **Interl.Depth** is interleave depth which defines the number of bits (or bytes) in each block of data.
- **Interl.Delay** is interleave delay which defines the mapping (relative spacing) between subsequent input bytes at the interleave input and their placement in the bit stream at the interleave output.

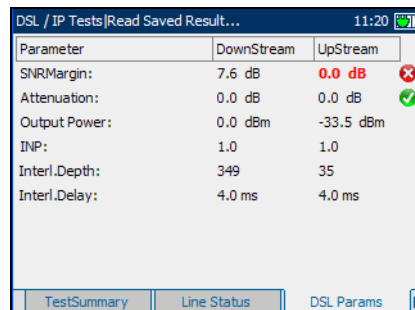

Parameter	DownStream	UpStream	
SNRMargin:	7.6 dB	0.0 dB	✘
Attenuation:	0.0 dB	0.0 dB	✔
Output Power:	0.0 dBm	-33.5 dBm	
INP:	1.0	1.0	
Interl.Depth:	349	35	
Interl.Delay:	4.0 ms	4.0 ms	

Statistics

The **Statistics** tab allows you to view transfer mode statistics and DSL counters.

The available test results are:

- **TransportType** options include packet transfer mode (**PTM**) and the asynchronous transfer mode (**ATM**).
- **SyncLostCount** is the number of times the unit lost synchronization.
- **DSL Counters** lists the **Local** and **Remote** results for the following counters:
 - **CRC** is the cyclical redundancy check (**CRC**) Interleaved/Fast counter.
 - **HEC** is the header error check (**HEC**) Interleaved/Fast counter.
 - **FEC** is the Reed Solomon forward error check (**FEC**) Interleaved/Fast counter.
 - **FEC Seconds** is the number of seconds when FEC is detected.
 - **Error Seconds** is the number of seconds when code violation is detected.
- **Reset Counters** button sets all counters to 0.

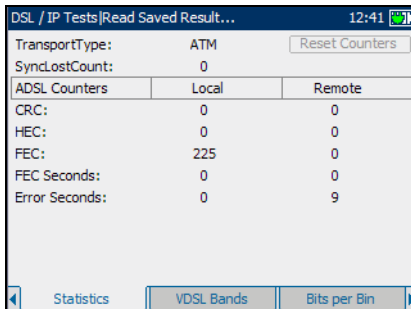

The screenshot shows a window titled "DSL / IP Tests | Read Saved Result..." with a timestamp of 12:41. It displays the following information:

- TransportType: ATM (with a "Reset Counters" button)
- SyncLostCount: 0
- ADSL Counters table:

ADSL Counters	Local	Remote
CRC:	0	0
HEC:	0	0
FEC:	225	0
FEC Seconds:	0	0
Error Seconds:	0	9

At the bottom, there are three tabs: "Statistics" (selected), "VDSL Bands", and "Bits per Bin".

VDSL Bands

The **VDSL Bands** tab allows you to view the VDSL parameters negotiated by the unit and central office, configured in the connection setup.

The available test results are the following:

- **SNR Margin** is the measured current signal-to-noise ratio (SNR) margin across all active sub-channels, as an amount of increased noise relative to the measured noise power that the system would be able to tolerate to maintain a bit error rate of 10⁻⁷.
- **LoopAttn** is the current reduction of the line.
- **SignalAttn** is the current reduction of the signal.
- **DS0-4** button displays the downstream parameters for different VDSL bands 0 to 4.
- **US0-4** button displays the upstream parameters for different VDSL bands 0 to 4.

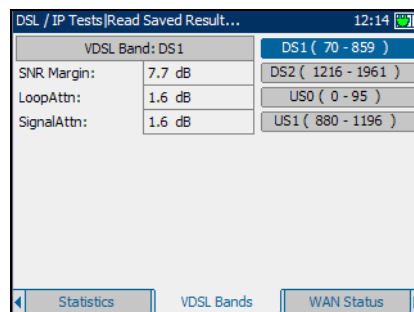

WAN Status

The **WAN Status** tab allows you to view the status of the connection between the wide area network and the ISP.

The available test results are the following:

- **WAN Access** specifies the type of wide area network access, either **Bridged** or **Routed** mode.
- **Status** displays either **Connected**, **Connecting**, or **Fail** for the line connection under test.
- **Encapsulat** is the encapsulation method used by the network and consists of the following types.
 - **PPPoE** is point-to-point protocol over Ethernet.
 - **Bridged Ether DHCP** is also known as multi-protocol encapsulation over ATM (MPoA).
- **VPI** is the virtual path identifier ranging from 0 to 255 for the ATM connection. VPI is not displayed for VDSL2 connections.
- **VCI** is the virtual circuit identifier ranging from 32 to 65535 for the ATM connection. VCI is not displayed for VDSL2 connections.
- **Assigned IP** is the IP address information assigned to the unit that is actively connected to your network or the internet at the time of login.
- **Gateway** is the IP address of the default gateway.
- **Subnet Mask** is the network address used to identify if the IP address is within the same wide area network.
- **DNS1** is the address of the *primary* domain name server to be used by the unit.
- **DNS2** is the address of the *secondary* domain name server to be used by the unit.

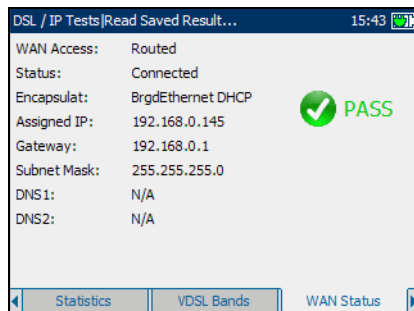

LAN Status

The **LAN Status** tab allows you to view the **Customer Info** configured for the local area network (LAN).

The available information is as follows:

- **STB IP address** is the IP address of the set-top box (STB) connected to the LAN port.
- **STB MAC address** is the MAC address of the STB connected to the LAN port.
- **Subnet Mask** is the network address used to identify if the IP address is within the same local area network.
- **Gateway** is the IP address of the default gateway.

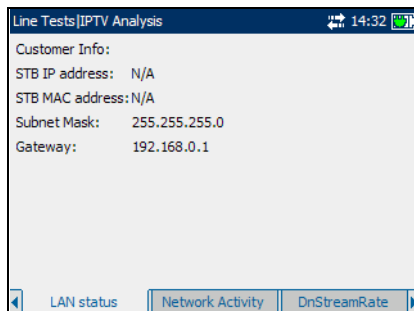

Network Activity

The **Network Activity** tab allows you to view the **PPPoE** (point-to-point protocol over Ethernet), **DHCP** (dynamic host configuration protocol) and **TFTP** (trivial file transfer protocol) mode sessions resulting from the video tests.

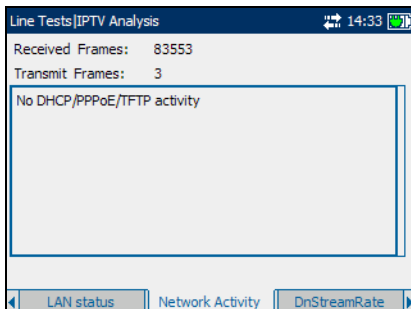

Down Stream Rate

The **DnStreamRate** tab allows you to view the bit rates of different layers related to the IPTV service.

The available test results are the following:

- **Line Rate** is the actual rate achieved by the circuit, in kbps.
- **Ave IP Bit Rate** is the average IP data rate for the IPTV service, including all channels detected.
- **Reset Statistics** button sets all monitoring values to 0.

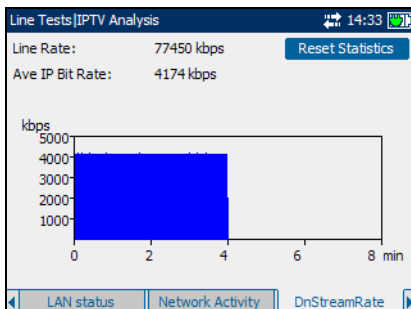

ERR Indicator

The **ERR Indicator** tab allows you to view the errors encountered at the different layers related to the IPTV service.

The available test results are the following:

- **DSL CRC errors/ADSL Errs** displays a count of frames lost at the DSL layer.
- **FEC frame counters/FEC Cnt** displays the number of forward error correction (**FEC**) frames that have been rectified by the Reed-Solomon error correction. When in the “fast” setting, the result will be 0. This parameter is useful for determining if a problem exists based on how many frames required correction.
- **ATM HECError/ATM Errs** display a count of frames lost at the transfer mode layer.
- **IP Packet/Pck Loss** is the number of packets lost, with errors, or out of sequence, during the test period.
- **Loss Ratio** is the percentage of IP packet loss during a one second period.
- **Reset Statistics** button sets all monitoring values to 0.

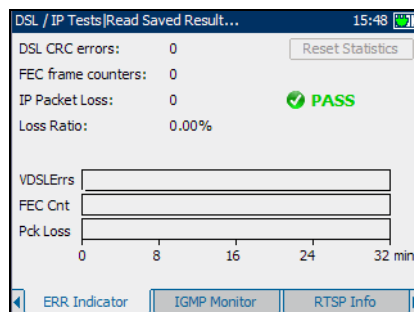

IGMP Monitor

The **IGMP Monitor** tab allows you to confirm that IGMP traffic is being transferred between the central network and STB, and view the statistics.

The available statistics are the following:

- **Queries** counts the number of IGMP queries issued by the network.
- **Join Request** is the number of unsolicited IGMP “joins” issued by the STB or the user.
- **Leave Request** is the number of IGMP “leaves” issued by the STB or the user.
- **Last Request** displays the multicast addresses for **Join/Leave** channels.
- **zap time(ms)** is the time required for a channel change or join, and is one of the key factors to be considered when evaluating the IPTV quality of service (QoS).

To start/stop reporting:

1. To have the STB send an IGMP report with the multicast IP address, press **Join**.
2. To inform the network to stop sending the current stream, press **Leave**.

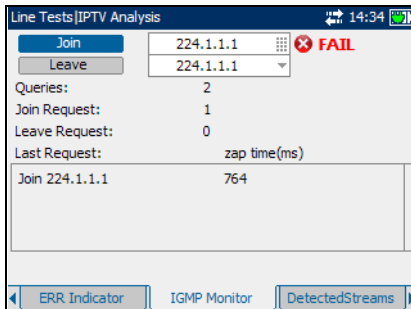

RTSP Info

The **RTSP Info** tab allows you to view the media stream sessions established by the real time streaming protocol (RTSP).

The available test results are the following:

- **RTSP Stream** is the IP address of the last RTSP server port.
- **Status** displays a message for the condition of the last RTSP.
- **Res Time** is the response time in ms from video request to incoming video data.
- **StatCode** displays the RTSP status codes defined as follows:
 - 100 - Continue
 - 200 - OK
 - 201 - Created
 - 250 - Low on Storage Space
 - 300 - Multiple Choices
 - 301 - Moved Permanently
 - 302 - Moved Temporarily
 - 303 - See Other
 - 304 - Not Modified
 - 305 - Use Proxy
 - 400 - Bad Request
 - 401 - Unauthorized
 - 402 - Payment Required
 - 403 - Forbidden
 - 404 - Not Found
 - 405 - Method Not Allowed

RTSP Stream	Status	Res Time/StatCode
192.168.0.111:554	Detected	212 ms
192.168.0.111:554	RTSP	200
192.168.0.111:554	PLAY	
192.168.0.111:554	RTSP	200
192.168.0.111:554	SETUP	
192.168.0.111:554	RTSP	200
192.168.0.111:554	DESCRIBE	
192.168.0.111:554	RTSP	200

Navigation buttons: ERR Indicator, IGMP Monitor, RTSP Info

IPTV Analysis

Reading Results

- 406 - Not Acceptable
- 407 - Proxy Authentication Required
- 408 - Request Time-out
- 410 - Gone
- 411 - Length Required
- 412 - Precondition Failed
- 413 - Request Entity Too Large
- 414 - Request-URI Too Large
- 415 - Unsupported Media Type
- 451 - Parameter Not Understood
- 452 - Conference Not Found
- 453 - Not Enough Bandwidth
- 454 - Session Not Found
- 455 - Method Not Valid in This State
- 456 - Header Field Not Valid for Resource
- 457 - Invalid Range
- 458 - Parameter Is Read-Only
- 459 - Aggregate operation not allowed
- 460 - Only aggregate operation allowed
- 461 - Unsupported transport
- 462 - Destination unreachable
- 463 - Key management Failure
- 500 - Internal Server Error
- 501 - Not Implemented
- 502 - Bad Gateway
- 503 - Service Unavailable
- 504 - Gateway Time-out
- 505 - RTSP Version not supported
- 551 - Option not supported

Detected Streams

The **DetectedStreams** tab allows you to view the details of detected video streams.

The available test results are the following:

- **Show Details** button, when pressed, displays a detailed description of the stream including from and to IP addresses and port numbers.
- **Stream IP** is the multicast IP address assigned to a specific channel.
- **Type** describes the video stream as:
 - **RTSP**: video on demand (VOD) or live TV streaming over connection based on RTP/RTSP/TCP or RTSP/TCP.
 - **Unicast**: unicast streaming over connection based on UDP or RTP/UDP.
 - **Multicast**: multicast streaming based on UDP or RTP/UDP.
- **Rates** is the IP packet rate in Kbps for this video stream.
- **Usage** is the percentage of total bandwidth being used by this particular video stream.

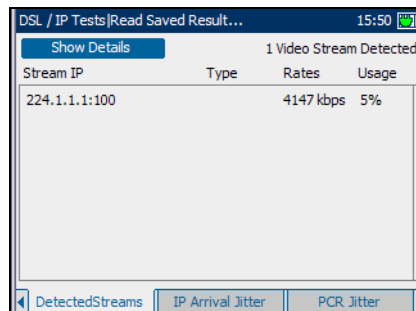

Stream IP	Type	Rates	Usage
224.1.1.1:100		4147 kbps	5%

IP Arrival Jitter

The **IP Arrival Jitter** tab allows you to view the **PASS/FAIL** status of the registered **IP Packet Jitter** for the video stream with a selected multicast IP address assigned to the specific video channel or **Analyzed Stream**.

The available test results are the following:

- **Max Recorded Jitter** is the maximum jitter detected, in **ms**.
- **Average Jitter** is the continuous running average of the jitter detected, in **ms**.
- **Standard Deviation** is based on the continuous sample size.
- **Reset Statistics** button clears all monitoring values.

The default monitoring interval is 8 minutes.

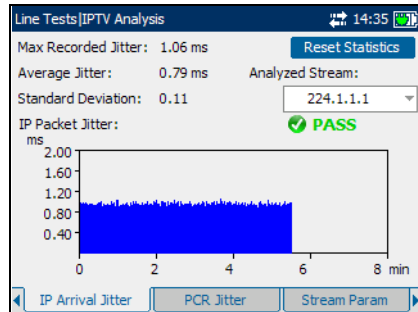

PCR Jitter

The **PCR Jitter** tab allows you to view the **PASS/FAIL** status of the **Peak to Peak PCR Jitter** for the short-term variation in the arrival of the program clock reference (PCR) information at the video decoder.

The available test results are the following:

- **PCR Packets Rate** is the number of received packets monitored over a one-second period.
- **Average Jitter** is the continuous running average of the jitter detected, measured in ms.
- **Analyzed Stream** is the multicast IP address assigned to the specific video channel.
- **Standard Deviation** is based on the continuous sample size.
- **Reset Statistics** button clears all monitoring values.

The default monitoring interval is 8 minutes.

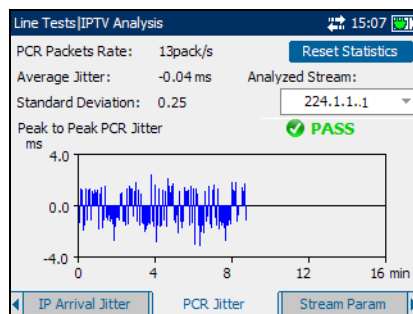

Stream Parameters

The **Stream Param** tab allows you to view the detected video **Stream Rates** and the **PASS/FAIL** status of the multicast IP address assigned to the specific video channel or **Analyzed Stream**.

The available test results are the following:

- **IP Packet** is the IP data rate for the IPTV service, for the selected channel.
- **Transport Rate** is the bit rate calculated based on the program clock reference (PCR).
- **Null Packet Rate** is the rate calculated for MPEG2-TS null packets. Null packets are defined as having no data.
- **MDI** is the media delivery index (MDI) or IP cumulative jitter and packet loss rate for the video stream.
- **DF(Ave)** is the average delay factor (DF) or the average amount of time the video must be delayed in the virtual buffer due to cumulative IP packet jitter and IP packetization.
- **DF(Min)** is the minimum delay factor (DF) or the minimum amount of time the video must be delayed in the virtual buffer due to cumulative IP packet jitter and IP packetization.
- **DF(Max)** is the maximum delay factor (DF) or the maximum amount of time the video must be delayed in the virtual buffer due to cumulative IP packet jitter and IP packetization.
- **VB(Min)** is the minimum virtual buffer (VB).
- **VB(Max)** is the maximum virtual buffer (VB).

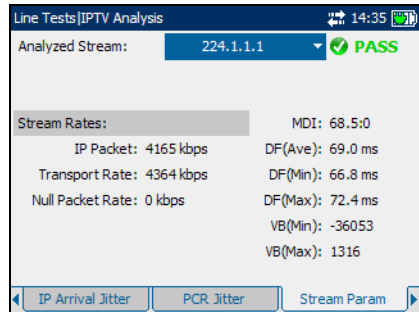

Stream Content

The **Stream Content** tab allows you to view statistical information about the **Video**, **Audio** and **Program Association/Map Table(s)** content for each MPEG video **Analyzed Stream**.

The available statistical results are the following:

- **PID** is a unique integer value or packet identifier (PID) that indicates the type of data that is stored in the packet payload of the video stream.
- **Rate(kbps)** is the rate calculated for a given stream.

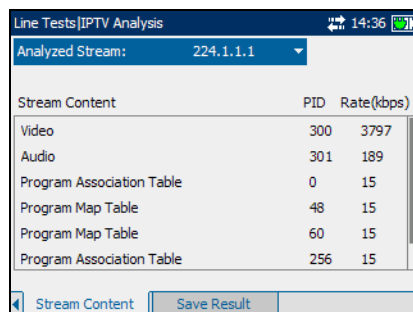

Stream Content	PID	Rate(kbps)
Video	300	3797
Audio	301	189
Program Association Table	0	15
Program Map Table	48	15
Program Map Table	60	15
Program Association Table	256	15

HPNA Info

The **HPNA Info** tab allows you to view the results of the HPNA devices detected on the network.

- **Device Detected** displays the total number of detected HPNA devices on the network.
- **Refresh** button allows you to rerun the DevInfo Test and update the page with new data.
- **Device MAC Address** lists all the MAC addresses for the detected HPNA devices.

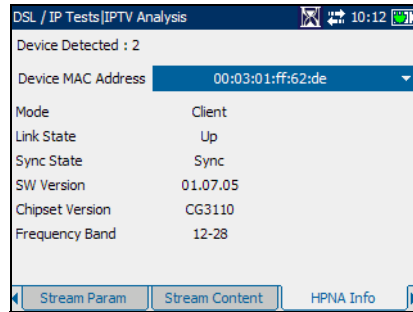

- **Mode** displays **Master** or **Client** for the selected device.
- **Link State** is the **Up** to **Down** (or vice versa) routing protocol of the network link for the selected device.
- **Sync State** is the sync status of the selected device.
- **SW Version** is the software version number of the selected device.
- **Chipset Version** is the version number of the chipset for the selected device.
- **Frequency Band** displays the range of signal frequency for the selected device.

To select a detected device:

1. Press ✓ to open the list.
2. In the list, press the up/down arrows to select the MAC address of the desired device.
3. Press ✓ to confirm the selection and view the results.

HPNA Statistics

The **HPNA Statistics** tab allows you to view counter statistics of the selected HPNA device.

- **Select Device** lists all the MAC addresses of the detected HPNA devices on the network.
- **Tx Packets** is the number of packets sent.
- **Rx Packets** is the number of packets received.
- **Tx Bytes** is the count of bytes sent.
- **Rx Bytes** is the count of bytes received.
- **Rx CRC Packets** is a count of cyclical redundancy check (CRC) errors received.
- **Tx Packets Dropped** is the number of outgoing packets dropped.
- **Rx Packets Dropped** is the number of incoming packets dropped.

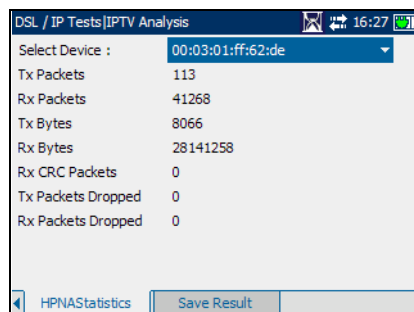

DSL / IP Tests IPTV Analysis	
Select Device :	00:03:01:ff:f6:2:de
Tx Packets	113
Rx Packets	41268
Tx Bytes	8066
Rx Bytes	28141258
Rx CRC Packets	0
Tx Packets Dropped	0
Rx Packets Dropped	0

HPNAStatistics Save Result

To select a MAC address:

1. Press ✓ to open the list.
2. In the list, press the up/down arrows to select the MAC address of the desired device.
3. Press ✓ to confirm the selection and view the results.

14 Data Analysis

The purpose of the Data Analysis test function is to have the unit act as a DSL modem allowing you to connect from your computer to the internet via the unit's Ethernet port. The unit will display the connected DSLAM parameters as well as bandwidth utilization, statistics for the IP traffic, and the different protocols detected as you send and receive information.

To view the available tabs:

Press the left/right function arrows on each side of the F1, F2, and F3 keys.

Reading Results

Test Summary

The **Test Summary** tab allows you to view the **PASS/FAIL** status and **Details** of the different tests. If a measured value is out the thresholds configured in the data analysis setup, or if the WAN/LAN connection was not completed successfully, the **Test Summary** pane will display a **FAIL** message.

The available test results are the following:

- **Line Status** displays **Booting, Activate, Handshaking, Full Initialization to Connected** for the particular line connection under test.
- **WAN Status** displays whether the unit is **Connected** to the wide area network, or in idle mode.
- **LAN Status** displays if the unit is **Connected** to the local area network.
- **IP Packets** provides a summary of the total amount of data received (being addressed to) and sent by a specific device on the local network.

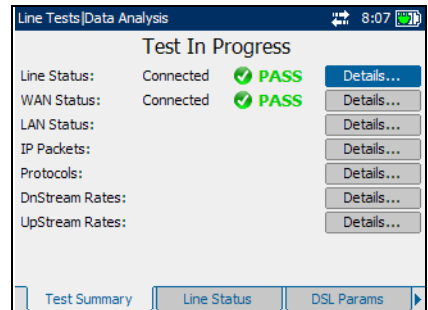

Data Analysis

Reading Results

- **Protocols** presents a summary of the different protocols used by the local network devices.
- **DnStream Rates** displays whether the maximum attainable downstream bit rate that the circuit can handle is within the threshold range.
- **UpStream Rates** displays whether the maximum attainable upstream bit rate that the circuit can handle is within the threshold range.
- **Details** button shortcuts to the applicable tab which provides more information about a particular test result.

To view more information about each available test result:

1. Press the up/down arrows to highlight the **Details** button alongside the desired test result.
2. Press  to select the desired **Details** button.

Line Status

The **Line Status** tab allows you to view the conditions of the line under test which was configured in the connection setup.

The available test results are the following:

- **Line Status** displays **Connected** when the unit and the DSLAM have successfully connected and negotiated applicable data rates for the particular connection under test. During negotiation with the DSLAM, the value changes from **Booting/Activate/Handshaking/Full Initialization** to **Connected**.
- **Operational Mode** is the DSL mode of operation as negotiated between the unit and the DSLAM.
- **CO VendorID** is a unique 4-digit alphanumeric identifier of the DSL chipset manufacturer used on the central office (CO) side.
- **CO Version** is the version number of the unique alphanumeric identifier of the DSL chipset used on the CO side.

Parameter	DownStream	UpStream
Max BitRate:	26664 kbps	1423 kbps
Actual BitRate:	24447 kbps	1023 kbps
Capacity:	91.7 %	71.9 %
Latency:	Fast	Fast

Data Analysis

Reading Results

- **Parameter** lists the **DownStream** and **UpStream** results for the following parameters:
 - **Max BitRate** displays the maximum attainable bit rates that the circuit can handle as determined by the remote terminal and CO during the training phase. Values can be greater than the actual bit rate.
 - **Actual BitRate** displays the values at which the unit and CO are connected, as negotiated during the training phase. The values should represent what the CO was set to, unless the DSL link is being subjected to high levels of noise/crosstalk, and are typically what the DSLAM has been set to, whether interleaved or fast.
 - **Capacity** is the capacity of the line as a ratio of achieved bit rate over the maximum attainable bit rate (Max BitRate) presented as a percentage (%). A high value could mean that the link is nearing its maximum capabilities while a low value could mean the link is being under utilized (sometimes intentionally – verify your local DSLAM setup).
 - **Latency** is the path type, **Fast** or **Interleave**, set by the service provider at the CO. The use of the interleaved path means greater delay in the delivery of data but it is less susceptible to noise or crosstalk due to increased Reed-Solomon coding and forward error checking (FEC). The use of the fast path means little of no delay in the delivery of data but it is more susceptible to noise and crosstalk.

When set up over Ethernet, the available test results are the following:

- **Line Status** displays either **Connected** or **Disconnected** for the particular line connection under test.
- **LinkSpeed** is a choice between **AUTO** (negotiated during the link establishment), **100** or **10 Mbps**.
- **ConnectMode** is **FULL_DUP** or **HALF_DUP**, when **Link Speed** is set to either **100** or **10 Mbps**.

DSL Parameters

The **DSL Params** tab allows you to view the pass/fail status of the **DownStream** and **UpStream** parameters configured in the test setup.

The available test results are the following:

- **SNR Margin** is a value ranging from 0 through 63.5 for the minimum signal-to-noise ratio margin.
- **Attenuation** is a value ranging from 0 through 63.5 for the maximum attenuation.
- **Output Power** is the current transmit power level that is a measure of the absolute transmit power.
- **INP** is the level of impulse noise protection.
- **Interl.Depth** is interleave depth which defines the number of bits (or bytes) in each block of data.
- **Interl.Delay** is interleave delay which defines the mapping (relative spacing) between subsequent input bytes at the interleave input and their placement in the bit stream at the interleave output.

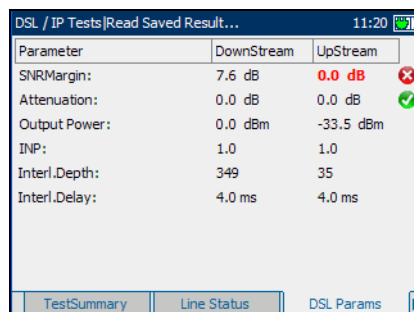

Parameter	DownStream	UpStream	
SNRMargin:	7.6 dB	0.0 dB	✘
Attenuation:	0.0 dB	0.0 dB	✔
Output Power:	0.0 dBm	-33.5 dBm	
INP:	1.0	1.0	
Interl.Depth:	349	35	
Interl.Delay:	4.0 ms	4.0 ms	

Statistics

The **Statistics** tab allows you to view transfer mode statistics and DSL counters.

The available test results are:

- **TransportType** options include packet transfer mode (**PTM**) and is the asynchronous transfer mode (**ATM**).
- **SyncLostCount** is the number of times the unit lost synchronization.
- **DSL Counters** lists the **Local** and **Remote** results for the following counters:
 - **CRC** is the cyclical redundancy check (**CRC**) Interleaved/Fast counter.
 - **HEC** is the header error check (**HEC**) Interleaved/Fast counter.
 - **FEC** is the Reed Solomon forward error check (**FEC**) Interleaved/Fast counter.
 - **FEC Seconds** is the number of seconds when FEC is detected.
 - **Error Seconds** is the number of seconds when code violation is detected.
- **Reset Counters** button sets all counters to 0.

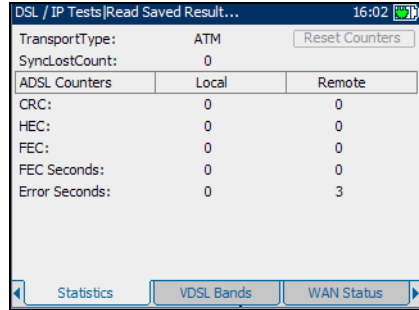

VDSL Bands

The **VDSL Bands** tab allows you to view the VDSL parameters negotiated by the unit and central office, configured in the connection setup.

The available test results are the following:

- **SNR Margin** is the measured current signal-to-noise ratio (SNR) margin across all active sub-channels, as an amount of increased noise relative to the measured noise power that the system would be able to tolerate to maintain a bit error rate of 10⁻⁷.
- **LoopAttn** is the current reduction of the line.
- **SignalAttn** is the current reduction of the signal.
- **DS0-4** button displays the downstream parameters for different VDSL bands 0 to 4.
- **US0-4** button displays the upstream parameters for different VDSL bands 0 to 4.

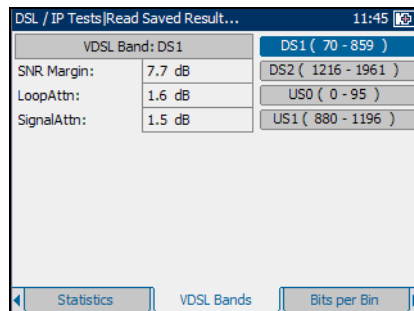

WAN Status

The **WAN Status** tab allows you to view the status of the connection between the wide area network and the ISP.

The available test results are the following:

- **WAN Access** specifies the type of wide area network access, either **Bridged** or **Routed** mode.
- **Status** displays either **Connected**, **Connecting**, or **Fail** for the line connection under test.
- **Encapsulat** is the encapsulation method used by the network and consists of the following types.
 - **PPPoE** is point-to-point protocol over Ethernet.
 - **Bridged Ether DHCP** is also known as multi-protocol encapsulation over ATM (MPoA).
- **VPI** is the virtual path identifier ranging from 0 to 255 for the ATM connection. VPI is not displayed for VDSL2 connections.
- **VCI** is the virtual circuit identifier ranging from 32 to 65535 for the ATM connection. VCI is not displayed for VDSL2 connections.
- **Assigned IP** is the IP address information assigned to the unit that is actively connected to your network or the internet at the time of login.
- **Gateway** is the IP address of the default gateway.
- **Subnet Mask** is the network address used to identify if the IP address is within the same wide area network.
- **DNS1** is the address of the *primary* domain name server to be used by the unit.
- **DNS2** is the address of the *secondary* domain name server to be used by the unit.

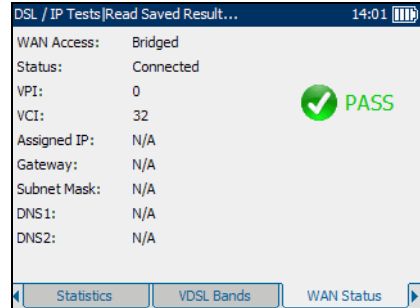

LAN Status

The **LAN Status** tab allows you to view the customer information configured for the local area network (LAN).

The available information is as follows:

- **Client IP** is the IP address of the network device connected to the LAN port.
- **Client MAC Addr** is the MAC address of the network device connected to the LAN port.
- **LAN IP** is the local network IP address of the unit.
- **LAN SubMask** is the network address mask used to identify if the IP address is within the same local area network.

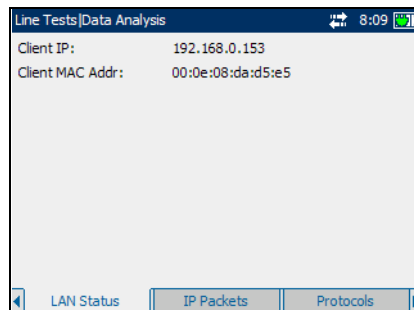

IP Packets

The **IP Packets** tab allows you to view the IP traffic statistics summary of the total amount of data **Received** (being addressed to) and sent (**Transmit**) for each **Client IP** address.

- **Client IP** the source IP address of the different requests.
- **Reset Statistics** button clears all monitoring information.

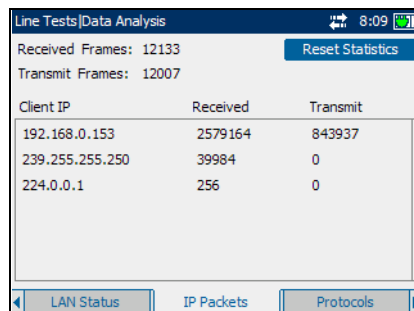

Protocols

The **Protocols** tab allows you to view a summary of the different protocols detected by the local network devices.

The screen identifies the source IP address (**Client IP Address**) of the different requests, as well as the amount of transmitted (**Download**) and received (**Upload**) information.

Protocols are displayed in reverse order with the most recent activity first.

Protocol Filter lists the different types of protocols that can be monitored such as: **RTP**, **SIP**, **MGCP**, **SCCP**, and **HTTP**.

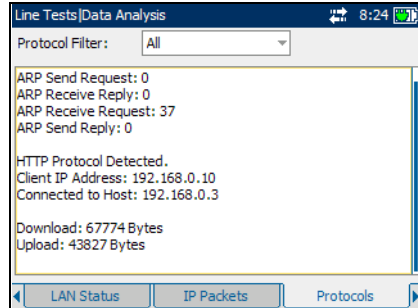

Down Stream Rates

The **DnStream Rates** tab allows you to view the maximum achieved downstream data rates for the data stream layers of the connection.

The available test results are the following:

- **DSL Rate (kbps)** is the actual downstream rate for the DSL layer.
- **Max DownStream Rate (kbps)** is the maximum downstream rate of the data stream for the connection.
- **Reset Statistics** button sets all monitoring values to 0.

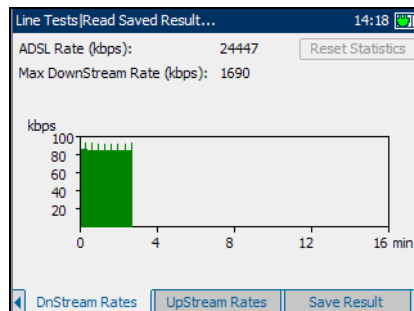

Up Stream Rates

The **UpStream Rates** tab allows you to view the maximum achieved upstream data rates for the data stream layers of the connection.

The available test results are the following:

- **DSL Rate (kbps)** is the actual upstream rate for the DSL layer.
- **Max UpStream Rate (kbps)** is the maximum upstream rate of the data stream for the connection.
- **Reset Statistics** button sets all monitoring values to 0.

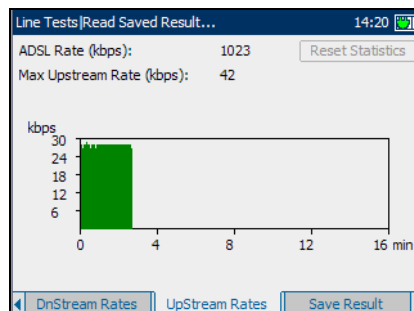

HPNA Info

The **HPNA Info** tab allows you to view the results of the HPNA devices detected on the network.

- **Device Detected** displays the total number of detected HPNA devices on the network.
- **Refresh** button allows you to rerun the DevInfo Test and update the page with new data.
- **Device MAC Address** lists all the MAC addresses for the detected HPNA devices.

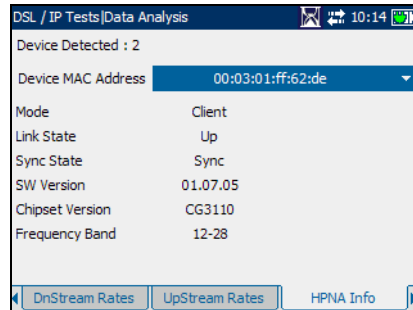

- **Mode** displays **Master** or **Client** for the selected device.
- **Link State** is the **Up** to **Down** (or vice versa) routing protocol of the network link for the selected device.
- **Sync State** is the sync status of the selected device.
- **SW Version** is the software version number of the selected device.
- **Chipset Version** is the version number of the chipset for the selected device.
- **Frequency Band** displays the range of signal frequency for the selected device.

To select a detected device:

1. Press ✓ to open the list.
2. In the list, press the up/down arrows to select the MAC address of the desired device.
3. Press ✓ to confirm the selection and view the results.

HPNA Statistics

The **HPNA Statistics** tab allows you to view counter statistics of the selected HPNA device.

- **Select Device** lists all the MAC addresses of the detected HPNA devices on the network.
- **Tx Packets** is the number of packets sent.
- **Rx Packets** is the number of packets received.
- **Tx Bytes** is the count of bytes sent.
- **Rx Bytes** is the count of bytes received.
- **Rx CRC Packets** is a count of cyclical redundancy check (CRC) errors received.
- **Tx Packets Dropped** is the number of outgoing packets dropped.
- **Rx Packets Dropped** is the number of incoming packets dropped.

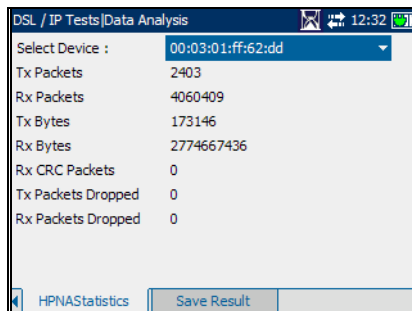

The screenshot shows a window titled "DSL / IP Tests | Data Analysis" with a timestamp of 12:32. It displays a list of statistics for a selected device with MAC address 00:03:01:ff:62:dd. The statistics are as follows:

Select Device :	00:03:01:ff:62:dd
Tx Packets	2403
Rx Packets	4060409
Tx Bytes	173146
Rx Bytes	2774667436
Rx CRC Packets	0
Tx Packets Dropped	0
Rx Packets Dropped	0

At the bottom of the window, there are two buttons: "HPNAStatistics" and "Save Result".

To select a MAC address:

1. Press ✓ to open the list.
2. In the list, press the up/down arrows to select the MAC address of the desired device.
3. Press ✓ to confirm the selection and view the results.

15 Running a VoIP Test

The purpose of the VoIP analysis test function is to allow you to configure the unit for VoIP testing. During the analysis, the unit determines the DSL and IP packet rate, and calculates jitter, packet loss, and packet delay. Results are displayed on the following tabs.

To view the available tabs:

Press the left/right function arrows on each side of the F1, F2, and F3 keys.

Reading Results

Summary

The **Summary** tab allows you to view the **PASS/FAIL** status and **Details** of the different tests. If a measured value is out the thresholds configured in the VoIP analysis setup, or if the WAN/LAN connection was not completed successfully, the **Summary** pane will display a **FAIL** message.

The available test results are the following:

- **Line Status** displays **Booting, Activate, Handshaking, Full Initialization to Connected** for the particular line connection under test.
- **WAN Status** displays whether the unit is **Connected** to the wide area network, or in idle mode.
- **LAN Status** displays if the unit is **Connected** to the local area network.
- **Network Activity** displays whether or not voice protocol registration activity is detected.
- **Call History** specifies the signaling protocol being used and determines the state of the call along with the call flow.
- **Pcks Analysis** displays the status of the percentage of packets of varying inter-arrival rates that are within 10 milliseconds of each other.

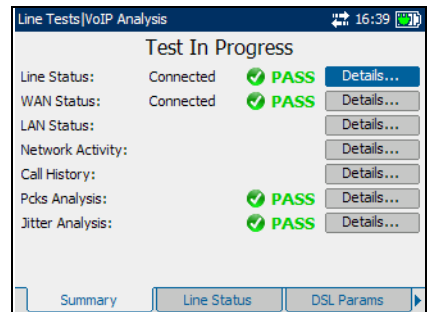

Running a VoIP Test

Reading Results

- **Jitter Analysis** is the status of the quality of the call by displaying an estimate of the variance of the real-time transport protocol (RTP) data packet inter-arrival time.
- **Details** button shortcuts to the applicable tab which provides more information about a particular test result.

To view more information about each available test result:

1. Press the up/down arrows to highlight the **Details** button alongside the desired test result.
2. Press  to select the desired **Details** button.

Line Status

The **Line Status** tab allows you to view the conditions of the line under test which was configured in the connection setup.

The available test results are the following:

- **Line Status** displays **Connected** when the unit and the DSLAM have successfully connected and negotiated applicable data rates for the particular connection under test. During negotiation with the DSLAM, the value changes from **Booting/Activate/Handshaking/Full Initialization** to **Connected**.

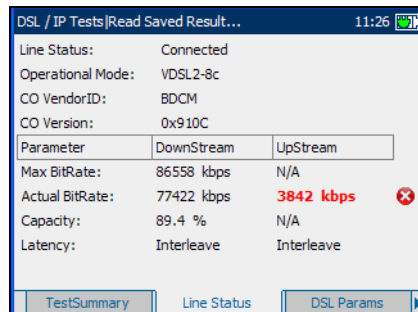

Parameter	DownStream	UpStream
Max BitRate:	86558 kbps	N/A
Actual BitRate:	77422 kbps	3842 kbps
Capacity:	89.4 %	N/A
Latency:	Interleave	Interleave

- **Operational Mode** is the DSL mode of operation as negotiated between the unit and the DSLAM.
- **CO VendorID** is a unique 4-digit alphanumeric identifier of the DSL chipset manufacturer used on the central office (CO) side.
- **CO Version** is the version number of the unique alphanumeric identifier of the DSL chipset used on the CO side.

- **Parameter** lists the **DownStream** and **UpStream** results for the following parameters:
 - **Max BitRate** displays the maximum attainable bit rates that the circuit can handle as determined by the remote terminal and CO during the training phase. Values can be greater than the actual bit rate.
 - **Actual BitRate** displays the values at which the unit and CO are connected, as negotiated during the training phase. The values should represent what the CO was set to, unless the DSL link is being subjected to high levels of noise/crosstalk, and are typically what the DSLAM has been set to, whether interleaved or fast.
 - **Capacity** is the capacity of the line as a ratio of achieved bit rate over the maximum attainable bit rate (Max BitRate) presented as a percentage (%). A high value could mean that the link is nearing its maximum capabilities while a low value could mean the link is being under utilized (sometimes intentionally – verify your local DSLAM setup).
 - **Latency** is the path type, **Fast** or **Interleave**, set by the service provider at the CO. The use of the interleaved path means greater delay in the delivery of data but it is less susceptible to noise or crosstalk due to increased Reed-Solomon coding and forward error checking (FEC). The use of the fast path means little of no delay in the delivery of data but it is more susceptible to noise and crosstalk.

When set up over Ethernet, the available test results are the following:

- **Line Status** displays either **Connected** or **Disconnected** for the particular line connection under test.
- **LinkSpeed** is a choice between **AUTO** (negotiated during the link establishment), **100** or **10 Mbps**.
- **ConnectMode** is **FULL_DUP** or **HALF_DUP**, when **Link Speed** is set to either **100** or **10 Mbps**.

Running a VoIP Test

Reading Results

DSL Parameters

The **DSL Params** tab allows you to view the pass/fail status of the **DownStream** and **UpStream** parameters configured in the test setup.

The available test results are the following:

- **SNR Margin** is a value ranging from 0 through 63.5 for the minimum signal-to-noise ratio margin.
- **Attenuation** is a value ranging from 0 through 63.5 for the maximum attenuation.
- **Output Power** is the current transmit power level that is a measure of the absolute transmit power.
- **INP** is the level of impulse noise protection.
- **Interl.Depth** is interleave depth which defines the number of bits (or bytes) in each block of data.
- **Interl.Delay** is interleave delay which defines the mapping (relative spacing) between subsequent input bytes at the interleave input and their placement in the bit stream at the interleave output.

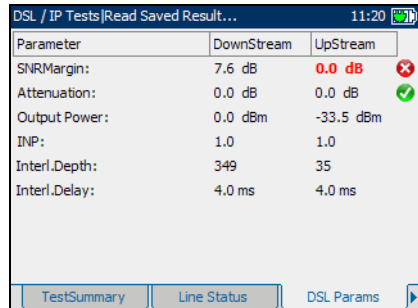

Parameter	DownStream	UpStream	
SNRMargin:	7.6 dB	0.0 dB	✘
Attenuation:	0.0 dB	0.0 dB	✔
Output Power:	0.0 dBm	-33.5 dBm	
INP:	1.0	1.0	
Interl.Depth:	349	35	
Interl.Delay:	4.0 ms	4.0 ms	

TestSummary | Line Status | DSL Params

Statistics

The **Statistics** tab allows you to view transfer mode statistics and DSL counters.

The available test results are:

- **TransportType** options include packet transfer mode (**PTM**) and is the asynchronous transfer mode (**ATM**).
- **SyncLostCount** is the number of times the unit lost synchronization.
- **Received Bytes** is the number of active (non-idle) PTM/ATM cells or frames received on a channel.
- **Transmit Bytes** records the number of active (non-idle) PTM/ATM cells or frames transmitted on a channel.
- **DSL Counters** lists the **Local** and **Remote** results for the following counters:
 - **CRC** is the cyclical redundancy check (**CRC**) Interleaved/Fast counter.
 - **HEC** is the header error check (**HEC**) Interleaved/Fast counter.
 - **FEC** is the Reed Solomon forward error check (**FEC**) Interleaved/Fast counter.
 - **FEC Seconds** is the number of seconds when FEC is detected.
 - **Error Seconds** is the number of seconds when code violation is detected.
- **Reset Counters** button sets all counters to 0.

DSL / IP Tests Read Saved Result... 12:41		
TransportType:	ATM <input type="button" value="Reset Counters"/>	
SyncLostCount:	0	
ADSL Counters	Local	Remote
CRC:	0	0
HEC:	0	0
FEC:	225	0
FEC Seconds:	0	0
Error Seconds:	0	9

Navigation: Statistics | VDSL Bands | Bits per Bin

Running a VoIP Test

Reading Results

VDSL Bands

The **VDSL Bands** tab allows you to view the VDSL parameters negotiated by the unit and central office, configured in the connection setup.

The available test results are the following:

- **SNR Margin** is the measured current signal-to-noise ratio (SNR) margin across all active sub-channels, as an amount of increased noise relative to the measured noise power that the system would be able to tolerate to maintain a bit error rate of 10⁻⁷.
- **LoopAttn** is the current reduction of the line.
- **SignalAttn** is the current reduction of the signal.
- **DS0-4** button displays the downstream parameters for different VDSL bands 0 to 4.
- **US0-4** button displays the upstream parameters for different VDSL bands 0 to 4.

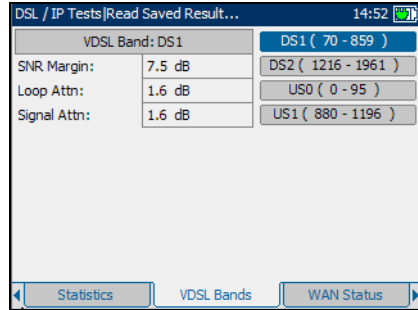

WAN Status

The **WAN Status** tab allows you to view the status of the connection between the wide area network and the ISP.

The available test results are the following:

- **WAN Access** specifies the type of WAN access, either **Bridged** or **Routed** mode.
- **Status** displays either **Connected**, **Connecting**, or **Fail** for the line connection under test.
- **Encapsulat** is the encapsulation method used by the network and consists of four types.
 - **PPPoE** is point-to-point protocol over Ethernet.
 - **Bridged Ether DHCP** is also known as multi-protocol encapsulation over ATM (MPoA).
- **VPI** is the virtual path identifier ranging from 0 to 255 for the ATM connection. VPI is not displayed for VDSL2 connections.
- **VCI** is the virtual circuit identifier ranging from 32 to 65535 for the ATM connection. VCI is not displayed for VDSL2 connections.
- **Assigned IP** is the IP address information assigned to the unit that is actively connected to your network or the internet at the time of login.
- **Gateway** is the IP address of the default gateway.
- **Subnet Mask** is the network address used to identify if the IP address is within the same wide area network.
- **DNS1** is the address of the *primary* domain name server to be used by the unit.
- **DNS2** is the address of the *secondary* domain name server to be used by the unit.

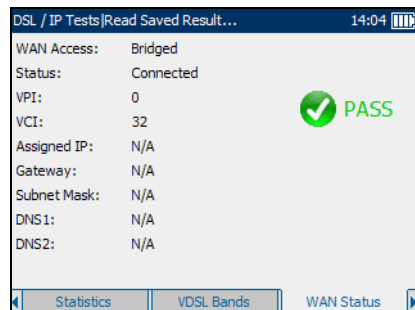

Running a VoIP Test

Reading Results

LAN Status

The **LAN Status** tab allows you to view the customer information configured for the local area network (LAN).

The available information is as follows:

- **Client IP** is the IP address of the network device connected to the LAN port.
- **Client MAC Addr** is the MAC address of the network device connected to the LAN port.
- **LAN IP** is the local network IP address of the unit.
- **LAN SubMask** is the network address mask used to identify if the IP address is within the same local area network.

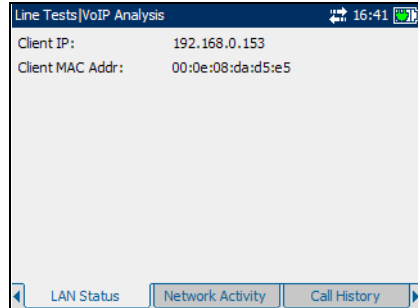

Network Activity

The **Network Activity** tab allows you to view the **PPoE** (Point-to-Point Protocol over Ethernet), **DHCP** (Dynamic Host Configuration Protocol) and **TFTP** (Trivial File Transfer Protocol) mode sessions resulting from the voice tests. It displays whether or not registration activity for the voice protocol is detected.

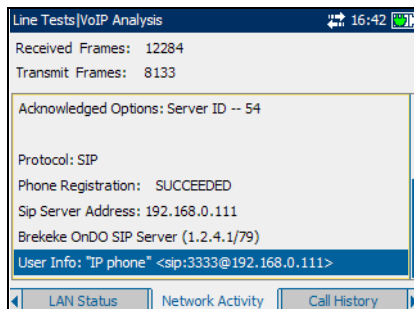

SIP (Session Initiation Protocol) is a signalling protocol used for establishing sessions in an IP network.

Call History

The **Call History** tab allows you to view the detailed call flow of the detected voice protocol. **SIP** (Session Initiation Protocol) is a signalling protocol used for establishing sessions in an IP network.

The **Clear History** button clears all information displayed.

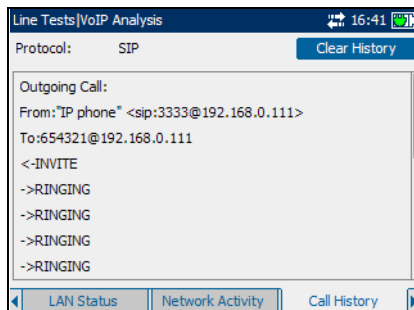

Running a VoIP Test

Reading Results

Packets Analysis

The **Pcks Analysis** tab allows you to view the **PASS/FAIL** status of the percentage of packets of varying inter-arrival rates that are within 10 milliseconds of each other.

The available test results are the following:

- **Codec** is the VoIP coder/decoder in use as detected by the unit.
- **Received Packets** display the total number of received VoIP packets.
- **Lost Packet** is the total number of lost VoIP packets that were never received during the conversation.
- **Dupl/OOS Packet** is the total number of duplicated (Dupl) or out of sequence (OOS) packets.
- **Invalid Packet(%)** represents a QoS reference factor of lost packets detected during the VoIP conversation.
- **Reset Statistics** button sets all monitoring values to 0.

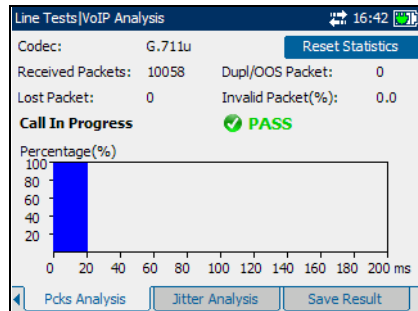

Jitter Analysis

The **Jitter Analysis** tab allows you to view the **PASS/FAIL** status of the quality of the call by displaying an estimate of the variance of the real-time transport protocol (RTP) data packet inter-arrival time.

The available test results are:

- **Jitter Average** is the continuous running average jitter.
- **Jitter Maximum** is the maximum jitter detected.
- **Std. Deviation** is the standard deviation based on the continuous sample size.
- **Reset Statistics** button sets all monitoring values to 0.

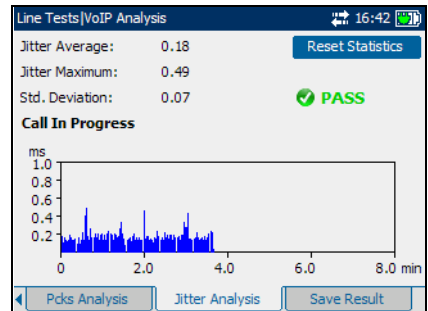

HPNA Info

The **HPNA Info** tab allows you to view the results of the HPNA devices detected on the network.

- **Device Detected** displays the total number of detected HPNA devices on the network.
- **Refresh** button allows you to rerun the DevInfo Test and update the page with new data.
- **Device MAC Address** lists all the MAC addresses for the detected HPNA devices.

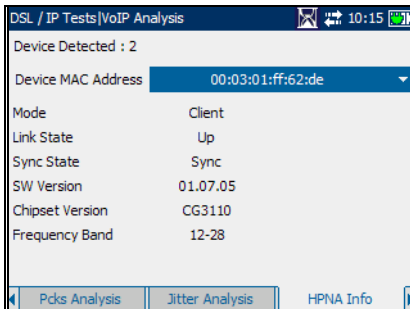

- **Mode** displays **Master** or **Client** for the selected device.
- **Link State** is the **Up** to **Down** (or vice versa) routing protocol of the network link for the selected device.
- **Sync State** is the sync status of the selected device.
- **SW Version** is the software version number of the selected device.
- **Chipset Version** is the version number of the chipset for the selected device.
- **Frequency Band** displays the range of signal frequency for the selected device.

To select a detected device:

1. Press ✓ to open the list.
2. In the list, press the up/down arrows to select the MAC address of the desired device.
3. Press ✓ to confirm the selection and view the results.

HPNA Statistics

The **HPNA Statistics** tab allows you to view counter statistics of the selected HPNA device.

- **Select Device** lists all the MAC addresses of the detected HPNA devices on the network.
- **Tx Packets** is the number of packets sent.
- **Rx Packets** is the number of packets received.
- **Tx Bytes** is the count of bytes sent.
- **Rx Bytes** is the count of bytes received.
- **Rx CRC Packets** is a count of cyclical redundancy check (CRC) errors received.
- **Tx Packets Dropped** is the number of outgoing packets dropped.
- **Rx Packets Dropped** is the number of incoming packets dropped.

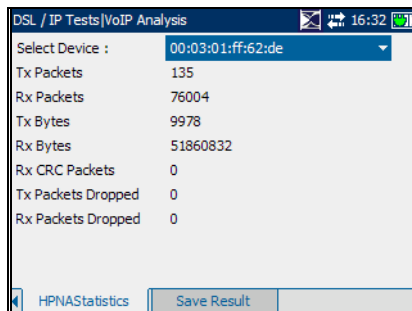

The screenshot shows a window titled "DSL / IP Tests | VoIP Analysis" with a timestamp of 16:32. It displays a table of statistics for a selected device with MAC address 00:03:01:ff:f6:2e. The statistics are as follows:

Statistic	Value
Select Device :	00:03:01:ff:f6:2e
Tx Packets	135
Rx Packets	76004
Tx Bytes	9978
Rx Bytes	51860832
Rx CRC Packets	0
Tx Packets Dropped	0
Rx Packets Dropped	0

At the bottom of the window, there are two buttons: "HPNAStatistics" and "Save Result".

To select a MAC address:

1. Press ✓ to open the list.
2. In the list, press the up/down arrows to select the MAC address of the desired device.
3. Press ✓ to confirm the selection and view the results.

16 *Maintenance*

General Maintenance

To help ensure long, trouble-free operation:

- Keep the unit free of dust.
- Clean the unit casing and front panel with a cloth slightly dampened with water.
- Store unit at room temperature in a clean and dry area. Keep the unit out of direct sunlight.
- Avoid high humidity or significant temperature fluctuations.
- Avoid unnecessary shocks and vibrations.
- If any liquids are spilled on or into the unit, turn off the power immediately and let the unit dry completely.



WARNING

Use of controls, adjustments, and procedures for operation and maintenance other than those specified herein may result in hazardous radiation exposure.

Battery Charging and Replacing

Charging the AXS-200/635i battery can take up to 1.5 hours. This battery was custom made for your unit; replacement batteries must be ordered from EXFO.

For more information about the battery, refer to the *Maintenance* chapter of the AXS-200 User Guide.

Maintenance

Recycling and Disposal (Applies to European Union Only)

Recycling and Disposal (Applies to European Union Only)



Recycle or dispose of your product (including electric and electronic accessories) properly, in accordance with local regulations. Do not dispose of it in ordinary garbage receptacles.

This equipment was sold after August 13, 2005 (as identified by the black rectangle).





- Unless otherwise noted in a separate agreement between EXFO and a customer, distributor, or commercial partner, EXFO will cover costs related to the collection, treatment, recovery, and disposal of end-of-lifecycle waste generated by electronic equipment introduced after August 13, 2005 to an European Union member state with legislation regarding Directive 2002/96/EC.
- Except for reasons of safety or environmental benefit, equipment manufactured by EXFO, under its brand name, is generally designed to facilitate dismantling and reclamation.

For complete recycling/disposal procedures and contact information, visit the EXFO Web site at www.exfo.com/recycle.

17 Troubleshooting

Solving Common Problems

The table below presents common problems and their solution.

Problem	Possible Cause	Solution
Impossible to turn on unit.	<ul style="list-style-type: none"> ➤ You did not press  long enough. ➤ Main batteries discharged. ➤ Battery compartment door is open. ➤ One of the two batteries is missing. ➤ Weather too cold. 	<ul style="list-style-type: none"> ➤ Press  for 2 seconds. ➤ Charge batteries by connecting the AC adapter/charger. ➤ Close battery compartment door. ➤ Insert 2 batteries and replace battery compartment door.
The display is almost blank when you turn on the unit.	Brightness may need some adjustment.	Press  to adjust brightness properly.
Batteries do not charge as expected.	<ul style="list-style-type: none"> ➤ Temperature is too high. ➤ Battery is incorrectly connected. 	<ul style="list-style-type: none"> ➤ Ensure temperature is within specifications. ➤ Ensure battery is connected properly.
A battery status LED is yellow.	Battery is defective.	Contact EXFO or replace the battery.
The unit is not responding.		<p>Shut down the unit by pressing  and holding it down.</p> <p>You will hear a first beep; release the key after you hear a second beep.</p> <p>Turn the unit on again to reset it.</p>

Troubleshooting

Contacting the Technical Support Group

Contacting the Technical Support Group

To obtain after-sales service or technical support for this product, contact EXFO at one of the following numbers. The Technical Support Group is available to take your calls from Monday to Friday, 8:00 a.m. to 7:00 p.m. (Eastern Time in North America).

For detailed information about technical support, visit the EXFO Web site at www.exfo.com.

Technical Support Group

400 Godin Avenue
Quebec (Quebec) G1M 2K2
CANADA

1 866 683-0155 (USA and Canada)
Tel.: 1 418 683-5498
Fax: 1 418 683-9224
support@exfo.com

To accelerate the process, please have information such as the name and the serial number (see the product identification label—an example is shown below), as well as a description of your problem, close at hand.



AXS-635i-XX-XX-XX

DSL modules
DSL software options
Copper software options

Transportation

Maintain a temperature range within specifications when transporting the unit. Transportation damage can occur from improper handling. The following steps are recommended to minimize the possibility of damage:

- Pack the unit in its original packing material when shipping.
- Avoid high humidity or large temperature fluctuations.
- Keep the unit out of direct sunlight.
- Avoid unnecessary shocks and vibrations.

18 Warranty

General Information

EXFO Inc. (EXFO) warrants this equipment against defects in material and workmanship for a period of one year from the date of original shipment. EXFO also warrants that this equipment will meet applicable specifications under normal use.

During the warranty period, EXFO will, at its discretion, repair, replace, or issue credit for any defective product, as well as verify and adjust the product free of charge should the equipment need to be repaired or if the original calibration is erroneous. If the equipment is sent back for verification of calibration during the warranty period and found to meet all published specifications, EXFO will charge standard calibration fees.



IMPORTANT

The warranty can become null and void if:

- unit has been tampered with, repaired, or worked upon by unauthorized individuals or non-EXFO personnel.
- warranty sticker has been removed.
- case screws, other than those specified in this guide, have been removed.
- case has been opened, other than as explained in this guide.
- unit serial number has been altered, erased, or removed.
- unit has been misused, neglected, or damaged by accident.

THIS WARRANTY IS IN LIEU OF ALL OTHER WARRANTIES EXPRESSED, IMPLIED, OR STATUTORY, INCLUDING, BUT NOT LIMITED TO, THE IMPLIED WARRANTIES OF MERCHANTABILITY AND FITNESS FOR A PARTICULAR PURPOSE. IN NO EVENT SHALL EXFO BE LIABLE FOR SPECIAL, INCIDENTAL, OR CONSEQUENTIAL DAMAGES.

Warranty

Liability

Liability

EXFO shall not be liable for damages resulting from the use of the product, nor shall be responsible for any failure in the performance of other items to which the product is connected or the operation of any system of which the product may be a part.

EXFO shall not be liable for damages resulting from improper usage or unauthorized modification of the product, its accompanying accessories and software.

Exclusions

EXFO reserves the right to make changes in the design or construction of any of its products at any time without incurring obligation to make any changes whatsoever on units purchased. Accessories, including but not limited to fuses, pilot lamps, batteries and universal interfaces (EUI) used with EXFO products are not covered by this warranty.

This warranty excludes failure resulting from: improper use or installation, normal wear and tear, accident, abuse, neglect, fire, water, lightning or other acts of nature, causes external to the product or other factors beyond the control of EXFO.



IMPORTANT

EXFO will charge a fee for replacing optical connectors that were damaged due to misuse or bad cleaning.

Certification

EXFO certifies that this equipment met its published specifications at the time of shipment from the factory.

Service and Repairs

EXFO commits to providing product service and repair for five years following the date of purchase.

To send any equipment for service or repair:

1. Call one of EXFO's authorized service centers (see *EXFO Service Centers Worldwide* on page 254). Support personnel will determine if the equipment requires service, repair, or calibration.
2. If equipment must be returned to EXFO or an authorized service center, support personnel will issue a Return Merchandise Authorization (RMA) number and provide an address for return.
3. If possible, back up your data before sending the unit for repair.
4. Pack the equipment in its original shipping material. Be sure to include a statement or report fully detailing the defect and the conditions under which it was observed.
5. Return the equipment, prepaid, to the address given to you by support personnel. Be sure to write the RMA number on the shipping slip. *EXFO will refuse and return any package that does not bear an RMA number.*

Note: *A test setup fee will apply to any returned unit that, after test, is found to meet the applicable specifications.*

After repair, the equipment will be returned with a repair report. If the equipment is not under warranty, you will be invoiced for the cost appearing on this report. EXFO will pay return-to-customer shipping costs for equipment under warranty. Shipping insurance is at your expense.

Routine recalibration is not included in any of the warranty plans. Since calibrations/verifications are not covered by the basic or extended warranties, you may elect to purchase FlexCare Calibration/Verification Packages for a definite period of time. Contact an authorized service center (see *EXFO Service Centers Worldwide* on page 254).

Warranty

EXFO Service Centers Worldwide

EXFO Service Centers Worldwide

If your product requires servicing, contact your nearest authorized service center.

EXFO Headquarters Service Center

400 Godin Avenue
Quebec (Quebec) G1M 2K2
CANADA

1 866 683-0155 (USA and Canada)
Tel.: 1 418 683-5498
Fax: 1 418 683-9224
quebec.service@exfo.com

EXFO Europe Service Center

Omega Enterprise Park, Electron Way
Chandlers Ford, Hampshire S053 4SE
ENGLAND

Tel.: +44 2380 246810
Fax: +44 2380 246801
europe.service@exfo.com

EXFO Telecom Equipment (Shenzhen) Ltd.

3rd Floor, Building 10,
Yu Sheng Industrial Park (Gu Shu
Crossing), No. 467,
National Highway 107,
Xixiang, Bao An District,
Shenzhen, China, 518126

Tel: +86 (755) 2955 3100
Fax: +86 (755) 2955 3101
beijing.service@exfo.com

A Technical Specifications



IMPORTANT

The following technical specifications can change without notice. The information presented in this section is provided as a reference only. To obtain this product's most recent technical specifications, visit the EXFO Web site at www.exfo.com.

VDSL2 VTU-R-MODULE

Chipsset	Infinion
Standard Compliance	
VDSL2	ITU-T G.993.2
ADSL1/2/2+	Annex A option (over POTS): ITU-T G.992.5 (ADSL2+), ITU-T G.992.3 (ADSL2), ITU-T G.992.1 (G.DMT) and ANSI T1.413 Issue 2 Annex B option (over ISDN): ITU-T G.992.5 (ADSL2+), ITU-T G.992.3 (ADSL2), ITU-T G.992.1 (G.DMT) Annex L (RE-ADSL) and Annex M are also supported
DSL measurements (upstream and downstream)	Maximum attainable bit rates Actual achieved bit rates Latency mode: fast, interleaved Capacity Signal-to-noise ratio (SNR) margin Output power Attenuation Carrier load (bits/bin) Interleave depth Interleave delay
Miscellaneous functions/measurements	INP support Link errors FEC, CRC, HEC Loss of sync counter VDSL2 per band information

IPTV-OVER-DSL/ETHERNET TESTING

Physical-layer support	VDSL2 ADSL1/2/2+ Ethernet 10/100
Supported video compression/standards	MPEG2, MPEG4 part 2 and 10 (H.264/AVC), WM9
Operation	Terminate and Pass Through
IPTV parameters/functionality	Video streaming (channels) detection IGMP join/leave requests with STB emulation Bandwidth usage per channel IGMP packets information Set-top box (STB) traffic/setup information Key IP video QoS parameters: packet loss, packet jitter, zap time, PCR jitter, PID statistics Media delivery index (MDI) showing delay factor, media loss rate and virtual buffer QoS pass/fail indicators Graphic results: bandwidth usage and multilayer fault analysis histogram IP packet and PCR jitter histograms Multicast/unicast RTP/UDP IP stream support TCP/RTSP VOD support Multiple downstream PVC in ATM mode for IPTV
IP connectivity support	DNS, DHCP client/server, NAT, VLAN

VoIP-OVER-DSL/ETHERNET TESTING

Physical-layer support	VDSL2 ADSL1/2/2+ Ethernet 10/100
Recognized signalling protocol	Session initiation protocol (SIP) v2 (RFC 3261)
Operation	Pass Through
Recognized codecs	G.711, G.729, G.726, G.723
VoIP parameters/functionality	Call monitoring/analysis/statistics Call flow Key VoIP QoS parameters: packet loss, packet jitter QoS pass/fail indicators Graphic results: delay distribution, jitter histogram
IP connectivity support	DNS, DHCP client/server, NAT, VLAN

Technical Specifications

DATA ANALYSIS MODE

Physical-layer support	VDSL2 ADSL1/2/2+ Ethernet 10/100
Encapsulation methods	PPPoE (RFC 2516), RFC 2684 supporting bridged Ethernet (IPoE)
Operation	Terminate and Pass Through
Login format	Username and password using PAP or CHAP
IP connectivity support	DNS, DHCP client/server, NAT, VLAN
Ping	Pings another device on the network Ping device: Gateway, destination IP address or URL Number of pings: 1 to 99 Packet size: 32 to 1500 bytes (32 is default) Results: Indicate packet size, packets sent/received, average round-trip time in milliseconds (ms)
Traceroute	Determines the path used to reach device on the network Timeout: In seconds Time to live (TTL): Default is 100 ms, maximum is 5 s Packet size: 32 bytes Number of hops: 1 to 30 (default is 30) Results: Indicate IP address of hop and round-trip time in milliseconds (ms)
HTTP speed test	Downloads a Web page and indicates speed of download Address: IP or URL Protocol: HTTP Results: Time, speed in kbit/s
FTP speed test	Displays speed to upload and/or download a file Address: IP or URL Protocol: FTP Results: Time, speed in kbit/s

RECEIVER CHARACTERISTICS ^b

Receive frequency	200 Hz to 10 kHz, resolution 1 Hz
Receive frequency	10 kHz to 20 kHz, resolution 10 Hz
Receive frequency	20 kHz to 30 MHz, resolution 1 kHz
Frequency uncertainty (accuracy)	±50 ppm + 0.5 Hz
Receive level (dBm)	-90 to +10 at 100 Ω or 135 Ω, resolution 0.1 dB
	-100 to +10 at 600 Ω, resolution 0.1 dB
Level uncertainty (accuracy)	±1.0 dB for 200 Hz to 20 kHz at 0 dBm
	±1.0 dB for 20 kHz to 30 MHz at 0 dBm
Impedance (Ω)	100, 135, 600 and bridging (100 kΩ)

TRANSMITTER CHARACTERISTICS

Transmit frequency	200 Hz to 20 kHz, resolution 1 Hz steps
Transmit frequency	20 kHz to 30 MHz, resolution 1 kHz steps
Transmit level (dBm)	-20 to +5 at 600 Ω for 200 Hz to 499 Hz
	-20 to +10 at 600 Ω for 500 Hz to 20 kHz
	-10 to +10 at 100/135 Ω for 20 kHz to 30 MHz
Frequency uncertainty (accuracy)	±50 ppm + 0.5 Hz
Level uncertainty (accuracy)	±0.6 dB 200 Hz to 20 kHz at 0 dBm
	±1 dB 20 kHz to 2.2 MHz
	±2 dB 2.2 MHz to 17 MHz
	±3 dB 17 MHz to 30 MHz
Impedance (Ω)	100, 135 and 600

VF NOISE MEASUREMENT

Range (dBm)	0 to -90, subject to instrument noise floor
Uncertainty (accuracy) (dB)	±1
Filters	None, 3 kHz flat, C-message, psophometric, notched and D filter (IEEE 743-1995)

VF IMPULSE NOISE

Low threshold (dBm)	0 to -40, in 1 dB steps
Mid threshold	Low threshold plus separation
High threshold	Mid threshold plus separation
Separation (dB)	1 to 6, in 1 dB steps
Dead time (ms)	125
Filters	None, 3 kHz flat, C-message, psophometric, notched and D filter (IEEE 743-1995)
Counter	Maximum 999 for each threshold
Timer	1 minute to 24 hours, default is 15 minutes

POWER INFLUENCE (NOISE TO GROUND)

Noise range (dBm)	-60 to +10
Uncertainty (accuracy) (dB)	±1.0
Level uncertainty (accuracy) (dB)	±1.0 at -60 dBm

VF LONGITUDINAL BALANCE

Frequency (Hz)	1004
Frequency uncertainty (accuracy) (ppm)	±50
Level range (dB)	0 to 80
Level uncertainty (accuracy) (dB)	±1

TIME-DOMAIN REFLECTOMETRY (TDR)

Mode	Fully automatic operation with location of most significant events
Distance range (m)	8 to 6000 (25 ft up to 20 000 ft)
Pulse width	15 ns to 20 μs
Test signals	Sine wave, compensated sine wave, half-sine wave and square wave
Amplitude	7.5 V p-p on cable, 9 V p-p open circuit
Velocity of propagation (VOP)	0.400 to 0.999 or 120 m/μs to 299 m/μs
Distance uncertainty ^c (accuracy) (m)	±(1.4 m + 2 % x distance) or ±(4.5 ft + 2 % x distance)
Units	Feet and meters
Horizontal scale (m)	Automatic or 30 (100 ft), 300 (1000 ft), 600 (2000 ft), 1500 (5000 ft), 3000 (10 000 ft), 6000 (20 000 ft), 13 500 (45 000 ft) and 15 000 (50 000 ft)

FREQUENCY-DOMAIN REFLECTOMETRY (FDR)

Distance range (m)	1.5 to 5000 (5 ft to 18 000 ft)
Velocity of propagation (VOP)	0.400 to 0.999 or 120 m/μs to 299 m/μs
Distance uncertainty (accuracy) (m)	±3 (3 to 1000), ±15 (1000 to 1500), ±50 (1500 to 5000)
Units	Feet and meters

LOAD COIL DETECTION

Count	Five
Plot (kHz)	Up to 10
Distance range (m)	Up to 8000 (up to 27 000 ft)

SINGLE-END FREQUENCY RESPONSE (ATTENUATION)

Distance range (m)	70 to 5000 (200 ft to 16 000 ft)
Frequency range	4.3 kHz to 30 MHz
Frequency uncertainty (accuracy)	±50 ppm
Level uncertainty (accuracy) (dB)	2 dB, 4 dB at 30 MHz
Resolution (dB)	0.1
Horizontal scale (MHz)	ADSL2+ = 2.208, VDSL2-12 = 12, VDSL2-17 = 17.66, VDSL2-30 = 30
Vertical scale (dB)	0 to +100

- NOTES**
- At 23 °C ± 1 °C on batteries, unless otherwise specified.
 - Characteristics are subject to instrument noise floor (approx. -70 dBm). Levels below -70 dBm can be measured using the PSD noise test.
 - Does not include the uncertainty due to VOP.

Technical Specifications

POWER SPECTRAL DENSITY (PSD) NOISE MEASUREMENT			
Test type	Continuous or peak-hold		
Vertical scale	-10 dBm/Hz to -145 dBm/Hz or +20 dBm to -110 dBm		
Horizontal scale	4.3125 kHz to 17 MHz, in 4.3125 kHz steps or 8.625 kHz to 30 MHz, in 8.625 kHz steps		
Noise filters	None or E, F, G, VDSL2-8, VDSL2-12, VDSL2-17 and VDSL2-30		
DSL IMPULSE NOISE MEASUREMENT			
Threshold	-50 dBm (40 dBm) to 0 dBm (90 dBm) in 1 dB steps		
Counter	Maximum 65 000		
Test duration	1, 5, 10, 15 and 60 min, 24 h or continuous (up to 360 h)		
Histogram plot interval	1, 5, 10, 15 or 60 min		
Uncertainty (accuracy) (dB)	±2		
SWEPT LONGITUDINAL BALANCE TEST			
Frequency uncertainty (accuracy) (ppm)	±50		
Level uncertainty (accuracy)(dB)	±2.0		
Vertical scale (dB)	0 to 80.0 up to 2.2 MHz 0 to 60.0 up to 30 MHz		
Horizontal scale	ADSL/2+: 26 kHz to 2.2 MHz SHDSL: 26 kHz to 1 MHz VDSL/VDSL2-12: 26 kHz to 12 MHz VDSL2-17: 26 kHz to 17.68 MHz VDSL2-30: 26 kHz to 30 MHz		
DIGITAL MULTIMETER (DMM)			
Measurement	Range	Resolution	Uncertainty (accuracy)
DC voltage	0 to 200 V	1 V	the better of ±2 % or ±1 V
AC voltage	0 to 140 Vrms	1 V	the better of ±2 % or ±1 V
Isolation resistance	0 to 999 MΩ	3 digits	
	0 to 999 Ω		the better of ±2 % or ±5 Ω
	1 kΩ to 99 MΩ		±(2 % + 1 digit)
	100 MΩ to 999 MΩ		±(5 % + 1 digit)
	Distance up to 30 000 m (100 000 ft)		
Resistance	0 to 30 MΩ	3 digits	
	0 to 999 Ω		the better of ±2 % or ±5 Ω
	1 kΩ to 30 MΩ		±(2 % + 1 digit)
	Distance up to 30 000 m (100 000 ft)		
Capacitance	1 nF to 10 μF	3 digits	±(2 % + 1 digit)
	Distance up to 30 000 m (100 000 ft)		
DC current	0 to 110 mA	1 mA	±(2 % + 1 digit)
AC current	0 to 77 mA	1 mA	±(2 % + 1 digit)
SPECTRAL DETECTIVE			
Allows the AXS-200/635 to bridge (high-impedance) onto a live circuit to display a plot of transmitted levels and spectrum (PSD). The Spectral Detective test can be referenced to any user-selected impedance. The impedance reference setting is required to display proper readings in dBm/Hz or dBm.			
Test type	Continuous or peak-hold		
Bridging impedance	15 kΩ		
Vertical scale	-10 to -145 dBm/Hz or +20 to -110 dBm		
Horizontal scale	4.3125 kHz to 17 MHz, in 4.3125 kHz steps or 8.625 kHz to 30 MHz, in 8.625 kHz steps		
Noise filters	None or E, F, G, VDSL2-8, VDSL2-12, VDSL2-17 and VDSL2-30		
STRESS/LEAKAGE (ISOLATION RESISTANCE)			
Source	100 VDC, current safely limited to <1.0 mA		
Range (MΩ)	0 to 999 auto-ranging		
Resolution	3 significant digits		
Uncertainty (accuracy)	0 to 999 Ω, the better of ±2 % or ±5 Ω 1 kΩ to 99 MΩ, ±(2 % + 1 digit) 100 MΩ to 999 MΩ, ±(5 % + 1 digit)		
Soak timer (s)	1 to 99		
RESISTIVE FAULT LOCATION (RFL)			
Test type	Single pair and separate good pair		
Fault detection (MΩ)	0 to 20		
Resolution	3 digits		
Loop resistance (kΩ)	7 maximum		
Multiple cable sections	Five (includes gauge and temperature setting)		
Fault location	*Total resistance, near-end to fault resistance, fault to strap resistance (four significant digits) *Total length, distance to fault, distance from fault to strap (3 ft/1 m resolution)		
Uncertainty (accuracy)	The better of 0.2 Ω or ±2 %		

GENERAL SPECIFICATIONS

Module size (H x W x D)	283 mm x 125 mm x 92 mm	(11 1/8 in x 4 11/16 in x 3 1/8 in)
Module weight (with battery)	1.3 kg	(2.8 lb)
Temperature		
operating	0 °C to 50 °C	(32 °F to 122 °F)
storage	-20 °C to 60 °C	(-4 °F to 140 °F)
Humidity	5 % to 95 % relative, non-condensing	
Power supply		
input	100-240 VAC at 1.8 A, 50 Hz to 60 Hz	
output	18-24 VDC at 3.33 A to 2.50 A, 60 W	
Battery	Internal rechargeable Li-Ion battery, with battery state indication	
Test connections	Five-color banana connector for T, R, G, T1, R1 RJ-45 for ADSL2+ and Ethernet 10/100 WAN RJ-45 for Ethernet 10/100 LAN	
Differential voltage protection	125 VRMS or 400 VDC max	
Common mode voltage protection	1000 VRMS	
Self-test	Routine on power-up	
Voltage detection	> 20 V will trigger alarm message	
Results storage	128 MB	
Languages	English, French, German, Spanish, Chinese (Simplified)	

Specifications based on 24 AWG (0.5 PE mm) cabling and subject to change without notice.

STANDARD ACCESSORIES

Hand strap, Certificate of Compliance
 ACC-RJTC: RJ-45 to telco clip (test cable), or ACC-RJMM: RJ-45 to 4 mm plugs with crocodile clips (test cable)
 ACC-RJRJ: RJ-45 Ethernet cable
 ACC-SCOLR: Five-color 4 mm banana plugs terminated with telco clips, or ACC-SCOLR4MM: Five-color 4 mm banana plugs terminated with 4 mm plugs with crocodile clips
 ACC-STRP: RFL strap

Index

A	
ADSL2+	6
after-sales service	248
applications	
Auto test	3
CPE tests	3
data analysis	3
IPTV analysis	3
VoIP analysis	3
attenuation test	133
C	
cable connections	4
capacitance test	86
caution	
of personal hazard	8
of product hazard	8
certification information	vi
cleaning	
front panel	245
configure tests	
data	178
FTP speed parameters	174
HTTP speed parameters	173
IPTV	175
ping parameters	171
STB support	179
traceroute	172
VoIP	177
configuring CQ auto tests	
common parameters	29
test list 1	26
test list 2	28
thresholds 1	34
thresholds 2	36
VF test parameters	30
WB test parameters	32
configuring video-DSL	
common parameters	67
configuring video-DSL rate prediction	
configuration	63
impulse noise	66
thresholds	65
connection setup	
DSL thresholds	164
LAN	162
line params	155
selected profile	152
WAN access	157
WAN IP	159
conventions, safety	8
CPE test results	
bits per bin	187
DSL Params	184
FTP speed	192
HPNA info	193
HPNA statistics	194
HTTP speed	191
line status	182
ping	189
statistics	185
summary	181
TraceRoute	190
VDSL Bands	186
WAN status	188
CQ auto tests	25
current test	87
customer service	253
D	
data analysis results	
downstream rates	227
DSL parameters	221
HPNA info	228
HPNA statistics	229

Index

IP packets	225
LAN status	225
line status	219
protocols	226
statistics.....	222
summary.....	217
upstream rates.....	227
VDSL bands	223
WAN status.....	224
data rate prediction	137
summary.....	139
DMM tests.....	81
DSL/IP auto tests	169

E

equipment returns	253
EXFO worldwide service centers	254

F

fault location	
loop mapper test	114
RFL-2 wire test	108
RFL-4 wire test	111
TDR test	106
fault location tests	105
front panel, cleaning	245

H

HPNA	
LAN setup	162
line mode	152

I

identification label	248
IGMP	157
monitor	206
zap time	196
impulse noise histogram test	130

impulse noise test.....	128
configuration	100
results	102
in service pair detection test.....	90
IPTV analysis results	
detected streams	209
downstream rates	204
DSL Params	199
errors	205
HPNA info	214
HPNA statistics	215
IGMP	206
IP arrival jitter.....	210
LAN status.....	203
line status	197
network activity	204
PCR jitter	211
RTSP info.....	207
statistics.....	200
stream content	213
stream params	212
summary.....	195
VDSL Bands.....	201
WAN status.....	202
isolation test	
isolation	85

L

label, identification.....	248
load coil detection test	
results	103
longitudinal balance.....	135
longitudinal balance test	89, 103
loop mapper test	
configuration	114
FDR graph	117
summary.....	115
TDR graph.....	51, 115

M	
main menu	7
maintenance	245
front panel	245
general information	245
N	
navigation	7
O	
opens meter	86
P	
POTS Dialer	10
power influence test	
results	102
product	
identification label	248
specifications	255
PSD noise test	122
R	
receive tone test (RX)	96
rectified loop detection test	91
recycling and disposal	246
regional settings	
cable setup	17
phone book	13
select profile	15
standard	19
resistance test	83
resistive balance	
resistive balance results	93
test setup	92
resistive balance test	92
results	
CPE tests	181
data analysis	217
IPTV test	195
read saved	23, 149
save	20, 147
VoIP tests	231
return merchandise authorization (RMA) ..	253
RFL-2 wire test	
configuration	108
connection diagram	110
result	110
RFL-4 wire test	
configuration	111
connection diagram	113
result	113
S	
safety	
caution	8
conventions	8
warning	8
send tone test (TX)	97
service and repairs	253
service centers	254
shipping to EXFO	253
shorts meter	83
solving common problems	247
specifications, product	255
spectral detective test	125
storage requirements	245
symbols, safety	8
T	
TDR test	
results	106
setup	106
technical specifications	255
technical support	248
temperature for storage	245
tracing tone test	98
transportation requirements	245, 249
troubleshooting	247
typical applications	3

Index

V

VDSL2.....	6
VF noise test.....	88, 99
VF tests	95
video-DSL rate prediction	
bits per bin graph.....	78
DMM results.....	71
DSL rate results.....	75
SNR graph	77
summary.....	68
video rates.....	70
WB attenuation	74
WB impulse noise	75
WB longitudinal balance.....	72
WB PSD noise	73
viewing CQ auto tests results	
attenuation.....	42
DMM results.....	38
isolation.....	38
load coil.....	38, 50, 61
PSD noise.....	41, 53
receive tone	39
summary.....	37
TDR.....	43
VF impulse noise.....	39
VF tests.....	39
WB impulse noise	43
WB longitudinal balance.....	40
VoIP analysis results	
call history	239
DSL parameters	234
HPNA info.....	242
HPNA statistics.....	243
jitter analysis.....	241
LAN status	238
line status	232
network activity.....	239
packets analysis	240
statistics.....	235
summary.....	231
VDSL bands	236
WAN status.....	237
voltage test	82

W

warranty	
certification.....	252
exclusions	252
general.....	251
liability.....	252
null and void.....	251
water detection test	91
wideband attenuation test	
configuration	133
results	134
wideband data rate prediction	
attenuation.....	142
bits per bin	144
DSL rate	137
PSD noise	141
SNR.....	143
wideband impulse noise histogram test	
configuration.....	130
graph.....	132
summary.....	131
wideband impulse noise test	
configuration	128
results	129
wideband longitudinal balance test	
configuration	135
results	136
wideband PSD noise test	
configuration	122
results	123
wideband receive tone test (RX).....	120
wideband send tone test (TX).....	121
wideband spectral detective test	
configuration	125
results	127
wideband tests.....	119

NOTICE

通告

CHINESE REGULATION ON RESTRICTION OF HAZARDOUS SUBSTANCES

中国关于有害物质限制的规定

NAMES AND CONTENTS OF THE TOXIC OR HAZARDOUS SUBSTANCES OR ELEMENTS CONTAINED IN THIS EXFO PRODUCT



包含在本 EXFO 产品中的有毒有害物质或元素的名称和含量

O	Indicates that this toxic or hazardous substance contained in all of the homogeneous materials for this part is below the limit requirement in SJ/T11363-2006 表示该有毒有害物质在该部件所有均质材料中的含量均在 SJ/T11363-2006 标准规定的限量要求以下。
X	Indicates that this toxic or hazardous substance contained in at least one of the homogeneous materials used for this part is above the limit requirement in SJ/T11363-2006 表示该有毒有害物质至少在该部件的某一均质材料中的含量超出 SJ/T11363-2006 标准规定的限量要求。

Part Name 部件名称	Toxic or hazardous Substances and Elements 有毒有害物质和元素					
	Lead 铅 (Pb)	Mercury 汞 (Hg)	Cadmium 镉 (Cd)	Hexavalent Chromium 六价铬 (Cr VI)	Polybrominated biphenyls 多溴联苯 (PBB)	Polybrominated diphenyl ethers 多溴二苯醚 (PBDE)
Enclosure 外壳	O	O	O	O	O	O
Electronic and electrical sub-assembly 电子和电子组件	X	O	X	O	X	X
Optical sub-assembly ^a 光学组件 ^a	X	O	O	O	O	O
Mechanical sub-assembly ^a 机械组件 ^a	O	O	O	O	O	O

- a. If applicable.
如果适用。

MARKING REQUIREMENTS
标注要求

Product 产品	Environmental protection use period (years) 环境保护使用期限 (年)	Logo 标志
This Exfo product 本 EXFO 产品	10	
Battery ^a 电池 ^a	5	

a. If applicable.
如果适用。

P/N: 1060295

www.EXFO.com · info@exfo.com

CORPORATE HEADQUARTERS	400 Godin Avenue	Quebec (Quebec) G1M 2K2 CANADA Tel.: 1 418 683-0211 · Fax: 1 418 683-2170
EXFO AMERICA	3701 Plano Parkway, Suite 160	Plano TX, 75075 USA Tel.: 1 972 907-1505 · Fax: 1 972 836-0164
EXFO EUROPE	Omega Enterprise Park, Electron Way	Chandlers Ford, Hampshire S053 4SE ENGLAND Tel.: +44 2380 246810 · Fax: +44 2380 246801
EXFO ASIA-PACIFIC	151 Chin Swee Road #03-29, Manhattan House	SINGAPORE 169876 Tel.: +65 6333 8241 · Fax: +65 6333 8242
EXFO CHINA	No. 88 Fuhua First Road, Central Tower, Room 801, Futian District	Shenzhen 518048 P. R. CHINA Tel.: +86 (755) 8203 2300 · Fax: +86 (755) 8203 2306
	Beijing New Century Hotel Office Tower, Room 1754-1755, No. 6 Southern Capital Gym Road	Beijing 100044 P. R. CHINA Tel.: +86 (10) 6849 2738 · Fax: +86 (10) 6849 2662
EXFO SERVICE ASSURANCE	285 Mill Road	Chelmsford MA, 01824 USA Tel.: 1 978 367-5600 · Fax: 1 978 367-5700
TOLL-FREE	(USA and Canada)	1 800 663-3936

© 2011 EXFO Inc. All rights reserved.
Printed in Canada (2011-01)

