

FTB-3930

Multifunction Loss Tester

Master date: 2004-08-23 10:28:40

FasTest

λ	Loss A→B (dB)	Loss B→A (dB)	Average (dB)	ORL A (dB)	ORL B (dB)
1310 nm	6,51	4,15	5,17	33,45	-
1550 nm	7,76	5,34	6,39	36,03	-

Fiber length: 12,985 km

Reference

- Loopback
- Side-by-side
- No reference

Take Reference

Tested fibers

- Fiber Name
- Fiber 001
- Fiber 002
- Fiber 003

Next fiber name

Prefix: Fiber

Suffix: 004

Full name: Fiber 004

FasTest result

Add

EXFO Ready 83% Local 2004-08-23 10:35

Copyright © 2004–2014 EXFO Inc. All rights reserved. No part of this publication may be reproduced, stored in a retrieval system or transmitted in any form, be it electronically, mechanically, or by any other means such as photocopying, recording or otherwise, without the prior written permission of EXFO Inc. (EXFO).

Information provided by EXFO is believed to be accurate and reliable. However, no responsibility is assumed by EXFO for its use nor for any infringements of patents or other rights of third parties that may result from its use. No license is granted by implication or otherwise under any patent rights of EXFO.

EXFO's Commerce And Government Entities (CAGE) code under the North Atlantic Treaty Organization (NATO) is 0L8C3.

The information contained in this publication is subject to change without notice.

Trademarks

EXFO's trademarks have been identified as such. However, the presence or absence of such identification does not affect the legal status of any trademark.

Units of Measurement

Units of measurement in this publication conform to SI standards and practices.

Version number: 9.0.2

Contents

Certification Information	v
1 Introducing the FTB-3930 Multifunction Loss Tester	1
Main Features	1
Typical Applications	3
Conventions	4
2 Safety Information	5
Other Safety Symbols on Your Unit	6
Laser Safety Information (Units without VFL)	7
Laser Safety Information (Units with VFL)	7
Electrical Safety Information	8
3 Customizing Your Multifunction Loss Tester	9
4 Setting Up Your Multifunction Loss Tester	11
Installing the EXFO Universal Interface (EUI)	11
Cleaning and Connecting Optical Fibers	12
Setting Autonoming Scheme	14
Setting Pass/Fail Thresholds	16
5 Measuring Power or Loss	19
Defining the List of Favorite Wavelengths	20
Nulling Electrical Offsets	22
Referencing Your Power Meter to a Source	23
Measuring Power or Loss	26
6 Measuring Optical Return Loss	29
Performing ORL Reference and Setting ORL Zero Value	30
Performing and Saving ORL Measurements	32
7 Performing Automated IL/ORL/Length Measurements (FasTest)	35
Setting Up the FasTest	36
Referencing Units for FasTest	38
Performing the FasTest	43
8 Managing Test Results	49
Viewing and Deleting Results	49
Customizing Result Display	52
Customizing and Printing Reports (FTB-500)	54
9 Using a Light Source	57

Contents

10 Identifying Fiber Faults Visually	61
11 Communicating with Other Users	63
Sending and Receiving Text Messages	63
Communicating by Voice	66
12 Maintenance	69
Cleaning EUI Connectors	69
Cleaning Detector Ports	72
Cleaning VFL-Type Connectors	73
Recalibrating the Unit	74
Recycling and Disposal (Applies to European Union Only)	75
13 Troubleshooting	77
Solving Common Problems	77
Obtaining Online Help	80
Contacting the Technical Support Group	81
Transportation	82
14 Warranty	83
General Information	83
Liability	84
Exclusions	84
Certification	84
Service and Repairs	85
EXFO Service Centers Worldwide	86
A Technical Specifications	87
Index	89

Certification Information

North America Regulatory Statement

This unit was certified by an agency approved in both Canada and the United States of America. It has been evaluated according to applicable North American approved standards for product safety for use in Canada and the United States.

Electronic test and measurement equipment is exempt from FCC part 15, subpart B compliance in the United States of America and from ICES-003 compliance in Canada. However, EXFO Inc. makes reasonable efforts to ensure compliance to the applicable standards.

The limits set by these standards are designed to provide reasonable protection against harmful interference when the equipment is operated in a commercial environment. This equipment generates, uses, and can radiate radio frequency energy and, if not installed and used in accordance with the user guide, may cause harmful interference to radio communications. Operation of this equipment in a residential area is likely to cause harmful interference in which case the user will be required to correct the interference at his own expense.

Modifications not expressly approved by the manufacturer could void the user's authority to operate the equipment.

European Community Declaration of Conformity

An electronic version of the declaration of conformity for your product is available on our website at www.exfo.com. Refer to the product's page on the Web site for details.

1 Introducing the FTB-3930 Multifunction Loss Tester

The FTB-3930 Multifunction Loss Tester integrates a power meter and light sources with an optical return loss meter, optional talk set and visual fault locator.

Main Features

The unit features **FASTEST™**, EXFO's one-touch automated measurement. In 10 seconds, you can simultaneously test IL and ORL at up to four wavelengths, in both directions. During the same test, the unit also determines fiber length.

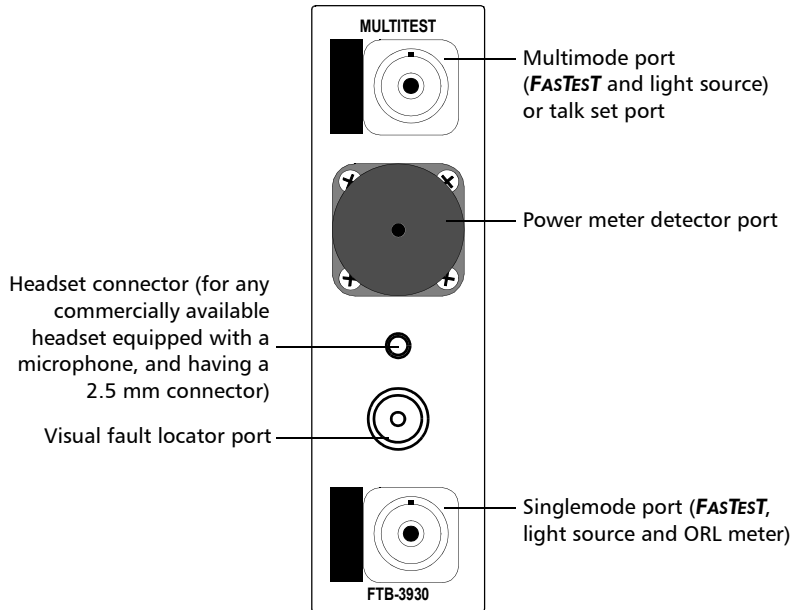

Note: Optical ports and connectors may differ from the illustration.

Introducing the FTB-3930 Multifunction Loss Tester

Main Features

The power meter has the following characteristics:

- Ge, GeX or InGaAs detector with 40 calibrated wavelengths to measure absolute power or link loss
- Editable list of favorite wavelengths for easy access
- Modulated signal detection
- No offset nulling required in normal operation

The light source has the following characteristics:

- Singlemode port (two or three wavelengths), also used for **FASTEST** and ORL.

AND/OR

Multimode port (two wavelengths), also used for **FASTEST** only.

- Modulated or high-power signal compatible with other EXFO units

Other test utilities:

- Text messaging
- Full-duplex digital talk set (optional)
- Visual fault locator to inspect or identify fibers (optional)

Result processing and analysis features (also available in the FastReporter application):

- Analyze data acquired on the field using a tabular format
- Customizable test thresholds with visual pass/fail analysis
- Transfer data from the FOT-930 Multifunction Loss Tester (using the Handheld Data Transfer application) for easier management and greater storage capacity
- Save your OLTS data in popular text formats (XML, ASCII, etc.) or convert older result files to the new format for analysis
- Customize user settings and cable identification parameters
- Generate and print reports about OLTS data, including user and test location information and operator comments
- **FASTEST** results displayed according to FTTx usage and terminology

Typical Applications

You can use the Multifunction Loss Tester for several applications, such as:

- Fiber installation and maintenance applications
- FTTx: testing of passive optical networks (PONs)
- Absolute power or link loss measurements
- Bidirectional loss and ORL testing
- Length measurement
- All-in-one tool for contractors

Conventions

Before using the product described in this guide, you should understand the following conventions:



WARNING

Indicates a potentially hazardous situation which, if not avoided, could result in *death or serious injury*. Do not proceed unless you understand and meet the required conditions.



CAUTION

Indicates a potentially hazardous situation which, if not avoided, may result in *minor or moderate injury*. Do not proceed unless you understand and meet the required conditions.



CAUTION

Indicates a potentially hazardous situation which, if not avoided, may result in *component damage*. Do not proceed unless you understand and meet the required conditions.



IMPORTANT

Refers to information about this product you should not overlook.

2 **Safety Information**



WARNING

Do not install or terminate fibers while a light source is active. Never look directly into a live fiber and ensure that your eyes are protected at all times.



WARNING

The use of controls, adjustments and procedures, namely for operation and maintenance, other than those specified herein may result in hazardous radiation exposure or impair the protection provided by this unit.



IMPORTANT

When you see the following symbol on your unit , make sure that you refer to the instructions provided in your user documentation. Ensure that you understand and meet the required conditions before using your product.



IMPORTANT







Other safety instructions relevant for your product are located throughout this documentation, depending on the action to perform. Make sure to read them carefully when they apply to your situation.

Safety Information

Other Safety Symbols on Your Unit

Other Safety Symbols on Your Unit

One or more of the following symbols may also appear on your unit.

Symbol	Meaning
	Direct current
	Alternating current
	The unit is equipped with an earth (ground) terminal.
	The unit is equipped with a protective conductor terminal.
	The unit is equipped with a frame or chassis terminal.
	On (Power)
	Off (Power)

Laser Safety Information (Units without VFL)

Your instrument is a Class 1 laser product in compliance with standards IEC 60825-1: 2007 and 21 CFR 1040.10, except for deviations pursuant to Laser Notice No. 50, dated June 24, 2007. Invisible laser radiation may be encountered at the output port.

The following label indicates that a product contains a Class 1 source:



Note: *The label is shown for information purposes only and are not necessarily applied on your module.*

Laser Safety Information (Units with VFL)

Your instrument is a Class 3R laser product in compliance with standards IEC 60825-1: 2007 and 21 CFR 1040.10, except for deviations pursuant to Laser Notice No. 50, dated June 24, 2007. Laser radiation is emitted at the output port. It is potentially harmful in direct intrabeam viewing.

The following label(s) indicate that the product contains a Class 3R source:



Affixed to
side of module

↕ VFL
Laser
Aperture

Indicated on
front panel

The maximum input power for the FTB-3930 Multifunction Loss Tester is 1.48 W. For more information on equipment ratings, refer to the user documentation for your platform.

Safety Information

Electrical Safety Information

Electrical Safety Information



CAUTION

When you use the unit outdoors, ensure that it is protected from liquids, dust, direct sunlight, precipitation, and full wind pressure.

3 Customizing Your Multifunction Loss Tester

Note: Your screen display may differ slightly from the figures in this user documentation depending on the platform you are using.

To set a length/distance unit and data display color (for the FTB-500):

1. From the main window, press **Setup**, then select the **Preferences** tab.
2. Select the desired unit. In the case of the FTB-500 platform, you can also select the background color.

Note: The length unit affects thresholds and fiber length only.

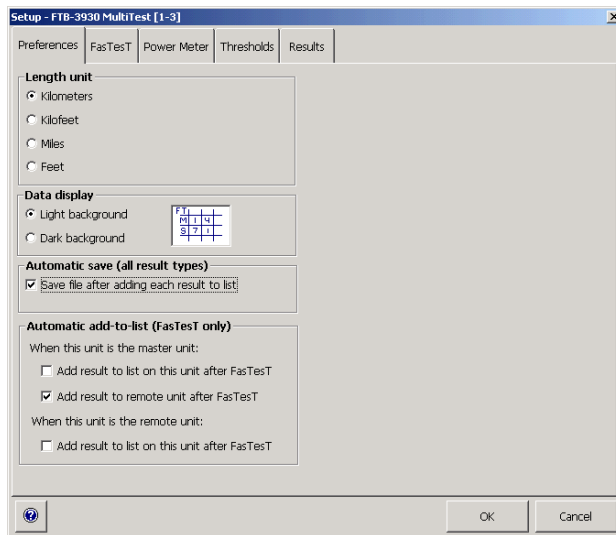

To automate adding and saving results:

1. From the main window, press **Setup**, then select the **Preferences** tab.
2. Select one or more of the following options:
 - **Save file after adding each result to list:** if you select this option, you will not need to manually save your file (with **Save** or **Save As**) after adding your result to the **Tested fibers** list. The asterisk will never appear in the title bar. In the case of the FTB-200 v2 platform, the file is saved after adding 10 results to the list.
 - **Add result to list on this unit after *FASTEST*:** if you select this option, you will not need to press **Add** to add your result to the **Tested fibers** list. When your Multifunction Loss Tester is the remote unit, it consequently ignores automatic save settings from the master unit.
 - **Add result to remote unit after *FASTEST*:** if you select this option and your Multifunction Loss Tester is the master unit, the result will automatically be sent and stored on the remote unit.

Note: *For details about naming settings, see Setting Autonaming Scheme on page 14.*

4 **Setting Up Your Multifunction Loss Tester**

Installing the EXFO Universal Interface (EUI)

The EUI fixed baseplate is available for connectors with angled (APC) or non-angled (UPC) polishing. A green border around the baseplate indicates that it is for APC-type connectors.

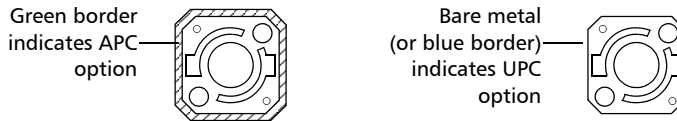

To install an EUI connector adapter onto the EUI baseplate:

1. Hold the EUI connector adapter so the dust cap opens downwards.

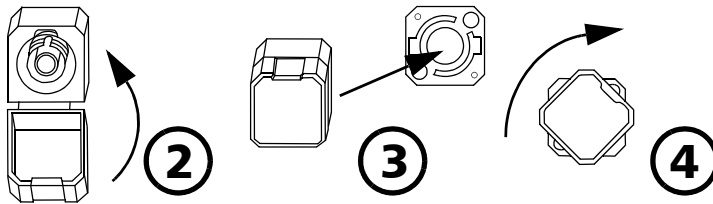

2. Close the dust cap in order to hold the connector adapter more firmly.
3. Insert the connector adapter into the baseplate.
4. While pushing firmly, turn the connector adapter clockwise on the baseplate to lock it in place.

Cleaning and Connecting Optical Fibers



IMPORTANT

To ensure maximum power and to avoid erroneous readings:

- Always inspect fiber ends and make sure that they are clean as explained below before inserting them into the port. EXFO is not responsible for damage or errors caused by bad fiber cleaning or handling.
- Ensure that your patchcord has appropriate connectors. Joining mismatched connectors will damage the ferrules.

To connect the fiber-optic cable to the port:

- 1.** Inspect the fiber using a fiber inspection microscope. If the fiber is clean, proceed to connecting it to the port. If the fiber is dirty, clean it as explained below.
- 2.** Clean the fiber ends as follows:
 - 2a.** Gently wipe the fiber end with a lint-free swab dipped in isopropyl alcohol.
 - 2b.** Use compressed air to dry completely.
 - 2c.** Visually inspect the fiber end to ensure its cleanliness.

Setting Up Your Multifunction Loss Tester

Cleaning and Connecting Optical Fibers

3. Carefully align the connector and port to prevent the fiber end from touching the outside of the port or rubbing against other surfaces.

If your connector features a key, ensure that it is fully fitted into the port's corresponding notch.

4. Push the connector in so that the fiber-optic cable is firmly in place, thus ensuring adequate contact.

If your connector features a screwsleeve, tighten the connector enough to firmly maintain the fiber in place. Do not overtighten, as this will damage the fiber and the port.

Note: *If your fiber-optic cable is not properly aligned and/or connected, you will notice heavy loss and reflection.*

EXFO uses good quality connectors in compliance with EIA-455-21A standards.

To keep connectors clean and in good condition, EXFO strongly recommends inspecting them with a fiber inspection probe before connecting them. Failure to do so will result in permanent damage to the connectors and degradation in measurements.

Setting Up Your Multifunction Loss Tester

Setting Autonaming Scheme

Setting Autonaming Scheme

When starting a new file, the unit suggests an initial fiber name. After adding a result to the **Tested fibers** list, the unit prepares the next fiber name by incrementing the suffix.

When you manually change the name for the first time (in **Power Meter**, **ORL Meter** or **FASTest**), the unit then ignores autonaming settings.



IMPORTANT

To start using new autonaming settings, you must close the current file.

- Cable names: maximum 60 characters for prefix, plus 3-digit suffix (or Microsoft Windows limitations when name is manually set)
- Fiber names: maximum 11 characters for prefix, plus 3-digit suffix (duplicate names allowed when name is manually set)

Note: *If you manually change a fiber name, then turn the unit off without saving at least one result, this name will be discarded.*

To set the autonaming scheme:

1. From the main window, press **Setup**, then select the **Results** tab.

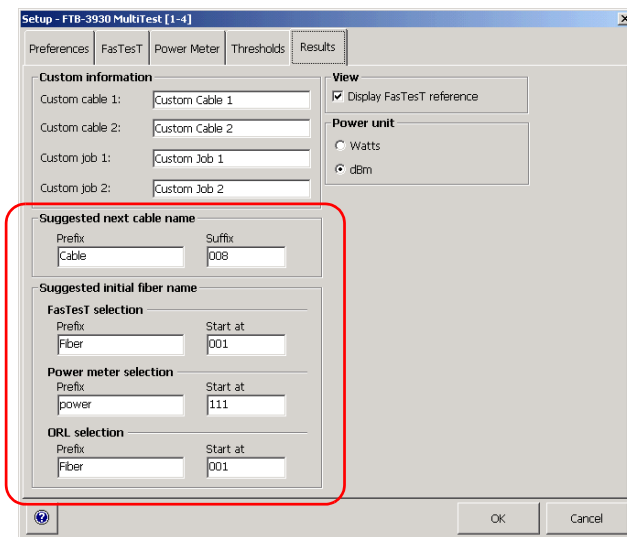

2. Set the names/values, then press **OK**.

Note: The cable name you set here will be the suggested file name when saving.

Setting Up Your Multifunction Loss Tester

Setting Pass/Fail Thresholds

Setting Pass/Fail Thresholds

You can define groups of thresholds to specify acceptable power (in W or dBm), power reference (in dB), **FASTeST** loss (in dB and dB per distance unit) and ORL values (in dB) for each wavelength.

Thresholds are supplied by system manufacturers and depend on the system deployed.

Measurements exceeding a threshold are shown with an exclamation mark. In the test tabs, these measurements also have a red background.



IMPORTANT

Thresholds are not saved with measurements. Results are compared to the threshold group currently *associated* to the file (for **FASTeST** results, not necessarily the master unit).

Note: *When transferring results from handheld unit to computer, thresholds are not transferred along with results.*

To set power, loss or ORL thresholds:

1. From the button bar, press **Setup**, then select the **Thresholds** tab.

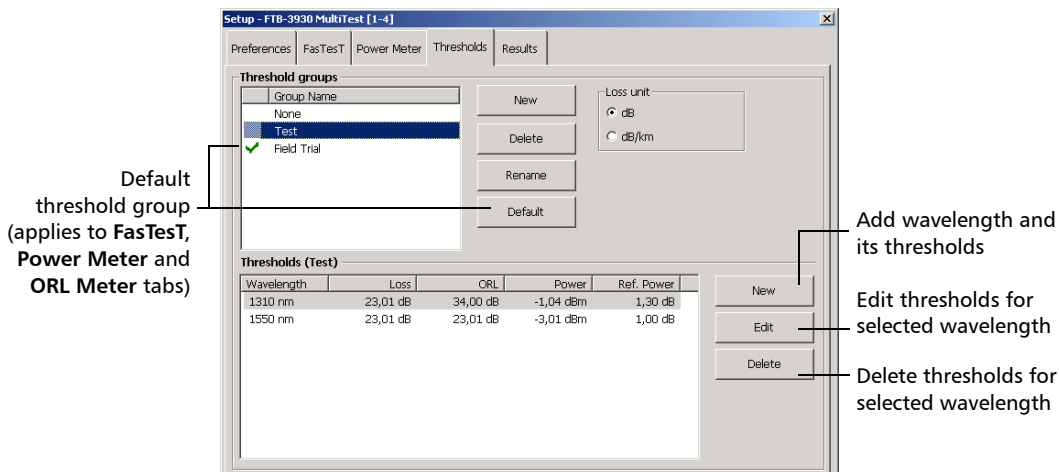

2. In the **Threshold groups** list, select a group to modify.

OR

Create a new group by pressing **New**. Duplicate names are allowed, but you should always use distinct names to avoid confusion.

3. Select loss units (dB or dB/distance; distance units are selected in the **Preferences** tab). In the case of the FTB-200 v2, you can select also the power units.

Setting Up Your Multifunction Loss Tester

Setting Pass/Fail Thresholds

4. In the **Thresholds** list, select a wavelength for which you want to set thresholds, then press **Edit**.

OR

Add a new wavelength to the list by pressing **New**. Wavelengths that are not supported by **FASTEST** are simply ignored in **FASTEST** result tables.

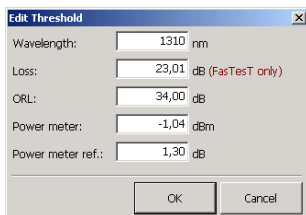

The screenshot shows the 'Edit Threshold' dialog box with the following values: Wavelength: 1310 nm, Loss: 23,01 dB (FASTEST only), ORL: 34,00 dB, Power meter: -1,04 dBm, and Power meter ref.: 1,30 dB. The 'Power meter' field has 'dBm' selected in a dropdown menu. At the bottom are 'OK' and 'Cancel' buttons.

dBm power units
selected in **Results** tab

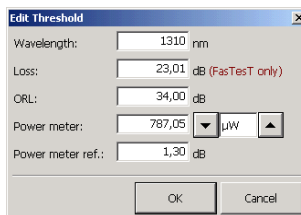

The screenshot shows the 'Edit Threshold' dialog box with the following values: Wavelength: 1310 nm, Loss: 23,01 dB (FASTEST only), ORL: 34,00 dB, Power meter: 787,05 μ W, and Power meter ref.: 1,30 dB. The 'Power meter' field has ' μ W' selected in a dropdown menu. At the bottom are 'OK' and 'Cancel' buttons.

Watt power units
selected in **Results** tab

5. In the text boxes, modify threshold values for the selected wavelength, then press **OK** to confirm the new thresholds (or **Cancel** to return to previous values).

You select **FASTEST** loss units (dB or dB/distance) on the **Thresholds** tab (and distance units on the **Preferences** tab).

Note: For the FTB-500, you select power units on the **Results** tab.

6. Press **OK** to return to the main window.

To rename a threshold group:

1. From the **Thresholds** tab, select a group in the **Threshold groups** list.
2. Press **Rename**, then set the new name (maximum 64 characters) and press **OK**.

5 Measuring Power or Loss

The FTB-3930 Multifunction Loss Tester is equipped with an optical power meter to measure absolute power (in dBm or W) or insertion loss (in dB). The power meter port is independent of the **FASTEST** port.

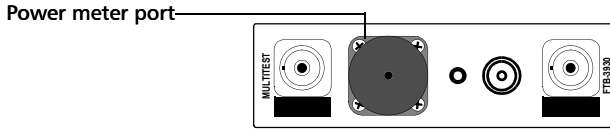

The following functions are available on your power meter:

Labels and their corresponding UI elements:

- Power meter port
- Reference power
- Measured power/loss
- Value under threshold
- Change name of next saved fiber
- Add current value to Tested fibers (to actually save data, press Save on function bar)
- Modulation detected
- Perform offset nulling
- Set reference for loss measurement
- Switch between favorite wavelengths
- Display power (W or dBm) or loss (dB)

Measuring Power or Loss

Defining the List of Favorite Wavelengths

Defining the List of Favorite Wavelengths

You must put the wavelengths you want to use on a list of favorite wavelengths. Only wavelengths selected from this list are available for measurements.

By default, the list contains 22 of the 40 calibrated wavelengths. It can contain a maximum of 30 wavelengths.

Specifications are guaranteed for calibrated wavelengths only. For other wavelengths, the unit will determine values based on the calibrated wavelengths (3-point interpolation).

Detector Type	Calibrated Wavelengths (nm)	Default Favorite Wavelengths (nm)
► InGaAs	800, 820, 830, 840, 850, 860, 870,	800, 840, 850,
► Ge	880, 910, 980, 1270, 1280, 1290, 1300, 1310, 1320, 1330, 1340, 1390, 1450, 1460, 1470, 1480, 1490, 1500, 1510, 1520, 1530, 1540, 1550, 1560, 1570, 1580, 1590, 1600, 1610, 1620, 1630, 1640, 1650.	860, 910, 980, 1280, 1300, 1310, 1320, 1450, 1470, 1480, 1490, 1510, 1520, 1530, 1540, 1550, 1560, 1570, 1625.
► GeX	All the above, plus 1370 and 1060.	Same as above.

Note: *The list must always contain at least one selected wavelength.*

To customize the list of favorite and selected wavelengths:

1. From the button bar, press **Setup**, then select the **Power Meter** tab.

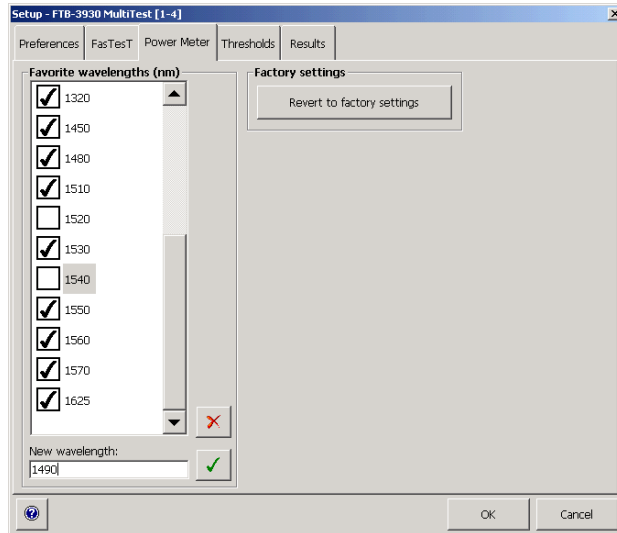

2. Scroll through the list.
3. Press on the highlighted wavelength to select/deselect it. An X appears beside selected wavelengths.
4. If a wavelength does not appear on the list, enter its value in the **New wavelength** box and press (or **Add** in the case of the FTB-200 v2). You can also remove a wavelength from the list by pressing (or **Delete** in the case of the FTB-200 v2).
5. Repeat these steps for other wavelengths as necessary.
6. Press **OK** to return to the main window.

To revert to the factory-default list:

1. From the button bar, press **Setup**, then select the **Power Meter** tab.
2. Press **Revert to factory settings**.

Nulling Electrical Offsets

Temperature and humidity variations affect the performance of electronic circuits and optical detectors. Nulling the electrical offsets eliminate these effects.

Your unit has been designed not to require offset nulling under normal operation, but you should perform it whenever environmental conditions change significantly or when measuring very low power values.



IMPORTANT

Light must not reach detectors when nulling offsets. Always use an EUI or protective screw cap. Do not use a soft rubber cover.

Note: Starting a nulling automatically deactivates all light sources on the unit.

To perform an offset nulling:

1. From the main window, select the **Power Meter** tab.

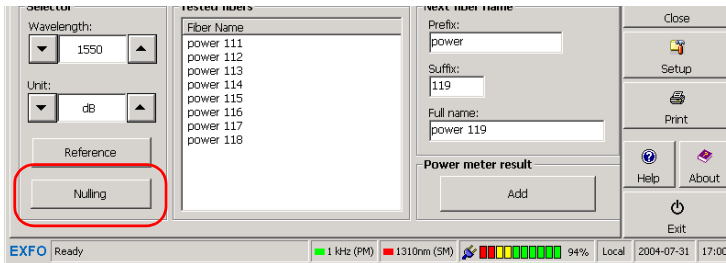

2. Press **Nulling**.
3. Tighten the protective caps on the power meter and **FASTEST** ports, then press **OK**.

The nulling process takes approximately 10 seconds. Nulling status is indicated in the data display. If light is still detected, you will need to place the caps properly and restart.

Referencing Your Power Meter to a Source

In reference mode, your unit displays the loss created by the fiber under test only, since it subtracts a reference value from the measured power.

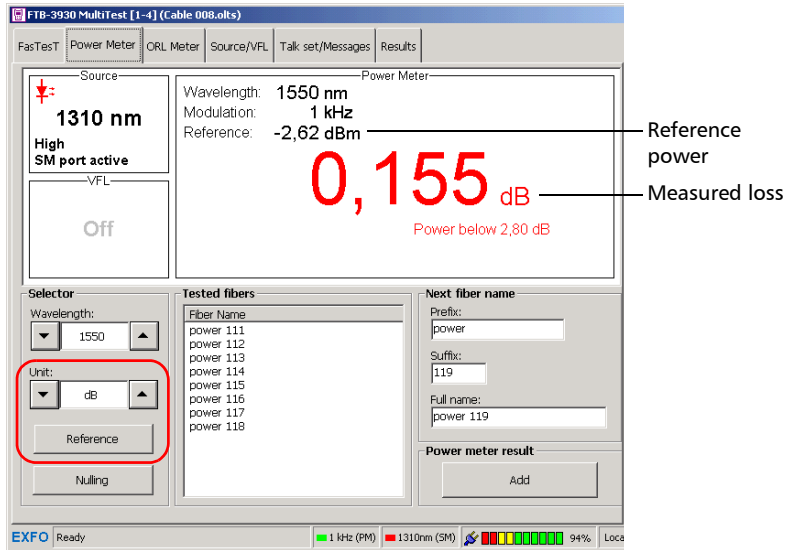

In the illustration, the reference value (-2.62 dBm) is subtracted from the actual power measured (-2.465 dBm).

Note: *The reference value you set for each wavelength remains in memory until a new one is set for the same wavelength, even when you turn the unit off.*

Measuring Power or Loss

Referencing Your Power Meter to a Source

To reference the power meter to a source:

1. From the main window, select the **Power Meter** tab.
2. Check your fibers and clean them properly for optimum performance (see *Cleaning and Connecting Optical Fibers* on page 12).
3. Using one of the following methods, connect a light source to the power meter port of your unit.

- One single reference patchcord

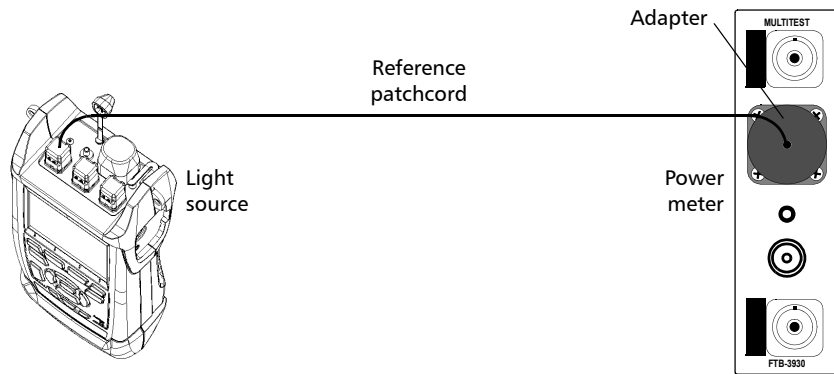

- Two reference patchcords and a bulkhead adapter

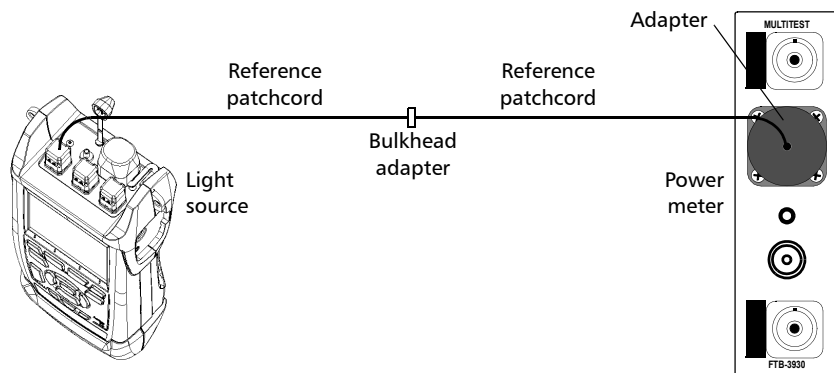

4. Activate the source at the desired wavelength.

5. Match the power meter wavelength with the source wavelength as follows:

Scroll through the **Wavelength** list to switch between **favorite wavelengths** of your power meter (see *Defining the List of Favorite Wavelengths* on page 20).

6. Scroll through the **Unit** list until you get **dB** units to retrieve the last saved reference.

OR

Press **Reference** to save the current power as the new reference.

Reference power appears (in dBm) and current loss is automatically switched to dB.

7. Repeat the procedure for each wavelength you want to reference.

Measuring Power or Loss

Measuring Power or Loss

Measuring Power or Loss

Measuring absolute power or link loss is done the same way, except for the referencing step. You can take power or loss measurements and save them for further analysis.



CAUTION

Connect high-power live fiber to the power meter port only.

To perform power or loss measurements:

1. If necessary, perform an [offset nulling](#) (see *Nulling Electrical Offsets* on page 22).
2. From the main window, select the **Power Meter** tab.

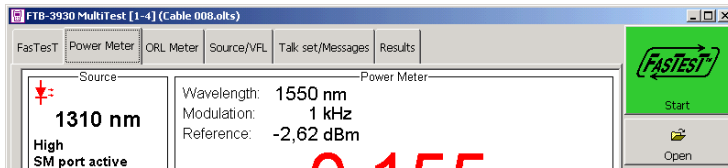

3. Check your fibers and clean them properly (see *Cleaning and Connecting Optical Fibers* on page 12).
4. For loss measurements, [reference your power meter](#) to a light source (see *Referencing Your Power Meter to a Source* on page 23), then deactivate the light source.
5. If you have used a single reference patchcord, disconnect it *from the power meter port only*, then attach a second reference patchcord to the power meter.

OR

If you have used two reference patchcords, disconnect both of them at the bulkhead.

- Using bulkhead adapters or the system patch panels, connect a fiber under test to reference patchcords attached to the light source and power meter.

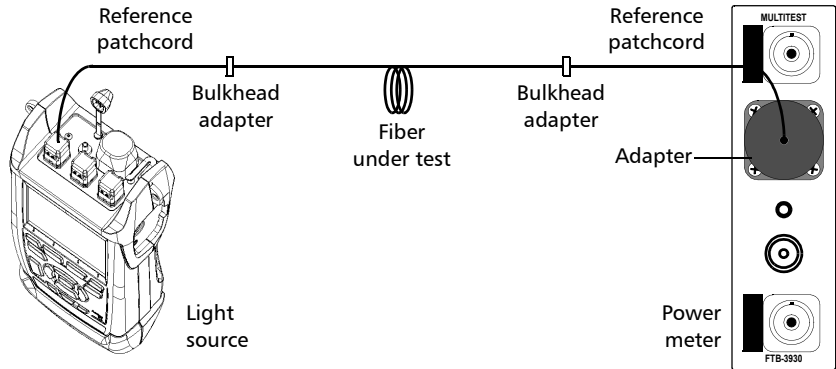

- Activate the source at the desired wavelength.
- Match the power meter wavelength with the source wavelength as follows:

Scroll through the **Wavelength** list to switch between **favorite wavelengths** of your power meter (see *Defining the List of Favorite Wavelengths* on page 20).

If the unit detects a modulated signal, it beeps and the signal frequency is indicated in the status bar.

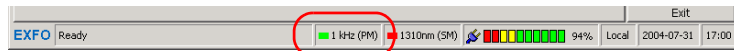

- Scroll through the **Unit** list to select the desired power (W or dBm) or loss (dB) unit.

Measuring Power or Loss

Measuring Power or Loss

10. Add the displayed values to the **Tested fibers** list if you want. If auto-save is activated (see *Customizing Your Multifunction Loss Tester* on page 9), results are automatically saved after adding them to the list.

10a. Change the displayed cable and fiber names as needed.

10b. Press **Add** to save the value along with wavelength, reference power, date and time. The fiber name will increment automatically, ready to save the next value.

For details about viewing results, see *Managing Test Results* on page 49.

11. Repeat the procedure for other wavelengths.

6 Measuring Optical Return Loss

Optical return loss (ORL) is the total effect of multiple reflections and scattering events within a fiber-optic system.

The FTB-3930 Multifunction Loss Tester is equipped with an ORL meter to measure ORL for singlemode fibers. The ORL meter uses the **FASTEST SM** (singlemode) port only.

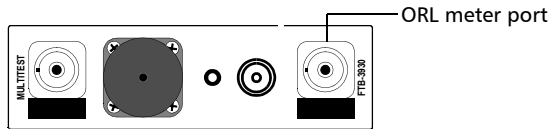

The following functions are available on your ORL meter:

The screenshot shows the software interface for the FTB-3930 MultiTest. The window title is 'FTB-3930 MultiTest [1-4] (Cable 008.olt)*'. The interface includes several sections:

- Source:** Shows '1310 nm', 'ORL mode', and 'SM port active'. A 'VFL' section is set to 'Off'.
- ORL Meter:** Displays 'Sensitivity: 41,26 dB' and a large red '14,74 dB' measurement. Below it, it says 'ORL below 34,00 dB' and 'Ready'.
- Selector:** Includes a 'Wavelength' dropdown set to '1310' and buttons for 'ORL Zero', 'ORL Reference', 'Default ORL Zero', and 'Loopback Ref.'.
- Tested fibers:** A list showing 'Fiber 001' and 'Fiber 002'.
- Next fiber name:** Fields for 'Prefix' (set to 'Fiber'), 'Suffix' (set to '003'), and 'Full name' (set to 'Fiber 003').
- ORL result:** An 'Add' button.
- Status Bar:** Shows 'EXFO Ready', '1310nm (SM)', a signal strength indicator, and '94% Loss'.

Labels pointing to specific interface elements include:

- ORL meter sensitivity
- Measured ORL (positive value)
- Value under threshold
- Change name of next saved fiber
- Add current value to Tested fibers (to actually save data, press Save on function bar)
- Current ORL wavelength
- Set reference using ORL calibrated patchcord (best)
- Set reference using any patchcord
- Calibrate ORL meter sensitivity
- Switch between singlemode wavelengths

Measuring Optical Return Loss

Performing ORL Reference and Setting ORL Zero Value

The ORL measurement procedure is outlined below:

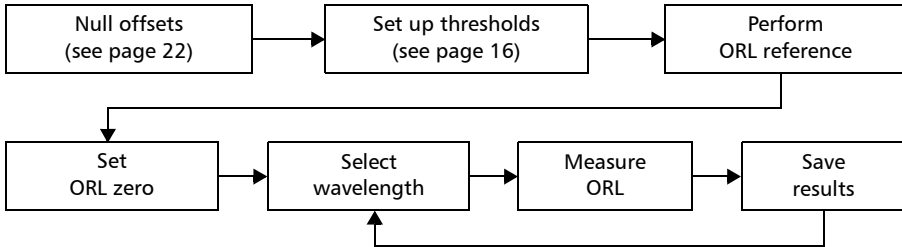

Performing ORL Reference and Setting ORL Zero Value

The ORL zero measurement eliminates the effects of backreflection on the link *before* the component under test, so your unit displays only the backreflection of this component.

You should set a new ORL zero:

- when you change the measurement patchcord (the one connected to the DUT, not the reference patchcord)
- when you remove a connection between the unit and mandrel

To set the ORL zero value (all wavelengths at once):

1. From the main window, select the **ORL Meter** tab.
2. Press **ORL Zero**.

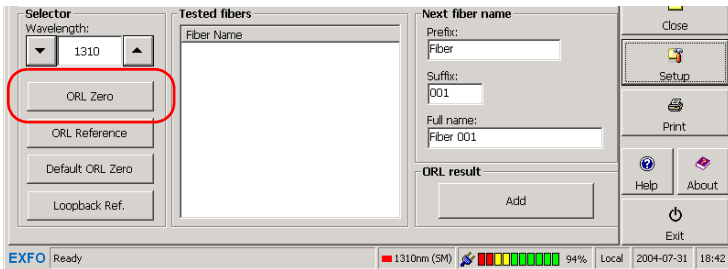

Measuring Optical Return Loss

Performing ORL Reference and Setting ORL Zero Value

3. Connect a patchcord to the **FASTEST** SM port.

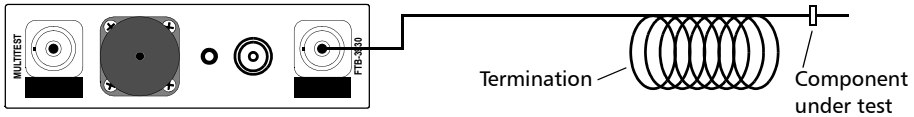

4. Terminate the fiber as close as possible *before* the component under test. Wrap it at least 10 turns around a mandrel or small diameter tool, adding turns until the reading stabilizes.
5. Press **OK** to save the ORL zero value, then remove the termination.

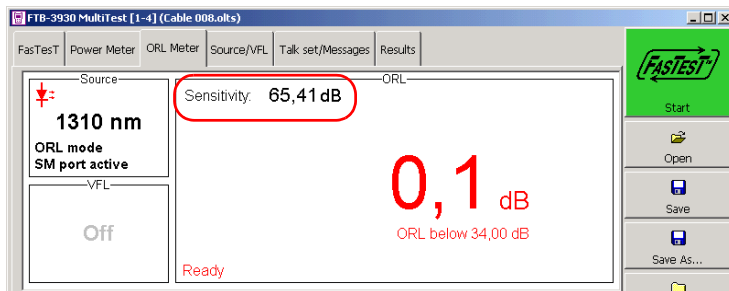

To revert to the factory-default ORL zero value:

1. From the main window, select the **ORL Meter** tab.
2. Press **Default ORL Zero**.

Measuring Optical Return Loss

Performing and Saving ORL Measurements

Performing and Saving ORL Measurements

You can define [ORL thresholds](#) (see *Setting Pass/Fail Thresholds* on page 16) before or after measuring ORL. ORL values below thresholds are displayed in red.

To measure ORL:

1. If necessary, perform an [offset nulling](#) (see *Nulling Electrical Offsets* on page 22).
2. From the main window, select the **ORL Meter** tab.

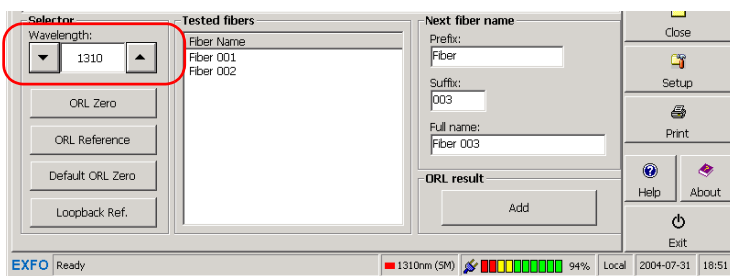

3. Scroll through the **Wavelength** list to select a singlemode wavelength.
4. Verify your patchcords and clean them properly (see *Cleaning and Connecting Optical Fibers* on page 12).

Note: *If the **FASTeST SM** port of your unit is equipped with an APC connector, use EXFO's optional ORL calibrated patchcord.*

Measuring Optical Return Loss

Performing and Saving ORL Measurements

5. Connect one end of a patchcord to the **FASTEST** SM port of your unit leaving the other end unconnected.
6. Perform an ORL reference as follows:

Note: During the reference, the patchcord end should remain in the air; reflections occurring at a fiber-to-air interface correspond to a constant of 14.7 dB.

Press **ORL Reference**.

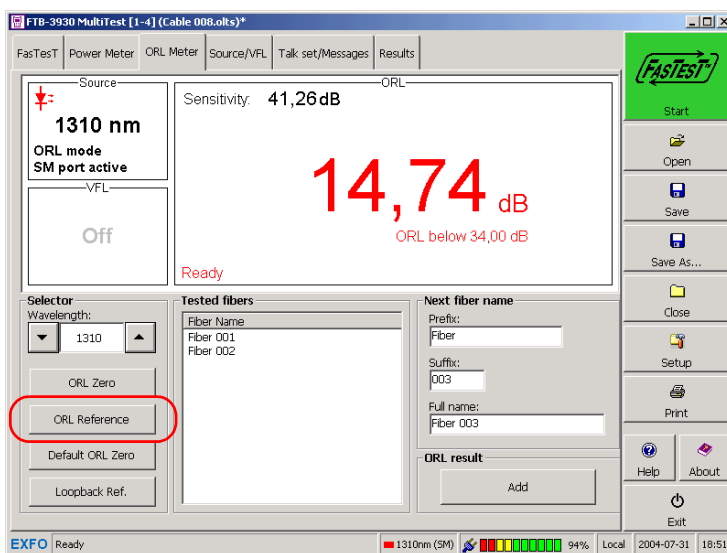

Measuring Optical Return Loss

Performing and Saving ORL Measurements

7. Perform an **ORL zero measurement** (see *Performing ORL Reference and Setting ORL Zero Value* on page 30).
8. Terminate the fiber as close as possible *after* the component under test. Wrap it at least 10 turns around a mandrel or small diameter tool, adding turns until the reading stabilizes.

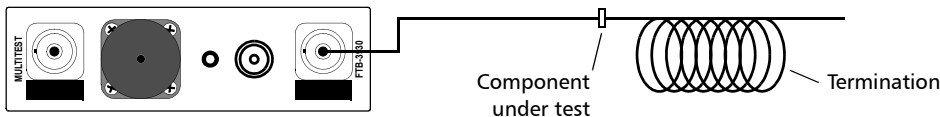

Note: *Avoid bending the fiber between the unit and the termination point.*

The displayed value represents the ORL of the component under test.

9. Add the displayed values to the **Tested fibers** list if you want. If auto-save is activated (see *Customizing Your Multifunction Loss Tester* on page 9), results are automatically saved (along with wavelength, date and time) after adding them to the list.
 - 9a. Change the displayed cable and fiber names as needed.
 - 9b. Press **Add**. The fiber name will increment automatically, ready to save the next value.

For details about viewing results, see *Managing Test Results* on page 49.

10. Repeat procedure for other wavelengths if necessary.

7 Performing Automated IL/ORL/Length Measurements (FastEST)

FastEST allows you to perform 2- or 3-wavelength bidirectional loss and ORL tests for singlemode fibers, or 2-wavelength loss tests for multimode fibers, in 10 seconds (including fiber length measurement).

FastEST is useful in high-fiber-count installations. Activated at the touch of a button, **FastEST** cuts down on training time and provides error-free results.

To use **FastEST**, you need a compatible unit (such as FTB-3930, FOT-930, FOT-920 or FTB-3920, but not the FOT-910). The unit at the remote end is only used to establish references. It then waits for commands from the unit initiating **FastEST** (master).

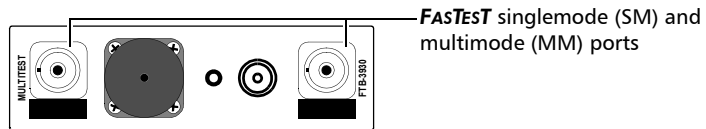

The **FastEST** procedure is outlined below:

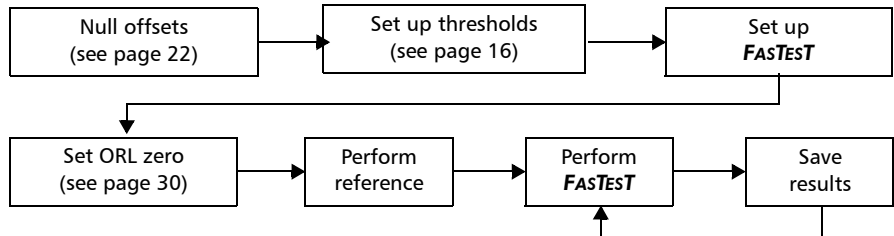

Setting Up the FasTest

You can configure the **FASTEST** on the master unit only. The remote unit will automatically adapt to these parameters (**FASTEST** parameters on remote unit are ignored).

Setup includes the following elements:

- Port and DUT (fiber) type: multimode **FASTEST** will not include ORL.
- Compatibility: select **FOT-930 / FTB-3930** for fast, two- or three-wavelength testing including ORL (it requires two FOT-930/FTB-3930). Use **FOT-920 / FTB-3920** when other unit is an FOT-920 or FTB-3920.
- Mode/wavelengths: select one or more wavelengths for the **FASTEST**. Depending on your choice, the **FASTEST** will include loss and/or ORL measurements. Selecting **FTTx Custom** or **FTTx All** allows you to define upstream and downstream wavelengths.
- Unit location: in FTTx mode, you specify if the master unit is closer to the CO (or to the premises) than the remote unit.

To set up the FasTeST:

1. From the button bar, press **Setup**, then select the **FasTeST** tab.

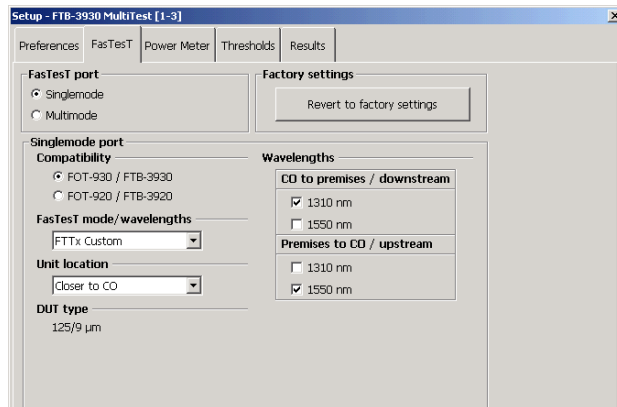

2. Select the **FasTeST** parameters.

To revert to factory-default FasTeST settings:

1. From the button bar, press **Setup**, then select the **FasTeST** tab.
2. Press **Revert to factory settings**.

Performing Automated IL/ORL/Length Measurements (FastEST)

Referencing Units for FastEST

Referencing Units for FastEST

Referencing subtracts the loss caused by the test setup components from the overall loss measured during **FASTEST**. The final result represents the loss inserted by the system under test alone.

Two referencing methods are available:

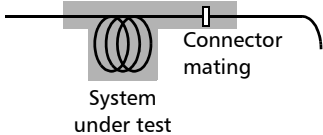
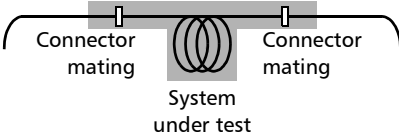
	Side-by-Side Method (Best)	Loopback Method
Description	Reference taken with both units together using their FASTEST ports. <i>Slightly more accurate</i> value than loopback method.	Reference taken separately on each unit (FASTEST port connected to power meter port).
Location of units	Must be at same location.	Can be at different locations.
Loss included in FASTEST result	Loss due to system under test and one connector mating. <div style="text-align: center;">  </div>	Loss due to system under test and the two connector matings. <div style="text-align: center;">  </div>
Elements to consider	Includes neither an ORL reference nor an ORL zero measurement . To obtain them, use the ORL Meter pane (see Performing ORL Reference and Setting ORL Zero Value on page 30). With multiple referencing, you may coordinate an FTB-3930 with up to 10 FOT-930 units.	When measuring ORL (FASTEST or ORL meter), accounts for connector loss and adjusts ORL calibration accordingly. Not recommended for short links.

Performing Automated IL/ORL/Length Measurements (FasTesT)

Referencing Units for FasTesT

To perform a side-by-side reference:

1. On the master unit (the one initiating the test), select the **FASTEST** tab.
2. In the **Reference** pane, select the **Side-by-side** reference type. The data display shows previous reference values (if any) for the *currently connected remote unit*.

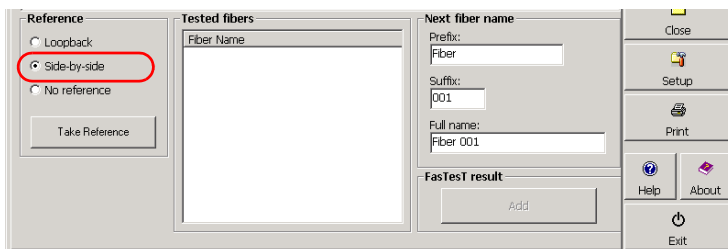

IMPORTANT

With its *multiple referencing* feature, your unit saves the last 10 side-by-side references for each DUT type and compatibility mode.

3. Connect both units through their **FASTEST** ports, using two reference patchcords and a bulkhead adapter.

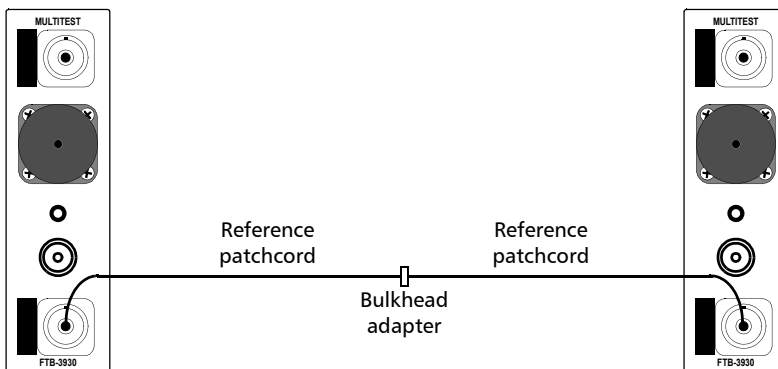

Performing Automated IL/ORL/Length Measurements (FasTest)

Referencing Units for FasTest

4. Press **Take Reference**. After a few seconds, the unit displays new reference values for each wavelength on both units. If values are not acceptable, try to clean connectors and repeat this step.

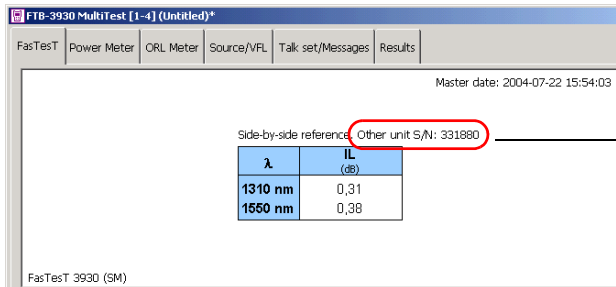

Serial number of unit on other side

5. Disconnect the two patchcords *from the bulkhead only* and connect them to the fiber under test (using bulkhead adapters or the system patch panels).



IMPORTANT

- You can turn off the unit without losing the reference.
- If you disconnect the patchcords from the *FasTest* ports, you must take a new reference.

Performing Automated IL/ORL/Length Measurements (FasTesT)

Referencing Units for FasTesT

To perform a loopback reference:

1. On the master unit (the one initiating the test), select the **FASTEST** tab.
2. In the **Reference** pane, select the **Loopback** reference type. The data display shows previous reference values (if any).

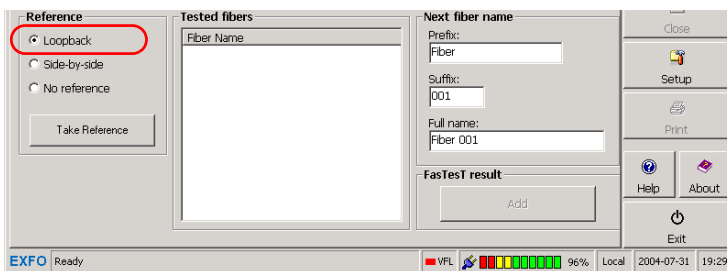

3. Connect a reference patchcord from the **FASTEST** port to the power meter adapter.

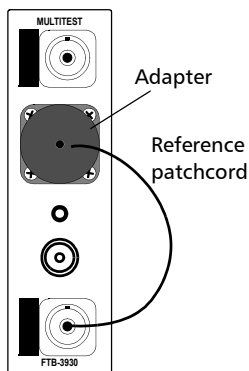

Performing Automated IL/ORL/Length Measurements (FasTest)

Referencing Units for FasTest

4. Press **Take Reference**. After a few seconds, the unit displays new reference values for each wavelength. If values are not acceptable, try to clean connectors and repeat this step.

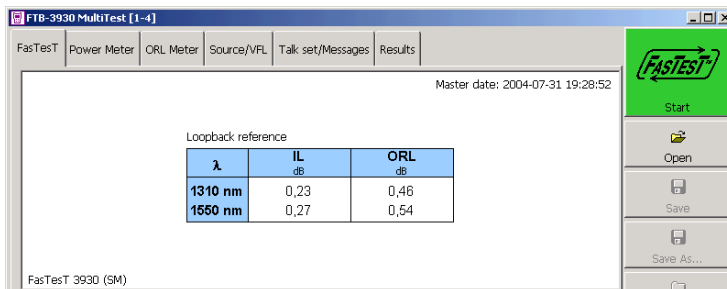

5. Disconnect the reference patchcord *from the power meter adapter only* and connect it to the fiber under test.



IMPORTANT

- You can turn off the unit without losing the reference.
- If you disconnect the patchcord from the *FasTest* port, you must take a new reference.

6. Repeat the procedure with the second unit.

Performing the FasTesT

Although **FASTEST** requires two units (one at each end of the fiber under test), you initiate it from only one (the master). Both units use **FASTEST** settings from the master unit.

To perform a FasTesT:

Unit A (Master)

- 1.** If necessary, null the offsets (see *Nulling Electrical Offsets* on page 22).
- 2.** Clean your fibers properly (see *Cleaning and Connecting Optical Fibers* on page 12).
- 3.** Set up the **FASTEST** (see *Setting Up the FasTest* on page 36).
- 4.** If you are testing ORL, perform an ORL zero measurement from the **ORL Meter** pane (see *Performing ORL Reference and Setting ORL Zero Value* on page 30).
- 5.** Reference your unit (see *Referencing Units for FasTesT* on page 38).

Unit B

- 1.** If necessary, null the offsets.
- 2.** Clean your fibers properly.
- 3.** If you are testing ORL, perform an ORL zero measurement from the **ORL Meter** pane.
- 4.** Reference your unit.

Performing Automated IL/ORL/Length Measurements (FasTest)

Performing the FasTest

Unit A (Master)

Unit B

6. Connect reference patchcord to fiber under test (as shown):

5. Connect reference patchcord to fiber under test (as shown):

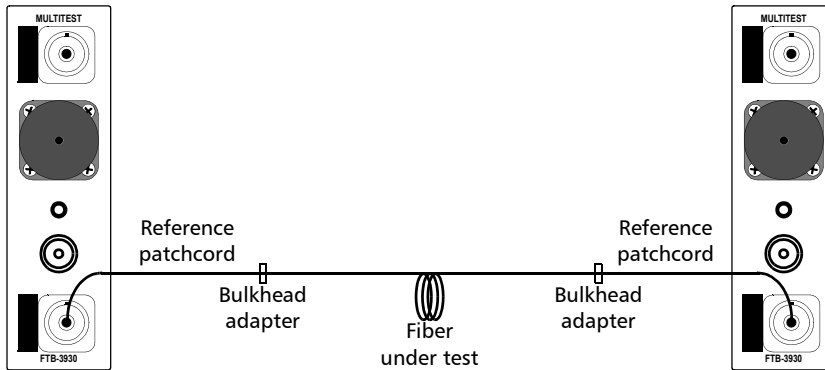

Unit A (Master)

Unit B

- From the button bar, press **FASTEST** (large green button).

The units establish communication and automated tests begin. Measurements appear on both units as they are taken.

Indicates unsaved results

Indicates results not added to Tested fibers list

Standard View

λ	Loss A->B (dB)	Loss B->A (dB)	Average (dB)	ORL A (dB)	ORL B (dB)
1310 nm	6,51	4,15	5,17	33,45	-
1550 nm	7,76	5,34	6,39	36,03	-

Measured values

Value under threshold (in red)

Calculated fiber length

Change name of next added fiber

Add current value to Tested fibers (to actually save data, press Save on function bar)

FTTx View

λ	Loss A->B (dB)	Loss B->A (dB)	Average (dB)	ORL A (dB)	ORL B (dB)
1310 nm	6,51	4,15	5,17	33,45	-
1550 nm	7,76	5,34	6,39	36,03	-

Measured values

Value under threshold (in red)

Performing Automated IL/ORL/Length Measurements (FasTest)

Performing the FasTest

Unit A (Master)

Unit B

- 8.** Add the displayed values to the **Tested fibers** list if you want. If automatic save was activated for one or both units (see *Customizing Your Multifunction Loss Tester* on page 9), results are already added to the list.
- 8a.** Change the displayed cable and fiber names as needed.
- 8b.** Press **Add**. The fiber name increments automatically, ready to save the next value.

If you are not satisfied with the results, press **FASTEST** and redo the test.

Performing Automated IL/ORL/Length Measurements (FasTesT)

Performing the FasTesT

For details about viewing **FASTEST** results, see *Managing Test Results* on page 49.

The screenshot shows the FasTesT software interface with the following components:

- Master date:** 6/27/2006 7:42:41 AM
- Measured values table:**

λ (nm)	Loss A->B (dB)	Loss B->A (dB)	Average (dB)	ORL A (dB)	ORL B (dB)
1310	0.17	0.10	0.13	> 48.72	11.77
1550	0.32	0.31	0.32	> 47.81	10.53
1625		0.02			16.23
- Calculated fiber length:** -0.023 km
- Reference options:** Loopback, Side-by-side (selected), No reference. Includes a "Take Reference" button.
- Tested fibers list:** Fiber 001, Fiber 002.
- Next fiber name fields:** Prefix: Fiber, Suffix: 003, Full name: Fiber 003. Includes an "Add" button.
- Function bar:** Start, Open, Save, Save As..., Close, Setup, Print, Help, About, Exit.

Annotations on the right side of the screenshot:

- "Measured values" points to the table.
- "Calculated fiber length" points to the fiber length field.
- "Change name of next added fiber" points to the Suffix field.
- "Add current value to Tested fibers (to actually save data, press Save on function bar)" points to the Add button.

8 *Managing Test Results*

Viewing and Deleting Results

You can save all your results (**FASTEST**, power/loss and ORL) on your platform, along with references and date/time of tests. You will save and recall this data according to cable names (or any Windows file name).



IMPORTANT

The date and time of **FASTEST** references are not saved. They are displayed with the results *immediately after the test* only.

Before or after saving the current file, you can view and edit results at any time (as long as a result was added to a **Tested fibers** list).

To view and process test results:

From the Multifunction Loss Tester application's main window, select the **Results** tab. The following functions are available when viewing results:

Managing Test Results

Viewing and Deleting Results

FTB-500

To copy all results to Windows clipboard (for pasting as plain text)

To modify job or cable information (you can also click on section title)

To select current threshold group (you can also click on section title)

Shortcut to result sections

Result sections

The screenshot shows the main interface of the FTB-500 software. At the top, there is a menu bar with options: Delete, Copy All, Edit Job Information, Edit Cable Information, and Select Threshold. Below the menu bar are several tabs: Job Information, Cable Information, System Information, FasTesT, Power Meter (Power), Power Meter (Loss), Manual ORL, and Thresholds. The main content area is divided into three sections: Job Information, Cable Information, and Thresholds. Each section contains detailed test data. The Job Information section includes fields for Job ID, Reason, Contractor, Customer, Custom Job 1, Test Date, Operator A, Operator B, and Custom Job 2. The Cable Information section includes fields for Cable ID, Location A, Cable Mfr., Custom Cable 1, Location B, Cable Type, and Custom Cable 2. The Thresholds section is currently empty. The status bar at the bottom shows 'EXFO Ready' and a battery level indicator at 36%.

To delete results for selected (checked) fibers

To mark fiber for deletion

Click on link to edit fiber ID or comments

Result exceeding threshold

The screenshot shows the 'Power Meter (dB)' section of the software. It features a table with the following columns: Fiber ID, Wavelength (nm), Loss (dB), and Reference (dBm). The table contains several rows of data. The fiber ID 'power 112' is checked, and its Loss (dB) is 0.147, which is highlighted in red, indicating it is exceeding the threshold. The fiber ID 'power 113' has a red exclamation mark icon next to its Loss (dB) value of 0.147, and a red text prompt 'Enter any comments here.' is visible next to it. The other fibers have Loss (dB) values of 0.146 or 0.148, which are within the threshold. The Reference (dBm) for all fibers is -2.62. The table also includes a 'Wavelength (nm)' column with values of 1550. Each row has a link to edit the fiber ID or comments.

Fiber ID	Wavelength (nm)	Loss (dB)	Reference (dBm)
<input type="checkbox"/> power 111	1550	0.139	-2.62
<input checked="" type="checkbox"/> power 112	1550	0.147	-2.62
<input checked="" type="checkbox"/> power 113	1550	0.147	-2.62
<input type="checkbox"/> power 114	1550	0.148	-2.62
<input type="checkbox"/> power 115	1550	0.146	-2.62
<input type="checkbox"/> power 116	1550	0.143	-2.62
<input type="checkbox"/> power 117	1550	0.146	-2.62

FTB-200 v2

FasTesT
Power Meter
ORL Meter
Source/VFL
Messages
Results

Master date: 12/19/2005 3:21:10 PM

FasTesT no reference

λ (nm)	Loss A->B (dB)	Loss B->A (dB)	Average (dB)	ORL A (dB)	ORL B (dB)
1310	3.27	2.71	2.98	33.38	34.11
1550	2.47	1.62	2.02	35.20	35.14
1625		1.93			35.75

Local Milou / Remote 261346
Fiber length: 8.385 km

Fibers [PF3]

- FasTesT 001
- FasTesT 002
- FasTesT 003
- FasTesT 004
- FasTesT 005

Additional information

Edit Job Information

Edit Cable Information

Select Threshold

Ready
(Untitled)*

To mark fiber for deletion → FasTesT 001

To modify job or cable information → Edit Job Information / Edit Cable Information

To select current threshold group → Select Threshold



IMPORTANT

The threshold group you select will remain associated with the file, even if you **change the default group**. However, if you change values in the selected group, they will apply to your results.

Note: For more accuracy, the loss average is always calculated from loss values in W and then converted to dB.

Customizing Result Display

For the FTB-500, you can customize the following elements:

- Power unit: will affect the **Results** tab and the [printed report](#), but not the different test tabs.
- Display **FASTeST** reference: when selected, the **FASTeST** references will be shown on the **Results** tab.
- Custom boxes: sets the names of fields in the **Edit Job Information** and **Edit Cable Information** windows. *When you change the field name, data in this field is kept.*

For the FTB-200 v2, in the results display, you can customize the custom boxes, that set the names of fields in the **Edit Job Information** and **Edit Cable Information** windows. *When you change the field name, data in this field is kept.*

You can also define default initial cable and fiber names. For details, see *Setting Autonoming Scheme* on page 14.

To customize the display of results:

1. From the main window, press **Setup**, then select the **Results** tab.

FTB-500

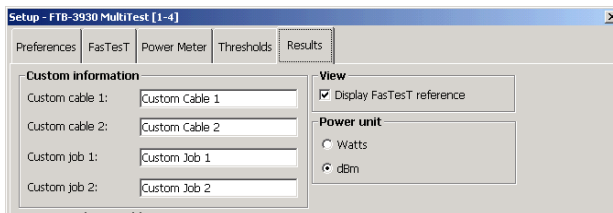

FTB-200 v2

From Edit Job
Information

Reason:

Custom job 1:

Custom job 2:



From Edit Cable
Information

Custom cable 1:

Custom cable 2:

Cable comments:



2. Set parameters and press **OK.**

Managing Test Results

Customizing and Printing Reports (FTB-500)

Customizing and Printing Reports (FTB-500)

The FTB-3930 Multifunction Loss Tester application allows you to print detailed reports including your custom selection of OLTS data (**FASTeST**, ORL and power results with cable and job information).

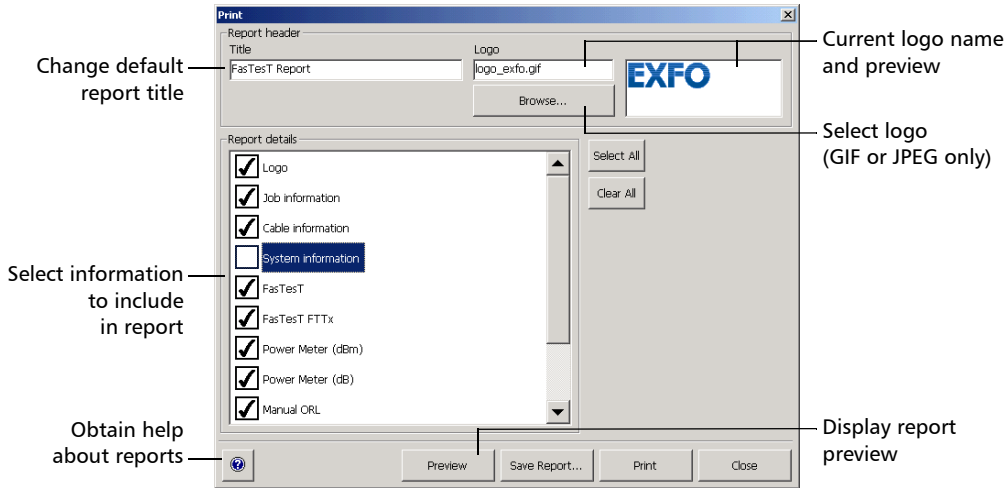

You can also save the report as an HTML or XML file to view or print it later using any HTML or XML browser.

Note: Saving a report including all items, a default title and no logo is equivalent to using the **Save As** button to save as HTML in the main window.

When you select information to include, consider the following:

- **System Information** and **Job Information** contain details from the **Job Information** section.
- **FasTesT** includes values from the Loss pane (except for references) and ORL pane (except for manual ORL values).
- Results exceeding **thresholds** are indicated with a “!”.

To print a report:

1. From the main window, press **Print**.
2. Enter a report title and press **Browse** to select a logo if desired.
3. Select items to include in the report, as follows:
 - To add or remove an item, check or clear the corresponding box.
 - To add all items, press **Select All**.
 - To remove all items, press **Clear All**.
4. If desired, press **Preview** to view the report before printing.
5. Press **Print**. For information about printer parameters, refer to your printer's user guide or to the Microsoft Windows documentation.

To save a report to a file:

1. Perform steps 1 to 4 in the above procedure.
2. Press **Save Report**, then select a name and file format (HTML or XML).

9 Using a Light Source

Your unit may contain two source ports: a 2- or 3-wavelength singlemode port and a 2-wavelength multimode port, depending on the configuration.

The source signal can be continuous (CW or high-power) or modulated (270 Hz, 1 kHz or 2 kHz) and uses the **FASTEST** ports.

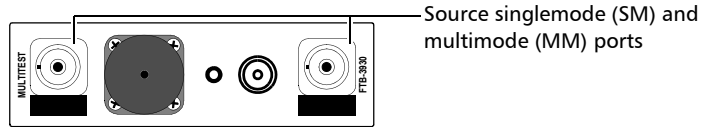

- CW signal (the default): constant power over the temperature range, but about 3 dB lower than maximum.
- High-power signal: reaches maximum power, but its power slightly varies over the temperature range.



WARNING

When a source is active, its port emits invisible laser radiation. Avoid exposure and do not stare directly into the beam. Ensure that any unused port is properly protected with a cap.

- If you switch to power meter or ORL meter, a **Source** status pane is always displayed.
- When you switch sources, the modulation remains the same. It is indicated in the data display.
- Only one source/wavelength may be active at a time. The active port (SM or MM) is indicated in the data display.
- The source status is indicated with a LED in the status bar and on the platform front panel.

Note: *The platform front panel always shows the source, VFL, ORL meter or talk set port status (even when you use other applications).*

Using a Light Source

To activate a light source:

1. Connect the fiber under test to the source port (see *Cleaning and Connecting Optical Fibers* on page 12).
2. From the main window, select the **Source/VFL** tab (units with a VFL) or the **Source** tab (units with no VFL).

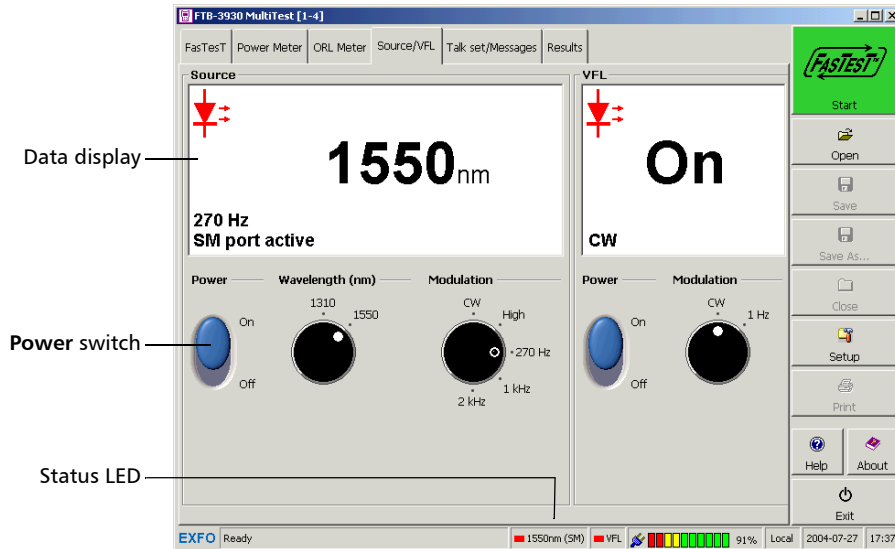

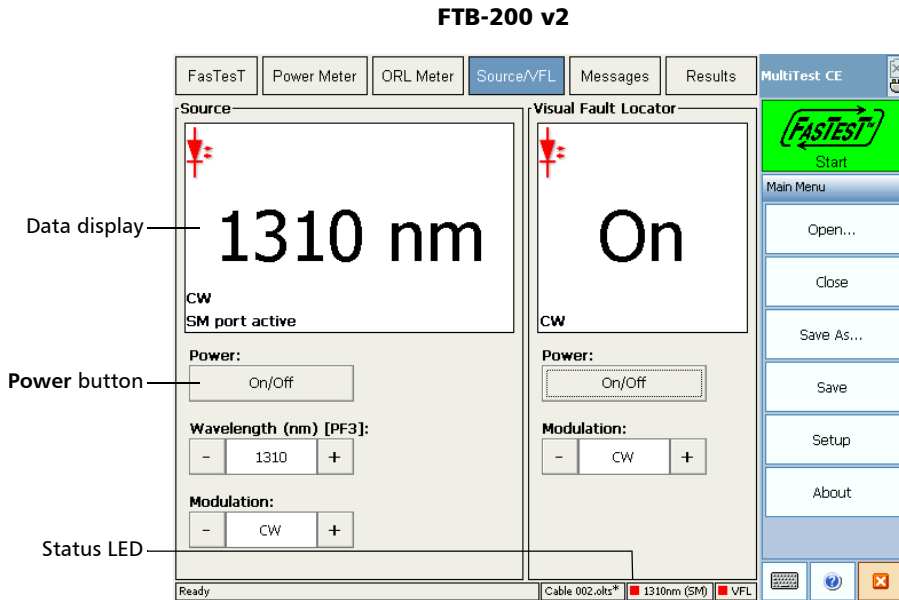

3. In the **Source** pane, select a wavelength using the **Wavelength** dial (Use the + and - buttons in the case of the FTB-200 v2 platform).
4. Slide the **Power** switch to **On** (or press the **On/Off** button in the case of the FTB-200 v2 platform).

To deactivate a light source:

Slide the **Power** switch to **Off** (or press the **On/Off** button in the case of the FTB-200 v2 platform).

To change the signal modulation:

1. Activate the source if you want.
2. Select a modulation using the **Modulation** dial (Use the + and - buttons in the case of the FTB-200 v2 platform).

10 Identifying Fiber Faults Visually

The visual fault locator (VFL) helps you identify bends, faulty connectors, splices and other causes of signal loss.

From its dedicated port, the VFL emits a red signal which becomes visible at the location of a fault on the fiber. This signal can be continuous (CW, the default) or blinking (1 Hz).

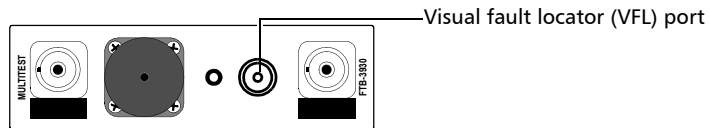

WARNING

When the VFL is active, the VFL port emits visible laser radiation. Avoid exposure and do not stare directly into the beam. Ensure that any unused port is properly protected with a cap.

- If you switch to power meter or ORL meter, a **VFL** status pane is always displayed.
- The VFL status is indicated with a LED in the status bar and on the platform front panel.

Note: *The platform front panel always shows the source, VFL, ORL meter or talk set port status (even when you use other applications).*

Identifying Fiber Faults Visually

To activate the VFL and inspect a fiber:

1. Connect the fiber under test to the VFL port (see *Cleaning and Connecting Optical Fibers* on page 12).
2. From the main window, select the **Source/VFL** tab.

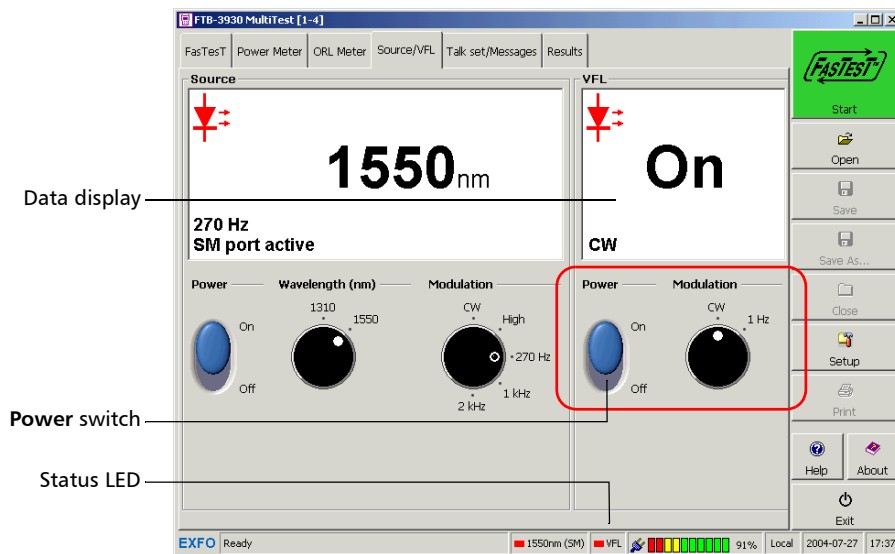

3. In the **VFL** pane, slide the **Power** switch to **On**.
4. To switch between blinking (1 Hz) and continuous (CW) signals, use the **Modulation** dial.
5. Without looking directly into the beam, examine the fiber. If light is coming out of the rubber jacket or on the side of the ferrule, the fiber is defective.
6. Deactivate the VFL by sliding the **Power** switch to **Off**.

11 **Communicating with Other Users**

Your Multifunction Loss Tester offers two ways to communicate:

- text messages
- voice (via the optional talk set)

Sending and Receiving Text Messages

To facilitate communication between opposite ends of a fiber (especially on models with no talk set), you may send text messages to compatible units (such as FOT-930, FTB-3930, FOT-920 or FTB-3920) through their **FASTEST** ports.

It is possible to send a predefined message or to write one of your own (maximum 30 characters). However, custom messages are not kept in memory.



IMPORTANT

- The messaging feature does not work with the talk set port.
- The messaging feature will not work if both units try to send a message at the same time.
- You cannot use other features while sending or receiving a message.
- You cannot cancel the operation.

To send a text message:

1. Connect the units at each end of the same fiber via their **FASTEST** ports.

Communicating with Other Users

Sending and Receiving Text Messages

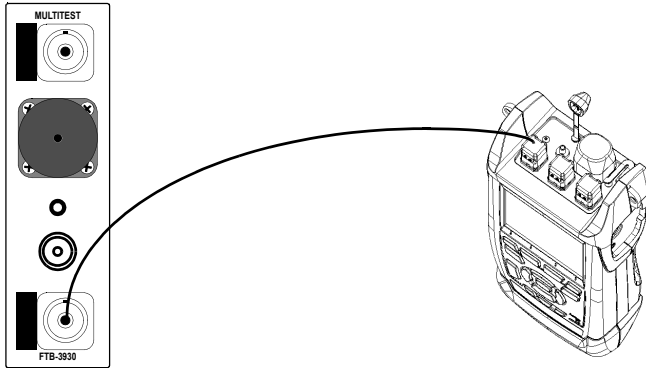

2. From the main window, select the **Talk set/Messages** tab (units with a talk set) or the **Messages** tab (units with no talk set and FTB-200 v2 units).

Status display (with port)

List of sent and received messages

3. Ensure that the port indicated (SM or MM) is the one you use. Otherwise, do as follows:
 - 3a. In the function bar, press **Setup**, then select the **FASTeST** tab.
 - 3b. Change the **FASTeST** port, then return to the **Messages** pane.
4. Scroll through the **Predefined messages** list and select a message.
OR
Enter a custom message in the **New message** text box.
5. Press the **Send** button next to your type of message (predefined or new).

After a few seconds, your message will automatically appear on the receiving unit (if its Multifunction Loss Tester application runs) and on the **Message log** pane. If an incompatible unit (or no unit) is detected at the other end, or if the **FASTeST** port of the receiving unit is in use, an error message will appear.

When you receive a message:

Your unit emits a short beep and displays the received message.

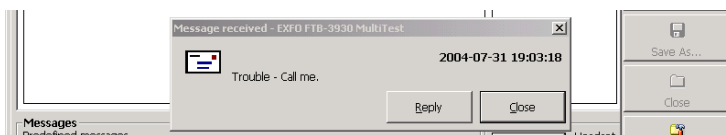

- Press **Close** to clear the display and return to your previous function.
- Press **Reply** to access the **Messages** tab and reply to the message. You will then need to return to your previous function manually. *However, your last readings will be lost.*

Note: *If the message was written with a language not supported by your unit, you will see unreadable characters only.*

Communicating by Voice

With the optional talk set, you can establish full-duplex digital voice communication over a dedicated fiber, even while other functions are in use.

The talk set provides adjustable headset volume and uses a dedicated port. It is not compatible with the FOT-920 or FTB-3920 talk sets.

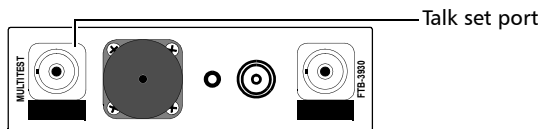

Note: You may use any commercially available headset equipped with a microphone. It is also compatible with the GP-92B speakerphone.

While communication is established, the actions and displays of each unit may differ as follows:

- You can send or receive a call at any time, except during a **FASTEST**. To receive a call, you must be running the Multifunction Loss Tester application.
- Once communication is established, it will be maintained even if you use the unit's other test tools (including **FASTEST**).
- If communication is lost, calling unit will automatically try to reestablish communication.

To communicate between units:

Calling Unit

1. Connect the calling unit to one end of the fiber via its talk set port, and plug in your headset.

Receiving Unit

1. Connect the receiving unit to the other end of the fiber via its talk set port, and plug in your headset.

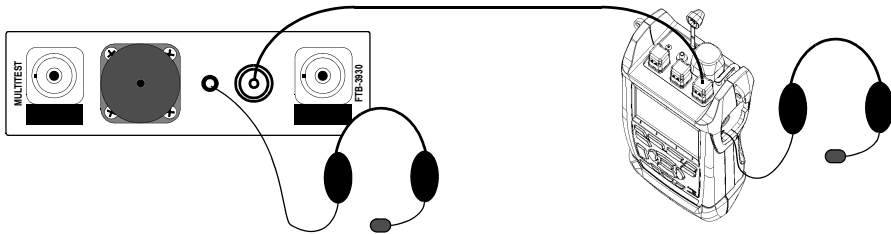

2. From the main window, select the **Talk set/Messages** tab (**Messages** tab for the FTB-200 v2 unit).

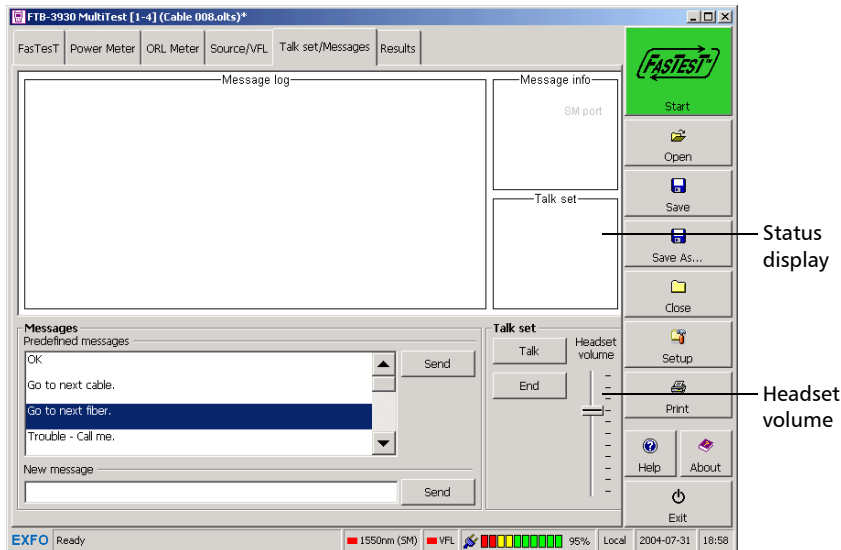

Communicating with Other Users

Communicating by Voice

Calling Unit

3. Press **Talk**. Your unit establishes communication with receiving unit.



If no compatible unit is detected at the other end, a message appears.

4. Talk to the receiving unit.
5. To end the communication, press **End** from the **Talk set** pane.

Receiving Unit

When receiving the call, the unit beeps. A phone icon appears to indicate that communication is established.

2. Simply answer (no need to press a key).
3. To end the communication, press **End** from the **Talk set** pane.

To adjust the headset volume (calling or receiving unit):

From the **Talk set** pane, move the **Headset volume** slider to the top (volume increase) or to the bottom (volume decrease).

You cannot adjust or mute the ring sound.

12 Maintenance

To help ensure long, trouble-free operation:

- Always inspect fiber-optic connectors before using them and clean them if necessary.
- Keep the unit free of dust.
- Clean the unit casing and front panel with a cloth slightly dampened with water.
- Store unit at room temperature in a clean and dry area. Keep the unit out of direct sunlight.
- Avoid high humidity or significant temperature fluctuations.
- Avoid unnecessary shocks and vibrations.
- If any liquids are spilled on or into the unit, turn off the power immediately, disconnect from any external power source, remove the batteries and let the unit dry completely.



WARNING

The use of controls, adjustments and procedures, namely for operation and maintenance, other than those specified herein may result in hazardous radiation exposure or impair the protection provided by this unit.

Cleaning EUI Connectors

Regular cleaning of EUI connectors will help maintain optimum performance. There is no need to disassemble the unit.



IMPORTANT

If any damage occurs to internal connectors, the module casing will have to be opened and a new calibration will be required.

Maintenance

Cleaning EUI Connectors



WARNING

Looking into the optical connector while the light source is active **WILL** result in permanent eye damage. EXFO strongly recommends to **TURN OFF** the unit before proceeding with the cleaning procedure.

To clean EUI connectors:

1. Remove the EUI from the instrument to expose the connector baseplate and ferrule.

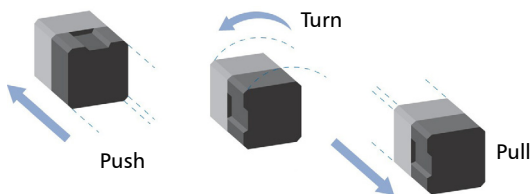

2. Moisten a 2.5 mm cleaning tip with *one drop* of isopropyl alcohol (alcohol may leave traces if used abundantly).
3. Slowly insert the cleaning tip into the EUI adapter until it comes out on the other side (a slow clockwise rotating movement may help).

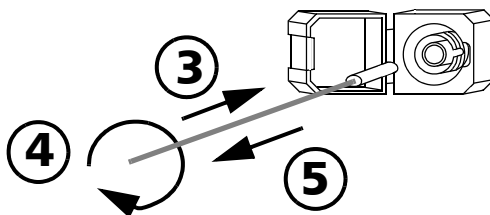

4. Gently turn the cleaning tip one full turn, then continue to turn as you withdraw it.
5. Repeat steps 3 to 4 with a dry cleaning tip.

Note: Make sure you don't touch the soft end of the cleaning tip.

6. Clean the ferrule in the connector port as follows:

6a. Deposit *one drop* of isopropyl alcohol on a lint-free wiping cloth.



IMPORTANT

Isopropyl alcohol may leave residues if used abundantly or left to evaporate (about 10 seconds).

Avoid contact between the tip of the bottle and the wiping cloth, and dry the surface quickly.

6b. Gently wipe the connector and ferrule.

6c. With a dry lint-free wiping cloth, gently wipe the same surfaces to ensure that the connector and ferrule are perfectly dry.

6d. Verify connector surface with a portable fiber-optic microscope (for example, EXFO's FOMS) or fiber inspection probe (for example, EXFO's FIP).

7. Put the EUI back onto the instrument (push and turn clockwise).

8. Throw out cleaning tips and wiping cloths after one use.

Cleaning Detector Ports

Regular cleaning of detectors will help maintain measurement accuracy.



IMPORTANT

Always cover detectors with protective caps when unit is not in use.

To clean detector ports:

1. Remove the protective cap and adapter (FOA) from the detector.
2. If the detector is dusty, blow dry with compressed air.
3. Being careful not to touch the soft end of the swab, moisten a cleaning tip with *only one drop* of isopropyl alcohol.



IMPORTANT

Alcohol may leave traces if used abundantly. Do not use bottles that distribute too much alcohol at a time.

4. While applying light pressure (to avoid breaking the detector window), gently rotate the cleaning tip on the detector window.
5. Repeat step 4 with a dry cleaning tip or blow dry with compressed air.
6. Discard the cleaning tips after one use.

Cleaning VFL-Type Connectors

VFL-type connectors are fixed on your unit and can be cleaned using a mechanical cleaner.



WARNING

Verifying the surface of the connector with a fiber-optic microscope WHILE THE UNIT IS ACTIVE WILL result in permanent eye damage.

To clean a connector using a mechanical cleaner:

1. Insert the mechanical into the optical adapter, and push the outer shell into the cleaner.

Note: *The cleaner makes a clicking sound to indicate that the cleaning is done.*

2. Verify connector surface with a portable fiber-optic microscope (for example, EXFO's FOMS) or fiber inspection probe (for example, EXFO's FIP).



WARNING

Only use an EXFO battery. Batteries from other suppliers could result in serious damage to your unit, or personal injuries. Contact EXFO for more information.

Maintenance

Recalibrating the Unit



WARNING

Do not throw batteries into fire or water and do not short-circuit the batteries' electrical contacts. Do not disassemble.

Recalibrating the Unit

EXFO manufacturing and service center calibrations are based on the ISO/IEC 17025 standard (*General Requirements for the Competence of Testing and Calibration Laboratories*). This standard states that calibration documents must not contain a calibration interval and that the user is responsible for determining the re-calibration date according to the actual use of the instrument.

The validity of specifications depends on operating conditions. For example, the calibration validity period can be longer or shorter depending on the intensity of use, environmental conditions and unit maintenance, as well as the specific requirements for your application. All of these elements must be taken into consideration when determining the appropriate calibration interval of this particular EXFO unit.

Under normal use, the recommended interval for your FTB-3930 Multifunction Loss Tester is: one year.

For newly delivered units, EXFO has determined that the storage of this product for up to six months between calibration and shipment does not affect its performance (EXFO Policy PL-03).

To help you with calibration follow-up, EXFO provides a special calibration label that complies with the ISO/IEC 17025 standard and indicates the unit calibration date and provides space to indicate the due date. Unless you have already established a specific calibration interval based on your own empirical data and requirements, EXFO would recommend that the next calibration date be established according to the following equation:

Next calibration date = Date of first usage (if less than six months after the calibration date) + Recommended calibration period (one year)

To ensure that your unit conforms to the published specifications, calibration may be carried out at an EXFO service center or, depending on the product, at one of EXFO's certified service centers. Calibrations at EXFO are performed using standards traceable to national metrology institutes.

Note: *You may have purchased a FlexCare plan that covers calibrations. See the Service and Repairs section of this user documentation for more information on how to contact the service centers and to see if your plan qualifies.*

Note: *The FlexCare warranty program includes Calibration/Verification packages (see Service and Repairs on page 85).*

Recycling and Disposal (Applies to European Union Only)

For complete recycling/disposal information as per European Directive WEEE 2012/19/UE, visit the EXFO Web site at www.exfo.com/recycle.

13 Troubleshooting

Solving Common Problems

Problem	Possible Cause	Solution
During offset nulling, you get the following message: “Light detected during nulling.”	Light reaches at least one detector (power meter or FASTEST).	Ensure protective caps are tightly screwed on FASTEST and power meter ports and perform the nulling again. Do not use rubber cover.
When using the power meter, you get Power Too Low or Power Too High .	Power of the signal received at the power meter port is outside its measurement range.	Check the connections. Ensure you use the proper fiber and connector type and that you use your power meter within specifications.
When measuring ORL, you get Too Much Power .	Measured reflected power is higher than emitted power. The ORL reference is incorrect.	Always perform ORL reference before each ORL measurement.
When measuring ORL, you get ORL exceeds .	Reflection is below sensitivity of ORL meter.	Perform an ORL zero measurement to increase the sensitivity of the detector. Ensure mandrel is correct and that patchcord and connectors are in good condition.

Troubleshooting

Solving Common Problems

Problem	Possible Cause	Solution
Unable to establish FASTEST communication.	<ul style="list-style-type: none"> ➤ Remote unit's FASTEST port is in use. ➤ Remote unit is not compatible. ➤ Selected port on master unit differs from actual port to which fiber is connected. ➤ Compatibility set to FOT-930 / FTB-3930 but remote unit is not an FOT-930 or FTB-3930. 	<ul style="list-style-type: none"> ➤ Wait until FASTEST completes, turn source and ORL meter off or exit Probe mode (FOT-930). ➤ Make sure remote unit is an FOT-930, FTB-3930, FOT-920 or FTB-3920. ➤ Set the port (SM or MM) correctly in Setup (FASTEST tab) on master unit. ➤ Set the compatibility to FOT-920 / FTB-3920 in Setup (FASTEST tab) on master unit.
During FASTEST , you get a message saying that loopback reference was not performed.	Loopback reference was selected, but not performed (or reference is outdated).	Perform a loopback reference before FASTEST measurement.
ORL values are inaccurate for short fibers at 1310 nm during a FASTEST .	—	Measure ORL manually.
Unable to communicate with an FOT-920 using the talk set.	Talk sets of the FOT-920 and FOT-930/FTB-3930 are not compatible.	Use text messaging instead.
Unable to establish connection with compatible talk set.	Probe mode is activated on remote unit (FOT-930 only).	Deactivate Probe mode.

Problem	Possible Cause	Solution
Unable to send a text message.	<ul style="list-style-type: none"> ▶ Selected port differs from actual port to which fiber is connected. ▶ Receiving unit's port is in use. ▶ Remote unit is not compatible. 	<ul style="list-style-type: none"> ▶ On the sending unit, set the correct port (SM or MM) in Setup (FASTeST tab). ▶ Wait until FASTeST completes, turn source and ORL meter off or exit Probe mode (FOT-930). ▶ Make sure remote unit is an FOT-930, FTB-3930, FOT-920 or FTB-3920.
On Results tab, a box indicates "Invld" instead of a numerical value.	The application is unable to calculate the FASTeST ORL value (e.g., at 1310 nm for short fibers).	Perform the measurements again.
On Results tab, a box indicates " - - - " instead of a numerical value.	The calculated value makes no sense (e.g., negative ORL value).	Perform the measurements again. Note that the calculated value is usually shown on the printed report.
When printing a report, rightmost columns are not printed.	The Fiber ID column is too wide. The width of this column is determined with the widest name.	Rename fiber IDs that have a long name.
When saving data in text formats, some ORL values are higher than the indicated sensitivity.	Saved text files containing symbols such as ">" may not open properly in some applications.	The actual measured value is used instead, even if it is not accurate.

Obtaining Online Help

Context-sensitive and interactive help is conveniently available at all times to guide you through the use of your application.

Note: You will also find a printable PDF version of the FTB-3930 Multifunction Loss Tester user guide on your installation CD.

To access online help:

Anywhere in the application, press the  button (or F1 on a keyboard) to get help about the current function.

OR

Press **About** in the button bar, then press **User Guide**.

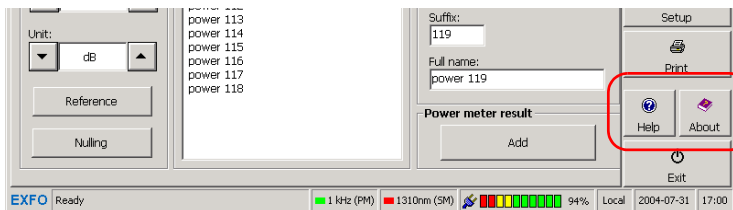

Contacting the Technical Support Group

To obtain after-sales service or technical support for this product, contact EXFO at one of the following numbers. The Technical Support Group is available to take your calls from Monday to Friday, 8:00 a.m. to 7:00 p.m. (Eastern Time in North America).

Technical Support Group

400 Godin Avenue
Quebec (Quebec) G1M 2K2
CANADA

1 866 683-0155 (USA and Canada)
Tel.: 1 418 683-5498
Fax: 1 418 683-9224
support@exfo.com

For detailed information about technical support, and for a list of other worldwide locations, visit the EXFO Web site at www.exfo.com.

If you have comments or suggestions about this user documentation, you can send them to customer.feedback.manual@exfo.com.

To accelerate the process, please have information such as the name and the serial number (see the product identification label), as well as a description of your problem, close at hand.

You may also be requested to provide software and module version numbers. This information, as well as technical support contact information, can be found by clicking **About** in the function bar

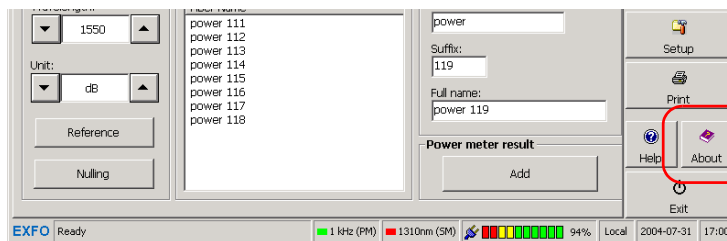

Transportation

Maintain a temperature range within specifications when transporting the unit. Transportation damage can occur from improper handling. The following steps are recommended to minimize the possibility of damage:

- Pack the unit in its original packing material when shipping.
- Avoid high humidity or large temperature fluctuations.
- Keep the unit out of direct sunlight.
- Avoid unnecessary shocks and vibrations.

14 **Warranty**

General Information

EXFO Inc. (EXFO) warrants this equipment against defects in material and workmanship for a period of three years from the date of original shipment. EXFO also warrants that this equipment will meet applicable specifications under normal use.

During the warranty period, EXFO will, at its discretion, repair, replace, or issue credit for any defective product, as well as verify and adjust the product free of charge should the equipment need to be repaired or if the original calibration is erroneous. If the equipment is sent back for verification of calibration during the warranty period and found to meet all published specifications, EXFO will charge standard calibration fees.



IMPORTANT

The warranty can become null and void if:

- **unit has been tampered with, repaired, or worked upon by unauthorized individuals or non-EXFO personnel.**
- **warranty sticker has been removed.**
- **case screws, other than those specified in this guide, have been removed.**
- **case has been opened, other than as explained in this guide.**
- **unit serial number has been altered, erased, or removed.**
- **unit has been misused, neglected, or damaged by accident.**

THIS WARRANTY IS IN LIEU OF ALL OTHER WARRANTIES EXPRESSED, IMPLIED, OR STATUTORY, INCLUDING, BUT NOT LIMITED TO, THE IMPLIED WARRANTIES OF MERCHANTABILITY AND FITNESS FOR A PARTICULAR PURPOSE. IN NO EVENT SHALL EXFO BE LIABLE FOR SPECIAL, INCIDENTAL, OR CONSEQUENTIAL DAMAGES.

Warranty

Liability

Liability

EXFO shall not be liable for damages resulting from the use of the product, nor shall be responsible for any failure in the performance of other items to which the product is connected or the operation of any system of which the product may be a part.

EXFO shall not be liable for damages resulting from improper usage or unauthorized modification of the product, its accompanying accessories and software.

Exclusions

EXFO reserves the right to make changes in the design or construction of any of its products at any time without incurring obligation to make any changes whatsoever on units purchased. Accessories, including but not limited to fuses, pilot lamps, batteries and universal interfaces (EUI) used with EXFO products are not covered by this warranty.

This warranty excludes failure resulting from: improper use or installation, normal wear and tear, accident, abuse, neglect, fire, water, lightning or other acts of nature, causes external to the product or other factors beyond the control of EXFO.



IMPORTANT

In the case of products equipped with optical connectors, EXFO will charge a fee for replacing connectors that were damaged due to misuse or bad cleaning.

Certification

EXFO certifies that this equipment met its published specifications at the time of shipment from the factory.

Service and Repairs

EXFO commits to providing product service and repair for five years following the date of purchase.

To send any equipment for service or repair:

- 1.** Call one of EXFO's authorized service centers (see *EXFO Service Centers Worldwide* on page 86). Support personnel will determine if the equipment requires service, repair, or calibration.
- 2.** If equipment must be returned to EXFO or an authorized service center, support personnel will issue a Return Merchandise Authorization (RMA) number and provide an address for return.
- 3.** If possible, back up your data before sending the unit for repair.
- 4.** Pack the equipment in its original shipping material. Be sure to include a statement or report fully detailing the defect and the conditions under which it was observed.
- 5.** Return the equipment, prepaid, to the address given to you by support personnel. Be sure to write the RMA number on the shipping slip. *EXFO will refuse and return any package that does not bear an RMA number.*

Note: *A test setup fee will apply to any returned unit that, after test, is found to meet the applicable specifications.*

After repair, the equipment will be returned with a repair report. If the equipment is not under warranty, you will be invoiced for the cost appearing on this report. EXFO will pay return-to-customer shipping costs for equipment under warranty. Shipping insurance is at your expense.

Routine recalibration is not included in any of the warranty plans. Since calibrations/verifications are not covered by the basic or extended warranties, you may elect to purchase FlexCare Calibration/Verification Packages for a definite period of time. Contact an authorized service center (see *EXFO Service Centers Worldwide* on page 86).

Warranty

EXFO Service Centers Worldwide

EXFO Service Centers Worldwide

If your product requires servicing, contact your nearest authorized service center.

EXFO Headquarters Service Center

400 Godin Avenue
Quebec (Quebec) G1M 2K2
CANADA

1 866 683-0155 (USA and Canada)
Tel.: 1 418 683-5498
Fax: 1 418 683-9224
support@exfo.com

EXFO Europe Service Center

Winchester House, School Lane
Chandlers Ford, Hampshire S053 4DG
ENGLAND

Tel.: +44 2380 246800
Fax: +44 2380 246801
support.europe@exfo.com

EXFO Telecom Equipment (Shenzhen) Ltd.

3rd Floor, Building 10,
Yu Sheng Industrial Park (Gu Shu
Crossing), No. 467,
National Highway 107,
Xixiang, Bao An District,
Shenzhen, China, 518126

Tel: +86 (755) 2955 3100
Fax: +86 (755) 2955 3101
support.asia@exfo.com

A Technical Specifications



IMPORTANT

The following technical specifications can change without notice. The information presented in this section is provided as a reference only. To obtain this product's most recent technical specifications, visit the EXFO Web site at www.exfo.com.

TECHNICAL SPECIFICATIONS					
External Power Meter	FTB-3932	FTB-3932X	FTB-3933		
Detector type	Ge	GeX	InGaAs		
Measurement range (dBm)	10 to -70	26 to -55	6 to -73		
Uncertainty ^{b, c}	± 5 % ± 0.1 nW	± 5 % ± 3 nW	± 5 % ± 0.05 nW		
Wavelength range (nm)	800 to 1650	800 to 1650	800 to 1650		
Display resolution ^b (dB)	0.01	0.01	0.01		
Calibrated wavelengths	40	42	40		
Recommended recalibration period (years)	3	3	3		
Automatic offset nulling ^d	Yes	Yes	Yes		
Measurement-distance units	kilometers, meters, kilofeet, feet, miles				
Sources	Standard	-4	-5	-12C (second port)	-12D (second port)
Wavelengths ^e (nm)	1310 ± 20 1550 ± 20	1310 ± 20 1550 ± 20 1625 ± 10	1310 ± 20 1490 ± 10 1550 ± 20	850 ± 25 1300 +50/-20	850 ± 25 1300 +50/-20
Emitter type	Laser	Laser	Laser	LED	LED
Minimum output power ^e (dBm)	-1/-1	-1/-4/-7	-1/-7/-4	-27/-27 (50/125 μm) ⁱ	-21/-21 (62.5/125 μm) ⁱ
Spectral width ^f (nm)	≤ 5/≤ 5	≤ 5/≤ 5/≤ 5	≤ 5/≤ 5/≤ 5	50/135	50/135
Stability ^g (8 hours) (dB)	± 0.05	± 0.05	± 0.05	± 0.05	± 0.05
FasTesT	Standard	-4	-5	-12C (second port)	-12D (second port)
Wavelengths (nm)	1310 1550	1310 1550 1625	1310 1490 1550	850 1300	850 1300
Loss range ^h (dB)	60	56	56	40	46
Loss precision ⁱ (repeatability) (dB)					
side-by-side	0.15	0.15	0.15	0.15	0.15
loopback	0.25	0.25	0.25	0.25	0.25
Length measurement range (km)	200	200	200	5	5
Length measurement uncertainty (typical) ^j	± (10 m + 1 % x length)				

Technical Specifications

SPECIFICATIONS					
Dedicated ORL Wavelengths	All SM	Talk Set		VFL ^l	
ORL range (APC / UPC) (dB)	65/55	Emitter type	Laser	Emitter type	Laser
ORL uncertainty ^j (dB)	± 0.5	Wavelength (nm)	1550 ± 20	Wavelength (nm)	650
Resolution ^b (dB)	0.01	Dynamic range at 1550 nm (dB)	45	Output power (dBm)	3
		Dynamic range MM ^k (dB)	40		

Notes

- At 23 °C ± 1 °C and 1550 nm with FC connector and on batteries, unless otherwise specified.
- Resolution, uncertainty and linearity are functions of input power; uncertainty is valid at calibration conditions.
- Up to 20 dBm for GeX.
- Power of > -45 dBm for Ge, > -30 dBm for GeX and > -47 dBm for InGaAs.
- In High source mode.
- As defined by Telcordia TR-TSY-000887, rms for lasers and at -3 dB for LEDs; typical values for LEDs.
- After a warmup time of 6 minutes, in CW source mode.
- Typical value, at 1550 nm for SM and 850 nm for MM.
- Typical value.
- For fiber length ≤ 120 km.
- For graded-index MM fibers; typical.

GENERAL SPECIFICATIONS		
Size (H x W x D)	96 mm x 25 mm x 260 mm (3 3/4 in x 1 in x 10 1/4 in)	
Weight	0.5 kg (1.1 lb)	
Temperature		
Operating	0 °C to 50 °C	(32 °F to 122 °F)
Storage ^l	-40 °C to 70 °C	(-40 °F to 158 °F)
Relative humidity	0% to 95% non-condensing	
Warranty (years)	3	

Index

!	16
A	
About button	81
after-sales service	81
analyzing results	3
applications, typical	3
autonaming, MultiTest	10, 14
B	
backreflection measurement	32
C	
cable and fiber names	14
calibrated wavelengths	2
cancelling dark current effects	22
caution	
of personal hazard	4
of product hazard	4
certification information	v
circuit performance	22
cleaning	
detector ports	72
EUI connectors	69
fiber ends	12
front panel	69
VFL connectors	73
color, data display	9
communication	
talk set	66
text messages	63
component under test. <i>see</i> DUT	
configuring	
application	9–17
printer	55
connector cleaner	73
connectors, cleaning	69
connectors, illustration of	1–3
conventions, safety	4
creating test report	54
customer service	85
customizing test report	54
D	
dark current effects, eliminating	22
data	
printing	54
transferring	3
description	
ORL meter	29
power meter	19
detection, modulation	2
detector	
types	2
<i>see also</i> power meter	
detector port, cleaning	72
device under test. <i>see</i> DUT	
display color	9
distance unit	9
DUT	23, 26, 30, 36, 39
E	
electronic offsets, eliminating	22
ending talk set communication	68
equipment returns	85
establishing talk set communication	66
EUI	
connector adapter	11
dust cap	11
EUI connectors, cleaning	69
exclamation mark	16

Index

F

FasTesT

- description..... 1
- port 1
- thresholds..... 16
- wavelengths, selecting 36

favorite wavelengths..... 2

features..... 1

fiber and cable names..... 14

fiber ends, cleaning..... 12

fiber length measurement..... 1, 35, 45, 47

fiber under test. *see* DUT

file formats..... 3

front panel, cleaning..... 69

FTTx

- mode..... 45
- mode/wavelengths 36
- results..... 3

H

hazard, laser radiation..... 7

headset

- connector 1
- using 67

help. *see* online help

high-power source 2

I

identification label 81

insertion loss (IL). *see* loss

intermittent signal..... 62

L

label, identification 81

laser safety information 7

laser source. *see* source

length

- fiber..... 1, 35, 45, 47
- unit..... 9

light source. *see* source

list of favorite wavelengths 2, 20

loopback referencing method 38

loss measurement

- description..... 1, 2
- performing..... 26
- reference..... 23, 38
- saving results 28
- thresholds..... 16

see also power meter

M

mail feature. *see* text messages

maintenance

- detector ports 72
- EUI connectors..... 69
- front panel..... 69
- general information 69

measurement units..... 9

measuring

- loss 26
- ORL 29
- power 26

mechanical connector cleaning 73

message feature. *see* text messages

modulation

- detection of..... 2, 27
- source 2, 57
- VFL..... 61

mounting EUI connector adapter 11

multimode port..... 1, 35, 57

multiple referencing 38

N

naming results automatically..... 10, 14

nulling offsets. *see* offset nulling

O

offset nulling 2, 22

online help 80

optical detector performance..... 22

- optical return loss. see ORL measurement
- ORL
- measurement description 1, 29
 - measurement thresholds 16
 - meter port 1
 - performing measurement 32
 - zero measurement 30
- P**
- pass/fail thresholds. see thresholds
- PDF. see online help
- performing
- null measurement 22
 - ORL measurement 32
 - ORL zero measurement 30
 - power or loss measurement 26
- PON testing 3
- ports, illustration of 1–3
- power measurement. see loss
- power meter
- description 2, 19
 - detector types 2
 - display 19
 - modulated signal detection 27
 - port 1
 - setting wavelength 19
 - wavelength list 20
- power reference, setting 23
- prefix, naming 14
- printer configuration 55
- printing test reports 3, 54
- product
- features 1
 - identification label 81
 - specifications 87
- protective cap 72
- R**
- radiation hazard, laser 7
- receiving text message 65
- red, value in 16
- reference measurement
- loopback method 38
 - multiple 38
 - power meter 23
 - side-by-side method 38
- reference, zero power 22
- report printing 3, 54
- results
- autonaming 14
 - ORL measurement 34
 - processing features 3
 - saving 10
- return loss. see ORL measurement
- return merchandise authorization (RMA) 85
- ring volume 68
- S**
- safety
- caution 4
 - conventions 4
 - information 7
 - warning 4
- saving
- power/loss results 28
 - results automatically 10
- sending text message 63
- service and repairs 85
- service centers 86
- setting
- power meter wavelength 19
 - power reference 23
 - source wavelength 58
 - thresholds 16
- shipping to EXFO 85
- side-by-side referencing method 38
- signal, modulating 57, 59, 61, 62
- singlemode port 1, 35, 57
- source
- activating 58
 - high-power 2
 - modulating signal 2, 57, 59

Index

- multimode 2
- operation and display 57
- port 1
- setting wavelength 58
- singlemode 2
- status 57
- specifications, product 87
- storage requirements 69
- stored data, printing 54
- suffix, naming 14
- symbols, safety 4
- system under test. *see* DUT

T

- talk set
 - compatibility 66
 - description 66
 - ending communication 68
 - establishing communication 66
 - placing a call 67
 - port 1, 66
 - receiving a call 68
 - voice and ring volumes 68
- technical specifications 87
- technical support 81
- temperature for storage 69
- test report. *see* report
- test tools
 - light source 57
 - ORL meter 29
 - power meter 19
- text messages
 - compatibility 63
 - description 3, 63
 - modifying 63
 - receiving 65
 - sending 63
- thresholds 3, 16
- tools
 - talk set 66
 - visual fault locator 61

- see also* test tools
- transferring data 3
- transportation requirements 69, 82
- typical applications 3

U

- units of measurement 9
- user guide. *see* online help

V

- VFL
 - modulating signal 61, 62
 - operation and display 62
 - performing a test 62
 - port 1
 - status 61
- VFL, cleaning 73
- visual fault locator. *see* VFL
- voice volume 68
- volumes (ring and voice) 68

W

- warranty
 - certification 84
 - exclusions 84
 - general 83
 - liability 84
 - null and void 83
- wavelengths
 - calibrated 2
 - FasTesT 36
 - list of favorite 2, 20
 - power meter 19
 - source 58

Z

- zero measurement, ORL 30
- zero-power reference 22

NOTICE

通告

CHINESE REGULATION ON RESTRICTION OF HAZARDOUS SUBSTANCES

中国关于有害物质限制的规定

NAMES AND CONTENTS OF THE TOXIC OR HAZARDOUS SUBSTANCES OR ELEMENTS CONTAINED IN THIS EXFO PRODUCT



包含在本 EXFO 产品中的有毒有害物质或元素的名称和含量

O	Indicates that this toxic or hazardous substance contained in all of the homogeneous materials for this part is below the limit requirement in SJ/T11363-2006 表示该有毒有害物质在该部件所有均质材料中的含量均在 SJ/T11363-2006 标准规定的限量要求以下。
X	Indicates that this toxic or hazardous substance contained in at least one of the homogeneous materials used for this part is above the limit requirement in SJ/T11363-2006 表示该有毒有害物质至少在该部件的某一均质材料中的含量超出 SJ/T11363-2006 标准规定的限量要求。

Part Name 部件名称	Toxic or hazardous Substances and Elements 有毒有害物质和元素					
	Lead 铅 (Pb)	Mercury 汞 (Hg)	Cadmium 镉 (Cd)	Hexavalent Chromium 六价铬 (Cr VI)	Polybrominated biphenyls 多溴联苯 (PBB)	Polybrominated diphenyl ethers 多溴二苯醚 (PBDE)
Enclosure 外壳	O	O	O	O	O	O
Electronic and electrical sub-assembly 电子和电子组件	X	O	X	O	X	X
Optical sub-assembly ^a 光学组件 ^a	X	O	O	O	O	O
Mechanical sub-assembly ^a 机械组件 ^a	O	O	O	O	O	O

a. If applicable.
如果适用。

MARKING REQUIREMENTS
标注要求

Product 产品	Environmental protection use period (years) 环境保护使用期限 (年)	Logo 标志
This EXFO product 本 EXFO 产品	10	
Battery ^a 电池 ^a	5	

- a. If applicable.
如果适用。

P/N: 1066510

www.EXFO.com · info@exfo.com

CORPORATE HEADQUARTERS	400 Godin Avenue	Quebec (Quebec) G1M 2K2 CANADA Tel.: 1 418 683-0211 · Fax: 1 418 683-2170
EXFO AMERICA	3400 Waterview Parkway Suite 100	Richardson, TX 75080 USA Tel.: 1 972-761-927 · Fax: 1 972-761-9067
EXFO EUROPE	Winchester House, School Lane	Chandlers Ford, Hampshire S053 4DG ENGLAND Tel.: +44 2380 246 800 · Fax: +44 2380 246 801
EXFO ASIA-PACIFIC	62 Ubi Road 1, #09-01/02 Oxley Bizhub 2	SINGAPORE 408734 Tel.: +65 6333 8241 · Fax: +65 6333 8242
EXFO CHINA	Beijing Global Trade Center, Tower C, Room 1207, 36 North Third Ring Road East, Dongcheng District	Beijing 100013 P. R. CHINA Tel.: +86 (10) 5825 7755 · Fax: +86 (10) 5825 7722
EXFO SERVICE ASSURANCE	270 Billerica Road	Chelmsford MA, 01824 USA Tel.: 1 978 367-5600 · Fax: 1 978 367-5700
EXFO FINLAND	Elektroniikkatie 2	FI-90590 Oulu, FINLAND Tel.: +358 (0) 403 010 300 · Fax: +358 (0) 8 564 5203
TOLL-FREE	(USA and Canada)	1 800 663-3936

© 2014 EXFO Inc. All rights reserved.
Printed in Canada (2014-04)

