

FTB-610

Advanced WB Copper Test Module

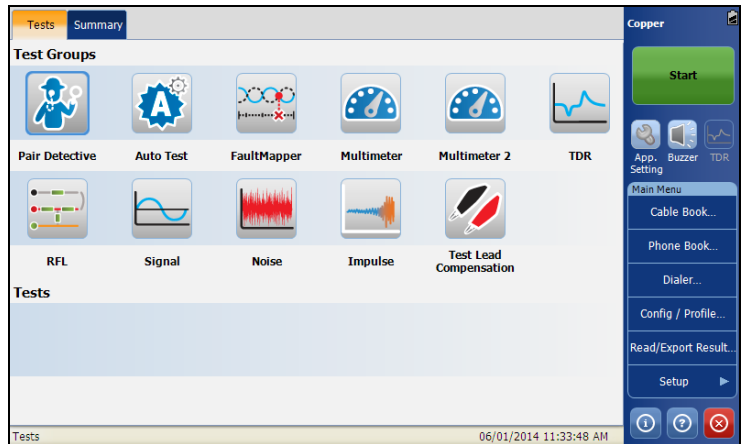

Copyright Information

Copyright © 2012–2014 EXFO Inc. All rights reserved. No part of this publication may be reproduced, stored in a retrieval system or transmitted in any form, be it electronically, mechanically, or by any other means such as photocopying, recording or otherwise, without the prior written permission of EXFO Inc. (EXFO).

Information provided by EXFO is believed to be accurate and reliable. However, no responsibility is assumed by EXFO for its use nor for any infringements of patents or other rights of third parties that may result from its use. No license is granted by implication or otherwise under any patent rights of EXFO.

EXFO's Commerce And Government Entities (CAGE) code under the North Atlantic Treaty Organization (NATO) is 0L8C3.

The information contained in this publication is subject to change without notice.

Trademarks

EXFO's trademarks have been identified as such. However, the presence or absence of such identification does not affect the legal status of any trademark.

Units of Measurement

Units of measurement in this publication conform to SI standards and practices.

September 12, 2014

Version number: 6.0.0

Contents

Copyright Information	ii
Certification Information	vii
1 Introducing the FTB-610 Advanced WB Copper Test Module	1
Key Features and Benefits	1
Typical Applications	2
Software Options	3
Conventions	4
2 Safety Information	5
Electrical Safety Information	6
Equipment Ratings	7
3 Getting Started	9
Starting Module Application	9
Cable Connections	10
Inserting and Removing Test Modules	12
Performing FTB-1 Software Updates	17
Usual Tab Elements	18
4 Advanced WB Copper Application	21
Using the Graphical User Interface	21
Main Window	21
Status Bar	22
Title Bar	23
Test Information and Control	23
Main Menu	23
Application buttons	24
5 Copper Tests: Using the Main Menu	27
Start/Stop Button	27
Cable Book	28
Phone Book	36
Dialer	46
Config/Profile	50
Application Settings	66
Factory Default	73
Save Test	74

6 Reading and Exporting Saved Results	79
Result File	79
Reading the Result File	80
Export Results	87
7 Pair Detective Test	89
Pair Detective	89
Multimeter	96
TDR	97
Summary	98
8 Auto Test	99
POTS Auto Test	99
Summary	104
User Auto Test	105
Summary	113
9 FaultMapper Test	115
FaultMapper	115
TDR	120
Summary	121
10 Multimeter Tests	123
Multimeter Main Page	124
Voltage Test	125
Current Test	134
Resistance Test	143
Capacitance/Opens Test	150
Resistive Balance Test	157
Balance Test	161
11 Multimeter 2 Tests	169
Multimeter 2 Main Page	169
Isolation Test	170
Locator Tone Test	176
Load Coils Test	179
Station Ground	182
12 TDR Test	187
Auto TDR	188
Manual TDR	191
Xtalk TDR	199
Summary	202

13 RFL Test	203
RFL-2-Wire	203
RFL-4-Wire	206
RFL-K-Test	209
Setting Cable Parameters	212
Summary	214
14 Signal Test	215
Signal Main Page	215
WB Balance Test	216
WB Attenuation Test	222
TX/RX Tone Test	228
15 Noise Tests	235
Noise Main Page	235
VF Noise Test	236
Power Influence Test	241
WB PSD Noise Test	246
NEXT	254
16 Impulse Tests	263
Impulse Main Page	263
VF Impulse Noise Test	265
WB Impulse Noise Test	269
Impulse Scope Test	275
Impulse Duration	282
17 Test Lead Compensation	289
Summary	290
18 Copper Tests: Result Summary	291
Summary	291
19 Maintenance	293
Recalibrating the Unit	294
Recycling and Disposal (Applies to European Union Only)	295
20 Troubleshooting	297
Solving Common Problems	297
Contacting the Technical Support Group	299
Transportation	300

21 Warranty	301
General Information	301
Liability	302
Exclusions	303
Certification	303
Service and Repairs	304
EXFO Service Centers Worldwide	305
A Technical Specifications	307
Index	313

Certification Information

North America Regulatory Statement

This unit was certified by an agency approved in both Canada and the United States of America. It has been evaluated according to applicable North American approved standards for product safety for use in Canada and the United States.

Electronic test and measurement equipment is exempt from FCC part 15, subpart B compliance in the United States of America and from ICES-003 compliance in Canada. However, EXFO Inc. makes reasonable efforts to ensure compliance to the applicable standards.

The limits set by these standards are designed to provide reasonable protection against harmful interference when the equipment is operated in a commercial environment. This equipment generates, uses, and can radiate radio frequency energy and, if not installed and used in accordance with the user guide, may cause harmful interference to radio communications. Operation of this equipment in a residential area is likely to cause harmful interference in which case the user will be required to correct the interference at his own expense.

Modifications not expressly approved by the manufacturer could void the user's authority to operate the equipment.

European Community Declaration of Conformity

An electronic version of the declaration of conformity for your product is available on our website at www.exfo.com. Refer to the product's page on the Web site for details.

1 ***Introducing the FTB-610 Advanced WB Copper Test Module***

The FTB-610 Advanced WB Copper Test Module is designed to qualify and troubleshoot the copper-loop plant by using pass/fail-driven automated functionality. The module provides a comprehensive offering of test features such as Pair Detective, Auto Test, FaultMapper, Multimeter, TDR, RFL, Signal, and Noise.

Key Features and Benefits

- SmartR™ Automatic results analysis
- High-voltage isolation testing
- Wideband impulse noise scope/analysis
- Ideal for FTTh repairs with platform built-in optical power meter

Typical Applications

- Perfect for troubleshooting fiber-to-the-cab service
- Complete suite of manual and automated advanced metallic tests
- 30 MHz wideband spectrum analysis
- High-power isolation for finding resistive faults and insulation failures
- Leverages FTB-1 platform connectivity to capture and upload results
- Wideband impulse noise analysis

Software Options

Software keys are available to enable additional services. For information on how to install and activate software options, refer to the FTB-1 User Guide.

Options	Description
SmartR	Enables Pair Detective and FaultMapper tests; both include TDR.
RFL	Enables support for RFL test.
TDR	Enables support for TDR test.
WBAND	<ul style="list-style-type: none"> ▶ Enables support for WB Balance and WB Attenuation from Signal test. ▶ Enables support for WB PSD Noise and WB Impulse Noise from Noise Test.
HIVOLT	<p>If this software option is activated, the following options is added for Soak Voltage parameter under Isolation test.</p> <ul style="list-style-type: none"> ▶ 250 V ▶ 300 V ▶ 400 V ▶ 500 V
NEXT	Enables Near End Crosstalk.

Note: *These options are also available as EXFO Connect floating options.*

Conventions

Before using the product described in this guide, you should understand the following conventions:



WARNING

Indicates a potentially hazardous situation which, if not avoided, could result in *death or serious injury*. Do not proceed unless you understand and meet the required conditions.



CAUTION

Indicates a potentially hazardous situation which, if not avoided, may result in *minor or moderate injury*. Do not proceed unless you understand and meet the required conditions.



CAUTION

Indicates a potentially hazardous situation which, if not avoided, may result in *component damage*. Do not proceed unless you understand and meet the required conditions.



IMPORTANT

Refers to information about this product you should not overlook.

2 **Safety Information**



WARNING

The use of controls, adjustments and procedures other than those specified herein may result in exposure to hazardous situations or impair the protection provided by this unit.



IMPORTANT



When you see the following symbol on your unit , make sure that you refer to the instructions provided in your user documentation. Ensure that you understand and meet the required conditions before using your product.



IMPORTANT

Other safety instructions relevant for your product are located throughout this documentation, depending on the action to perform. Make sure to read them carefully when they apply to your situation.



WARNING

Use only accessories that meet EXFO specifications.

Safety Information

Electrical Safety Information

Electrical Safety Information

If you need to ensure that the unit is completely turned off, disconnect the power cable and remove the batteries.



WARNING

- Use the external power supply indoors only.
- Position the unit so that the air can circulate freely around it.
- Operation of any electrical instrument around flammable gases or fumes constitutes a major safety hazard.
- To avoid electrical shock, do not operate the unit if any part of the outer surface (covers, panels, etc.) is damaged.
- Only authorized personnel should carry out adjustments, maintenance or repair of opened units under voltage. A person qualified in first aid must also be present. Do not replace any components while power cable and battery are connected.
- Capacitors inside the unit may be charged even if the unit has been disconnected from its electrical supply.
- Use only the AC adapter/charger provided by EXFO with your unit.

Equipment Ratings

Equipment Ratings	
Temperature	
▶ Operation	▶ 0 °C to 40 °C (32 °F to 104 °F)
Maximum operation altitude	▶ 3000 m (9842 ft)

For more information on product safety and equipment ratings, refer to the user documentation of your platform.

3 Getting Started

The Copper Test application is pre-installed on the FTB-1. If the module is not already installed, refer to the FTB-1 User Guide for more information on how to install the application.

Starting Module Application

The module can be configured and controlled by starting the **Wideband Copper** application.

To start the copper test application:

From the **Mini Toolbox**, tap the **Advanced WB Copper** icon.

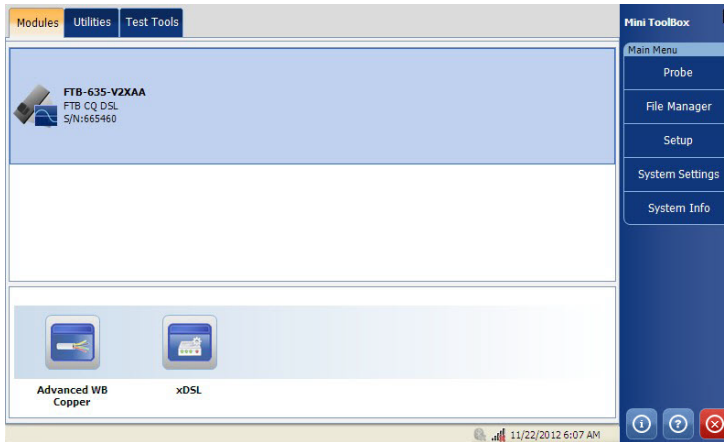

Cable Connections



WARNING

These connections are intended for the express purpose of electrical testing of common telephone line conductors, within the ranges specified in the *Technical Specifications* on page 307. The device is not intended to be used on telephone lines having voltages greater than 280 VAC or 400 VDC, and it is also not intended to be used on power distribution circuits.

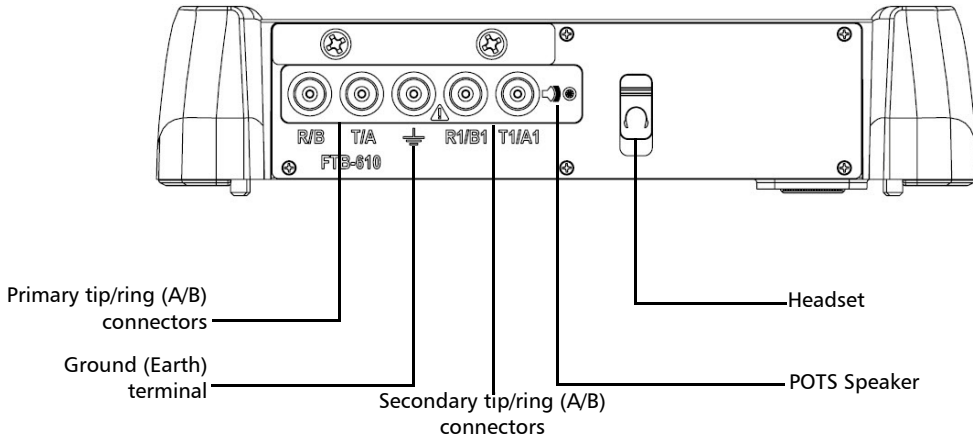

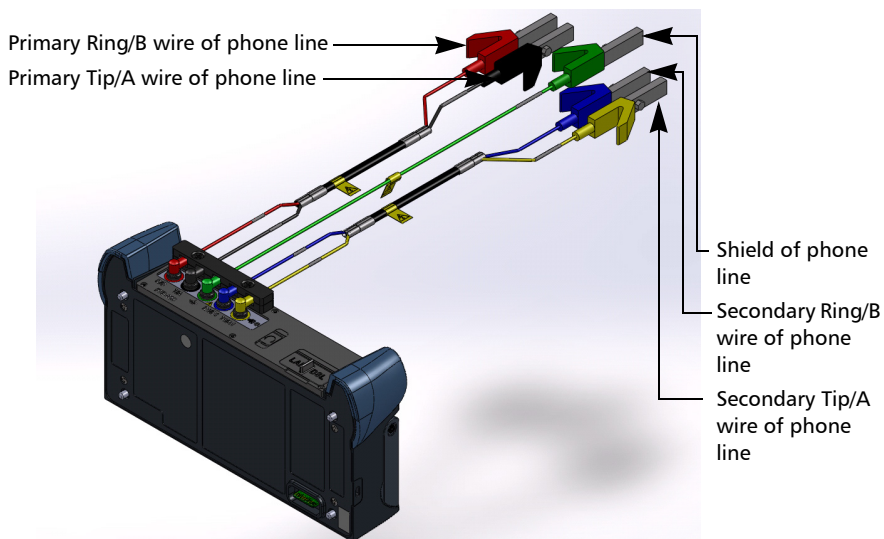

WARNING

A 50/100/125/500 Vcc limited power source may be present on connector R/T/R1/T1 when the unit is testing isolation resistance. Use with caution.



CAUTION

The unit is protected against damage caused by fault voltages that may be present on lines under test. Do not connect the unit if the maximum expected fault voltage is greater than 500 volts.

Getting Started

Inserting and Removing Test Modules

Inserting and Removing Test Modules



CAUTION

Never insert or remove a module while the FTB-1 is turned on. This will result in immediate and irreparable damage to both the module and unit.



CAUTION

To avoid damaging your unit, use it only with modules approved by EXFO.

To insert a module into the FTB-1:

1. Turn off your unit (shutdown, not hibernate or standby).
2. Position the unit so that its front panel rests on a flat surface such as a table.

Place the module on the platform making sure that the bumpers and the shorter sides of the module are flush with those of the platform. If necessary, slightly move the module until alignment is correct.

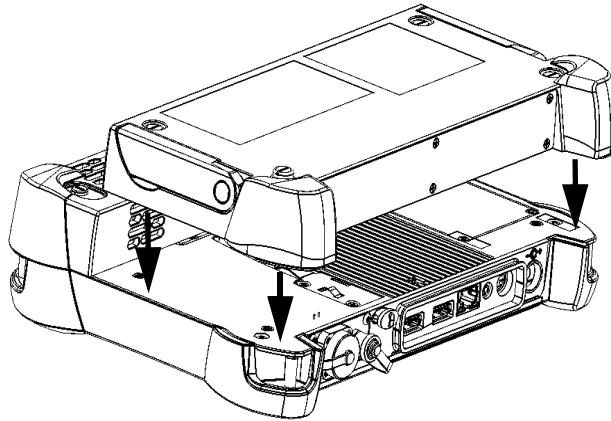

Getting Started

Inserting and Removing Test Modules

3. Using a flat screwdriver, turn the screws (4) clockwise until they are tightened.

This will secure the module into its “seated” position.

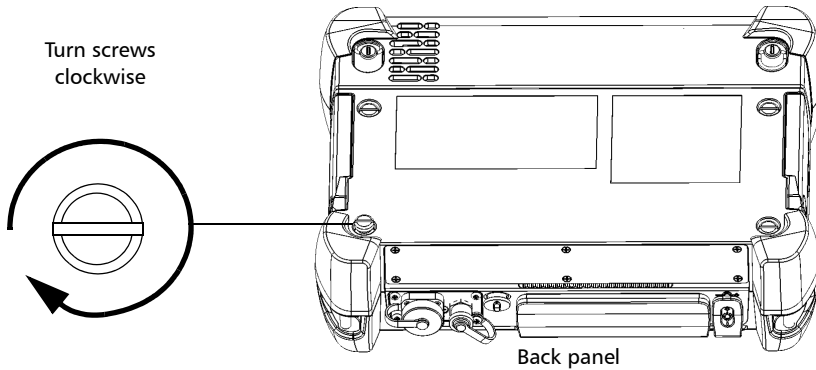

When you turn on the unit, the startup sequence will automatically detect the module.

To remove a module from the FTB-1:

- 1.** Turn off your unit (Shutdown).
- 2.** Position the unit so that its front panel rests on a flat surface such as a table.
- 3.** Using a flat screwdriver, turn the screws (4) counterclockwise until they are loose. Since they are captive screws, you cannot remove them completely.

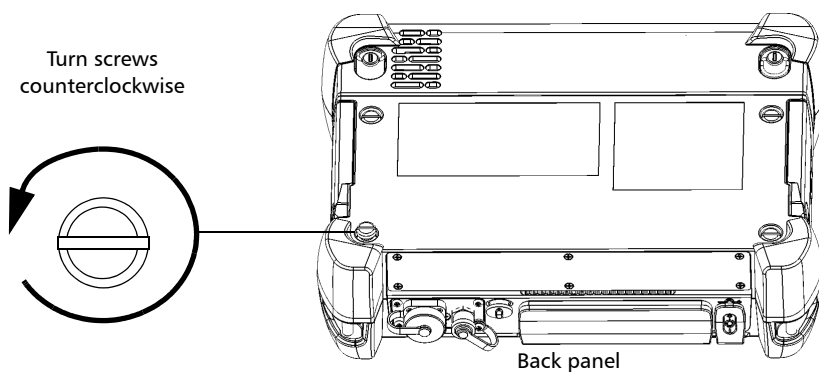

Getting Started

Inserting and Removing Test Modules

4. Hold the module by its sides (*NOT by the connectors*) and pull it up.

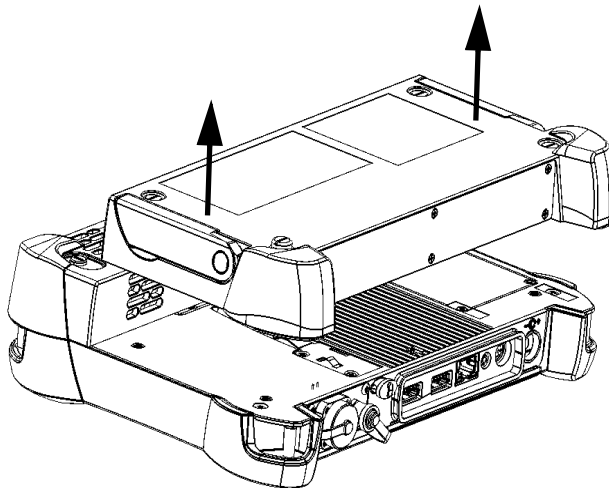

CAUTION

Pulling a module by its connectors could seriously damage both the module and connector. Always pull a module by its casing.

Performing FTB-1 Software Updates

The FTB-1 software updates can only be performed by a Supervisor, since only Supervisors are given administrative rights (upon FTB-1 login). Since administrative rights are required in order to use Update Manager, persons logging in as an Operator will not have access to Update Manager.

After completing the FTB-1 software update using Update Manager, the Supervisor should always run the newly installed application. The reason for this is that some updates may require a module firmware update, and only a Supervisor has the administrative rights to allow this update to proceed. If a module firmware update is required, but is not performed by the Supervisor (that is, by running the application), then when an Operator attempts to start the application the following message is displayed:







Module firmware update required. Please login as Administrator.

The above message may also be displayed if an Operator replaces the FTB-1 module with a module from another FTB-1 that does not have the required module firmware. For both cases the Operator will only have access to the application if a Supervisor logs into the FTB-1 and completes the installation of the module firmware.









Usual Tab Elements

While configuring tests or consulting results, different tabs and buttons allow you to navigate within the application.

Arrow Buttons

Button	Description
	Moves to the top of the list.
	Moves one page up.
	Moves one line up.
	Moves one line down.
	Moves one page down.
	Moves to the end of the list.

Graph Controls

Button	Description
	Arrow enables cursor mode (move a vertical cursor to get precise information about the plot along the x-axis).
	Hand is used to pan around the graph.
	Used to draw a zoom box to select an area on the graph.
	Resets the graph to original size (full view).
	Zoom in.
	Zoom out.
	Pause is used in the TDR test to hold the current TDR on screen for comparison to a new live trace.
	Mask is used in the WB PSD test to cycle through the selection of available masks; a long press reverses direction of cycle.
	Toggle is used in the Impulse Scope test to switch between the main and insert graphs on the page.

4 *Advanced WB Copper Application*

Using the Graphical User Interface

This chapter describes the graphical user interface of the Copper tests application.

The graphical user interface allows you to configure and start the Copper tests, view results and statistics, and other information related to the FTB-610. The application user interface contains:

- Main Window
- Status Bar
- Title Bar
- Test Menu
- Application Buttons

Main Window

The main window allows you to view the first and second level tabs for test groups, the tests within groups, and results as applicable.

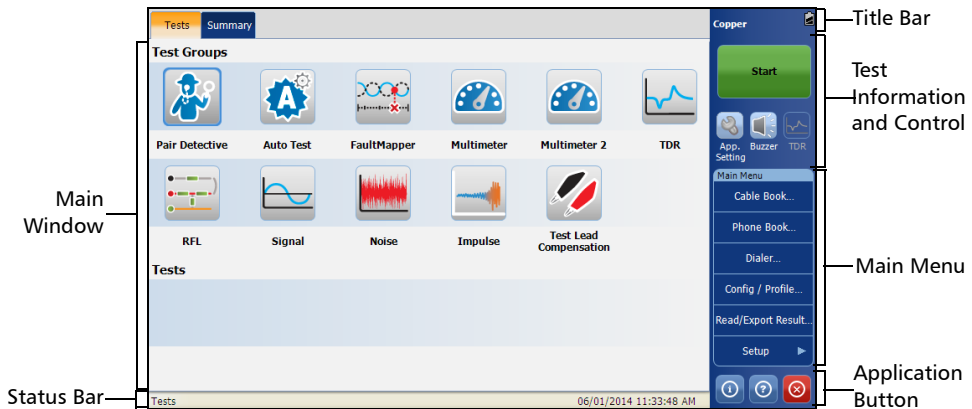

Test Groups

The **Copper** application provides you the following **Test Groups**:

- **Pair Detective**
- **Auto Test**
- **FaultMapper**
- **Multimeter**
- **Multimeter 2**
- **TDR**
- **RFL**
- **Signal**
- **Noise**
- **Impulse**
- **Test Lead Compensation**

Tests

The **Tests** section of the main window displays the selected test or its sub-tests.

Status Bar

The Status Bar displays the navigation path of the test, date, and time.

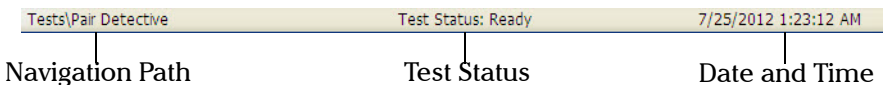



Title Bar

The Title Bar displays the software application name and the battery level indicator.

Test Information and Control

Your **Copper** application allows you to view the global indicator, Start/Stop any test or tool, use control buttons, and use the main menu to setup tests/tools and view test results.

- Start/Stop button: for more details, see *Start/Stop Button* on page 27.
- Application Settings: for more details, see *Application Settings* on page 66.
- The Buzzer  icon is a shortcut for **Buzzer** tab under Application settings. For more details, see *Buzzer* on page 72.
- The TDR  icon is a shortcut for the **TDR** test which is activated for Load Coils, Pair Detective and FaultMapper tests. For more details, see *TDR Test* on page 187.

Main Menu

The **Main Menu** displays the Setup and Result button. Setup allows you to configure a test or tool, and the Result button allows you to view respective test results.

Application buttons

Help Button

The help button  displays the help information related to the tab. It is also possible to navigate through the remainder of the help information.

About Button

You can view the product version details and technical support information in this window.

To view the information about the product:

1. From the main window, tap .

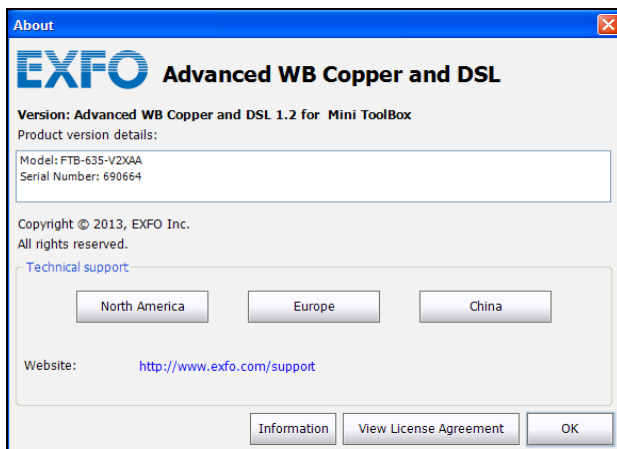

2. Tap **Information** to view further details about the product, software, and memory installed on the device.

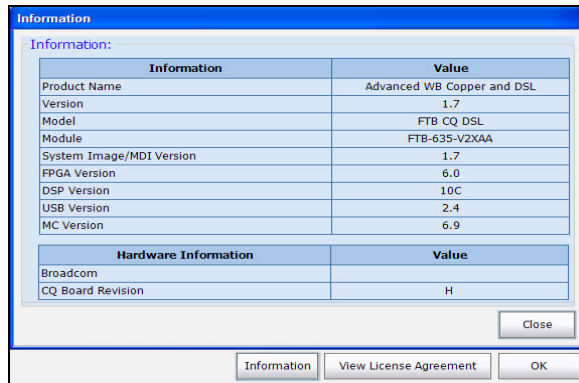

- 2a. You can view the complete versioning information by double-tapping on the **Version** value.

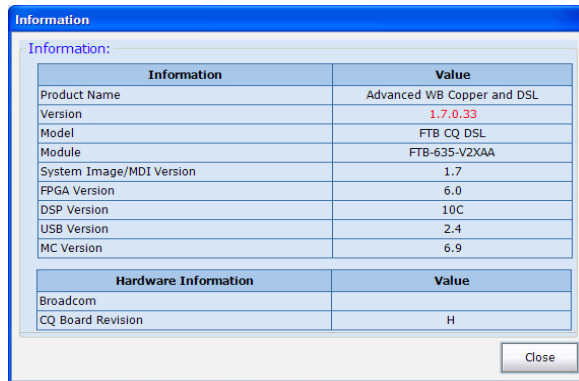

- 2b. Double-tap the **Version** value again to return to the original value.

Advanced WB Copper Application

Application buttons

3. Tap **View License Agreement** to view further details about using the product and software.

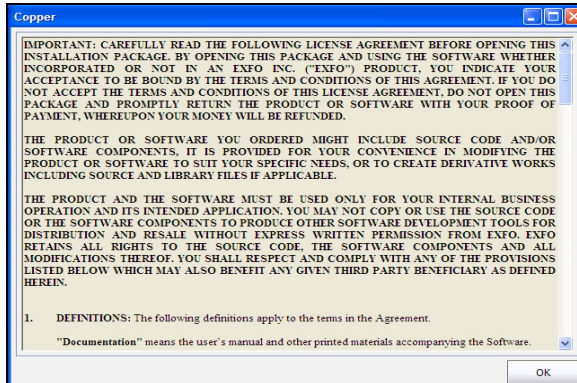

Exit Button

The Exit button  closes the application.

5 Copper Tests: Using the Main Menu

The FTB-610 is designed to test twisted pair quality, identify and locate faults, and troubleshoot noise and signal issues. These measurements offer a quick and thorough method to determine if the cable is capable of supporting xDSL technology.

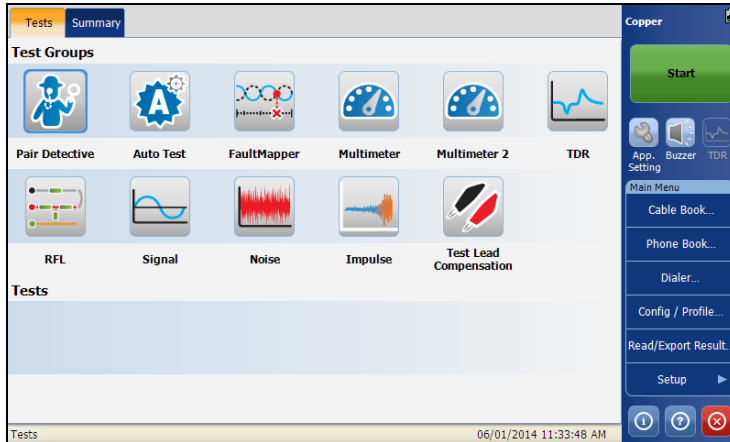

Start/Stop Button

The **Start/Stop** button allows you to start and stop a test. The button text changes depending on the action performed (toggle button).

Start: when the test is not running.

Stop: when the test is running.

Copper Tests: Using the Main Menu

Cable Book

Cable Book

The **Cable Book** menu presents a selection of functions which allow you to manage the groups of cables relevant to performing the copper tests. The **Cable Book** menu allows you to load, add, clone, and delete a cable, as well as modify its details.

To access Cable Book:

From the **Copper Main Menu**, select **Cable Book**.

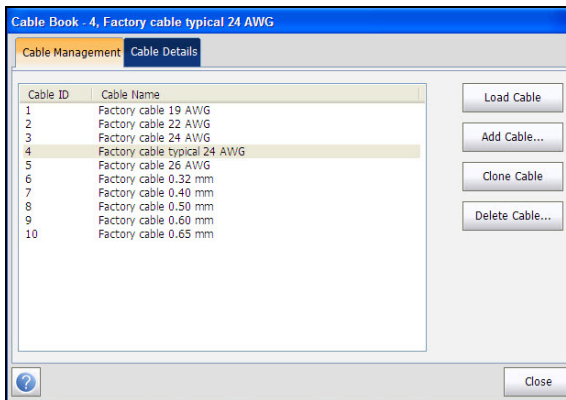

Load Cable

The page lists entries by **Cable ID** and **Cable Name**. There is 1 group of 10 factory default entries which cannot be edited or deleted. The **Cable Book** can include a maximum of 50 groups.

To load a cable:

- 1.** From the **Main Menu**, tap **Cable Book**.
- 2.** From the **Cable Management** tab, select the cable that you want to load.
- 3.** Tap **Load Cable** button to load the group/entry.

Cable Details

The **Cable Details** page allows you to view the cable parameter details of the currently highlighted cable entry.

To view/modify cable details:

1. From the **Main Menu**, tap **Cable Book**.
2. From the **Cable Management** tab, select the cable for which you want to view details.
3. Select the **Cable Details** tab to view the details.
4. Tap **Close** to exit from the page.

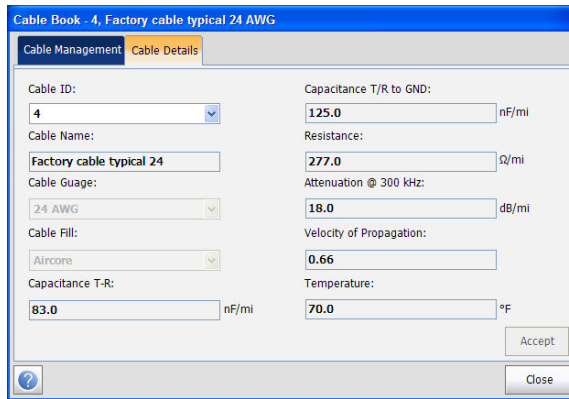

The page displays the following parameters:

- **Cable ID** displays the cable ID number.
- **Cable Name** is the name of the cable in the **Cable Book**.
- **Cable Gauge** is the gauge system for measuring wire sizes in AWG (American Wire Gauge) units or mm (metric wire size).
- **Cable Fill Material** is the type of material the cable is filled with: **Aircore**, **Jelly**, **Pulp**, **5 PR**, or **2 PR**. The selection influences the cable capacitance per length, automatically updating the **Cap. T/R to GND** field.

- **Capacitance T-R** specifies a value for the capacitance per length constant.
- **Capacitance T/R to GND** specifies a value for the capacitance per length to ground constant.
- **Resistance** specifies a value for the resistance constant of the cable.
- **Attenuation @ 300 kHz** specifies a value for the reduction in signal strength or insertion loss of the cable.
- **Velocity of propagation** for the cable as a ratio of the speed of light.
- **Temperature** specifies the temperature of reference at which all cable parameters have been measured, in either F (Fahrenheit) or C (Celsius) units. The measurement units are updated based on the **Temperature** settings in the **Application Settings, General** on page 66.

Add Cable

The **Add Cable** page allows you to add a new cable entry into the **Cable Book** using the following parameters for the currently highlighted **Cable ID**.

To add a Cable:

1. From the **Main Menu**, tap **Cable Book**.
2. Select the **Cable Management** tab and tap **Add Cable**.

The **Add Cable** dialog opens.

The screenshot shows the 'Add Cable' dialog box with the following parameters:

Parameter	Value	Unit
Cable ID	11	
Cable Name	NewCable	
Cable Gauge	19 AWG	
Cable Fill	Aircore	
Capacitance T-R	33.0	nF/mi
Capacitance T/R to GND	10.0	nF/mi
Resistance	10.0	Ω/mi
Attenuation @ 300 kHz	100.0	dB/mi
Velocity of Propagation	0.99	
Temperature	50.0	°F

The page allows you to set the following parameters:

- **Cable ID** displays the cable ID number. This parameter cannot be modified.
- **Cable Name** is displayed in the **Cable Book**.
- **Cable Gauge** allows you to enter the Cable Gauge. This is the gauge system for measuring wire sizes in AWG (American Wire Gauge) units or mm (metric wire size).

- **Cable Fill Material** allows you to select the type of material the cable can be filled with. Changing the selection to **Aircore**, **Jelly**, **Pulp 5 PR**, or **2 PR** influences the cable capacitance per length, automatically updates the **Capacitance T/R to GND** field.
- **Capacitance T-R** allows you to specify a value for the capacitance per length constant.
- **Capacitance T/R to GND** allows you to specify a value for the capacitance per length to ground constant.
- **Resistance** allows you specify a value for the resistance constant of the cable.
- **Attenuation @ 300 kHz** allows you to specify a value for the reduction in signal strength or insertion loss of the cable.
- **Velocity of propagation** allows you to set the velocity of propagation for the cable as a ratio of the speed of light.
- **Temperature** allows you to specify the temperature of reference at which all cable parameters have been measured.
- **Add** button, tap the **Add** button to append the new cable entry to the end of the **Cable Book**. If the maximum number of Cable Book entries has been reached, delete an entry before adding a new one.

Copper Tests: Using the Main Menu

Cable Book

Clone Cable

The **Clone Cable** option allows you to copy the cable details of an existing entry to a new cable entry in the **Cable Book**.

To clone a cable entry:

1. From the **Main Menu**, tap **Cable Book**.
2. From the **Cable Management** tab, select the cable ID that you want to clone.
3. Tap the **Clone Cable** button to copy the details of the highlighted entry and append a new **Cable ID** to the list.

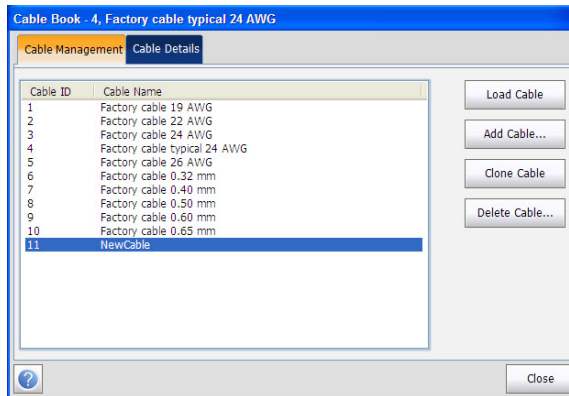

Delete Cable

The **Delete Cable** page allows you to delete a cable entry from the **Cable Book**. The page lists all entries, excluding the 10 factory default cable entries, by **Cable ID** and **Cable Name**.

To delete a cable entry:

1. From the **Main Menu**, tap **Cable Book**.
2. Select the **Cable Management** tab and tap **Delete Cable**.

The **Delete Cable** dialog opens.

3. Select the cable ID that you want to delete.

Note: Check the **Select All Cables** to specify all cable IDs.

4. Tap the **Delete Cable** button to remove the entry from the **Cable Book**. If you try to delete a cable in use, a warning message pops-up.

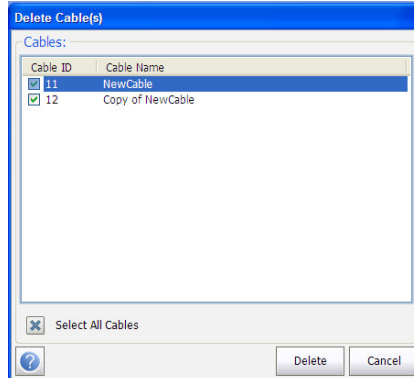

Phone Book

The **Phone Book** menu presents a selection of functions which allow you to manage the groups of phone numbers relevant to performing the copper tests. It can include a maximum of 50 groups of up to 3 individual entries each.

To access Phone Book:

From the **Copper Main Menu**, select **Phone Book**.

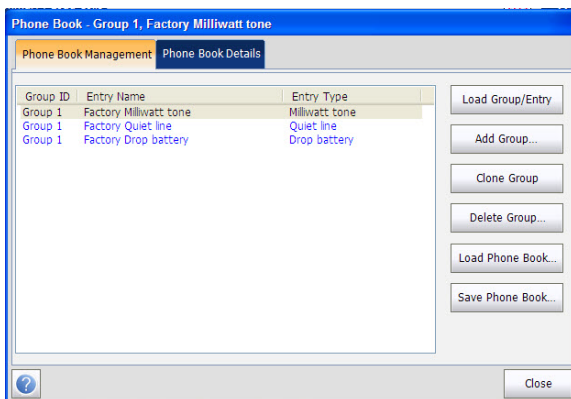

Load Group/Entry

The page lists entries by **Group ID** and **Entry Name/Type**. There is 1 group of 3 factory default entries which cannot be edited or deleted. The **Phone Book** can include a maximum of 50 groups.

To load Group/Entry:

1. From the **Main Menu**, tap **Phone Book**.
2. From the **Phone Book Management** tab, select the group which you want to load.
3. Tap the **Load Group/Entry** button to load the group/entry.

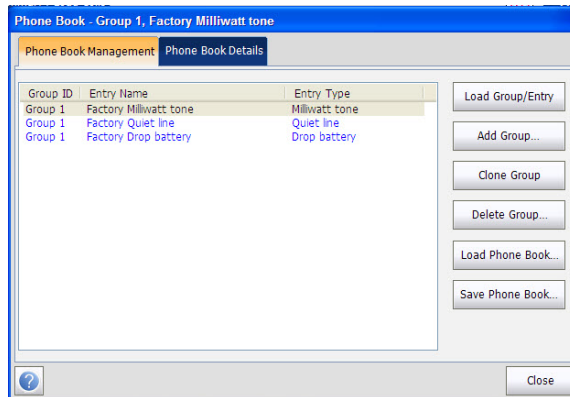

Copper Tests: Using the Main Menu

Phone Book

Phone Book Details

The **Phone Book Details** page allows you to view and modify the **Phone Book** parameters of the currently highlighted phone entry. As well, you can enable/disable entries 2 and 3 in each phone group. When creating a new phone group, only entry 1 is enabled. Entries 2 and 3 remain disabled until entry 1 is filled in.

To view/modify Phone Book details:

- 1.** From the **Main Menu**, tap **Phone Book**.
- 2.** From the **Phone Book Management** tab, select the group which you want to load.
- 3.** Select the **Phone Book Details** tab to view the details.
- 4.** Tap **Close** to exit from the page.

The screenshot shows the 'Phone Book - Group 1, Factory Milliwatt tone' screen. It has two tabs: 'Phone Book Management' and 'Phone Book Details'. The 'Phone Book Details' tab is active. The screen contains the following fields:

- Group ID: 1 (dropdown)
- Entry Name 1: Factory Milliwatt tone (text field)
- Entry Name 3: Factory Drop battery (text field)
- Phone Number 1: 4169580109 (text field)
- Phone Number 3: 4169581198 (text field)
- Type 1: Milliwatt tone (dropdown)
- Type 3: Drop battery (dropdown)
- Entry Name 2: Factory Quiet line (text field)
- Phone Number 2: 4169581110 (text field)
- Type 2: Quiet line (dropdown)

At the bottom right, there are 'Accept' and 'Close' buttons. At the bottom left, there is a help icon (question mark in a circle).

The page displays the following parameters:

- **Group ID** displays the group ID number. This is the only parameter that cannot be modified however you can navigate between the available phone groups.
- **Entry Name** is the name of the entry in the **Phone Book**.
- **Phone Number** is the 10-digit numeric phone number of the entry.
- **Type** displays the following list of values:
 - **Milliwatt tone**
 - **Drop battery**
 - **Quiet line**
 - - (for additional line types)
- **Accept** button validates and updates all the parameters of the **Phone Book**.

Add Group

The **Add Group** page allows you to add a new group entry into the **Phone Book** using the following parameters for the currently highlighted **Group ID**.

To Add Group:

1. From the **Main Menu**, tap **Phone Book**.
2. From the **Phone Book Management** tab, tap **Add Group**.

The screenshot shows the 'Add Phone Group' dialog box with the following data:

Field	Value
Group ID	2
Entry Name 1	Ron Jo
Phone Number 1	00445133260
Type 1	Drop battery
Entry Name 2	
Phone Number 2	
Type 2	None
Entry Name 3	
Phone Number 3	
Type 3	None

The page displays the following parameters:

- **Group ID** displays the group ID number. This parameter that cannot be modified.
- **Entry Name** is the name of the entry in the **Phone Book**.
- **Phone Number** is the 10-digit numeric phone number of the entry.

- **Type** displays the following list of values:
 - **Milliwatt tone**
 - **Drop battery**
 - **Quiet line**
 - **-** (for additional line types)
- **Add** function key adds the new group entry to the **Phone Book**.

Clone Group

The **Clone Group** page allows you to copy the details of an existing entry to a new group entry in the **Phone Book**. The page lists all entries by **Group ID**.

The list can display a maximum of 50 entries.

To Clone Group:

1. From the **Main Menu**, tap **Phone Book**.
2. From the **Phone Book Management** tab, select the group you want to clone.
3. Tap **Clone Group**.

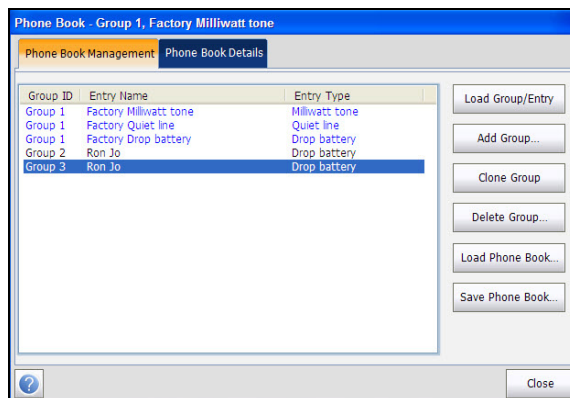

Delete Group

The **Delete Group** page allows you to delete a group entry from the **Phone Book**. The page lists all entries by **Group ID**.

To delete a group entry:

1. From the **Main Menu**, tap **Phone Book**.
2. From the **Phone Book Management** tab, select the group you want to delete.

Note: Select the **Select All Groups** option to select all group IDs.

3. Tap the **Delete Group** button to remove the entry from the **Cable Book**. If you try to delete a group in use, a warning message pops-up.

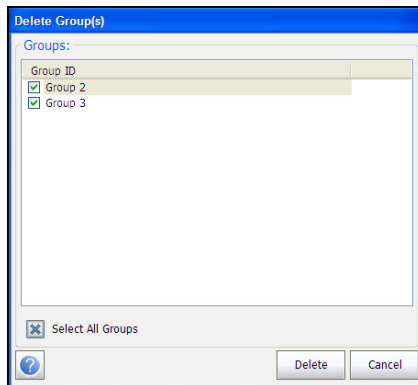

Load Phone Book

The **Load Phone Book** page allows you to import a phone book. The page displays the file name and date of the last phone book loaded. Only .csv files are supported.

To load Phone Book:

1. From the **Main Menu**, tap **Phone Book**.
2. Tap the **Load Phone Book** button.

The **Load Phone Book** dialog opens.

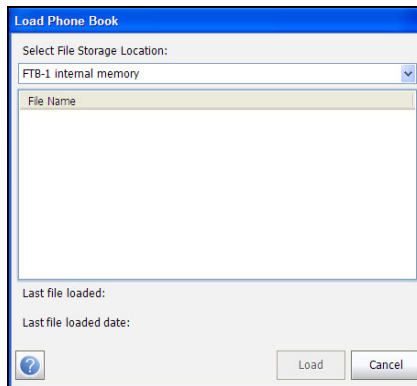

3. Select the file name to load.
4. Tap **Load** and confirm. The unit will remove the existing phone book and replace it by the loaded one.
OR
5. Tap **Cancel** to remove the message.

Copper Tests: Using the Main Menu

Phone Book

The page displays the following parameters:

- The **File Storage Location** lists the load destinations:
 - **FTB-1 internal memory**
 - Name of the USB Device (if attached)
- **File Name** lists the phone book file name(s) to load.
- **Load** button imports the selected phone book. You will be prompted for confirmation since this action will overwrite the current phone book.
- **Cancel** button removes the confirmation/warning message without impacting the phone book.

Save Phone Book

The **Save Phone Book** page allows you to save or export a phone book.

To Save Phone Book:

1. From the **Main Menu**, tap **Phone Book**.
2. From the Phone Book Management tab, tap the **Save Phone Book** button.

The **Save Phone Book** dialog opens.

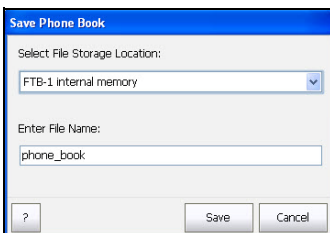

The screenshot shows a dialog box titled "Save Phone Book". It contains a dropdown menu for "Select File Storage Location" with "FTB-1 internal memory" selected. Below it is a text input field for "Enter File Name" with "phone_book" entered. At the bottom, there are three buttons: a question mark icon, a "Save" button, and a "Cancel" button.

The page displays the following parameters:

- **Enter File Name** allows you to enter a file name of the current phone book to save. By default, the name is phone_book.
- **Select File Storage Location** lists the save destinations:
 - **FTB-1 internal memory**
 - Name of the USB Device (if attached)
- **Save** button saves the selected file. Only .csv files are supported.

Note: *The platform will overwrite any document with the same file name found on the disk, without warning.*

Copper Tests: Using the Main Menu

Dialer

Dialer

The Dialer function provides a dial-up path from the module to another tester (or quiet termination or silent switchman) through a switched circuit network. DTMF transmission is enabled via the phone keypad allowing you to place POTS calls. The dialer can be accessed from the **Copper Main Menu** and is also integrated into individual test screens to give you quick access to the manual dialer function, speed dial and last dialed lists, without exiting the current test application.

The **Dialer** function allows you to use the unit as a telephone (with a headset) and the on-screen phone keypad as a dialer when **Enter Number** is invoked, whether in the test results screens or through the separate dedicated **Dialer** application. An external speaker on top of the module provides DTMF audio, while a headset jack also lets you connect a headset and microphone.

To access the Dialer function:

From the **Main Menu** select **Dialer**.

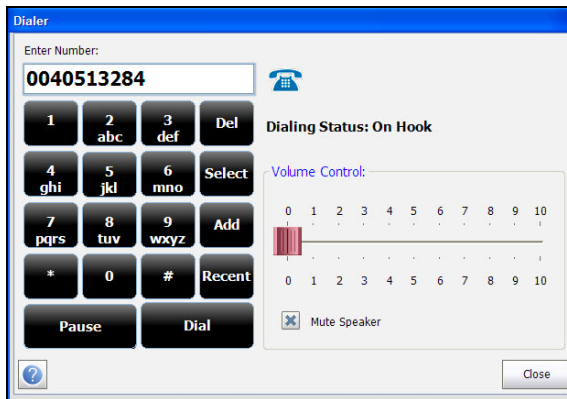

The following functions can be accessed from this page:

- **Dialing Status** shows the current status of the dialed number.
- **Enter Number** displays the telephone number entered or selected from the **Recent Dialed Numbers** list or **Phone Book**.
- **Recent** button opens a list of recently dialed numbers for selection.
- **Select** button allows you to select a number from the **Phone Book**.
- **Function Keys**
 - **Dial/Hang Up** allows you to dial the selected or entered number, or hang up the dialer.
 - **Add** saves the entered number to the **Phone Book**.
 - **Mute Speaker** changes the speaker status.
 - **Volume** adjusts the volume level.

To dial a number:

1. Enter a new phone number using the on-screen or hard keypad, or select an existing one from the phone book or recent dialed list.
2. Tap the **Dial** button to start the call.

Enter Number

The **Enter Number** box is where you enter the phone number you wish to dial.

To enter a phone number:

1. Enter the phone number.
2. Delete a character by moving the cursor to the left of the character and tapping the **Del** button.
3. Tap **Dial** button when you have completed entering a phone number.

Note: *Alphabets on the key pad are for reference only. Tapping any of the buttons will not show the alpha-character in the text box.*

Recent Dialed Numbers

The **Recent Dialed Numbers** page lists a maximum of 25 recently dialed telephone numbers which you can select to make your call.

To select a recently dialed number:

1. Tap **Recent** button to open the **Recent Dialed Numbers** page.
2. Select the number.
3. Tap the OK button. The number is automatically entered in the **Enter Number** field of the **Dialer** page.

Select from Phone Book

The **Select Phone Book Entry** page lists entries by **Group ID** and **Entry Name/Type**. There is 1 group of 3 factory default entries which cannot be edited or deleted. The **Phone Book** can include a maximum of 50 groups.

Group # in Use displays the group number in use.

To select a group and entry:

1. Tap **Select** button to open the **Select Phone Book Entry** page.
2. Select the desired entry and tap OK. The **Group # in Use** is updated with the current selection and automatically entered in the **Enter Number** field of the **Dialer** page.

Add to Phone Book

The **Add Phone Group** page allows you to add a new group entry into the **Phone Book** using the following parameters for the currently highlighted **Group ID**.

- **Group ID** displays the group ID number. This parameter that cannot be modified.
- **Entry Name** is the name of the entry in the **Phone Book**.
- **Phone Number** is the 10-digit numeric phone number of the entry.
- **Type** displays the following list of values:
 - **Milliwatt tone**
 - **Drop battery**
 - **Quiet line**
 - - (for additional line types)
- **Add** button adds the new group entry to the **Phone Book**.

To add a number to the phone book:

1. Tap Add on the Dialer page.
2. Enter the required details.
3. Tap the **Add** button to append the new group entry to the end of the **Phone Book**. If the maximum number of **Phone Book** entries has been reached, delete an entry before adding a new one.

Config/Profile

The **Config/Profile** menu presents a selection of functions, which allows you to manage the profiles and view the profile details. The FTB-610 Advanced WB Copper Test Module supports several types of copper test applications. Configuration parameters are saved into a test configuration profile. A **Profile Default** is provided with a predefined set of parameters for all test applications.

To access Config/Profile:

From the **Copper Main Menu**, select **Config/Profile**.

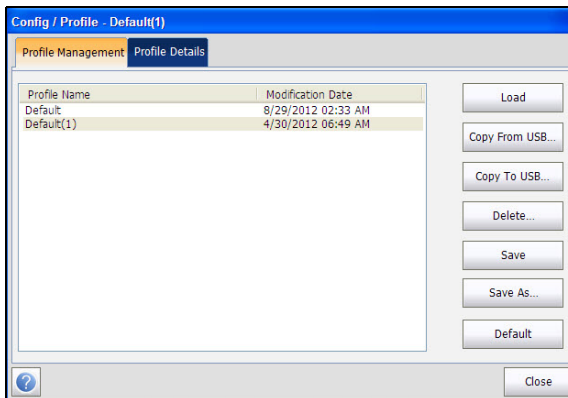

Load

The **Profile Management** page lists the available profiles in the internal memory, by **Profile Name** and **Modification Date**.

To load Profile:

1. From the **Main Menu**, tap **Config/Profile**.
2. From the **Profile Management** tab, select the profile which you want to load.
3. Tap the **Load** button to load the Profile.

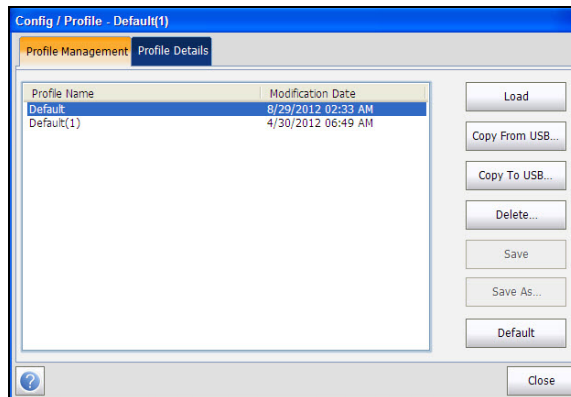

Copper Tests: Using the Main Menu

Config/Profile

Profile Details

You can view any of your saved profiles on the FTB-610 Advanced WB Copper Test Module from the **Profile Details** menu by selecting the desired test icon. An asterisk "*" on the currently **Selected Profile** name indicates that modifications have been made to this profile in the threshold settings or parameters of a particular test.

Each test displays a sub-menu of test icons to select and setup.

To view Profile details:

1. From the **Main Menu**, tap **Config/Profile**.
2. From the **Profile Details** tab, select the test for which you want to view the details.

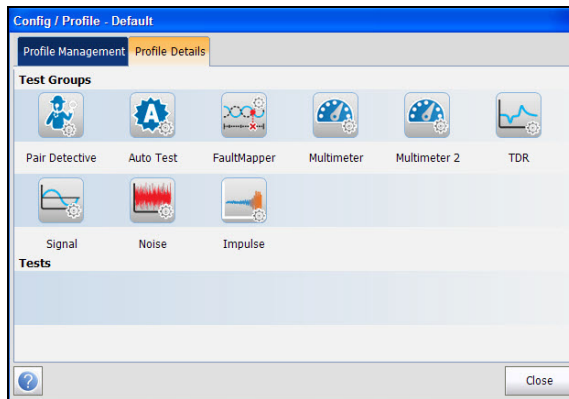

The page displays the following tests:

- **Pair Detective**
- **Auto Test**
- **FaultMapper**
- **Multimeter**
- **Multimeter 2**
- **TDR**
- **Signal**
- **Noise**
- **Impulse**

Pair Detective Profile Details

The profile details **Pair Detective** main menu allows you to view the test threshold and parameters.

To view the Pair Detective Profile details:

1. From the **Main Menu**, tap **Config/Profile**.
2. Tap the **Profile Details** tab.
3. From the **Test Groups**, select the **Pair Detective** test.
4. From the **Tests** menu, select the test for which you want to view the details.

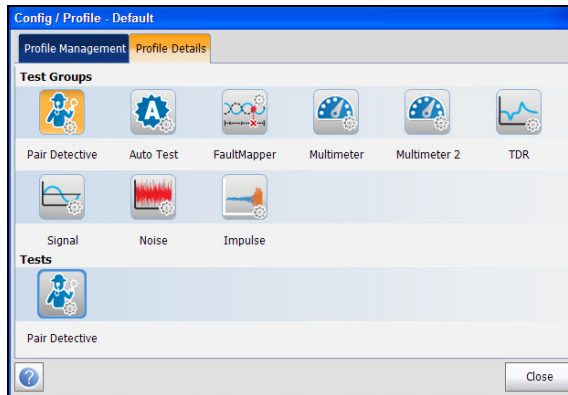

Auto Test Profile Details

The profile details **Auto Test** main menu allows you to view the test threshold and parameters of the following tests:

- **Pots Auto Test**
- **User Auto Test**

To view the Auto Test Profile details:

1. From the **Main Menu**, tap **Config/Profile**.
2. Tap the **Profile Details** tab.
3. From the **Test Groups**, select the **Auto** test.
4. From the **Tests** menu, select the test for which you want to view the details.

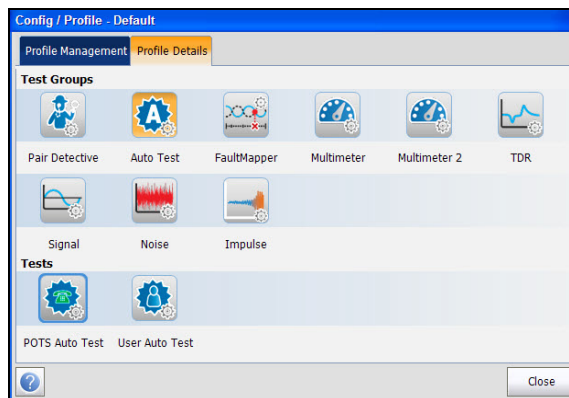

Copper Tests: Using the Main Menu

Config/Profile

FaultMapper Test Profile Details

The profile details **FaultMapper Test** main menu allows you to view the test threshold and parameters.

To view the FaultMapper Test Profile details:

1. From the **Main Menu**, tap **Config/Profile**.
2. Tap the **Profile Details** tab.
3. From the **Test Groups**, select the **FaultMapper** test.
4. From the **Tests** menu, select the test for which you want to view the details.

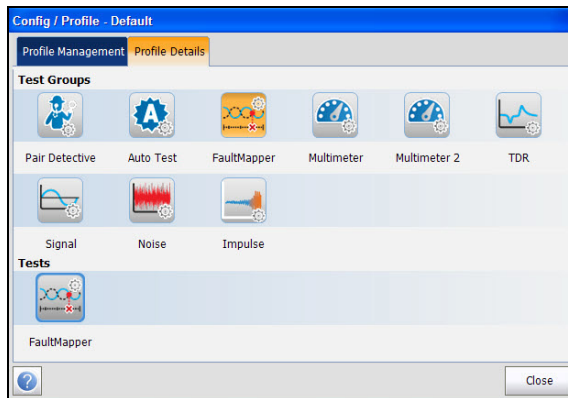

Multimeter Test Profile Details

The profile details **Multimeter** main menu allows you to view the test threshold and parameters of the following tests:

- **Voltage**
- **Current**
- **Resistance**
- **Capacitance/Opens**
- **Resistive Balance**
- **Balance**

To view the Multimeter Test Profile details:

1. From the **Main Menu**, tap **Config/Profile**.
2. Tap the **Profile Details** tab.
3. From the **Test Groups**, select the **Multimeter** test.
4. From the **Tests** menu, select the test for which you want to view the details.

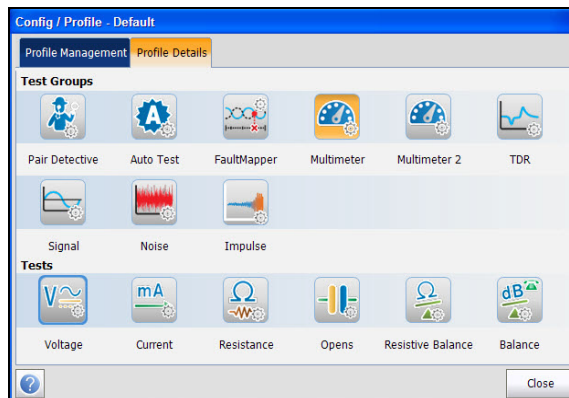

Copper Tests: Using the Main Menu

Config/Profile

Multimeter 2 Test Profile Details

The profile details **Multimeter 2** main menu allows you to view the test threshold and parameters of the following tests:

- **Isolation**
- **Station Ground**

To view the Multimeter 2 Test Profile details:

1. From the **Main Menu**, tap **Config/Profile**.
2. Tap the **Profile Details** tab.
3. From the **Test Groups**, select the **Multimeter 2** test.
4. From the **Tests** menu, select the test for which you want to view the details.

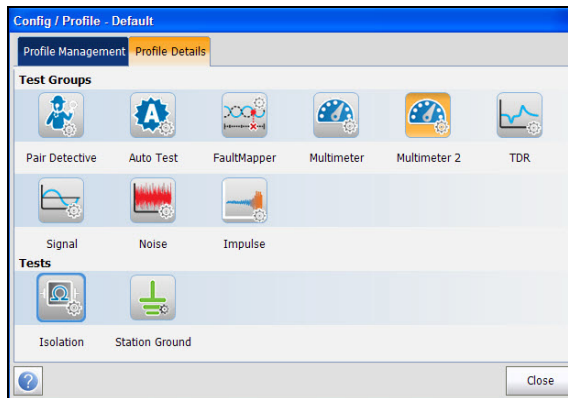

TDR Test Profile Details

The profile details **TDR** main menu allows you to view the test threshold and parameters of the following tests:

- **Auto TDR**
- **Manual TDR**
- **Xtalk TDR**

To view the TDR Test Profile details:

1. From the **Main Menu**, tap **Config/Profile**.
2. Tap the **Profile Details** tab.
3. From the **Test Groups**, select the **TDR** test.
4. From the **Tests** menu, select the test for which you want to view the details.

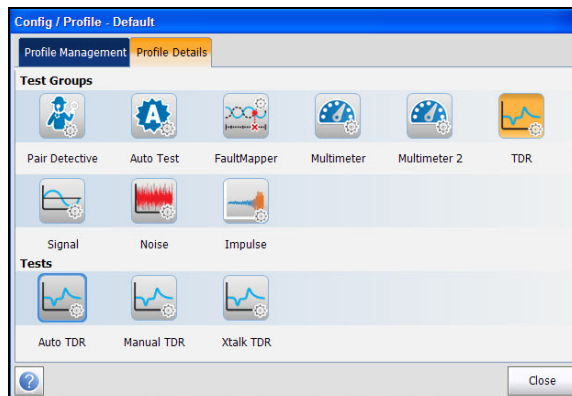

Copper Tests: Using the Main Menu

Config/Profile

Signal Test Profile Details

The profile details **Signal** main menu allows you to view the test threshold and parameters of the following tests:

- **WB Balance**
- **WB Attenuation**
- **TX/RX Tone**

To view the Signal Test Profile details:

1. From the **Main Menu**, tap **Config/Profile**.
2. Tap the **Profile Details** tab.
3. From the **Test Groups**, select the **Signal** test.
4. From the **Tests** menu, select the test for which you want to view the details.

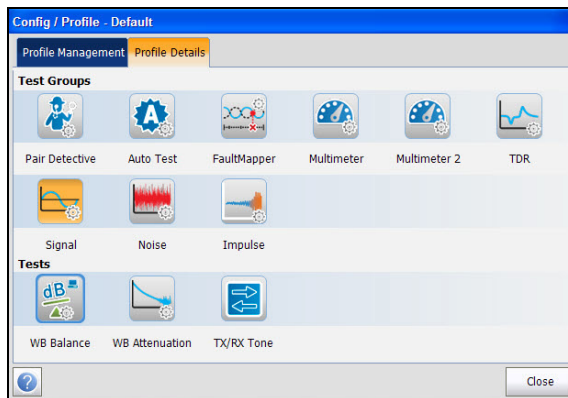

Noise Test Profile Details

The profile details **Noise** main menu allows you to view the test threshold and parameters of the following tests:

- **VF Noise**
- **Power Influence**
- **WB PSD Noise**
- **NEXT**

To view the Noise Test Profile details:

1. From the **Main Menu**, tap **Config/Profile**.
2. Tap the **Profile Details** tab.
3. From the **Test Groups**, select the **Noise** test.
4. From the **Tests** menu, select the test for which you want to view the details.

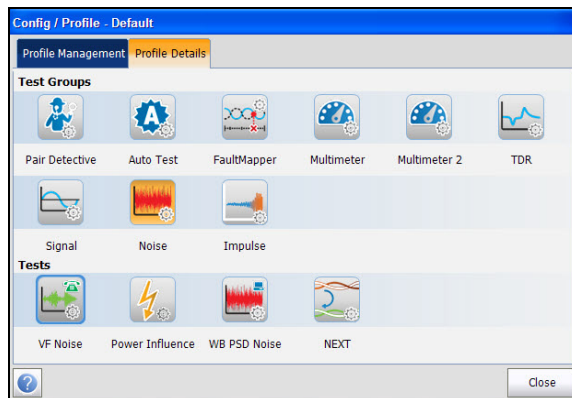

Copper Tests: Using the Main Menu

Config/Profile

Impulse Test Profile Details

The profile details **Impulse** main menu allows you to view the test threshold and parameters of the following tests:

- **VF Impulse Noise**
- **WB Impulse Noise**
- **Impulse Scope**
- **Impulse Duration**

To view the Impulse Test Profile details:

1. From the **Main Menu**, tap **Config/Profile**.
2. Tap the **Profile Details** tab.
3. From the **Test Groups**, select the **Impulse** test.
4. From the **Tests** menu, select the test for which you want to view the details.

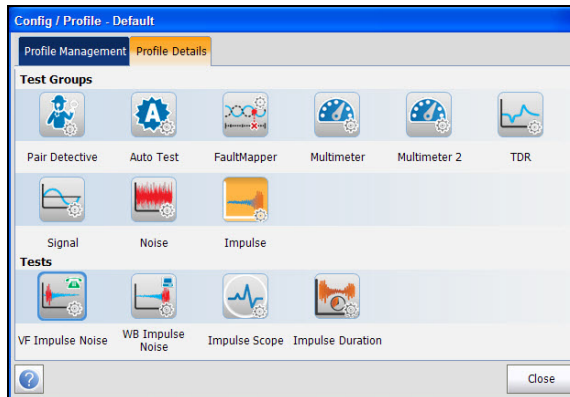

Copy from USB

Copy from USB allows you to copy all profiles found on an external USB device to the unit.

To copy the profile details:

1. From the **Main Menu**, tap **Config/Profile**.
2. From the **Profile Management** tab, tap the **Copy from USB** button. The Copy From USB page opens.
3. Select the USB drive from the **USB Drives** list.
4. Select the profile to copy.

Note: Check *Select All Profiles* to select all profile names.

5. Tap the **Copy** button to start the copying process.

Copy to USB

Copy to USB allows you to copy all profiles found in the internal memory to an external USB device. If the profile name already exists in the destination folder, Copy (x) will be appended to the profile name, where x corresponds to the number of copies starting from 1.

To copy the profile details:

1. From the **Main Menu**, tap **Config/Profile**.
2. From the **Profile Management** tab, tap the **Copy to USB** button.
The Copy From USB page opens.
3. Select the profile to copy.

Note: Check *Select All Profiles* to select all profile names.

4. Select the USB drive from the **USB Drives** list.
5. Tap the **Copy** button to start the copying process.

Delete Profile

Delete allows you to delete a profile (except the default profile) on the unit.

To delete a profile:

1. From the **Main Menu**, tap **Config/Profile**.
2. From the **Profile Management** tab, select the profiles to delete.
3. Tap the **Delete** button. The selected profiles are deleted.

Save

Save allows you to save changes made to selected profile. An asterisk "*" on the **Selected Profile** name indicates that modifications have been made in the threshold settings or parameters of a particular test.

To save a profile:

1. From the **Main Menu**, tap **Config/Profile**.
2. From the **Profile Management** tab, select the profiles and tap Save.
 - **Save** allows you to save to the currently selected profile name.
 - **Save As** opens the alphanumeric editor screen allowing you to enter a new name for the profile selected.

Default

Default resets the current test setup to the factory default profile. If selected, a dialogue box pops up to confirm that all single and auto test settings will revert to factory test settings.

To reset the setup:

- 1.** From the **Main Menu**, tap **Config/Profile**.
- 2.** From the **Profile Management** tab, tap the **Default** button. A warning is displayed to confirm that settings will be reset to factory defaults.
- 3.** Tap **OK** to continue or **Cancel** to abort.

Application Settings

Before executing the copper tests, set up the software settings and values for the cables. The module allows you to save standard parameter settings to different profiles and reuse them as needed.

To access *Application Settings*:

1. From the **Main Menu**, select **Setup**.
2. Tap **App. Setting**.

The page displays the following tabs:

General

The **General** tab allows you to configure the cable temperature, test startup mode, report format, etc. for the application.

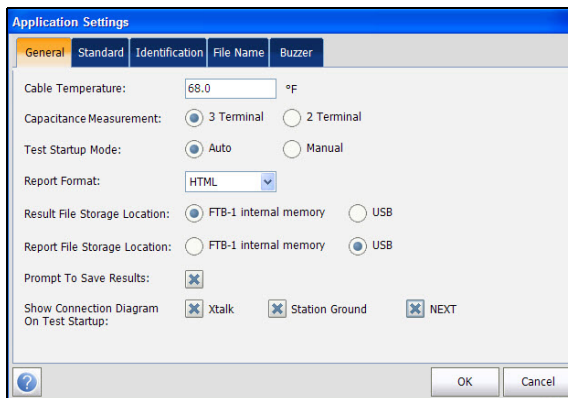

The page allows you to set the following parameters:

- **Cable Temperature** specifies the temperature of the cable under test in either F (Fahrenheit) or C (Celsius) units.

- **Capacitance Measurement** is either 3 Terminal or 2 Terminal. The latter method measures the capacitance across the 2 terminals specified (either T-R, T-G, R-G or A-B, A-E, B-E), whereas the 3 Terminal method measures the capacitance across the 2 terminals specified, and shorts the remaining (or unspecified) terminal to G/E.

Note: *In order to correctly determine cable length by using the capacitance measurement, the **Cable Book** must contain both 3/2 Terminal values.*

- **Test Startup Mode** lists the test startup type:
 - **Auto** (default) automatically starts a test when you select the respective icon from the test sub-menu.
 - **Manual** requires that you tap the Start button on the **Main Menu** to start a test.
- **Result File Storage Location** allows you to select where to save your results: to a **USB** or the internal memory.
- **Report Format** is **HTML**, **MHTML**, **XML**, or **PDF** as the generated report format.
- **Prompt To Save Results** allows you to enable popup confirmation messages before leaving a test and not saving results, by checking the box.
- **Show Connection Diagram On Test Startup** allows you to enable the hookup diagram upon startup by checking the boxes of the following tests:
 - **Xtalk**
 - **Station Ground**
 - **NEXT**

Copper Tests: Using the Main Menu

Application Settings

Standard

The **Standard** tab allows you to set Measurement unit and Test Parameter Preset values.

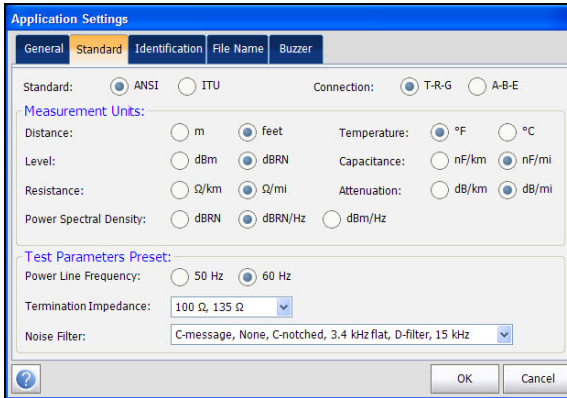

The page allows you to set the following parameters:

➤ Standard Selection

Standard allows you to specify if the copper tests should conform to the ITU (International Telecommunications) or **ANSI** (American National Standards Institute) standard.

Note: *Selecting the **Standard** resets the default **Measurement Units**, **Label Customization**, and **Test Parameters Preset** for the page.*

➤ Measurement Units

- **Distance** lists the measurement units for distance in feet or meters.
- **Temperature** lists the measurement units for temperature in **F** (Fahrenheit) or **C** (Celsius).
- **Level** lists the units of power level in dBm or dBRN.
- **Capacitance** lists the units of capacitance for Tip and Ring in (nF/km or nF/mi).

- **Resistance** lists the units for resistance in (**Ω/km** or **Ω/mi**).
- **Attenuation** lists the units for the reduction in signal strength or insertion loss of the cable, in (**dB/km** or **dB/mi**).
- **Power Spectral Density** (PSD) lists the units to measure the noise energy at a point in a noise spectrum. Units are dependent on the previously selected **Level**.
- **Label Customization**
 - Connection** lists the type of cable connection: **T-R-G** or **A-B-E**.
- **Test Parameters Preset**
 - **Power Line Frequency** lists the frequency value of the power line.
 - **Termination Impedance** lists the values for the impedance of the dummy load connected to the line.
 - **Noise Filter** lists the type of noise filters to use.

Identification

The **Identification** tab allows you to preset values to identify each single and auto test result file when saving them.

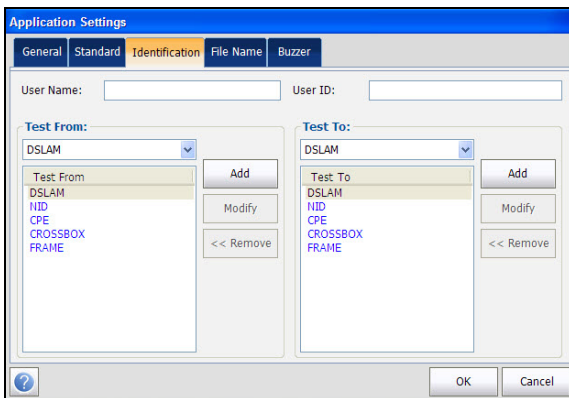

The page allows you to set the following parameters:

- **User Name/User ID** allow you to enter up to 25 alphanumeric characters, in each field.
- **Test From/To** list the following values: **DSLAM, NID, CPE, CROSSBOX, FRAME** - up to 20 entries each, including user defined values.
- **Test From/To List Setup** buttons open separate list management pages.

A maximum of 20 different entries can be added.

To manage the list:

1. Select the entries.
2. Tap **Add** button to add an entry just below the selected entry in the list.
3. To edit an entry, select the entry and tap **Modify** button.
4. Tap **Delete** button to delete any entry you have added.

File Name

The **File Name** tab sets up the standard configuration for automatically naming a result file. You can only select/deselect the entries. All enabled entries are considered for file name generation.

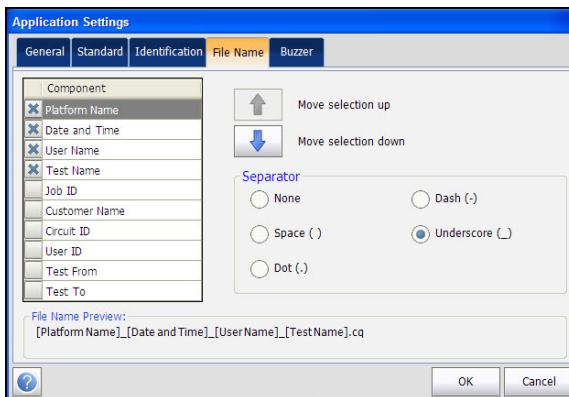

The page allows you to set the following parameters:

- **File Name Preview** displays a preview of the file name. The actual values of the selected entries are not shown.
- **Date and Time** value format depends on the format selected in **System Settings**. This entry cannot be deselected.
- **Separator** allows you to choose a value to separate the enabled entries in the file name, e.g.: **Space ()**, **Dash (-)**, **Underscore (_)**.
- Up and down arrows allow you to change the order of the identification field.

Copper Tests: Using the Main Menu

Application Settings

Buzzer

The buzzer is always on when the module is powered, to provide audible and visual warnings of hazardous voltages on the line under test.

The **Buzzer** tab allows you to configure values for the buzzer settings.

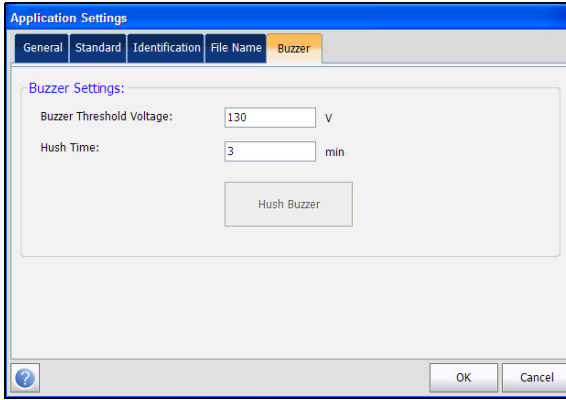

The page allows you to set the following parameters:

- **Buzzer Threshold Voltage** allows you to configure the hazardous voltage level from 70 to 150 volts. Default is 80 volts.
- **Hush Time** allows you to configure the hush timeout from 1 to 15 minutes. Default is 3 minutes.
- **Hush Buzzer** button mutes the sounding buzzer.

Factory Default

The Factory Default allows you to restore the Application Settings, Phone Book settings or both of them to factory default settings.

To access Factory Default Settings:

1. From the **Main Menu**, select **Setup**.
2. Tap **Factory Default**.
3. Select the option to reset to factory default.
4. Tap **Confirm Factory Default** button to confirm selection.
5. Tap **Close** to exit from the page.

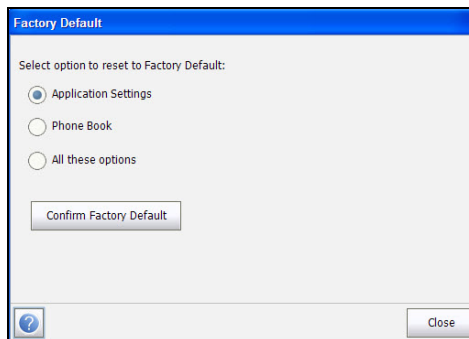

The page displays the following parameters:

- **Application Settings** allows you to reset all the application settings to factory default values.
- **Phone Book** allows you to reset the phone book to the factory default values.
- **All these options** allows you to reset Application Settings and Phone Book to the factory default values.

Save Test

You can save a snapshot of test results into a result/report file during or after a test performed with the FTB-610. Each copper test includes a **Save Test** button which opens a page where results can be saved to an internal memory or external USB drive. Reports can be created in the following formats: **HTML**, **MHTML**, **XML**, or **PDF**.

Alternately, when a test is completed or stopped and you select another test to start, **Save** dialogue box pops up. Selecting **Save** displays the **Save Test** screen.

The screenshot shows a dialog box titled "Save Test - MultimeterVoltage". It is organized into three main sections:

- Identification Fields:** Contains text boxes for "User Name:", "User ID:", "Job ID:", "Customer Name:", "Circuit ID:", and "Comments:". It also has dropdown menus for "Test From:" and "Test To:", both currently set to "DSLAM".
- Results:** Includes a dropdown for "Result File Storage Location:" (set to "FTB-1 internal memory") and a "Select Result File" button. Below it is a text box for "Result File Name:" containing "FTB1_12-11-2013 3:45:25 PM_Voltage" and a "Save Results" button.
- Report:** Includes a dropdown for "Report File Storage Location:" (set to "FTB-1 internal memory") and a "Select Report" button. Below it is a text box for "Report File Name:" containing "FTB1_12-11-2013 3:45:25 PM_Voltage" and a "Save Report" button. A dropdown for "Report Format:" is set to "HTML".

At the bottom left is a help icon (question mark in a circle), and at the bottom right is a "Close" button.

The page allows you to set the following parameters:

➤ **Identification Fields**

- **User Name/User ID** display the values set up in the **Application Settings/Identification** tab. You can edit this field using the editor screen.
- **Test From/To** display the values set up in the **Application Settings/Identification** tab. You can edit this field using the choices from the list box.
- **Job ID** allows you to create/edit a unique identifier for the task.
- **Customer Name** is the name of the customer for which the test was run.
- **Circuit ID** allows you to create/edit a unique identifier for the circuit under test.
- **Comments** allows you to add any relevant information.

➤ **Results**

- **Select Result File** button displays a list of existing file names where you can save your results.

If the result file already exists, a warning message is displayed to overwrite the existing file.

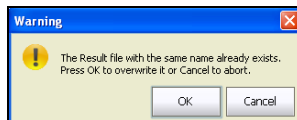

Tap **OK** to overwrite the existing file or **Cancel** to abort.

Copper Tests: Using the Main Menu

Save Test

- **Result File Storage Location** gives you the option of storing results either in the FTB-1 internal memory or a USB device. The default selection comes from **Application Settings/General** tab.
- **Result File Name** allows you to preview and edit the result file name. The proposed file name is based on current auto-naming parameters configured in Setup/Application Settings/File Name.
- **Save Results** button confirms if the **Result File Name** is saved successfully.
- **Report**
 - **Select Report** button displays a list of existing report file names where you can save your results.
 - **Report File Storage** gives you the option of storing your report either in the FTB-1 internal memory or a USB device.
 - **Report File Name** allows you to preview and edit the report file name. The proposed file name is based on current auto-naming parameters configured in Setup/Application Settings/File Name.
 - **Report Format** is **HTML**, **MHTML**, **XML**, or **PDF**.

You can generate reports from any saved test result. Reports include:

 - General Information** including **Pass/Fail** status.
 - Identification**
 - Profile/Result Summary**

Blank entries for your **Signature** and the **Date**.
 - **Save Report** button confirms if the **Report File Name** is saved successfully. If a USB device is not inserted, the following warning dialogue box appears: **USB device not present**.

Select Result File

Select Result File page displays a list of existing file names where you can save your results.

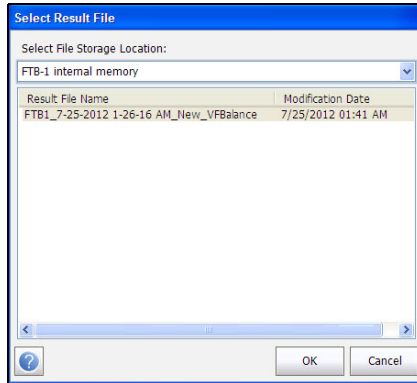

To save your results to an existing File Name:

1. Select the desired File Name.
2. Tap **OK** to confirm your selection.

Note: *The selected result file is overwritten with the new results.*

Select Report File

Select Report page displays a list of existing file names where you can save your reports.

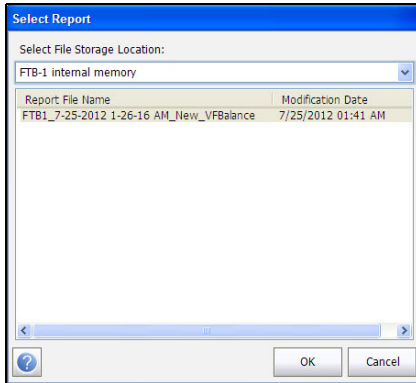

To save your reports to an existing File Name:

1. Select the desired **Report File Name**.
2. Tap **OK** to confirm your selection.

Note: The selected report file is overwritten with the new report.

6 Reading and Exporting Saved Results

You can view and or export any of your saved results by selecting the **Read/Export Results** from the **Main Menu**.

Result File

The **Result File** page allows you to select a **Result File Name** and view the results of files previously saved. The page lists all saved result files by test date and time. The format of **Modification Date** is per the selection in **System Settings**. Result files can be loaded from either the **FTB-1 internal memory** or a **USB**.

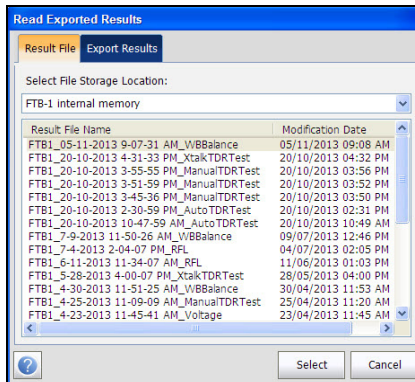

To open previously saved test results:

1. Tap to select the file to open.
2. Tap **Select** to open the result file or **Cancel** to exit the page.

Reading the Result File

Once you open a saved result file, you are presented with the saved measured result details and cable parameters of the selected test. The following tabs and buttons are displayed dependent on the test saved:

- **Summary** tab displays a list of the names of the executed tests, the date and time each test was run, and pass/fail status of the test. Refer to *Summary* on page 319.
- **Profile Details** displays the thresholds and setup parameters of the test.
- **Result Summary** displays general information and parameters of the test under the following tabs:
 - **Save Test** displays pass/fail status, general and identification information, along with comments.
 - **Phone Book** displays the phone entries dialed during the test.
 - **Supplemental** displays the status, date and time of the last **Test Lead Compensation** performed.

Profile Details

The **Profile Details** page displays read-only **Test Thresholds** and **Test Parameters** information about the setup of the selected test.

The screenshot shows a 'Profile Details' dialog box with the following information:

- Test Group: Multimeter
- Test Identification: Voltage
- Profile Name: Default

Test Thresholds:

AC Voltage:		
Pair	Voltage	Type
T - R	30.0 VAC	Maximum
T - G	30.0 VAC	Maximum
R - G	30.0 VAC	Maximum

DC Voltage:		
Pair	Voltage	Type
T - R	500.0 VDC	Maximum
T - G	500.0 VDC	Maximum
R - G	500.0 VDC	Maximum

Test Parameters:

Snapshot:	
Termination Resistance:	100 kΩ
Selected Pair:	R - G

Continuous AC:	
Termination Resistance:	100 kΩ
Selected Pair:	T - R

Continuous DC:	
Termination Resistance:	100 kΩ
Selected Pair:	T - R

The dialog box includes a help icon (question mark) and a 'Close' button.

The page displays the following parameters:

- **Test Group** is the overall test group of the selected saved results file, for example **Multimeter**.
- **Test Identification** is the test type of the group, for example **Voltage**.
- **Profile Name** is the file name of the selected saved results.

Reading and Exporting Saved Results

Reading the Result File

Result Summary

The **Save Test** tab displays pass/fail status, general and identification information, along with comments, for the test.

The screenshot shows a software window titled "Result Summary" with three tabs: "Save Test", "Phone Book", and "Supplemental". The "Save Test" tab is active. It displays the following information:

- Result File Name: FTB1_2-28-2013 3-16-56 PM_Voltage
- Test Date and Time: 2/28/2013 3:16:56 PM
- Test Group: Multimeter
- Test Identification: Voltage
- Test Modes: Snapshot

On the right side, there is a "P/F Status:" section with a green checkmark icon and the word "Pass" below it. Below this are three buttons: "Save", "Save As...", and "Save Report".

Under the "Identification Fields:" section, there are several input fields and dropdown menus:

- User Name: [Text Input]
- User ID: [Text Input]
- Test From: [Dropdown Menu, value: DSLAM]
- Test To: [Dropdown Menu, value: DSLAM]
- Job ID: [Text Input]
- Customer Name: [Text Input]
- Circuit ID: [Text Input]
- Comments: [Text Input]

At the bottom left is a help icon (question mark in a circle), and at the bottom right is a "Close" button.

- **General Information** displays read-only information pertaining to the test result.
 - Result File Name
 - Test Date and Time
 - Test Group
 - Test Identification
 - Test Modes
- **Editable Identification Fields** display values from the loaded file. You can edit all fields using the editor screen or by selecting an entry from the list box.
 - User Name/ID
 - Test From/To
 - Job ID

- Customer Name
- Circuit ID
- Comments
- **Save** button keeps any current changes with the current file name.
- **Save As** button saves the current changes under a different file name that you can configure in the editor screen.

The **Save As** dialog opens.

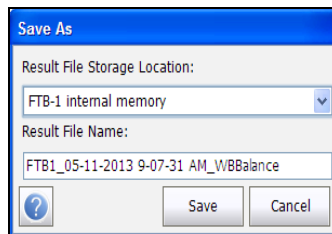

The page displays the following parameters:

- **Result File Storage Location** gives you the option of storing results either in the **FTB-1 internal memory** or USB device. The default selection comes from **Application Settings/General** tab.
- **Result File Name** allows you to preview and edit the result file name. The proposed file name is based on current auto-naming parameters configured in **Setup/Application Settings/File Name**.
- **Save** button confirms your selections.
- **Cancel** button exits the dialog box.

Reading and Exporting Saved Results

Reading the Result File

- **Save Report** allows you to load a result file, update the ID fields, and generate a report.

The **Save Report** dialog opens.

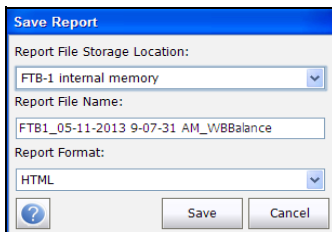

The page displays the following parameters:

- **Report File Storage Location** gives you the option of storing the report either in the **FTB-1 internal memory** or USB device. The default selection comes from **Application Settings/General** tab.
- **Report File Name** allows you to preview and edit the result file name. The proposed file name is based on current auto-naming parameters configured in **Setup/Application Settings/File Name**.
- **Report Format** allows you to select **HTML**, **MHTML**, **XML**, or **PDF** for the generated report.
- **Save** button confirms your selections.
- **Cancel** button exits the dialog box.
- **Close** does not save any changes and closes the page.

Phone Book

The **Phone Book** tab summarizes the Phone Book details when loading a results file.

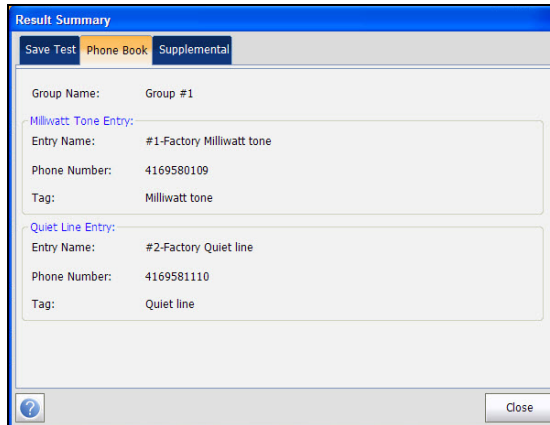

It contains information about group entries such as group/Entry name, phone numbers, and tags.

If the dialer was not used during the test, the **Phone Book** tab will not appear as part of the **Result Summary** page.

Reading and Exporting Saved Results

Reading the Result File

Supplemental

The **Test Lead Compensation** under the **Supplemental** tab displays read-only **Date and Time** and **Pass/Fail Test Status** of the compensated resistance and capacitance based on the cable temperature of the test lead.

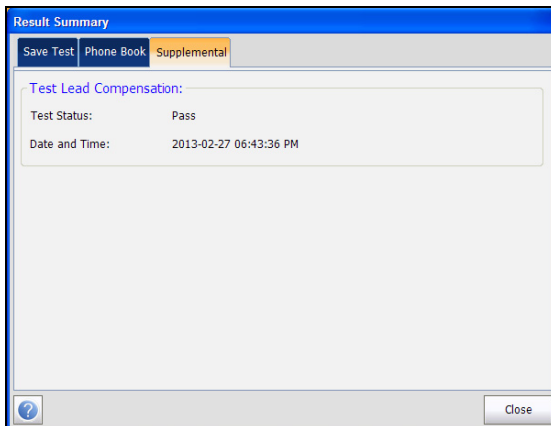

Export Results

The **Export Results** page allows you to select a **Result File Name** or **Select All** files previously saved and export the results in a selected report format.

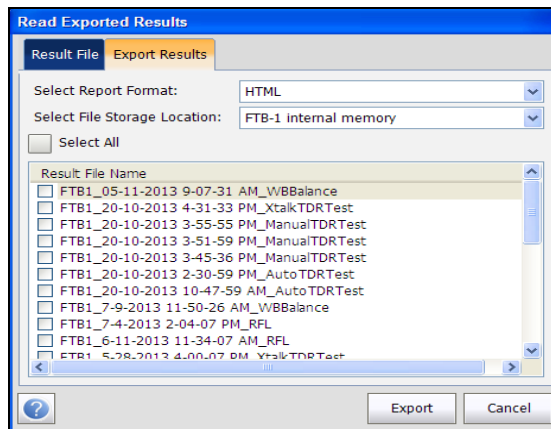

The page displays the following parameters:

- **Select Report Format** allows you to select **HTML**, **MHTML**, **XML**, or **PDF** for the saved report(s).
- **Select File Storage Location** gives you the option of exporting your results to either the **FTB-1 internal memory** or USB device.
- **Select All** allows you to check all file names listed or when not selected, one or more files to export.
- **Result File Name** lists all the saved result files to format.
- **Export** button transfers the selected file(s) to the internal memory or USB device in the selected report format.
- **Cancel** button exits the dialog box.

7 Pair Detective Test

The **Pair Detective** test consists of a series of 10 consecutive individual tests and applies a high voltage to the line. It automatically analyzes collected results and gives plain language indications of possible faults. Before proceeding with this test, ensure the line is inactive.

At the start of any test, the unit checks for the presence of dangerous voltage and an active circuit. If dangerous voltage is detected, a dialog box is displayed to inform you and the test will stop. If an active circuit is detected, a dialog box is displayed to ask you whether or not to proceed with the test.

Pair Detective

The **Pair Detective** page displays a summary of the pass/fail status, **DC-Voltage/Current** and **Isolation** for each selected wire pair, as well as other detailed results of the **Pair Detective** test.

To access the Pair Detective Page:

1. From the **Copper** main menu **Test Groups**, select **Pair Detective** test.
2. From the **Tests** menu, select **Pair Detective** to start the test.

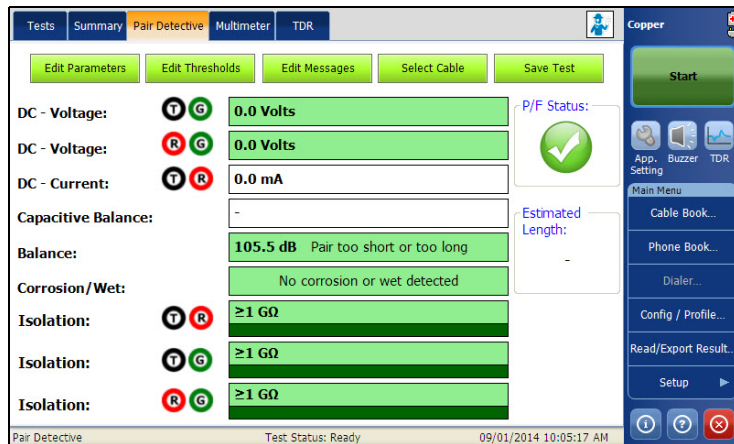

Note: Results are not real and for example only.

Pair Detective Test

Pair Detective

The page allows you to set the following parameters:

- **Edit Parameters** button opens a new page that allows you to set the soak period of time from 0 to 59 Minutes and 59 Seconds for the **Isolation** test. Default is 30 s.
- **Edit Thresholds** button opens a new page that allows you to set the **Pair Detective** threshold parameters.
- **Edit Messages** button allows you to edit the error messages in the test.
- **Select Cable** button opens a new page that allows you to set the **Cable Parameters** for the test.
- **Save Test** button opens a new page that allows you to save a snapshot of test results into a result file. Refer *Save Test* on page 74 for more information.

Setting Test Parameters

The **Test Parameters** page allows you to set **Test Parameters** for the **Pair Detective** test.

To set the Test Parameter values:

1. From the **Copper** main menu **Test Groups**, select **Pair Detective** test.
2. From the **Tests** menu, select **Pair Detective** test.
3. Tap **Edit Parameters** button to open the **Test Parameters** page.
4. Configure the **Isolation Soak Time** as required.
5. Tap **Close** to confirm and exit the page.

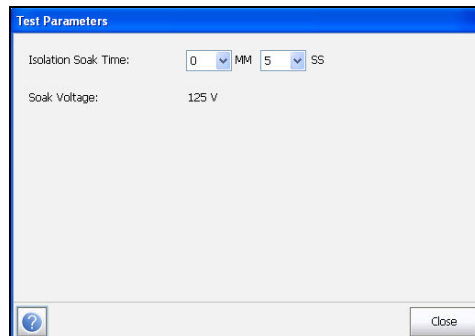

The page allows you to set the following parameters:

Isolation Soak Time sets a soak period of time from 0 to 59 minutes and 59 seconds for the **Pair Detective** test.

Setting Threshold Values

The **Test Thresholds** page allows you to set the **Pair Detective** threshold values.

To set the Threshold values:

1. From the **Copper** main menu **Test Groups**, select **Pair Detective** test.
2. From the **Tests** menu, select **Pair Detective** test.
3. Tap **Edit Thresholds** button to open the **Test Thresholds** page.
4. Configure the thresholds as required.
5. Tap **Close** to confirm and exit the page.

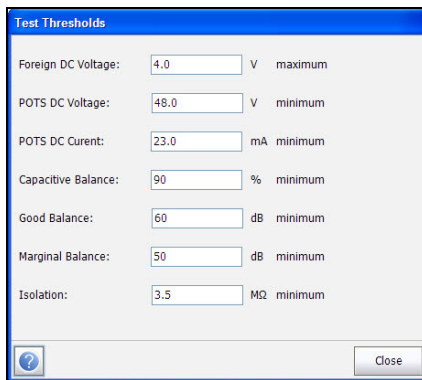

The screenshot shows a dialog box titled "Test Thresholds" with a blue header. It contains seven rows of configuration options, each with a text input field, a unit, and a label. The values in the input fields are: 4.0, 48.0, 23.0, 90, 60, 50, and 3.5. At the bottom left is a help icon (question mark in a circle) and at the bottom right is a "Close" button.

Parameter	Value	Unit	Label
Foreign DC Voltage:	4.0	V	maximum
POTS DC Voltage:	48.0	V	minimum
POTS DC Current:	23.0	mA	minimum
Capacitive Balance:	90	%	minimum
Good Balance:	60	dB	minimum
Marginal Balance:	50	dB	minimum
Isolation:	3.5	MΩ	minimum

The page allows you to set the following parameters:

- **Foreign DC Voltage** sets the maximum foreign DC voltage value.
- **POTS DC Voltage** sets the minimum working POTS DC voltage value.
- **POTS DC Current** sets the minimum working POTS DC current value.
- **Capacitive Balance** sets the minimum capacitive balance threshold as a percentage.
- **Good Balance** sets the good balance threshold.

- **Marginal Balance** sets the marginal balance threshold.
- **Isolation** sets the isolation resistance threshold.

Edit Messages

The **Edit Messages** page allows you to edit any error messages within the Pair Detective test.

To edit messages:

1. From the **Copper** main menu **Test Groups**, select **Pair Detective** test.
2. From the **Tests** menu, select **Pair Detective** test.
3. Tap **Edit Messages** button to open the **Pair Detective Messages** page.
4. Enter changes as required.
5. Tap **Close** to confirm and exit the page.

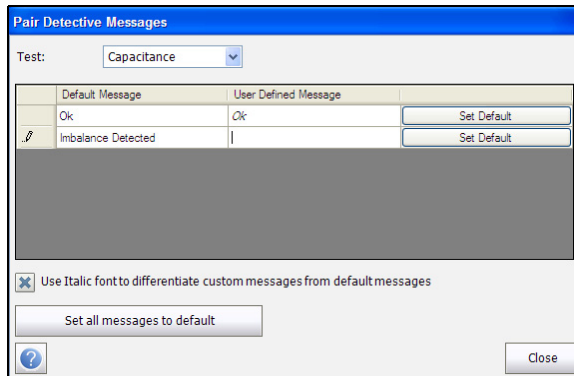

Pair Detective Test

Pair Detective

The page allows you to edit the following parameters:

- **Test** displays a list of all the Pair Detective tests containing default error messages. Select the test(s) you want to set a custom message for.
- Message box displays the **Default Message(s)** specific to each test, alongside a column for **User Defined Message** where you can enter your edit(s). Each message has a **Set Default** button that reverts your entry back to the **Default Message**.
- **Use Italic font to differentiate custom messages from default messages** enables your messages to be displayed in italics, when checked.
- **Set all messages to default** button allows you to clear all your edits at once.

Setting Cable Parameters

The **Cable Setup** page allows you to set **Cable Parameters** for the **Pair Detective** test.

To set the Cable values:

1. From the **Copper** main menu **Test Groups**, select **Pair Detective** test.
2. From the **Tests** menu, select **Pair Detective** test.
3. Tap **Select Cable** button to open the **Cable Selection** page.
4. Configure the **Cable Parameters** as required.
5. Tap **Close** to confirm and exit the page.

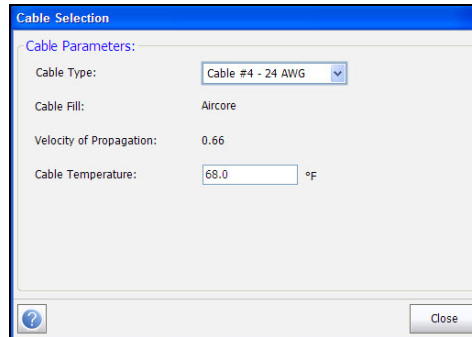

The page allows you to set the following parameters:

- **Cable Type** allows you to select a cable entry (with its associated parameters) from the current **Cable Book**, to use for testing. The selection is not saved when leaving the test. The current Cable Book entry is shown by default.
- **Cable Fill** read-only entry is the type of material the cable is filled with: **Aircore**, **Jelly**, **Pulp**, **5 PR**, or **2 PR**. Setup in the **Cable Book**.
- **Velocity of Propagation** read-only entry is the velocity of propagation for the cable as a ratio of the speed of light. Setup in the **Cable Book**.
- **Cable Temperature** allows you to change the temperature of the cable under test in either degree **C** or **F**.

Pair Detective Test

Multimeter

Multimeter

The Pair Detective **Multimeter** page displays read-only results and the **P/F** (pass/fail) status for the tests.

To access the Multimeter Page:

1. From the **Copper** main menu **Test Groups**, select **Pair Detective** test.
2. From the **Tests** menu, select **Pair Detective** to start the test.
3. Tap **Multimeter** tab to open the **Multimeter** page.

The screenshot shows the Multimeter test page with the following data:

DC Voltage:		
Pair	VDC	P/F
T R	4.9	✓
T G	3.6	✓
R G	2.2	✓

DC Current:	
Pair	DC
T R	8.5 mA

Opens:			
Pair	Opens	Length	All Pairs
T R	0.88 nF	55 ft	✗
T G	1.67 nF	70 ft	Capacitive Balance
T R	0.16 nF	6 ft	9 %

Isolation:			
Pair	Resistance	Soak Counter (HH:MM:SS)	P/F
T R	24 Ω	5	✗
T G	25 Ω	5	✗
R G	25 Ω	5	✗

At the bottom of the screen, it says "Pair Detective", "Test Status: Ready", and "8/29/2012 5:17:21 AM".

The **Multimeter** page displays the **P/F** status of the following tests:

- **DC Voltage** displays the volts for each DC **Pair**.
- **DC Current** displays the **DC** current results for T-R wire **Pair**.
- **Capacitance/Opens** displays **Capacitance** and **Length** for each wire **Pair** as well as **Capacitive Balance** among **All Pairs** in %.
- **Isolation** displays **Resistance** and a **Soak Counter** for each wire **Pair**.

TDR

The Pair Detective **TDR** tab allows you to review the TDR test capturing results retrieved from the **Pair Detective** test. The TDR starts each time Pair Detective is run and continues to run for your convenience upon completion of Pair Detective sequence. Refer to *Auto TDR* on page 188 for more information on this test.

To access the TDR test:

1. From the **Copper** main menu **Test Groups**, select **Pair Detective** test.
2. From the **Tests** menu, tap **Pair Detective** icon to start the test.
3. Upon completion of Pair Detective sequence, you may select and use the **TDR** which is still running.
4. Use the graph controls to maneuver the graph. Refer to *Graph Controls* on page 19 for more information.



Pair Detective Test

Summary

The page allows you to select the following parameters:

- **Edit Parameters** button opens a new page that allows you to select the test values. See *Edit Parameters* on page 189 for more information.
- **Select Cable** button opens a new page that allows you to set cable parameters for the current test. See *Select Cable* on page 190 for more information.

Summary

The **Summary** tab displays the pass/fail status and identifying information of the tests executed. Refer to *Copper Tests: Result Summary* on page 291 for more information.

8 Auto Test

Auto Test allows you to automatically run tests used in pre-qualification, installation, and maintenance of different circuit types from POTS to VDSL2.

POTS Auto Test

The Purpose of the POTS Auto Test is to quickly access the quality of the pair to transmit voice. This test allows you to compare measured results against stored threshold values to provide pass or fail status results of the POTS circuit type. The line must be provisioned on a switch supporting these test functions: drop battery, milliwatt tone, or quiet line state.

To access POTS Auto Test:

1. From the **Copper** main menu **Test Groups**, select **Auto Test**.
2. From the **Tests** menu, select **POTS Auto Test** to start the test.

By default, the **POTS Auto** page opens.

The screenshot displays the 'POTS Auto' test interface. At the top, there are tabs for 'Tests', 'Summary', and 'POTS Auto'. Below the tabs are buttons for 'Edit Parameters', 'Edit Thresholds', 'Set Volume', and 'Save Test'. The main area is divided into 'Dial Information' and 'Global P/F'. Under 'Dial Information', the 'Number' is '-' and the 'Status' is 'On Hook'. A large red 'X' icon is visible next to the status. Below this is a table with columns 'Test', 'Value', and 'P/F'. The table contains the following data:

Test	Value	P/F
Loop DC Current (T - R):	8.5 mA	X
Loss (T - R):	-	
Power Influence:	-	
VF Noise:	-	
Balance:	-	

At the bottom of the interface, there is a status bar that reads 'Auto Test|POTS Auto' and 'Test Status: Test interrupted. Absence.. 8/29/2012 5:20:14 AM'. On the right side, there is a 'Copper' sidebar with a 'Start' button and a 'Main Menu' section containing options like 'Cable Book...', 'Phone Book...', 'Dialer...', 'Config / Profile...', 'Read Result File...', and 'Setup'.

Auto Test

POTS Auto Test

The page allows you to set the following parameters:

- **Edit Parameters** button opens a new page that allows you to set the parameters for POTS Auto test.
- **Edit Thresholds** button opens a new page that allows you to set the **POTS Auto** thresholds.
- **Set Volume** button opens a new page that allows you to adjust the volume level.
- **Save Test** button opens a new page that allows you to save a snapshot of test results into a result file. Refer *Save Test* on page 74 for more information.

Setting Threshold Values

The **Test Thresholds** page allows you to set the **POTS Auto Test** threshold values for the combination of multiple tests.

To set the Threshold values:

1. From the **Copper** main menu **Test Groups**, select **Auto Test**.
2. From the **Tests** menu, select **POTS Auto Test**.
3. Tap **Edit Thresholds** button to open the **Test Thresholds** page.
4. Edit the Threshold values as required.
5. Tap **Close** to confirm and exit the page.

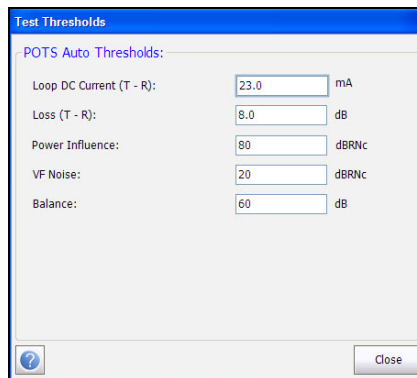

The screenshot shows a dialog box titled "Test Thresholds" with a blue header. Below the header, it says "POTS Auto Thresholds:". There are five rows of input fields, each with a label on the left, a text box in the middle, and a unit on the right. The values in the text boxes are: 23.0, 8.0, 80, 20, and 60. At the bottom left is a help icon (a question mark in a circle), and at the bottom right is a "Close" button.

Parameter	Value	Unit
Loop DC Current (T - R):	23.0	mA
Loss (T - R):	8.0	dB
Power Influence:	80	dBm/c
VF Noise:	20	dBm/c
Balance:	60	dB

The page allows you to set the following parameters:

- **Loop DC Current (T-R)** sets the DC current value for the T-R wire pair.
- **Loss (T-R)** sets the loss value for the T-R wire pair.
- **Power Influence** sets the power influence value for the test.
- **VF Noise** sets the level of voice frequency noise to be used.
- **Balance** sets the balance value for active mode.

Setting Test Volume

The Set Volume page allows you to set the POTS Auto Test Volume.

To set the Volume:

1. From the **Copper** main menu **Test Groups**, select **Auto Test**.
2. From the **Tests** menu, select **POTS Auto Test**.
3. Tap **Set Volume** button to open the **Volume Settings** page.
4. Set the volume as required.
5. Tap **Close** to confirm and exit the page.

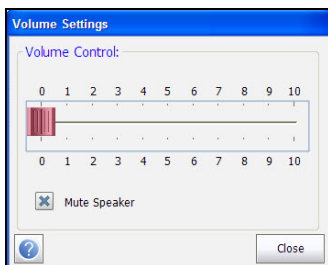

The page allows you to set the following parameters:

- **Volume** control adjusts the volume level.
- **Mute Speaker** check box changes the speaker status.

Setting Test Parameters

The **Test Parameters** page allows you to set the **POTS Auto** test parameters.

To set the Parameter values:

1. From the **Copper** main menu **Test Groups**, select **Auto Test**.
2. From the **Tests** menu, select **POTS Auto Test**.
3. Tap **Edit Parameters** button to open the **Test Parameters** page.
4. Set the parameters as required.
5. Tap **Close** to confirm and exit the page.

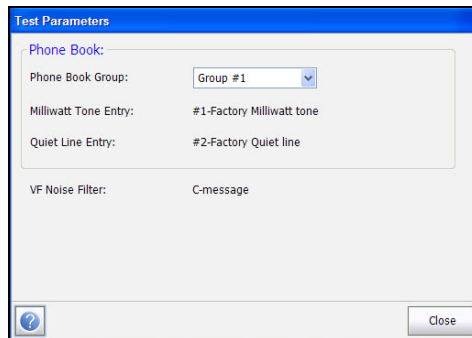

The page allows you to set the following parameters:

- **Phone Book Group** allows you to select the **Group #** from a list of phone book groups that include mW tone entries.
- **Milliwatt Tone Entry** displays at least 1 mW tone entry number from the selected **Phone Book Group**.
- **Quiet Line Entry** displays the quiet line entry number from the selected **Phone Book Group**.
- **VF Noise Filter** displays the voice frequency noise filter used, dependent on **ITU** or **ANSI Standard** mode and Noise Filter set in **Setup/Application Settings**.

Auto Test

Summary

Summary

The voltage and resistance provides you the basic measurements needed to identify loop currents, Power Influence and voice frequency values. POTS Auto Test consists of a combination of multiple tests.

Summary tab displays the pass/fail status of the tests executed. Refer *Copper Tests: Result Summary* on page 291 for more information.

User Auto Test

User Auto Test runs a range of different user-defined tests that compare measured results against stored threshold values to provide pass or fail status and results. Test parameters and thresholds are inherited from individual tests.

To access User Auto Test:

1. From the **Copper** main menu **Test Groups**, select **Auto Test**.
2. From the **Tests** menu, select **User Auto Test** to start the test.

By default, the **User Auto Test** page opens.

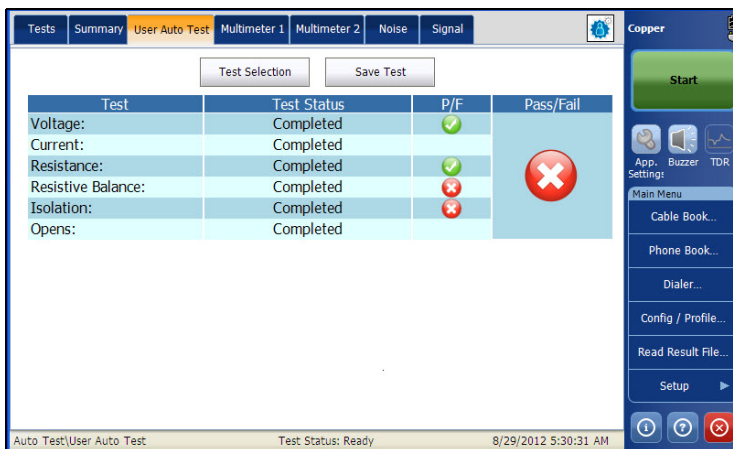

The page allows you to set the following parameters:

- **Test Selection** button opens a new page that allows you to select the tests to include in the **User Auto Test**.
- **Save Test** button opens a new page that allows you to save a snapshot of test results into a result file. Refer *Save Test* on page 74 for more information.

User Auto Test Selection

The **Test Selection** page allows you to select up to 13 test types to include in the auto test, and set a **Pause** between tests by selecting Pause check box. All listed tests have a fixed duration (snapshot) and are not continuous. Graphs are not displayed.

To select the test:

1. From the **Copper** main menu **Test Groups**, select **Auto Test**.
2. From the **Tests** menu, select **User Auto Test** to start the test.
3. Tap **Test Selection** button to open a new page.
4. Select the tests to run.
5. Tap **Close** to confirm and exit the page.

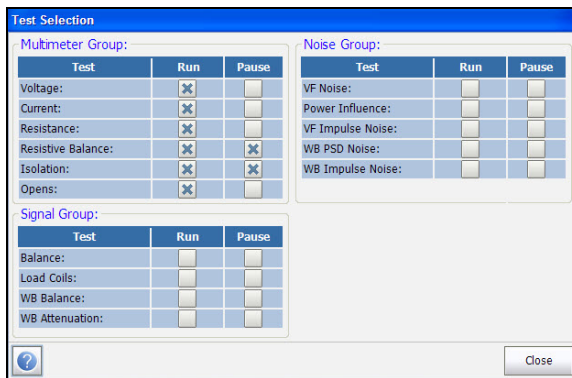

The following tests are available:

- **Voltage** detects AC RMS and DC voltages in the line.
- **Current** checks for AC RMS and DC currents in the line.
- **Resistance** uses DC current to measure the opposition to flow, or resistance, between each of the lead combinations. It is also used to identify possible faults, and to measure the resistance of the twisted pair cable for estimating loop length.

- **Resistive Balance** measures and compares the resistance of each leg.
- **Isolation** measures the quality of insulation or sheathing for the copper pairs.
- **Opens** measures the capacitance with distance conversion for each lead, useful to indicate an open wire.
- **VF Noise** measures voice frequency noise in the line.
- **Power Influence** measures the effects that 50 Hz and 60 Hz power line (AC Mains) interference has on the circuit under test.
- **VF Impulse Noise** measures the random occurrences of energy spikes in the voice frequency range that have random amplitude and spectral content.
- **WB PSD Noise** measures power spectral density noise.
- **WB Impulse Noise** measures the irregular occurrences of energy spikes in the wideband range that have random amplitude and spectral content.
- **Balance** determines how much noise the pair can mitigate, in dB, based on the difference between longitudinal and mutual noise, which depends on how much the two conductors are the same. It is very useful in identifying loops that will suffer from crosstalk.
- **WB Balance** performs a balance test like above, but across a very wide frequency spectrum.
- **WB Attenuation** is a single-ended loss test that calculates the dissipation of power of a transmitted signal as it travels over the copper line.
- **Load Coils** counts the number of load coils in the line.

Multimeter 1

The **Multimeter 1** page displays the multimeter 1 results and pass/fail status.

To access Multimeter 1 Page:

1. From the **Copper** main menu **Test Groups**, select **Auto Test**.
2. From the **Tests** menu, select **User Auto Test** to start the test.
3. Tap **Multimeter 1** tab to open the **Multimeter 1** page.

Voltage:					
Pair	VDC	P/F	VAC	F(Hz)	P/F
T R	4.9	✓	2.3	1.1	✓
T G	-		-	-	
R G	-		-	-	

Current:					
Pair	DC (mA)	P/F	AC (mA)	F(Hz)	P/F
T R	8.5		5.0	6.7	
T G	-		-	-	
R G	-		-	-	

Resistance:			
Pair	Resistance	Length	P/F
T R	40.6 Ω	777 ft	✓
T G	-	-	
R G	-	-	

The page displays the following results:

- **AC-DC Voltage** - volts and frequency (**Hz**) values for each continuous AC/DC **Pair**.
- **AC-DC Current** - DC current, AC current and frequency (**Hz**) values for each wire **Pair**.
- **Resistance** and **Length** for each wire **Pair**.

Multimeter 2

The **Multimeter 2** page displays additional loop tests and pass/fail statuses.

To access **Multimeter 2** Page:

1. From the **Copper** main menu **Test Groups**, select **Auto Test**.
2. From the **Tests** menu, select **User Auto Test** to start the test.
3. Tap **Multimeter 2** tab to open the **Multimeter 2** page.

Resistive Balance:		
R-Leg (Resistance)	T-Leg (Resistance)	Loop (Resistance)
6.0Ω	5.7Ω	11.7Ω
Resistive Balance		P/F
0.3Ω		✖
95 %		

Isolation:			
Pair	Resistance	Soak Counter (s)	P/F
T R	24 Ω	5	✖
T G	-	-	
R G	-	-	

Opens:		
Pair	Opens	Length
T R	0.88 nF	55 ft
T G	-	-
R G	-	-

Auto Test: User Auto Test Test Status: Ready 8/29/2012 5:33:45 AM

The page displays the following results:

- **Resistive Balance - R-Leg, T-Leg, Loop** resistance, and pass/fail status and values in Ω and %.
- **Isolation** - pass/fail status, **Resistance** and a **Soak Counter(s)** for each wire **Pair**.
- **Capacitance/Opens** and **Length** for each wire **Pair**.

Auto Test

User Auto Test

Noise

The **Noise** page displays the noise results and their pass/fail status.

To access the Noise Page:

1. From the **Copper** main menu **Test Groups**, select **Auto Test**.
2. From the **Tests** menu, select **User Auto Test** to start the test.
3. Tap **Noise** tab to open the **Noise** page.

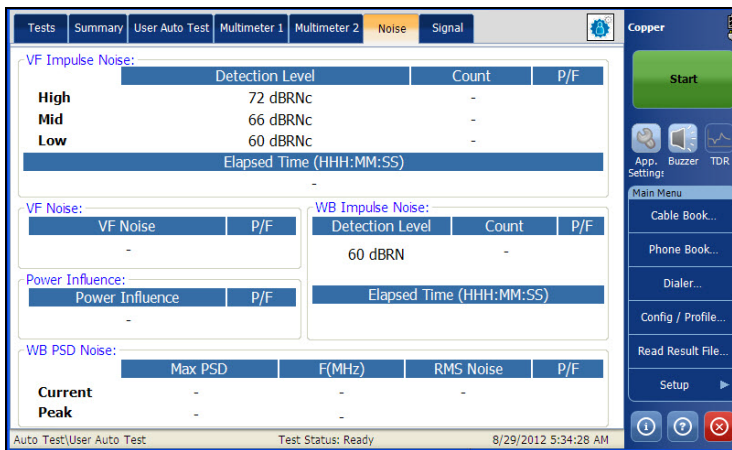

The page displays the following results:

- **VF Noise**
- **Power Influence**
- **VF Impulse Noise - High, Mid, Low** counts, respective detection levels, and **Elapsed Time**. Here the pass/fail status is for the **Mid** level only.
- **WB PSD Noise - Max PSD** and frequency and **RMS Noise** values differentiating the **Current** trace from the **Peak** hold.
- **WB Impulse Noise - impulse Count, Detection Level, and Elapsed Time**.

Auto Test

User Auto Test

Signal

The **Signal** page displays the signal results and their pass/fail status.

To access the Signal Page:

1. From the **Copper** main menu **Test Groups**, select **Auto Test**.
2. From the **Tests** menu, select **User Auto Test** to start the test.
3. Tap **Signal** tab to open the **Signal** page.

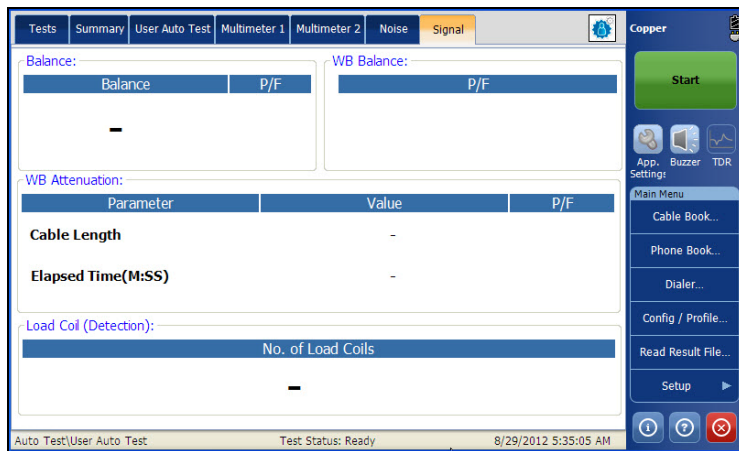

The page displays the following results:

- **Balance** and pass/fail status.
- **WB Balance** pass/fail status.
- **WB Attenuation**
- **Load Coil (Detection)** - number of load coils.

Summary

Summary tab displays the pass/fail status of the tests executed. Refer *Copper Tests: Result Summary* on page 291 for more information.

9 *FaultMapper Test*

The **FaultMapper** is a unique function that analyzes TDR, resistance, and capacitance results to automatically identify, locate and present a number of common cable faults in a unique graphical presentation using plain language.

FaultMapper

The **FaultMapper** page allows you to configure the parameters for the **FaultMapper** test and view the results. The page also displays the pass/fail status of the test.

To access FaultMapper Test:

1. From the **Copper** main menu **Test Groups**, select **FaultMapper**.
2. From the **Tests** menu, select **FaultMapper** to start the test.

By default, the **FaultMapper** page opens.

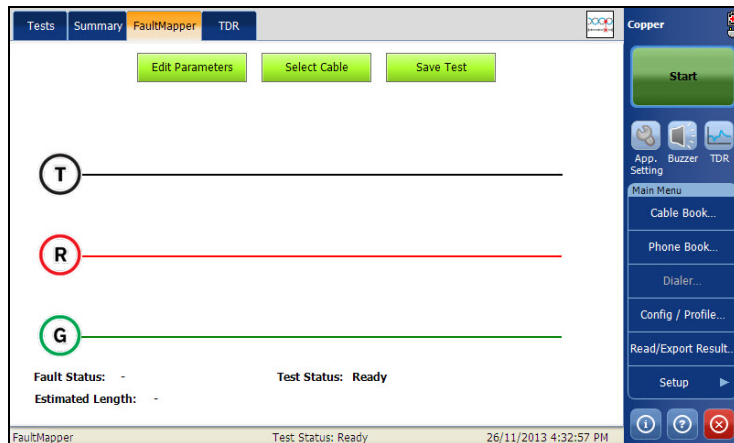

FaultMapper Test

FaultMapper

The page allows you to set the following parameters:

- **Edit Parameters** button opens a new page that allows you to set the test parameters.
- **Select Cable** button opens a new page that allows you to set the cable parameters for the current test.
- **Save Test** button opens a new page that allows you to save a snapshot of test results into a result file. Refer *Save Test* on page 74 for more information.
- **Fault Status** displays the number of faults detected after running the test. The status **Open detected** is reported in the following case:
 - No strap.
 - The pair is open.
 - No faults (other than the pair being open).

Open and the distance to **Open** are displayed and represented using **X** in the graph.

- **Test Status** displays the current state of measurement or an error message.
- **Estimated Length** displays the cable length when the cable is open.

Note: *The cable length may include the Bridge Tap length. Remove the Bridge Tap for better accuracy.*

Setting Test Parameters

The **Edit Parameters** page allows you to set **Test Parameters** for the **FaultMapper** test.

To configure the Edit Parameters:

1. From the **Copper** main menu **Test Groups**, select **FaultMapper** test.
2. From the **Tests** menu, select **FaultMapper** test.
3. Tap **Edit Parameters** button to open the **Test Parameters** page.
4. Configure the parameters as required.
5. Tap **Close** to confirm and exit the page.

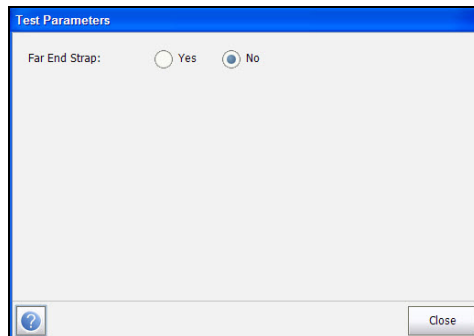

The page allows you to set the following parameter:

Far End Strap allows you to enable or disable Far End Strap.

Setting Cable Parameters

The **Cable Setup** page allows you to set **Cable Parameters** for the **FaultMapper** test.

To configure the Cable Setup:

1. From the **Copper** main menu **Test Groups**, select **FaultMapper** test.
2. From the **Tests** menu, select **FaultMapper** test.
3. Tap **Select Cable** button to open the **Cable Selection** page.
4. Configure the cable parameters as required.
5. Tap **Close** to confirm and exit the page.

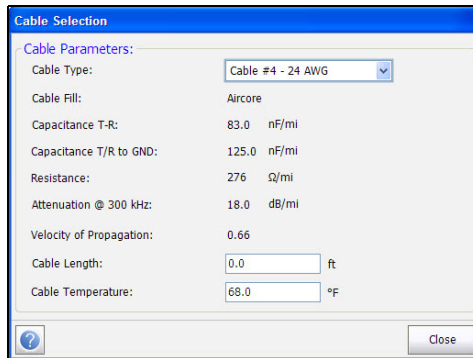

The screenshot shows a dialog box titled "Cable Selection" with a blue header. Below the header, the text "Cable Parameters:" is followed by a list of settings. "Cable Type:" is a dropdown menu showing "Cable #4 - 24 AWG". "Cable Fill:" is a text field showing "Aircore". "Capacitance T-R:" is a text field showing "83.0 nF/mi". "Capacitance T/R to GND:" is a text field showing "125.0 nF/mi". "Resistance:" is a text field showing "276 Ω/mi". "Attenuation @ 300 kHz:" is a text field showing "18.0 dB/mi". "Velocity of Propagation:" is a text field showing "0.66". "Cable Length:" is a text field showing "0.0 ft". "Cable Temperature:" is a text field showing "68.0 °F". At the bottom left is a help icon (question mark in a circle), and at the bottom right is a "Close" button.

The page allows you to select a cable type, set length and temperature, and view other parameters:

- **Cable Type** allows you to select a cable entry (with its associated parameters) from the current **Cable Book**, to use for testing. The selection is not saved when leaving the test. The current Cable Book entry is shown by default. The current cable may be set from the cable book.
- **Cable Fill Material** read-only entry is the type of material the cable is filled with: **Aircore**, **Jelly**, **Pulp**, **5 PR**, or **2 PR**. Setup in the **Cable Book**.

- **Capacitance T-R** specifies a value for the capacitance per length constant.
- **Capacitance T-R to GND** specifies a value for the capacitance per length to ground constant.
- **Resistance** specifies a value for the resistance constant of the cable.
- **Attenuation @ 300 kHz** specifies a value for the reduction in signal strength or insertion loss of the cable.
- **Cable Length** specifies the length of the cable.
- **Velocity of Propagation** read-only entry is the velocity of propagation for the cable as a ratio of the speed of light. Setup in the **Cable Book**.
- **Cable Temperature** allows you to change the temperature of the cable under test in either degree **C** or **F**.

TDR

The FaultMapper **TDR** tab allows you to run an Auto TDR test capturing results retrieved from the **FaultMapper** test. Refer to *Auto TDR* on page 188 for more information on this test.

To access the TDR test:

1. From the **Copper** main menu **Test Groups**, select **FaultMapper** test.
2. From the **Tests** menu, tap **FaultMapper** icon to start the test.
3. Select the **TDR** tab to run this test. Tap **OK** when the test asks you to leave the FaultMapper and go to the TDR test.
4. Use the graph controls to maneuver the graph. Refer to *Graph Controls* on page 19 for more information.

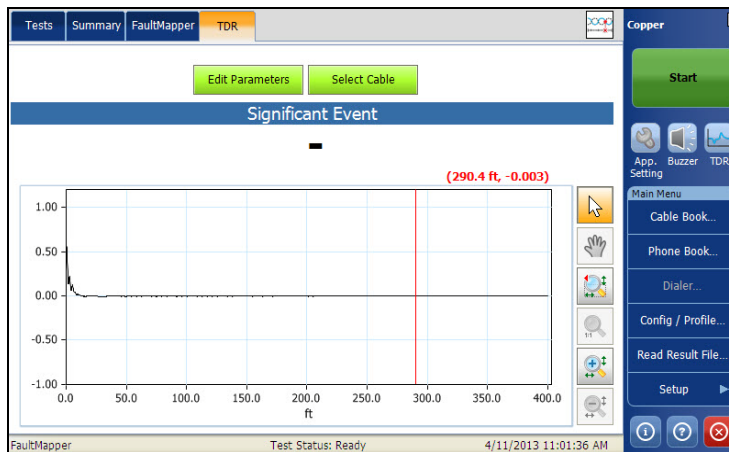

The page allows you to select the following parameters:

- **Edit Parameters** button opens a new page that allows you to select the test values. See *Edit Parameters* on page 189 for more information.
- **Select Cable** button opens a new page that allows you to set cable parameters for the current test. See *Select Cable* on page 190 for more information.

Summary

Summary tab displays the pass/fail status of the tests executed. Refer *Copper Tests: Result Summary* on page 291 for more information.

10 *Multimeter Tests*

The purpose of the multimeter tests function is to detect AC/DC voltages and currents, measure resistance and capacitance in a loop, and the balance of a circuit. These tests allow you to make basic electrical safety checks (AC volts), check from *crossed* or coupled battery voltages, assess basic loop continuity and quality with resistance measurements, and measure total electrical length with capacitance.

Refer to *Multimeter 2 Tests* on page 169 for **Isolation**, **Locator Tone**, and **Load Coils** tests.

To access Multimeter tests:

From the **Copper** main menu **Test Groups**, tap **Multimeter**.

Multimeter Main Page

The **Multimeter** menu allows you to select and run the displayed tests:

- **Voltage**
- **Current**
- **Resistance**
- **Capacitance/Opens**
- **Resistive Balance**
- **Balance**



To start/stop a test:

1. From the **Copper** main menu **Test Groups**, select **Multimeter** test.
2. From the **Tests** menu, select the test to run.

Voltage Test

The **Voltage** test detects AC RMS and DC voltages in the line and allows you to measure AC/DC voltages and **Frequency** on A/B/E or T/R/G depending on the selected **Standard** in **Setup/Application Settings**.

Snapshot

The voltage **Snapshot** shows measured volts for each lead combination. This page also displays a snapshot of the pass/fail status, volts and frequency (Hz) values for each continuous AC/DC pair.

To access Snapshot page:

1. From the **Copper** main menu **Test Groups**, select **Multimeter** test.
2. From the **Tests** menu, select **Voltage** test to start the test.

By default, the **Snapshot** page opens.

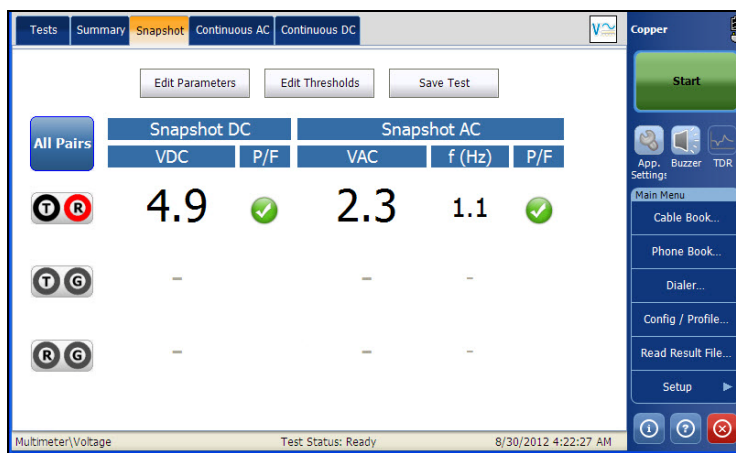

The current group and the current test which is being measured is displayed in the status bar, for example **Multimeter\Voltage**.

Multimeter Tests

Voltage Test

The page displays the following parameters:

- **All Pairs** allow you to select **All Pairs** for measurement.

Note: *You can select individual wire pairs to view the result for that particular wire pair.*

- **Edit Threshold** button opens a new page that allows you to set the AC/DC voltage thresholds for each pair.
- **Edit Parameters** button opens a new page that allows you to set the termination resistance for the selected pair.
- **Save Test** button opens a new page that allows you to save a snapshot of test results into a result file. Refer *Save Test* on page 74 for more information.
- **Test Status** displays the current state of measurement or an error message.

Continuous AC

The **Continuous AC** function measures each pair, displaying and updating results in *real time*, until you stop the test. The last valid results then remain displayed.

Continuous AC and **Continuous DC** runs synchronously.

To access Continuous AC page:

1. From the **Copper** main menu **Test Groups**, select **Multimeter** test.
2. From the **Tests** menu, select **Voltage** test to start the test.
3. Tap **Continuous AC** tab to open the Continuous AC page.

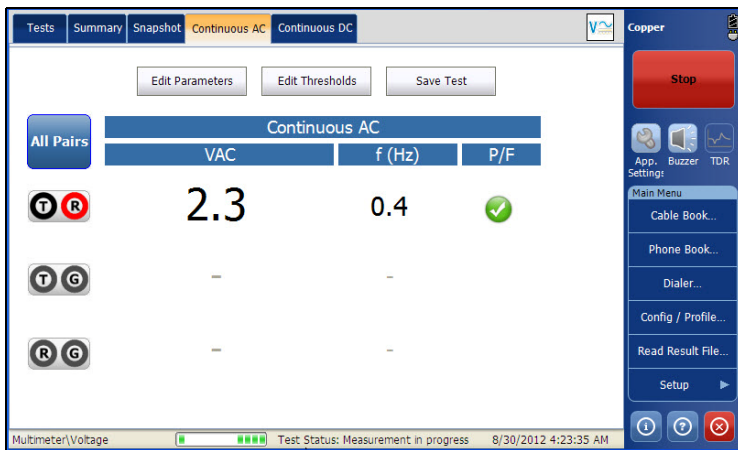

The current group and the current test which is being measured is displayed in the status bar, for example **Multimeter\Voltage**.

Multimeter Tests

Voltage Test

The page displays the following parameters:

- **All Pairs** allow you to select **All Pairs** for measurement.

Note: *You can select individual wire pairs to view the result for that particular wire pair.*

- **Edit Threshold** button opens a new page that allows you to set the AC voltage thresholds for each pair.
- **Edit Parameters** button opens a new page that allows you to set the terminal resistance for the selected pair.
- **Save Test** button opens a new page that allows you to save a snapshot of test results into a result file. Refer *Save Test* on page 74 for more information.
- **Test Status** displays the current state of measurement or an error message.

Continuous DC

The **Continuous DC** function measures each pair, displaying and updating results in *real time*, until you stop the test. The last valid results then remain displayed.

Continuous AC and **Continuous DC** are run synchronously.

To access Continuous DC page:

1. From the **Copper** main menu **Test Groups**, select **Multimeter** test.
2. From the **Tests** menu, select **Voltage** test to start the test.
3. Tap **Continuous DC** tab to open the Continuous DC page.

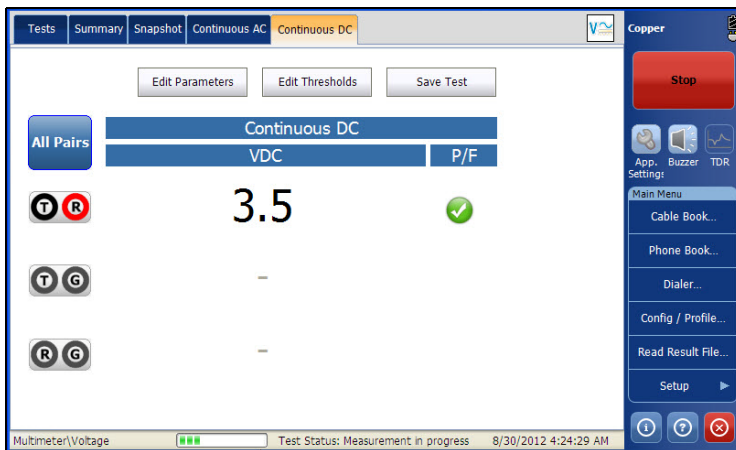

The current group and the current test which is being measured is displayed in the status bar, for example **Multimeter\Voltage**.

Multimeter Tests

Voltage Test

The page displays the following parameters:

- **All Pairs** allow you to select **All Pairs** for measurement.

Note: *You can select individual wire pairs to view the result for that particular wire pair.*

- **Edit Threshold** button opens a new page that allows you to set the DC voltage thresholds for each pair.
- **Edit Parameters** button opens a new page that allows you to set the terminal resistance for the selected pair.
- **Save Test** button opens a new page that allows you to save a snapshot of test results into a result file. Refer *Save Test* on page 74 for more information.
- **Test Status** displays the current state of measurement or an error message.

Setting Threshold Values

The **Test Threshold** page allows you to set the **Threshold Voltage** for each pair.

To set the Threshold values:

1. From the **Copper** main menu **Test Groups**, select **Multimeter** test.
2. From the **Tests** menu, select **Voltage** test.
3. Tap **Continuous DC** or **Continuous AC** tab for which you want to set the Threshold values.
4. Tap **Edit Thresholds** button to open the **Test Thresholds** page.
5. Set the Threshold values as required.
6. Tap **Close** to confirm and exit the page.

The screenshot shows a dialog box titled "Test Thresholds" with a subtitle "DC Voltage Threshold:". It contains three sections for setting thresholds: "T - R", "T - G", and "R - G". Each section has a "Threshold:" dropdown menu set to "Maximum" and a "Threshold Voltage:" text input field containing "500.0" followed by "VDC". At the bottom left is a help icon (question mark) and at the bottom right is a "Close" button.

The page allows you to set the following parameters:

- **Threshold** is the threshold limit for each pair: **Maximum**, **Minimum**, or **None**.
- **Threshold Voltage** sets the threshold value.

Setting Test Parameters

The **Test Parameters** page allows you to set the **Multimeter Voltage** test parameters.

To set the Parameter values:

1. From the **Copper** main menu **Test Groups**, select **Multimeter** test.
2. From the **Tests** menu, select **Voltage** test.
3. Tap **Continuous DC** or **Continuous AC** tab for which you want to set the Parameter values.
4. Tap **Edit Parameters** button to open the **Test Parameters** page.
5. Set the Parameter values as required.
6. Tap **Close** to confirm and exit the page.

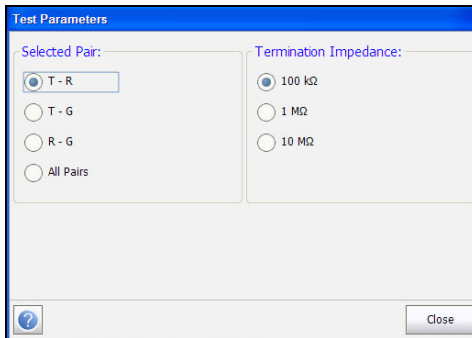

The page allows you to set the following parameters:

- **Selected Pair** allows you to select the pair for which the resistance is to be set.
- **Termination Resistance** allows you to set the termination resistance for the selected pair.

Summary

Summary tab displays the pass/fail status of the tests executed. Refer *Copper Tests: Result Summary* on page 291 for more information.

Current Test

The **Current** test allows you to measure the AC/DC currents and frequency in the loop.

Snapshot

The current **Snapshot** shows measured AC/DC results for each lead combination.

To access Snapshot page:

1. From the **Copper** main menu **Test Groups**, select **Multimeter** test.
2. From the **Tests** menu, select **Current** test to start the test.

By default, the **Snapshot** page opens.

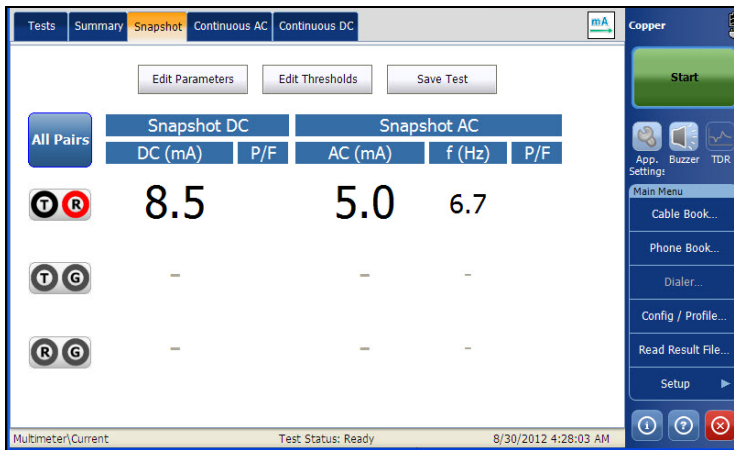

The current group and the current test which is being measured is displayed in the status bar, for example **Multimeter\Current**.

The page displays the following parameters:

- **All Pairs** allow you to select **All Pairs** for measurement.

Note: *You can select individual wire pairs to view the result for that particular wire pair.*

- **Edit Threshold** button opens a new page that allows you to set the AC/DC current thresholds for each pair.
- **Edit Parameters** button opens a new page that allows you to set the termination resistance for the selected pair.
- **Save Test** button opens a new page that allows you to save a snapshot of test results into a result file. Refer *Save Test* on page 74 for more information.
- **Test Status** displays the current state of measurement or an error message.

Multimeter Tests

Current Test

Continuous AC

The **Continuous AC** function measures each pair, displaying and updating results in *real time*, until you stop the test. The last valid results then remain displayed.

Continuous AC and **Continuous DC** are run synchronously.

To access Continuous AC page:

1. From the **Copper** main menu **Test Groups**, select **Multimeter** test.
2. From the **Tests** menu, select **Current** test to start the test.
3. Tap **Continuous AC** tab to open the Continuous AC page.

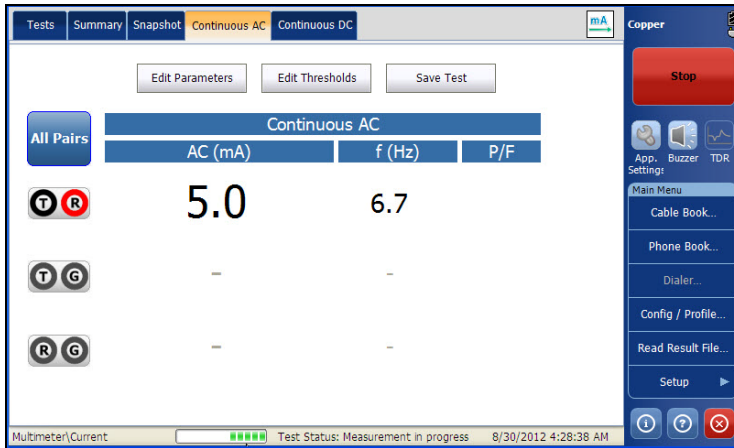

The current group and the current test which is being measured is displayed in the status bar, for example **Multimeter\Current**.

The page displays the following parameters:

- **All Pairs** allow you to select **All Pairs** for measurement.

Note: *You can select individual wire pairs to view the result for that particular wire pair.*

- **Edit Threshold** button opens a new page that allows you to set the AC/DC current thresholds for each pair.
- **Edit Parameters** button opens a new page that allows you to set the terminal resistance for the selected pair.
- **Save Test** button opens a new page that allows you to save a snapshot of test results into a result file. Refer *Save Test* on page 74 for more information.
- **Test Status** displays the current state of measurement or an error message.

Multimeter Tests

Current Test

Continuous DC

The **Continuous DC** function measures each pair, displaying and updating results in *real time*, until you stop the test. The last valid results then remain displayed.

Continuous AC and **Continuous DC** are run synchronously.

To access Continuous DC page:

1. From the **Copper** main menu **Test Groups**, select **Multimeter** test.
2. From the **Tests** menu, select **Current** test to start the test.
3. Tap **Continuous DC** tab to open the Continuous DC page.

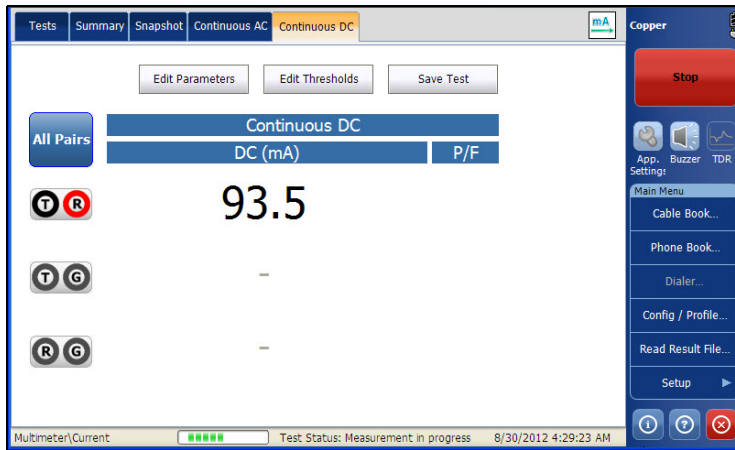

The current group and the current test which is being measured is displayed in the status bar, for example **Multimeter|Voltage**.

The page displays the following parameters:

- **All Pairs** allow you to select **All Pairs** for measurement.

Note: *You can select individual wire pairs to view the result for that particular wire pair.*

- **Edit Threshold** button opens a new page that allows you to set the AC/DC current thresholds for each pair.
- **Edit Parameters** button opens a new page that allows you to set the terminal resistance for the selected pair.
- **Save Test** button opens a new page that allows you to save a snapshot of test results into a result file. Refer *Save Test* on page 74 for more information.
- **Test Status** displays the current state of measurement or an error message.

Setting Threshold Values

The **Test Threshold** page allows you to set the **Threshold Current** for each pair.

To set the Threshold values:

1. From the **Copper** main menu **Test Groups**, select **Multimeter** test.
2. From the **Tests** menu, select **Current** test.
3. Tap **Continuous DC** or **Continuous AC** tab for which you want to set the Threshold values.
4. Tap **Edit Thresholds** button to open the **Test Thresholds** page.
5. Set the Threshold values as required.
6. Tap **Close** to confirm and exit the page.

The screenshot shows a dialog box titled "Test Thresholds" with a blue header. Below the header, it says "DC Current Threshold:". There are three sections, each for a different pair: "T - R", "T - G", and "R - G". Each section has a "Threshold:" label followed by a dropdown menu currently set to "None", and a "Threshold Current:" label followed by a text input field containing "50.0" and a "mA" unit. At the bottom left of the dialog is a help icon (a question mark in a circle), and at the bottom right is a "Close" button.

The page allows you to set the following parameters:

- **Threshold** is the threshold limit for each pair: **Maximum**, **Minimum**, or **None**.
- **Threshold Current** sets the threshold value.

Setting Test Parameters

The **Test Parameters** page allows you to set the **Multimeter Current** test parameters.

To set the Parameter values:

1. From the **Copper** main menu **Test Groups**, select **Multimeter** test.
2. From the **Tests** menu, select **Current** test.
3. Tap **Continuous DC** or **Continuous AC** tab for which you want to set the Parameter values.
4. Tap **Edit Parameters** button to open the **Test Parameters** page.
5. Set the Parameter values as required.
6. Tap **Close** to confirm and exit the page.

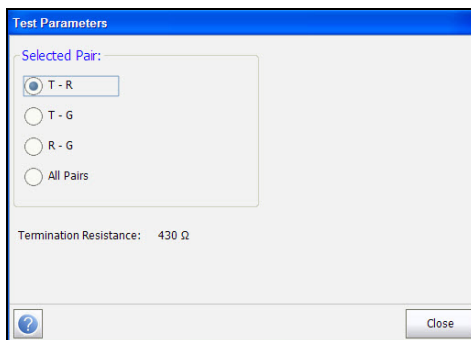

The page allows you to set the following parameters:

- **Selected Pair** allows you to select the pair for which the resistance is to be set.
- **Termination Resistance** displays the termination resistance for the selected pair.

Multimeter Tests

Current Test

Summary

Current measurements helps you to understand the voice frequency transmission, with snapshot or continuous measurements.

Summary tab displays the pass/fail status of the tests executed. Refer *Copper Tests: Result Summary* on page 291 for more information.

Resistance Test

The **Resistance** test allows you to measure the current resistance value and cable length for line under test.

Snapshot

The resistance **Snapshot** shows measured current resistance values and cable lengths for each lead combination. The page also displays a snapshot of the pass/fail status, **Resistance** and **Length** for each selected wire pair.

To access Snapshot page:

1. From the **Copper** main menu **Test Groups**, select **Multimeter** test.
2. From the **Tests** menu, select **Resistance** test to start the test.

By default, the **Snapshot** page opens.

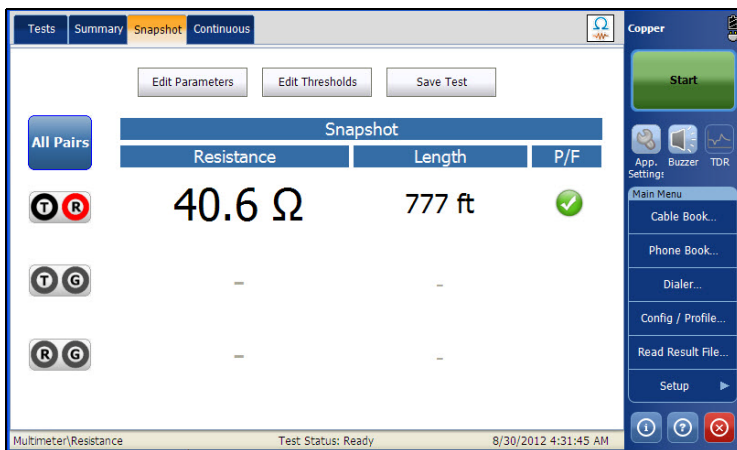

Multimeter Tests

Resistance Test

The current group and the current test which is being measured is displayed in the status bar, for example **Multimeter\Resistance**.

The page displays the following parameters:

- **All Pairs** allow you to select **All Pairs** for measurement.

Note: *You can select individual wire pairs to view the result for that particular wire pair.*

- **Edit Threshold** button opens a new page that allows you to set the Resistance thresholds for each pair.
- **Edit Parameters** button opens a new page that allows you to set the cable parameters for the selected pair.
- **Save Test** button opens a new page that allows you to save a snapshot of test results into a result file. Refer *Save Test* on page 74 for more information.
- **Test Status** displays the current state of measurement or an error message.

Continuous

The **Continuous** function measures each pair, displaying and updating results in *real time*, until you stop the test. The last valid results then remain displayed. The page also displays the last values of the pass/fail status, **Continuous Resistance** and **Length** for each selected wire pair.

To access Continuous page:

1. From the **Copper** main menu **Test Groups**, select **Multimeter** test.
2. From the **Tests** menu, select **Resistance** test to start the test.
3. Tap **Continuous** tab to open the Continuous page.

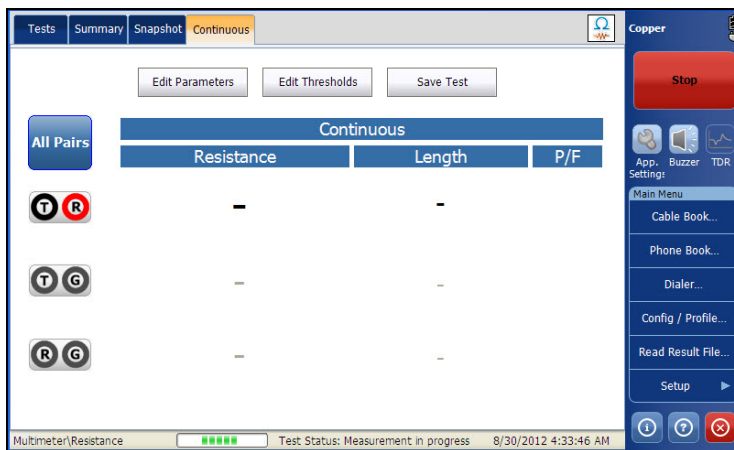

The current group and the current test which is being measured is displayed in the status bar, for example **Multimeter\Voltage**.

Multimeter Tests

Resistance Test

The page displays the following parameters:

- **All Pairs** allow you to select **All Pairs** for measurement.

Note: *You can select individual wire pairs to view the result for that particular wire pair.*

- **Edit Threshold** button opens a new page that allows you to set the AC/DC resistance thresholds for each pair.
- **Edit Parameters** button opens a new page that allows you to set the cable parameters for the selected pair.
- **Save Test** button opens a new page that allows you to save a snapshot of test results into a result file. Refer *Save Test* on page 74 for more information.
- **Test Status** displays the current state of measurement or an error message.

Setting Threshold Values

The **Test Threshold** page allows you to set the **Threshold Resistance** for each pair.

To set the Threshold values:

1. From the **Copper** main menu **Test Groups**, select **Multimeter** test.
2. From the **Tests** menu, select **Resistance** test.
3. Tap **Continuous** tab to set the Threshold values.
4. Tap **Edit Thresholds** button to open the **Test Thresholds** page.
5. Set the Threshold values as required.
6. Tap **Close** to confirm and exit the page.

The screenshot shows a dialog box titled "Test Thresholds" with a subtitle "Resistance Threshold:". It contains three sections for setting thresholds: "T - R", "T - G", and "R - G". Each section has a "Threshold:" dropdown menu set to "Maximum" and a "Threshold Resistance:" text input field set to "500.00" with a "kΩ" unit. At the bottom right is a "Close" button.

The page allows you to set the following parameters:

- **Threshold** is the threshold limit for each pair: **Maximum**, **Minimum**, or **None**.
- **Threshold Resistance** sets the threshold value.

Multimeter Tests

Resistance Test

Setting Test Parameters

The **Test Parameters** page allows you to set the **Multimeter Resistance** test parameters.

To set the Parameter values:

1. From the **Copper** main menu **Test Groups**, select **Multimeter** test.
2. From the **Tests** menu, select **Resistance** test.
3. Tap **Continuous** tab to set the Parameter values.
4. Tap **Edit Parameters** button to open the **Test Parameters** page.
5. Set the Parameter values as required.
6. Tap **Close** to confirm and exit the page.

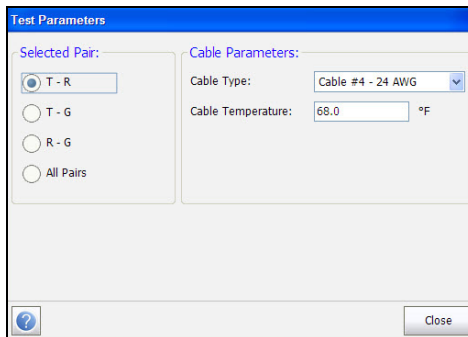

The page allows you to set the following parameters:

- **Selected Pair** allows you to select the pair for which the cable parameter is to be set.
- **Cable Type** allows you to select a cable entry (with its associated parameters) from the current Cable Book, to use for testing. The selection is not saved when leaving the test. The current Cable Book entry is shown by default.
- **Cable Temperature** is the temperature in either degree **C** or **F** of the cable under test.

Summary

Summary tab displays the pass/fail status of the tests executed. Refer *Copper Tests: Result Summary* on page 291 for more information.

Capacitance/Opens Test

The **Opens** test measures the capacitance of the loop and calculates length. Capacitive balance is also measured when all pairs are selected.

Snapshot

The capacitance/opens **Snapshot** shows measured **Capacitance** values and **Length** for each lead combination. The page also displays a snapshot of the pass/fail status, **Capacitance** and **Length** for each selected wire pair. **Capacitive Balance** is shown in % when **All Pairs** is selected.

To access Snapshot page:

1. From the **Copper** main menu **Test Groups**, select **Multimeter** test.
2. From the **Tests** menu, select **Opens** test to start the test.

By default, the **Snapshot** page opens.

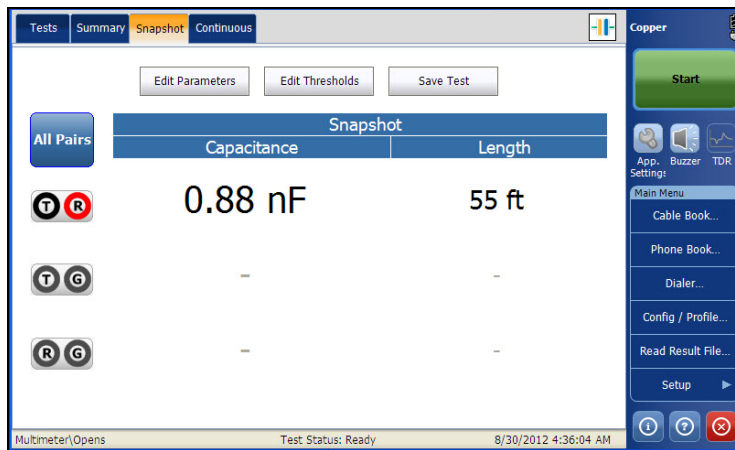

The current group and the current test which is being measured is displayed in the status bar, for example **Multimeter\Opens**.

The page displays the following parameters:

- **All Pairs** allow you to select **All Pairs** for measurement.

Note: *You can select individual wire pairs to view the result for that particular wire pair.*

- **Edit Threshold** button opens a new page that allows you to set the Capacitance/Opens thresholds for each pair.
- **Edit Parameters** button opens a new page that allows you to set the cable parameters for the selected pair.
- **Save Test** button opens a new page that allows you to save a snapshot of test results into a result file. Refer *Save Test* on page 74 for more information.
- **Test Status** displays the current state of measurement or an error message.

Multimeter Tests

Capacitance/Opens Test

Continuous

The **Continuous** function measures each pair, displaying and updating results in *real time*, until you stop the test. The last valid results then remain displayed.

To access Continuous page:

1. From the **Copper** main menu **Test Groups**, select **Multimeter** test.
2. From the **Tests** menu, select **Opens** test to start the test.
3. Tap **Continuous** tab to open the Continuous page.

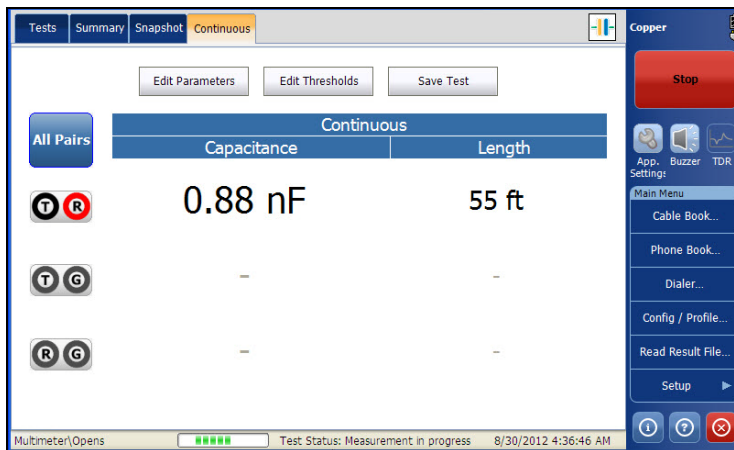

The current group and the current test which is being measured is displayed in the status bar, for example **Multimeter\Opens**.

The page displays the following parameters:

- **All Pairs** allow you to select **All Pairs** for measurement.

Note: *You can select individual wire pairs to view the result for that particular wire pair.*

- **Edit Threshold** button opens a new page that allows you to set the Capacitance/Opens resistance for each pair.
- **Edit Parameters** button opens a new page that allows you to set the cable parameters for the selected pair.
- **Save Test** button opens a new page that allows you to save a snapshot of test results into a result file. Refer *Save Test* on page 74 for more information.
- **Test Status** displays the current state of measurement or an error message.

Setting Threshold Values

The **Test Threshold** page allows you to set the **Threshold Capacitance/Opens** for each pair.

To set the Threshold values:

1. From the **Copper** main menu **Test Groups**, select **Multimeter** test.
2. From the **Tests** menu, select **Opens** test.
3. Tap **Snapshot** or **Continuous** tab to set the Threshold values.
4. Tap **Edit Thresholds** button to open the **Test Thresholds** page.
5. Set the Threshold values as required.
6. Tap **Close** to confirm and exit the page.

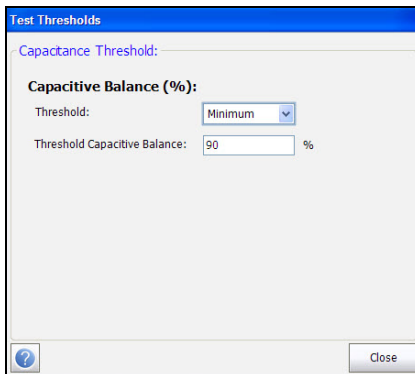

The page allows you to set the following parameters:

- **Threshold** is the threshold limit for each pair: **Maximum**, **Minimum**, or **None**.
- **Threshold Capacitive Balance** sets the threshold value.

Setting Test Parameters

The **Test Parameters** page allows you to set the **Multimeter Capacitance/Opens** test parameters.

To set the Parameter values:

1. From the **Copper** main menu **Test Groups**, select **Multimeter** test.
2. From the **Tests** menu, select **Opens** test.
3. Tap **Snapshot** or **Continuous** tab to set the Parameter values.
4. Tap **Edit Parameters** button to open the **Test Parameters** page.
5. Set the Parameter values as required.
6. Tap **Close** to confirm and exit the page.

Test Parameters

Selected Pair:

- T - R
- T - G
- R - G
- All Pairs

Cable Parameters:

Cable Type: Cable #4 - Aircore

Capacitance T-R: 83.0 nF/mi

Capacitance T/R to GND: 125.0 nF/mi

Close

Multimeter Tests

Capacitance/Opens Test

The page allows you to set the following parameters:

- **Selected Pair** allows you to select the pair for which the cable parameter is to be set.
- **Cable Type** allows you to select a cable entry (with its associated parameters) from the current Cable Book, to use for testing. The selection is not saved when leaving the test. The current Cable Book entry is shown by default.
- **Capacitance T-R** displays the capacitance value from Tip to Ring in nF/mi ranging from 10.0 to 500.0.
- **Capacitance T/R to GND** displays the capacitance value from Tip or Ring to Ground, in nF/mi ranging from 10.0 to 500.0.

Summary

Summary tab displays the pass/fail status of the tests executed. Refer *Copper Tests: Result Summary* on page 291 for more information.

Resistive Balance Test

The **Resistive Balance** test measures and compares the resistance of each conductor. This test requires you to short Tip and Ring (T-R) to ground at the far end (T-R-G short) before proceeding with the test.

Snapshot

The resistive balance **Snapshot** shows results for **Ring**, **Tip**, **Loop** resistance, and the pass/fail status for **Resistive Balance** in Ω and %.

To access Snapshot page:

1. From the **Copper** main menu **Test Groups**, select **Multimeter** test.
2. From the **Tests** menu, select **Resistive Balance** test to start the test.

By default, the **Snapshot** page opens.

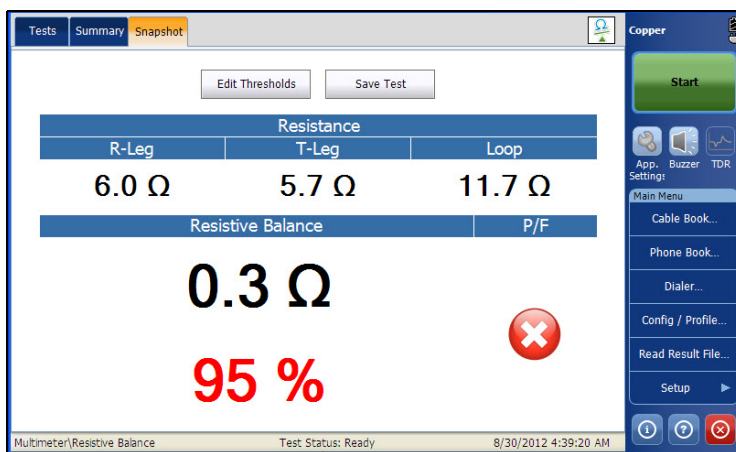

The current group and the current test which is being measured is displayed in the status bar, for example **Multimeter\Resistive Balance**.

Multimeter Tests

Resistive Balance Test

The page displays the following parameters:

- **Edit Threshold** button opens a new page that allows you to set the Resistive Balance thresholds for each pair.
- **Save Test** button opens a new page that allows you to save a snapshot of test results into a result file. Refer *Save Test* on page 74 for more information.
- **Test Status** displays the current state of measurement or an error message.

Setting Threshold Values

The **Test Thresholds** page allows you to set the **Resistive Balance Threshold** values for the test, in Ω and %.

To set the Threshold values:

1. From the **Copper** main menu **Test Groups**, select **Multimeter** test.
2. From the **Tests** menu, select **Resistive Balance** test.
3. Tap **Snapshot** tab to set the Threshold values.
4. Tap **Edit Thresholds** button to open the **Test Thresholds** page.
5. Set the Threshold values as required.
6. Tap **Close** to confirm and exit the page.

Test Thresholds

Resistive Balance Threshold:

Resistive Balance (Ω):

Threshold: None

Threshold Resistive Balance: 5.00 Ω

Resistive Balance (%):

Threshold: Minimum

Threshold Resistive Balance: 97 %

Close

The page allows you to set the following parameters:

- **Threshold** is the threshold limit for each pair: **Maximum**, **Minimum**, or **None**.
- **Threshold Resistive Balance** sets the threshold value.

Multimeter Tests

Resistive Balance Test

Summary

The **Resistive Balance** test is a reliable way to understand pair balance using resistance measurements and a far end strap. Compared to regular resistance tests, **Resistive Balance** isolates the resistance of each conductor (leg) which should ideally be the same within 5%; if not, and if there are no other metallic faults (for example, a ground/earth fault), then a highly resistive (HR) fault may be present. An HR can otherwise be very difficult to identify. Use **Pair Detective** or **TDR** or **RFL** to locate the HR.

Summary tab displays the pass/fail status of the tests executed. Refer *Copper Tests: Result Summary* on page 291 for more information.

Balance Test

The VF Longitudinal Balance test allows you to check that the pair balance is sufficient to mitigate common-mode noise. The test is a measurement of how much the T/A leg is like the R/B leg in electrical characteristics, measured by how much noise the line can mitigate (in dB). It is an overall health indicator and a quick way to tell if the line is in good condition. The better the longitudinal balance of the cable pair, the higher the dB reading.

Active

The **Active** function applies its own signal to take a balance measurement, displaying and updating results in *real time*, until you stop the test. The last valid results then remain displayed. The page also displays the pass/fail status and **Balance** value.

To access Active page:

1. From the **Copper** main menu **Test Groups**, select **Signal** test.
2. From the **Tests** menu, select **Balance** test to start the test.

By default, the **Active** page opens.



Multimeter Tests

Balance Test

The current group and the current test which is being measured is displayed in the status bar, for example **Signal\Balance**.

The page displays the following parameters:

- **Edit Thresholds** button opens a new page that allows you to set the **VF Balance** threshold.
- **Test Status** displays the current state of measurement or an error message.
- **Save Test** button opens a new page that allows you to save a snapshot of test results into a result file. Refer to *Save Test* on page 74 for more information.

Setting Threshold Values

The **Test Thresholds** page allows you to set the Balance Threshold values for the test.

To set the Threshold values:

- 1.** From the **Copper** main menu **Test Groups**, select **Signal** test.
- 2.** From the **Tests** menu, select **Signal** test.
- 3.** Tap **Active** tab for which you want to set the Threshold values.
- 4.** Tap **Edit Thresholds** button to open the **Test Thresholds** page.
- 5.** Set the Threshold values as required.
- 6.** Tap **Close** to confirm and exit the page.

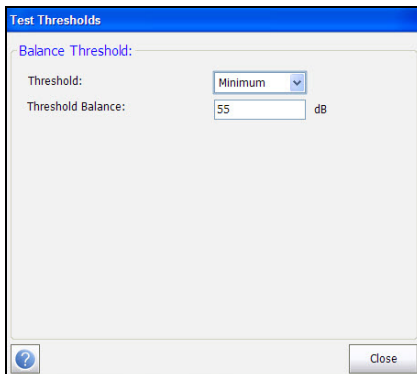

The screenshot shows a dialog box titled "Test Thresholds" with a blue header. Below the header, the text "Balance Threshold:" is displayed. Underneath, there are two input fields: "Threshold:" with a dropdown menu set to "Minimum", and "Threshold Balance:" with a text box containing "55" and the unit "dB" to its right. At the bottom left of the dialog is a help icon (a question mark in a circle), and at the bottom right is a "Close" button.

Note: Refer to your maintenance techniques or manager for guidance on setting thresholds.

The page allows you to set the following parameters:

- **Threshold** is the threshold limit for each pair: **Maximum**, **Minimum**, or **None**.
- **Threshold Balance** sets the balance threshold.

Multimeter Tests

Balance Test

Passive

The **Passive** function computes the passive balance as the difference between **Power Influence** and **VF Noise**, displaying and updating results in *real time*, until you stop the test. The last valid results then remain displayed. The page also displays the **Passive** pass/fail status, **Power Influence**, **VF Noise**, and **Balance** values.

To access *Passive* page:

1. From the **Copper** main menu **Test Groups**, select **Signal** test.
2. From the **Tests** menu, select **Balance** test to start the test.
3. Select the **Passive** tab.

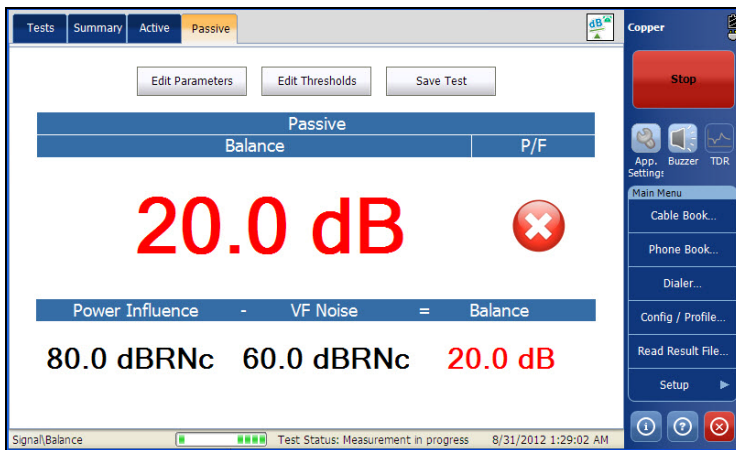

The current group and the current test which is being measured is displayed in the status bar, for example **Signal\Balance**.

The page displays the following parameters:

- **Edit Thresholds** button opens a new page that allows you to set the **Balance** threshold.
- **Edit Parameters** button opens a new page that allows you to set the test parameters.
- **Save Test** button opens a new page that allows you to save a snapshot of test results into a result file. Refer *Save Test* on page 74 for more information.

Setting Threshold Values

The **Test Thresholds** page allows you to set the **Balance Threshold** and **Power Influence Threshold** values for the test.

To set the Threshold values:

- 1.** From the **Copper** main menu **Test Groups**, select **Signal** test.
- 2.** From the **Tests** menu, select **Signal** test.
- 3.** Tap **Passive** tab for which you want to set the Parameter values.
- 4.** Tap **Edit Thresholds** button to open the **Test Thresholds** page.
- 5.** Set the Threshold values as required.
- 6.** Tap **Close** to confirm and exit the page.

Multimeter Tests

Balance Test

Test Thresholds

Balance Threshold:

Threshold: Minimum

Threshold Balance: 55 dB

Power Influence Threshold:

Threshold: Minimum

Threshold Power Influence: 60 dBRnc

Close

Note: Refer to your maintenance techniques or manager for guidance on setting thresholds.

The page allows you to set the following parameters:

- **Threshold** is the threshold limit for each pair: **Maximum**, **Minimum**, or **None**.
- **Threshold Balance** sets the passive balance threshold.

Setting Test Parameters

The **Test Parameters** page allows you to view the parameter values for the test.

To view the Parameter values:

1. From the **Copper** main menu **Test Groups**, select **Signal** test.
2. From the **Tests** menu, select **Balance** test.
3. Tap **Passive** tab for which you want to set the Parameter values.
4. Tap **Edit Parameter** button to open the **Test Parameter** page.
5. Tap **Close** to confirm and exit the page.

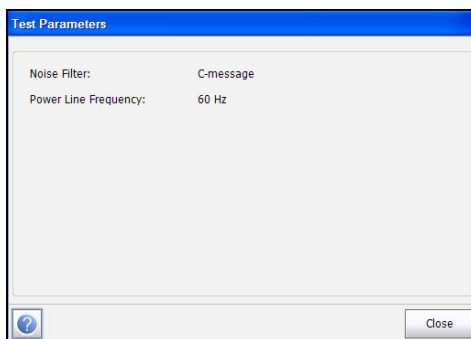

The page displays the following parameters:

- **Power Line Frequency** displays the frequency value of the power line.
- **Noise Filter** displays the type of noise filter used.

Multimeter Tests

Balance Test

Summary

Balance is the best single indicator of pair condition, by assessing how much noise the pair is cancelling or mitigating. Many cables are constructed to mitigate 60dB of noise, which the test displays directly. The Passive test measures Power Influence, VF Noise and calculates the difference; but this method depends on the presence of at least 60dB of Power Influence. The active test applies it's own signal or noise and can be used anytime or when there is not enough Power Influence present for the Passive test.

Summary tab displays the pass/fail status of the tests executed. Refer *Copper Tests: Result Summary* on page 291 for more information.

11 Multimeter 2 Tests

The **Multimeter 2** icon contains the **Isolation**, **Locator Tone**, and **Load Coils** tests.

To access Multimeter 2 tests:

From the **Copper** main menu **Test Groups**, tap **Multimeter 2**.

Multimeter 2 Main Page

The **Multimeter 2** menu allows you to select and run the displayed tests:

- **Isolation**
- **Locator Tone**
- **Load Coils**
- **Station Ground**

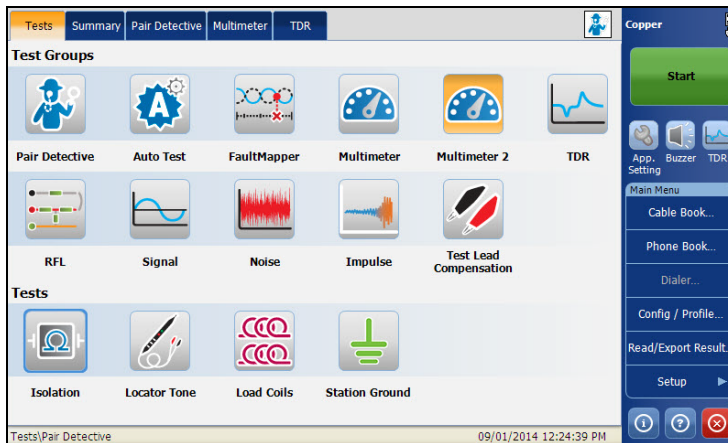

To start/stop a test:

1. From the **Copper** main menu **Test Groups**, select **Multimeter 2** test.
2. From the **Tests** menu, select the test to run.

Isolation Test

The **Isolation** test allows you to run a resistance test with high voltage over a period of time to test wire pair insulation. The test, also referred to as a *leakage* test, can reveal highly resistive faults.

Snapshot

The isolation **Snapshot** shows measured isolation resistance values for each lead combination. The page also displays a snapshot of the pass/fail status, **Resistance** and a **Soak Counter** for each selected wire pair. When running the test, the counter counts to the selected **Soak Timer** by the second, for the wire pair(s) under test.

To access Snapshot page:

1. From the **Copper** main menu **Test Groups**, select **Multimeter 2** test.
2. From the **Tests** menu, select **Isolation** test to start the test.

By default, the **Snapshot** page opens.

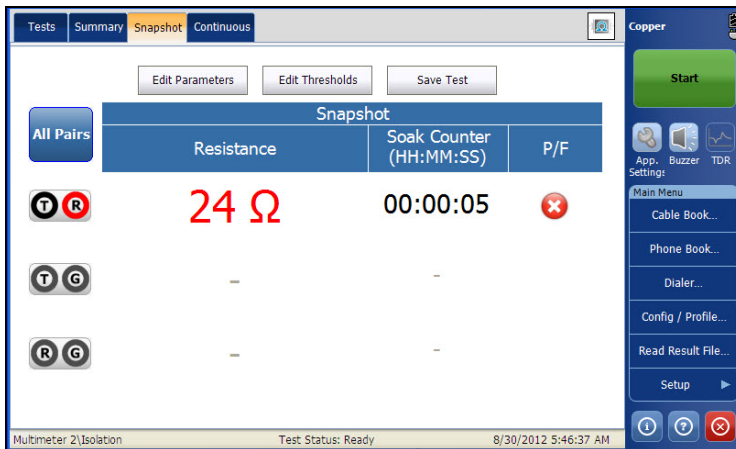

The current group and the current test which is being measured is displayed in the status bar, for example **Multimeter 2\Isolation**.

The page displays the following parameters:

- **All Pairs** allow you to select **All Pairs** for measurement.

Note: *You can select individual wire pairs to view the result for that particular wire pair.*

- **Edit Threshold** button opens a new page that allows you to set the isolation thresholds for each pair.
- **Edit Parameters** button opens a new page that allows you to set the isolation parameters for the selected pair.
- **Save Test** button opens a new page that allows you to save a snapshot of test results into a result file. Refer *Save Test* on page 74 for more information.
- **Test Status** displays the current state of measurement or an error message.

Multimeter 2 Tests

Isolation Test

Continuous

The **Continuous** function measures each pair, displaying and updating results in *real time*, until you stop the test. The last valid results then remain displayed.

To access Continuous page:

1. From the **Copper** main menu **Test Groups**, select **Multimeter 2** test.
2. From the **Tests** menu, select **Isolation** test to start the test.
3. Tap **Continuous** tab to open the Continuous page.

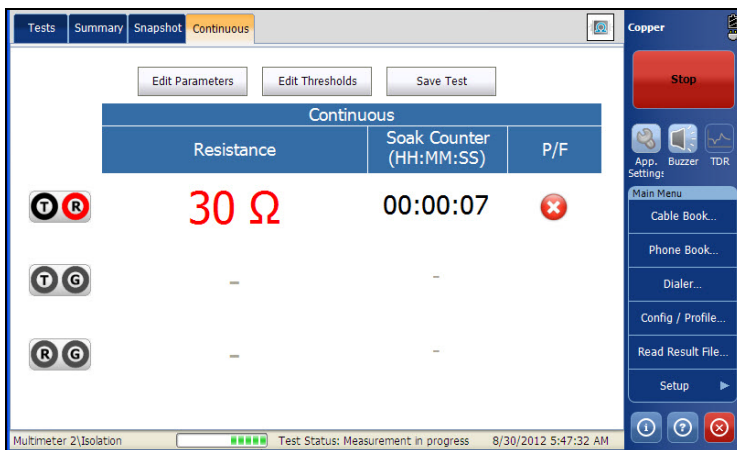

The current group and the current test which is being measured is displayed in the status bar, for example **Multimeter 2\Isolation**.

The page displays the following parameters:

- **Edit Threshold** button opens a new page that allows you to set the isolation thresholds for each pair.
- **Edit Parameters** button opens a new page that allows you to set the isolation parameters for the selected pair.

- **Save Test** button opens a new page that allows you to save a snapshot of test results into a result file. Refer *Save Test* on page 74 for more information.
- **Test Status** displays the current state of measurement or an error message.

Setting Threshold Values

The **Test Thresholds** page allows you to set the **Resistance Threshold** for each pair.

To set the Threshold values:

1. From the **Copper** main menu **Test Groups**, select **Multimeter 2** test.
2. From the **Tests** menu, select **Isolation** test to start the test.
3. Tap **Snapshot** or **Continuous** tab for which you want to set the Threshold values.
4. Tap **Edit Thresholds** button to open the **Test Thresholds** page.
5. Set the Threshold values as required.
6. Tap **Close** to confirm and exit the page.

Test Thresholds

Resistance Threshold:

T - R:
Threshold: Minimum
Threshold Resistance: 500.00 MΩ

T - G:
Threshold: Minimum
Threshold Resistance: 500.00 MΩ

R - G:
Threshold: Minimum
Threshold Resistance: 500.00 MΩ

Close

Multimeter 2 Tests

Isolation Test

The page allows you to set the following parameters:

- **Threshold** is the threshold limit for each pair: **Maximum**, **Minimum**, or **None**.
- **Threshold Resistance** sets the threshold value.

Setting Test Parameters

The **Test Parameters** page allows you to set the **Multimeter 2 Isolation** test parameters.

To set the Parameter values:

1. From the **Copper** main menu **Test Groups**, select **Multimeter 2** test.
2. From the **Tests** menu, select **Isolation** test.
3. Tap **Snapshot** or **Continuous** tab for which you want to set the Parameter values.
4. Tap **Edit Parameters** button to open the **Test Parameters** page.
5. Set the Parameter values as required.
6. Tap **Close** to confirm and exit the page.

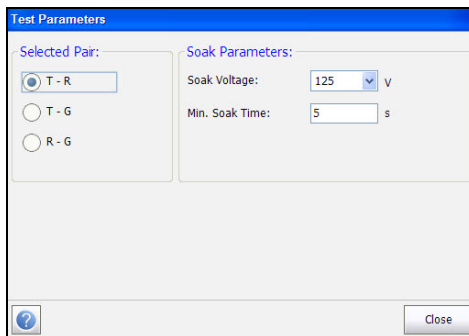

The page allows you to set the following parameters:

- **Selected Pair** allows you to select the pair for which the Soak Parameters is to be set.
- **Soak Voltage** allows you to apply a voltage value to the pair(s) currently under test. The standard voltage level is 125, but the HIVOLT option allows up to 500 V.
- **Min. Soak Time** sets a soak period of time from 1 Second to 59 Minutes and 59 Seconds.

Summary

The Isolation resistance tests, also called leakage tests, are very useful and apply voltage over a period of time, in order to measure resistance on longer loops, or to assess the quality of conductor insulation; a significant reduction in measured resistance over time can indicate breakdown of the conductor insulation. However, the application of voltage over time removes minor corrosion and the resistance measurement may appear to increase/improve, but the cause of the corrosion remains and the fault is likely return. For this reason, the isolation tests should not be used before other tests, or used only when necessary.

Summary tab displays the pass/fail status of the tests executed. Refer *Copper Tests: Result Summary* on page 291 for more information.

Multimeter 2 Tests

Locator Tone Test

Locator Tone Test

When **Locator Tone** is selected from the **Signal Tests** menu, an alternating 577 Hz signal and a 983 Hz signal are sent separately for 200 ms each. The sequence of this tone is repeated continuously until you stop the test. Sinusoidal waveform is used to generate these signals.

Tone

The **Tone** function allows you to set the **Tone Power** and generate a pulsed tone on the line to trace a cable pair at the far end. The page also displays the **Elapsed Time** the locator tone is being sent.

To access Tone page:

1. From the **Copper** main menu **Test Groups**, select **Signal** test.
2. From the **Tests** menu, select **Locator Tone** test to start the test.

By default, the **Tone** page opens.

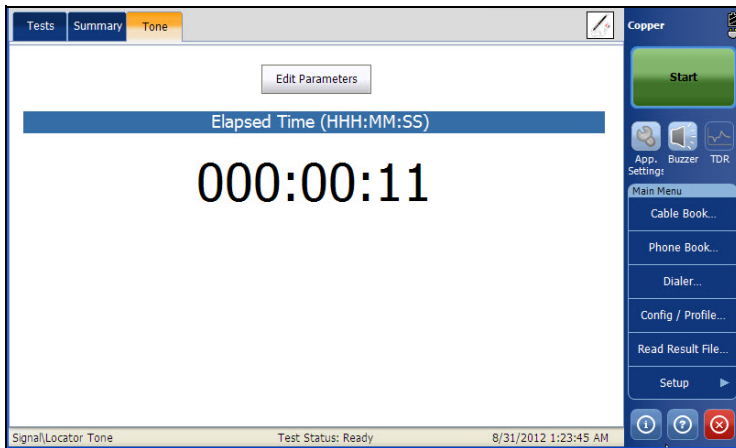

The page displays the following parameters:

- **Edit Parameters** button opens a new page that allows you to set the test parameters.
- **Test Status** displays the current state of measurement or an error message.

Setting Test Parameters

The **Test Parameters** page allows you to set the **Signal Locator Tone** test parameters.

To set the Parameter values:

1. From the **Copper** main menu **Test Groups**, select **Signal** test.
2. From the **Tests** menu, select **Locator Tone** test.
3. Tap **Tone** tab for which you want to set the Parameter values.
4. Tap **Edit Parameters** button to open the **Test Parameters** page.
5. Set the parameter values as required.
6. Tap **Close** to confirm and exit the page.

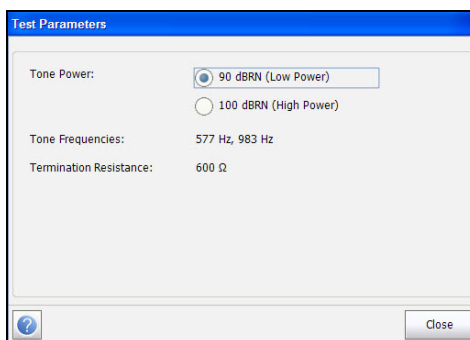

Multimeter 2 Tests

Locator Tone Test

The page allows you to set the following parameters:

- **Tone Power** allows you to select either low or high power for the **Locator Tone**.
- **Tone Frequencies** displays the frequencies of the **Locator Tone**.
- **Termination Resistance** is a read-only value of **600 Ω** .

Summary

The locator tone transmits an alternating signal at 0 dBm or +10 dBm to locate specific pairs with a tone probe.

Summary tab displays the pass/fail status of the tests executed. Refer *Copper Tests: Result Summary* on page 291 for more information.

Load Coils Test

The **Load Coils** test allows you to detect the presence of load coils, which are detrimental to the use of DSL technologies on the line. If a load coil is detected, use the time domain reflectometry (TDR) test to quickly locate and remove it from the cable.

Load Coils

The load coils function detects the presence of load coils in the cable section, counts them, and displays frequency response in graphical form. The page also displays the number of load coils in text and graphical format.

To access Load Coils page:

1. From the **Copper** main menu **Test Groups**, select **Signal** test.
2. From the **Tests** menu, select **Load Coils** test to start the test.

By default, **Load Coils** page opens.

3. Use the graph controls to maneuver the graph. Refer to *Graph Controls* on page 19 for more information.

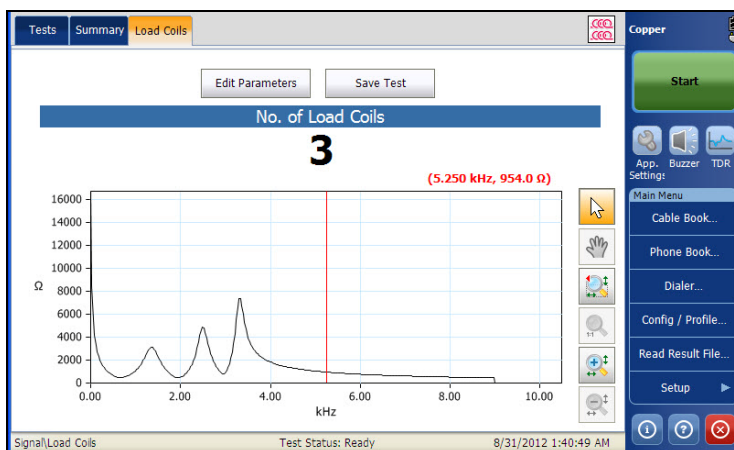

Multimeter 2 Tests

Load Coils Test

The current group and the current test which is being measured is displayed in the status bar, for example **Signal/Load Coils**.

The page displays the following parameters:

- **Edit Parameters** button opens a new page that allows you to set the test parameters.
- **Save Test** button opens a new page that allows you to save a snapshot of test results into a result file. Refer *Save Test* on page 74 for more information.

Setting Test Parameters

The **Test Parameters** page allows you to set the parameter values for the test.

To set the Parameter values:

1. From the **Copper** main menu **Test Groups**, select **Signal** test.
2. From the **Tests** menu, select **Load Coils** test.
3. Tap **Load Coils** tab to set the Parameter values.
4. Tap **Edit Parameter** button to open the **Test Parameter** page.
5. Set the Parameter values as required.
6. Tap **Close** to confirm and exit the page.

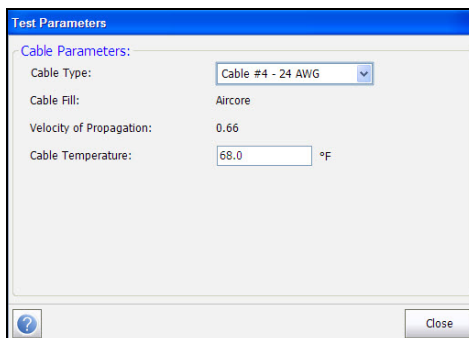

The screenshot shows a dialog box titled "Test Parameters" with a blue header. Below the header, the text "Cable Parameters:" is followed by four rows of settings:

- Cable Type: Cable #4 - 24 AWG (dropdown menu)
- Cable Fill: Aircore
- Velocity of Propagation: 0.66
- Cable Temperature: 68.0 °F (text input field)

At the bottom left of the dialog is a help icon (question mark in a circle), and at the bottom right is a "Close" button.

The page displays the following parameters:

- **Cable Type** allows you to select a cable entry (with its associated parameters) from the current **Cable Book**, to use for testing. The selection is not saved when leaving the test. The current Cable Book entry is shown by default.
- **Cable Fill Material** read-only entry is the type of material the cable is filled with: **Aircore, Jelly, Pulp, 5 PR, or 2 PR**. Setup in the **Cable Book**.
- **Velocity of Propagation** read-only entry is the velocity of propagation for the cable as a ratio of the speed of light. Setup in the **Cable Book**.
- **Cable Temperature** allows you to change the temperature of the cable under test in either degree **C** or **F**.

Summary

Load coils generally stop or severely impact DSL service and should be removed. Some specialized load coils pass some ADSL signals. The load coil detector quickly counts the load on the pair. In some cases the DSL splitter may be counted as a load coil. A TDR is the easiest way to locate a load coil, although only the closest appears, as it blocks the TDR signal beyond it. The load coil test is quick and easy, use it at the start of testing to clear any unwanted coils.

Summary tab displays the pass/fail status of the tests executed. Refer *Copper Tests: Result Summary* on page 291 for more information.

Multimeter 2 Tests

Station Ground

Station Ground

The **Station Ground** test measures the resistance of the ground path from the CPE (Customer Premises Equipment) to the CO (Central Office). The test uses Tip (A), Ring (B), and Ground (Earth) leads and measures isolation resistance between the wires and to ground. Station Ground is also used to identify possible faults, and to measure the resistance of the twisted pair cable.

To access the Station Ground window:

1. From the **Copper** main menu **Test Groups**, select **Multimeter 2** test.
2. From the **Tests** menu, select **Station Ground** to start the test.

By default, the **Confirmation** page opens displaying how to connect your leads. See *Hookup Diagram* on page 184 for more information.

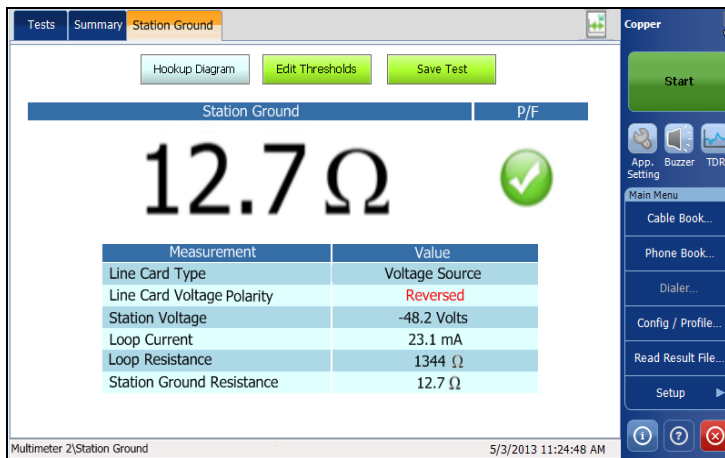

The screenshot shows the 'Station Ground' test interface. At the top, there are tabs for 'Tests', 'Summary', and 'Station Ground'. Below the tabs are buttons for 'Hookup Diagram', 'Edit Thresholds', and 'Save Test'. The main display area shows 'Station Ground' and 'P/F' in a blue bar, followed by a large digital readout of '12.7 Ω' and a green checkmark icon. Below the readout is a table with the following data:

Measurement	Value
Line Card Type	Voltage Source
Line Card Voltage Polarity	Reversed
Station Voltage	-48.2 Volts
Loop Current	23.1 mA
Loop Resistance	1344 Ω
Station Ground Resistance	12.7 Ω

At the bottom of the interface, there is a status bar with 'Multimeter 2|Station Ground' on the left and '5/3/2013 11:24:48 AM' on the right. On the far right, there is a vertical sidebar with a 'Copper' header, a 'Start' button, and a 'Main Menu' section containing options like 'Cable Book...', 'Phone Book...', 'Dialer...', 'Config / Profile...', 'Read Result File...', and 'Setup'.

The page displays the **Station Ground** pass/fail results and the following measurement values:

- **Line Card Type** displays one of the following messages:
 - **Card Not Detected**
 - **Voltage Source**
 - **Current Source**
- **Line Card Voltage Polarity** displays either **Ok** or **Reversed**.
- **Station Voltage** is the maximum/minimum AC/DC threshold voltage value for the circuit.
- **Loop Current** is the minimum loop current for the circuit in **mA**.
- **Loop Resistance** displays the resistance value of the twisted cable pair.
- **Station Ground Resistance** from 0.0 to 25.0 ohms is considered a pass.

If an error message is displayed in lieu of the resistance measurement, one of the following conditions could exist:

- Loop resistance > 10 k Ohms
- Tip (A) not connected to Ground (Earth) at CO
- Improper hookup (check your lead connections)
- Incorrect/no line card
- Improper line voltage, polarity, or current
- Resistance measurement error (out of range for normal resistance measurement, etc.).

Multimeter 2 Tests

Station Ground

Hookup Diagram

The **Station Ground** feature displays a **Hookup Diagram** in a popup window at the beginning of the test, showing you how to connect. The hookup diagram uses the following graphic and textual components:

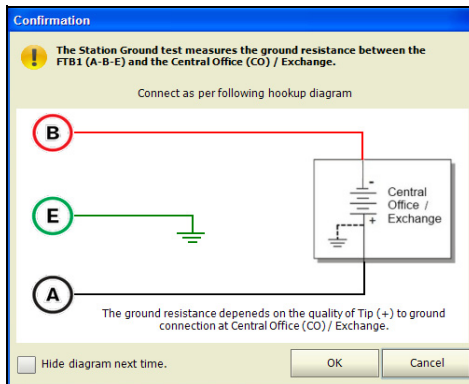

Note: *The **Station Ground** test only works with central offices where the tip (A) is connected to ground (earth).*

- **OK** button closes the hookup diagram prompt and starts the test.
- **Cancel** button closes the hookup diagram prompt only; you must tap **Start** to run the test.
- The **Confirmation** window is prompted before every **Station Ground** test is started. You can select **Hide diagram next time** which will not display the connection diagram the next time you run the test.

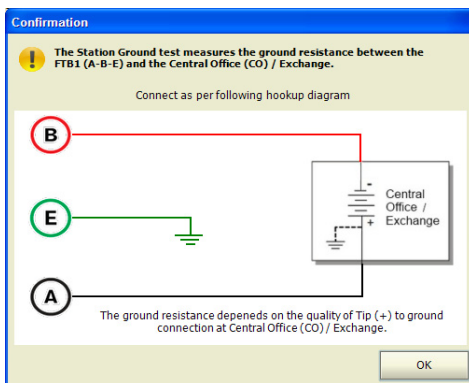

However, you can check the connection diagram at any time by tapping **Hookup Diagram** in the main **Station Ground** window. In this case, the test will not automatically start when you tap the **OK** button to close the **Confirmation** window.

Setting Threshold Values

The **Test Thresholds** page allows you to configure resistance thresholds for the **Station Ground** test.

To set the threshold values:

1. From the **Copper** main menu **Test Groups**, select **Multimeter 2** test.
2. From the **Tests** menu, select **Station Ground** to start the test.
3. Tap **Edit Thresholds** button to open the **Test Thresholds** page.
4. Set the threshold values as required.
5. Tap **Close** to confirm and exit the page.

Multimeter 2 Tests

Station Ground

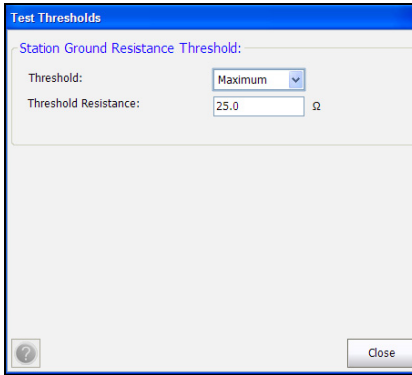

The screenshot shows a dialog box titled "Test Thresholds" with a blue header. Below the header, the text "Station Ground Resistance Threshold:" is displayed. There are two input fields: "Threshold:" with a dropdown menu set to "Maximum", and "Threshold Resistance:" with a text box containing "25.0" and a unit symbol "Ω". At the bottom left is a help icon (question mark in a circle), and at the bottom right is a "Close" button.

The page allows you to set the following parameters:

- **Threshold** is the threshold limit for the cable: **Maximum**, **Minimum**, or **None**.
- **Threshold Resistance** sets the threshold ground resistance value. **Station Ground** resistance from 0.0 to 25.0 ohms is considered a pass.

Summary

Summary tab displays the pass/fail status of the tests executed. Refer to *Copper Tests: Result Summary* on page 291 for more information.

12 TDR Test

The **TDR** test is a useful tool on the large FTB screen to locate cable faults. The test is used after a fault has been identified running other tests, since TDR reacts to all faults and conditions on a typical cable pair, revealing multiple events, some of which may be acceptable conditions. TDR first attempts to find the length of the circuit and then searches all ranges from shortest to longest for significant events. Upon completion, the test selects the nearest major event, sets the range to match, and aligns the cursor with the event. TDR can see events as close as the ends of the test leads. The graph controls allow you to see the reflections and their distances so that you can find and resolve faults.

There are 3 modes of operation to choose from:

- **Auto TDR**
- **Manual TDR**
- **Xtalk TDR**

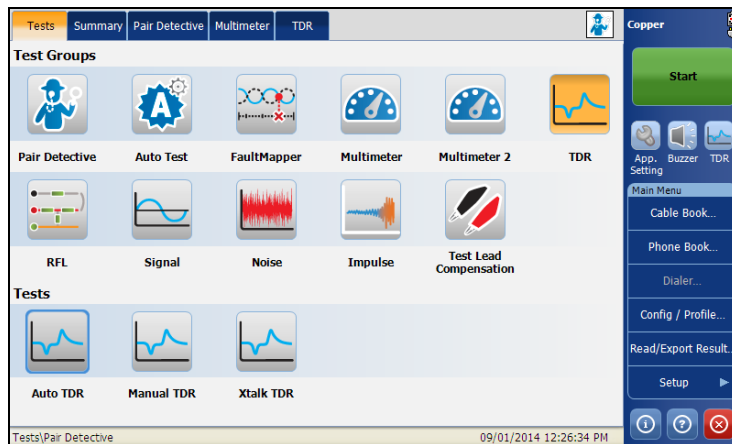

Auto TDR

The **Auto TDR** automatically determines the length of the cable, finds the nearest significant event, and configures the parameters. Range and Gain are updated to reflect the optimized TDR settings but can be edited using the **Edit Parameters** button. **Auto TDR** displays the distance to the most **Significant Event** and updates results in *real time*, until you stop the test. The last valid results then remain displayed.

To access Auto TDR Test:

1. From the **Copper** main menu **Test Groups**, tap **TDR** test.
2. From the **Tests** menu, tap **Auto TDR** to start the test.
3. Use the graph controls to maneuver the graph. Refer to *Graph Controls* on page 19 for more information.

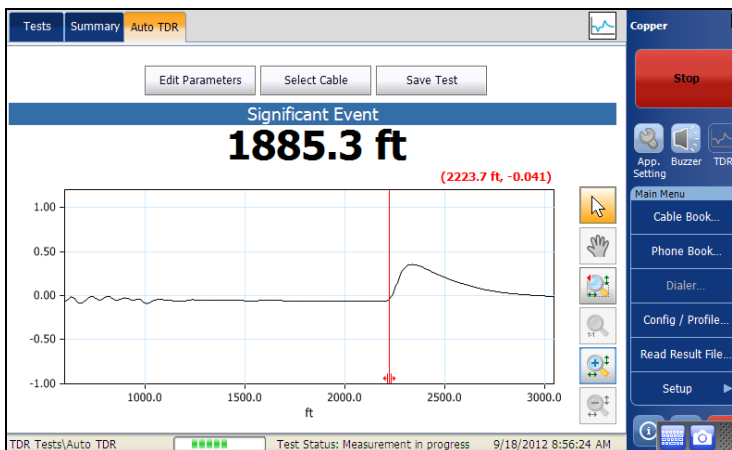

The page allows you to select the following parameters:

- **Edit Parameters** button opens a new page that allows you to select the test values.
- **Select Cable** button opens a new page that allows you to set cable parameters for the current test.
- **Save Test** button opens a new page that allows you to save a snapshot of test results into a result file. Refer to *Save Test* on page 74 for more information.

Edit Parameters

The **Test Parameters** page allows you to select the **Range** and **Gain** values from given lists, for the **Auto TDR** test. The **Pulse Width** parameter is a non-editable value that is automatically updated.

To edit the test parameters:

1. From the **Auto TDR** page, select **Edit Parameters** to open the page.
2. In the **Test Parameters** page, edit the test values as required.
3. Tap **Close** to confirm and close the page.

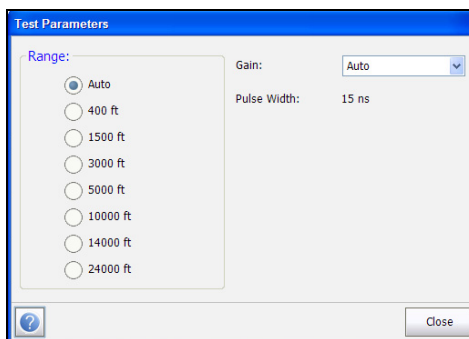

Select Cable

The **Cable Selection** page allows you to set cable parameters for the **Auto TDR** test.

To select cable values:

1. From the **Auto TDR** page, click the **Select Cable** button to open the page.
2. In the **Cable Selection** page, edit the cable parameters as required.
3. Tap **Close** to confirm and close the page.

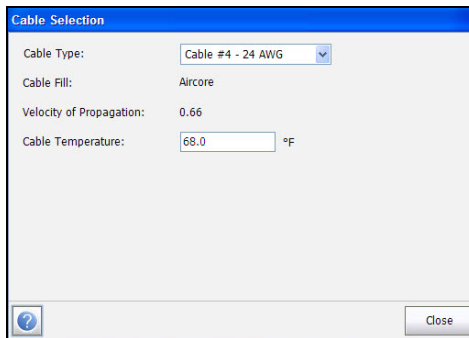

The page allows you to set or view the following parameters:

- **Cable Type** allows you to select a cable entry (with its associated parameters) from the current **Cable Book**, to use for testing. The selection is not saved when leaving the test. The current Cable Book entry is shown by default.
- **Cable Fill** read-only entry displays the type of material the cable is filled with: **Aircore**, **Jelly**, **Pulp**, **5 PR**, or **2 PR**. Setup in the **Cable Book**.
- **Velocity of Propagation** read-only entry is the velocity of propagation for the cable as a ratio of the speed of light. Setup in the **Cable Book**.
- **Cable Temperature** allows you to change the temperature of the cable under test in either degree **C** or **F**.

Manual TDR

Manual TDR does not automate any function nor settings and gives you full control over TDR parameters such as range and gain. The test allows you to set the parameters to be used as inputs for the TDR measurements. It can display up to 3 traces, 1 live and 2 saved (1 minimum), in graphical format, updating results in *real time*, until you stop the test. The last valid results then remain displayed.

To access Manual TDR Test:

1. From the **Copper** main menu **Test Groups**, tap **TDR** test.
2. From the **Tests** menu, tap **Manual TDR** to start the test.
3. Use the graph controls to maneuver the graph. Refer to *Graph Controls* on page 19 for more information, except for hold trace , see below.

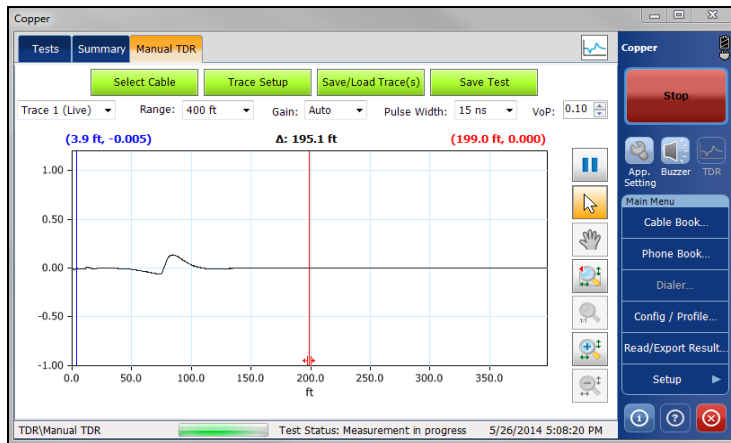

The page allows you to view and set the following parameters:

- **Select Cable** button opens a new page that allows you to set the **Cable Parameters** for the current test.
- **Trace Setup** button opens a new page used for trace settings.
- **Save/Load Trace(s)** button is used for loading and saving traces.

- **Save Test** button opens a new page that allows you to save a snapshot of test results into a result file. Refer *Save Test* on page 74 for more information.
- **Trace** allows you to select corresponding configurations showing the following Trace control values:
 - Trace 1 (Live)
 - Trace 2
 - Trace 3
- Drop-down lists of the following TDR values allow you to change their respective parameters for live Trace 1. Modification of the on-screen parameters will be applied to the live trace for the next cycle of measurement. When Trace 2/3 is selected, these parameters are disabled and the list-values are shown as read only.
 - **Range**
 - **Gain**
 - **Pulse Width**
 - **VoP** allows you to change the velocity of propagation value for the cable using the virtual keyboard. Or to change the value by 0.01, use the on-screen up/down arrows or up/down arrow keys of the keypad.

Note: *Changes to the VoP only apply during the test, for both factory and user cables. Upon exiting the test, the original cable VoP value set in the **Cable Book** remains unchanged.*

- Hold trace  graph control icon holds the current TDR on screen for comparison to a new live trace. The held trace is not saved. Select **Save Trace** to store a trace in memory for later recall. The icon is only enabled when at least one trace is configured as **Hold** in *Trace Setup* on page 194.

Select Cable

This **Cable Selection** page allows you to set cable parameters, including the **Velocity of Propagation**, for both the **Manual TDR** and **Xtalk TDR** tests.

To select cable values:

1. From either the **Manual TDR** or **Xtalk TDR** page, click the **Select Cable** button to open the page.
2. In the **Cable Selection** page, edit the cable parameters as required.
3. Tap **Close** to confirm and close the page.

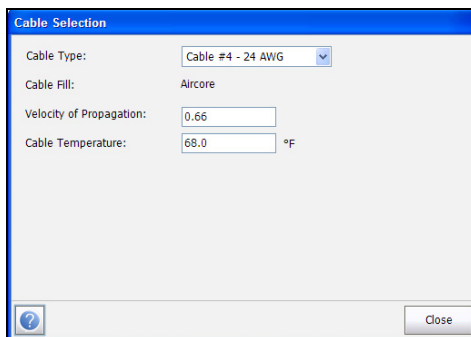

The page allows you to set or view the following parameters:

- **Cable Type** allows you to select a cable entry (with its associated parameters) from the current **Cable Book**, to use for testing. The selection is not saved when leaving the test. The current Cable Book entry is shown by default.
- **Cable Fill** read-only entry displays the type of material the cable is filled with: **Aircore**, **Jelly**, **Pulp**, **5 PR**, or **2 PR**. Setup in the **Cable Book**.
- **Velocity of Propagation** allows you to set the velocity of propagation for the cable as a ratio of the speed of light.
- **Cable Temperature** allows you to change the temperature of the cable under test in either degree **C** or **F**.

Trace Setup

The **Trace Setup** button opens a page that allows you to configure the trace parameters. Trace 2 and Trace 3 can be individually enabled/disabled. Trace 1 is a *live* TDR trace, and is always enabled.

Note: *If two traces are shown, they can either be Trace 1 and Trace 2 or Trace 1 and Trace 3, not Trace 2 and Trace 3 since Trace 1 is always enabled.*

To setup the trace parameters:

1. From the **Manual TDR** page, select **Trace Setup** to open the page.
2. In the **Trace Setup** page, select the parameters as required.
3. Tap **Close** to confirm and close the page.

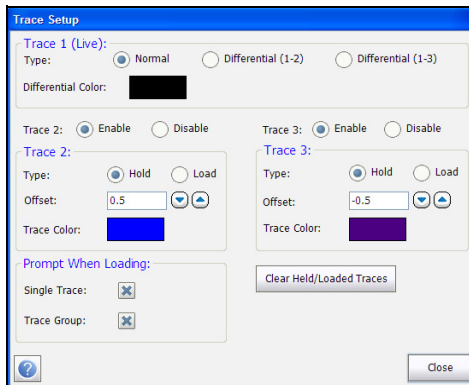

- **Trace 1 (Live) Type** can be configured as follows:
 - **Normal** displays a regular live TDR trace.
 - **Differential (1-2)** is the subtraction of **Trace 2** from the normal TDR signal. The differential trace is a live trace.
 - **Differential (1-3)** is the subtraction of **Trace 3** from the normal TDR signal. The differential trace is a live trace.

Note: In order to configure **Trace 1** as **Differential**, at least two traces must be enabled.

Note: If **Trace 1** is configured as **Differential** and no trace is held or loaded, then **Trace 1** will display the normal TDR trace.

- **Differential Color** option opens a color panel which allows you to differentiate between **Trace 2**, **Trace 3** and **Trace 1**. If **Type** is **Normal** for **Trace 1**, its color is black and the color option is disabled.
- **Trace 2/3:** When enabled the following parameters can be set:
 - **Type** allows you to configure each trace as the following:
 - Hold** - using this trace to display static snapshots of the live normal TDR (regardless of whether **Trace 1** is configured as **Normal** or **Differential**) or
 - Load** - displaying traces loaded from a file.
 - **Offset:** Each trace has a configurable offset, ranging from -1.00 to 1.00. The offset for **Trace 1 (Live)** is fixed at 0.00. If three traces are enabled, all with **Offset: 0.0**, then all three traces will overlap.
 - **Trace Color** option opens a color panel which allows you to differentiate between all 3 traces.
- **Prompt When Loading** allows you to change TDR parameters to that of the loaded file, either a **Single Trace** or **Trace Group** (multiple traces) when enabled.
- **Clear Held/Loaded Traces** button clears the parameters set for all held or loaded traces.

Save/Load Trace(s)

The **Save/Load Trace(s)** button opens a page which allows you to configure parameters to load and save a single trace or **Trace Group**.

To set the parameters:

1. From the **Manual TDR** page, select **Save/Load Trace(s)** to open the page.
2. In the **Save** tab, select the parameters as required.
3. Click **Save** button to confirm and/or **Close** button to exit the page.
4. In the **Load** tab, select the parameters as required.
5. Click **Close** to confirm and close the page.

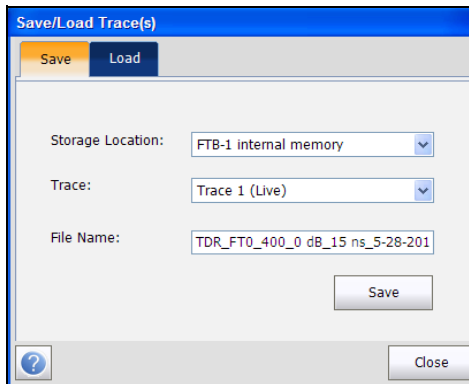

➤ **Save** tab

- **Storage Location** allows you to select where to save your results: to a USB or the internal memory.
- **Trace** lists the single TDR trace or **Trace Group** to save.
- **File Name** displays the automatically configured file name or you can enter a new one.
- **Save** button confirms your selections.

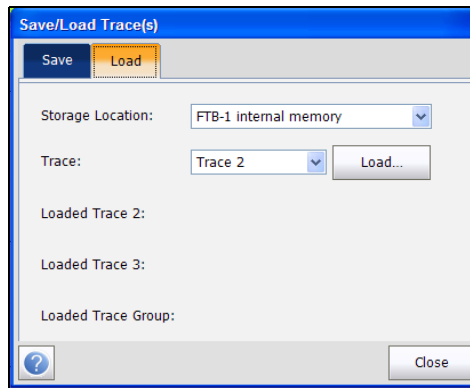

- **Load tab**
 - **Storage Location** lists the load destinations:
 - FTB-1 Internal Memory**
Name of the USB Device (if attached)
 - **Trace** lists the individual trace or **Trace Group** to load.
 - **Load** button loads the selected **Trace** from the **Trace Result File**.
 - **Loaded Trace 2/3/Group** displays the file name(s) of the loaded trace(s).

Trace Result File

The **Trace Result File** lists the names of the saved trace result files and their **Modification Date** stored in the location selected in the **Save/Load Trace(s)** window.

- From the **Trace Result File** window, you can **Select** a file to load, **Delete** a file, or **Delete All** files.
- **Cancel** exits the list and returns to the **Save/Load Trace(s)** window.

To access the list of trace result files:

1. From the **Save/Load Trace(s)** window, tap the **Load** tab to open its window.
2. Tap the **Load** button to open the **Trace Result File** window.

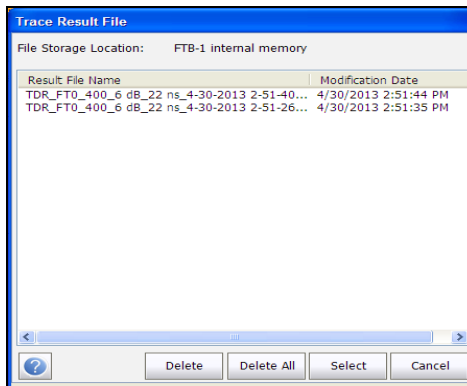

Xtalk TDR

The Xtalk TDR test allows you to detect and isolate split pairs or electrical dissimilarities between tip (A) and ring (B) copper wires which may be causing service disruptions. The test transmits on pair one and receives on pair two to locate the split pairs.

To access Xtalk TDR Test:

1. From the **Copper** main menu **Test Groups**, tap **TDR** test.
2. From the **Tests** menu, tap **Xtalk TDR** to start the test.
3. Use the graph controls to maneuver the graph. Refer to *Graph Controls* on page 19 for more information, except for hold trace , see below.



The page allows you to view and set the following parameters:

- **Hookup Diagram** button opens a **Confirmation** window displaying how to connect your cables.
- **Select Cable** button opens a new page that allows you to set the **Cable Parameters** for the current test. See *Select Cable* on page 193 for more information.

- **Trace Setup** button opens a new page used for trace settings. See *Trace Setup* on page 194 for more information.
- **Save/Load Trace(s)** button is used for loading and saving traces. See *Save/Load Trace(s)* on page 196 for more information.
- **Save Test** button opens a new page that allows you to save a snapshot of test results into a result file. Refer *Save Test* on page 74 for more information.
- **Trace** allows you to select corresponding configurations showing the following Trace control values:
 - Values: Trace 1 (Live)
 - Trace 2 (Static)
 - Trace 3 (Static)
- Drop-down lists of the following TDR values allow you to change their respective parameters for live Trace 1. Modification of the on-screen parameters will be applied to the live trace for the next cycle of measurement. When Trace 2/3 is selected, these parameters are disabled and the list-values are shown as read only.
 - **Range**
 - **Gain**
 - **Pulse Width**
 - **VoP** allows you to change the velocity of propagation value for the cable using the virtual keyboard. Or to change the value by 0.01, use the on-screen up/down arrows or up/down arrow keys of the keypad.

Note: *Changes to the VoP only apply during the test, for both factory and user cables. Upon exiting the test, the original cable VoP value set in the **Cable Book** remains unchanged.*

- Hold trace  graph control icon holds the current TDR on screen for comparison to a new live trace. The held trace is not saved. Select **Save Trace** to store a trace in memory for later recall. The icon is only enabled when at least one trace is configured as **Hold** in *Trace Setup* on page 194.

Hookup Diagram

The **Xtalk TDR** feature displays a hookup diagram in a popup window at the beginning of the test, showing you how to connect 2 pairs. The hookup diagram uses the following graphic and textual components:

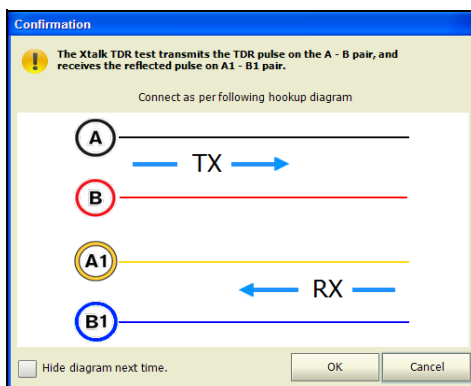

- **OK** button closes the hookup diagram prompt and starts the test.
- **Cancel** button closes the hookup diagram prompt only; you must tap **Start** to run the test.
- The **Confirmation** window is prompted before every **Xtalk TDR** test is started. You can select **Hide diagram next time** which will not display the connection diagram the next time you run the test.

TDR Test

Summary

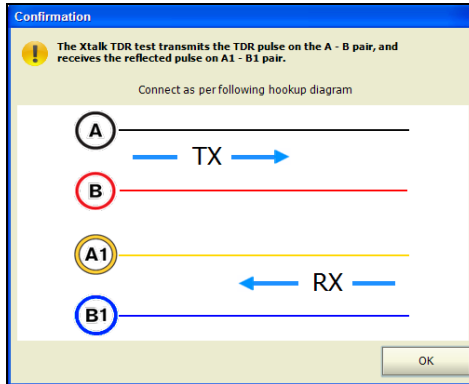

However, you can check the connection diagram at any time by tapping **Hookup Diagram** in the main **Xtalk TDR** window. In this case, the test will not automatically start when you tap the **OK** button to close the **Confirmation** window.

Summary

The **Summary** tab displays the pass/fail status and identifying information of the tests executed. Refer to *Copper Tests: Result Summary* on page 291 for more information.

13 RFL Test

RFL (resistive fault locate) testing is the most accurate way to locate cable faults such as shorts, grounds, and battery crosses. Before performing RFL tests, install the strap(s) at the other end of the cable. Graphical hook up diagrams and results speed interpretation and provide adjustable parameters of the tests and cables under test for more accuracy. RFL uses a series of resistance measurements across the faulted and reference conductors with the far end strap to determine the resistance of each section of the conductor relative to the test set, fault, and strap (however, accuracy may be compromised due to noise oscillators or toners which inject noise and errors, should not be used in place of a very low resistance far end strap).

There are 3 RFL tests to choose from:

- **RFL-2-Wire**
- **RFL-4-Wire**
- **RFL-K-Test**

RFL-2-Wire

The **RFL-2-Wire** test allows you to locate resistive faults between tip to ground, or ring to ground. By default, the unit assumes that the fault cable is connected to ring. If the distance to fault is greater than the strap, the tester will automatically reverse the leads internally and change the results diagram to reflect this.

The *connection diagram* shows you how to connect the cables to the unit. The green lead is used as reference.

Note: *Results are less accurate than a separate good pair setup.*

RFL Test

RFL-2-Wire

To access RFL-2-Wire Test:

1. From the **Copper** main menu **Test Groups**, select **RFL** test.
2. From the **Tests** menu, select **RFL** test.
By default, the **RFL-2-Wire** page opens.
3. Tap **Start** button to start the test

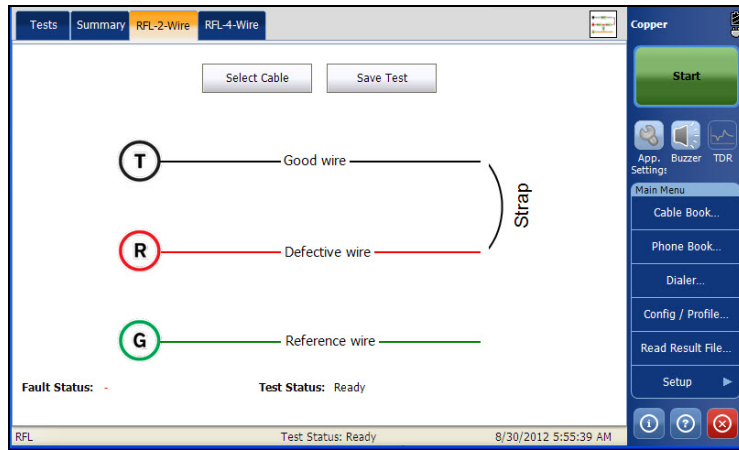

The page allows you to set the following parameters:

- **Select Cable** button opens a new page that allows you to set the cable parameters for the current test. Refer *Setting Cable Parameters* on page 212 for more information.
- **Save Test** button opens a new page that allows you to save a snapshot of test results into a result file. Refer *Save Test* on page 74 for more information.

- The page displays single pair RFL test results. Based on the cable condition, corresponding values are added into the diagram at their specific positions. Test result units are dependent on **Standard** in **Setup/Application Settings**.
 - Distance to strap (DTS).
 - Resistance to strap (RTS).
 - Distance from fault to strap (DFTS).
 - Resistance from fault to strap (RFTS).
 - Resistance to fault (RTF).
 - Distance to fault (DTF).
 - Faulted cable (FC).
 - Resistance at Fault (Rf) is the ohms of the fault only.
 - Voltage at fault (Vf).

If the test reports that it cannot detect the strap when the measured loop resistance is >10 k Ohm, this may mean:

- There is no strap connected.
- There is a strap, but the cable is too long and has a loop resistance >10 k Ohm.
- There is a strap, but there is a high resistance fault or open in the cable.
- The connection (leads or strap) may be faulty.

The resistance test may be used to troubleshoot this problem.

- **Fault Status** displays the status of the RFL test.
- **Test Status** displays the current state of measurement or an error message.

RFL-4-Wire

The **RFL-4-Wire** or separate good pair test allows you to determine the distance to a short, ground, or battery cross on a faulty cable conductor using two separate good cable conductors.

Connect a strap from the faulted wire to both conductors of the good pair.

The *connection diagram* shows you how to connect the cables to the unit.

Note: Results are more accurate but less forgiving than a 2-wire setup because the 4-wire setup requires you to connect the faulted wire conductor to the Ring (red) jack only.

To access RFL-4-Wire Test:

1. From the Copper main menu **Test Groups**, select **RFL** test.
2. From the **Tests** menu, select **RFL** test to start the test.
3. Tap **RFL-4-Wire** tab to open the window.

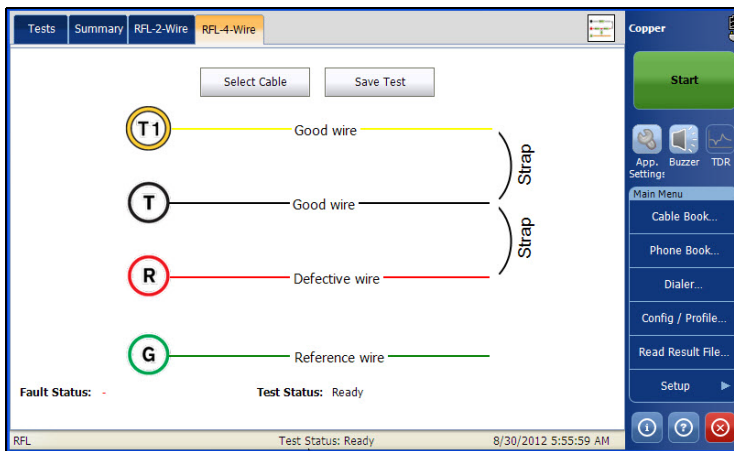

The page allows you to set the following parameters:

- **Select Cable** button opens a new page that allows you to set the cable parameters for the current test. Refer *Setting Cable Parameters* on page 212 for more information.
- **Save Test** button opens a new page that allows you to save a snapshot of test results into a result file. Refer *Save Test* on page 74 for more information.
- The page displays the separate good pair RFL test results. Based on the cable condition, corresponding values are added into the diagram at their specific positions. Test result units are dependent on **Standard in Setup/Application Settings**.
 - Distance to strap (DTS).
 - Resistance to strap (RTS).
 - Distance from fault to strap (DFTS).
 - Resistance from fault to strap (RFTS).
 - Resistance to fault (RTF).
 - Distance to fault (DTF).
 - Faulted cable (FC).
 - Resistance at Fault (Rf) is the ohms of the fault only.
 - Voltage at fault (Vf).

If the test reports that it cannot detect the strap when the measured loop resistance is >10 k Ohm, this may mean:

RFL Test

RFL-4-Wire

- There is no strap connected.
- There is a strap, but the cable is too long and has a loop resistance > 10 k Ohm.
- There is a strap, but there is a high resistance fault or open in the cable.
- The connection (leads or strap) may be faulty.

The resistance test may be used to troubleshoot this problem.

- **Fault Status** displays the status of the RFL test.
- **Test Status** displays the current state of measurement or an error message.

RFL-K-Test

The RFL-K Test (Küpfmüller test) method allows you to locate faults on both conductors of one pair. In other words, the K-Test is specialized for detecting double faults. Due to the precision and sensitive nature of RFL tests, the cable pair under test should be open (disconnected) and battery removed. The test may be used in live cables with ground/earth as a reference for the 2-wire method, however ground/earth may also introduce significant noise affecting the accuracy.

The K-Test is performed in 2 steps:

1. Measurements are made with the far end open.
2. Measurements are made with the far end closed (strap).

To access RFL-K-Test:

1. From the Copper main menu **Test Groups**, select **RFL** test.
2. From the **Tests** menu, select **RFL** test to start the test.

Tap **RFL-K-Test** tab to open the window.

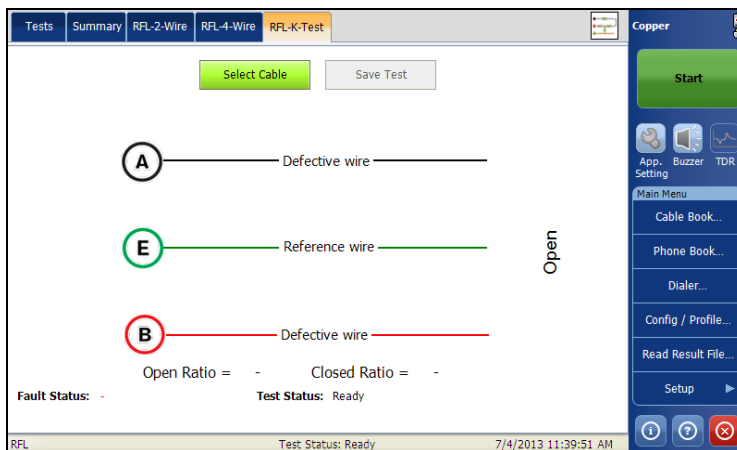

The page allows you to set the following parameters:

- **Select Cable** button opens a new page that allows you to set the cable parameters for the current test. Refer *Setting Cable Parameters* on page 212 for more information.
- **Save Test** button opens a new page that allows you to save a snapshot of test results into a result file. Refer *Save Test* on page 74 for more information.
- Based on the cable condition, corresponding values are added into the diagram at their specific positions. Test result measurement units are dependent on **Standard** in **Setup/Application Settings**. The **RFL-K-Test** diagram can display some of the following elements:
 - R/A-T/B-G/E wire connectors.
 - Distance/resistance to strap (DTS/RTS): distance/resistance from the FTB-1 to the strap (far end).
 - Distance/resistance from fault to strap (DFTS/RFTS).
 - Distance/resistance to fault (DTF/RTF): distance/resistance from the FTB-1 to the fault.
 - Faults are displayed as follows:
 - Defective Cable (DC).
 - Resistance at fault (Rf1, Rf2): resistance from the fault to the resistance wire.
 - Voltage at fault (Vf1, Vf2).

Note: *There need not be 2 faults (Rf1, Rf2). If there is only one fault, the K-Test reduces to the **RFL-2-Wire** case.*

- **Open Ratio** value is calculated during the first step mentioned above (1), and is displayed prior to the second step (2).
- **Closed Ratio** value is calculated during the second step (2), and is displayed on the final diagram, along with the **Open Ratio** value.
- Defective wire is represented by T/A and R/B wires.
- Reference wire is represented by G/E wire.
- **Fault Status** displays the status of the RFL test.
- **Test Status** displays the current state of measurement or an error message.

Setting Cable Parameters

The **Cable Selection** page allows you to set cable parameters for an RFL test. Settings are shared by all RFL test: 2-Wire, 4-Wire, and K-Test. Changes done for one test are reflected in the others.

To set the cable values:

1. From the **Copper** main menu **Test Groups**, select **RFL** test.
2. From the **Tests** menu, select **RFL** test.
3. Tap **RFL-2-Wire**, **RFL-4-Wire**, or **RFL-K-Test** to open the window.
4. Tap **Select Cable** button to open the **Cable Selection** page.
5. Edit the cable values as required.
6. Tap **Close** to confirm and exit the page.

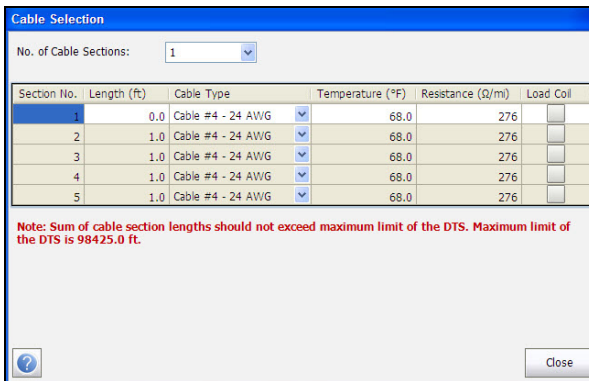

The page allows you to set the following parameters:

- **No. of Cable Sections** allows you to set the number of consecutive cable sections, to a maximum of 5. If unknown, set the number to 1.
- **Section No.** lists the number of cable sections.
- **Length** allows you to specify the cable length of each section. If the cable length is unknown, specify 0 and the RFL test will measure the length.
- **Cable Type** allows you to select a cable entry (with its associated parameters) from the current **Cable Book**, to use for testing. The selection is not saved when leaving the test. The current Cable Book entry is shown by default.
- **Temperature** allows you to change the temperature of the cable under test in either degree **C** or **F**.
- **Resistance** specifies a value for the resistance constant of the cable in each section.
- **Load Coil** allows you to set the detection of the presence of load coils by checking the box.

Summary

Summary tab displays the pass/fail status of the tests executed. Refer *Copper Tests: Result Summary* on page 291 for more information.

Supplemental

The **Supplemental** tab displays read-only **Date and Time** and **Pass/Fail Test Status** of the **Test Lead Compensation**. It also displays the **Cable Parameters** details configured for the RFL tests. See *Setting Cable Parameters* on page 212 for more information on the cable values.

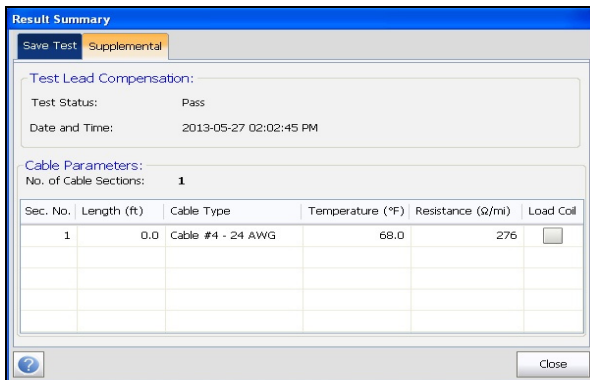

14 Signal Test

The purpose of the signal tests is to perform VF (voice frequency) and WB (Wideband) level measurements and calculate signal attenuation during transmission.

To access Signal tests:

From the **Copper** main menu **Test Groups**, select **Signal** test.

Signal Main Page

The **Signal** menu allows you to select and run the displayed tests:

- **WB Balance**
- **WB Attenuation**
- **TX/RX Tone**

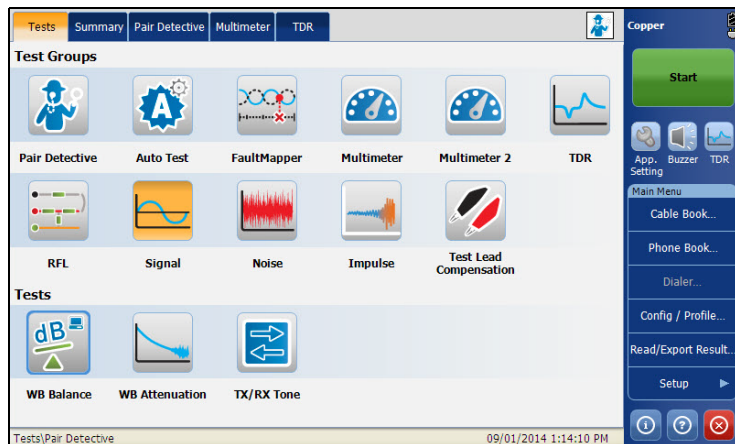

To start/stop a test:

1. From the **Copper** main menu **Test Groups**, select **Signal** test.
2. From the **Tests** menu, select the test to run.

Signal Test

WB Balance Test

WB Balance Test

The wideband balance test ensures that the balance ratio for the twisted pair complies with applicable standards so as to reduce the effects of common-mode voltage to ground. The better the balance of the cable pair, the higher the dB reading. Unlike VF Balance, WB Balance measures balance across many frequencies to get an understanding of balance at higher frequencies used for DSL. However, as frequency increases, balance is reduced, so that a single threshold value across the wideband range is an approximate indication in the test. Significant decrease across a wide band of frequencies could be indicative of service affecting cable fault affecting higher frequencies more than low (and hence DSL).

WB Balance

The **Balance** page allows you to configure the parameters for the **WB Balance** test and view the results. The page also displays a graph of the **Marginal** and **Good** balance threshold values, and pass/fail status.

To access **WB Balance** page:

1. From the **Copper** main menu **Test Groups**, select **Signal** test.
2. From the **Tests** menu, select **WB Balance** test to start the test.
By default, **WB Balance** page opens.
3. Use the graph controls to maneuver the graph. Refer to *Graph Controls* on page 19 for more information.



The current group and the current test which is being measured is displayed in the status bar, for example **Signal\WB Balance**.

Signal Test

WB Balance Test

The page displays the following parameters:

- The **P/F** (pass/fail) status is a fail if any attenuation measurement (trace) is greater than the corresponding marginal test threshold for a **Maximum** threshold, or less than the corresponding marginal test threshold for a **Minimum** threshold. Otherwise, the status is a pass. If no valid results are available or the marginal threshold is disabled, there will be no **P/F** indicator.
- **Edit Parameters** button opens a new page that allows you to set the test parameters.
- **Edit Thresholds** button opens a new page that allows you to set the threshold parameters.
- **Save Test** button opens a new page that allows you to save a snapshot of test results into a result file. Refer *Save Test* on page 74 for more information.
- **Marginal** is the marginal balance threshold for the current selected bandwidth, represented by a horizontal yellow line.
- **Good** is the good balance threshold for the current selected bandwidth, represented by a horizontal green line.

Setting Test Parameters

The **Test Parameters** page allows you to set the parameter values for the test.

To set the Parameter values:

1. From the **Copper** main menu **Test Groups**, select **Signal** test.
2. From the **Tests** menu, select **WB Balance** test.
3. Tap **WB Balance** tab to set the parameter values.
4. Tap **Edit Parameters** button to open the **Test Parameters** page.
5. Set the parameter values as required.
6. Tap **Close** to confirm and exit the page.

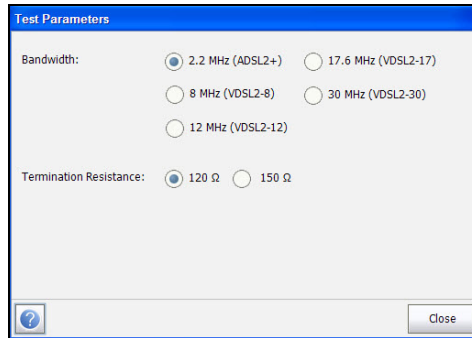

The page allows you to set the following parameters:

- **Bandwidth** sets the frequency range for the test by selecting from the following bandwidths:
 - 2.2 MHz (ADSL/2+)
 - 8 MHz (VDSL2-8)
 - 12 MHz (VDSL2-12)
 - 17.6 MHz (VDSL2-17)
 - 30 MHz (VDSL2-30)
- **Termination Resistance** defines the resistance of the test interface connected to the line.

Signal Test

WB Balance Test

Setting Threshold Values

The **Test Thresholds** page allows you to set the **Marginal/Good Balance** thresholds for ADSL/2+ and VDSL2-8/12/17/30 WB Balance.

To set the Threshold values:

1. From the **Copper** main menu **Test Groups**, select **Signal** test.
2. From the **Tests** menu, select **WB Balance** test.
3. Tap **WB Balance** tab for which you want to set the threshold values.
4. Tap **Edit Thresholds** button to open the **Test Thresholds** page.
5. Set the threshold values as required.
6. Tap **Close** to confirm and exit the page.

Test Type	Marginal Balance (dB)	Good Balance (dB)
ADSL/2+	50	55
VDSL2-8	50	55
VDSL2-12	50	55
VDSL2-17	35	38
VDSL2-30	35	38

The page allows you to set the following parameters:

- **Threshold** is the threshold limit for each pair: **Maximum**, **Minimum**, or **None**.
- **Marginal/Good Balance** are balance thresholds ranging from 5 dB to 99 dB..

Summary

VF and WB Balances are great indicators of quality, the best single indication of how much one conductor is like the other based on how much Power Influence or noise the pair can mitigate.

Summary tab displays the pass/fail status of the tests executed. Refer *Copper Tests: Result Summary* on page 291 for more information.

Signal Test

WB Attenuation Test

WB Attenuation Test

The WB Attenuation test calculates the single ended attenuation across a user specified bandwidth.

WB Attenuation

The **WB Attenuation** page allows you to configure the parameters for the **Attenuation** test and view the results. The page also displays a graph of the **Marginal** and **Good** balance results, and pass/fail status.

To access WB Attenuation page:

1. From the **Copper** main menu **Test Groups**, select **Signal** test.
2. From the **Tests** menu, select **WB Attenuation** test to start the test.
By default, **WB Attenuation** page opens.
3. Use the graph controls to maneuver the graph. Refer to *Graph Controls* on page 19 for more information.



The current group and the current test which is being measured is displayed in the status bar, for example **Signal\WB Attenuation**.

The page displays the following parameters:

- **Edit Parameters** button opens a new page that allows you to set the test parameters.
- **Edit Thresholds** button opens a new page that allows you to set the Threshold parameters.
- **Select Cable** button opens a new page that allows you to set the **Cable Parameters** for the current test.
- **Save Test** button opens a new page that allows you to save a snapshot of test results into a result file. Refer *Save Test* on page 74 for more information.

Signal Test

WB Attenuation Test

Setting Test Parameters

The **Test Parameters** page allows you to set the parameter values for the test.

To set the Parameter values:

1. From the **Copper** main menu **Test Groups**, select **Signal** test.
2. From the **Tests** menu, select **WB Attenuation** test.
3. Tap **Edit Parameter** button to open the **Test Parameter** page.
4. Set the **Bandwidth** values as required.
5. Tap **Close** to confirm and exit the page.

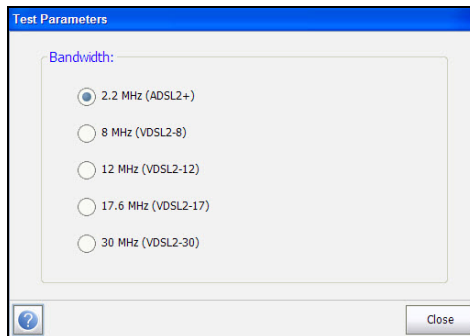

The page allows you to set the following parameter:

Bandwidth sets the frequency range for the test.

Setting Threshold Values

The **Test Thresholds** page allows you to set the **WB Attenuation Thresholds** values for the test.

To set the Threshold values:

1. From the **Copper** main menu **Test Groups**, select **Signal** test.
2. From the **Tests** menu, select **WB Attenuation** test.
3. Tap **Edit Thresholds** button to open the **Test Thresholds** page.
4. Set the threshold values as required.
5. Tap **Close** to confirm and exit the page.

WB Attenuation Thresholds:	
Threshold:	Maximum
Attenuation (ADSL/2+) :	65 dB
Threshold:	Maximum
Attenuation (VDSL2-8) :	65 dB
Threshold:	Maximum
Attenuation (VDSL2-12) :	65 dB
Threshold:	Maximum
Attenuation (VDSL2-17) :	65 dB
Threshold:	Maximum
Attenuation (VDSL2-30) :	65 dB

The page allows you to set the following parameters:

- **Threshold** is the threshold limit for each pair: **Maximum**, **Minimum**, or **None**.
- **Attenuation** sets the threshold.

Signal Test

WB Attenuation Test

Setting Cable Parameters

The **Cable Selection** page allows you to set cable parameters for the **Attenuation** test.

To set the Cable Setup values:

1. From the **Copper** main menu **Test Groups**, select **Signal** test.
2. From the **Tests** menu, select **WB Attenuation** test.
3. Tap **Select Cable** button to open the **Cable Selection** page.
4. Edit the **Cable Parameters** as required.
5. Tap **Close** to confirm and exit the page.

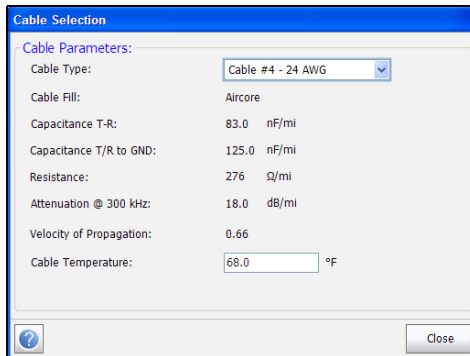

The screenshot shows a dialog box titled "Cable Selection" with a blue header. Below the header, the text "Cable Parameters:" is followed by a list of parameters and their values:

Cable Type:	Cable #4 - 24 AWG
Cable Fill:	Aircore
Capacitance T-R:	83.0 nF/mi
Capacitance T/R to GND:	125.0 nF/mi
Resistance:	276 Ω/mi
Attenuation @ 300 kHz:	18.0 dB/mi
Velocity of Propagation:	0.66
Cable Temperature:	68.0 °F

At the bottom left of the dialog box is a help icon (a question mark in a circle), and at the bottom right is a "Close" button.

The page allows you to set or view the following parameters:

- **Cable Type** allows you to select a cable entry (with its associated parameters) from the current **Cable Book**, to use for testing. The selection is not saved when leaving the test. The current Cable Book entry is shown by default.
- **Cable Fill Material** read-only entry is the type of material the cable is filled with: **Aircore**, **Jelly**, **Pulp**, **5 PR**, or **2 PR**. Setup in the **Cable Book**.
- **Capacitance T-R** specifies a value for the capacitance per length constant.

- **Capacitance T/R to GND** specifies a value for the capacitance per length to ground constant.
- **Resistance** specifies a value for the resistance constant of the cable.
- **Attenuation @ 300 kHz** specifies a value for the reduction in signal strength or insertion loss of the cable.
- **Velocity of Propagation** read-only entry is the velocity of propagation for the cable as a ratio of the speed of light. Setup in the **Cable Book**.
- **Cable Temperature** allows you to change the temperature of the cable under test in either degree **C** or **F**.

Summary

Summary tab displays the pass/fail status of the tests executed. Refer *Copper Tests: Result Summary* on page 291 for more information.

Signal Test

TX/RX Tone Test

TX/RX Tone Test

The purpose of the **TX/RX Tone** test is to perform VF (voice frequency) and WB (wideband) frequency and level measurements for Send and Receive tone.

Send Tone

The Send Tone allows you to measure the amount of level and frequency tone sent.

To access Send Tone page:

1. From the **Copper** main menu **Test Groups**, select **Signal** test.
2. From the **Tests** menu, select **TX/RX Tone** test to start the test.

By default, the **Send Tone** page opens.

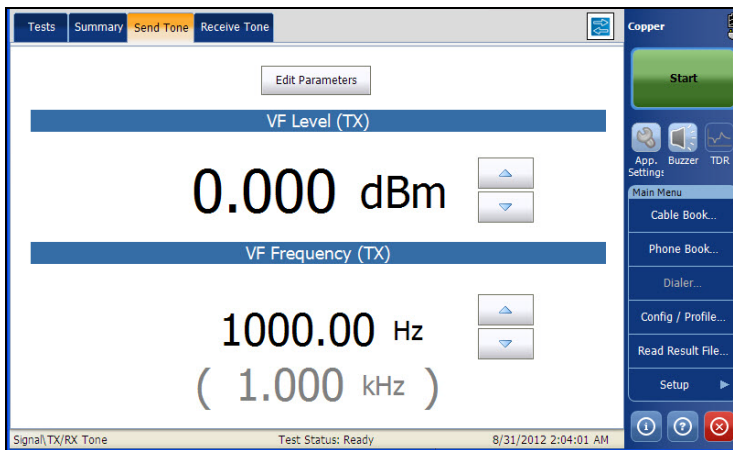

The current group and the current test which is being measured is displayed in the status bar, for example **Signal/TX/RX Tone**.

Note: You can increase or decrease the value of **VF Level** and **VF Frequency** by using the corresponding up and down arrows.

The page displays the following parameters:

- **Edit Parameters** button opens a new page that allows you to set the test parameters.
- **Test Status** displays the current state of measurement or an error message.

Setting Test Parameters

The **Test Parameters** page allows you to set the parameter values for the test.

To set the Parameter values:

1. From the **Copper** main menu **Test Groups**, select **Signal** test.
2. From the **Tests** menu, select **TX/RX Tone** test.
3. Tap **Send Tone** tab for which you want to set the Parameter values.
4. Tap **Edit Parameter** button to open the **Test Parameter** page.
5. Set the Parameter values as required.
6. Tap **Close** to confirm and exit the page.

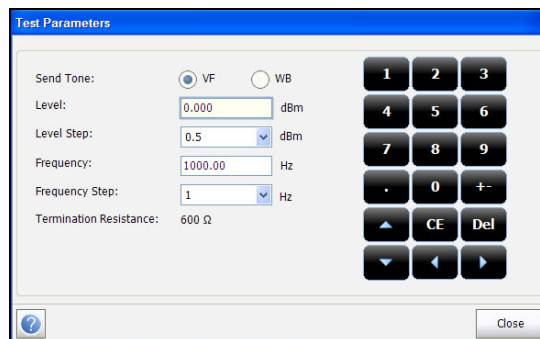

Signal Test

TX/RX Tone Test

The page displays the following parameters:

- **Send Tone** allows you to select the Wideband Frequency or Voice Frequency for the Send tone.
- **Level** allows you to set the send tone level.
- **Level Step** allows you to set the send tone level step.
- **Frequency** allows you to set the send tone frequency to be used.
- **Frequency Step** allows you to set the send tone frequency step.
- **Termination Resistance** displays the termination resistance.

Note: *The Level or Frequency values can be increased or decreased by selecting the Level or Frequency and pressing up or down arrows on the FTB-1 keypad.*

Receive Tone

The Receive Tone allows you to measure the amount of level and frequency tone received.

To access Receive Tone page:

- 1.** From the **Copper** main menu **Test Groups**, select **Signal** test.
- 2.** From the **Tests** menu, select **TX/RX Tone** test to start the test.
- 3.** Select the **Receive Tone** tab.

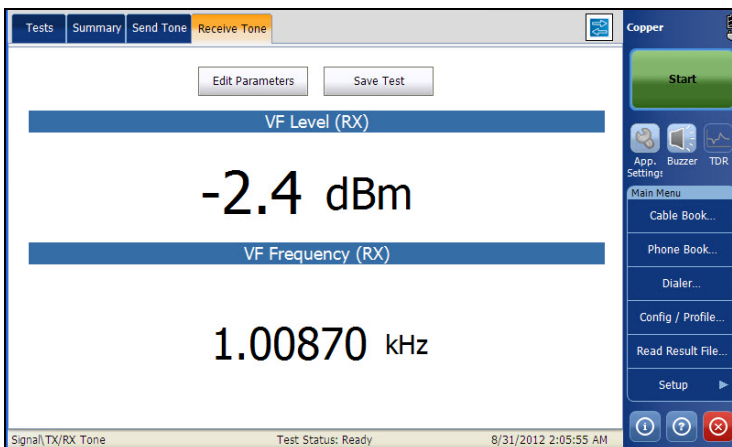

The current group and the current test which is being measured is displayed in the status bar, for example **Signal/TX/RX Tone**.

Signal Test

TX/RX Tone Test

The page displays the following parameters:

- **Edit Parameters** button opens a new page that allows you to set the test parameters.
- **Test Status** displays the current state of measurement or an error message.
- **Save Test** button opens a new page that allows you to save a snapshot of test results into a result file. Refer *Save Test* on page 74 for more information.

Setting Test Parameters

The **Test Parameters** page allows you to set the parameter values for the test.

To set the Parameter values:

1. From the **Copper** main menu **Test Groups**, select **Signal** test.
2. From the **Tests** menu, select **Balance** test.
3. Tap **Receive Tone** tab for which you want to set the Parameter values.
4. Tap **Edit Parameter** button to open the **Test Parameter** page.
5. Set the Parameter values as required.
6. Tap **Close** to confirm and exit the page.

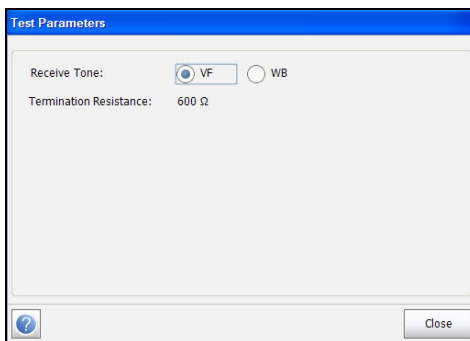

The page displays the following parameters:

- **Receive Tone** allows you to select the Wideband Frequency or Voice Frequency for the Receive tone.
- **Termination Resistance** displays the termination resistance.

Summary

Summary tab displays the pass/fail status of the tests executed. Refer *Copper Tests: Result Summary* on page 291 for more information.

15 Noise Tests

The purpose of the noise tests is to perform VF (voice frequency) noise, WB (wideband) noise, and level measurements.

To access Noise tests:

From the **Copper** main menu **Test Groups**, select **Noise** test.

Noise Main Page

The **Noise** menu allows you to select and run the displayed tests:

- **VF Noise**
- **Power Influence**
- **WB PSD Noise**
- **NEXT**

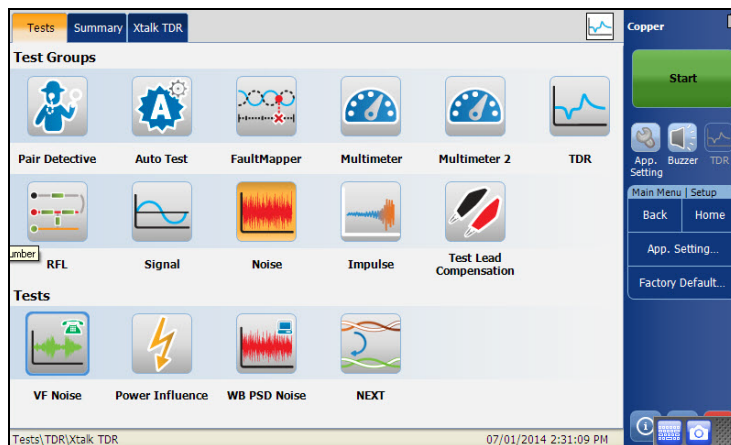

To start/stop a test:

1. From the **Copper** main menu **Test Groups**, select **Noise** test.
2. From the **Tests** menu, select the test to run.

Noise Tests

VF Noise Test

VF Noise Test

The **VF Noise** test allows you to measure the amount of unwanted VF band noise within the C-Message filter, which could affect POTS voice communications.

Continuous

The **Continuous** function displays and updates results in *real time*, until you stop the test. The last valid results then remain displayed. The page also displays the pass/fail status and **VF Noise** value.

To access **Continuous** page:

1. From the **Copper** main menu **Test Groups**, select **Noise** test.
2. From the **Tests** menu, select **VF Noise** test to start the test.

By default, the **Continuous** page opens.

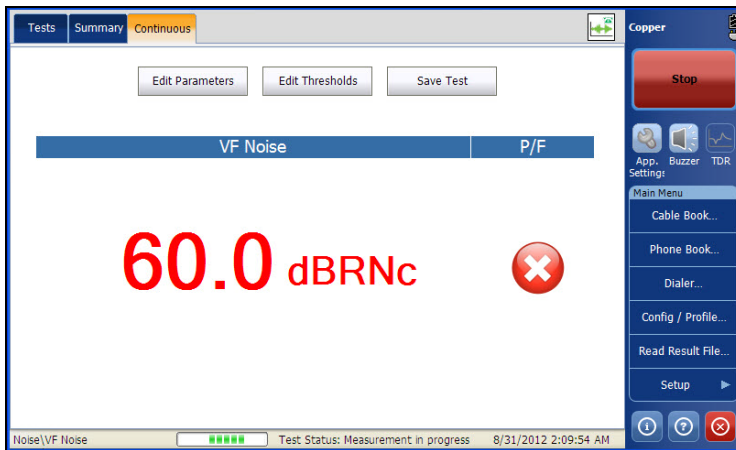

The current group and the current test which is being measured is displayed in the status bar, for example **Noise\VF Noise**.

The page displays the following parameters:

- **Edit Thresholds** button opens a new page that allows you to set the VF Noise thresholds.
- **Edit Parameters** button opens a new page that allows you to set the Noise parameters.
- **Save Test** button opens a new page that allows you to save a snapshot of test results into a result file. Refer *Save Test* on page 74 for more information.
- **Test Status** displays the current state of measurement or an error message.

Setting Threshold Values

The **Test Thresholds** page allows you to set the **VF Noise Threshold** values for the test.

To set the Threshold values:

1. From the **Copper** main menu **Test Groups**, select **Noise** test.
2. From the **Tests** menu, select **VF Noise** test.
3. Tap **Continuous** tab.
4. Tap **Edit Thresholds** button to open the **Test Thresholds** page.
5. Set the Threshold values as required.
6. Tap **Close** to confirm and exit the page.

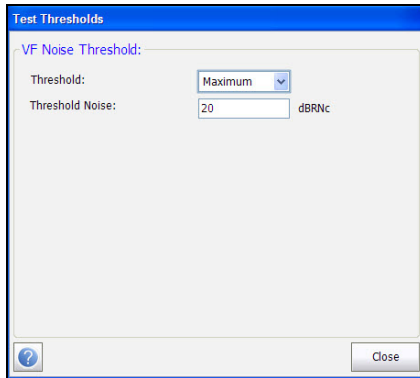

The page allows you to set the following parameters:

- **Threshold** is the threshold limit for each pair: **Maximum**, **Minimum**, or **None**.
- **Threshold Noise** sets the threshold value.

Setting Test Parameters

The **Test Parameters** page allows you to set the **VF Noise** test parameters.

To set the Parameter values:

1. From the **Copper** main menu **Test Groups**, select **Noise** test.
2. From the **Tests** menu, select **VF Noise** test.
3. Tap **Continuous** tab.
4. Tap **Edit Parameters** button to open the **Test Parameters** page.
5. Set the Parameter values as required.
6. Tap **Close** to confirm and exit the page.

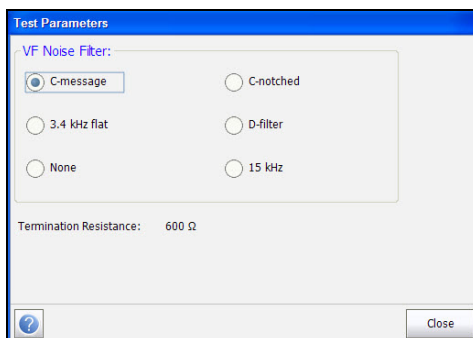

The page allows you to set the following parameters:

- **VF Noise filter** allows you to define the voice frequency noise filter to be used, dependent on **ITU** or **ANSI Standard** mode.
- **Termination Resistance** is a read-only value of **600 Ω**.

Noise Tests

VF Noise Test

Summary

The VF noise tests provides you a quick and simple indication of level of voice band noise on the circuit. In general values greater than 20 DBRNC affect service and can be heard by the customer. Metallic faults and bad VF Balance are the typical causes of VF Noise, although high external sources or Power Influence can also cause too much noise on an otherwise good pair.

Summary tab displays the pass/fail status of the tests executed. Refer *Copper Tests: Result Summary* on page 291 for more information.

Power Influence Test

The Power Influence test allows you to view the effects of interference from a 50 Hz or 60 Hz power source (AC mains) on the circuit under test to include graphical display of third triplet power harmonics up to 20KHz, which can aid in troubleshooting noisy circuits. The results of the power influence test are also in graphical form.

Power Influence

The **Power Influence** function displays and updates results in *real time*, until you stop the test. The last valid results then remain displayed. The page also displays a value and graph of the **Power Influence** measurement, and pass/fail status.

To access Power Influence page:

- 1.** From the **Copper** main menu **Test Groups**, tap **Noise** test.
- 2.** From the **Tests** menu, tap **Power Influence** icon to start the test.
By default, the **Power Influence** page opens.
- 3.** Use the graph controls to maneuver the graph. Refer to *Graph Controls* on page 19 for more information.

Noise Tests

Power Influence Test



The current group and the current test which is being measured is displayed in the status bar, for example **Noise\Power Influence**.

The page displays the following parameters:

- **Edit Parameters** button opens a new page that allows you to view the **Power Influence** parameters.
- **Edit Thresholds** button opens a new page that allows you to set the Power Influence thresholds.
- **Save Test** button opens a new page that allows you to save a snapshot of test results into a result file. Refer *Save Test* on page 74 for more information.

Setting Threshold Values

The **Test Thresholds** page allows you to set the **Power Influence Threshold** values for the test.

To set the Threshold values:

1. From the **Copper** main menu **Test Groups**, select **Noise** test.
2. From the **Tests** menu, select **Power Influence** test.
3. Tap **Edit Thresholds** button to open the **Test Thresholds** page.
4. Set the threshold values as required.
5. Tap **Close** to confirm and exit the page.

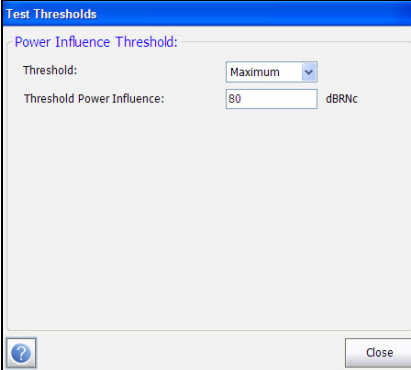

The screenshot shows a dialog box titled "Test Thresholds" with a blue header. Below the header, the text "Power Influence Threshold:" is displayed. There are two input fields: "Threshold:" with a dropdown menu currently set to "Maximum", and "Threshold Power Influence:" with a text input field containing the number "80" and the unit "dB(R)C" to its right. At the bottom left of the dialog is a help icon (a question mark in a circle), and at the bottom right is a "Close" button.

The page allows you to set the following parameters:

- **Threshold** is the threshold limit for each pair: **Maximum**, **Minimum**, or **None**.
- **Threshold Power Influence** sets the threshold value.

Noise Tests

Power Influence Test

Test Parameters

The **Test Parameters** page allows you to view the **Power Influence** test parameters which are fixed, based on the application setting of ITU or ANSI.

To view the parameter values:

1. From the **Copper** main menu **Test Groups**, select **Noise** test.
2. From the **Tests** menu, select **Power Influence** test.
3. Tap **Edit Parameters** button to open the **Test Parameters** page.
4. Tap **Close** to confirm and exit the page.

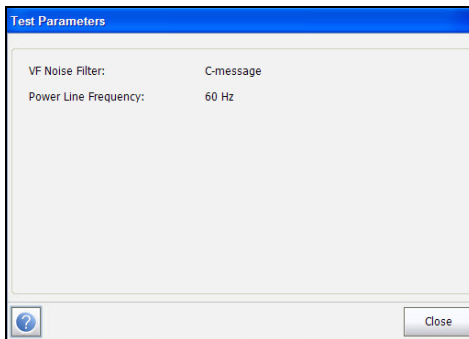

The page displays the following parameters:

- **VF Noise filter** is the voice frequency noise filter to be used, dependent on ITU or **ANSI Standard** mode.
- **Power Line Frequency** is a value of 50 or 60 Hz based on frequency selected in **Setup/Application Settings/Standard**.

Summary

Power Influence is a classical and common measurement to check the level of influence of power lines on voice circuits. The level of influence is mostly affected by how long the power line runs parallel with the phone line, but also the distance between the power and phone lines, and balance of the pairs/cable. The presence of harmonics can indicate problems or faults in the power distribution plant, which may only be resolved in some cases by the power company. With the deployment of higher speed services over DSL, the upper harmonics of the power distribution are of more concern, and can reach as high as 375KHz, well into DSL frequencies. Good balance and a well maintained sheath/shield (bonds and grounds) are the key elements in minimizing the effect of Power Influence on cable pairs.

Summary tab displays the pass/fail status of the tests executed. Refer *Copper Tests: Result Summary* on page 291 for more information.

WB PSD Noise Test

The Wideband PSD (Power Spectral Density) noise test measures the noise power across a wide frequency passband, to provide an indication of the presence of XTALK, noise disturbers, impulse noise, EMI, and other sources (such as North American AM radio) that have coupled onto the cable pair under test. The test automatically identifies some typical cross-talk (XTALK) such as HDSL or ISDN, while you can move the cursor over other peaks to see the frequency and power level of specific frequencies. You can view a *mask*, a line representing the power distribution of typical circuits such as ISDN, overlaid on the noise graph to identify the presence of other signals on the line under test.

WB PSD

The **PSD** page allows you to configure the parameters for the wideband PSD noise test and view the results.

To access WB PSD page:

- 1.** From the **Copper** main menu **Test Groups**, select **Noise** test.
- 2.** From the **Tests** menu, select **WB PSD Noise** test to start the test.
By default, the **WB PSD** page opens.
- 3.** Use the graph controls to maneuver the graph. Refer to *Graph Controls* on page 19 for more information, except for Mask , see below.

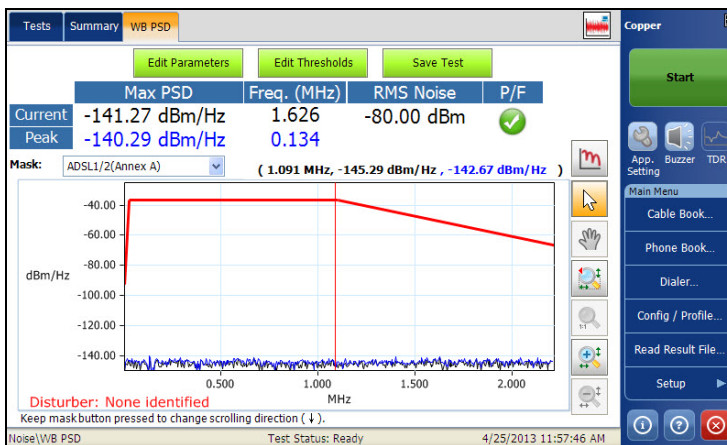

The page displays the following parameters:

- **Edit Parameters** button opens a new page that allows you to set the WB PSD parameters.
- **Edit Thresholds** button opens a new page that allows you to set the WB PSD thresholds.
- **Save Test** button opens a new page that allows you to save a snapshot of test results into a result file. Refer to *Save Test* on page 74 for more information.
- **Current** displays the current value plotted on the y-axis.
- **Peak** displays the maximum peak PSD noise measurement value.
- **Mask** (drop-down list) allows you to overlay masks (lines representing the power signal of other services) by selecting a mask from the drop-down list, which is displayed over the active noise graph.
- Mask  graph control icon is enabled only if at least one mask is enabled. Tapping the icon displays the next (sequential) enabled mask. A long press reverses direction of the cycle.

Noise Tests

WB PSD Noise Test

Note: You can quickly go to a mask, that is without scrolling , if you select the desired mask using the **Mask** drop-down list.

- **Disturber** displays the name of the dominant **Disturber** and its associated probability detected from the **WB PSD** test result.

Setting Test Parameters

The **Test Parameters** page allows you to set the WB PSD Noise test parameters.

To set the Parameter values:

1. From the **Copper** main menu **Test Groups**, tap **Noise** test.
2. From the **Tests** menu, tap **WB PSD Noise** test.
3. Tap **Edit Parameters** button to open the **Test Parameters** page.
4. Set the parameter values as required.
5. Tap **Close** to confirm and exit the page.

General Settings

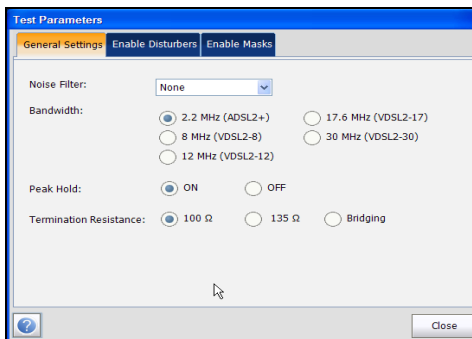

The **General Settings** tab allows you to set the following parameters:

- **Noise Filter** defines the filter currently enabled. Options are: **None**, **ISDN-E**, **HDSL-F**, **ADSL-G**, **ADSL**, **ADSL2+**, **VDSL**, **VDSL2-8**, **VDSL2-12**, **VDSL2-17**, **VDSL2-30**.
- **Bandwidth** sets the frequency range for the test.
- **Peak Hold** allows you to measure the current PSD noise value, compare it against the peak value at each given frequency, and display the maximum value. Select either **ON** or **OFF**.
- **Termination Resistance** allows you to define the resistance of the dummy load connected to the line, including **Bridging**.

Noise Tests

WB PSD Noise Test

Enable Disturbers

The **Enable Disturbers** tab allows you to select disturbers to display on the screen: specific ones, all, or none. The displayed disturber on the WB PSD results page will be the most dominant disturber that is enabled.

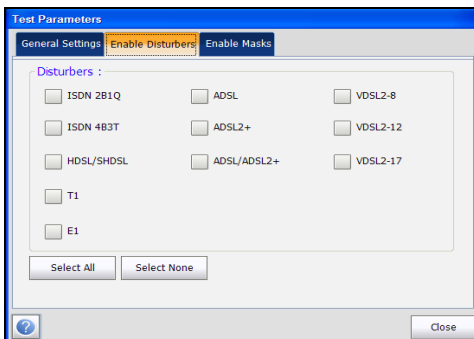

Enable Masks

The **Enable Masks** tab allows you to enable/disable each type and each individual mask.

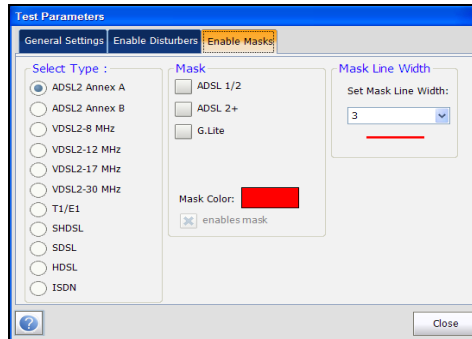

The page displays the following parameters:

- **Select Type** lists all possible mask types to enable.
- **Mask** lists a selection of masks, from the type, available for overlay.
- **Mask Color** allows you to select the color of the mask overlay to easily differentiate it from the WB PSD noise signal.
- **Mask Line Width** allows you to set the width for the mask line in the graph.

Setting Threshold Values

The **Test Thresholds** page allows you to set the **WB PSD Noise Threshold** values for the test.

To set the Threshold values:

1. From the **Copper** main menu **Test Groups**, select **Noise** test.
2. From the **Tests** menu, tap **WB PSD Noise** test.
3. Tap the **Edit Thresholds** button to open the **Test Thresholds** page.
4. Set the threshold values as required.
5. Tap **Close** to confirm and exit the page.

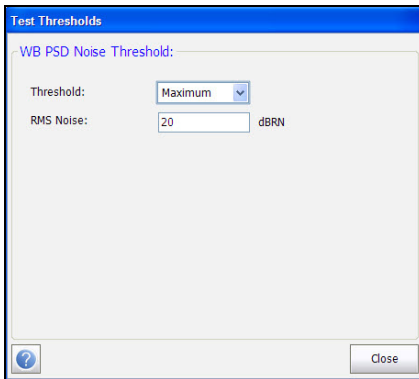

The page allows you to set the following parameters:

- **Threshold** is the threshold limit for each pair: **Maximum**, **Minimum**, or **None**.
- **RMS Noise** sets the threshold value.

Summary

In general, with the advent of high speed DSL, we are concerned not only with metallic pair quality, but also noise which may be reducing SNR, and hence interfering with signal quality and service. The WB Power Spectral Density (PSD) Test and features are very informative in today's complex cable environment of high speed services.

Summary tab displays the pass/fail status of the tests executed. Refer *Copper Tests: Result Summary* on page 291 for more information.

Noise Tests

NEXT

NEXT

The **NEXT** test measures the Near End Crosstalk (NEXT) in dB, between 2 pairs of cables: the calculation is a ratio and a larger value is better. The test transmits a signal on the T/A - R/B pair, and measures the received crosstalk on T1/A1 - R1/B1 pair. The test has 2 modes of operation: **Spot** or continuous and **Spectrum** or snapshot.

Hookup Diagram

The **NEXT** test optionally displays a hookup diagram in a popup window at the start of each mode, showing you how to connect 2 pairs. The appearance of this diagram at test startup can be controlled in **Application Settings/General**. The hookup diagram uses the following graphic and textual components:

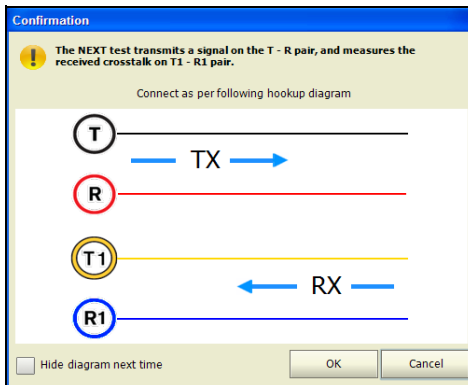

- **OK** button closes the hookup diagram prompt and starts the test.
- **Cancel** button closes the hookup diagram prompt only; you must tap **Start** to run the test.

- The **Confirmation** window is prompted before each mode is started (when selected in **Application Settings/General**). You can select **Hide diagram next time** which will not display the connection diagram the next time you run the test.

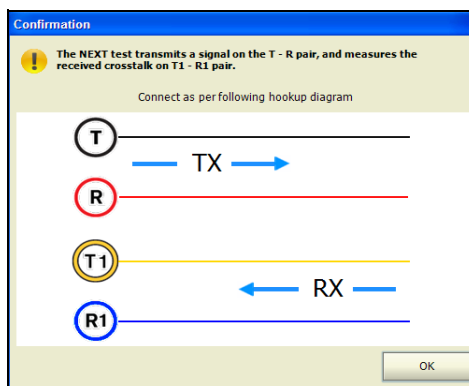

However, you can view the connection diagram at any time by tapping **Hookup Diagram** in either the **Spot** or **Spectrum** window. In this case, the test will not automatically start when you tap the **OK** button to close the **Confirmation** window.

Spot

The **Spot** function is a continuous mode of operation measuring the crosstalk for a specific frequency selected by you, similar to the method used by the **Send Tone** test. The **Spot** function displays and updates results in *real time*, until you stop the test. The last valid results including pass/fail status then remain displayed.

To access the Spot page:

1. From the **Copper** main menu **Test Groups**, select **Noise** test.
2. From the **Tests** menu, select **NEXT** test to start the test.

By default, the **Spot** page opens.

Noise Tests

NEXT

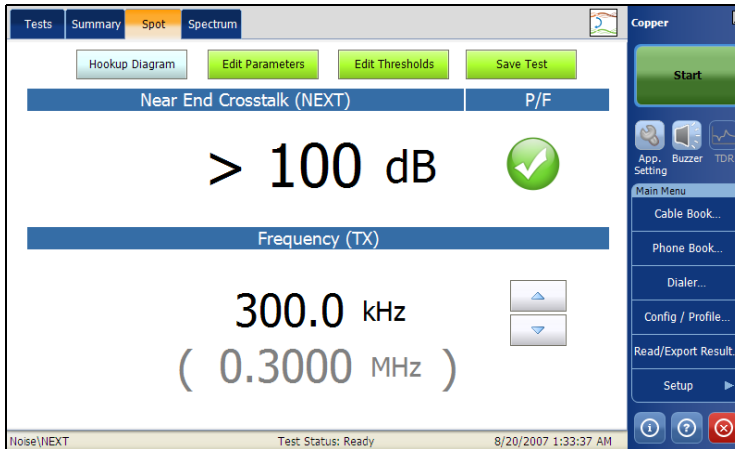

The page allows you to view and set the following parameters:

- **Hookup Diagram** button opens a **Confirmation** window displaying how to connect your cables.
- **Edit Parameters** button opens a new page that allows you to set the test parameters.
- **Edit Thresholds** button opens a new page that allows you to set the **Spot Mode Thresholds**.
- **Save Test** button opens a new page that allows you to save a snapshot of test results into a result file. Refer *Save Test* on page 74 for more information.
- **Near End CrossTalk (NEXT)** displays the measured near end crosstalk (in dB) for a single user selected frequency. The NEXT measurement range is from 0 to 100 dB, with 0.1 dB resolution.
- **Frequency (TX)** displays the single transmission frequency value selected in the **Test Parameters**.
- The up/down controls can be used for incrementing/decreasing the frequency value by one frequency step at a time.



Setting Spot Test Parameters

The **Test Parameters** page allows you to set the parameter values for the test.

To set the Parameter values:

1. From the **Copper** main menu **Test Groups**, select **Noise** test.
2. From the **Tests** menu, select **NEXT** test.
3. Tap **Spot** tab for which you want to set the parameter values.
4. Tap **Edit Parameter** button to open the **Test Parameter** page.
5. Set the parameter values as required.
6. Tap **Close** to confirm and exit the page.

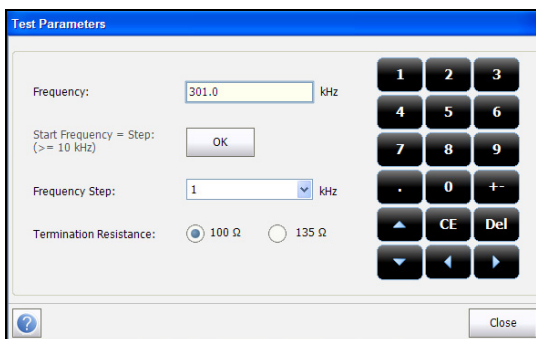

The page displays the following parameters:

- **Frequency** allows you to set the frequency value for the Near End Crosstalk (NEXT).
- **Start Frequency = Step: (>= 10 kHz)** **OK** button automatically enters/transfers the **Frequency Step** value into the **Frequency** value.
- **Frequency Step** lists a choice of frequency step values.
- **Termination Resistance** allows you to select either **100 Ω** or **135 Ω**.

Noise Tests

NEXT

Note: The Frequency values can be increased or decreased by tapping in the Frequency box, then tapping/pressing the up or down arrows on either the on-screen keyboard or FTB-1 keypad.

Setting Spot Test Thresholds

The **Test Thresholds** page allows you to set the **Spot Mode Thresholds**.

To set the Threshold values:

1. From the **Copper** main menu **Test Groups**, select **Noise** test.
2. From the **Tests** menu, select **NEXT** test.
3. Tap **Spot** tab.
4. Tap **Edit Thresholds** button to open the **Test Thresholds** page.
5. Set the threshold values as required.
6. Tap **Close** to confirm and exit the page.

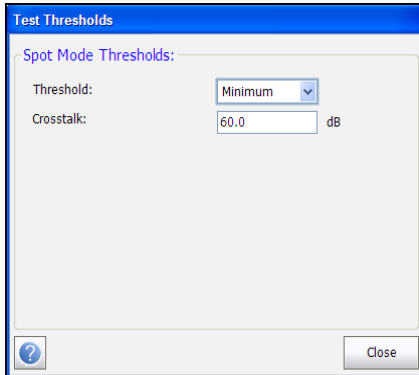

The page allows you to set the following parameters:

- **Threshold** is the threshold limit for each pair: **Maximum**, **Minimum**, or **None** which disables the threshold. In this case, the pass/fail status indicator will not be displayed.
- **Crosstalk** allows you to set the NEXT threshold value.

Spectrum

Spectrum is a snapshot mode of operation similar to **WB Attenuation**. The test makes one measurement of the near end crosstalk (NEXT) at fixed and periodic frequencies, and then stops. The frequency steps depend on the selected bandwidth selected in the **Test Parameters**.

To access the **Spectrum** page:

1. From the **Copper** main menu **Test Groups**, select **Noise** test.
2. From the **Tests** menu, select **NEXT** test to start the test.
3. Select the **Spectrum** tab.

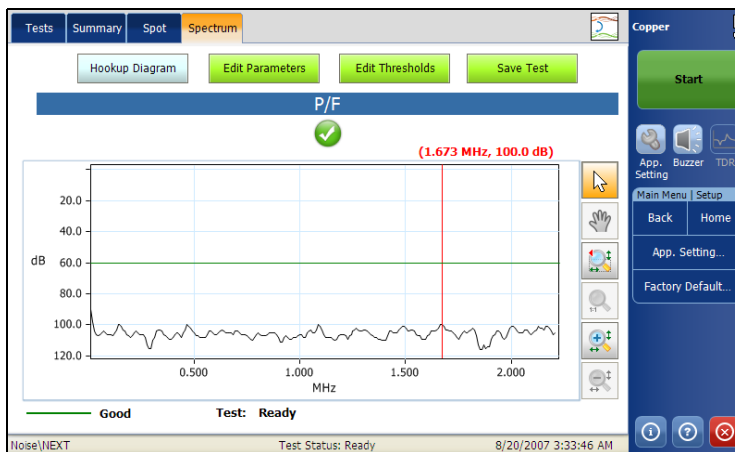

The page allows you to view and set the following parameters:

- **Hookup Diagram** button opens a **Confirmation** window displaying how to connect your cables.
- **Edit Parameters** button opens a new page that allows you to set the test parameters.
- **Edit Thresholds** button opens a new page that allows you to set the **Spectrum Mode Thresholds**.

Noise Tests

NEXT

- **Save Test** button opens a new page that allows you to save a snapshot of test results into a result file. Refer *Save Test* on page 74 for more information.

Setting Spectrum Test Parameters

The **Test Parameters** page allows you to set the parameter values for the test.

To set the Parameter values:

1. From the **Copper** main menu **Test Groups**, select **Noise** test.
2. From the **Tests** menu, select **NEXT** test.
3. Tap **Spectrum** tab for which you want to set the parameter values.
4. Tap **Edit Parameter** button to open the **Test Parameters** page.
5. Set the parameter values as required.
6. Tap **Close** to confirm and exit the page.

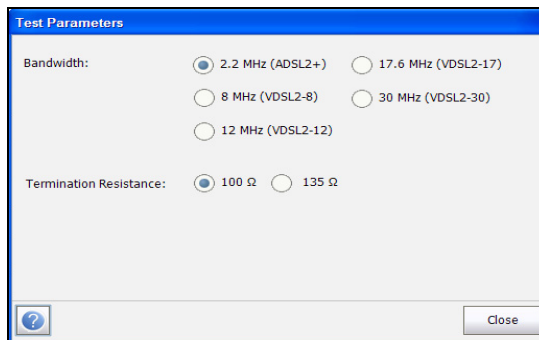

The page displays the following parameters:

- **Bandwidth** allows you to select the bandwidth of the frequency range for the test. Available frequency bandwidths are: **2.2 MHz**, **8 MHz**, **12 MHz**, **17.6 MHz**, and **30 MHz**.
- **Termination Resistance** allows you to select either **100 Ω** or **135 Ω**.

Setting Spectrum Test Thresholds

The **Test Thresholds** page allows you to set the **Spectrum Mode Thresholds**.

To set the Threshold values:

1. From the **Copper** main menu **Test Groups**, select **Noise** test.
2. From the **Tests** menu, select **NEXT** test.
3. Tap **Spectrum** tab.
4. Tap **Edit Thresholds** button to open the **Test Thresholds** page.
5. Set the threshold values as required.
6. Tap **Close** to confirm and exit the page.

Spectrum Mode Thresholds:	
Threshold:	Minimum
Crosstalk (ADSL/2+) :	60.0 dB
Threshold:	Minimum
Crosstalk (VDSL2-8) :	55.0 dB
Threshold:	Minimum
Crosstalk (VDSL2-12) :	50.0 dB
Threshold:	Minimum
Crosstalk (VDSL2-17) :	50.0 dB
Threshold:	Minimum
Crosstalk (VDSL2-30) :	45.0 dB

The page allows you to set the following parameters:

- **Threshold** is the threshold limit for each pair: **Maximum**, **Minimum**, or **None** which disables the threshold. In this case, the pass/fail status indicator will not be displayed.
- **Crosstalk** allows you to edit the NEXT threshold values for all bandwidths.

Summary

Summary tab displays the pass/fail status of the tests executed. Refer to *Copper Tests: Result Summary* on page 291 for more information.

16 *Impulse Tests*

The purpose of the impulse tests is to count, view, capture, and analyze VF and Wideband impulse noise events on the line under test. Use the **VF Impulse Noise** and **WB Impulse Noise** tests to count impulse events over time that exceed the configured noise level threshold.

The **Impulse Scope** displays and captures impulse noises in the time domain so you can analyze impulse duration and frequency. Both continuous and capture/trigger modes are provided.

The **Impulse Duration** and **Disruption (IDD)** tests capture and show the distribution and accumulation of impulse noise durations over time in a histogram.

To access Impulse tests:

From the **Copper** main menu **Test Groups**, select **Impulse** test.

Impulse Main Page

The **Impulse** menu allows you to select and run the displayed tests:

- **VF Impulse Noise**
- **WB Impulse Noise**
- **Impulse Scope**
- **Impulse Duration**

Impulse Tests

Impulse Main Page

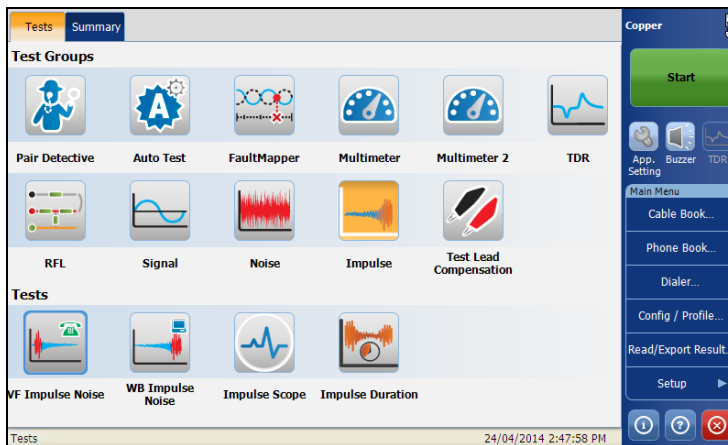

To start/stop a test:

- 1.** From the **Copper** main menu **Test Groups**, select **Impulse** test.
- 2.** From the **Tests** menu, select the test to run.

VF Impulse Noise Test

The **VF Impulse Noise** test allows you to measure voice frequency impulse noise on the circuit under test. The test counts and compares the number of short duration impulse noise spikes exceeding the threshold counters in the voice band to quickly understand the impulse rate affecting the circuit.

VF Impulse

The **VF Impulse** function displays and updates results in *real time*, for the length of time set in **Test Duration** or less if you stop the test. The last valid results then remain displayed.

To access VF Impulse page:

1. From the **Copper** main menu **Test Groups**, select **Impulse** test.
2. From the **Tests** menu, select **VF Impulse Noise** test to start the test.

By default, the **VF Impulse** page opens.

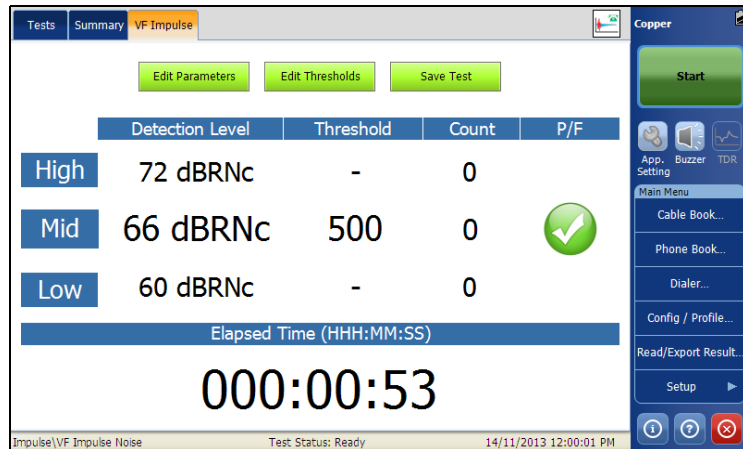

The current group and the current test which is being measured is displayed in the status bar, for example **Impulse\VF Impulse Noise**.

Impulse Tests

VF Impulse Noise Test

The page displays the following parameters:

- **Edit Parameters** button opens a new page that allows you to set the **VF Impulse** parameters.
- **Edit Thresholds** button opens a new page that allows you to set the **VF Impulse** thresholds.
- **Save Test button** opens a new page that allows you to save a snapshot of test results into a result file. Refer *Save Test* on page 74 for more information.

Setting Test Parameters

The **Test Parameters** page allows you to set the **VF Impulse** test parameters.

To set parameter values:

1. From the **Copper** main menu **Test Groups**, tap **Noise test**.
2. From the **Tests** menu, tap **VF Impulse Noise test**.
3. Tap **Edit Parameters** button to open the **Test Parameters** page.
4. Set the parameter values as required.
5. Tap **Close** to confirm and close the page.

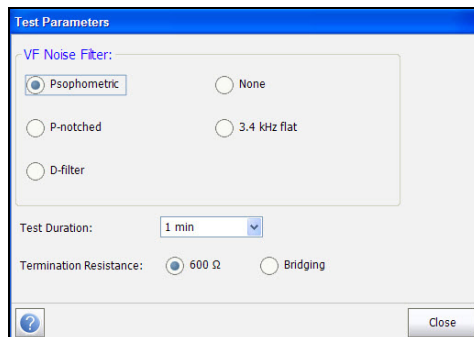

The page allows you to set the following parameters:

- **VF Noise filter** allows you to define the voice frequency noise filter to be used, dependent on **ITU** or **ANSI Standard** mode.
- **Test Duration** allows you to set the length of time to run the test from a list of values.
- **Termination Resistance** allows you to define the resistance of the dummy load connected to the line, by selecting either **600 Ω** or **Bridging** (100 kΩ).

Setting Threshold Values

The **Test Thresholds** page allows you to set the **VF Impulse Noise Threshold** values for the test.

To set the Threshold values:

- 1.** From the **Copper** main menu **Test Groups**, select **Noise** test.
- 2.** From the **Tests** menu, select **VF Impulse Noise** test.
- 3.** Tap **VF Impulse** tab.
- 4.** Tap **Edit Thresholds** button to open the **Test Thresholds** page.
- 5.** Set the Threshold values as required.
- 6.** Tap **Close** to confirm and exit the page.

Impulse Tests

VF Impulse Noise Test

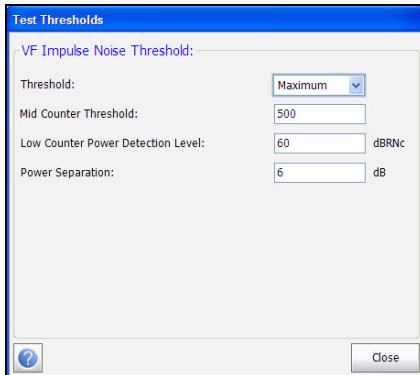

Test Thresholds

VF Impulse Noise Threshold:

Threshold: Maximum

Mid Counter Threshold: 500

Low Counter Power Detection Level: 60 dBmC

Power Separation: 6 dB

Close

The page allows you to set the following parameters:

- **Threshold** is the threshold limit for each pair: **Maximum**, **Minimum**, or **None**.
- **Mid Counter Threshold** allows you to set the threshold value for this counter.
- **Low Counter Power Detection Level** defines the low threshold limits for the impulse noise test.
- **Power Separation** defines the level difference between the **Low**, **Mid**, and **High** thresholds. Specify a value between 1 and 6 dB.

Summary

Summary tab displays the pass/fail status of the tests executed. Refer *Copper Tests: Result Summary* on page 291 for more information.

WB Impulse Noise Test

WB Impulse Noise test allows you to measure impulse noise on the circuit under test. The test counter counts noise spikes above thresholds across a wide frequency spectrum, providing a good picture of the rate of impulse noise (hits) upon the circuit under test. Because the counter does not identify the sources, use the impulse noise scope and impulse duration and disruption test to capture and analyze them, and determine their characteristics. The **WB Impulse Noise** test may be run over long time periods to assess time of day challenges not experienced during repair times.

WB Count

The **Count** function displays and updates results in *real time*, for the length of time set in **Test Duration** or less if you stop the test. The last valid results then remain displayed. The page also displays the **Detection Level, Count, Elapsed Time**, and pass/fail status which is periodically refreshed, until you stop the test.

To access WB Count page:

- 1.** From the **Copper** main menu **Test Groups**, select **Impulse** test.
- 2.** From the **Tests** menu, select **WB Impulse Noise** to start the test.

By default, the **WB Count** page opens.

Impulse Tests

WB Impulse Noise Test

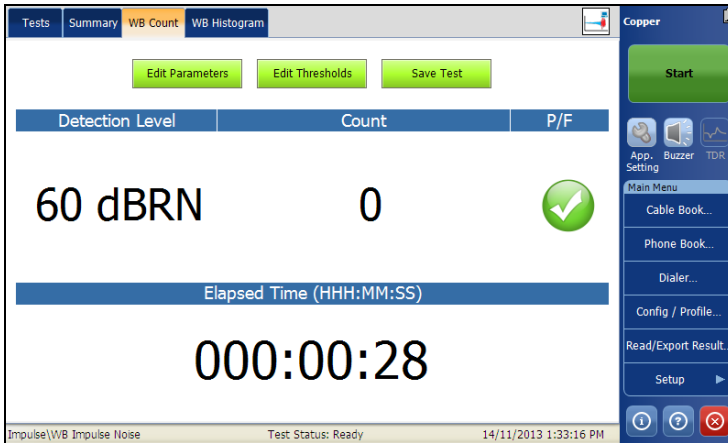

The page displays the following parameters:

- **Edit Parameters** button opens a new page that allows you to set the test parameters.
- **Edit Thresholds** button opens a new page that allows you to set the test thresholds.
- **Save Test** button opens a new page that allows you to save a snapshot of test results into a result file. Refer *Save Test* on page 74 for more information.

Setting Test Parameters

The **Test Parameters** page allows you to set either the **WB Count** or **WB Histogram** test parameters, depending which tab is open.

To set the parameter values:

1. From either the **WB Count** or **WB Histogram** tab, click the **Edit Parameters** button to open the **Test Parameters** page.
2. Set the parameter values as required.
3. Tap **Close** to confirm and exit the page.

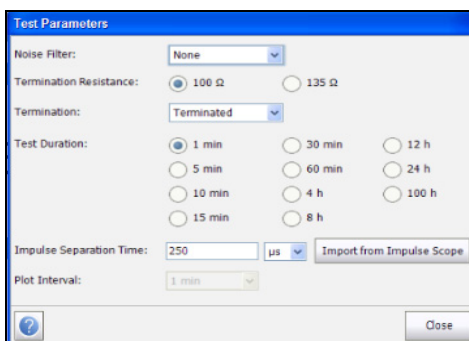

The page allows you to set the following parameters:

- **Noise Filter** lists the filter currently enabled. Options are: **None**, **ISDN-E**, **HDSL-F**, **ADSL-G**, **ADSL**, **ADSL2+**, **VDSL**, **VDSL2-8**, **VDSL2-12**, **VDSL2-17**, **VDSL2-30**.
- **Termination Resistance** allows you to define the resistance of the dummy load connected to the line.
- **Termination** is either **Terminated**, if the termination resistance is internal to the unit, or **Bridging** if additional termination resistance is used to *bridge* onto live circuits with minimal interruption.
- **Test Duration** allows you to set the length of time to run the test from a selection of values.

Impulse Tests

WB Impulse Noise Test

- **Impulse Separation Time** defines the shortest time between consecutive discrete impulses, and is used for centering the impulse on the graph. This separation time also defines the largest allowable gap between threshold events within a single impulse.
- **Import from Impulse Scope** button allows you to import the **Impulse Separation Time** value from **Impulse Scope**.
- **Plot Interval** allows you to define the time period to display the impulse noise spikes on the graph.

Setting Threshold Values

The **Test Thresholds** page allows you to set the **WB Impulse Noise Threshold** values for the test.

To set the threshold values:

1. From either the **WB Count** or **WB Histogram** tab, tap the **Edit Thresholds** button to open the **Test Thresholds** page.
2. Set the threshold values as required.
3. Tap **Close** to confirm and close the page.

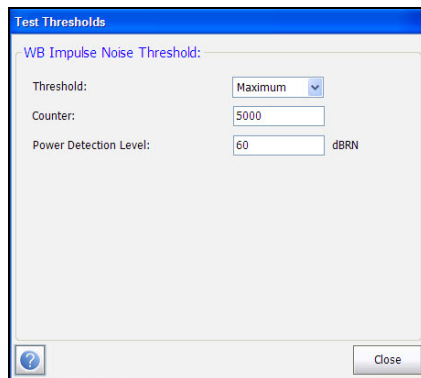

The page allows you to set the following parameters:

- **Threshold** is the threshold limit for each pair: **Maximum, Minimum, or None.**
- **Counter** allows you to set the threshold value for this counter.
- **Power Detection Level** defines the threshold limits.

Impulse Tests

WB Impulse Noise Test

WB Histogram

The wideband impulse noise histogram test displays a plot of the impulse noise spikes over a user-defined time period.

To access WB Histogram page:

1. From the **Copper** main menu **Test Groups**, tap **Noise** test.
2. From the **Tests** menu, tap **WB Impulse Noise** icon to start the test.
By default, the **WB Count** page opens.
3. Tap the **WB Histogram** tab to view the graph.
4. Use the graph controls to maneuver the graph. Refer to *Graph Controls* on page 19 for more information.

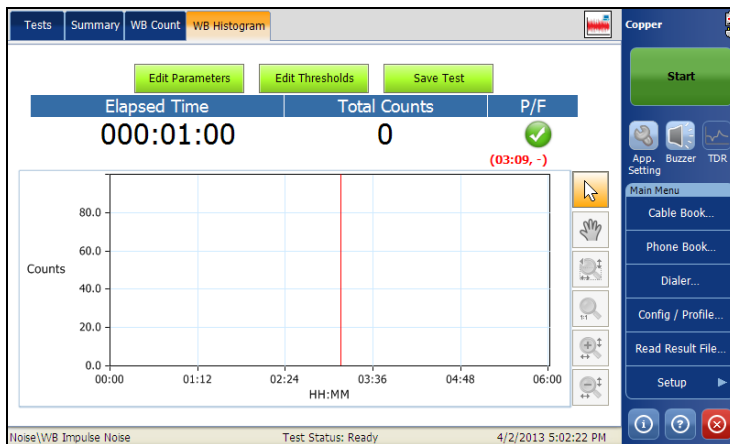

Summary

Summary tab displays the pass/fail status of the tests executed. Refer to *Copper Tests: Result Summary* on page 291 for more information

Impulse Scope Test

The **Impulse Scope** is an oscilloscope mode which displays and captures the duration and frequencies of multiple impulse events.

Impulse Scope

The **Impulse Scope** function displays and updates results in *real time*, for the length of time set in **Test Duration** or less, if you stop the test. The last valid results then remain displayed.

To access Impulse Scope page:

1. From the **Copper** main menu **Test Groups**, select **Impulse** test.
2. From the **Tests** menu, select **Impulse Scope** to open the page and start the test.
3. Use the graph controls to maneuver the graph. Refer to *Graph Controls* on page 19 for more information, except for Toggle , see below.



Impulse Tests

Impulse Scope Test

The page opens to the time-domain graph by default, with the frequency domain graph insert, and displays the following parameters:

- **Edit Parameters** button opens a new page that allows you to set the test parameters.
- **Edit Thresholds** button opens a new page that allows you to set the **Impulse Scope Threshold**.
- **Graph Settings** button opens a new page that allows you to set parameters for the **Impulse Scope** main graph and graph insert. Here, you may also disable the graph insert, and choose to view either the time or frequency domain graph.
- **Save Test** button opens a new page that allows you to save a snapshot of test results into a result file. Refer to *Save Test* on page 74 for more information.
- **Voltage Threshold** determines when impulse events are displayed or captured (trigger level) based on the Peak voltage level of the event(s). The **Voltage Detection Level**, set in the **Threshold** page above, is displayed.
- **Capture Window** provides a drop-down list that allows you to select the x-axis display window width.
- **IST** (Impulse Separation Time) specifies the time interval between successive impulses. Some impulse events comprise many sub-pulses or a pulse-train. Use a larger IST to capture longer events of many sub-pulses, or a smaller IST between events to capture fast sub-pulses as separate impulse events.
- Toggle  graph control icon allows you to switch between graphs on the page, making the graph insert larger and the main graph into the graph insert. You can also double tap the small windows to toggle between large and small graphs.

Setting Test Parameters

The **Test Parameters** page allows you to set the **Impulse Scope** test parameters.

To set the Parameter values:

1. From the **Copper** main menu **Test Groups**, tap **Impulse** test.
2. From the **Tests** menu, tap **Impulse Scope** test.
3. Tap **Edit Parameters** button to open the **Test Parameters** page.
4. Set the parameter values as required.
5. Tap **Close** to confirm and exit the page.

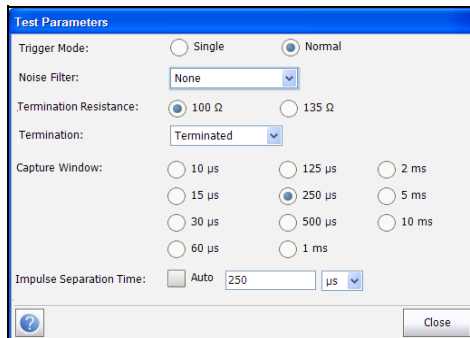

The page allows you to set the following parameters:

- **Trigger Mode** is either **Single** (one-shot/snapshot) or **Normal** (continuous/constantly re-triggered). The test (either **Single** or **Normal**) is triggered by the first impulse that reaches the test threshold (either +/- threshold value).
- **Noise Filter** defines the filter currently enabled. Options are: **None**, **ISDN-E**, **HDSL-F**, **ADSL-G**, **ADSL**, **ADSL2+**, **VDSL**, **VDSL2-8**, **VDSL2-12**, **VDSL2-17**, **VDSL2-30**.
- **Termination Resistance** allows you to define the resistance of the dummy load connected to the line.

Impulse Tests

Impulse Scope Test

- **Termination** is either **Terminated**, if the termination resistance is internal to the unit, or **Bridging** if additional termination resistance is used to *bridge* onto live circuits with minimal interruption.
- **Capture Window** provides the graph plot interval time and defines the size of the displayed time domain graph. However, 10 msec of data is always stored independent of the capture window size. This enables you to zoom-out to 10 ms for any **Capture Window** size.
- **Impulse Separation Time** defines the shortest time between consecutive discrete impulses, and is used for centering the impulse on the graph. This separation time also defines the largest allowable gap between threshold events within a single impulse. When set to **Auto**, the **Capture Window** value is used.

Setting Threshold Values

The **Threshold** page allows you to set the **Impulse Scope Threshold** for the test.

To access the Threshold page:

1. From the **Copper** main menu **Test Groups**, select **Impulse** test.
2. From the **Tests** menu, select **Impulse Scope** test.
3. Tap **Edit Thresholds** button to open the **Threshold** page.
4. Set the threshold as required.
5. Tap **Close** to confirm and exit the page.

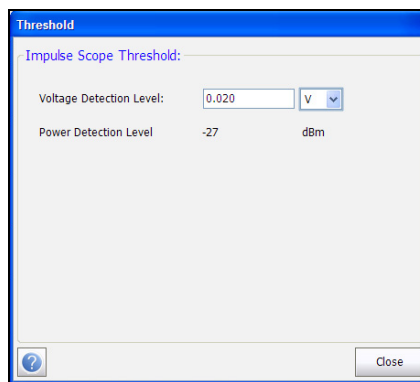

The following parameters are displayed:

- The **Voltage Detection Level** allows you to set the test threshold in either V or mV. The threshold can be changed when the test is running but will be applied to the next trigger event.
- **Power Detection Level** is read only, allowing you to view the test threshold limit.

Impulse Tests

Impulse Scope Test

Graph Settings

The **Graph Settings** page allows you to set parameters for the **Impulse Scope** main graph and graph insert.

To select the Graph settings:

1. From the **Copper** main menu **Test Groups**, select **Impulse** test.
2. From the **Tests** menu, select **Impulse Scope** test.
3. Tap **Graph Settings** button to open the page.
4. Select the settings as required.
5. Tap **Close** to confirm and exit the page.

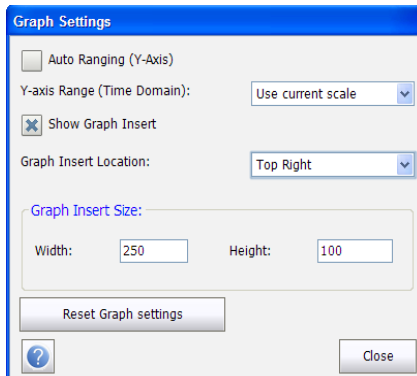

The screenshot shows a dialog box titled "Graph Settings" with a blue header. It contains the following controls:

- An unchecked checkbox labeled "Auto Ranging (Y-Axis)".
- A label "Y-axis Range (Time Domain):" followed by a dropdown menu showing "Use current scale".
- A checked checkbox labeled "Show Graph Insert".
- A label "Graph Insert Location:" followed by a dropdown menu showing "Top Right".
- A section titled "Graph Insert Size:" containing two input fields: "Width" with the value "250" and "Height" with the value "100".
- A "Reset Graph settings" button.
- A question mark icon in a circle at the bottom left.
- A "Close" button at the bottom right.

The page allows you to set the following parameters:

- **Auto Ranging (Y-Axis)** can be selected to make the y-axis (voltage) dynamic, that is, scaled to fit the largest impulse height, for both trigger modes.
- **Y-axis Range (Time Domain)** is a pull-down list, when **Auto Ranging** is turned off, allowing you to select a y-axis scale. Default is **Use current scale**. If a previous/current scale is not available, for example when first using the test, then the y-axis scale is set to **-10 to +10 V**, however, the pull-down selection displays **Use current scale**.
- **Show Graph Insert** allows you to remove the graph insert, when *not* selected.
- **Graph Insert Location** allows you to select where the graph insert is placed on the page:
 - Top Left/Right
 - Bottom Left/Right
- **Graph Insert Size** allows you to specify the **Width** and **Height** of the graph insert.
 - **Width** value should be in the range of 250 to 400. Default is 250.
 - **Height** value should be in the range of 100 to 150. Default is 100.
- **Reset Graph Settings** button restores the page to the default settings.

Summary

Summary tab displays the pass/fail status of the tests executed. Refer to *Copper Tests: Result Summary* on page 291 for more information.

Impulse Duration

The **Impulse Duration** is a histogram displaying the distribution of different captured impulse durations (widths) over a period of time. This is very useful if different types of impulse noises are occurring at different times. It also provides a **Disruption** graph showing the total accumulated durations of impulse events over a period of time.

Impulse Duration

On the **Impulse Duration** page, the test histogram plots impulse **Counts** (y-axis) vs. **Impulse Duration** (x-axis), showing the distribution of different duration impulses over time. This is key to understand when short events such as REIN occur, versus longer events (PEIN) or short high impulse noise events (SHINE). The page also records the **Elapsed Time**, **Total Counts**, and pass/fail status. The test displays and updates results in *real time*, for the length of time set in **Test Duration** or less, if you stop the test. The last valid results then remain displayed.

To access the Impulse Duration page:

- 1.** From the **Copper** main menu **Test Groups**, select **Impulse** test.
- 2.** From the **Tests** menu, select **Impulse Duration** to open the page and start the test.
- 3.** Use the graph controls to maneuver the graph. Refer to *Graph Controls* on page 19 for more information.

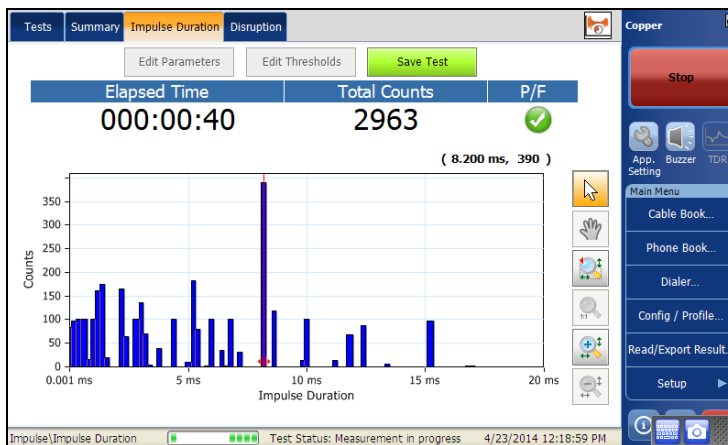

The page opens to the histogram indicating how many impulses have been detected for the **Impulse Duration** interval. The following parameters are displayed:

- **Edit Parameters** button opens a new page that allows you to set the test parameters.
- **Edit Thresholds** button opens a new page that allows you to set the **Impulse Duration** and **Counter** thresholds.
- **Save Test** button opens a new page that allows you to save a snapshot of test results into a result file. Refer to *Save Test* on page 74 for more information.

Impulse Tests

Impulse Duration

Disruption

On the **Disruption** page, the test histogram plots **Disruption** (y-axis) vs. **Minutes** (x-axis), that is the amount of time each minute (depending on plot interval) was disrupted by impulse events. The page also records the **Elapsed Time**, **Total Disruption**, and pass/fail status. The test displays and updates results in *real time*, for the length of time set in **Test Duration** or less, if you stop the test. The last valid results then remain displayed.

To access the Disruption page:

1. From the **Copper** main menu **Test Groups**, select **Impulse** test.
2. From the **Tests** menu, select **Impulse Duration** to open the page, then tap the **Disruption** tab to start the test.
3. Use the graph controls to maneuver the graph. Refer to *Graph Controls* on page 19 for more information.



The page opens to the histogram indicating how many disruptions have been detected for the **Impulse Duration** interval. The following parameters are displayed:

- **Edit Parameters** button opens a new page that allows you to set the test parameters.
- **Edit Thresholds** button opens a new page that allows you to set the **Impulse Duration** and **Counter** thresholds.
- **Save Test** button opens a new page that allows you to save a snapshot of test results into a result file. Refer to *Save Test* on page 74 for more information.

Impulse Tests

Impulse Duration

Setting Test Parameters

The **Test Parameters** page allows you to set either the **Impulse Duration** or **Disruption** test parameters, depending which tab is open.

To set the parameter values:

1. From either the **Impulse Duration** or **Disruption** tab, click the **Edit Parameters** button to open the **Test Parameters** page.
2. Set the parameter values as required.
3. Tap **Close** to confirm and exit the page.

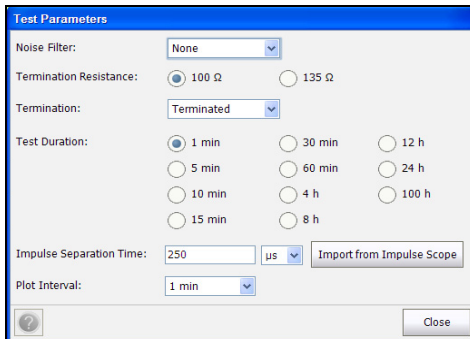

The page allows you to set the following parameters:

- **Noise Filter** defines the filter currently enabled. Options are: **None**, **ISDN-E**, **HDSL-F**, **ADSL-G**, **ADSL**, **ADSL2+**, **VDSL**, **VDSL2-8**, **VDSL2-12**, **VDSL2-17**, **VDSL2-30**.
- **Termination Resistance** allows you to define the resistance of the dummy load connected to the line.
- **Termination** is either **Terminated**, if the termination resistance is internal to the unit, or **Bridging** if the termination resistance is external.
- **Test Duration** allows you to set the length of time to run the test from a list of values.

- **Impulse Separation Time** defines the shortest time between consecutive discrete impulses, and is used for centering the impulse on the graph. This separation time also defines the largest allowable gap between threshold events within a single impulse.
- **Import from Impulse Scope** button allows you to import the **Impulse Separation Time** value from **Impulse Scope**.
- **Plot Interval** is only enabled in the **Disruption** tab and allows you to define the time period to display the impulse noise bars on the graph. The **Disruption** histogram shows the sum of impulse durations that are collected during each plot interval (bar).

Setting Threshold Values

The **Threshold** page allows you to set the **Impulse Duration Threshold** for the test.

To set the threshold values:

1. From either the **Impulse Duration** or **Disruption** tab, tap the **Edit Thresholds** button to open the **Threshold** page.
2. Set the thresholds as required.
3. Tap **Close** to confirm and exit the page.

Threshold

Impulse Duration Threshold:

Power Detection Level: dBm

Voltage Detection Level: mV

Total Count Threshold:

Threshold:

Total Counts:

Total Disruption Threshold:

Threshold:

Total Disruption: ms

Impulse Tests

Impulse Duration

The page allows you to set the following parameters:

- **Impulse Duration Threshold:**
 - **Power Detection Level** allows you to set the test threshold limit.
 - **Voltage Detection Level** is read-only and calculated from the **Power Detection Level**.
 - **Import Detection Level from Impulse Scope** button allows you to import the power and voltage detection values from the **Impulse Scope** test.
- **Total Count/Disruption Threshold:**
 - **Threshold** is the counts/disruption threshold limit: **Maximum**, **Minimum**, **None**.
 - **Total Counts/Disruption** define the threshold values for either the number of total counts during the impulse noise duration or the number of total disruptions.

Summary

Summary tab displays the pass/fail status of the tests executed. Refer to *Copper Tests: Result Summary* on page 291 for more information.

17 Test Lead Compensation

Test lead compensation is required for some of the copper tests so as not to affect data accuracy, since test lead characteristics have some impact on copper test results (mainly resistance, capacitance, and TDR tests). Test lead characteristics vary with respect to cable temperature.

The **Test Lead Compensation** routine allows you to perform resistance and capacitance compensation. The page displays the **Pass/Fail** status of the last compensation done.

Note: For greatest accuracy, perform a test lead compensation before a new test session with the FTB-1 unit.

To access Test Lead Compensation:

1. From the **Copper** main menu **Test Groups**, select **Test Lead Compensation**.
2. From the **Tests** menu, select **Test Lead Compensation**.

By default, the **Test Lead Compensation** page opens.

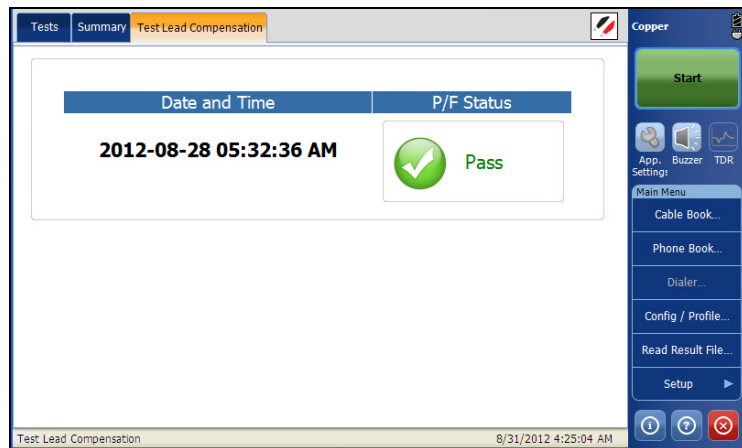

Test Lead Compensation

Summary

The page displays the following parameters:

- **Date and Time** identifies when the last compensation was done or application installation time.
- **Start Compensation** button allows you to start the **Test Lead Compensation** by overwriting the current test lead characteristics.

Summary

Summary tab displays the pass/fail status of the tests executed. Refer *Copper Tests: Result Summary* on page 291 for more information.

18 Copper Tests: Result Summary

Summary

The **Summary** tab displays the name of the executed test, date and time the test was last executed, and pass/fail status of the test.

To access Summary Page:

1. From the **Copper** main menu **Test Groups**, select the test.
2. From the **Tests** menu, select the test to run.
3. Select the **Summary** tab to view the summary page.

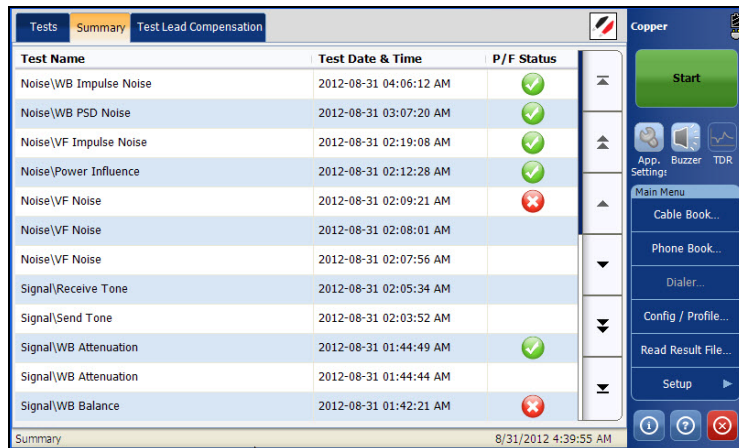

The screenshot shows the 'Summary' tab of the Copper test interface. It features a table with three columns: 'Test Name', 'Test Date & Time', and 'P/F Status'. The table lists various tests such as 'Noise\WB Impulse Noise', 'Noise\VF Impulse Noise', and 'Signal\Receive Tone'. The 'P/F Status' column uses green checkmarks for pass and red 'X' marks for fail. A right-hand sidebar contains a 'Start' button and a 'Main Menu' section with options like 'Cable Book...', 'Phone Book...', and 'Setup'. The bottom status bar shows 'Summary' and the date/time '8/31/2012 4:39:55 AM'.

Test Name	Test Date & Time	P/F Status
Noise\WB Impulse Noise	2012-08-31 04:06:12 AM	✓
Noise\WB PSD Noise	2012-08-31 03:07:20 AM	✓
Noise\VF Impulse Noise	2012-08-31 02:19:08 AM	✓
Noise\Power Influence	2012-08-31 02:12:28 AM	✓
Noise\VF Noise	2012-08-31 02:09:21 AM	✗
Noise\VF Noise	2012-08-31 02:08:01 AM	
Noise\VF Noise	2012-08-31 02:07:56 AM	
Signal\Receive Tone	2012-08-31 02:05:34 AM	
Signal\Send Tone	2012-08-31 02:03:52 AM	
Signal\WB Attenuation	2012-08-31 01:44:49 AM	✓
Signal\WB Attenuation	2012-08-31 01:44:44 AM	
Signal\WB Balance	2012-08-31 01:42:21 AM	✗

The page displays the following fields:

- **Test Name** displays the name of the tests executed.
- **Test Date & Time** displays the date and time the test was executed.
- **P/F Status** displays the pass/fail status of the test.

19 *Maintenance*

To help ensure long, trouble-free operation:

- Always inspect fiber-optic connectors before using them and clean them if necessary.
- Keep the unit free of dust.
- Clean the unit casing and front panel with a cloth slightly dampened with water.
- Store unit at room temperature in a clean and dry area. Keep the unit out of direct sunlight.
- Avoid high humidity or significant temperature fluctuations.
- Avoid unnecessary shocks and vibrations.
- If any liquids are spilled on or into the unit, turn off the power immediately, disconnect from any external power source, remove the batteries and let the unit dry completely.



WARNING

The use of controls, adjustments and procedures, namely for operation and maintenance, other than those specified herein may result in hazardous radiation exposure or impair the protection provided by this unit.

Recalibrating the Unit

EXFO manufacturing and service center calibrations are based on the ISO/IEC 17025 standard (*General Requirements for the Competence of Testing and Calibration Laboratories*). This standard states that calibration documents must not contain a calibration interval and that the user is responsible for determining the re-calibration date according to the actual use of the instrument.

The validity of specifications depends on operating conditions. For example, the calibration validity period can be longer or shorter depending on the intensity of use, environmental conditions and unit maintenance, as well as the specific requirements for your application. All of these elements must be taken into consideration when determining the appropriate calibration interval of this particular EXFO unit.

Under normal use, the recommended interval for your FTB-610 Advanced WB Copper Test Module is: 2 years.

For newly delivered units, EXFO has determined that the storage of this product for up to six months between calibration and shipment does not affect its performance (EXFO Policy PL-03).

To help you with calibration follow-up, EXFO provides a special calibration label that complies with the ISO/IEC 17025 standard and indicates the unit calibration date and provides space to indicate the due date. Unless you have already established a specific calibration interval based on your own empirical data and requirements, EXFO would recommend that the next calibration date be established according to the following equation:

Next calibration date = Date of first usage (if less than six months after the calibration date) + Recommended calibration period (2 years)

To ensure that your unit conforms to the published specifications, calibration may be carried out at an EXFO service center or, depending on the product, at one of EXFO's certified service centers. Calibrations at EXFO are performed using standards traceable to national metrology institutes.

Note: *You may have purchased a FlexCare plan that covers calibrations. See the Service and Repairs section of this user documentation for more information on how to contact the service centers and to see if your plan qualifies.*

Recycling and Disposal (Applies to European Union Only)

For complete recycling/disposal information as per European Directive WEEE 2002/96/EC, visit the EXFO Web site at www.exfo.com/recycle.

20 *Troubleshooting*

Solving Common Problems

Before calling EXFO's technical support, please read the following common problems that can occur and their respective solution.

Problem	Possible Cause	Solution
Unit does not turn on.	Battery is discharged.	<ul style="list-style-type: none">➤ Charge the battery.➤ Replace the battery with a fully charged one.➤ Connect the unit to an external power supply using the AC adapter/charger.
	Unit is not connected to an external power supply.	Connect the unit to an external power supply using the AC adapter/charger.
	External power supply is disconnected.	Make sure the external power supply is connected at both ends.
Unit screen is dark.	Unit's backlight is off.	Tap the backlight button.
	Battery is discharged and unit has shut down.	<ul style="list-style-type: none">➤ Charge the battery.➤ Replace the battery with a fully charged one.➤ Connect the unit to an external power supply using the AC adapter/charger.
	Unit is in suspend or hibernate mode.	Press power button momentarily.

Troubleshooting

Solving Common Problems

Problem	Possible Cause	Solution
At logon, no scroll bar is displayed to browse through all user accounts.	---	<ul style="list-style-type: none">➤ Select any of the user accounts that you can see on screen, and then press the down arrow (from the unit's keypad) to go to the next account.➤ User the up/down arrows to browse through the accounts.

Contacting the Technical Support Group

To obtain after-sales service or technical support for this product, contact EXFO at one of the following numbers. The Technical Support Group is available to take your calls from Monday to Friday, 8:00 a.m. to 7:00 p.m. (Eastern Time in North America).

Technical Support Group

400 Godin Avenue
Quebec (Quebec) G1M 2K2
CANADA

1 866 683-0155 (USA and Canada)
Tel.: 1 418 683-5498
Fax: 1 418 683-9224
support@exfo.com

For detailed information about technical support, and for a list of other worldwide locations, visit the EXFO Web site at www.exfo.com.

If you have comments or suggestions about this user documentation, you can send them to customer.feedback.manual@exfo.com.

To accelerate the process, please have information such as the name and the serial number (see the product identification label), as well as a description of your problem, close at hand.

Transportation

Maintain a temperature range within specifications when transporting the unit. Transportation damage can occur from improper handling. The following steps are recommended to minimize the possibility of damage:

- Pack the unit in its original packing material when shipping.
- Avoid high humidity or large temperature fluctuations.
- Keep the unit out of direct sunlight.
- Avoid unnecessary shocks and vibrations.

21 Warranty

General Information

one year (EXFO) warrants this equipment against defects in material and workmanship for a period of one year from the date of original shipment. EXFO also warrants that this equipment will meet applicable specifications under normal use.

During the warranty period, EXFO will, at its discretion, repair, replace, or issue credit for any defective product, as well as verify and adjust the product free of charge should the equipment need to be repaired or if the original calibration is erroneous. If the equipment is sent back for verification of calibration during the warranty period and found to meet all published specifications, EXFO will charge standard calibration fees.



IMPORTANT

The warranty can become null and void if:

- unit has been tampered with, repaired, or worked upon by unauthorized individuals or non-EXFO personnel.
- warranty sticker has been removed.
- case screws, other than those specified in this guide, have been removed.
- case has been opened, other than as explained in this guide.
- unit serial number has been altered, erased, or removed.
- unit has been misused, neglected, or damaged by accident.

THIS WARRANTY IS IN LIEU OF ALL OTHER WARRANTIES EXPRESSED, IMPLIED, OR STATUTORY, INCLUDING, BUT NOT LIMITED TO, THE IMPLIED WARRANTIES OF MERCHANTABILITY AND FITNESS FOR A PARTICULAR PURPOSE. IN NO EVENT SHALL EXFO BE LIABLE FOR SPECIAL, INCIDENTAL, OR CONSEQUENTIAL DAMAGES.

Warranty

Liability

Liability

EXFO shall not be liable for damages resulting from the use of the product, nor shall be responsible for any failure in the performance of other items to which the product is connected or the operation of any system of which the product may be a part.

EXFO shall not be liable for damages resulting from improper usage or unauthorized modification of the product, its accompanying accessories and software.

Exclusions

EXFO reserves the right to make changes in the design or construction of any of its products at any time without incurring obligation to make any changes whatsoever on units purchased. Accessories, including but not limited to fuses, pilot lamps, batteries and universal interfaces (EUI) used with EXFO products are not covered by this warranty.

This warranty excludes failure resulting from: improper use or installation, normal wear and tear, accident, abuse, neglect, fire, water, lightning or other acts of nature, causes external to the product or other factors beyond the control of EXFO.



IMPORTANT

In the case of products equipped with optical connectors, EXFO will charge a fee for replacing connectors that were damaged due to misuse or bad cleaning.

Certification

EXFO certifies that this equipment met its published specifications at the time of shipment from the factory.

Service and Repairs

EXFO commits to providing product service and repair for five years following the date of purchase.

To send any equipment for service or repair:

1. Call one of EXFO's authorized service centers (see *EXFO Service Centers Worldwide* on page 305). Support personnel will determine if the equipment requires service, repair, or calibration.
2. If equipment must be returned to EXFO or an authorized service center, support personnel will issue a Return Merchandise Authorization (RMA) number and provide an address for return.
3. If possible, back up your data before sending the unit for repair.
4. Pack the equipment in its original shipping material. Be sure to include a statement or report fully detailing the defect and the conditions under which it was observed.
5. Return the equipment, prepaid, to the address given to you by support personnel. Be sure to write the RMA number on the shipping slip. *EXFO will refuse and return any package that does not bear an RMA number.*

Note: *A test setup fee will apply to any returned unit that, after test, is found to meet the applicable specifications.*

After repair, the equipment will be returned with a repair report. If the equipment is not under warranty, you will be invoiced for the cost appearing on this report. EXFO will pay return-to-customer shipping costs for equipment under warranty. Shipping insurance is at your expense.

Routine recalibration is not included in any of the warranty plans. Since calibrations/verifications are not covered by the basic or extended warranties, you may elect to purchase FlexCare Calibration/Verification Packages for a definite period of time. Contact an authorized service center (see *EXFO Service Centers Worldwide* on page 305).

EXFO Service Centers Worldwide

If your product requires servicing, contact your nearest authorized service center.

EXFO Headquarters Service Center

400 Godin Avenue
Quebec (Quebec) G1M 2K2
CANADA

1 866 683-0155 (USA and Canada)
Tel.: 1 418 683-5498
Fax: 1 418 683-9224
support@exfo.com

EXFO Europe Service Center

Winchester House, School Lane
Chandlers Ford, Hampshire S053 4DG
ENGLAND

Tel.: +44 2380 246800
Fax: +44 2380 246801
support.europe@exfo.com

EXFO Telecom Equipment (Shenzhen) Ltd.

3rd Floor, Building 10,
Yu Sheng Industrial Park (Gu Shu
Crossing), No. 467,
National Highway 107,
Xixiang, Bao An District,
Shenzhen, China, 518126

Tel: +86 (755) 2955 3100
Fax: +86 (755) 2955 3101
support.asia@exfo.com

A Technical Specifications



IMPORTANT

The following technical specifications can change without notice. The information presented in this section is provided as a reference only. To obtain this product's most recent technical specifications, visit the EXFO Web site at www.exfo.com

COPPER SPECIFICATIONS ^{a, b, c}		
Transmitter characteristics		
Frequency range (200 Hz to 20 kHz)	Frequency resolution	1 Hz steps
	Frequency uncertainty (accuracy)	±50 ppm + 1 Hz
	Level range	-20 dBm to 0 dBm at 600 Ω
	Level resolution	0.1 dB
Frequency range (20 kHz to 2.2 MHz)	Level uncertainty (accuracy)	±1 dB
	Frequency resolution	1 kHz steps
	Frequency uncertainty (accuracy)	±50 ppm + 100 Hz
	Level range	-20 dBm to 0 dBm at 100 Ω
Frequency range (2.2 MHz to 17 MHz)	Level resolution	0.1 dB
	Level uncertainty (accuracy)	±1 dB
	Frequency resolution	1 kHz steps
	Frequency uncertainty (accuracy)	±50 ppm + 100 Hz
Frequency range (17 MHz to 30 MHz)	Level range	-20 dBm to 0 dBm at 100 Ω
	Level resolution	0.1 dB
	Level uncertainty (accuracy)	±1 dB
	Impedance	100 Ω, 120 Ω, 135 Ω, 150 Ω, 600 Ω
Receiver characteristics		
Reception frequency range	Reception frequency range	200 Hz to 20 kHz 20 kHz to 30 MHz
	Frequency uncertainty (accuracy)	±50 ppm + 1 digit
	VF reception level range	-90 dBm to 15 dBm at 600 Ω
	VF level uncertainty (accuracy)	200 Hz to 20 kHz -90 dBm to -50 dBm, uncertainty (accuracy) ±2 dB -50 dBm to 15 dBm, uncertainty (accuracy) ±1 dB
WB reception level range	WB reception level range	-80 dBm to 15 dBm at 100 Ω, 120 Ω, 135 Ω, 150 Ω
	WB level uncertainty (accuracy)	20 kHz to 2.2 MHz -80 dBm to -50 dBm, uncertainty (accuracy) ±2 dB -50 dBm to 15 dBm, uncertainty (accuracy) ±1 dB
Impedance	Impedance	2.2 MHz to 30 MHz -80 dBm to -50 dBm, uncertainty (accuracy) ±2 dB -50 dBm to 15 dBm, uncertainty (accuracy) ±1 dB
	Impedance	100 Ω, 120 Ω, 135 Ω, 150 Ω, 600 Ω
POTS dialer	DTMF	0 - 9, #, *
	Phonebook	25 entries
Digital multimeter (DMM)	Test type	Snapshot and continuous
	Impedance selection (for voltage measurement)	100 kΩ, 1 MΩ, 10 MΩ

Notes

- Subject to change without notice.
- Typical, at 23 °C ± 3 °C, on batteries, with no USB connection.
- Specifications based on 24 AWG (PE 0.5 mm) cabling.

Technical Specifications

COPPER SPECIFICATIONS ^{a, b, c} (continued)				
	Measurement	Range	Resolution	Uncertainty (accuracy)
	DC voltage	0 to 400 V	0.1 V for 0 to 99.9 V 1 V for 100 to 400 V	±(1 % + 0.5 VDC)
	AC voltage	0 to 280 Vrms	0.1 VAC for 0 to 99.9 VAC 1 VAC for 100 to 280 VAC	±(1 % + 0.5 VAC)
	Isolation resistance (stress/leakage)	0 to 1 GΩ, auto-ranging 1 kΩ to 99 MΩ 100 MΩ to 999 MΩ	Three digits	±(2 % + 1 digit) ±(5 % + 1 digit)
	Resistance	0 to 100 MΩ 0 to 999 Ω 1 kΩ to 100 MΩ	Three digits	±(1 % + 5 Ω) ±(2 % + 1 digit)
	Capacitance	0 nF to 2 μF	Four digits	±(2 % + 50 pF)
	DC current	0 to 110 mA	0.1 mA	±(2 % + 1 mA)
	AC current	0 to 110 mA	0.1 mA	±(2 % + 1 mA) ^d
	Station Ground	0 to 1 MΩ 0 to 999 Ω 1 kΩ to 1 MΩ	Up to three digits	±(1 % + 3 Ω) ±(2 % + 1 digit)
	Isolation resistance (stress/leakage) (continued)	Source	50 V to 500 V (current safely limited to 0.5 mA)	
		Soak timer	1 s to 59.9 min	
	VF noise measurement	Frequency range	200 Hz to 20 kHz	
		Level range	-90 dBm to 20 dBm	
		Resolution	0.1 dB	
		Uncertainty (accuracy)	-90 dBm to -50 dBm, uncertainty (accuracy) ±2 dB -50 dBm to 20 dBm, uncertainty (accuracy) ±1 dB	
		Filters	ITU: none, psophometric, P-notched, 3.4 kHz, D-filter, 15 kHz ANSI: none, C-message, C-notched, 3.4 kHz, D-filter, 15 kHz	
		Impedance	600 Ω	
	VF impulse noise	Low threshold	-40 dBm to 0 dBm, in 1 dB steps	
		Mid threshold	Low threshold plus separation	
		High threshold	Mid threshold plus separation	
		Test duration	Minutes: 1, 5, 10, 15, 30, 60 Hours: 4, 8, 12, 24, 100	
		Separation	1 dB to 6 dB, in 1 dB steps	
		Dead time	125 ms	
		Filters	None, 3 kHz flat, C-message, psophometric, notched and D-filter (IEEE 743-1995)	
		Counter	Maximum 999 for each threshold	
		Timer	1 min to 24 h, default is 15 min	
	Power influence (noise to ground)	Noise range	-60 dBm to 10 dBm	
		Uncertainty (accuracy)	-60 dBm to -50 dBm ± 2 dB -50 dBm to 10 dBm ± 1 dB	
		Graphical display	Third triplet harmonics to 20 kHz	
	VF longitudinal balance	Frequency	1004 Hz	
		Level range	0 dB to 100 dB	
		Level uncertainty (accuracy)	±1 dB	
		Impedance	600 Ω	
	Time-domain reflectometer (TDR)	Modes	Automatic, Manual, and Crosstalk (Xtalk) operation with location of most significant event(s)	
		Distance range	0 m to 6700 m (0 ft up to 22 000 ft) on 24 AWG (0.5 mm) cable	
		Pulse width	15 ns to 20 μs (automatic control)	
		Amplitude	7.5 V p-p on cable, 9 V p-p open circuit	
		Velocity of propagation (VOP)	0.40 to 0.99	
		Distance uncertainty (accuracy) ^e	±(0.5 m + 1 % x distance)	
		Units	Meters and feet	

Notes

- Subject to change without notice.
- Typical, at 23 °C ± 3 °C, on batteries, with no USB connection.
- Specifications based on 24 AWG (PE 0.5 mm) cabling.
- From 10 mA to 110 mA.
- Qualified up to 300 m (1000 ft) and does not include the uncertainty due to VOP.

COPPER SPECIFICATIONS ^{a,b,c} (continued)		
Load coil detection	Count	Up to 5
	Plot	Up to 10 kHz
	Distance range	Up to 8000 m (up to 27 000 ft)
Near End Crosstalk (NEXT)	Frequency Range	10 kHz to 30 MHz
	Level Range	0 to 90 dB
	Level Resolution	0.1 dB
	Level uncertainty (accuracy)	2.2 MHz: ± 2.0 dB, from 0 to 90 dB 8 MHz: ± 2.0 dB, from 0 to 85 dB 12 MHz: ± 2.0 dB, from 0 to 80 dB 17.6 MHz: ± 3.0 dB, from 0 to 80 dB 30 MHz: ± 3.0 dB, from 0 to 80 dB
	Terminations	100, 120, 135, 150 Ω
Power spectral density (PSD)	Test type	Continuous with peak-hold, disturber identification, spectral mask overlay, and bridging impedance features
	Vertical scale	15 dBm/Hz to -140 dBm/Hz or 20 dBm to -100 dBm
	Horizontal scale	4.3125 kHz to 17 MHz, in 4.3125 kHz steps or 8.625 kHz to 30 MHz, in 8.625 kHz steps
	Noise filters	None or E, F, G, ADSL, ADSL2+, VDSL, VDSL2-8, VDSL2-12, VDSL2-17 and VDSL2-30
Wideband impulse noise	Test type	Counter, count histogram, time and frequency scope, duration and disruption histogram (IDD)
	Counter, count histogram threshold	-60 dBm (30 dBrrn) to 0 dBm (90 dBrrn) in 1 dB steps
	Scope threshold	0.000 V to 7.000 V in 0.001 increments (0 V provides continuous triggering)
	IDD threshold	-60 dBm to 15 dBm
	Total impulse hit count	65 000 000
	Total impulse disruption time	65 000 000 ms
	Range	Scope: 10 μ s to 10 ms IDD: 1 μ s to 20 ms
	Test duration	Counter, histogram – minutes: 1, 5, 10, 15, 30 and 60 Counter, histogram – hours: 4, 8, 12, 24 and 100 Scope: continuous and capture/trigger modes
	Impulse separation time (IST)	1 μ s to 999 μ s
	Noise filters	None or E, F, G, ADSL, ADSL2+, VDSL, VDSL2-8, VDSL2-12, VDSL2-17 and VDSL2-30
Wideband longitudinal balance	Level scale	0 to 100 dB
	Level range uncertainty (accuracy)	2.2 MHz: ± 2.0 dB, from 0 to 55 dB 8 MHz: ± 2.0 dB, from 0 to 45 dB 12 MHz: ± 3.0 dB, from 0 to 45 dB 17.6 MHz: ± 3.0 dB, from 0 to 40 dB 30 MHz: ± 4.0 dB, from 0 to 40 dB
	Level resolution	0.1 dB
	Frequency resolution	1 kHz
	Frequency uncertainty (accuracy)	$\pm(50$ ppm + 1 digit)
	Frequency scale	ADSL/2+: 10 kHz to 2.2 MHz VDSL2-8 : 20 kHz to 8 MHz VDSL2-12: 20 kHz to 12 MHz VDSL2-17: 35 kHz to 17.6 MHz VDSL2-30: 35 kHz to 30 MHz
	Fault location	Total resistance, near-end to fault resistance, fault to strap resistance (three significant digits, least significant digit 0.1 Ω). Total length, distance to fault, distance from fault to strap (three significant digits, least significant digit 1 m)
	Uncertainty (accuracy)	$\pm(0.1 \Omega + 1 \% \times \text{RTS})$

NOTES

- Subject to change without notice.
- Typical, at 23 °C \pm 3 °C, on batteries, with no USB connection.
- Specifications based on 24 AWG (PE 0.5 mm) cabling.

Technical Specifications

COPPER SPECIFICATIONS ^{a, b, c} (continued)

Single-ended frequency response (attenuation) ^d	Distance range	100 m to 5000 m (300 ft to 16000 ft)
	Frequency range	4.3 kHz to 30 MHz
	Frequency uncertainty (accuracy)	±(50 ppm + 1 digit)
	Level uncertainty (accuracy)	±2 dB typical for 2.2 MHz and 8 MHz ranges ±3 dB for VDSL2-12 and VDSL2-17 ±4 dB for VDSL2-30 ranges
	Resolution	0.1 dB
	Horizontal scale	ADSL2+ = 2.208 MHz, VDSL2-8 = 8 MHz, VDSL2-12 = 12 MHz, VDSL2-17 = 17.66 MHz, VDSL2-30 = 30 MHz
	Vertical scale	0 dB to 100 dB
Resistive fault location (RFL)	Test type	Single pair (two wire) and separate good pair (four wire) and Küpfmüller (K-Test)
	Fault detection	0 to 20 MΩ
	Resolution	Three digits
	Loop resistance	10 kΩ maximum
	Multiple cable sections	Five (includes gauge and temperature setting)
	Fault location	Total resistance, near-end to fault resistance, fault to strap resistance (three significant digits, least significant digit 0.1 Ω). Total length, distance to fault, distance from fault to strap (three significant digits, least significant digit 1 m)
	Uncertainty (accuracy)	±(0.1 Ω + 1 % x RTS)
	K-Test uncertainty (accuracy)	± (1.0 Ω + 1 % RTS + (Rf1 + Rf2)/10 MΩ) - double fault ± (1.0 Ω + 1 % RTS) - single fault

Notes

- Subject to change without notice.
- Typical, at 23 °C ± 3 °C, on batteries, with no USB connection.
- Specifications based on 24 AWG (PE 0.5 mm) cabling.
- Specification based on 1 kft 24 AWG cabling. Range depends on cable type and condition.

TECHNICAL SPECIFICATIONS

Display	Color touchscreen, 800 x 480 TFT, 178 mm (7 in)
Interfaces	Two USB 2.0 ports RJ45 LAN 10/100/1000 Mbit/s Fiber inspection probe connector port (video) Built-in Bluetooth and Wi-Fi (hardware option) Five-color coded 2 mm analog safety shrouded line interfaces
Storage	8 GB internal memory (flash) 16 GB internal memory (flash), optional
Batteries	Rechargeable lithium-ion batteries Operating time: 4.75 h (typical with extended battery)

GENERAL SPECIFICATIONS (MODULE ONLY)

Size (H x W x D)	130 mm x 252 mm x 56 mm (5 ¹ / ₁₆ in x 9 ¹⁵ / ₁₆ in x 2 ³ / ₁₆ in)
Weight	0.93 kg (2 lb)
Temperature operating storage	0 °C to 40 °C (32 °F to 104 °F) ^a -40 °C to 70 °C (-40 °F to 158 °F)

Note

- DC voltage, isolation resistance, VF and WB receiver = 0 °C to 45 °C (32 °F to 113 °F).

PM-1 BUILT-IN POWER METER SPECIFICATIONS ^a	
Calibrated wavelengths (nm)	850, 1300, 1310, 1490, 1550, 1625, 1650
Optional CWDM calibrated wavelengths (nm)	1270, 1290, 1310, 1330, 1350, 1370, 1390, 1410, 1430, 1450, 1470, 1490, 1510, 1530, 1550, 1570, 1590, 1610, 1383, 1625
Power range (dBm)	10 to -86 (InGaAs) 26 to -64 (GeX)
Uncertainty (%) ^b	±5 % ± 3 pW (InGaAs) ±5 % ± 0.4 nW (GeX)
Display resolution (dB)	
InGaAs	0.01 = max to -76 dBm 0.1 = -76 dBm to -86 dBm 1 = -86 dBm to min
GeX	0.01 = max to -64 dBm 0.1 = -60 dBm to -60 dBm 1 = -60 dBm to min
Automatic offset nulling range ^c	Max power to -63 dBm for InGaAs Max power to -40 dBm for GeX
Tone detection (Hz)	270/1000/2000

Notes

- a. At 23 °C ± 1 °C, 1550 nm and FC connector. With modules in Idle mode. Battery-operated.
- b. Up to 5 dBm.
- c. For ±0.05 dB, from 18 °C to 28 °C.

Index

A	
adapter	6
after-sales service	299
attenuation	31, 69, 227
B	
balance	101, 107
capacitive	92
good VF/AC	92
marginal VF/AC	93
bandwidth	219, 224
buttons	
arrow	18
graph controls	19
buzzer	72
threshold value	72
C	
cable	
add	32
book	28
clone	34
delete	35
details	30
fill	95
fill material	30
gauge	30
ID	30
length	119
load	29
name	30
temperature	95, 119
type	95, 156
capacitance	31, 68, 96, 119
capacitors	6
caution	
of personal hazard	4
of product hazard	4
CE	viii
certification information	vii
charger	6
circuit ID	75
cleaning	
front panel	293
conventions, safety	4
current	106
customer name	75
customer service	304
D	
DC current	96
DC voltage	96
detecting module	14
dialer	46
distance	68
E	
edit	
parameters	90, 100, 126
threshold	126
thresholds	90, 100
enter number	47
entry name	39, 49
equipment returns	304
export	76
external power supply	6
F	
fault status	205
file name	71
foreign DC voltage	92
front panel, cleaning	293

Index

- G**
- graph controls..... 19
 - group
 - add..... 40
 - clone..... 41
 - delete..... 42
 - group ID..... 39
- H**
- hush buzzer..... 72
 - hush time..... 72
- I**
- identification label..... 299
 - indoor use..... 6
 - inserting a module..... 12
 - isolation..... 93, 96, 107
- L**
- label customization..... 69
 - label, identification..... 299
 - level..... 68
 - load coil..... 107, 213
- M**
- maintenance..... 293
 - front panel..... 293
 - general information..... 293
 - measurement units..... 68
 - milliwatt tone entry..... 103
 - module
 - detection..... 14
 - insertion..... 12
 - removal..... 12
- N**
- noise filter..... 69
- P**
- phone book..... 36
 - details..... 38
 - load..... 43
 - save..... 44
 - phone number..... 39
 - POTS
 - DC Current..... 92
 - DC voltage..... 92
 - power influence..... 101, 107
 - power line frequency..... 69
 - power separation..... 268
 - power spectral density..... 69
 - power supply..... 6
 - product
 - identification label..... 299
 - specifications..... 307
 - profile
 - delete..... 64
 - load..... 51
- Q**
- quiet line entry..... 103
- R**
- removing a module..... 12
 - repairing unit..... 6
 - resistance..... 31, 69, 106, 119, 227
 - termination..... 219, 225
 - resistive balance..... 107
 - result file name..... 76
 - result file storage location..... 76
 - return merchandise authorization (RMA) .. 304
- S**
- safety
 - caution..... 4
 - conventions..... 4
 - warning..... 4

save.....	76
save result	75
save test.....	90, 100
section length	213
select cable.....	90
select result file	75
separator.....	71
service and repairs.....	304
service centers.....	305
set volume.....	100
shipping to EXFO	304
soak voltage.....	175
specifications, product	307
standard selection	68
start compensation	290
status bar	
copper	22
storage requirements	293
symbols, safety.....	4

T

technical specifications.....	307
technical support	299
temperature	68
temperature for storage.....	293
termination impedance	69
test	
from	70
to.....	70
threshold	
mid counter.....	268
threshold capacitive balance	154
transportation requirements	293, 300
troubleshooting	297

U

unit	
repairing.....	6
USB	
copy from	63
copy to	63

V

VF	
impulse noise.....	107, 111
noise	107, 111
VF noise.....	101
VF noise filter	103
voltage	106

W

warranty.....	301
certification.....	303
exclusions	303
general.....	301
liability.....	302
null and void.....	301
WB	
attenuation	107
balance	107
impulse noise.....	107, 111
PSD noise	107, 111

NOTICE
通告

CHINESE REGULATION ON RESTRICTION OF HAZARDOUS SUBSTANCES
中国关于有害物质限制的规定



NAMES AND CONTENTS OF THE TOXIC OR HAZARDOUS SUBSTANCES OR ELEMENTS
CONTAINED IN THIS EXFO PRODUCT
包含在本 **EXFO** 产品中的有毒有害物质或元素的名称和含量

O	Indicates that this toxic or hazardous substance contained in all of the homogeneous materials for this part is below the limit requirement in SJ/T11363-2006 表示该有毒有害物质在该部件所有均质材料中的含量均在 SJ/T11363-2006 标准规定的限量要求以下。
X	Indicates that this toxic or hazardous substance contained in at least one of the homogeneous materials used for this part is above the limit requirement in SJ/T11363-2006 表示该有毒有害物质至少在该部件的某一均质材料中的含量超出 SJ/T11363-2006 标准规定的限量要求。

Part Name 部件名称	Toxic or hazardous Substances and Elements 有毒有害物质和元素					
	Lead 铅 (Pb)	Mercury 汞 (Hg)	Cadmium 镉 (Cd)	Hexavalent Chromium 六价铬 (Cr VI)	Polybrominated biphenyls 多溴联苯 (PBB)	Polybrominated diphenyl ethers 多溴二苯醚 (PBDE)
Enclosure 外壳	O	O	O	O	O	O
Electronic and electrical sub-assembly 电子和电子组件	X	O	X	O	X	X
Optical sub-assembly ^a 光学组件 ^a	X	O	O	O	O	O
Mechanical sub-assembly ^a 机械组件 ^a	O	O	O	O	O	O

a. If applicable.
如果适用。

MARKING REQUIREMENTS
标注要求

Product 产品	Environmental protection use period (years) 环境保护使用期限 (年)	Logo 标志
This Exfo product 本 EXFO 产品	10	
Battery ^a 电池 ^a	5	

- a. If applicable.
如果适用。

P/N: 1067071

www.EXFO.com · info@exfo.com

CORPORATE HEADQUARTERS	400 Godin Avenue	Quebec (Quebec) G1M 2K2 CANADA Tel.: 1 418 683-0211 · Fax: 1 418 683-2170
EXFO AMERICA	3400 Waterview Parkway Suite 100	Richardson, TX 75080 USA Tel.: 1 972-761-927 · Fax: 1 972-761-9067
EXFO EUROPE	Winchester House, School Lane	Chandlers Ford, Hampshire S053 4DG ENGLAND Tel.: +44 2380 246 800 · Fax: +44 2380 246 801
EXFO ASIA-PACIFIC	62 Ubi Road 1, #09-01/02 Oxley Bizhub 2	SINGAPORE 408734 Tel.: +65 6333 8241 · Fax: +65 6333 8242
EXFO CHINA	Beijing Global Trade Center, Tower C, Room 1207, 36 North Third Ring Road East, Dongcheng District	Beijing 100013 P. R. CHINA Tel.: +86 (10) 5825 7755 · Fax: +86 (10) 5825 7722
EXFO SERVICE ASSURANCE	270 Billerica Road	Chelmsford MA, 01824 USA Tel.: 1 978 367-5600 · Fax: 1 978 367-5700
EXFO FINLAND	Elektroniikkatie 2	FI-90590 Oulu, FINLAND Tel.: +358 (0) 403 010 300 · Fax: +358 (0) 8 564 5203
TOLL-FREE	(USA and Canada)	1 800 663-3936

© 2014 EXFO Inc. All rights reserved.
Printed in Canada (2014-09)

