FTB-9100

Optical Switch for FTB-500



Copyright © 2006–2009 EXFO Electro-Optical Engineering Inc. All rights reserved. No part of this publication may be reproduced, stored in a retrieval system or transmitted in any form, be it electronically, mechanically, or by any other means such as photocopying, recording or otherwise, without the prior written permission of EXFO Electro-Optical Engineering Inc. (EXFO).

Information provided by EXFO is believed to be accurate and reliable. However, no responsibility is assumed by EXFO for its use nor for any infringements of patents or other rights of third parties that may result from its use. No license is granted by implication or otherwise under any patent rights of EXFO.

EXFO's Commerce And Government Entities (CAGE) code under the North Atlantic Treaty Organization (NATO) is 0L8C3.

The information contained in this publication is subject to change without notice.

Trademarks

EXFO's trademarks have been identified as such. However, the presence or absence of such identification does not affect the legal status of any trademark.

Units of Measurement

Units of measurement in this publication conform to SI standards and practices.

Patents

EXFO's Universal Interface is protected by US patent 6,612,750.

Version number: 3.0.1

Contents

Copyright Information	ii
Certification Information	v
1 Introducing the FTB-9100 Optical Switch	1
Main Features	1
Basic Switching Principles	2
Typical Application, OTDR Testing	3
Conventions	4
2 Getting Started with Your Optical Switch	5
Inserting and Removing Test Modules	5
Starting the Optical Switch Application	10
Exiting the Application	13
3 Operating the Optical Switch	15
Installing the EXFO Universal Interface (EUI)	16
Cleaning and Connecting Optical Fibers	17
Optimizing the Application for Repeatability	19
Selecting Configurations	20
Saving and Recalling Configurations	21
4 Maintenance	23
Cleaning Fixed Connectors	24
Cleaning EUI Connectors	26
Recycling and Disposal (Applies to European Union Only)	28
5 Troubleshooting	29
Solving Common Problems	29
Obtaining Online Help	30
Contacting the Technical Support Group	31
Transportation	32
6 Warranty	33
General Information	33
Liability	34
Exclusions	34
Certification	34
Service and Repairs	35
EXFO Service Centers Worldwide	36
A Technical Specifications	37

Contents

B SCPI Command Reference	39
Quick Reference Command Tree	40
Product-Specific Commands—Description	41
Index	61

Certification Information

F.C.C. Information

Electronic test equipment is exempt from Part 15 compliance (FCC) in the United States. However, compliance verification tests are systematically performed on most EXFO equipment.

CE Information

Electronic test equipment is subject to the EMC Directive in the European Union. The EN61326 standard prescribes both emission and immunity requirements for laboratory, measurement, and control equipment. This unit has undergone extensive testing according to the European Union Directive and Standards.

Certification Information

EXFO DECLARATION OF CONFORMITY

Application of Council Directive(s):	2006/95/EC - The Low Voltage Directive 2004/108/EC - The EMC Directive And their amendments
Manufacturer's Name:	EXFO Electro-Optical Engineering Inc.
Manufacturer's Address:	400 Godin Avenue Quebec, Quebec Canada, G1M 2K2 (418) 683-0211
Equipment Type/Environment:	Test & Measurement / Industrial
Trade Name/Model No.:	FTB-9100 Optical Switch

Standard(s) to which Conformity is Declared:

EN 61010-1:2001	Safety Requirements for Electrical Equipment for Measurement, Control, and Laboratory Use, Part 1: General Requirements.
EN 61326-1:2006	Electrical Equipment for Measurement, Control and Laboratory Use - EMC Requirements – Part 1: General requirements
EN 60825-1:1994 +A2:2001 +A1:2002	Safety of laser products – Part 1: Equipment classification, requirements, and user's guide
EN 55022: 1998 +A2: 2003	Information technology equipment - Radio disturbance characteristics - Limits and methods of measurement

I, the undersigned, hereby declare that the equipment specified above conforms to the above Directive and Standards.

Manufacturer

Signature:

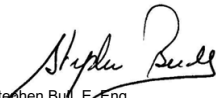

Full Name: Stephen Bull, E, Eng
Position: Vice-President Research and Development
Address: 400 Godin Avenue, Quebec (Quebec),
Canada, G1M 2K2
Date: January 09, 2009

1 Introducing the FTB-9100 Optical Switch

Main Features

The FTB-9100 Optical Switch provides highly accurate and repeatable fiber-to-fiber switching for the FTB-500 test modules.

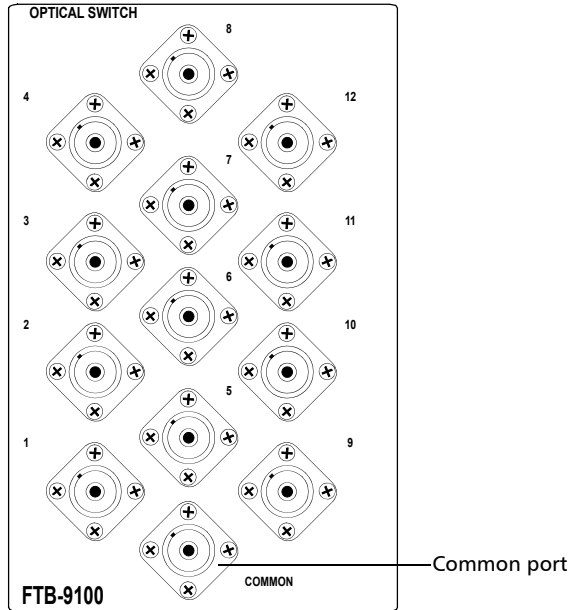

Note: Actual connectors may differ from the illustration.

The Optical Switch enhances test performances by

- minimizing downtime
- automating the testing process
- reducing manual intervention in ribbon or multifiber testing
- enabling remote testing on multiple fibers

Introducing the FTB-9100 Optical Switch

Basic Switching Principles

The FTB-9100 Optical Switch supports local control (via the ToolBox software) and remote control (through GPIB, RS-232, or Ethernet TCP/IP using SCPI commands or the provided LabVIEW drivers). For more information, refer to the *FTB-500* user guide.

Basic Switching Principles

The switch ports of 1 x N optical switches are numbered on the front panel, while the common port is identified as such.

These switches are bidirectional. This means that the optical signal can either enter through the common port and be directed toward any switch port, or enter through any switch port and then be directed toward the common port.

1 x N Optical Switch Principle

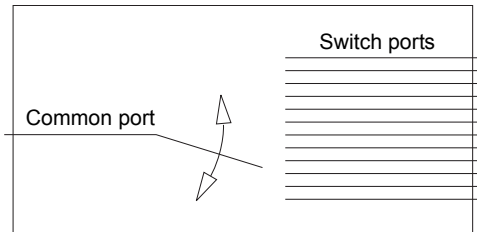

Typical Application, OTDR Testing

You can use your switch to test several fibers with an OTDR without having to connect and disconnect them before each acquisition.

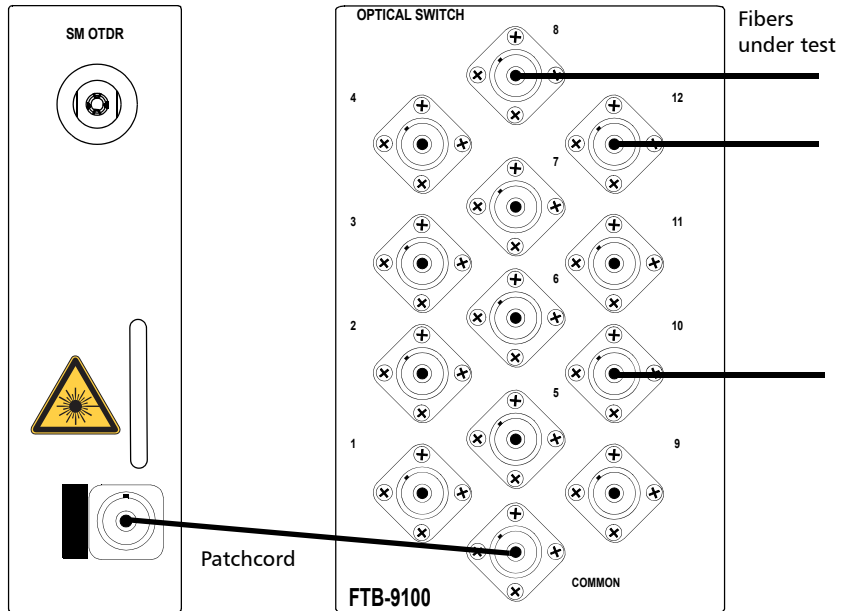

For more information, refer to the EXFO OTDR user guide.

Conventions

Before using the product described in this manual, you should understand the following conventions:



WARNING

Indicates a potentially hazardous situation which, if not avoided, could result in *death or serious injury*. Do not proceed unless you understand and meet the required conditions.



CAUTION

Indicates a potentially hazardous situation which, if not avoided, may result in *minor or moderate injury*. Do not proceed unless you understand and meet the required conditions.



CAUTION

Indicates a potentially hazardous situation which, if not avoided, may result in *component damage*. Do not proceed unless you understand and meet the required conditions.



IMPORTANT

Refers to information about this product you should not overlook.

2 **Getting Started with Your Optical Switch**



CAUTION

Your Optical Switch contains sensitive precision optical components. To ensure reliable, long-term service, observe proper handling and operating instructions. At no time should the module be subject to shock or impact.

Inserting and Removing Test Modules



CAUTION

Never insert or remove a module while the FTB-500 is turned on. This will result in immediate and irreparable damage to both the module and unit.



WARNING

When the laser safety LED () is flashing on the FTB-500, at least one of your modules is emitting an optical signal. Please check all modules, as it might not be the one you are currently using.

To insert a module into the FTB-500:

1. Exit ToolBox and turn off your unit.
2. Position the FTB-500 so that its right panel is facing you.

Getting Started with Your Optical Switch

Inserting and Removing Test Modules

3. Take the module and place it so that the connector pins are at the back, as explained and shown below.

Identification sticker must be facing up and connector pins at the right of the retaining screw hole.

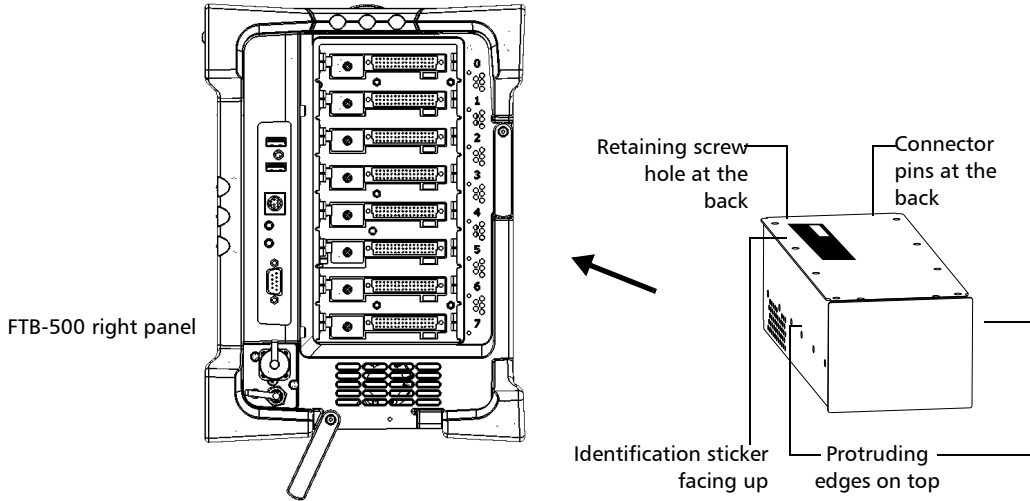

4. Insert the protruding edges of the module into the grooves of the receptacle's module slot.
5. Push the module all the way to the back of the slot, until the retaining screw makes contact with the receptacle casing.
6. Place the FTB-500 so that its left panel is facing you.

Getting Started with Your Optical Switch

Inserting and Removing Test Modules

7. While applying slight pressure to the module, turn the retaining screw clockwise until it is tightened.

This will secure the module into its “seated” position.

Turn retaining screw knob
clockwise

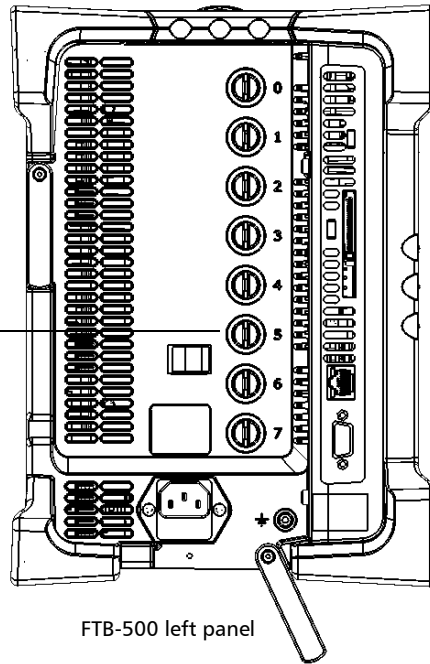
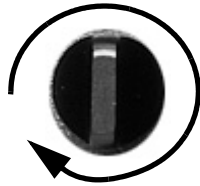

FTB-500 left panel

When you turn on the unit, the startup sequence will automatically detect the module.

Getting Started with Your Optical Switch

Inserting and Removing Test Modules

To remove a module from the FTB-500:

1. Exit ToolBox and turn off your unit.
2. Position the FTB-500 so that the left panel is facing you.
3. Turn the retaining screw counterclockwise until it stops.

The module will be slowly released from the slot.

Turn retaining screw knob(s)
counterclockwise

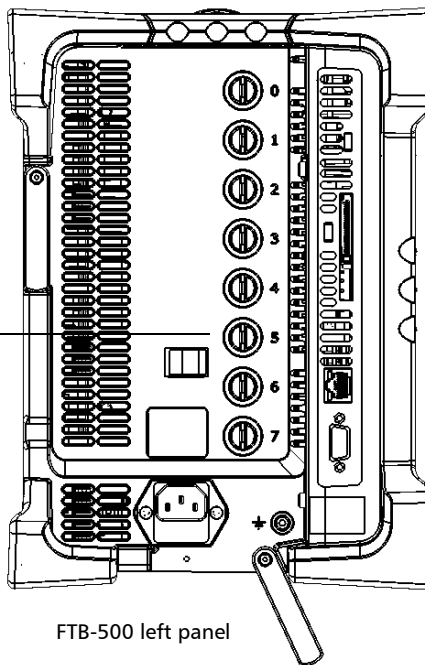
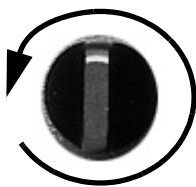

4. Place the FTB-500 so that the right panel is facing you.

Getting Started with Your Optical Switch

Inserting and Removing Test Modules

5. Hold the module by its sides or by the handle (*NOT by the connector*) and pull it out.

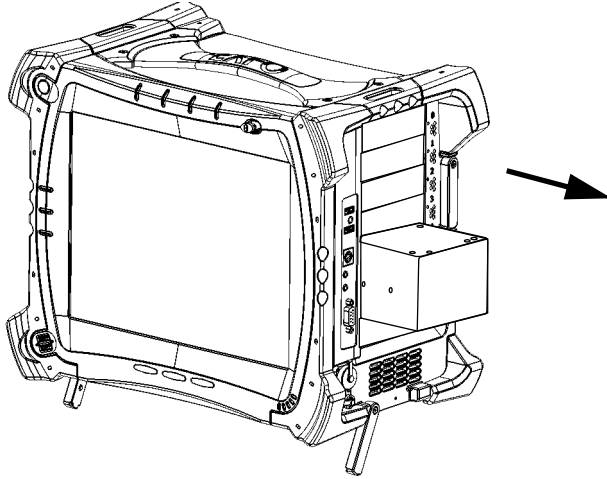

Getting Started with Your Optical Switch

Starting the Optical Switch Application

Starting the Optical Switch Application

Your FTB-9100 Optical Switch module can be configured and controlled from its dedicated ToolBox application.

Note: For details about ToolBox, refer to the FTB-500 user guide.

To start the application:

1. From the main window, select the module to use.

It will turn blue to indicate that it is highlighted.

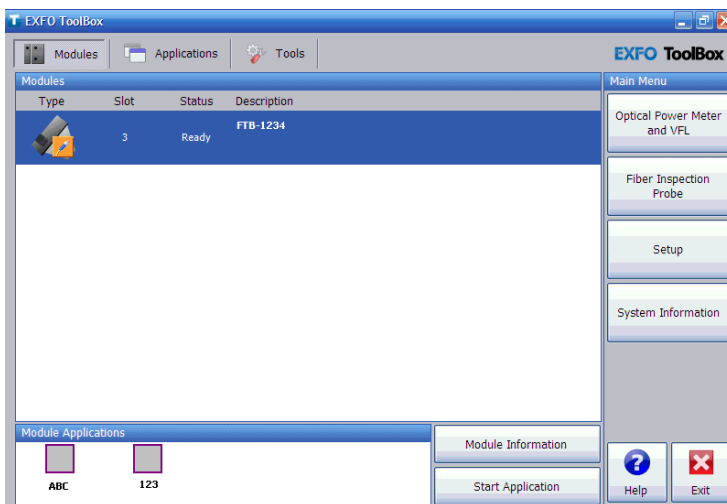

2. Click the corresponding button in the **Module Applications** box.

Getting Started with Your Optical Switch

Starting the Optical Switch Application

The main window (shown below) contains all the commands required to control the Optical Switch:

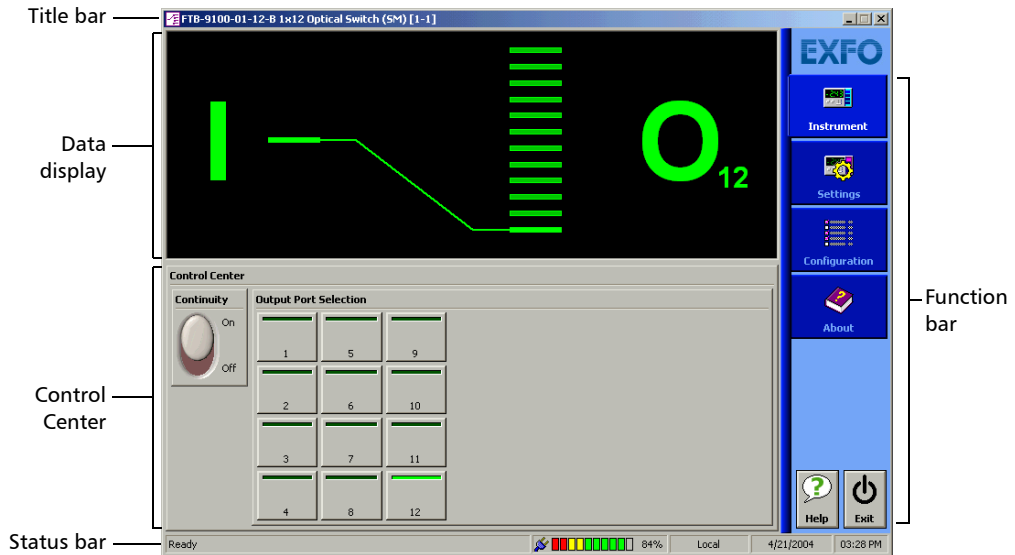

Note: You can also control the switch directly from ToolBox's OTDR application, as explained in the OTDR user guide.

Getting Started with Your Optical Switch

Starting the Optical Switch Application

Data Display

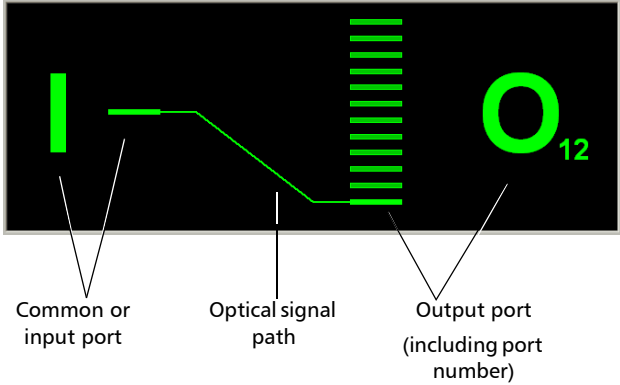

Status Bar

The status bar, located at the bottom of the main window, identifies the operational status of the FTB-9100 Optical Switch.

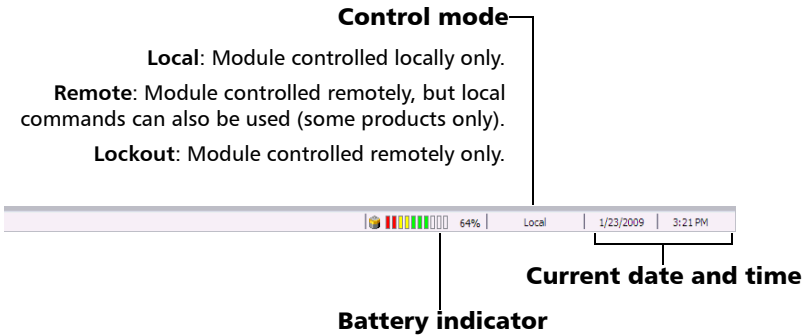

For more information about automating or remotely controlling the FTB-9100 Optical Switch, refer to your platform user guide.

Exiting the Application

Closing any application that is not currently being used helps freeing system memory.

To close the application from the main window:

Click  in the top right corner of the main window.

OR

Click the **Exit** button located at the bottom of the function bar.

3 ***Operating the Optical Switch***

Before using the FTB-9100 Optical Switch in a test setup, you must first connect the ports to other test components and select a switching configuration.

Note: *You can configure your switch before connecting it to your test setup.*



CAUTION

Your Optical Switch contains sensitive precision optical components. To ensure reliable, long-term service, observe proper handling and operating instructions. At no time should the module be subject to shock or impact.

Operating the Optical Switch

Installing the EXFO Universal Interface (EUI)

Installing the EXFO Universal Interface (EUI)

The EUI fixed baseplate is available for connectors with angled (APC) or non-angled (UPC) polishing. A green border around the baseplate indicates that it is for APC-type connectors.

Green border
indicates APC
option

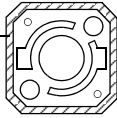

Bare metal
(or blue border)
indicates UPC
option

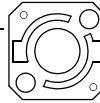

To install an EUI connector adapter onto the EUI baseplate:

1. Hold the EUI connector adapter so the dust cap opens downwards.

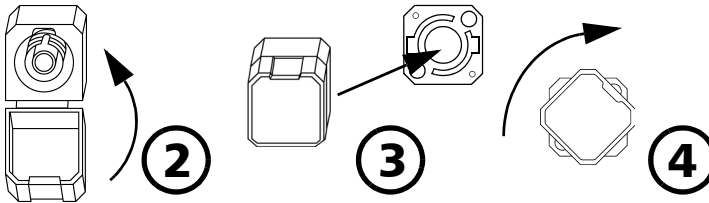

2. Close the dust cap in order to hold the connector adapter more firmly.
3. Insert the connector adapter into the baseplate.
4. While pushing firmly, turn the connector adapter clockwise on the baseplate to lock it in place.

Cleaning and Connecting Optical Fibers



IMPORTANT

To ensure maximum power and to avoid erroneous readings:

- Always inspect fiber ends and make sure that they are clean as explained below before inserting them into the port. EXFO is not responsible for damage or errors caused by bad fiber cleaning or handling.
- Ensure that your patchcord has appropriate connectors. Joining mismatched connectors will damage the ferrules.

To connect the fiber-optic cable to the port:

- 1.** Inspect the fiber using a fiber inspection microscope. If the fiber is clean, proceed to connecting it to the port. If the fiber is dirty, clean it as explained below.
- 2.** Clean the fiber ends as follows:
 - 2a.** Gently wipe the fiber end with a lint-free swab dipped in isopropyl alcohol.
 - 2b.** Use compressed air to dry completely.
 - 2c.** Visually inspect the fiber end to ensure its cleanliness.

Operating the Optical Switch

Cleaning and Connecting Optical Fibers

- 3.** Carefully align the connector and port to prevent the fiber end from touching the outside of the port or rubbing against other surfaces.

If your connector features a key, ensure that it is fully fitted into the port's corresponding notch.

- 4.** Push the connector in so that the fiber-optic cable is firmly in place, thus ensuring adequate contact.

If your connector features a screwsleeve, tighten the connector enough to firmly maintain the fiber in place. Do not overtighten, as this will damage the fiber and the port.

Note: *If your fiber-optic cable is not properly aligned and/or connected, you will notice heavy loss and reflection.*

Optimizing the Application for Repeatability

The optimization for repeatability ensures better accuracy in positioning the light path when switching.

- With optimization activated, every time a switching occurs, the switch mechanism returns to the “no continuity” (**Off**) position before aligning to a new channel position. This option provides better precision, but with slower switching.
- With optimization deactivated, the switch mechanism goes directly to the new channel position. This option provides faster switching, but with less precision.

To optimize switching for repeatability:

1. In the main window, select the **Settings** function tab.

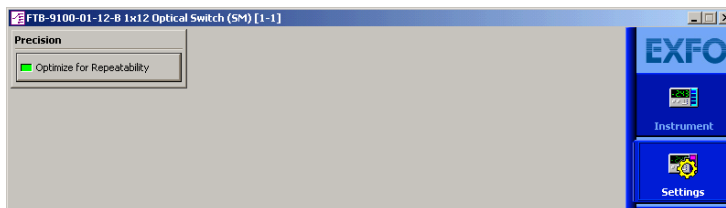

2. Press the **Optimize for Repeatability** button. The light indicator on the button will turn bright green to indicate optimization is active.

Selecting Configurations

The different configurations available for your switch allow you to access a number of switch possibilities.

To select configurations:

1. Set the **Continuity** switch to the **On** or **Off** position, depending on whether or not you want the light signal to pass through the optical switch.

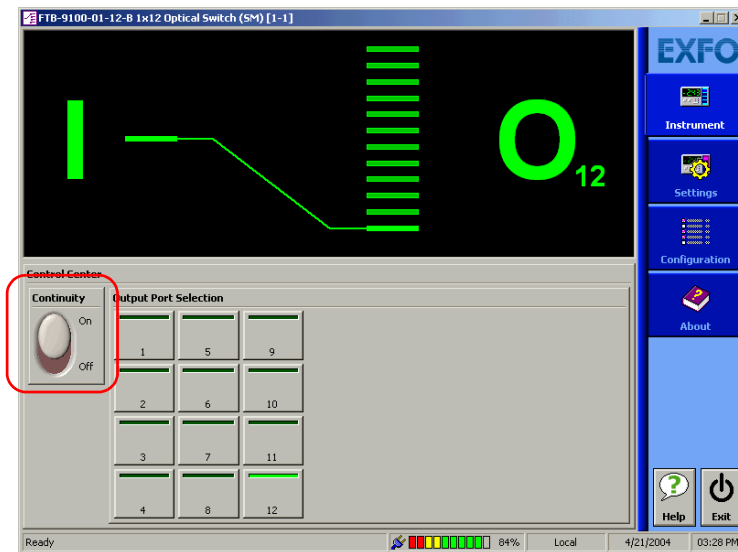

2. In the **Output Port Selection** panel, select the port through which you want to direct the light.

Note: You can change the output port at any time, and as many times as you want. You cannot preset output switch port activation sequences. You must activate each port manually.

Saving and Recalling Configurations

Once you have set the FTB-9100 Optical Switch parameters, you can save your custom configuration and recall it at any time. You can also recall the factory-defined settings.

Saved configurations include all parameters set in the **Control Center** (**Instrument** function tab) and in the **Settings** function tab (if present).

To save a configuration:

1. Select the **Configuration** function tab.

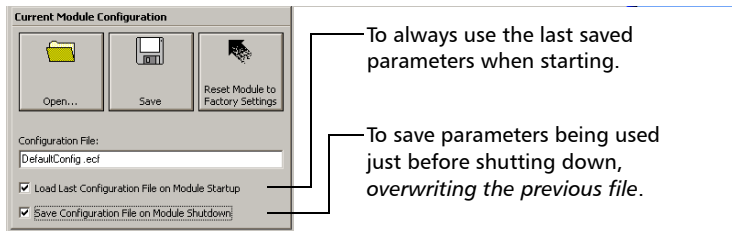

2. Under **Current Module Configuration**, enter the name you want to use for your configuration file.

It will be saved in *D:\ToolBox\Configuration Files\(*your_module*)*.

3. Click **Save**.

Operating the Optical Switch

Saving and Recalling Configurations

To recall a configuration:

1. Select the **Configuration** function tab.
2. Click **Open**.
3. Select the configuration file you want to recall and confirm your action.

You will return to your application and the new parameters will be set.

To revert to factory settings:

1. Select the **Configuration** function tab.
2. Click the **Reset Module to Factory Settings** button.



IMPORTANT

Reverting to the factory settings will interrupt any module operation in progress.



IMPORTANT

The operation may take a few seconds to complete.

4 **Maintenance**

To help ensure long, trouble-free operation:

- Always inspect fiber-optic connectors before using them and clean them if necessary.
- Keep the unit free of dust.
- Clean the unit casing and front panel with a cloth slightly dampened with water.
- Store unit at room temperature in a clean and dry area. Keep the unit out of direct sunlight.
- Avoid high humidity or significant temperature fluctuations.
- Avoid unnecessary shocks and vibrations.
- If any liquids are spilled on or into the unit, turn off the power immediately and let the unit dry completely.



WARNING

Use of controls, adjustments, and procedures for operation and maintenance other than those specified herein may result in hazardous radiation exposure.

Cleaning Fixed Connectors

Regular cleaning of connectors will help maintain optimum performance. *Do not try to disassemble the unit. Doing so would break the connector.*

To clean fixed connectors:

1. Fold a lint-free wiping cloth in four to form a square.
2. Moisten the center of the lint-free wiping cloth with *only one drop* of isopropyl alcohol.



IMPORTANT

Alcohol may leave traces if used abundantly. Avoid contact between the tip of the bottle and the wiping cloth, and do not use bottles that distribute too much alcohol at a time.

3. Gently wipe the connector threads three times with the folded and moistened section of the wiping cloth.



IMPORTANT

Isopropyl alcohol takes approximately ten seconds to evaporate. Since isopropyl alcohol is not absolutely pure, evaporation will leave microscopic residue. Make sure you dry the surfaces before evaporation occurs.

4. With a dry lint-free wiping cloth, gently wipe the same surfaces three times with a rotating movement.
5. Throw out the wiping cloths after one use.

6. Moisten a cleaning tip (2.5 mm tip) with *only one drop* of isopropyl alcohol.



IMPORTANT

Alcohol may leave traces if used abundantly. Avoid contact between the tip of the bottle and the cleaning tip, and do not use bottles that distribute too much alcohol at a time.

7. Slowly insert the cleaning tip into the connector until it reaches the ferrule inside (a slow clockwise rotating movement may help).

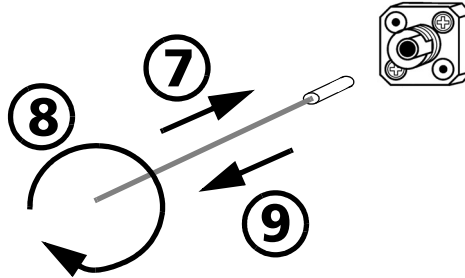

8. Gently turn the cleaning tip one full turn.
9. Continue to turn as you withdraw the cleaning tip.
10. Repeat steps 7 to 9, but this time with a dry cleaning tip (2.5 mm tip provided by EXFO).

Note: Make sure you don't touch the soft end of the cleaning tip and verify the cleanliness of the cotton tip.

11. Throw out the cleaning tips after one use.

Cleaning EUI Connectors

Regular cleaning of EUI connectors will help maintain optimum performance. There is no need to disassemble the unit.



IMPORTANT

If any damage occurs to internal connectors, the module casing will have to be opened and a new calibration will be required.

To clean EUI connectors:

1. Remove the EUI from the instrument to expose the connector baseplate and ferrule.

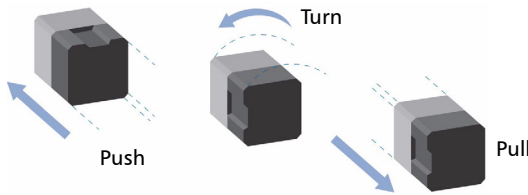

2. Moisten a 2.5 mm cleaning tip with *one drop* of isopropyl alcohol (alcohol may leave traces if used abundantly).
3. Slowly insert the cleaning tip into the EUI adapter until it comes out on the other side (a slow clockwise rotating movement may help).

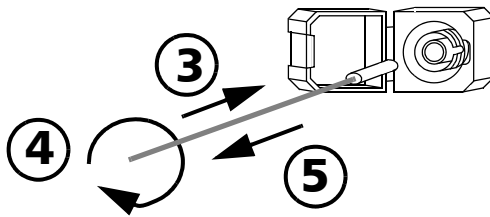

4. Gently turn the cleaning tip one full turn, then continue to turn as you withdraw it.

5. Repeat steps 3 to 4 with a dry cleaning tip.

Note: *Make sure you don't touch the soft end of the cleaning tip.*

6. Clean the ferrule in the connector port as follows:

6a. Deposit *one drop* of isopropyl alcohol on a lint-free wiping cloth.



IMPORTANT

Isopropyl alcohol may leave residues if used abundantly or left to evaporate (about 10 seconds).

Avoid contact between the tip of the bottle and the wiping cloth, and dry the surface quickly.

- 6b.** Gently wipe the connector and ferrule.
- 6c.** With a dry lint-free wiping cloth, gently wipe the same surfaces to ensure that the connector and ferrule are perfectly dry.
- 6d.** Verify connector surface with a portable fiber-optic microscope (for example, EXFO's FOMS) or fiber inspection probe (for example, EXFO's FIP).



WARNING

Verifying the surface of the connector WHILE THE UNIT IS ACTIVE WILL result in permanent eye damage.

7. Put the EUI back onto the instrument (push and turn clockwise).
8. Throw out cleaning tips and wiping cloths after one use.

Maintenance

Recycling and Disposal (Applies to European Union Only)

Recycling and Disposal (Applies to European Union Only)



Recycle or dispose of your product (including electric and electronic accessories) properly, in accordance with local regulations. Do not dispose of it in ordinary garbage receptacles.

This equipment was sold after August 13, 2005 (as identified by the black rectangle).

- Unless otherwise noted in a separate agreement between EXFO and a customer, distributor, or commercial partner, EXFO will cover costs related to the collection, treatment, recovery, and disposal of end-of-lifecycle waste generated by electronic equipment introduced after August 13, 2005 to an European Union member state with legislation regarding Directive 2002/96/EC.
- Except for reasons of safety or environmental benefit, equipment manufactured by EXFO, under its brand name, is generally designed to facilitate dismantling and reclamation.

For complete recycling/disposal procedures and contact information, visit the EXFO Web site at www.exfo.com/recycle.

5 Troubleshooting

Solving Common Problems

Problem	Possible cause	Recommended action
Insertion loss higher than expected.	Dirty optical connectors.	Clean all optical connectors.
	Improper wavelength selected on other instruments	Switch to the correct wavelength on all instruments being used.
Poor repeatability.	Optical source is unstable.	Wait for source to stabilize.
	—	Select Optimize for Repeatability .
No optical continuity.	Switch is off.	Set the Continuity switch to On .

Troubleshooting

Obtaining Online Help

Obtaining Online Help

An online version of the FTB-9100 Optical Switch user guide is conveniently available at all times from the application.

Note: *You will also find a printable PDF version on your installation CD.*

To access online help:

Click the **Help** button on the function bar.

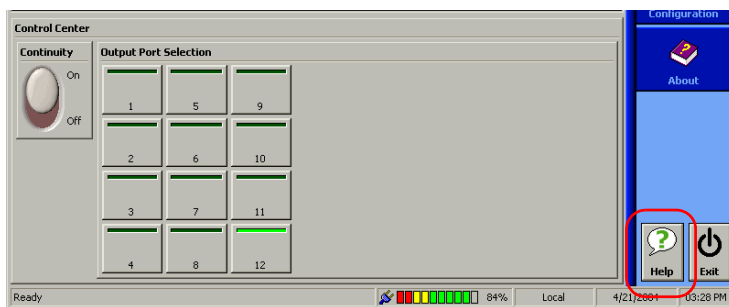

Contacting the Technical Support Group

To obtain after-sales service or technical support for this product, contact EXFO at one of the following numbers. The Technical Support Group is available to take your calls from Monday to Friday, 8:00 a.m. to 7:00 p.m. (Eastern Time in North America).

For detailed information about technical support, visit the EXFO Web site at www.exfo.com.

To accelerate the process, please have information such as the name and the serial number (see the product identification label—an example is shown below), as well as a description of your problem, close at hand.

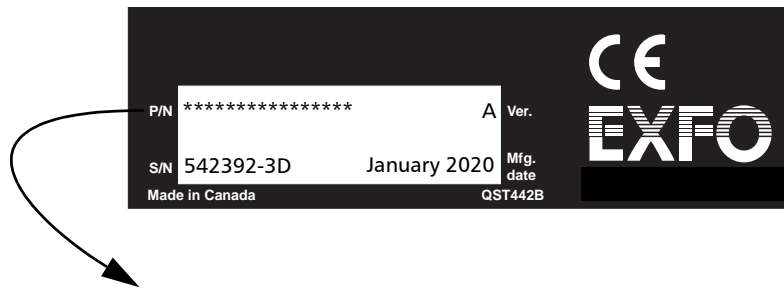

FTB-9100-01-12-X-XX

Fiber type
Connector type

FTB-9100-01-12-B-92-XX

Singlemode fiber
MTP/APC output connector
Input connector

Troubleshooting

Transportation

You may also be requested to provide software and module version numbers. This information, as well as technical support contact information, can be found in the **About** function tab.

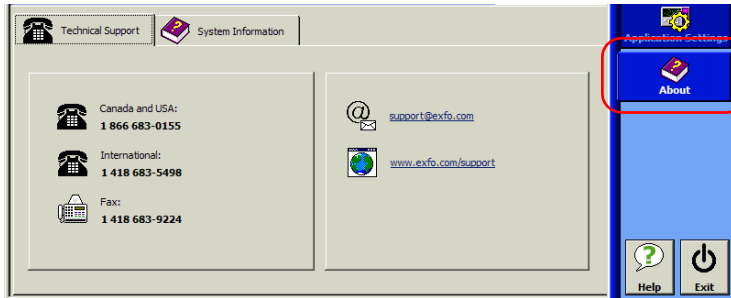

- Select the **Technical Support** tab to view phone numbers and active Internet links to EXFO's Technical Support Group. Use these links to send an information request by e-mail or to access EXFO's web site.
- Select the **Module Information** tab to view the module identification, serial number and firmware version.

Transportation

Maintain a temperature range within specifications when transporting the unit. Transportation damage can occur from improper handling. The following steps are recommended to minimize the possibility of damage:

- Pack the unit in its original packing material when shipping.
- Avoid high humidity or large temperature fluctuations.
- Keep the unit out of direct sunlight.
- Avoid unnecessary shocks and vibrations.

6 **Warranty**

General Information

EXFO Electro-Optical Engineering Inc. (EXFO) warrants this equipment against defects in material and workmanship for a period of one year from the date of original shipment. EXFO also warrants that this equipment will meet applicable specifications under normal use.

During the warranty period, EXFO will, at its discretion, repair, replace, or issue credit for any defective product, as well as verify and adjust the product free of charge should the equipment need to be repaired or if the original calibration is erroneous. If the equipment is sent back for verification of calibration during the warranty period and found to meet all published specifications, EXFO will charge standard calibration fees.



IMPORTANT

The warranty can become null and void if:

- **unit has been tampered with, repaired, or worked upon by unauthorized individuals or non-EXFO personnel.**
- **warranty sticker has been removed.**
- **case screws, other than those specified in this guide, have been removed.**
- **case has been opened, other than as explained in this guide.**
- **unit serial number has been altered, erased, or removed.**
- **unit has been misused, neglected, or damaged by accident.**

THIS WARRANTY IS IN LIEU OF ALL OTHER WARRANTIES EXPRESSED, IMPLIED, OR STATUTORY, INCLUDING, BUT NOT LIMITED TO, THE IMPLIED WARRANTIES OF MERCHANTABILITY AND FITNESS FOR A PARTICULAR PURPOSE. IN NO EVENT SHALL EXFO BE LIABLE FOR SPECIAL, INCIDENTAL, OR CONSEQUENTIAL DAMAGES.

Warranty

Liability

Liability

EXFO shall not be liable for damages resulting from the use of the product, nor shall be responsible for any failure in the performance of other items to which the product is connected or the operation of any system of which the product may be a part.

EXFO shall not be liable for damages resulting from improper usage or unauthorized modification of the product, its accompanying accessories and software.

Exclusions

EXFO reserves the right to make changes in the design or construction of any of its products at any time without incurring obligation to make any changes whatsoever on units purchased. Accessories, including but not limited to fuses, pilot lamps, batteries and universal interfaces (EUI) used with EXFO products are not covered by this warranty.

This warranty excludes failure resulting from: improper use or installation, normal wear and tear, accident, abuse, neglect, fire, water, lightning or other acts of nature, causes external to the product or other factors beyond the control of EXFO.



IMPORTANT

EXFO will charge a fee for replacing optical connectors that were damaged due to misuse or bad cleaning.

Certification

EXFO certifies that this equipment met its published specifications at the time of shipment from the factory.

Service and Repairs

EXFO commits to providing product service and repair for five years following the date of purchase.

To send any equipment for service or repair:

- 1.** Call one of EXFO's authorized service centers (see *EXFO Service Centers Worldwide* on page 36). Support personnel will determine if the equipment requires service, repair, or calibration.
- 2.** If equipment must be returned to EXFO or an authorized service center, support personnel will issue a Return Merchandise Authorization (RMA) number and provide an address for return.
- 3.** If possible, back up your data before sending the unit for repair.
- 4.** Pack the equipment in its original shipping material. Be sure to include a statement or report fully detailing the defect and the conditions under which it was observed.
- 5.** Return the equipment, prepaid, to the address given to you by support personnel. Be sure to write the RMA number on the shipping slip. *EXFO will refuse and return any package that does not bear number.*

Note: *A test setup fee will apply to any returned unit that, after test, is found to meet the applicable specifications.*

After repair, the equipment will be returned with a repair report. If the equipment is not under warranty, you will be invoiced for the cost appearing on this report. EXFO will pay return-to-customer shipping costs for equipment under warranty. Shipping insurance is at your expense.

Routine recalibration is not included in any of the warranty plans. Since calibrations/verifications are not covered by the basic or extended warranties, you may elect to purchase FlexCare Calibration/Verification Packages for a definite period of time. Contact an authorized service center (see *EXFO Service Centers Worldwide* on page 36).

Warranty

EXFO Service Centers Worldwide

EXFO Service Centers Worldwide

If your product requires servicing, contact your nearest authorized service center.

EXFO Headquarters Service Center

400 Godin Avenue
Quebec (Quebec) G1M 2K2
CANADA

1 866 683-0155 (USA and Canada)
Tel.: 1 418 683-5498
Fax: 1 418 683-9224
quebec.service@exfo.com

EXFO Europe Service Center

Omega Enterprise Park, Electron Way
Chandlers Ford, Hampshire S053 4SE
ENGLAND

Tel.: +44 2380 246810
Fax: +44 2380 246801
europe.service@exfo.com

EXFO China Service Center/ Beijing OSIC

Beijing New Century Hotel
Office Tower, Room 1754-1755
No. 6 Southern Capital Gym Road
Beijing 100044
P. R. CHINA

Tel.: +86 (10) 6849 2738
Fax: +86 (10) 6849 2662
beijing.service@exfo.com

A Technical Specifications



IMPORTANT

The following technical specifications can change without notice. The information presented in this section is provided as a reference only. To obtain this product's most recent technical specifications, visit the EXFO Web site at www.exfo.com.

SPECIFICATIONS ^a

Model	FTB-9100-01-12-B-XX	FTB-9100-01-12-B-92-XX	FTB-9100-01-12-B-92-XX
	Singlemode	Singlemode	Multimode
Number of channels	1x12	1x12	1x12
Connector type	SC/PC (54), E-2000/PC (95) SC/APC (88), E-2000/APC (96)	MTP/APC (female connector) ^b	SC/PC (54)
Insertion loss ^c (dB)	0.7	0.9	0.5
Backreflection ^d (dB)	-40 (PC) -55 (APC)	-55	-24
Repeatability ^e (dB)	± 0.03	± 0.03	± 0.03
Operating wavelengths (nm)	1290 to 1650	1290 to 1650	780 to 1350
Polarization dependent loss (dB)	0.05 ^f	0.05 ^f	-
Crosstalk (dB)	-80	-80	-80
Switch life	10 million cycles minimum (excluding connector cycles)		
Maximum optical input power	24 dBm	24 dBm	24 dBm

GENERAL SPECIFICATIONS ^a

Temperature	operating	10 °C to 40 °C	(50 °F to 104 °F)
	storage	-20 °C to 60 °C	(-4 °F to 140 °F)
Relative humidity	80 % max. non-condensing		
Size (H x W x D)	96 mm x 51 mm x 260 mm	(3 3/4 in x 2 in x 10 1/4 in)	
Weight	1.0 kg	(2.2 lb)	

NOTES

- All specifications are for a temperature of 23 °C (73 °F) with an SC/PC connector unless otherwise specified.
- MTP connectors are sensitive to dirt. Protection and cleanup before and after each use is recommended.
- Typical insertion loss per module, excluding connectors, measured at singlemode wavelengths of 1310 nm and 1550 nm.
- Typical backreflection measured at singlemode wavelengths of 1310 nm and 1550 nm, excluding connectors.
- Typical repeatability values for 100 cycles per switch module at a constant temperature for 1 hour with a stabilized source/power meter at singlemode wavelengths of 1310 nm and 1550 nm.
- Typical.
- Configuration 54-SC/PC is offered for singlemode or multimode fiber types.
- Configuration 88-SC/APC is offered for singlemode fiber types only.
- Configuration E-2000 is offered for singlemode fiber types only.

B *SCPI Command Reference*

This appendix presents detailed information on the commands and queries supplied with your FTB-9100 Optical Switch.



IMPORTANT

Since the FTB-500 can house many instruments, you must explicitly specify which instrument you want to remotely control.

You must add the following mnemonic *at the beginning of any command or query* that you send to an instrument:

LINstrument<LogicalInstrumentPos>:

where <*LogicalInstrumentPos*> corresponds to the identification number of the instrument.

FTB-500 backplane identification number

|

1Y

|

Instrument slot number:

For information on modifying unit identification, refer to your platform user guide.

SCPI Command Reference

Quick Reference Command Tree

Quick Reference Command Tree

Command					Parameter(s)	P.
ROUte[1..n]	CLOSe					41
	OPEN					42
		STATe?				43
	PATH	CATalog?				44
	SCAN				<Position>	45
	SCAN?					47
	SCAN	ADJust				49
			AUTO		<AutoAdjust>	50
			AUTO?			52
		NEXT				54
		PREV				55
		SYNChronous			<Synchronous>	56
		SYNChronous?				57
SNUMber?						58
STATus?						59

Product-Specific Commands—Description

:ROUTe[1..n]:CLOSE

Description	This command positions the optical switch to the reset position. In this position, there is no optical continuity. *RST has no effect on this command.
Syntax	:ROUTe[1..n]:CLOSE
Parameter(s)	None
Example(s)	ROUT:CLOSE
Notes	For all switches except: 1x2, 2x2, and 2x4.
See Also	ROUTe[1..n]:OPEN ROUTe[1..n]:OPEN:STATE?

SCPI Command Reference

Product-Specific Commands—Description

:ROUTe[1..n]:OPEN

Description	This command makes the switch change from the reset position (no optical continuity) to the channel position in effect when the switch was turned off. *RST has no effect on this command.
Syntax	:ROUTe[1..n]:OPEN
Parameter(s)	None
Example(s)	ROUT:OPEN
Notes	For all switches except: 1x2, 2x2, and 2x4.
See Also	ROUTe[1..n]:OPEN ROUTe[1..n]:OPEN:STATe?

:ROUTE[1..n]:OPEN:STATE?

Description	<p>This query returns a value indicating whether the switch is optically open or closed.</p> <p>On *RST, the value of this setting is OFF.</p>
Syntax	:ROUTE[1..n]:OPEN:STATE?
Parameter(s)	None
Response Syntax	<OpticalContinuity>
Response(s)	<p><i>OpticalContinuity:</i></p> <p>The response data syntax for <OpticalContinuity> is defined as a <NR1 NUMERIC RESPONSE DATA> element.</p> <p>The <OpticalContinuity> response represents the optical continuity state, where:</p> <p>0, means there is no optical continuity. 1, means there is optical continuity.</p>
Example(s)	<p>ROUT:CLOS ROUT:OPEN:STAT? returns 0 (there is no optical continuity) ROUT:OPEN ROUT:OPEN:STAT? returns 1 (there is optical continuity)</p>
Notes	For all switches except: 1x2, 2x2, and 2x4.
See Also	<p>ROUTE[1..n]:OPEN ROUTE[1..n]:CLOSE</p>

SCPI Command Reference

Product-Specific Commands—Description

:ROUTe[1..n]:PATH:CATalog?

Description	<p>This query returns a value indicating the type of switch in use (e.g. 1x2, 1x4, 1x12, 1x16, 1x 32, 2x2 or 2x4).</p> <p>*RST has no effect on this command.</p>
Syntax	:ROUTe[1..n]:PATH:CATalog?
Parameter(s)	None
Response Syntax	<Type>
Response(s)	<p><i>Type:</i></p> <p>The response data syntax for <Type> is defined as a <STRING RESPONSE DATA> element.</p> <p>The <Type> response is a string indicating the switch type in the format 9x99.</p>
Example(s)	ROUT:PATH:CAT? returns "2x2"

:ROUTE[1..n]:SCAN

Description

This command sets the switch to a specific channel.

On *RST, the selected output channel depends on the switch configuration:

- a) For 1xN switch configuration: Output 1.
- b) For 2x4 switch configuration: no continuity for both Input 1 and Input 2.
- c) For 2x2 switch configuration: BYPASS state.

Syntax

:ROUTE[1..n]:SCAN<wsp> <Position>

Parameter(s)

Position:

The program data syntax for <Position> is defined as a <DECIMAL NUMERIC PROGRAM DATA> element.

The <Position> is a number from 0 to 32, depending on switch configuration as follows:

- a) For a 1xN switch configuration, a number from 1 to 32, depending on the number of output channels.
- b) For a 2x4 switch, a number from 0 to 5, where
 - 0, means no continuity for both Input 1 and Input 2.
 - 1, means no continuity for Input 1, and Input 2 is connected to Output 1.

:ROUTE[1..n]:SCAN

2, means Input 1 is connected to Output 1 and Input 2 is connected to Output 2.

3, means Input 1 is connected to Output 2 and Input 2 is connected to Output 3.

4, means Input 1 is connected to Output 3 and Input 2 is connected to Output 4.

5, means Input 1 is connected to Output 4 and Input 2 has no continuity.

c) For a 2x2 switch, a number, 1 or 2, where:

1, means BYPASS state.

2, means INSERT state.

Example(s)

ROUT:SCAN 1

ROUT:SCAN? returns 1

ROUT:SCAN 2

ROUT:SCAN? returns 2

See Also

ROUTE[1..n]:SCAN?

ROUTE[1..n]:SCAN:PREV

ROUTE[1..n]:SCAN:NEXT

:ROUTE[1..n]:SCAN?

Description	<p>This query returns a value indicating the current switch position.</p> <p>On *RST, the selected output channel depends on the switch configuration:</p> <ul style="list-style-type: none"> a) For 1xN switch configuration: Output 1. b) For 2x4 switch configuration: no continuity for both Input 1 and Input 2. c) For 2x2 switch configuration: BYPASS state.
Syntax	:ROUTE[1..n]:SCAN?
Parameter(s)	None
Response Syntax	<Position>
Response(s)	<p><i>Position:</i></p> <p>The response data syntax for <Position> is defined as a <NR1 NUMERIC RESPONSE DATA> element.</p> <p>The <Position> response represents the currently selected channel on the switch, as follows:</p> <ul style="list-style-type: none"> a) For a 1xN switch configuration, a number from 1 to 32, depending on the number of output channels. b) For a 2x4 switch, a number from 0 to 5, where <ul style="list-style-type: none"> 0, means no continuity for both Input 1 and Input 2. 1, means no continuity for Input 1, and Input 2 is connected to Output 1.

:ROUTE[1..n]:SCAN?

2, means Input 1 is connected to Output 1 and Input 2 is connected to Output 2.

3, means Input 1 is connected to Output 2 and Input 2 is connected to Output 3.

4, means Input 1 is connected to Output 3 and Input 2 is connected to Output 4.

5, means Input 1 is connected to Output 4 and Input 2 has no continuity.

c) For a 2x2 switch, a number, 1 or 2, where:

1, means BYPASS state.

2, means INSERT state.

Example(s)

ROUT:SCAN 1

ROUT:SCAN? returns 1

ROUT:SCAN 2

ROUT:SCAN? returns 2

See Also

ROUTE[1..n]:SCAN

ROUTE[1..n]:SCAN:PREV

ROUTE[1..n]:SCAN:NEXT

:ROUTe[1..n]:SCAN:ADJust

Description	<p>This command makes the switch mechanism return to a reference position before aligning to the current position.</p> <p>This command is an event and has no associated *RST condition or query form.</p>
Syntax	:ROUTe[1..n]:SCAN:ADJust
Parameter(s)	None
Example(s)	ROUT:SCAN:ADJ
See Also	ROUTe[1..n]:SCAN:ADJust:AUTO ROUTe[1..n]:SCAN:ADJust:AUTO?

:ROUTE[1..n]:SCAN:ADJust:AUTO

Description

This command sets the <Optimize for repeatability> option. When this option is selected, the switch mechanism returns to a reference position before aligning to a new position. This ensures optimum repeatability. When this option is not selected, the switch mechanism goes directly to the new channel position. This provides faster switching times, but less repeatability.

On *RST, the value of this setting is OFF.

Syntax

:ROUTE[1..n]:SCAN:ADJust:AUTO<wsp> <Auto Adjust>

Parameter(s)

AutoAdjust:

The program data syntax for <AutoAdjust> is defined as a <Boolean Program Data> element. The <AutoAdjust> special forms ON and OFF are accepted on input for increased readability. ON corresponds to 1 and OFF corresponds to 0.

The <AutoAdjust> parameter enables or disables the optimization for repeatability.

1 or ON, enables the optimization for repeatability.

0 or OFF, disables the optimization for repeatability.

:ROUTe[1..n]:SCAN:ADJust:AUTO

Example(s)	<p>ROUT:SCAN:ADJ:AUTO 0 ROUT:SCAN:ADJ:AUTO? returns 0 (optimization for repeatability is not selected).</p>
	<p>ROUT:SCAN:ADJ:AUTO 1 ROUT:SCAN:ADJ:AUTO? returns 1 (optimization for repeatability is selected).</p>
Notes	<p>For all switches except: 1x2 and 2x2.</p>
See Also	<p>ROUTe[1..n]:SCAN:ADJust ROUTe[1..n]:SCAN:ADJust:AUTO?</p>

:ROUTE[1..n]:SCAN:ADJust:AUTO?

Description	<p>This query returns the current value of the <Optimize for repeatability> option. When this option is selected, the switch mechanism returns to a reference position before aligning to a new position. This ensures optimum repeatability. When this option is not selected, the switch mechanism goes directly to the new channel position. This provides faster switching times, but less repeatability.</p> <p>On *RST, the value of this setting is OFF.</p>
Syntax	:ROUTE[1..n]:SCAN:ADJust:AUTO?
Parameter(s)	None
Response Syntax	<AutoAdjust>
Response(s)	<p><i>AutoAdjust:</i></p> <p>The response data syntax for <AutoAdjust> is defined as a <NR1 NUMERIC RESPONSE DATA> element.</p>

:ROUTe[1..n]:SCAN:ADJust:AUTO?

The <AutoAdjust> response represents the current state of the <Optimize for repeatability> option, where:

1, <Optimize for repeatability> option is selected.

0, <Optimize for repeatability> option is not selected.

Example(s)

ROUT:SCAN:ADJ:AUTO 0

ROUT:SCAN:ADJ:AUTO? returns 0 (optimization for repeatability is not selected).

ROUT:SCAN:ADJ:AUTO 1

ROUT:SCAN:ADJ:AUTO? returns 1 (optimization for repeatability is selected).

See Also

ROUTe[1..n]:SCAN:ADJust

ROUTe[1..n]:SCAN:ADJust:AUTO

SCPI Command Reference

Product-Specific Commands—Description

:ROUTe[1..n]:SCAN:NEXT

Description	This command moves the switch to the next position. This command is an event and has no associated *RST condition or query form.
Syntax	:ROUTe[1..n]:SCAN:NEXT
Parameter(s)	None
Example(s)	ROUT:SCAN 1 ROUT:SCAN:NEXT ROUT:SCAN? returns 2
See Also	ROUTe[1..n]:SCAN ROUTe[1..n]:SCAN? ROUTe[1..n]:SCAN:PREV

:ROUTe[1..n]:SCAN:PREV

Description	<p>This command moves the switch to its previous position.</p> <p>This command is an event and has no associated *RST condition or query form.</p>
Syntax	:ROUTe[1..n]:SCAN:PREV
Parameter(s)	None
Example(s)	<p>ROUT:SCAN 2</p> <p>ROUT:SCAN:PREV</p> <p>ROUT:SCAN? returns 1</p>
See Also	<p>ROUTe[1..n]:SCAN</p> <p>ROUTe[1..n]:SCAN?</p> <p>ROUTe[1..n]:SCAN:NEXT</p>

:ROUTe[1..n]:SCAN:SYNChronous

Description	This command enables/disables the switch to change position synchronously or not.
Syntax	:ROUTe[1..n]:SCAN:SYNChronous<wsp><Synchronous>
Parameter(s)	<p><i>Synchronous:</i></p> <p>The program data syntax for <Synchronous> is defined as a <Boolean Program Data> element. The <Synchronous> special forms ON and OFF are accepted on input for increased readability. ON corresponds to 1 and OFF corresponds to 0.</p> <p>The <Synchronous> parameter enables or disables the synchronous mode.</p> <p>1 or ON, enables the synchronous mode for changing position. 0 or OFF, disables the synchronous mode for changing position.</p>
Example(s)	<pre>ROUT:SCAN:SYNC 0 ROUT:SCAN:SYNC? returns 0 ROUT:SCAN 12 STATUS? returns BUSY (Module busy)</pre>
See Also	<pre>ROUTe[1..n]:SCAN ROUTe[1..n]:SCAN? ROUTe[1..n]:SCAN:SYNChronous?</pre>

:ROUTe[1..n]:SCAN:SYNChronous?

Description	<p>This query returns a value indicating whether the switch is changing position synchronously or not.</p> <p>On *RST, the value of this setting is ON.</p>
Syntax	:ROUTe[1..n]:SCAN:SYNChronous?
Parameter(s)	None
Response Syntax	<Synchronous>
Response(s)	<p><i>Synchronous:</i></p> <p>The response data syntax for <Synchronous> is defined as a <NR1 NUMERIC RESPONSE DATA> element.</p> <p>The <Synchronous> response represents switching position mode, where:</p> <p>0, means the module is changing position asynchronously.</p> <p>1, means the module is changing position synchronously.</p>
See Also	<p>ROUTe[1..n]:SCAN</p> <p>ROUTe[1..n]:SCAN?</p> <p>ROUTe[1..n]:SCAN:SYNChronous</p>

SCPI Command Reference

Product-Specific Commands—Description

:SNUMber?	
Description	<p>This query returns a value indicating the module's serial number</p> <p>This command is an event and has no associated *RST condition or query form.</p>
Syntax	:SNUMber?
Parameter(s)	None
Response Syntax	<SerialNumber>
Response(s)	<p><i>SerialNumber:</i></p> <p>The response data syntax for <SerialNumber> is defined as a <STRING RESPONSE DATA> element.</p> <p>The <SerialNumber> response represents a string containing the modules serial number.</p>
Example(s)	SNUM? returns "123456-AB"

:STATus?

Description	<p>This query returns a value indicating the status of the switch (READY, BUSY, etc.)</p> <p>This command is an event and has no associated *RST condition or query form.</p>
Syntax	:STATus?
Parameter(s)	None
Response Syntax	<Status>
Response(s)	<p><i>Status:</i></p> <p>The response data syntax for <Status> is defined as a <CHARACTER RESPONSE DATA> element.</p> <p>The <Status> response represents the module state, where:</p> <p>UNINITIALIZED, means the module is not initialized.</p> <p>INITINPROGRESS, means the module initialization is in progress,</p> <p>READY, means the module is ready,</p> <p>BUSY, means the module is busy,</p> <p>DISCONNECTED, means the module is disconnected,</p> <p>DEFECTIVE, means the module is defective, and</p> <p>UNCONFIGURED, means the module is not configured.</p>
Example(s)	STAT? returns READY (Module is ready.)

Index

A	
About function tab	32
after-sales service	31
application	
contacting EXFO support from	32
exiting	13
main window description	11
setting up	15
starting, single-module	10
see <i>also</i> optical switch	
B	
bidirectional optical switch	2
Busy, module status	12
C	
caution	
of personal hazard	4
of product hazard	4
certification information	v
cleaning	
EUI connectors	26
fiber ends	17
fixed connectors	24
front panel	23
common port	2
configuration	
recall	21
save	21
configurations, optical switch	
available	20
basic principles	2
selecting	20
connectors, cleaning	24, 26
contact information, EXFO	32
continuity, optical switch	19, 20, 29
conventions, safety	4
customer service	32, 35
D	
detecting module	7
E	
equipment returns	35
EUI	
connector adapter	16
dust cap	16
EUI connectors, cleaning	26
EXFO support e-mail	32
EXFO Web site	32
exiting application	13
F	
fiber ends, cleaning	17
firmware version, module	32
front panel description	1
front panel, cleaning	23
FTB-9100 Optical Switch. see optical switch	
H	
help. see online user guide	
I	
identification label	31
inserting a module	5
insertion loss, higher than expected	29
L	
label, identification	31
LabVIEW drivers	2

Index

M

main window, application.....	11
maintenance	
EUI connectors.....	26
fixed connectors.....	24
front panel.....	23
general information.....	23
model, optical switch.....	20
model. <i>see</i> configurations	
module	
detection.....	7
front panel description.....	1
insertion.....	5
removal.....	5
status.....	12
<i>see also</i> optical switch	
module information	
firmware version number.....	32
module identification number.....	32
serial number.....	32
mounting EUI connector adapter.....	16

O

online user guide.....	30
operating the optical switch.....	15
optical continuity	
function.....	20
optimization for repeatability.....	19
problem with.....	29
optical switch	
available models.....	1
bidirectional.....	2
connecting optical fiber.....	15
introducing.....	1
operating.....	15
optimizing for repeatability.....	19
ports.....	2
<i>see also</i> application <i>and</i> module	
optimizing switch for repeatability.....	19

P

PDF. <i>see</i> online user guide	
poor repeatability.....	29
product	
identification label.....	31
specifications.....	37

R

Ready, module status.....	12
recalling a configuration.....	21
remote control	
methods.....	2
removing a module.....	5
repeatability	
optimizing switch for.....	19
problem with.....	29
return merchandise authorization (RMA)	35

S

safety	
caution.....	4
conventions.....	4
warning.....	4
saving configuration.....	21
selecting configurations.....	20
serial number, module.....	32
service and repairs.....	35
service centers.....	36
shipping to EXFO.....	35
software. <i>see</i> application	
specifications, product.....	37
status bar.....	12
storage requirements.....	23
switch. <i>see</i> optical switch	
switching	
accuracy.....	19
basic principles.....	2
longer time.....	19
optimized for repeatability.....	19
symbols, safety.....	4

T

technical specifications..... 37
technical support 31, 32
temperature for storage..... 23
transportation requirements 23, 32

U

user guide. see online user guide

W

warranty
 certification 34
 exclusions 34
 general 33
 liability..... 34
 null and void..... 33

NOTICE

通告

CHINESE REGULATION ON RESTRICTION OF HAZARDOUS SUBSTANCES

中国关于有害物质限制的规定

NAMES AND CONTENTS OF THE TOXIC OR HAZARDOUS SUBSTANCES OR ELEMENTS CONTAINED IN THIS EXFO PRODUCT



包含在本 EXFO 产品中的有毒有害物质或元素的名称和含量

O	Indicates that this toxic or hazardous substance contained in all of the homogeneous materials for this part is below the limit requirement in SJ/T11363-2006 表示该有毒有害物质在该部件所有均质材料中的含量均在 SJ/T11363-2006 标准规定的限量要求以下。
X	Indicates that this toxic or hazardous substance contained in at least one of the homogeneous materials used for this part is above the limit requirement in SJ/T11363-2006 表示该有毒有害物质至少在该部件的某一均质材料中的含量超出 SJ/T11363-2006 标准规定的限量要求。

Part Name 部件名称	Toxic or hazardous Substances and Elements 有毒有害物质和元素					
	Lead 铅 (Pb)	Mercury 汞 (Hg)	Cadmium 镉 (Cd)	Hexavalent Chromium 六价铬 (Cr VI)	Polybrominated biphenyls 多溴联苯 (PBB)	Polybrominated diphenyl ethers 多溴二苯醚 (PBDE)
Enclosure 外壳	O	O	O	O	O	O
Electronic and electrical sub-assembly 电子和电子组件	X	O	X	O	X	X
Optical sub-assembly ^a 光学组件 ^a	X	O	O	O	O	O
Mechanical sub-assembly ^a 机械组件 ^a	O	O	O	O	O	O

- a. If applicable.
聞種矽杉羽塞粒粒。

MARKING REQUIREMENTS
标注要求

Product 产品	Environmental protection use period (years) 环境保护使用期限 (年)	Logo 标志
This Exfo product 本 EXFO 产品	10	
Battery ^a 电池 ^a	5	

- a. If applicable.
閩種殆衫翎塞粒。

P/N: 1055208

www.EXFO.com · info@exfo.com

CORPORATE HEADQUARTERS	400 Godin Avenue	Quebec (Quebec) G1M 2K2 CANADA Tel.: 1 418 683-0211 · Fax: 1 418 683-2170
EXFO AMERICA	3701 Plano Parkway, Suite 160	Plano TX, 75075 USA Tel.: 1 972 907-1505 · Fax: 1 972 836-0164
EXFO EUROPE	Omega Enterprise Park, Electron Way	Chandlers Ford, Hampshire S053 4SE ENGLAND Tel.: +44 2380 246810 · Fax: +44 2380 246801
EXFO ASIA-PACIFIC	151 Chin Swee Road #03-29, Manhattan House	SINGAPORE 169876 Tel.: +65 6333 8241 · Fax: +65 6333 8242
EXFO CHINA	No. 88 Fuhua First Road, Central Tower, Room 801, Futian District	Shenzhen 518048 P. R. CHINA Tel.: +86 (755) 8203 2300 · Fax: +86 (755) 8203 2306
	Beijing New Century Hotel Office Tower, Room 1754-1755, No. 6 Southern Capital Gym Road	Beijing 100044 P. R. CHINA Tel.: +86 (10) 6849 2738 · Fax: +86 (10) 6849 2662
EXFO SERVICE ASSURANCE	285 Mill Road	Chelmsford MA, 01824 USA Tel.: 1 978 367-5600 · Fax: 1 978 367-5700
TOLL-FREE	(USA and Canada)	1 800 663-3936

© 2009 EXFO Electro-Optical Engineering Inc. All rights reserved.
Printed in Canada (2009-04)

