

Optical Switch

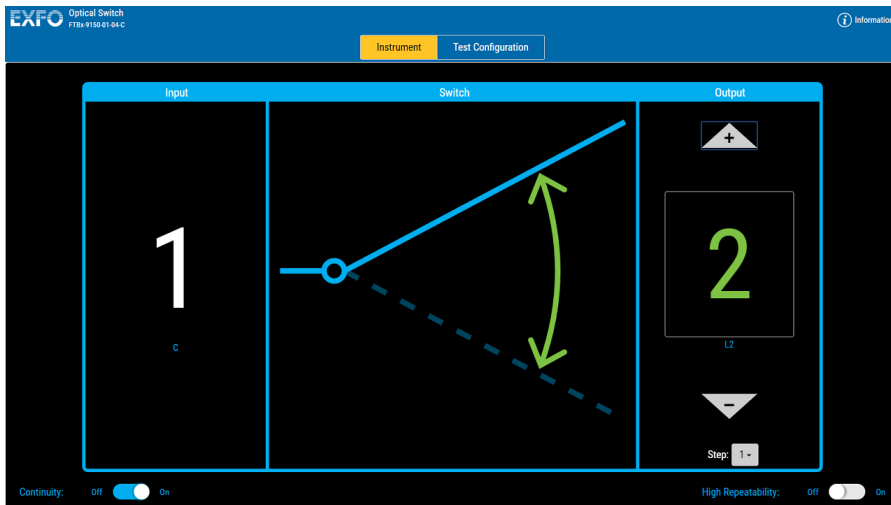

Copyright © 2016–2022 EXFO Inc. All rights reserved. No part of this publication may be reproduced, stored in a retrieval system or transmitted in any form, be it electronically, mechanically, or by any other means such as photocopying, recording or otherwise, without the prior written permission of EXFO Inc. (EXFO).

Information provided by EXFO is believed to be accurate and reliable. However, no responsibility is assumed by EXFO for its use nor for any infringements of patents or other rights of third parties that may result from its use. No license is granted by implication or otherwise under any patent rights of EXFO.

EXFO's Commerce And Government Entities (CAGE) code under the North Atlantic Treaty Organization (NATO) is 0L8C3.

The information contained in this publication is subject to change without notice.

Trademarks

EXFO's trademarks have been identified as such. However, the presence or absence of such identification does not affect the legal status of any trademark.

Where applicable, the Bluetooth[®] word mark and logos are registered trademarks owned by Bluetooth SIG, Inc. and any use of such marks by EXFO Inc. is under license. Other third party trademarks and trade names are those of their respective owners.

Units of Measurement

Units of measurement in this publication conform to SI standards and practices.

Patents

The exhaustive list of patents is available at EXFO.com/patent.

Version number: 7.0.0.1

Contents

Regulatory Information	v
1 Introducing the Optical Switch	1
Main Features	1
Available Models	2
Correspondence Between Port Numbers and Fiber Numbers (RTUe-9120)	11
External Switch LED Indicator Description	12
Basic Switching Principles	13
Typical Applications	16
Technical Specifications	19
Conventions	20
2 Safety Information	21
General Safety Information	21
Other Safety Symbols on Your Unit	23
Electrical Safety Information	24
3 Operating the Optical Switch	25
Installing an External Switch in a Rack	25
Grounding an External Switch	33
Connecting an LTBe-9110 External Switch to a Platform	35
Connecting RTUe-9110 External Switches to the RTU-2 Unit	37
Connecting RTUe-9120 External Switches to the RTU-2 Unit	42
Installing the EXFO Universal Interface (EUI)	46
Selecting a Module from a Web Browser	47
Selecting an Optical Switch in the Array (LTBe-9110 Models)	48
Cleaning and Connecting Optical Fibers	49
Optimizing the Application for Repeatability	51
Selecting Configurations with the 1 x N Model	52
Selecting Configurations with the 2 x 2 Model	55
Selecting Configurations with the 2 x 4 Model	56
Configuring Port Names	58
Managing Configurations	59
4 Maintenance	65
Cleaning Fixed Connectors	66
Cleaning EUI Connectors	68
Cleaning LT Connectors	70
Cleaning and Inspecting MPO-Type Connectors	71
Recycling and Disposal	73

Contents

- 5 Troubleshooting75**
 - Solving Common Problems75
 - Viewing Online Documentation78
 - Contacting the Technical Support Group79
 - Viewing Product Information80
 - Transportation81

- 6 Warranty83**
 - General Information83
 - Gray Market and Gray Market Products84
 - Liability85
 - Exclusions85
 - Certification85
 - Service and Repairs86
 - EXFO Service Centers Worldwide87

- A SCPI Command Reference89**
 - Quick Reference Command Tree90
 - Product-Specific Commands—Description91

- B REST Command Reference113**

- Index115**

Regulatory Information

USA Electromagnetic Interference Regulatory Statement

Electronic test and measurement equipment is exempt from FCC part 15, subpart B compliance in the United States of America. However, EXFO Inc. makes reasonable efforts to ensure compliance to the applicable standards.

The limits set by these standards are designed to provide reasonable protection against harmful interference when the equipment is operated in a commercial environment. This equipment generates, uses, and can radiate radio frequency energy and, if not installed and used in accordance with the user documentation, may cause harmful interference to radio communications. Operation of this equipment in a residential area is likely to cause harmful interference in which case the user will be required to correct the interference at his own expense.

Modifications not expressly approved by the manufacturer could void the user's authority to operate the equipment.

Canada Electromagnetic Interference Regulatory Statement

This equipment generates, uses, and can radiate radio frequency energy and, if not installed and used in accordance with the instruction manual, may cause harmful interference to radio communications. Operation of this equipment in a residential area is likely to cause harmful interference.

Cet équipement génère, utilise et peut émettre de l'énergie radio-fréquence et, s'il n'est pas installé et utilisé conformément à la documentation de l'utilisateur, il peut occasionner une interférence néfaste aux communications radio. L'utilisation de cet équipement dans une zone résidentielle est susceptible d'occasionner une interférence néfaste.

Regulatory Information

Caution: This equipment is not intended for use in residential environments and may not provide adequate protection to radio reception in such environments.

Attention : Cet appareil n'est pas destiné à être utilisé dans des environnements résidentiels et peut ne pas assurer la protection adéquate à la réception radioélectrique dans ce type d'environnements.

This is a class A, group 1 product.

Ceci est un produit de classe A, groupe 1.

- **Class A equipment:** Equipment that is, by virtue of its characteristics, highly unlikely to be used in a residential environment, including a home business shall be classified as class A and shall comply with the class A limits specified in the applicable ICES standard. Characteristics considered in this assessment include price, marketing and advertising methodology, the degree to which the functional design inhibits applications suitable to residential environments, or any combination of features that would effectively preclude the use of such equipment in a residential environment.

Classe A : Matériel qui, en raison de ses caractéristiques, ne sera fort probablement pas utilisé dans un milieu domiciliaire ni par des entreprises établies à domicile. Parmi les caractéristiques considérées dans cette évaluation, il y a le prix, les méthodes de commercialisation et de publicité, la mesure dans laquelle les fonctions de l'appareil font qu'il ne se prête pas à des applications convenant au milieu domiciliaire ou toute combinaison de ces caractéristiques qui aurait pour conséquence d'en prévenir effectivement l'utilisation à domicile. Utilisé également pour indiquer les limites d'émission correspondantes qui s'appliquent à un tel matériel.

- **Class B equipment:** Equipment that cannot be classified as Class A shall comply with the Class B limits specified in the applicable ICES standard.

Classe B : Matériel qui ne peut pas être inclus dans la classe A. Utilisé également pour indiquer les limites d'émission correspondantes qui s'appliquent à un tel matériel.

- Group 1 equipment: group 1 contains all equipment which is not classified as group 2 equipment, and includes equipment such as laboratory and scientific equipment, industrial process, measurement and control equipment.

Group 2 equipment: group 2 contains all ISM RF equipment in which radio-frequency energy in the frequency range 9 kHz to 400 GHz is intentionally generated and used or only used locally, in the form of electromagnetic radiation, inductive and/or capacitive coupling, for the treatment of material for inspection/analysis purposes, or for transfer of electromagnetic energy.

Appareils du groupe 1 : le groupe 1 réunit tous les appareils compris dans le domaine d'application de la présente Norme, qui ne sont pas classés comme étant des appareils du groupe 2. Le groupe 1 inclut les appareils scientifiques et de laboratoire, les processus industriels, appareils de mesure ou de contrôle.

Appareils du groupe 2 : le groupe 2 réunit tous les appareils ISM à fréquences radioélectriques dans lesquels de l'énergie à fréquences radioélectriques dans la plage de fréquences comprises entre 9 kHz et 400 GHz est produite et utilisée volontairement ou uniquement utilisée localement sous forme de rayonnement électromagnétique, de couplage inductif et/ou capacitif, pour le traitement de la matière, à des fins d'examen ou d'analyse ou pour le transfert d'énergie électromagnétique.

Supplier's Declaration of Conformity (SDoC)

The SDoC for your product is as follows:

CAN ICES-001 (A) / NMB-001 (A)

EU and UK Electromagnetic Compatibility Regulatory Statement

Warning: This is a class A product. In a domestic environment, this product may cause radio interference in which case the user may be required to take adequate measures. EX1: Your product is suitable for use in industrial electromagnetic environments. EX10: Your product is suitable for use in basic electromagnetic environments.

Simplified EU and UK Declaration of Conformity

The full text of the declaration of conformity is available at the following Internet address: www.exfo.com/en/resources/legal-documentation.

EU Economic Operator

EXFO Solutions SAS
2, rue Jacqueline Auriol,
Saint-Jacques-de-la-Lande,
35091 Rennes Cedex 9
FRANCE

1 **Introducing the Optical Switch**

Main Features

The Optical Switch provides fiber-to-fiber positioning of optical signals for a number of optical applications. This module, which exists in various models depending on the number of optical ports and configuration options it has, allows you to quickly switch light from one fiber to another.

Note: *Actual ports may differ from the illustrations.*

The Optical Switch enhances test performances by:

- minimizing downtime
- automating the testing process
- reducing manual intervention in ribbon or multifiber testing
- enabling remote testing on multiple fibers

Introducing the Optical Switch

Available Models

Available Models

The Optical Switch comes in different models.

Model	Features
FTBx-9110	<ul style="list-style-type: none">➤ singlemode➤ available in single channel width (Simplex) for uplink testing and double channel width (Duplex) for simultaneous uplink and downlink testing when used with an RTU2➤ available in 1 x N configurations (up to 24 switch ports)➤ possible to disable/re-enable continuity on all models➤ supports local control, or remote control using SCPI or REST commands <p>You can also use the IVI drivers you can find on the EXFO website at www.exfo.com. The drivers have their own specific documentation to help you use them with your application.</p> <p>Note: <i>Automation using SCPI or REST is possible only when the module is used in an FTB or LTB platform.</i></p>
FTBx-9150	<ul style="list-style-type: none">➤ singlemode or multimode➤ available in 1 x N and 2 x N configurations (up to 32 switch ports)➤ possible to disable/re-enable continuity on 1 x 4 to 1 x 32 models➤ supports local control, or remote control using SCPI or REST commands <p>You can also use the IVI drivers you can find on the EXFO website at www.exfo.com. The drivers have their own specific documentation to help you use them with your application.</p>

Model	Features
FTBx-9160	<ul style="list-style-type: none"> ➤ singlemode ➤ available in 1 x N configurations (up to 32 switch ports) ➤ supports local control, or remote control using SCPI or REST commands <p>You can also use the IVI drivers you can find on the EXFO website at www.exfo.com. The drivers have their own specific documentation to help you use them with your application.</p>
LTBe-9110 external switch	<ul style="list-style-type: none"> ➤ singlemode ➤ rack-mounted switch powered and controlled through a USB port ➤ available in multichannel width, quad-switch configurations available: 1 x 4 or 1 x 8. Other customized configurations are possible.
RTUe-9110 external switch	<ul style="list-style-type: none"> ➤ singlemode ➤ rack-mounted switch powered and controlled through a USB port ➤ available in single channel width (Simplex) for uplink testing and double channel width (Duplex) for simultaneous uplink and downlink testing ➤ available in configurations of 26 or 52 ports for the single-channel-width models and of 2 links of 26 ports for the double-channel-width models ➤ supports local control
RTUe-9120 external switch	<ul style="list-style-type: none"> ➤ singlemode ➤ rack-mounted switch powered and controlled through a USB port ➤ available in configurations of 2, 4, 8, or 16 MPO ports containing 16 fibers each (two rows of eight fibers) ➤ supports local control

Introducing the Optical Switch

Available Models

Below are a few examples of the available models:

Note: Actual connectors may differ from those depicted in the illustrations.

1 x 2 FTBx Optical Switch Module (FTBx-9110/FTBx-9150/FTBx9160)

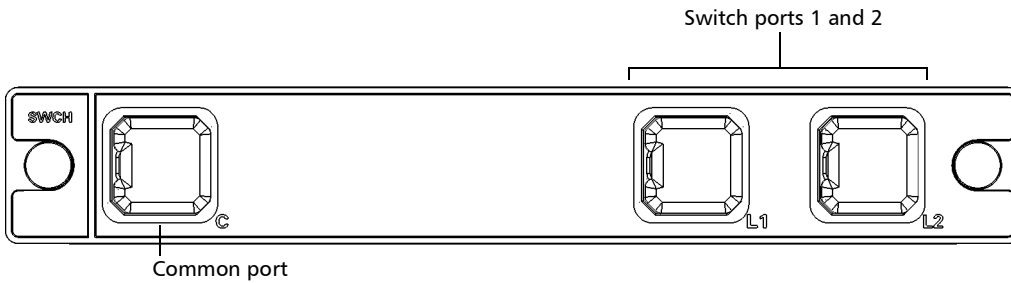

1 x 8 FTBx Optical Switch Module (FTBx-9150/FTBx9160)

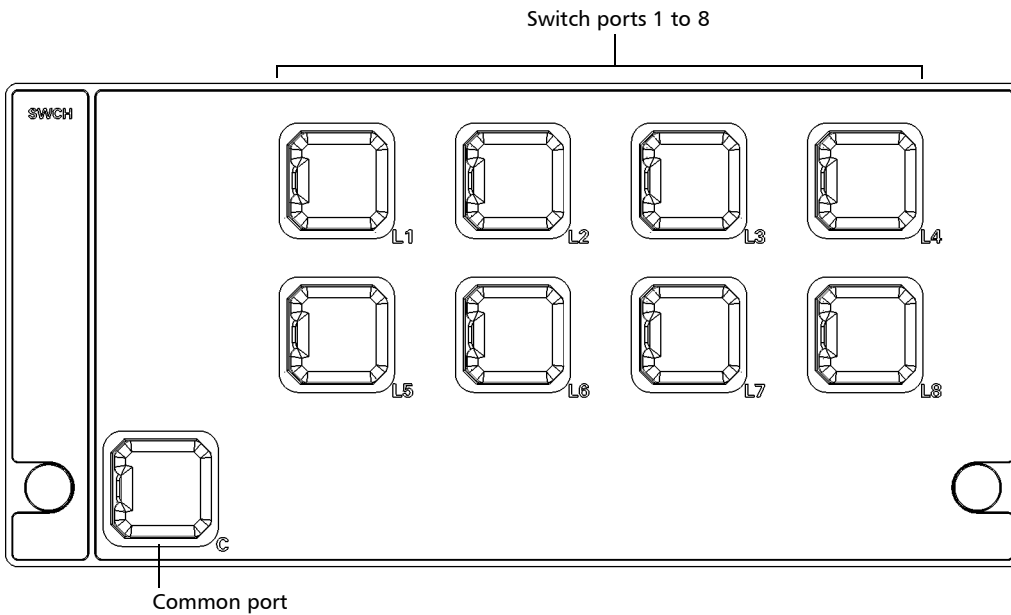

1 x 12 FTBx Duplex Optical Switch Module (FTBx-9110)

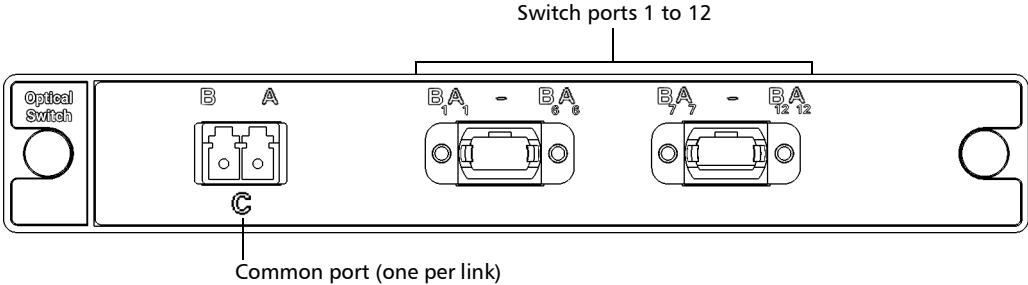

FTBx 1 x N Optical Switch Module (FTBx-9110)

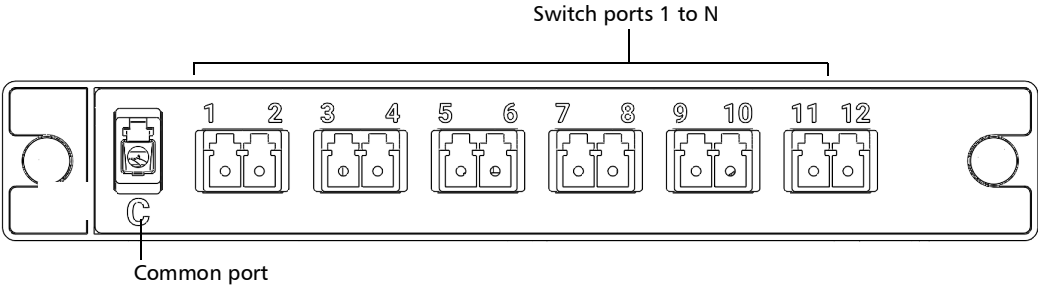

Introducing the Optical Switch

Available Models

1 x 32 FTBx Optical Switch Module (FTBx-9150/FTBx9160)

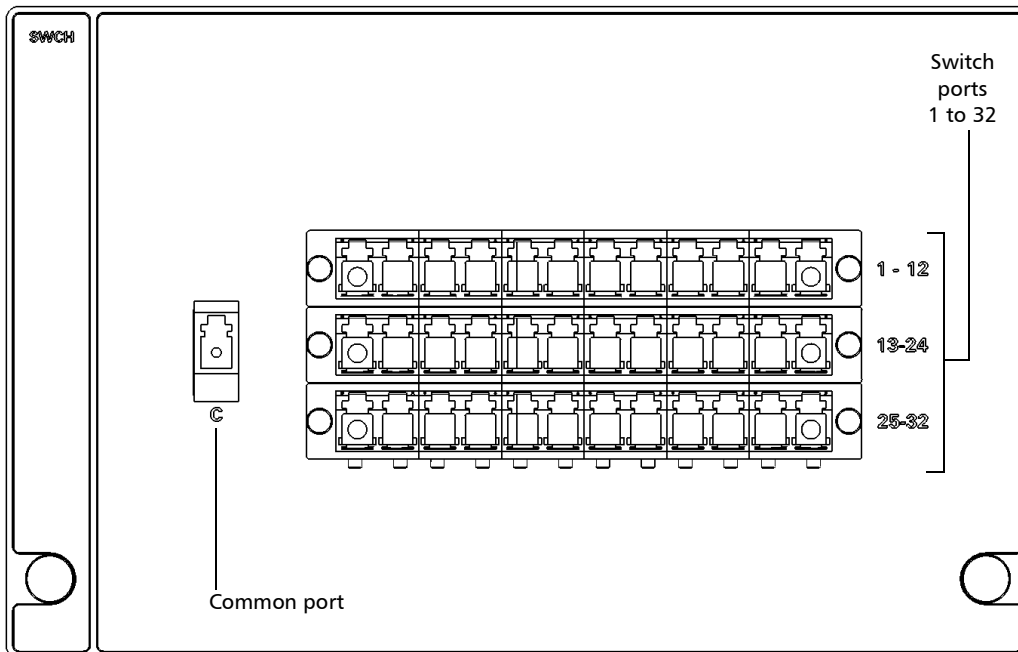

2 x 2 FTBx Optical Switch Module (FTBx-9150 only)

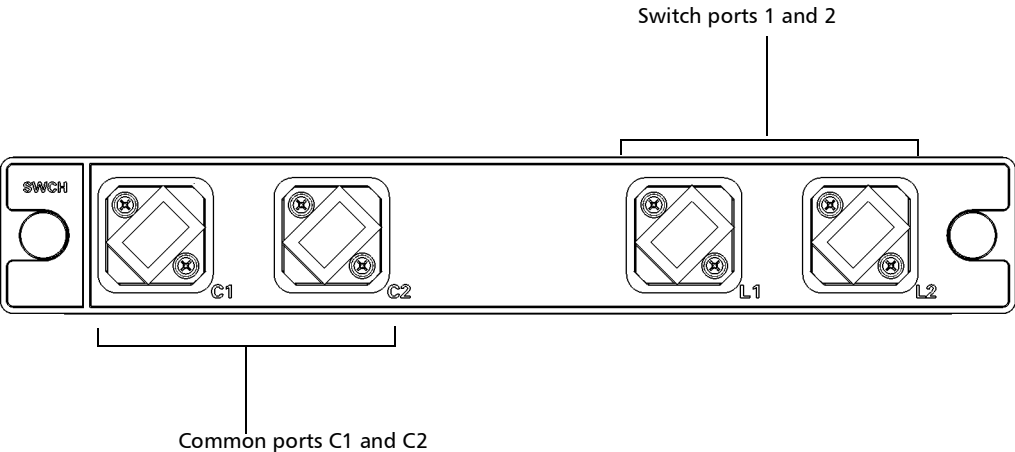

2 x 4 FTBx Optical Switch Module (FTBx-9150 only)

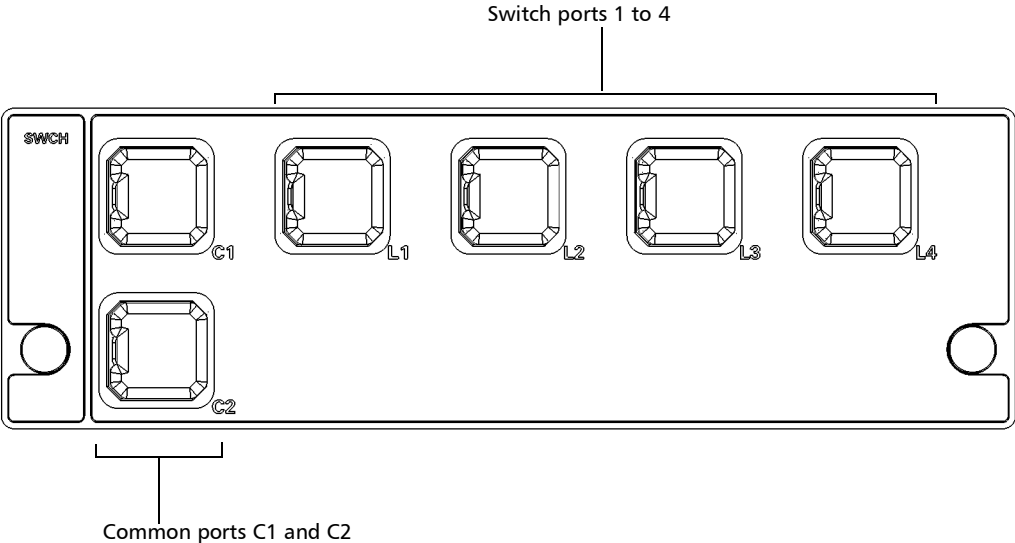

Introducing the Optical Switch

Available Models

LTBe-9110 switch array - Front - 1 x 8 ports per array

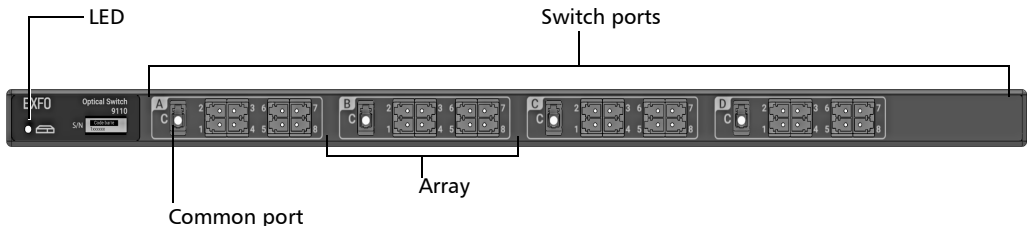

RTUe-9110 switch - Front - Single-channel-width model - 26 ports

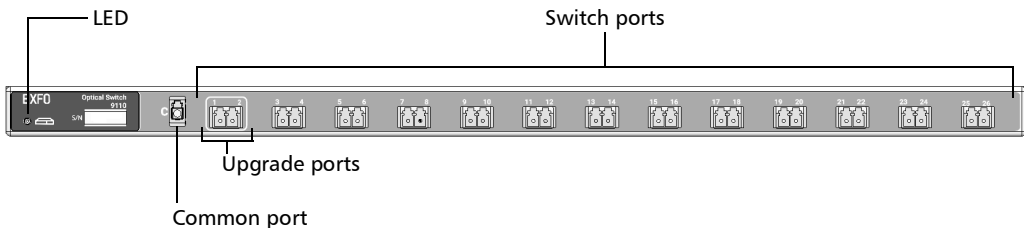

RTUe-9110 switch - Front - Single-channel-width model - 52 ports

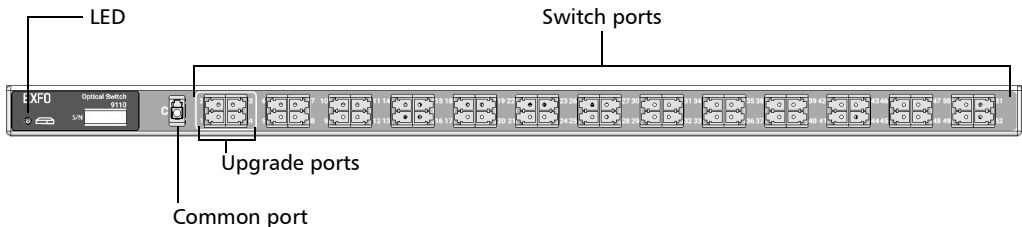

RTUe-9110 switch - Front - Double-channel-width model - 2 links of 26 ports

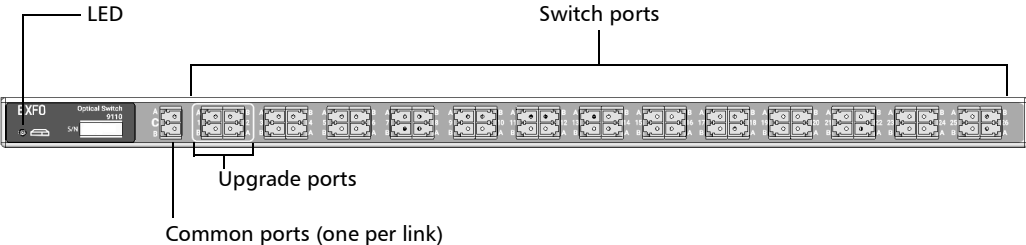

Note: On all RTUe-9110 models shown above, you can use the upgrade ports to cascade external switches, or use them as standard switch ports. The upgrade ports have lower insertion loss (IL) than the other ports, which makes them particularly well suited for switch cascading.

Note: On all RTUe-9110 models shown above, you can use the common port(s) as a connection point with the primary switch when the switch is cascaded, or to receive signal from a test module.

LTBe-9110/RTUe-9110 switch - Back - All models shown above

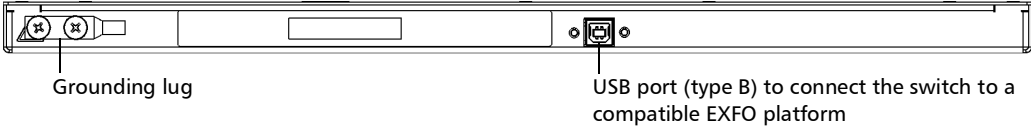

Introducing the Optical Switch

Available Models

RTUe-9120 switch - Front 16 ports

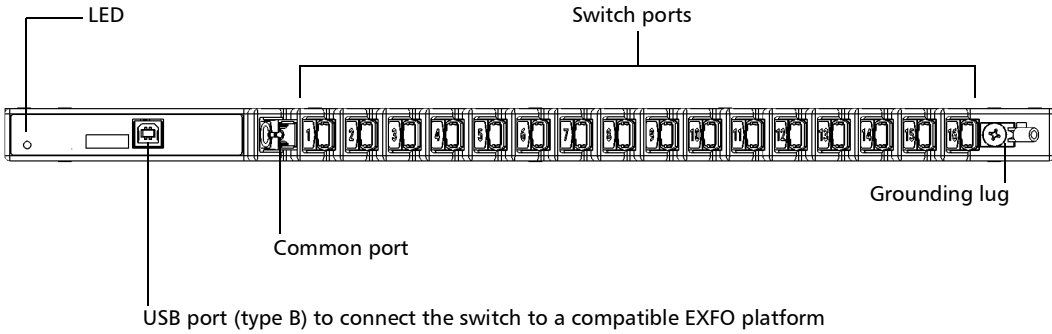

RTUe-9120 switch - Back



Correspondence Between Port Numbers and Fiber Numbers (RTUe-9120)

The table below lists the fiber numbers associated with each port for easier identification.

Note: *The number of ports varies with the model of switch that you have purchased.*

Port Number	Fiber Numbers
1	1 to 16
2	17 to 32
3	33 to 48
4	49 to 64
5	65 to 80
6	81 to 96
7	97 to 112
8	113 to 128
9	129 to 144
10	145 to 160
11	161 to 176
12	177 to 192
13	193 to 208
14	209 to 224
15	225 to 240
16	241 to 256

Introducing the Optical Switch

External Switch LED Indicator Description

External Switch LED Indicator Description

A LED indicator on the front panel of the external switch displays its current status. The table below presents the possible statuses once the initial startup sequence is complete.

LED	Status	Meaning
 ^a	Green	The switch is working properly and is ready.
	Green, blinking	The initialization of the switch is underway.
	Yellow	Non-critical hardware error detected. The temperature of the room where the switch is located could be slightly too low or too high, or there could be a hardware malfunction. Ensure that the temperature falls within the specified operating temperature range of the platform. If the problem persists, contact EXFO.
	Red	Critical hardware error detected. The temperature of the room where the switch is located is critically too low or too high, or there could be a hardware malfunction. Ensure that the temperature falls within the specified operating temperature range of the platform. If the problem persists, contact EXFO.
	Off	Switch is off or not connected to an platform.

- a. If more than one error is detected at the same time, the color of the LED will be set according to the most severe error (red as the most severe, followed by yellow).

Note: For information about the LED indicators on other platforms, refer to the corresponding user documentation.

Basic Switching Principles

The switch ports of 1 x N optical switches are numbered on the front panel, while the common port is identified with a "C."

These switches are bidirectional. This means that the optical signal can either enter through the common port and be directed toward any switch port, or enter through any switch port and then be directed toward the common port.

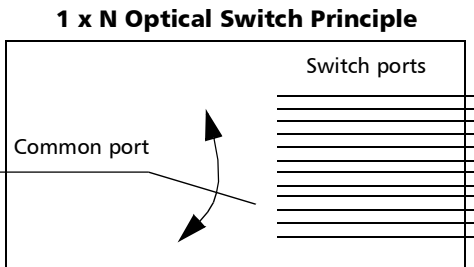

Introducing the Optical Switch

Basic Switching Principles

Duplex switches follow the same principles as 1 x N switches, but each port have two fibers.

1 x N Duplex Optical Switch Principle

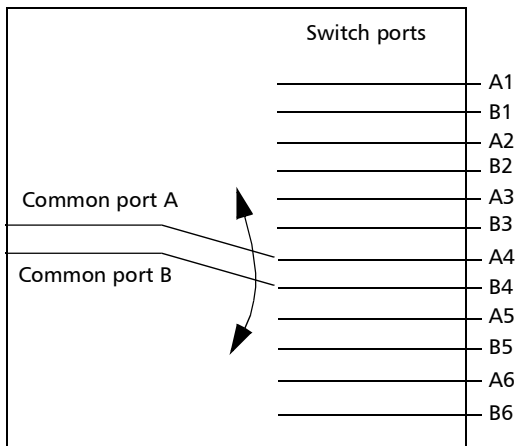

The FTBx-9150 (2 x 2 model) is also a bidirectional switch. The two positions for this switch are known as inserted state and bypass state.

2 x 2 Optical Switch Principle

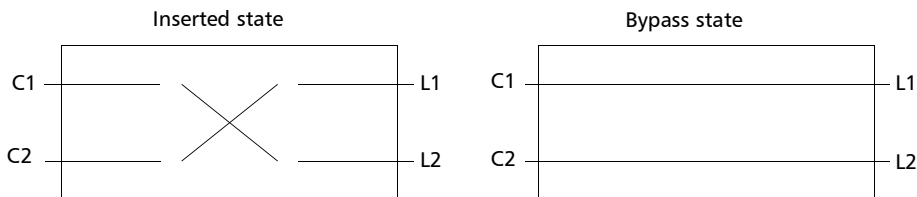

The FTBx-9150 (2 × 4 model) is also a bidirectional switch. As illustrated in the following figure, it can be set to six positions. In three of these positions, one or both input channels do not transmit light to output ports.

2 x 4 Optical Switch Principle

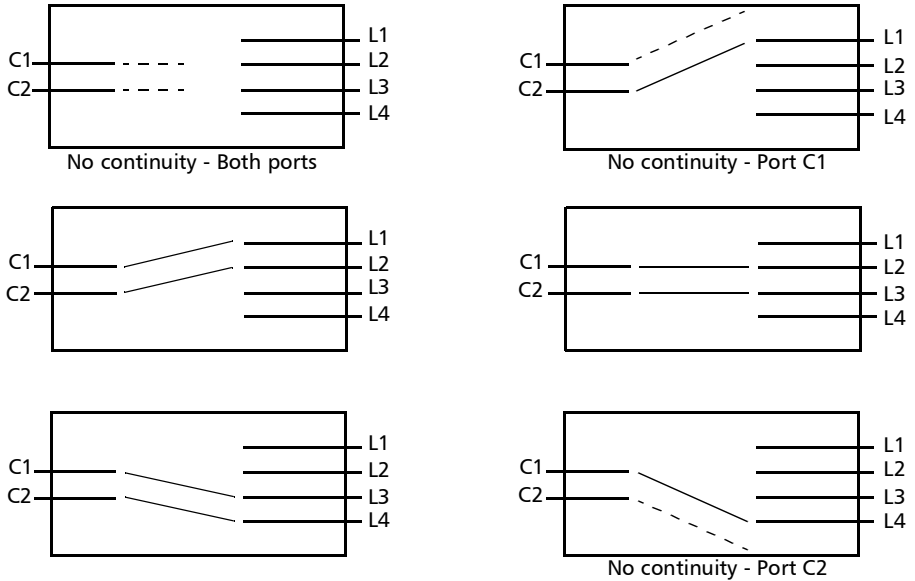

Typical Applications

Testing with Multiple Devices

Using two optical switches, a light source and a power meter, it is possible to perform automated qualification and production testing for multiple devices.

To perform automated qualification and production testing for multiple devices:

1. Connect the modules and DUTs as shown below.

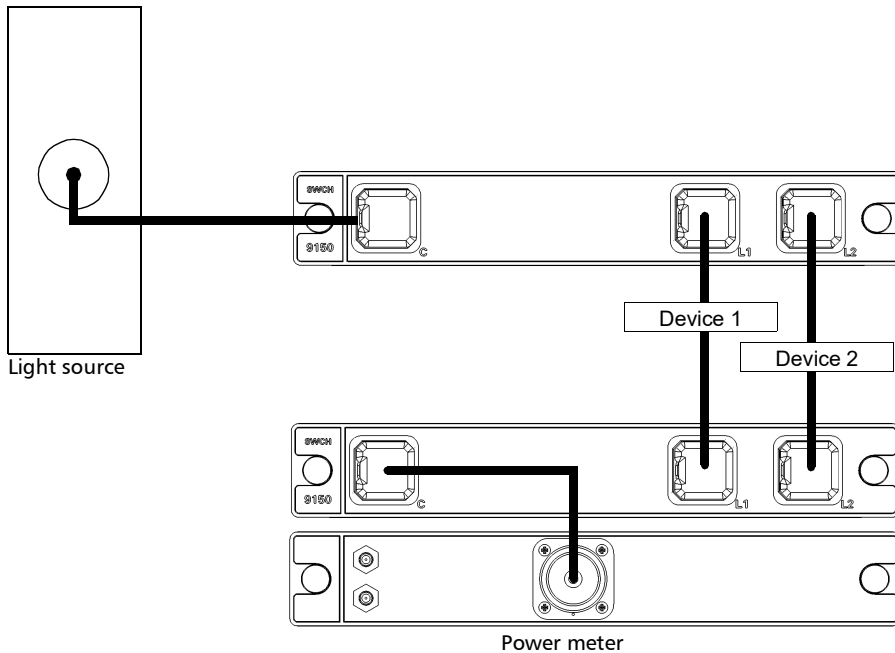

2. Measure the DUTs with the power meter.

Measuring Optical Switch Port Insertion Loss

The insertion loss (IL) of any switch port can be measured using a light source, power meter, and the Optical Switch.

To measure Optical Switch port insertion loss:

1. Connect the light source output port to the power meter detector port using two test jumpers linked with a bulkhead connector.

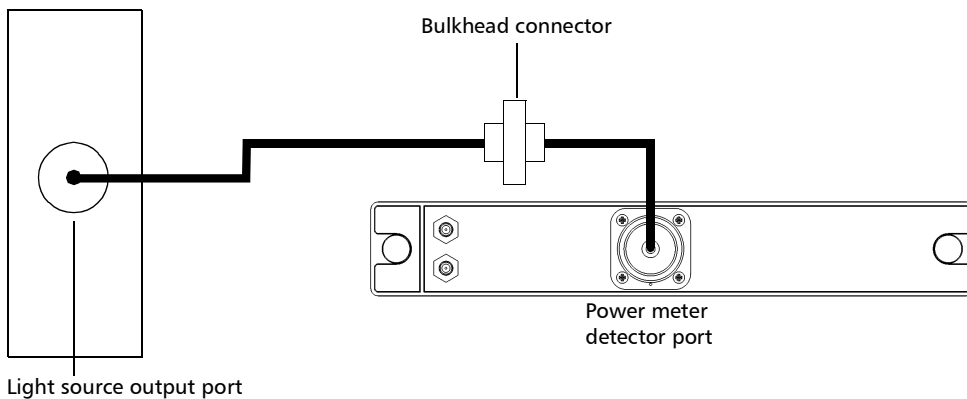

2. Store the power reading obtained as a reference value in the power meter.

Introducing the Optical Switch

Typical Applications

- Using the same test jumpers, connect the light source to one of the switch ports, and connect the switch common port to the power meter detector port (the Optical Switch now replaces the bulkhead connector).

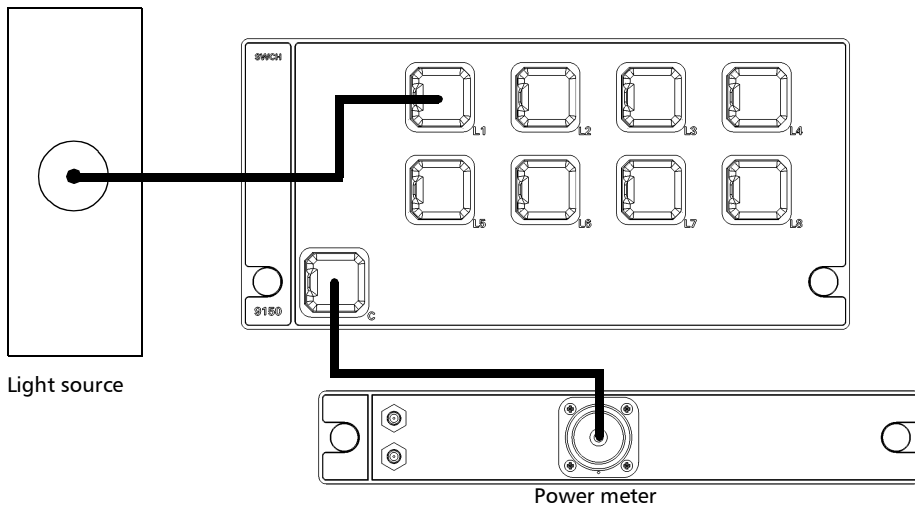

- The IL registered on the power meter will then be the switch port IL including connectors.

Creating Customized Switch Configurations

By interconnecting two or more switch modules, customized switch configurations can be built. For example, 1×2 and 1×8 switches can be connected to create a 2×8 switch configuration. To do so, simply connect the common ports of both switches.

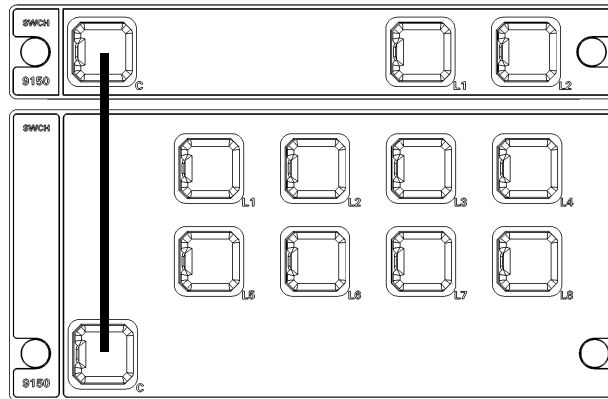

Technical Specifications

To obtain this product's technical specifications, visit the EXFO Web site at www.exfo.com.

Conventions

Before using the product described in this guide, you should understand the following conventions:



WARNING

Indicates a potentially hazardous situation which, if not avoided, could result in *death or serious injury*. Do not proceed unless you understand and meet the required conditions.



CAUTION

Indicates a potentially hazardous situation which, if not avoided, may result in *minor or moderate injury*. Do not proceed unless you understand and meet the required conditions.



CAUTION

Indicates a potentially hazardous situation which, if not avoided, may result in *component damage*. Do not proceed unless you understand and meet the required conditions.



IMPORTANT

Refers to information about this product you should not overlook.

2 **Safety Information**

Your Optical Switch does not contain laser components in itself. However, you will be using it with light sources.

General Safety Information



WARNING

Do not install or terminate fibers while a light source is active. Never look directly into a live fiber and ensure that your eyes are protected at all times.



WARNING

The use of controls, adjustments and procedures, namely for operation and maintenance, other than those specified herein may result in hazardous radiation exposure or impair the protection provided by this unit.



WARNING

If the equipment is used in a manner not specified by the manufacturer, the protection provided by the equipment may be impaired.



WARNING

Use only accessories designed for your unit and approved by EXFO. For a complete list of accessories available for your unit, refer to its technical specifications or contact EXFO.



IMPORTANT

Refer to the documentation provided by the manufacturers of any accessories used with your EXFO product. It may contain environmental and/or operating conditions limiting their use.

Safety Information

General Safety Information



IMPORTANT



When you see the following symbol on your unit , make sure that you refer to the instructions provided in your user documentation. Ensure that you understand and meet the required conditions before using your product.



IMPORTANT



When you see the following symbol on your unit , it indicates that the unit is equipped with a laser source, or that it can be used with instruments equipped with a laser source. These instruments include, but are not limited to, modules and external optical units.



IMPORTANT

Other safety instructions relevant for your product are located throughout this documentation, depending on the action to perform. Make sure to read them carefully when they apply to your situation.













CAUTION

Your Optical Switch contains sensitive precision optical components. To ensure reliable, long-term service, observe proper handling and operating instructions. At no time should the switch be subject to shock or impact.

Other Safety Symbols on Your Unit

One or more of the following symbols may also appear on your unit.

Symbol	Meaning
	Direct current
	Alternating current
	The unit is equipped with an earth (ground) terminal.
	The unit is equipped with a protective conductor terminal.
	The unit is equipped with a frame or chassis terminal.
	On (Power)
	Off (Power)
 OR 	On/off (Power)
	Fuse

Electrical Safety Information



WARNING

Unless otherwise specified, all interfaces are intended for connection to ES1 circuits only.



CAUTION

Position the unit so that the air can circulate freely around it.

The equipment ratings for your product are as follows:

- The maximum input power for the FTBx Series Optical Switches is 4 W. For more information on product safety and equipment ratings, refer to the user documentation of your platform.
- The maximum input power for the LTBe-9110 and RTUe-9110 switches is 4.4 V - 5.25 V $\overline{\text{---}}$; 700 mA. For more information on product safety and equipment ratings, refer to the user documentation of your platform.
- The maximum input power for the RTUe-9120 switches is 4.4 V - 5.25 V $\overline{\text{---}}$; 500 mA. For more information on product safety and equipment ratings, refer to the user documentation of your platform.

For more information on product safety and equipment ratings, refer to the user documentation of your platform used with your optical switch.

3 Operating the Optical Switch

The Optical Switch comes in different models, depending on the number of ports and switch configurations it has. To use its different models more efficiently, follow the instructions provided in this section.

Before using the Optical Switch in a test setup, you must first connect the ports to other test components and select a switching configuration.

Note: *You can configure your switch before connecting it to your test setup.*



CAUTION

Your Optical Switch contains sensitive precision optical components. To ensure reliable, long-term service, observe proper handling and operating instructions. At no time should the module be subject to shock or impact.

Installing an External Switch in a Rack

- The external switch is designed to be installed in 19-inch racks with the provided mounting brackets and in 21-inch (ETSI) racks with both the provided mounting brackets and adapters. It will not fit into 23-inch racks.

The height of the external switch is half a rack unit (0.5U) high or 22,23 mm (0.87 in.).

- When operating the switch, select a location that provides at least:
 - 75 mm (3 in.) of rear clearance
 - 75 mm (3 in.) of front clearance

Note: *There is no need to leave an empty slot between switches when you stack them one on top of the other inside a rack.*

Operating the Optical Switch

Installing an External Switch in a Rack



WARNING

- The equipment rack must be anchored to an unmovable support to prevent it from falling over when one or more units are extended in front of the rack on slides. You must also consider the weight of any other device installed in the rack. A crush hazard exists if the rack tilts forward, which could cause serious injury.
- Mounting of the unit in a rack or cabinet should be such that a hazardous condition is not achieved due to uneven mechanical loading.



CAUTION

To ensure that the RTUe-9110/RTUe-9120 external switches have optimum support, EXFO recommends to install them on top of an RTU-2 unit in the rack.

Note: *The instructions presented in the procedure hereafter apply to the LTBe-9110, RTUe-9110 and RTUe-9120 switches regardless of which switch appears in the illustrations.*

To install your unit or external switch in a rack:

1. Ensure that no USB cable, or optical fibers are connected to the external switch.
2. Position the switch so that its bottom panel rests on a flat surface such as a table.



IMPORTANT

The external switches are only half a unit high.

To maximize the utilization of rack space when you install external switches, EXFO recommends to alternate the position of the brackets for each switch. The brackets should be placed with their rack screw holes at the bottom for the first (primary) switch, at the top for the second, at the bottom for the next switch, and so on (see illustrations hereafter).

Operating the Optical Switch

Installing an External Switch in a Rack

3. Align the holes of the first bracket with the holes of the switch's casing at the position that best suits your installation needs. You can even invert position of the mounting bracket if necessary.

Brackets in standard position

LTBe-9110/RTUe-9110 - Rack screw holes at the bottom

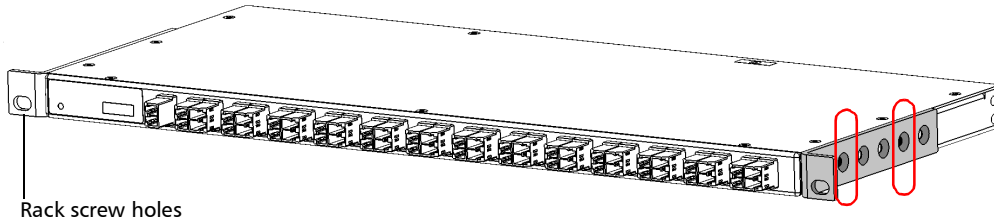

LTBe-9110/RTUe-9110 - Rack screw holes at the top

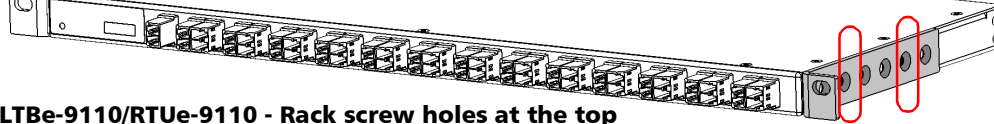

Brackets in inverted position

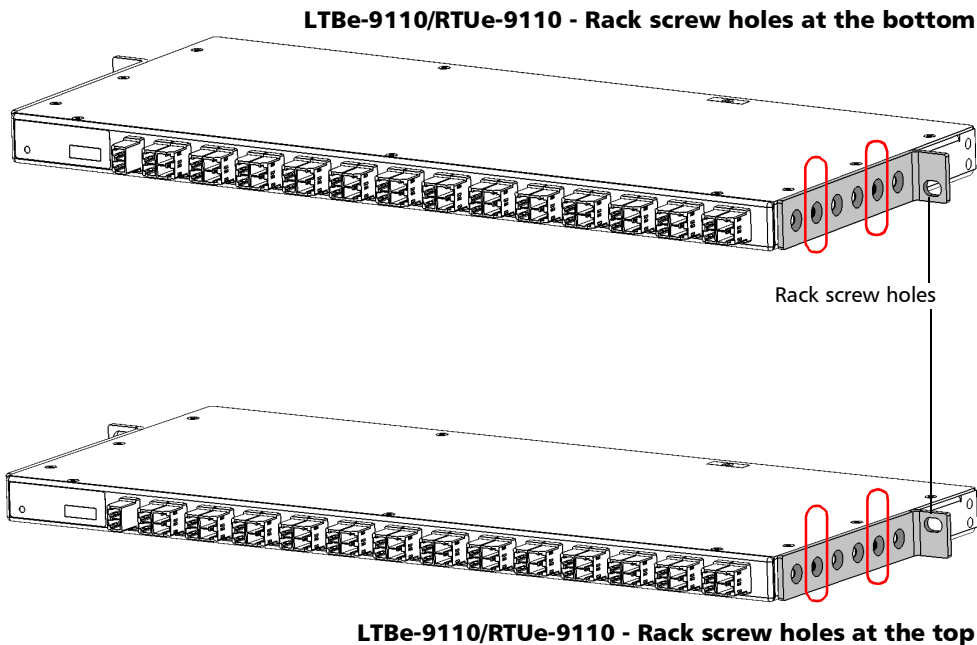

4. Fix the first bracket on the switch with the supplied screws (two screws per bracket).
5. Repeat steps 3 and 4 with the other bracket, ensuring that you place the bracket at the exact same position (orientation of the bracket, set of holes on the bracket and on the switch's casing).

Operating the Optical Switch

Installing an External Switch in a Rack

6. If you have a 21-inch (ETSI) rack, install the adapters as follows:
 - 6a. Align one of the round holes of the adapter with the screw hole of the mounting bracket previously installed on the switch. You can use the adapter's top or bottom round hole, depending on your installation needs.

RTUe-9120 - Adapter in standard position

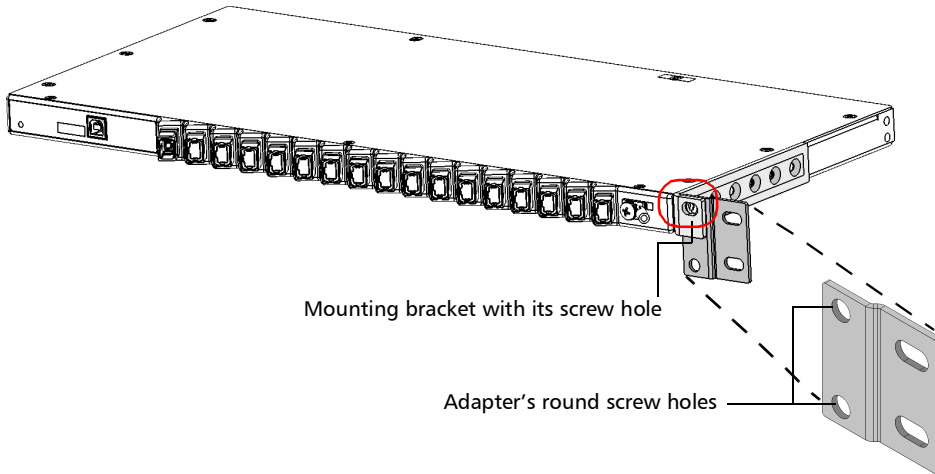

Note: *To better suit your installation needs, you can flip the orientation of the adapter, as long as you use one of its round holes to attach it to the mounting bracket.*

Operating the Optical Switch

Installing an External Switch in a Rack

- 6b.** Fix the first adapter on the switch's mounting bracket with the supplied screw, flat washer and nut as shown below.

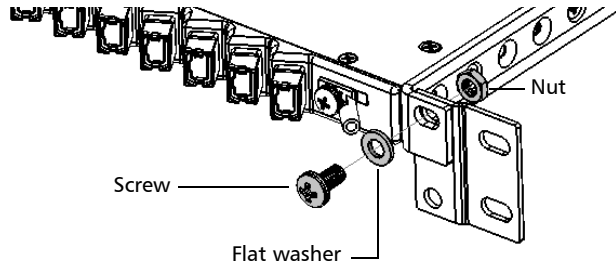

- 6c.** Repeat steps 6a and 6b with the other adapter, ensuring that you place the adapter at the exact same position (orientation of the adapter, hole on the adapter).
- 7.** Place the switch in the rack at the desired height.

Operating the Optical Switch

Installing an External Switch in a Rack

8. Fix the switch in place using the hardware supplied with the rack. Use one screw per side.

To ground your switch properly, you must ensure that there is a metal-to-metal contact between the rack and the mounting hardware. For this reason, EXFO recommends to use thread-forming screws, star (tooth) lock washers, or similar hardware that remove any paint or non-conductive coatings. For more information, see *Grounding an External Switch* on page 33.

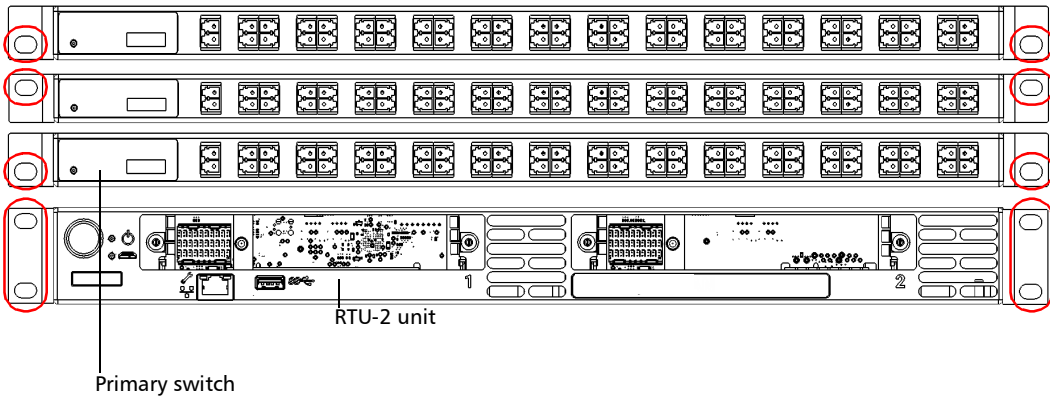

Grounding an External Switch

To avoid the potential for an electrical shock hazard, you must reliably connect an earth grounding conductor to the external switch.



WARNING

All wiring and installation must be in accordance with local building and electrical codes acceptable to the authorities in the countries where the equipment is installed and used.

If you are not sure on how to proceed, consult a certified electrician.

If you are working with an RTUe-9120 switch, you can either ground it from its front panel or from its back panel (not both), depending on your installation needs. See the corresponding procedure hereafter for details.

To ground an LTBe-9110 or RTUe-9110 external switch:

1. Remove the two Phillips screws and the grounding lug from the back panel of your switch.



2. Prepare the ground wire (#6 AWG, green), and attach one of its ends to the switch's grounding lug using a crimping tool.
3. Use the two Phillips screws to attach the grounding lug and wire assembly to the back panel of your switch.
4. Ground the other end of the wire as per your local regulation.

Your switch is now grounded properly.

Operating the Optical Switch

Grounding an External Switch

To ground the RTUe-9120 external switch:

1. Remove the Phillips screw and the grounding lug from the front panel of your switch.

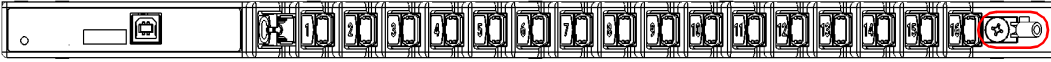

2. Prepare the ground wire (#10 AWG, green), and attach one of its ends to the switch's grounding lug using a crimping tool.
3. Depending on your installation needs, use the Phillips screw to attach the grounding lug and wire assembly to the front panel of your switch.

Front panel

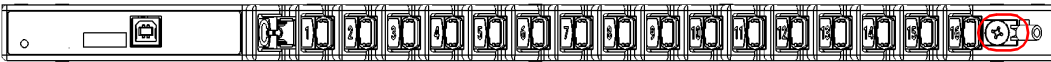

OR

Use the Phillips screw to attach the grounding lug and wire assembly to the back panel of your switch in one of the two corresponding holes.

Back panel

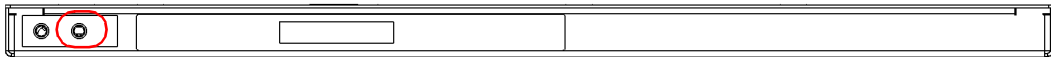

Note: Attach a grounding lug and wire assembly either to the front panel or the back panel of your unit, but not to both.

4. Ground the other end of the wire as per your local regulation.
- Your switch is now grounded properly.

Connecting an LTBe-9110 External Switch to a Platform

Depending on your testing needs, you may want to connect external switches to your platform to increase the number of optical ports available.



IMPORTANT

Although there are multiple USB 3.0 ports on your platform, EXFO recommends to connect a single LTBe-9110 unit. If you require more than one Optical Switch in your application, contact EXFO.

Note: *On all switch models, the group of upgrade ports is outlined with a rounded rectangle for easier identification.*

If you want to remove a switch from the system, ensure that no test is underway, and then simply disconnect the optical fibers and the USB cable.

Operating the Optical Switch

Connecting an LTBe-9110 External Switch to a Platform



IMPORTANT

To let the front USB and management ports free for potential maintenance, EXFO recommends to keep all non-optical connections to the back of the unit.

To connect a single RTUe-9110 switch to your RTU-2 unit:

1. Connect the provided USB cable to the USB port (B type) located on the back panel of the switch.



2. Connect the other end of the USB cable to one of the USB ports located on the back panel of the RTU-2 unit.

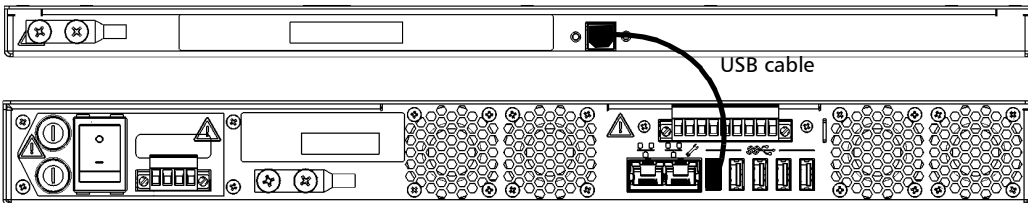

Connecting RTUe-9110 External Switches to the RTU-2 Unit

Depending on your testing needs, you may want to connect external switches to your RTU-2 unit to increase the number of optical ports available.

The recommended number of switches that you can connect (cascade) on a single RTU-2 unit for a given optical link depends on the model of RTUe-9110 switch that you are using.

Model	Maximum recommended number of connected switches
Single channel width – 26 ports (2 upgrade ports)	3
Single channel width – 52 ports (4 upgrade ports)	5
Double channel width – 2 links of 26 ports (2 upgrade ports)	3

Note: *If you intend to work with a mix of 26-port and 52-port single-channel-width switches, you may want to use a 52-port switch as your primary switch to benefit from four upgrade ports instead of two.*

Note: *On all switch models, the group of upgrade ports is outlined with a rounded rectangle for easier identification.*

If you want to remove a switch from the system, ensure that no test is underway, and then simply disconnect the optical fibers and the USB cable.

Operating the Optical Switch

Connecting RTUe-9110 External Switches to the RTU-2 Unit



IMPORTANT

To let the front USB and management ports free for potential maintenance, EXFO recommends to keep all non-optical connections to the back of the unit.

To connect a single RTUe-9110 switch to your RTU-2 unit:

1. Connect the provided USB cable to the USB port (B type) located on the back panel of the switch.



2. Connect the other end of the USB cable to one of the USB ports located on the back panel of the RTU-2 unit.

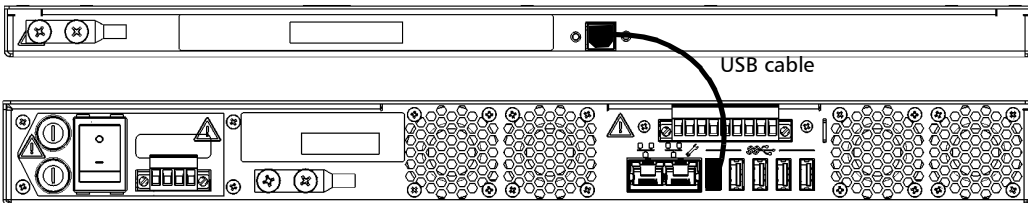

Operating the Optical Switch

Connecting RTUe-9110 External Switches to the RTU-2 Unit

To connect several RTUe-9110 switches to your RTU-2 unit (cascading):

1. Ensure that all the switches are connected to the RTU-2 unit with the provided USB cables as follows:
 - 1a. Connect the provided USB cables to the USB ports (B type) located on the back panel of each switch that you want to use.



- 1b. Connect the other end of the USB cables to one of the USB ports located on the back panel of the RTU-2 unit.

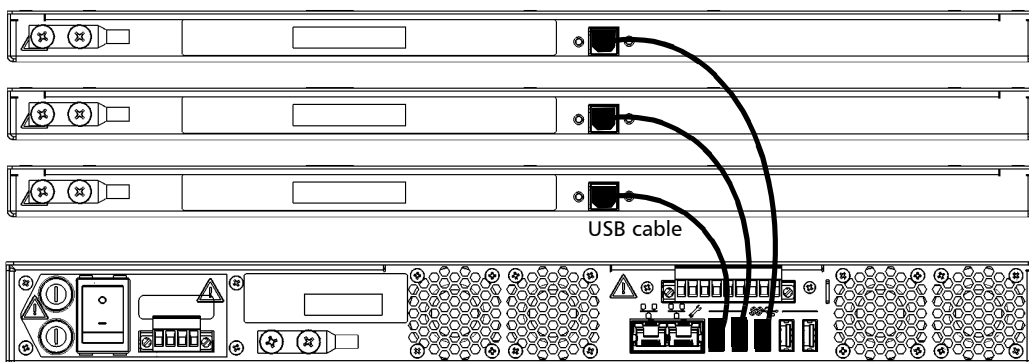

2. Clean and inspect the patchcords that you will be using to connect the RTUe-9110 switches between them.
3. Clean and inspect the ports (connectors) of the RTUe-9110 switches. For more information, see *Cleaning LT Connectors* on page 70.



IMPORTANT

For optimum results and to avoid affecting the power budget of the signal, always use the upgrade ports to connect switches to one another.

Operating the Optical Switch

Connecting RTUe-9110 External Switches to the RTU-2 Unit

- 4. If you are working with switches having a single channel width, connect the first upgrade port of the primary switch to the common port of the second switch.

Single-channel-width switches (52-port model shown)

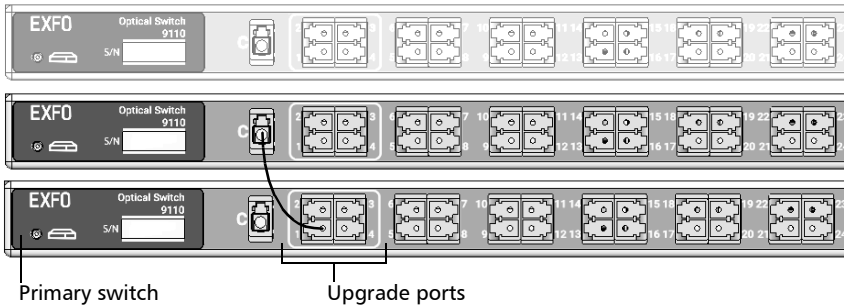

OR

If you are working with switches having a double channel width, connect the first A and B upgrade ports of the primary switch to the corresponding common ports of the second switch. Ensure that you link ports with the same letter (A-A and B-B).

Double-channel-width switches

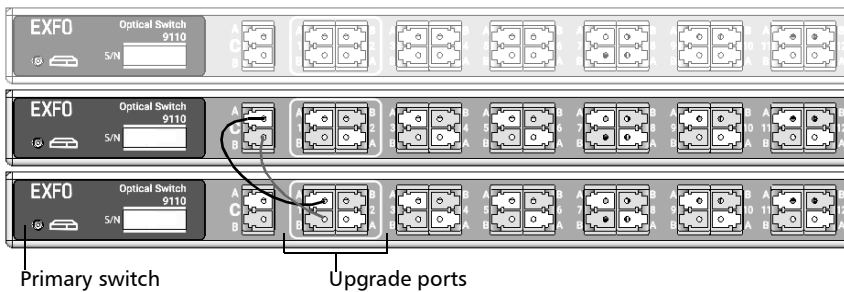

Note: The common port(s) of the primary switch are used to receive the signal from a test module.

Operating the Optical Switch

Connecting RTUe-9110 External Switches to the RTU-2 Unit

5. If you are working with switches having a single channel width, connect the next upgrade port of the primary switch to the common port of the next switch.

Single-channel-width switches (52-port model shown)

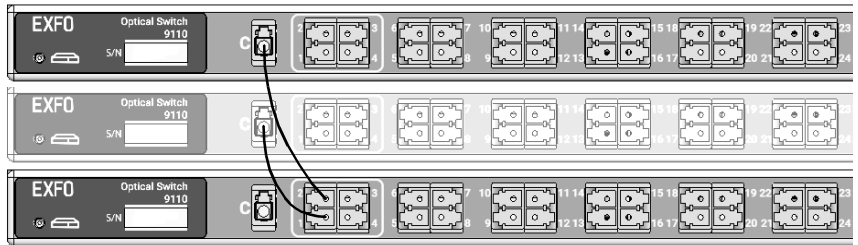

OR

If you are working with switches having a double channel width, connect the second A and B upgrade ports of the primary switch to the corresponding common ports of the next switch. Ensure that you link ports with the same letter (A-A and B-B).

Double-channel-width switches

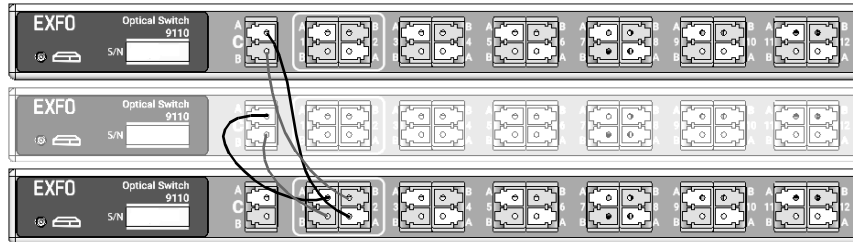

6. If your primary switch is a single channel width switch having 52 ports, repeat step 5 with the remaining switches that you want to cascade (up to two more switches).

Operating the Optical Switch

Connecting RTUe-9120 External Switches to the RTU-2 Unit

Connecting RTUe-9120 External Switches to the RTU-2 Unit

Depending on your testing needs, you may want to connect external switches to your RTU-2 unit to increase the number of optical ports available.

You can connect several RTUe-9120 external switches on a single RTU-2 unit. In such a case, each of these external switches will receive its optical signal from one of the ports of an FTBx switch with a sufficient number of ports (Ex.: FTBx-9160 for up to four external switches), inserted in the RTU-2.

If you want to remove an external switch from the system, ensure that no test is underway, and then simply disconnect the optical fibers and the USB cable.

To connect a single RTUe-9120 switch to your RTU-2 unit:

1. Connect the provided USB cable to the USB port (B type) located on the front panel of the switch.

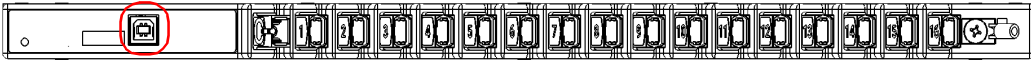

2. Connect the other end of the USB cable to one of the USB ports located on the back panel of the RTU-2 unit.

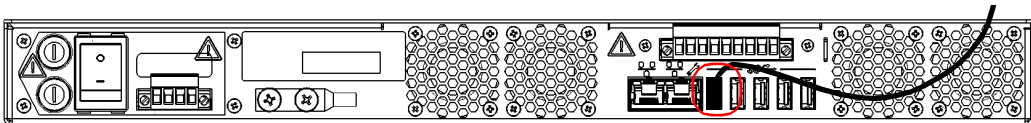

Operating the Optical Switch

Connecting RTUe-9120 External Switches to the RTU-2 Unit

To connect several RTUe-9120 switches to your RTU-2 unit:

1. Ensure that all the switches are connected to the RTU-2 unit with the provided USB cables as follows:
 - 1a. Connect the provided USB cables to the USB ports (B type) located on the front panel of each switch that you want to use.

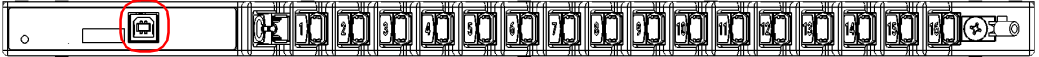

- 1b. Connect the other end of the USB cables to one of the USB ports located on the back panel of the RTU-2 unit.

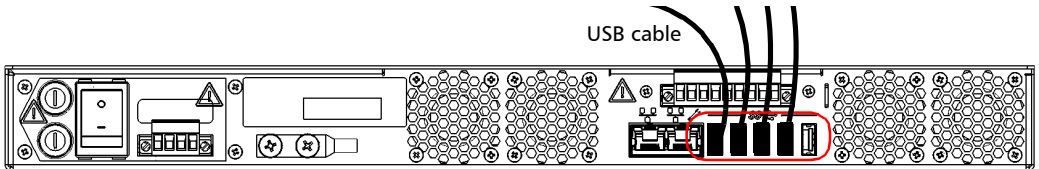

Operating the Optical Switch

Connecting RTUe-9120 External Switches to the RTU-2 Unit

2. Insert the FTBx switch in any module slot of the RTU-2 unit. For more information on module insertion and removal, refer to the RTU-2 user guide.

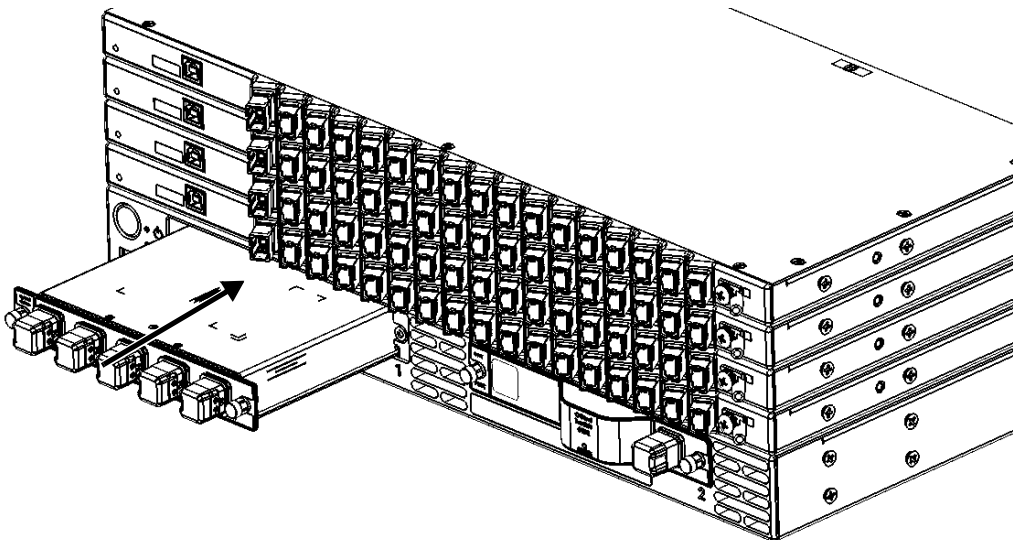

Note: The common port of the FTBx switch is used to receive the signal from a test module such as an OTDR that would be inserted in the other slot of the RTU-2 unit.

3. Clean and inspect the patchcords that you will be using to connect the FTBx switch to the RTUe-9120 switches.
4. Clean and inspect the ports (connectors) of the RTUe-9120 switches. For more information, see *Cleaning and Inspecting MPO-Type Connectors* on page 71.
5. Clean and inspect the ports (connectors) of the FTBx switch. For more information, see the section related to the type of connector of your switch in this user documentation.

Operating the Optical Switch

Connecting RTUe-9120 External Switches to the RTU-2 Unit

6. Connect the first port of the FTBx switch to the common port of the first RTUe-9120 switch.

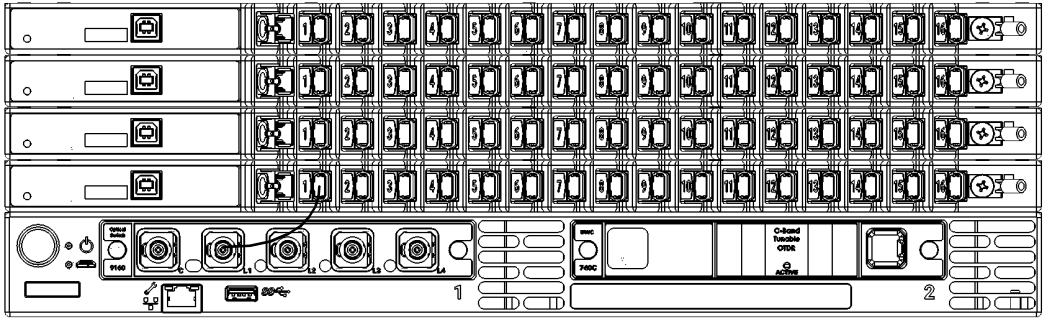

Note: Since the RTUe-9120 switch is equipped with unpinned MPO ports (two rows of eight fibers each), you will need a patchcord with a pinned MPO connector.

7. Repeat step 6 with the remaining switches that you want to connect to the RTU-2 unit.

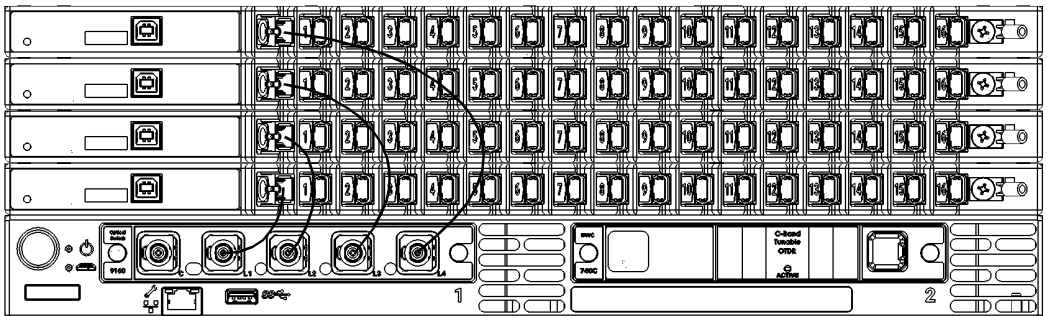

Operating the Optical Switch

Installing the EXFO Universal Interface (EUI)

Installing the EXFO Universal Interface (EUI)

The EUI fixed baseplate is available for connectors with angled (APC) or non-angled (UPC) polishing. The type of border around the baseplate indicates which type of connector it is designed for.

Green border
indicates APC
option

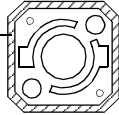

Bare metal, or a
black or dark gray
border indicates
UPC option

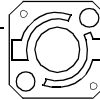

To install an EUI connector adapter onto the EUI baseplate:

1. Hold the EUI connector adapter so the dust cap opens downwards.

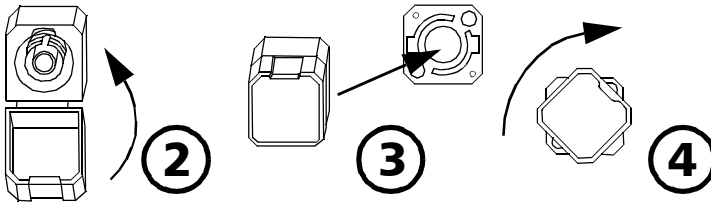

2. Close the dust cap in order to hold the connector adapter more firmly.
3. Insert the connector adapter into the baseplate.
4. While pushing firmly, turn the connector adapter clockwise on the baseplate to lock it in place.

Selecting a Module from a Web Browser

Note: This feature is not necessarily available on all platforms.

If you are accessing your module from a Web browser, you can select which module or application you want to work with. Simply enter `http://[IP address of your unit]` in your browser address box.

To only view the Optical Switch modules, enter `http://[IP address of your unit]/FTBx9150`.

Search filter

EXFO LTB-8 Module Selector 192.168.200.11 S.N.: 12334567890

1	FTBx-1750-04-EI High-Performance Optical Power Meter (S.N.: 636990)	▲	▶
2	FTBx-3500 Variable Optical Attenuator (S.N.: SIMFTB3500DEI)		▶
3	FTBx-1750-02-EI High-Performance Optical Power Meter (S.N.: 614552)	▲	▶
5	FTBx-3500-BI Variable Optical Attenuator (S.N.: SIMFTB3500BEA)		▶
8	FTBx-3500 Variable Optical Attenuator (S.N.: SIMFTB3500BIEA)		▶

Location of module on unit.

Module is ejecting.

Module was ejected.

Click to start the application.

Note: The list you see on-screen will differ depending on which modules are in your unit.

Operating the Optical Switch

Selecting an Optical Switch in the Array (LTBe-9110 Models)

Selecting an Optical Switch in the Array (LTBe-9110 Models)

When working with a source that features arrays, you have to select which one you want to work with.

To select an array and start the corresponding application:

From Toolbox X, locate your module, then click the array you want to use.

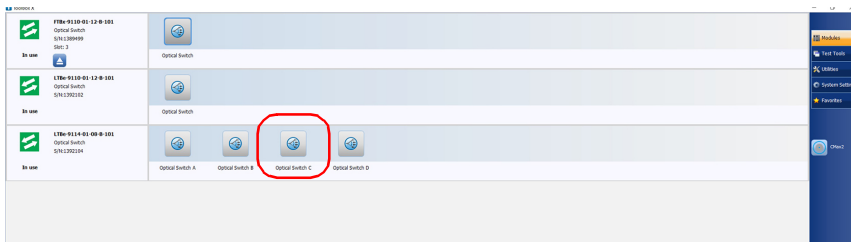

The corresponding display appears. The array is identified next to the module number.

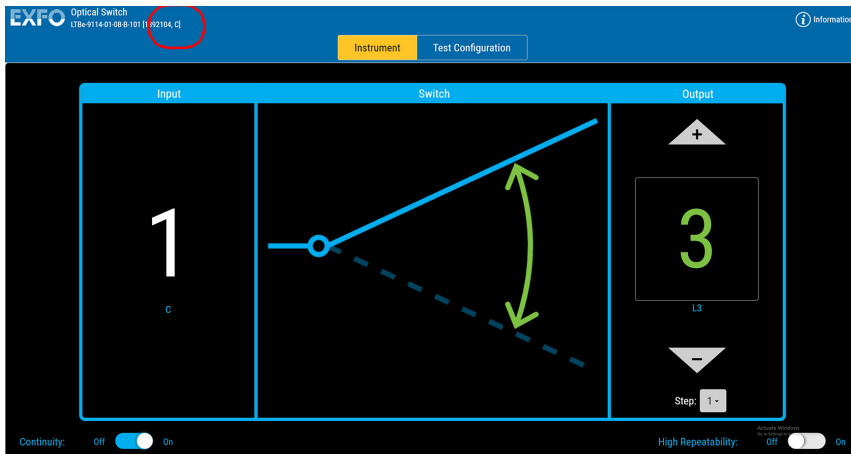

Note: *You can start more than one array at a time. Simply return in ToolBox X and select the next array you want to use.*

Cleaning and Connecting Optical Fibers



IMPORTANT

To ensure maximum power and to avoid erroneous readings:

- ▶ Always inspect fiber ends and make sure that they are clean as explained below before inserting them into the port. EXFO is not responsible for damage or errors caused by bad fiber cleaning or handling.
- ▶ Ensure that your patchcord has appropriate connectors. Joining mismatched connectors will damage the ferrules.

To connect the fiber-optic cable to the port:

- 1.** Inspect the fiber using a fiber inspection scope (or probe). If the fiber is clean, proceed to connecting it to the port. If the fiber is dirty, clean it as explained below.
- 2.** Clean the fiber ends as follows:
 - 2a.** Gently wipe the fiber end with a lint-free swab dipped in optical-grade liquid cleaner.
 - 2b.** Use a dry swab to dry the connector completely.
 - 2c.** Visually inspect the fiber end to ensure its cleanliness.

Operating the Optical Switch

Cleaning and Connecting Optical Fibers

3. Carefully align the connector and port to prevent the fiber end from touching the outside of the port or rubbing against other surfaces.

If your connector features a key, ensure that it is fully fitted into the port's corresponding notch.

4. Push the connector in so that the fiber-optic cable is firmly in place, thus ensuring adequate contact.

If your connector features a screw sleeve, tighten the connector enough to firmly maintain the fiber in place. Do not overtighten, as this will damage the fiber and the port.

Note: *If your fiber-optic cable is not properly aligned and/or connected, you will notice heavy loss and reflection.*

EXFO uses good quality connectors in compliance with EIA-455-21A standards.

To keep connectors clean and in good condition, EXFO strongly recommends inspecting them with a fiber inspection scope (or probe) before connecting them. Failure to do so may result in permanent damage to the connectors and degradation in measurements.

Optimizing the Application for Repeatability

Note: *This feature is not necessarily available on all platforms.*

The optimization for repeatability ensures better accuracy in positioning the light path when switching.

- With optimization activated, every time a switching occurs, the switch mechanism returns to the “no continuity” (**Off**) position before aligning to a new channel position. This option provides better precision, but with slower switching.
- With optimization deactivated, the switch mechanism goes directly to the new channel position. This option provides faster switching, but with less precision.

Note: *This option is NOT available on the 1 x 2 and 2 x 2 models.*

To optimize switching for repeatability:

From the main window, put the **High Repeatability** switch to the **On** position.

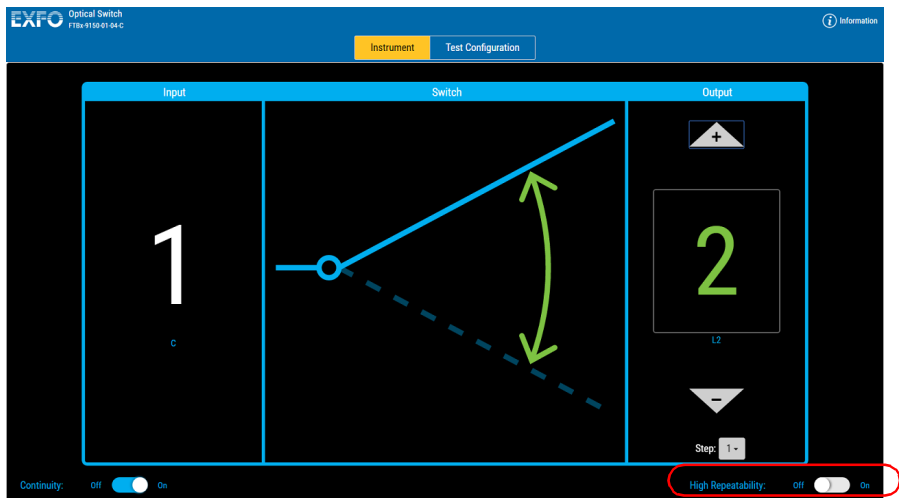

Operating the Optical Switch

Selecting Configurations with the 1 x N Model

Note: *This feature is not necessarily available on all platforms.*

The different configurations available in the 1 x N switch model allow you to access a number of switch possibilities.

Depending on the module, you can also enable the continuity of the signal.

To set the route on the 1 x N switch:

In the **Output** pane, use the up and down arrow buttons to reach the desired value.

Note: *The Step list will indicate how many values are skipped when you click on the arrow buttons.*

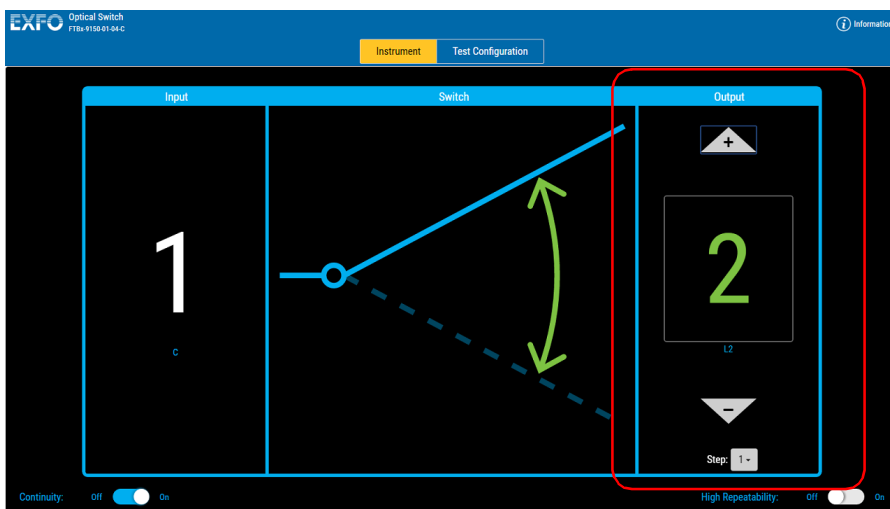

Operating the Optical Switch

Selecting Configurations with the 1 x N Model

OR

On some models, you can click directly on the value and enter a specific number or position.

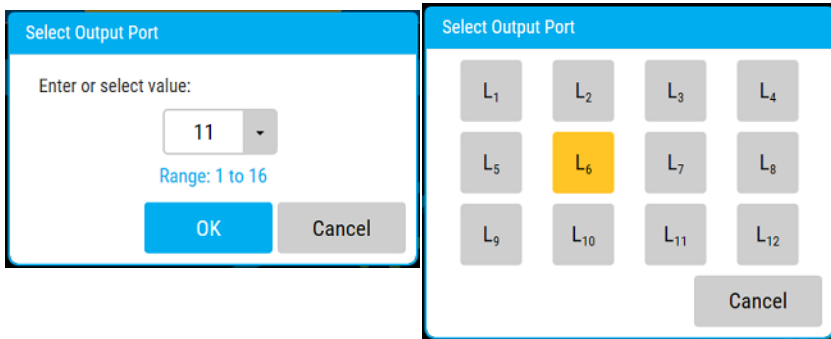

Operating the Optical Switch

Selecting Configurations with the 1 x N Model

To use the continuity:

1. Set the **Continuity** switch to the **On** or **Off** position, depending on whether or not you want the light signal to pass through the optical switch.

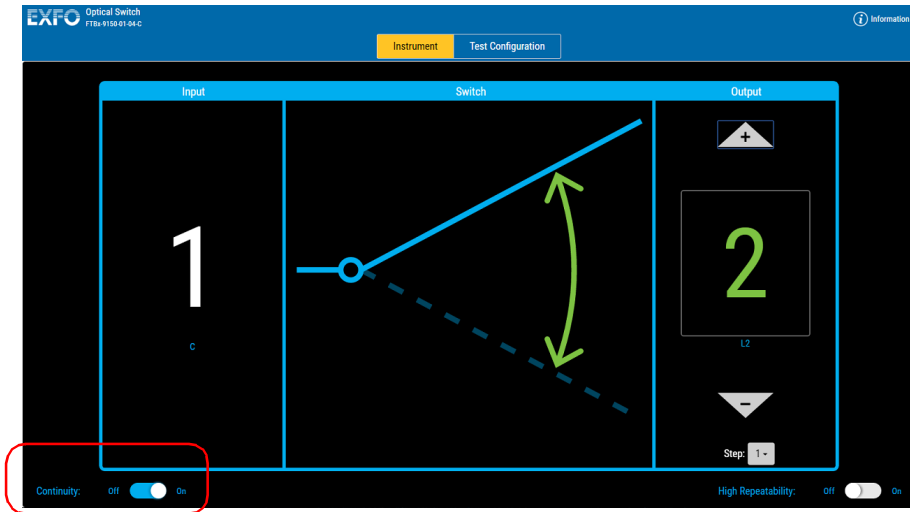

2. In the **Output** panel, select the port through which you want to direct the light.

Note: You can change the output port at any time, and as many times as you want. You cannot preset output switch port activation sequences from the control application with 1 x N optical switches. You must activate each port manually.

Selecting Configurations with the 2 x 2 Model

Note: *This feature is not necessarily available on all platforms.*

The 2 x 2 optical switch model offers two configurations:

- Insert mode: Input 1 will be linked to output 1, and input 2 will be linked to output 2.
- Bypass mode: Input 1 will be linked to output 2 and vice-versa.

Note: *See Basic Switching Principles on page 13 for details.*

To select a configuration with the 2 x 2 optical switch model:

In the **Switch** panel, use the two buttons to select which configuration you want to use.

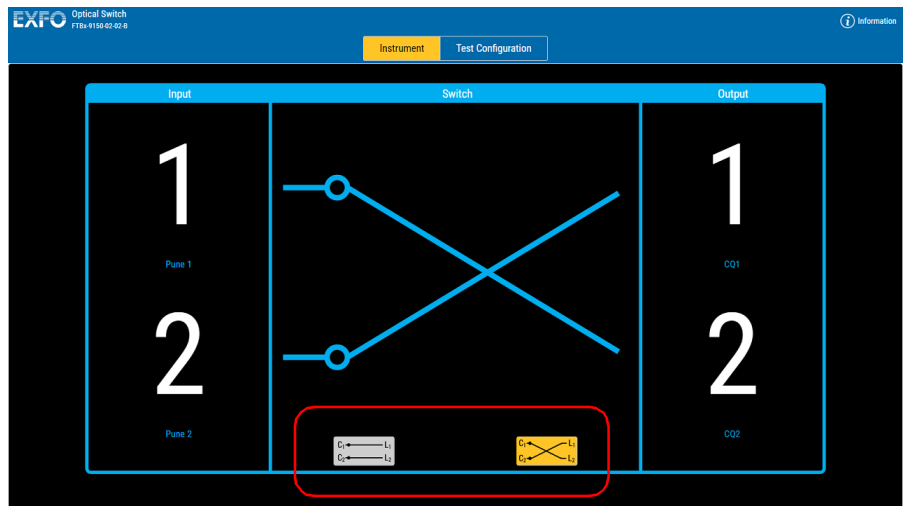

Note: *For the 2 x 2 model, the **Continuity** function is not available.*

Operating the Optical Switch

Selecting Configurations with the 2 x 4 Model

Note: This feature is not necessarily available on all platforms.

The different configurations available with the 2 x 4 optical switch model provides six switch possibilities.

Note: For more information on 2 x 4 model configurations, see Basic Switching Principles on page 13.

To select a configuration with the 2 x 4 optical switch model:

In the **Output** panel, use the arrow buttons to select configuration you want and display the relevant output ports.

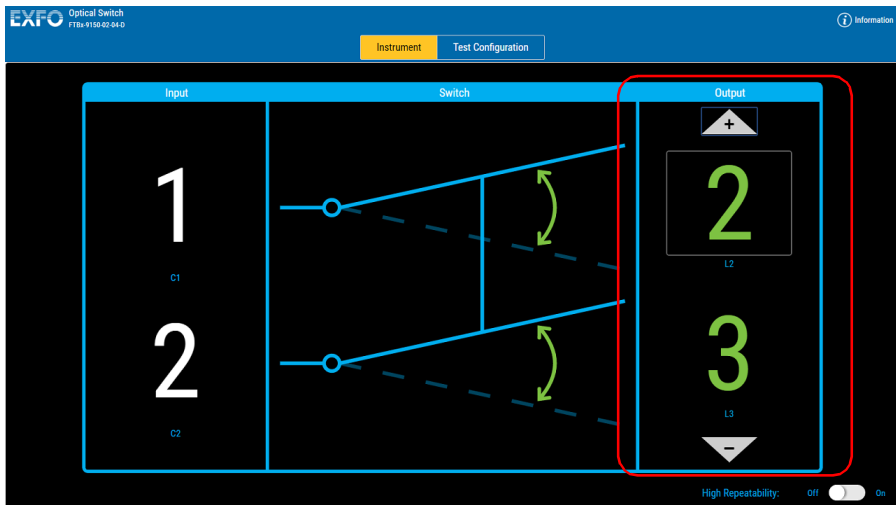

OR

Click directly in the output window to select the position in the list of available choices.

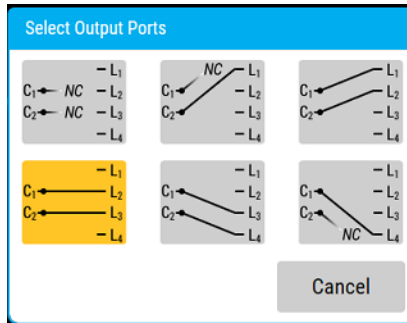

Configuring Port Names

Note: This feature is not necessarily available on all platforms.

You can modify the input and output port names for your switch to help you identify them. The names will appear under the port number in the **Instrument** function tab.

To enter a name for the ports:

1. Select the **Test Configuration** function tab.
2. Modify the names of the ports as needed.

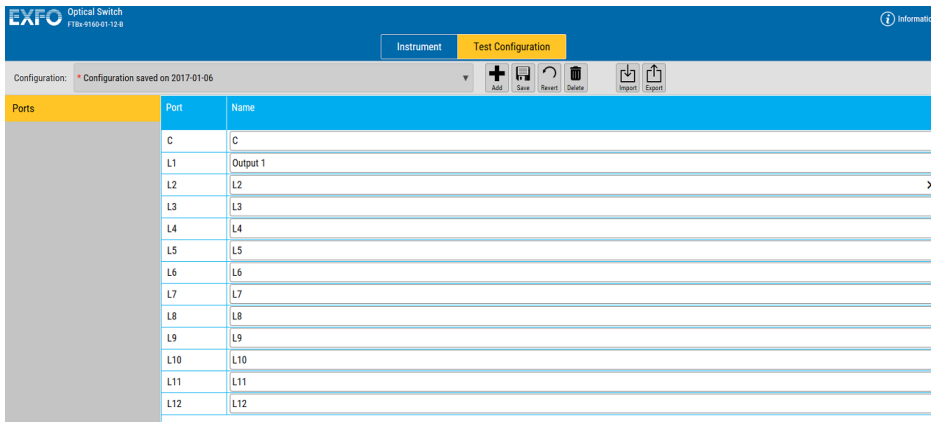

The changes are reflected automatically in the **Instrument** function tab.

Managing Configurations

Note: *This feature is not necessarily available on all platforms.*

You can create configurations that will keep your test settings. The actions made on the configuration (saving, deleting, etc.) affect all tabs of the unit at the same time.

The configuration will include the following items:

- Selected output ports
- Names for the input and output ports
- High repeatability and continuity settings

Operating the Optical Switch

Managing Configurations

To save changes in an existing configuration:

1. Select the **Test Configuration** tab.

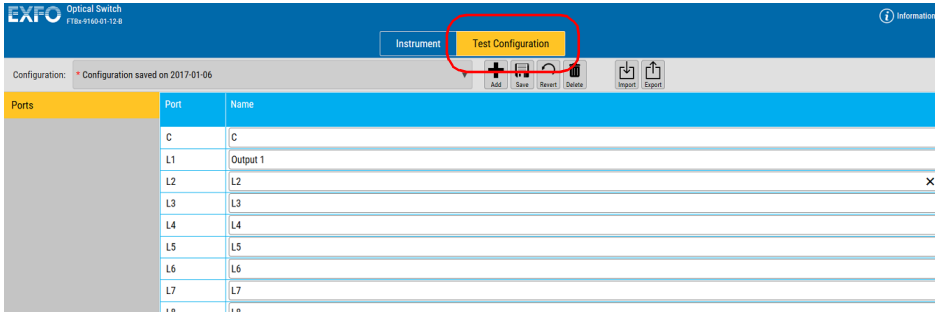

2. Select a configuration in the list.

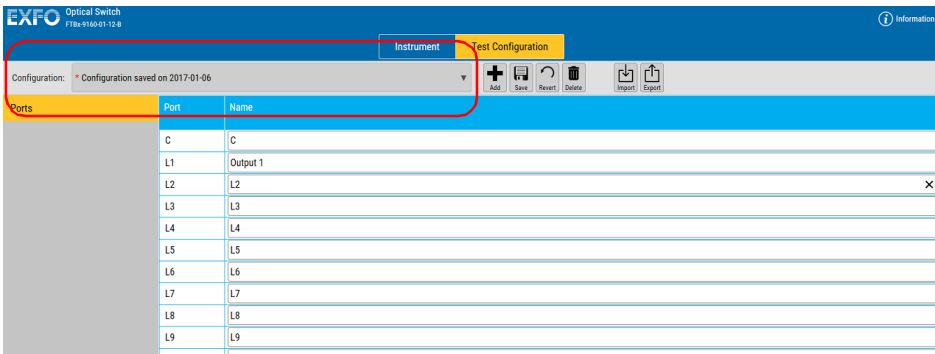



3. Change the configuration as needed.

4. Click  .

To create a configuration:

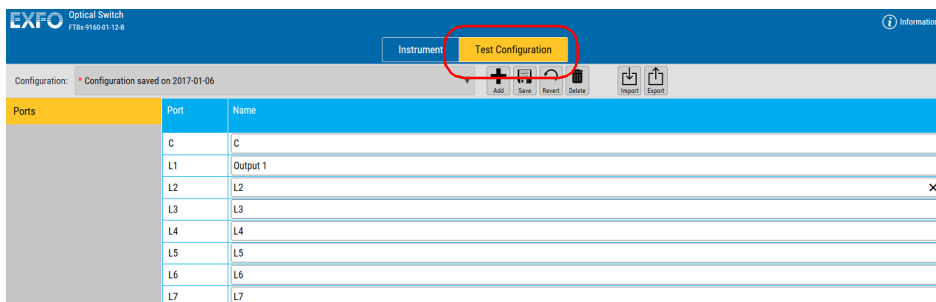
1. Select the **Test Configuration** tab.



2. Change the configuration as needed.
3. Click .
4. Enter a name for the configuration.

The dialog box titled 'Add a test configuration' contains a text input field for 'Name' with the value 'Configuration saved on 2016-12-16'. At the bottom of the dialog, there are two buttons: 'Add' and 'Cancel'.

5. Confirm your choice.

Operating the Optical Switch

Managing Configurations

To delete a configuration:

1. Select the **Test Configuration** tab.

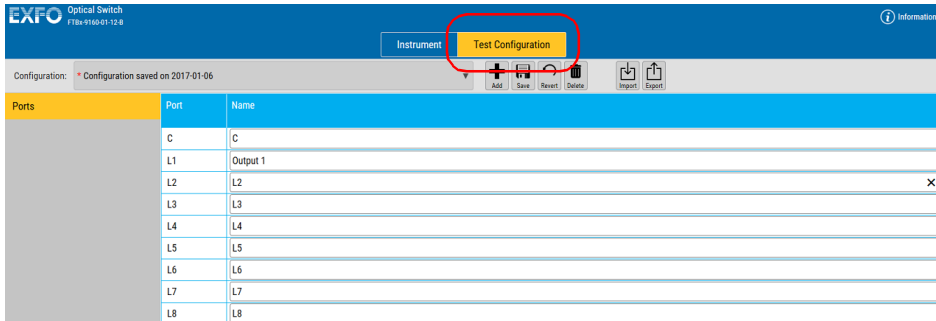

2. Select the configuration you want to delete.

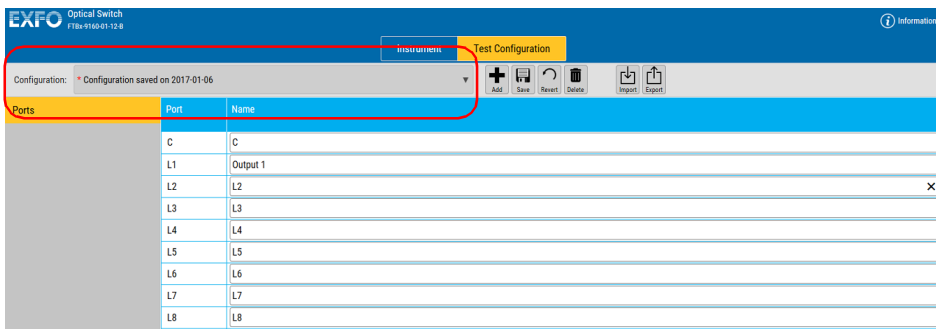

3. Click .
4. Confirm your choice.

To revert to the current configuration and erase changes:

1. While in the **Test Configuration** tab, click .
2. Confirm your choice.

To export a configuration:

1. Select the **Test Configuration** tab.

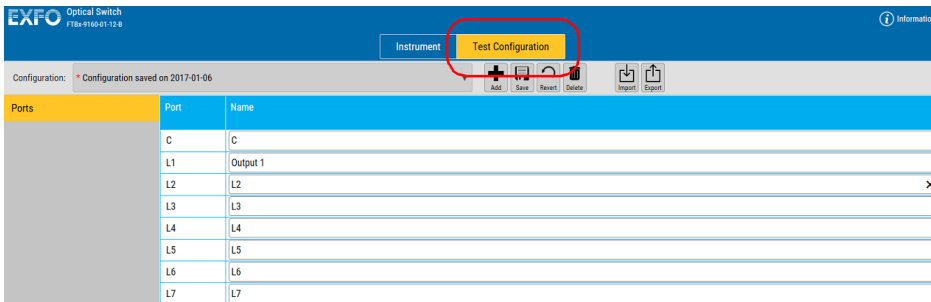

2. Select the configuration you want to export.

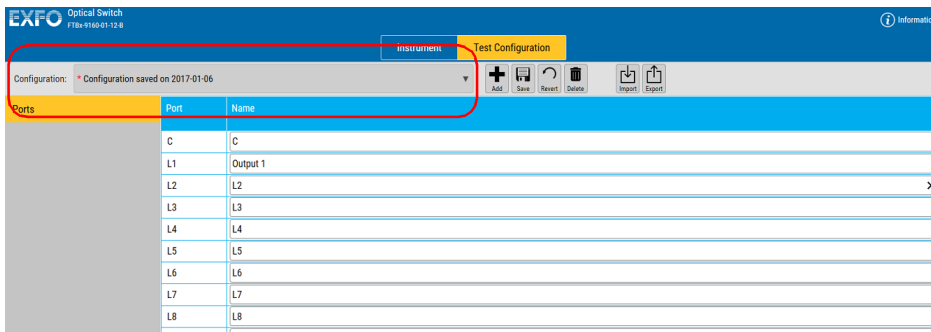

3. Click .
4. Select the location for the file and change the name if needed.
5. If you have changed the name or location, click **Save** to confirm the export operation.

Operating the Optical Switch

Managing Configurations

To import a configuration:

1. Select the **Test Configuration** tab.

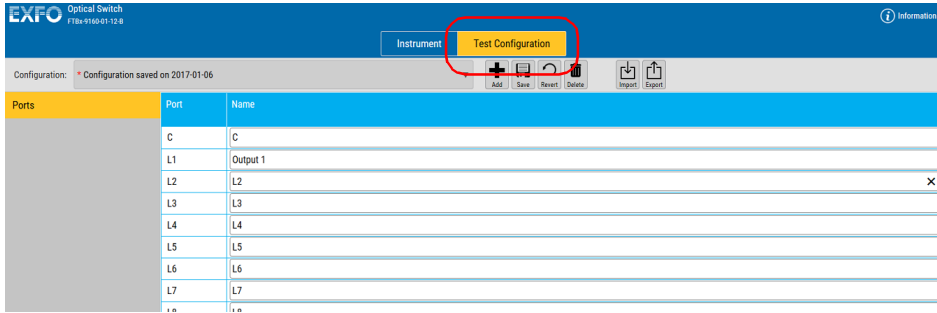

2. Click .
3. Locate the configuration files that you want to add and click **Open**.

4 **Maintenance**

To help ensure long, trouble-free operation:

- Always inspect fiber-optic connectors before using them and clean them if necessary.
- Keep the unit free of dust.
- Clean the unit casing and front panel with a cloth slightly dampened with water.
- Store unit at room temperature in a clean and dry area. Keep the unit out of direct sunlight.
- Avoid high humidity or significant temperature fluctuations.
- Avoid unnecessary shocks and vibrations.
- If any liquids are spilled on or into the unit, turn off the power immediately, disconnect from any external power source, remove the batteries and let the unit dry completely.



WARNING

The use of controls, adjustments and procedures, namely for operation and maintenance, other than those specified herein may result in hazardous radiation exposure or impair the protection provided by this unit.

Cleaning Fixed Connectors

Regular cleaning of connectors will help maintain optimum performance.



CAUTION

Do not try to disassemble the unit. Doing so would break the connector.



WARNING

Looking into the optical connector while the light source is active **WILL** result in permanent eye damage. EXFO strongly recommends to **TURN OFF** the unit before proceeding with the cleaning procedure.

To clean fixed connectors:

1. Fold a lint-free wiping cloth in four to form a square.
2. Moisten the center of the lint-free wiping cloth with *only one drop* of optical-grade liquid cleaner.



IMPORTANT

Some cleaners may leave traces if used abundantly. Avoid contact between the tip of the bottle and the wiping cloth, and do not use bottles that distribute too much liquid at a time.

3. Gently wipe the connector threads three times with the folded and moistened section of the wiping cloth.
4. With a dry lint-free wiping cloth, gently wipe the same surfaces three times with a rotating movement.
5. Throw out the wiping cloths after one use.

6. Moisten a cleaning tip (2.5 mm tip) with *only one drop* of optical-grade liquid cleaner.



IMPORTANT

Some cleaners may leave traces if used abundantly. Avoid contact between the tip of the bottle and the cleaning tip, and do not use bottles that distribute too much liquid at a time.

7. Slowly insert the cleaning tip into the connector until it reaches the ferrule inside (a slow clockwise rotating movement may help).

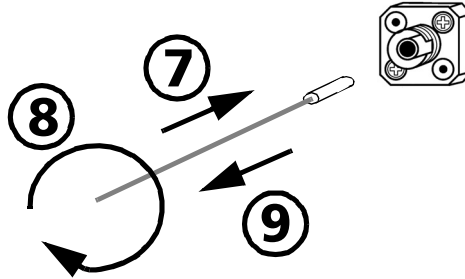

8. Gently turn the cleaning tip one full turn.
9. Continue to turn as you withdraw the cleaning tip.
10. Repeat steps 7 to 9, but this time with a dry cleaning tip (2.5 mm tip provided by EXFO).

Note: Make sure you don't touch the soft end of the cleaning tip and verify the cleanliness of the cotton tip.

11. Throw out the cleaning tips after one use.

Cleaning EUI Connectors

Regular cleaning of EUI connectors will help maintain optimum performance. There is no need to disassemble the unit.



IMPORTANT

If any damage occurs to internal connectors, the module casing will have to be opened and a new calibration will be required.



WARNING

Looking into the optical connector while the light source is active **WILL** result in permanent eye damage. EXFO strongly recommends to **TURN OFF** the unit before proceeding with the cleaning procedure.

To clean EUI connectors:

1. Remove the EUI from the instrument to expose the connector baseplate and ferrule.

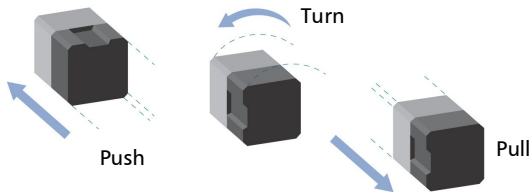

2. Moisten a 2.5 mm cleaning tip with *one drop* of optical-grade liquid cleaner.

3. Slowly insert the cleaning tip into the EUI adapter until it comes out on the other side (a slow clockwise rotating movement may help).

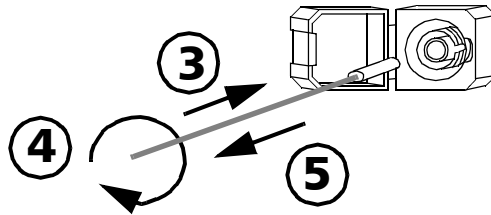

4. Gently turn the cleaning tip one full turn, then continue to turn as you withdraw it.
5. Repeat steps 3 to 4 with a dry cleaning tip.

Note: *Make sure you don't touch the soft end of the cleaning tip.*

6. Clean the ferrule in the connector port as follows:
 - 6a. Deposit *one drop* of optical-grade liquid cleaner on a lint-free wiping cloth.



IMPORTANT

Avoid contact between the tip of the bottle and the wiping cloth, and dry the surface quickly.

- 6b. Gently wipe the connector and ferrule.
- 6c. With a dry lint-free wiping cloth, gently wipe the same surfaces to ensure that the connector and ferrule are perfectly dry.
- 6d. Verify connector surface with a fiber inspection probe (for example, EXFO's FIP).
7. Put the EUI back onto the instrument (push and turn clockwise).
8. Throw out cleaning tips and wiping cloths after one use.

Cleaning LT Connectors

The connectors of the RTUe-9110 external switch can be cleaned using a mechanical cleaner.



WARNING

Never look directly into a live fiber. It could cause serious eye damage. Always use a Fiber Inspection Probe.



WARNING

Before cleaning the connectors, you should suspend the tests to avoid hazardous radiation exposure.

To clean a connector using a mechanical cleaner:

1. Insert the mechanical cleaner into the optical adapter, and push the outer shell into the cleaner.

Note: *The cleaner makes a clicking sound that indicates that the cleaning is done.*

2. Verify connector surface with a fiber inspection probe (for example, EXFO's FIP).

Cleaning and Inspecting MPO-Type Connectors

Your RTUe-9120 external switch is equipped with unpinned MPO ports (connectors) that can be cleaned using a multifiber mechanical cleaner.



You can inspect these connectors using a Fiber Inspection Probe supporting MPO connector configurations (for example, EXFO's FIP-435B MF-ready). Each of the switch's MPO connector has 16 fibers (two rows of eight fibers).



WARNING

Never look directly into a live fiber. It could cause serious eye damage. Always use a Fiber Inspection Probe.



WARNING

Before cleaning the connectors, you should suspend the tests to avoid hazardous radiation exposure.

Maintenance

Cleaning and Inspecting MPO-Type Connectors

To clean and inspect an MPO-type connector:

1. Insert the cleaning tip into the optical adapter, and push the outer shell into the cleaner.

Note: *The cleaner makes a clicking sound to indicate that the cleaning is done.*

2. Verify connector surface with a Fiber Inspection Probe. From the dedicated FIP application, ensure to select either a 2 x 8 configuration or a 2 x 12 configuration if no 2 x 8 configuration is available.

Note: *For the exact inspection procedure, refer to the FIP-400 Fiber Inspection Probe and ConnectorMax2 user guide.*

Note: *If you have selected a 2 x 12 configuration and the dedicated application returns a Fail status, you may want to have a closer look at the exact fibers with a Fail status. Since the four fibers at each end of the connector are not used, a Fail status on these fibers can be disregarded. If the sixteen central fibers all have a Pass status, you can then consider the whole connector to have a Pass status.*

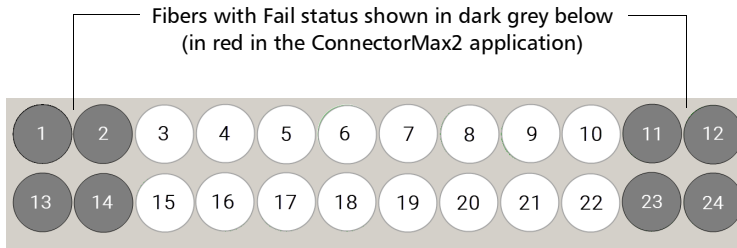

Note: *If you have selected a 2 x 12 configuration, the fiber numbers shown in the dedicated FIP application will not correspond to the actual fiber numbers on your RTUe-9120 switch.*

Recycling and Disposal



This symbol on the product means that you should recycle or dispose of your product (including electric and electronic accessories) properly, in accordance with local regulations. Do not dispose of it in ordinary garbage receptacles.

For complete recycling/disposal information, visit the EXFO Web site at www.exfo.com/recycle.

5 *Troubleshooting*

Solving Common Problems

Here are some solutions to common problems you could have with your unit.

Problem	Possible cause	Recommended action
Insertion loss higher than expected.	Dirty optical connectors.	Clean all optical connectors.
	Improper wavelength selected on other instruments.	Switch to the correct wavelength on all instruments being used.
Poor repeatability.	Optical source is unstable.	Wait for source to stabilize.
	—	Select High Repeatability .
No optical continuity.	Switch is off.	Set the Continuity switch to On .

Troubleshooting

Solving Common Problems

Problem	Possible cause	Recommended action
The LTBe-9110/RTUe-9110/RTUe-9120 external switch that I have just connected is not working.	A firmware update is in progress.	<ul style="list-style-type: none">▶ When a firmware update is in progress, the switch's LED remains off during all the update process.▶ Wait a little time for the update to complete. You will know that the switch is ready to use again when its LED turns steady green. <p>Note: <i>If you have access to the Optical Switch application from ToolBox X, you will see a message about the update.</i></p>
	The switch has not been detected.	<ul style="list-style-type: none">▶ Disconnect, then reconnect the switch.▶ Ensure that the unit is on and that its System LED () is green and not blinking. <p>If the problem persists, turn off the unit, ensure that the switch is connected properly to it with the USB cable, and then restart the unit.</p>

Problem	Possible cause	Recommended action
<p>The dedicated FIP application now returns a Fail status for one of the MPO port (connector) of my RTUe-9120 external switch.</p>	<p>There is at least one dirty or damaged fiber inside the MPO connector.</p>	<p>From the dedicated FIP application, verify which fibers have a Fail status.</p> <p>If you have used a 2 x 12 configuration for the inspection, you can disregard the Fail status of the four fibers at each end of the connector as they are not used.</p> <p>If the sixteen central fibers all have a Pass status, you can then consider the whole connector to have a Pass status.</p> <p>If some of the eight central fibers have a Fail status, try cleaning the connector again (see <i>Cleaning and Inspecting MPO-Type Connectors</i> on page 71).</p> <p>If the problem persists, contact EXFO.</p>

Troubleshooting

Viewing Online Documentation

Viewing Online Documentation

A PDF version of the user guide is available at all times for your switch.

To view the user guide:

1. From the main window, click **Information**.

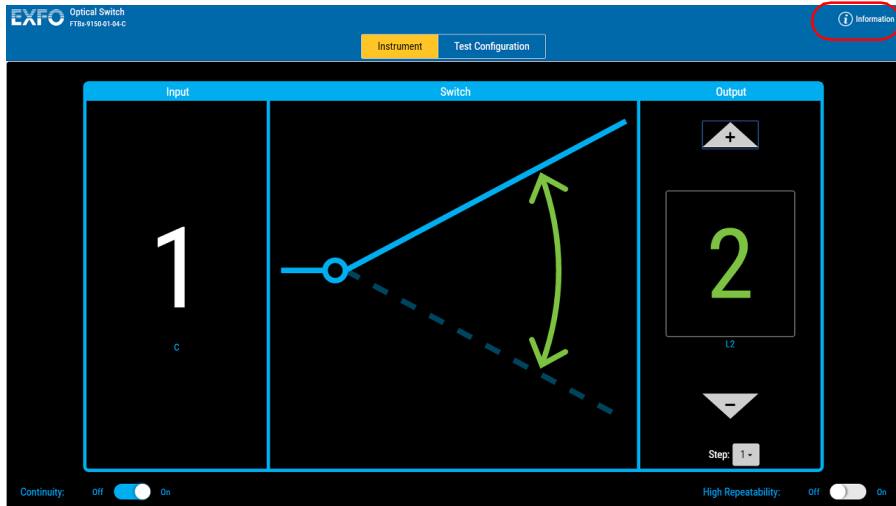

2. Select **User Guide**.

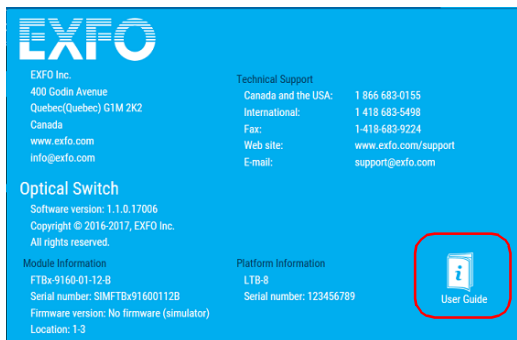

Contacting the Technical Support Group

To obtain after-sales service or technical support for this product, contact EXFO at one of the following numbers. The Technical Support Group is available to take your calls from Monday to Friday, 8:00 a.m. to 7:00 p.m. (Eastern Time in North America).

Technical Support Group

400 Godin Avenue
Quebec (Quebec) G1M 2K2
CANADA

1 866 683-0155 (USA and Canada)
Tel.: 1 418 683-5498
Fax: 1 418 683-9224
support@exfo.com

For detailed information about technical support, and for a list of other worldwide locations, visit the EXFO Web site at www.exfo.com.

If you have comments or suggestions about this user documentation, you can send them to customer.feedback.manual@exfo.com.

To accelerate the process, please have information such as the name and the serial number (see the product identification label), as well as a description of your problem, close at hand.

Viewing Product Information

You can see information about your product, such as the serial and version numbers and contact information at all times.

To view product information:

1. From the main window, click **Information**.

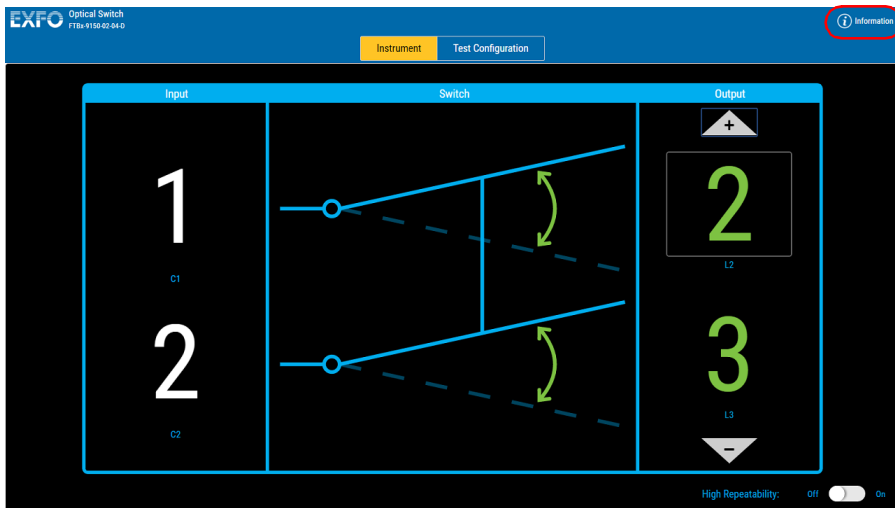

2. Once you are done, click anywhere on the screen to close the window.



Transportation

Maintain a temperature range within specifications when transporting the unit. Transportation damage can occur from improper handling. The following steps are recommended to minimize the possibility of damage:

- Pack the unit in its original packing material when shipping.
- Avoid high humidity or large temperature fluctuations.
- Keep the unit out of direct sunlight.
- Avoid unnecessary shocks and vibrations.

6 **Warranty**

General Information

EXFO Inc. (EXFO) warrants this equipment against defects in material and workmanship for a period of two years from the date of original shipment. EXFO also warrants that this equipment will meet applicable specifications under normal use.

During the warranty period, EXFO will, at its discretion, repair, replace, or issue credit for any defective product, as well as verify and adjust the product free of charge should the equipment need to be repaired or if the original calibration is erroneous. If the equipment is sent back for verification of calibration during the warranty period and found to meet all published specifications, EXFO will charge standard calibration fees.



IMPORTANT

The warranty can become null and void if:

- **unit has been tampered with, repaired, or worked upon by unauthorized individuals or non-EXFO personnel.**
- **warranty sticker has been removed.**
- **case screws, other than those specified in this guide, have been removed.**
- **case has been opened, other than as explained in this guide.**
- **unit serial number has been altered, erased, or removed.**
- **unit has been misused, neglected, or damaged by accident.**

THIS WARRANTY IS IN LIEU OF ALL OTHER WARRANTIES EXPRESSED, IMPLIED, OR STATUTORY, INCLUDING, BUT NOT LIMITED TO, THE IMPLIED WARRANTIES OF MERCHANTABILITY AND FITNESS FOR A PARTICULAR PURPOSE. IN NO EVENT SHALL EXFO BE LIABLE FOR SPECIAL, INCIDENTAL, OR CONSEQUENTIAL DAMAGES.

Warranty

Gray Market and Gray Market Products

Gray Market and Gray Market Products

Gray market is a market where products are traded through distribution channels that are legal but remain unofficial, unauthorized, or unintended by the original manufacturer. Intermediaries using such channels to distribute products are considered to be part of the gray market (hereafter unauthorized intermediary).

EXFO considers that a product originates from the gray market (hereafter gray market product) in the following situations:

- A product is sold by an unauthorized intermediary.
- A product is designed and destined for a particular market and sold on a second market.
- A product is resold, despite being reported lost or stolen.

When products are purchased on the gray market, rather than through an authorized EXFO distribution channel, EXFO is unable to guarantee the source and quality of those products nor the local safety regulations and certifications (CE, UL, etc.).

EXFO will not honor warranty, install, maintain, repair, calibrate, provide technical support nor make any support contracts available for gray market products.

For complete information, refer to EXFO's policy regarding gray market products at www.exfo.com/en/how-to-buy/sales-terms-conditions/gray-market/

Liability

EXFO shall not be liable for damages resulting from the use of the product, nor shall be responsible for any failure in the performance of other items to which the product is connected or the operation of any system of which the product may be a part.

EXFO shall not be liable for damages resulting from improper usage or unauthorized modification of the product, its accompanying accessories and software.

Exclusions

EXFO reserves the right to make changes in the design or construction of any of its products at any time without incurring obligation to make any changes whatsoever on units purchased. Accessories, including but not limited to fuses, pilot lamps, batteries and universal interfaces (EUI) used with EXFO products are not covered by this warranty.

This warranty excludes failure resulting from: improper use or installation, normal wear and tear, accident, abuse, neglect, fire, water, lightning or other acts of nature, causes external to the product or other factors beyond the control of EXFO.



IMPORTANT

In the case of products equipped with optical connectors, EXFO will charge a fee for replacing connectors that were damaged due to misuse or bad cleaning.

Certification

EXFO certifies that this equipment met its published specifications at the time of shipment from the factory.

Service and Repairs

EXFO commits to providing product service and repair for five years following the date of purchase.

To send any equipment for service or repair:

1. Call one of EXFO's authorized service centers (see *EXFO Service Centers Worldwide* on page 87). Support personnel will determine if the equipment requires service, repair, or calibration.
2. If equipment must be returned to EXFO or an authorized service center, support personnel will issue a Return Merchandise Authorization (RMA) number and provide an address for return.
3. If possible, back up your data before sending the unit for repair.
4. Pack the equipment in its original shipping material. Be sure to include a statement or report fully detailing the defect and the conditions under which it was observed.
5. Return the equipment, prepaid, to the address given to you by support personnel. Be sure to write the RMA number on the shipping slip. *EXFO will refuse and return any package that does not bear an RMA number.*

Note: *A test setup fee will apply to any returned unit that, after test, is found to meet the applicable specifications.*

After repair, the equipment will be returned with a repair report. If the equipment is not under warranty, you will be invoiced for the cost appearing on this report. EXFO will pay return-to-customer shipping costs for equipment under warranty. Shipping insurance is at your expense.

Routine recalibration is not included in any of the warranty plans. Since calibrations/verifications are not covered by the basic or extended warranties, you may elect to purchase FlexCare Calibration/Verification Packages for a definite period of time. Contact an authorized service center (see *EXFO Service Centers Worldwide* on page 87).

EXFO Service Centers Worldwide

If your product requires servicing, contact your nearest authorized service center.

EXFO Headquarters Service Center

400 Godin Avenue
Quebec (Quebec) G1M 2K2
CANADA

1 866 683-0155 (USA and Canada)
Tel.: 1 418 683-5498
Fax: 1 418 683-9224
support@exfo.com

EXFO Europe Service Center

Winchester House, School Lane
Chandlers Ford, Hampshire S053 4DG
ENGLAND

Tel.: +44 2380 246800
Fax: +44 2380 246801
support.europe@exfo.com

EXFO Telecom Equipment (Shenzhen) Ltd.

3rd Floor, Building C,
FuNing Hi-Tech Industrial Park, No. 71-3,
Xintian Avenue,
Fuhai, Bao'An District,
Shenzhen, China, 518103

Tel: +86 (755) 2955 3100
Fax: +86 (755) 2955 3101
support.asia@exfo.com

To view EXFO's network of partner-operated Certified Service Centers nearest you, please consult EXFO's corporate website for the complete list of service partners:

<http://www.exfo.com/support/services/instrument-services/exfo-service-centers>.

A **SCPI Command Reference**

Note: This section applies only to the LTBe/FTBx-9110, FTBx-9150 and FTBx-9160.

This section presents detailed information on the commands and queries supplied with your Optical Switch.



IMPORTANT

- ▶ The commands and queries for your Optical Switch are not supported on IQS-600 and FTB-500 platforms.
- ▶ You can use these commands and queries with any other platform, as long as it supports the Optical Switch and offers automation capabilities.
- ▶ Since the platforms can house many instruments, you must explicitly specify which instrument you want to remotely control.

You must add the following mnemonic *at the beginning of any command or query* that you send to an instrument:

LINStrument<LogicalInstrumentPos>:

where *<LogicalInstrumentPos>* corresponds to the identification number of the instrument.

Use the LINS value defined in the Remote Control Configuration tool (accessible from System Settings). For information on modifying the LINS value, refer to your platform user guide.

SCPI Command Reference

Quick Reference Command Tree

Quick Reference Command Tree

Command						Parameter(s)
LOCK	[STATe]					<State>
	[STATe]?					
ROUTE[1..n]	CLOSE					
	OPEN					
		STATe?				
	PATH	CATalog?				
	SCAN					<Position>
	SCAN?					
	SCAN	ADJust				
			AUTO			<AutoAdjust>
			AUTO?			
		NEXT				
		PREV				
		SYNChronous				<Synchronous>
		SYNChronous?				
RST						
SNUMber?						
STATus?						

Product-Specific Commands—Description

:LOCK[:STATe]	
Description	The :LOCK:STATe command controls the API write lock. When locked, only SCPI can change the instrument configuration.
Syntax	:LOCK[:STATe] <wsp> <State>
Parameter(s)	<p><i>State:</i></p> <p>The program data syntax for <State> is defined as a <Boolean Program Data> element. The <State> special forms ON and OFF are accepted on input for increased readability. ON corresponds to 1 and OFF corresponds to 0.</p> <p>The <State> is rounded to an integer. A non-zero result is interpreted as 1.</p>
Example(s)	:LOCK:STAT ON (api is locked) :LOCK:STAT 0 (api is unlocked)
See Also	:LOCK:STATe?

SCPI Command Reference

Product-Specific Commands—Description

:LOCK[:STATe]?	
Description	The :LOCK:STATe? command return the locked state of the instrument api.
Syntax	:LOCK[:STATe]?
Parameter(s)	None
Response Syntax	<State>
Response(s)	<i>State:</i> The response data syntax for <State> is defined as a <NR1 NUMERIC RESPONSE DATA> element. 1 corresponds to ON and 0 corresponds to OFF.
Example(s)	:LOCK:STAT? returns 1 (api locked) :LOCK:STAT? returns 0 (api unlocked)
See Also	:LOCK:STATe

:ROUTe[1..n]:CLOSE

Description	This command positions the optical switch to the reset position. In this position, there is no optical continuity. *RST has no effect on this command.
Syntax	:ROUTe[1..n]:CLOSE
Parameter(s)	None
Example(s)	ROUT:CLOSE
Notes	For all switches except: 1x2, 2x2, and 2x4, plus FTBx-9160 models.
See Also	ROUTe[1..n]:OPEN ROUTe[1..n]:OPEN:STATE?

SCPI Command Reference

Product-Specific Commands—Description

:ROUTE[1..n]:OPEN

Description	This command makes the switch change from the reset position (no optical continuity) to the channel position in effect when the switch was turned off. *RST has no effect on this command.
Syntax	:ROUTE[1..n]:OPEN
Parameter(s)	None
Example(s)	ROUT:OPEN
Notes	For all switches except: 1x2, 2x2, and 2x4.
See Also	ROUTE[1..n]:OPEN ROUTE[1..n]:OPEN:STATE?

:ROUTe[1..n]:OPEN:STATe?

Description	<p>This query returns a value indicating whether the switch is optically open or closed.</p> <p>On *RST, the value of this setting is OFF.</p>
Syntax	:ROUTe[1..n]:OPEN:STATe?
Parameter(s)	None
Response Syntax	<OpticalContinuity>
Response(s)	<p><i>OpticalContinuity:</i></p> <p>The response data syntax for <OpticalContinuity> is defined as a <NR1 NUMERIC RESPONSE DATA> element.</p> <p>The <OpticalContinuity> response represents the optical continuity state, where:</p> <p>0, means there is no optical continuity. 1, means there is optical continuity.</p>
Example(s)	<p>ROUT:CLOS</p> <p>ROUT:OPEN:STAT? returns 0 (there is no optical continuity)</p> <p>ROUT:OPEN</p> <p>ROUT:OPEN:STAT? returns 1 (there is optical continuity)</p>
Notes	For all switches except: 1x2, 2x2, and 2x4.
See Also	<p>ROUTe[1..n]:OPEN</p> <p>ROUTe[1..n]:CLOSE</p>

SCPI Command Reference

Product-Specific Commands—Description

:ROUTE[1..n]:PATH:CATalog?

Description	<p>This query returns a value indicating the type of switch in use (e.g. 1x2, 1x4, 1x12, 1x16, 1x 32, 2x2 or 2x4).</p> <p>*RST has no effect on this command.</p>
Syntax	:ROUTE[1..n]:PATH:CATalog?
Parameter(s)	None
Response Syntax	<Type>
Response(s)	<p><i>Type:</i></p> <p>The response data syntax for <Type> is defined as a <STRING RESPONSE DATA> element.</p> <p>The <Type> response is a string indicating the switch type in the format 9x99.</p>
Example(s)	ROUT:PATH:CAT? returns "2x2"

:ROUTE[1..n]:SCAN

Description

This command sets the switch to a specific channel.

On *RST, the selected output channel depends on the switch configuration:

- a) For 1xN switch configuration: Output 1.
- b) For 2x4 switch configuration: no continuity for both Input 1 and Input 2.
- c) For 2x2 switch configuration: BYPASS state.

Syntax

:ROUTE[1..n]:SCAN<wsp><Position>

Parameter(s)

Position:

The program data syntax for <Position> is defined as a <DECIMAL NUMERIC PROGRAM DATA> element.

The <Position> is a number from 0 to 32, depending on switch configuration as follows:

- a) For a 1xN switch configuration, a number from 1 to 32, depending on the number of output channels.
- b) For a 2x4 switch, a number from 0 to 5, where
 - 0, means no continuity for both Input 1 and Input 2.
 - 1, means no continuity for Input 1, and Input 2 is connected to Output 1.

SCPI Command Reference

Product-Specific Commands—Description

:ROUTE[1..n]:SCAN

2, means Input 1 is connected to Output 1 and Input 2 is connected to Output 2.

3, means Input 1 is connected to Output 2 and Input 2 is connected to Output 3.

4, means Input 1 is connected to Output 3 and Input 2 is connected to Output 4.

5, means Input 1 is connected to Output 4 and Input 2 has no continuity.

c) For a 2x2 switch, a number, 1 or 2, where:

1, means BYPASS state.

2, means INSERT state.

Example(s)

ROUT:SCAN 1

ROUT:SCAN? returns 1

ROUT:SCAN 2

ROUT:SCAN? returns 2

See Also

ROUTE[1..n]:SCAN?

ROUTE[1..n]:SCAN:PREV

ROUTE[1..n]:SCAN:NEXT

:ROUTE[1..n]:SCAN?

Description	<p>This query returns a value indicating the current switch position.</p> <p>On *RST, the selected output channel depends on the switch configuration:</p> <ul style="list-style-type: none"> a) For 1xN switch configuration: Output 1. b) For 2x4 switch configuration: no continuity for both Input 1 and Input 2. c) For 2x2 switch configuration: BYPASS state.
Syntax	:ROUTE[1..n]:SCAN?
Parameter(s)	None
Response Syntax	<Position>
Response(s)	<p><i>Position:</i></p> <p>The response data syntax for <Position> is defined as a <NR1 NUMERIC RESPONSE DATA> element.</p> <p>The <Position> response represents the currently selected channel on the switch, as follows:</p> <ul style="list-style-type: none"> a) For a 1xN switch configuration, a number from 1 to 32, depending on the number of output channels. b) For a 2x4 switch, a number from 0 to 5, where <ul style="list-style-type: none"> 0, means no continuity for both Input 1 and Input 2. 1, means no continuity for Input 1, and Input 2 is connected to Output 1.

SCPI Command Reference

Product-Specific Commands—Description

:ROUTE[1..n]:SCAN?

2, means Input 1 is connected to Output 1 and Input 2 is connected to Output 2.

3, means Input 1 is connected to Output 2 and Input 2 is connected to Output 3.

4, means Input 1 is connected to Output 3 and Input 2 is connected to Output 4.

5, means Input 1 is connected to Output 4 and Input 2 has no continuity.

c) For a 2x2 switch, a number, 1 or 2, where:

1, means BYPASS state.

2, means INSERT state.

Example(s)

ROUT:SCAN 1

ROUT:SCAN? returns 1

ROUT:SCAN 2

ROUT:SCAN? returns 2

See Also

ROUTE[1..n]:SCAN

ROUTE[1..n]:SCAN:PREV

ROUTE[1..n]:SCAN:NEXT

:ROUTe[1..n]:SCAN:ADJust

Description	<p>This command makes the switch mechanism return to a reference position before aligning to the current position.</p> <p>This command is an event and has no associated *RST condition or query form.</p>
Syntax	:ROUTe[1..n]:SCAN:ADJust
Parameter(s)	None
Example(s)	ROUT:SCAN:ADJ
See Also	ROUTe[1..n]:SCAN:ADJust:AUTO ROUTe[1..n]:SCAN:ADJust:AUTO?

:ROUTE[1..n]:SCAN:ADJust:AUTO

Description	<p>This command sets the <Optimize for repeatability> option. When this option is selected, the switch mechanism returns to a reference position before aligning to a new position. This ensures optimum repeatability. When this option is not selected, the switch mechanism goes directly to the new channel position. This provides faster switching times, but less repeatability.</p> <p>On *RST, the value of this setting is OFF.</p>
Syntax	<p>:ROUTE[1..n]:SCAN:ADJust:AUTO<wsp><Auto Adjust></p>
Parameter(s)	<p><i>AutoAdjust:</i></p> <p>The program data syntax for <AutoAdjust> is defined as a <Boolean Program Data> element. The <AutoAdjust> special forms ON and OFF are accepted on input for increased readability. ON corresponds to 1 and OFF corresponds to 0.</p> <p>The <AutoAdjust> parameter enables or disables the optimization for repeatability.</p> <p>1 or ON, enables the optimization for repeatability. 0 or OFF, disables the optimization for repeatability.</p>

:ROUTE[1..n]:SCAN:ADJust:AUTO

Example(s)	<p>ROUT:SCAN:ADJ:AUTO 0 ROUT:SCAN:ADJ:AUTO? returns 0 (optimization for repeatability is not selected).</p> <p>ROUT:SCAN:ADJ:AUTO 1 ROUT:SCAN:ADJ:AUTO? returns 1 (optimization for repeatability is selected).</p>
Notes	<p>For all switches except: 1x2 and 2x2, plus FTBx-9160 models.</p>
See Also	<p>ROUTE[1..n]:SCAN:ADJust ROUTE[1..n]:SCAN:ADJust:AUTO?</p>

:ROUTE[1..n]:SCAN:ADJust:AUTO?

Description	<p>This query returns the current value of the <Optimize for repeatability> option. When this option is selected, the switch mechanism returns to a reference position before aligning to a new position. This ensures optimum repeatability. When this option is not selected, the switch mechanism goes directly to the new channel position. This provides faster switching times, but less repeatability.</p> <p>On *RST, the value of this setting is OFF.</p>
Syntax	:ROUTE[1..n]:SCAN:ADJust:AUTO?
Parameter(s)	None
Response Syntax	<AutoAdjust>
Response(s)	<p><i>AutoAdjust:</i></p> <p>The response data syntax for <AutoAdjust> is defined as a <NR1 NUMERIC RESPONSE DATA> element.</p>

:ROUTE[1..n]:SCAN:ADJust:AUTO?

The <AutoAdjust> response represents the current state of the <Optimize for repeatability> option, where:

1, <Optimize for repeatability> option is selected.

0, <Optimize for repeatability> option is not selected.

Example(s)

ROUT:SCAN:ADJ:AUTO 0

ROUT:SCAN:ADJ:AUTO? returns 0 (optimization for repeatability is not selected).

ROUT:SCAN:ADJ:AUTO 1

ROUT:SCAN:ADJ:AUTO? returns 1 (optimization for repeatability is selected).

See Also

ROUTE[1..n]:SCAN:ADJust

ROUTE[1..n]:SCAN:ADJust:AUTO

SCPI Command Reference

Product-Specific Commands—Description

:ROUTe[1..n]:SCAN:NEXT

Description	<p>This command moves the switch to the next position.</p> <p>This command is an event and has no associated *RST condition or query form.</p>
Syntax	:ROUTe[1..n]:SCAN:NEXT
Parameter(s)	None
Example(s)	<p>ROUT:SCAN 1</p> <p>ROUT:SCAN:NEXT</p> <p>ROUT:SCAN? returns 2</p>
See Also	<p>ROUTe[1..n]:SCAN</p> <p>ROUTe[1..n]:SCAN?</p> <p>ROUTe[1..n]:SCAN:PREV</p>

:ROUTe[1..n]:SCAN:PREV

Description	<p>This command moves the switch to its previous position.</p> <p>This command is an event and has no associated *RST condition or query form.</p>
Syntax	:ROUTe[1..n]:SCAN:PREV
Parameter(s)	None
Example(s)	<p>ROUT:SCAN 2</p> <p>ROUT:SCAN:PREV</p> <p>ROUT:SCAN? returns 1</p>
See Also	<p>ROUTe[1..n]:SCAN</p> <p>ROUTe[1..n]:SCAN?</p> <p>ROUTe[1..n]:SCAN:NEXT</p>

SCPI Command Reference

Product-Specific Commands—Description

:ROUTe[1..n]:SCAN:SYNChronous

Description	This command enables/disables the switch to change position synchronously or not.
Syntax	:ROUTe[1..n]:SCAN:SYNChronous <wsp> <Synchronous>
Parameter(s)	<p><i>Synchronous:</i></p> <p>The program data syntax for <Synchronous> is defined as a <Boolean Program Data> element. The <Synchronous> special forms ON and OFF are accepted on input for increased readability. ON corresponds to 1 and OFF corresponds to 0.</p> <p>The <Synchronous> parameter enables or disables the synchronous mode.</p> <p>1 or ON, enables the synchronous mode for changing position. 0 or OFF, disables the synchronous mode for changing position.</p>
Example(s)	<pre>ROUT:SCAN:SYNC 0 ROUT:SCAN:SYNC? returns 0 ROUT:SCAN 12 STATUS? returns BUSY (Module busy)</pre>
See Also	<pre>ROUTe[1..n]:SCAN ROUTe[1..n]:SCAN? ROUTe[1..n]:SCAN:SYNChronous?</pre>

:ROUte[1..n]:SCAN:SYNChronous?

Description	<p>This query returns a value indicating whether the switch is changing position synchronously or not.</p> <p>On *RST, the value of this setting is ON.</p>
Syntax	:ROUte[1..n]:SCAN:SYNChronous?
Parameter(s)	None
Response Syntax	<Synchronous>
Response(s)	<p><i>Synchronous:</i></p> <p>The response data syntax for <Synchronous> is defined as a <NR1 NUMERIC RESPONSE DATA> element.</p> <p>The <Synchronous> response represents switching position mode, where:</p> <p>0, means the module is changing position asynchronously.</p> <p>1, means the module is changing position synchronously.</p>
See Also	<p>ROUte[1..n]:SCAN</p> <p>ROUte[1..n]:SCAN?</p> <p>ROUte[1..n]:SCAN:SYNChronous</p>

SCPI Command Reference

Product-Specific Commands—Description

		:RST
Description	The command resets the optical switch to its default configuration. This command is an event and has no associated *RST condition or query form.	
Syntax	:RST	
Parameter(s)	None	

:SNUMber?	
Description	<p>This query returns a value indicating the module's serial number</p> <p>This command is an event and has no associated *RST condition or query form.</p>
Syntax	:SNUMber?
Parameter(s)	None
Response Syntax	<SerialNumber>
Response(s)	<p><i>SerialNumber:</i></p> <p>The response data syntax for <SerialNumber> is defined as a <STRING RESPONSE DATA> element.</p> <p>The <SerialNumber> response represents a string containing the modules serial number.</p>
Example(s)	SNUM? returns "123456-AB"

SCPI Command Reference

Product-Specific Commands—Description

:STATus?	
Description	<p>This query returns a value indicating the status of the switch (READY, BUSY, etc.)</p> <p>This command is an event and has no associated *RST condition or query form.</p>
Syntax	:STATus?
Parameter(s)	None
Response Syntax	<Status>
Response(s)	<p><i>Status:</i></p> <p>The response data syntax for <Status> is defined as a <CHARACTER RESPONSE DATA> element.</p> <p>The <Status> response represents the module state, where:</p> <p>UNINITIALIZED, means the module is not initialized.</p> <p>INITINPROGRESS, means the module initialization is in progress,</p> <p>READY, means the module is ready,</p> <p>BUSY, means the module is busy,</p> <p>DISCONNECTED, means the module is disconnected,</p> <p>DEFECTIVE, means the module is defective, and</p> <p>UNCONFIGURED, means the module is not configured.</p>
Example(s)	STAT? returns READY (Module is ready.)

B *REST Command Reference*

Note: *This section applies only to the LTBe/FTBx-9110, FTBx-9150 and FTBx-9160.*

A complete list of REST commands for your unit is available at all times online. It details the commands with examples and appropriate syntax.

To view the REST command documentation:

From your internet browser, go to the following address:
[http://\[IP address of your platform\]/FTBx9150/help](http://[IP address of your platform]/FTBx9150/help).

Index

- 21-inch rack, adapters 30
- A**
- adapters for ETSI rack 30
- adding external switch 37, 42
- after-sales service 79
- application, setting up 25
- array, selecting 48
- B**
- bidirectional optical switch 13, 14
- building optical switch configurations 19
- bypass
- light path, 2 x 2 optical switch 14
 - state, 2 x 2 optical switch 14
- C**
- cabinet installation 25
- cascading external switches 37
- caution
- of personal hazard 20
 - of product hazard 20
- cleaning
- EUI connectors 68
 - fiber ends 49
 - fixed connectors 66
 - front panel 65
 - MPO connectors 71
 - other connectors 70
- common port 13
- configurations
- creating 61
 - deleting 62
 - erasing changes 62
 - exporting 63
 - items included 59
 - naming ports 58
 - saving 60
- configurations, optical switch
- 1 x N model 52
 - 2 x 2 model 55
 - 2 x 4 model 56
 - available 52
 - basic principles 13
 - changing 54
 - customized 19
 - selecting 52
- connecting
- devices under test 16
 - external switch to unit 37, 42
- connectors, cleaning 66, 68
- continuity, optical switch 51, 52, 54, 75
- conventions, safety 20
- creating a test configuration 61
- customer service 86
- customized optical switch configurations 19
- D**
- deleting configurations 62
- devices under test, connecting 16
- E**
- equipment returns 86
- erasing test configuration changes 62
- ETSI racks 25, 30
- EUI
- baseplate 46
 - connector adapter 46
 - connectors, cleaning 68
- EXFO universal interface. see EUI
- exporting configurations 63

Index

- external switch
 - connecting to unit 37, 42
 - grounding 33
 - installing in rack 27
- F**
- fiber ends, cleaning 49
- fiber numbers 11
- fitting switch in ETSI rack 30
- front panel description, optical switch 4
- front panel, cleaning 65
- G**
- grounding external switch 33
- I**
- identification label 79
- input port, naming 58
- inserted
 - light path, 2 x 2 optical switch 14
 - state, 2 x 2 optical switch 14
- insertion loss
 - higher than expected 75
 - measuring 17
- inspecting MPO connectors 71
- installing external switch in rack 25, 27
- L**
- label, identification 79
- LED for RTUe-9110/RTUe-9120 12
- light path
 - bypass state, 2 x 2 optical switch 14
 - inserted state, 2 x 2 optical switch 14
- LT connector cleaner 70
- LTBe-9110 array 48
- lug, grounding 33
- M**
- maintenance
 - EUI connectors 68
 - fixed connectors 66
 - front panel 65
 - general information 65
 - measuring switch port insertion loss 17
 - mechanical connector cleaning 70
 - model, optical switch
 - 1 x N 54
 - 2 x 2 55
 - 2 x 4 56
 - module
 - models 2
 - starting from Web browser 47
 - mounting brackets 25
 - mounting EUI connector adapter 46
- MPO
 - cleaning connector 71
 - port configuration 3
- multiple devices, testing 16
- N**
- naming ports 58
- O**
- operating the optical switch 25
- optical continuity
 - function 52
 - optimization for repeatability 51
 - problem with 75
- optical switch
 - available models 1, 4
 - bidirectional 13
 - connecting optical fiber 25
 - custom configurations 19
 - front panel 4
 - introducing 1
 - MPO ports vs fiber numbers 11
 - operating 25

optimizing for repeatability	51	service and repairs	86
ports	13	service centers	87
<i>see also</i> application <i>and</i> module		shipping to EXFO	86
optimizing switch for repeatability	51	single-fiber cleaner	70
output port, naming	58	specifications, product	19
P			
path, light (2 x 2 optical switch)		starting module from Web browser	47
bypass state	14	state, 2 x 2 optical switch	
inserted state	14	bypass	14
poor repeatability	75	inserted	14
port		storage requirements	65
names	58	suggested applications	16
numbers vs fiber numbers	11	switch. <i>see</i> optical switch	
product		switching	
identification label	79	accuracy	51
specifications	19	basic principles	13
R			
rack		longer time	51
dimensions	25	optimized for repeatability	51
installing switches in	27	symbols, safety	20
regulatory information	v, viii	system LED, RTUe-9110/RTUe-9120	12
repeatability		T	
optimizing switch for	51	technical specifications	19
problem with	75	technical support	79
return merchandise authorization (RMA)	86	temperature for storage	65
RTUe-9110/RTUe-9120, installing	27	test configurations	
S			
safety		creating	61
caution	20	deleting	62
conventions	20	exporting	63
grounding switch	33	items included	59
warning	20	resetting	62
saving test configurations	60	saving	60
selecting		testing with multiple devices	16
configurations with the 1 x N model	52	transportation requirements	65, 81
configurations with the 2 x 2 model	55		
configurations with the 2 x 4 model	56		

Index

W

warranty	
certification	85
exclusions	85
general	83
liability	85
null and void	83
Web browser, selecting module	47

CHINESE REGULATION ON RESTRICTION OF HAZARDOUS SUBSTANCES (RoHS)
中国关于有害物质限制的规定

NAMES AND CONTENTS OF THE TOXIC OR HAZARDOUS SUBSTANCES OR ELEMENTS
CONTAINED IN THIS EXFO PRODUCT
包含在本 EXFO 产品中的有毒有害物质或元素的名称及含量

Part Name 部件名称	Lead 铅 (Pb)	Mercury 汞 (Hg)	Cadmium 镉 (Cd)	Hexavalent Chromium 六价铬 (Cr(VI))	Polybrominated biphenyls 多溴联苯 (PBB)	Polybrominated diphenyl ethers 多溴二苯醚 (PBDE)
Enclosure 外壳	O	O	O	O	O	O
Electronic and electrical sub-assembly 电子和电气组件	X	O	X	O	X	X
Optical sub-assembly ^a 光学组件 ^a	X	O	O	O	O	O
Mechanical sub-assembly ^a 机械组件 ^a	O	O	O	O	O	O

Note:

注:

This table is prepared in accordance with the provisions of SJ/T 11364.

本表依据 SJ/T 11364 的规定编制。

O: Indicates that said hazardous substance contained in all of the homogeneous materials for this part is below the limit requirement of GB/T 26572.

O: 表示该有害物质在该部件所有均质材料中的含量均在 GB/T 26572 标准规定的限量要求以下。

X: indicates that said hazardous substance contained in at least one of the homogeneous materials used for this part is above the limit requirement of GB/T 26572. Due to the limitations in current technologies, parts with the “X” mark cannot eliminate hazardous substances.



X: 表示该有害物质至少在该部件的某一均质材料中的含量超出 GB/T 26572 标准规定的限量要求。

标记“X”的部件，皆因全球技术发展水平限制而无法实现有害物质的替代。

a. If applicable.

如果适用。

MARKING REQUIREMENTS
标注要求

Product 产品	Environmental protection use period (years) 环境保护使用期限 (年)	Logo 标志
This EXFO product 本 EXFO 产品	10	
Battery ^a 电池	5	

a. If applicable.
如果适用。

P/N: 1083103

www.EXFO.com · info@EXFO.com

CORPORATE HEADQUARTERS 400 Godin Avenue

Quebec (Quebec) G1M 2K2 CANADA
Tel.: 1 418 683-0211 · Fax: 1 418 683-2170

TOLL-FREE (USA and Canada)

1 800 663-3936

© 2022 EXFO Inc. All rights reserved.
Printed in Canada (2022-12)

