

FVA-3150

Variable Attenuator



Copyright © 2010–2011 EXFO Inc. All rights reserved. No part of this publication may be reproduced, stored in a retrieval system or transmitted in any form, be it electronically, mechanically, or by any other means such as photocopying, recording or otherwise, without the prior written permission of EXFO Inc. (EXFO).

Information provided by EXFO is believed to be accurate and reliable. However, no responsibility is assumed by EXFO for its use nor for any infringements of patents or other rights of third parties that may result from its use. No license is granted by implication or otherwise under any patent rights of EXFO.

EXFO's Commerce And Government Entities (CAGE) code under the North Atlantic Treaty Organization (NATO) is 0L8C3.

The information contained in this publication is subject to change without notice.

Trademarks

EXFO's trademarks have been identified as such. However, the presence or absence of such identification does not affect the legal status of any trademark.

Units of Measurement

Units of measurement in this publication conform to SI standards and practices.

Version number: 1.0.0

Contents

Certification Information	v
1 Introducing the FVA-3150 Variable Attenuator	1
Main Features	1
Front Panel	2
Back Panel	3
Available Models	4
Typical Applications	4
Main Concept	5
Conventions	6
2 Safety Information	7
Laser Safety Information	7
Electrical Safety Information	8
3 Getting Started With Your Variable Attenuator	11
Installing your FVA-3150 Variable Attenuator in a Rackmount	11
Turning the Variable Attenuator On and Off	13
Accessing Menus	14
4 Setting Up Your Variable Attenuator	15
Selecting the Display Intensity	15
Locking Control Key Access	16
Managing the Wavelength Shortlist	17
Selecting the Attenuation	20
Selecting and Using an Attenuation Display Mode	24
Saving and Recalling a Configuration	31
5 Operating Your Variable Attenuator	35
Cleaning and Connecting Optical Fibers	35
Installing the EXFO Universal Interface (EUI)	37
Performing an Attenuation Routine	38
Operating the Shutter	44

Contents

- 6 Controlling Your Variable Attenuator Remotely45**
 - Setting Up the Variable Attenuator for Remote Control45
 - Communication Parameters48
 - Standard Status Data Structure49
 - Command Structure51
 - Error Messages52
 - SCPI Management Errors (System Errors)53
 - RS-232 Connector Pinout54
- 7 Maintenance55**
 - Cleaning EUI Connectors56
 - Cleaning Detector Ports58
 - Recalibrating the Unit59
 - Recycling and Disposal (Applies to European Union Only)60
- 8 Troubleshooting61**
 - Contacting the Technical Support Group61
 - Transportation62
- 9 Warranty63**
 - General Information63
 - Liability64
 - Exclusions65
 - Certification65
 - Service and Repairs66
 - EXFO Service Centers Worldwide67
- A Technical Specifications69**
- B Remote Control Commands71**
 - IEEE 488.2 Required Commands71
 - Specific commands-Quick Reference Command Tree79
- Index103**

Certification Information

FCC Information

Electronic test equipment is exempt from Part 15 compliance (FCC) in the United States. However, compliance verification tests are systematically performed on most EXFO equipment.

CE Information

Electronic test equipment is subject to the EMC Directive in the European Union. The EN61326 standard prescribes both emission and immunity requirements for laboratory, measurement, and control equipment. This unit has undergone extensive testing according to the European Union Directive and Standards.

CSA Information

This unit is certified by the CSA (certificate number 162451) and was evaluated according to applicable CSA and UL standards (as confirmed by “C-US” mark) as well as applicable IEC standards for use in Canada, the United States, and other countries.

EXFO CE **DECLARATION OF CONFORMITY**

Application of Council Directives:	2006/95/EC - The Low Voltage Directive 2004/108/EC - The EMC Directive 2006/66/EC - The Battery Directive 93/68/EEC - CE Marking And their amendments
Manufacturer's Name:	EXFO Inc.
Manufacturer's Address:	400 Godin Avenue Quebec, Quebec Canada, G1M 2K2
Equipment Type/Environment: Trade Name/Model No.:	Test & Measurement / Industrial Variable Attenuator / FVA-3150

Standard(s) to which Conformity is Declared:

EN 61010-1:2001 Edition 2.0	Safety Requirements for Electrical Equipment for Measurement, Control, and Laboratory Use – Part 1: General Requirements.
EN 61326-1:2006	Electrical Equipment for Measurement, Control and Laboratory Use - EMC Requirements
EN 55022: 2006 + A1: 2007	Information technology equipment — Radio disturbance characteristics — Limits and methods of measurement

I, the undersigned, hereby declare that the equipment specified above conforms to the above Directives and Standards.

Manufacturer

Signature: 

Full Name: Stephen Bull, E. Eng
Position: Vice-President Research and Development
Address: 400 Godin Avenue, Quebec (Quebec),
Canada, G1M 2K2
Date: June 2, 2010

1 **Introducing the FVA-3150 Variable Attenuator**

Main Features

The FVA-3150 Variable Attenuator is the instrument that allows you to perform several attenuation related tasks.

The FVA-3150 Variable Attenuator is configured for singlemode and multimode fibers. It is built to offer a high spectral uniformity, an important feature which allows you to maintain the attenuation value throughout the entire WDM spectrum. Its low insertion loss allows you to minimize your loss budget.

The FVA-3150 Variable Attenuator has a program function, which allows you to create custom programs such as automatic attenuation scan.

The Variable Attenuator has the versatility of three display modes:

- Absolute, which includes the insertion loss.
- Reference, in reference to the 0.001 dB level.
- Offset, relative display to any selected reference value.

The FVA-3150 Variable Attenuator is controlled by easy-to-use software, enabling multiple-user configuration storage.

The FVA-3150 Variable Attenuator can be remotely controlled through a GPIB or RS-232 interface.

Introducing the FVA-3150 Variable Attenuator

Front Panel

Front Panel

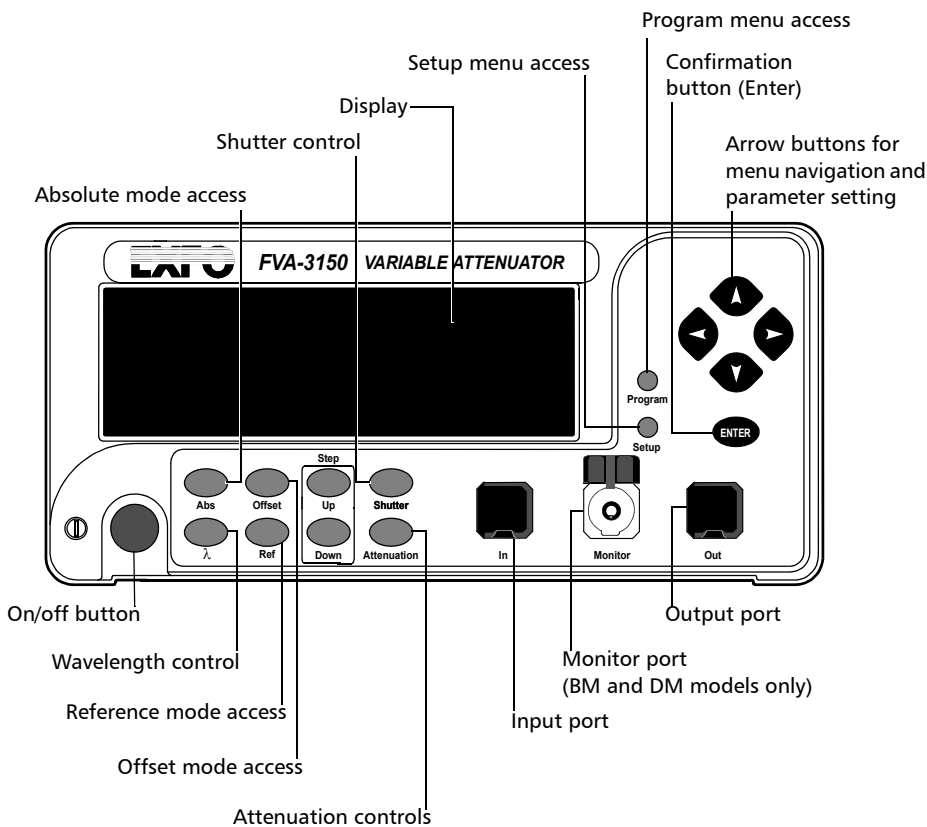

Note: Your FVA-3150 Variable Attenuator may differ slightly from the illustration depending on the specific model of your unit.

Back Panel

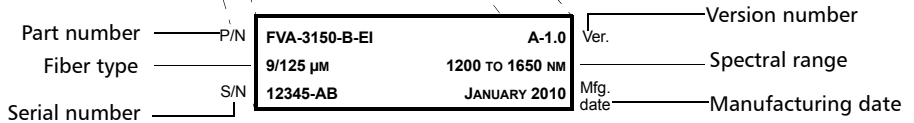
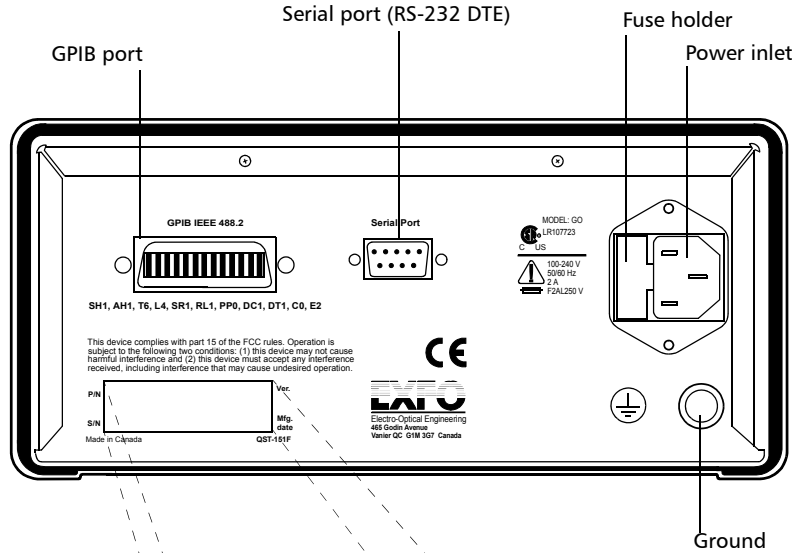

Note: Your FVA-3150 Variable Attenuator may differ slightly from the illustration depending on the specific model of your unit.

Introducing the FVA-3150 Variable Attenuator

Available Models

Available Models

According to the models you own, additional options are available. The FVA-3150-CM, FVA-3150-BM, and FVA-3150-DM all come with a monitor output, which ensures accurate power-level monitoring.

Typical Applications

The FVA-3150 Variable Attenuator is ideal for:

- manufacturing and laboratory applications such as system characterization
- EDFA
- component and system loss simulation
- instrument calibration
- power meter linearity measurement
- spectral tuning

The FVA-3150 Variable Attenuator is particularly suitable to demanding laboratory and manufacturing qualification applications.

Main Concept

The significance of the attenuation value displayed by an optical attenuator may differ from one manufacturer to another. At EXFO, for example, the attenuation displayed by the FVA-3150 Variable Attenuator is the actual loss or attenuation between the input and the output ports of the Variable Attenuator, including the loss of its own internal connectors, after performing a reference reading with a power meter.



IMPORTANT

The Variable Attenuator has been calibrated with a light source connected to the input port and a power meter connected to the output port. For optimum performance, do not interchange the input and output connections.

Conventions

Before using the product described in this manual, you should understand the following conventions:



WARNING

Indicates a potentially hazardous situation which, if not avoided, could result in *death or serious injury*. Do not proceed unless you understand and meet the required conditions.



CAUTION

Indicates a potentially hazardous situation which, if not avoided, may result in *minor or moderate injury*. Do not proceed unless you understand and meet the required conditions.



CAUTION

Indicates a potentially hazardous situation which, if not avoided, may result in *component damage*. Do not proceed unless you understand and meet the required conditions.



IMPORTANT

Refers to information about this product you should not overlook.

2 ***Safety Information***

Laser Safety Information



WARNING

Do not install or terminate fibers while a light source is active. Never look directly into a live fiber and ensure that your eyes are protected at all times.



WARNING

Use of controls, adjustments and procedures for operation and maintenance other than those specified herein may result in hazardous radiation exposure or impair the protection provided by this unit.

Safety Information

Electrical Safety Information

Electrical Safety Information

This unit uses an international safety standard three-wire power cable. This cable serves as a ground when connected to an appropriate AC power outlet.

Note: *If you need to ensure that the unit is completely powered off, disconnect the power cable.*



WARNING

- Insert the power cable plug into a power outlet with a protective ground contact. Do not use an extension cord without a protective conductor.
- Before powering on the unit, connect all grounding terminals, extension cords and devices to a protective ground via a ground socket. Any interruption of the protective grounding is a potential shock hazard and may cause personal injury. Whenever the ground protection is impaired, do not use the unit and secure it against any accidental operation.
- Do not tamper with the protective ground terminal.

The color coding used in the electric cable depends on the cable. New plugs should meet the local safety requirements and include:

- adequate load-carrying capacity
- ground connection
- cable clamp



IMPORTANT

EXFO assumes no liability if you attempt to perform internal service on this unit.



WARNING

- Use this unit indoors only.
- Position the unit so that the air can circulate freely around it.
- Operation of any electrical instrument around flammable gases or fumes constitutes a major safety hazard.
- Do not remove unit covers during operation.
- To avoid electrical shock, do not operate the unit if any part of the outer surface (covers, panels, etc.) is damaged.
- Only authorized personnel should carry out adjustments, maintenance or repair of opened units under voltage. A person qualified in first aid must also be present. Do not replace any components while power cable are connected.
- Use only fuses with the required rated current and specified type (IEC, 5 mm x 20 mm (0.197 in x 0.787 in), fast-blow, 250 V, 2 A). Do not use repaired fuses or short-circuited fuse holders.
- Capacitors inside the unit may be charged even if the unit has been disconnected from its electrical supply.

Safety Information

Electrical Safety Information

Equipment Ratings	
Temperature	
► Operation	0 °C to 40 °C (32 °F to 104 °F)
► Storage	-40 °C to 70 °C (-40 °F to 158 °F)
Relative humidity ^a	0 % to 80 % non-condensing
Maximum operation altitude	2000 m (6562 ft)
Pollution degree	2
Overtoltage category	II
Power supply rating ^b	100 V to 240 V (50 Hz/60 Hz) maximum input power 2 A

- a. Measured in 0 °C to 31 °C (32 °F to 87.8 °F) range, decreasing linearly to 50 % at 40 °C (104 °F).
b. Not exceeding $\pm 10\%$ of the nominal voltage.

The following label is located on the back panel of the unit:

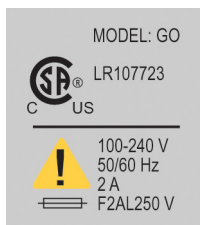

3 Getting Started With Your Variable Attenuator

Installing your FVA-3150 Variable Attenuator in a Rackmount

You can place your FVA-3150 Variable Attenuator in a rackmount to facilitate its usage.

To install the rackmount:

1. Fix the angle iron using four flat Phillips screws.

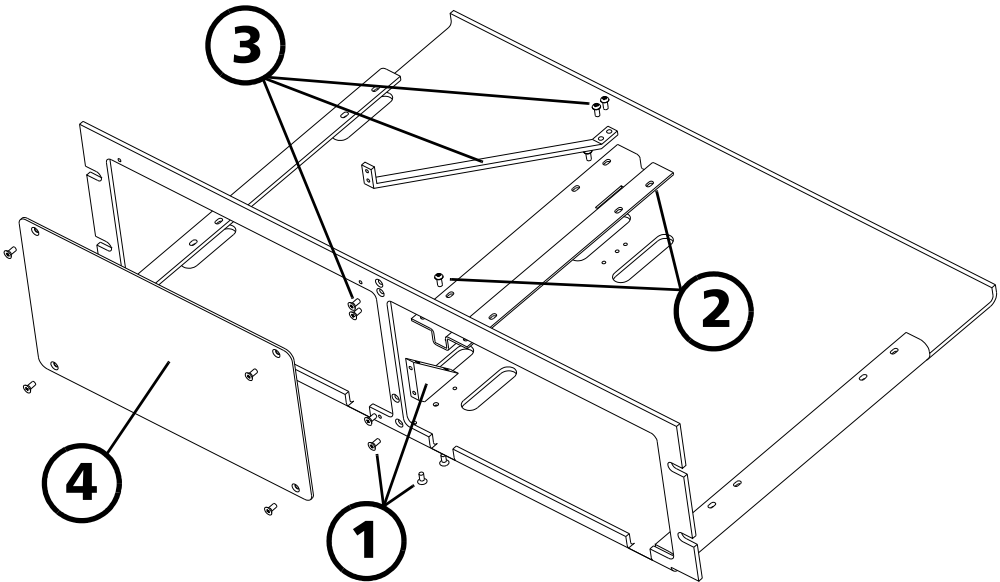

2. Fix the rackmount bracket to the frame using two round Phillips screws.
3. Fix the rackmount stiffener using two flat Phillips screws (for the front panel) and two round Phillips screws.
4. If your rackmount will contain only one unit, fix the rackmount cover plate to the empty part of the frame using four flat Phillips screws.

Getting Started With Your Variable Attenuator

Installing your FVA-3150 Variable Attenuator in a Rackmount

To install your FVA-3150 Variable Attenuator in a rackmount:

1. Slide the benchtop unit into the rackmount and tighten it from underneath using the four cover fixing screws.

If measurement X on the illustration exceeds 11.125 in., fix the unit into the four holes identified as A. Otherwise, use the other four holes.

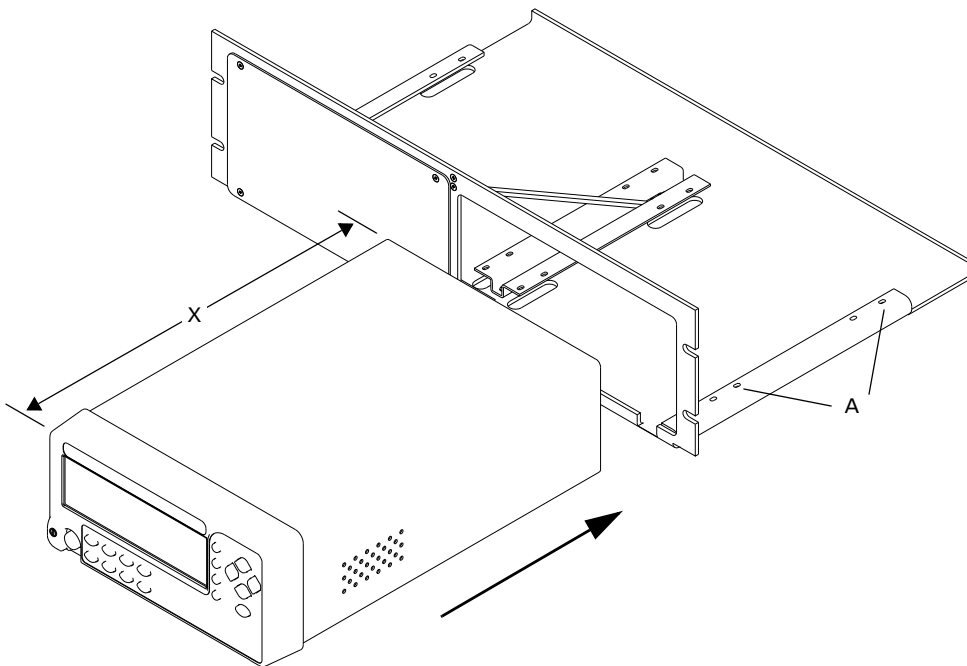

2. If a second benchtop is to be installed, remove the cover plate and repeat step 1.

Turning the Variable Attenuator On and Off

When you turn on your unit:

- it beeps twice
- it performs a self-test
- it enters the mode that was active at the last power-off (Absolute, Offset, or Reference)

When you turn the unit off, the following items remain in read-only memory:

- current shutter state
- current display mode
- current attenuation setting
- current wavelength
- shortlisted wavelengths
- each wavelength offsets
- step size
- remote-control settings
- programmed attenuation routine settings
- saved configurations

Note: *The power cord is the most effective disconnecting device. To ensure that the power is completely turned off, disconnect the power cord.*

Getting Started With Your Variable Attenuator

Accessing Menus

To turn the unit on and off:

Use the red button in the lower left corner of the front panel.



IMPORTANT

Some internal mechanisms can sometimes take a few seconds to adjust, depending on the operation performed. While the Variable Attenuator is performing internal adjustments (for example after having changed the wavelength or the attenuation setting), no buttons should be pressed while Program flashes on the display.



CAUTION

The Variable Attenuator should not be turned off while Program is flashing in the lower left corner of the display.

Accessing Menus

The blue buttons to the right of the display give access to single-level menus: Program and Setup. The following diagram shows the menus and their items.

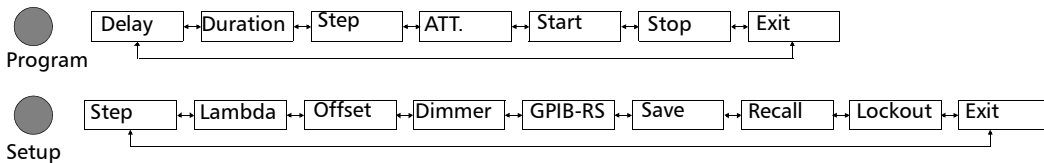

To move (in a loop) between the menu items:

Use the left/right arrows.

To exit a menu:

Press the button that gave access to the menu;

OR

Use the left/right arrows to move until EXIT is displayed, then press ENTER.

4 **Setting Up Your Variable Attenuator**

Selecting the Display Intensity

Display intensity may be set to high or low. You can also turn off the display without turning off the unit.

To select the display intensity:

1. Press the Setup button.
2. Use the left/right arrows to move until it displays **DIMMER**.



3. Press ENTER. The current dimmer state will start flashing.
4. Use the up/down arrows to modify the dimmer status: LO, HI, or OFF.
5. Press ENTER.

Note: *Setting the dimmer to OFF turns off the display. Press any button to turn the display back on.*

6. To exit the Setup menu, press the Setup button.

Setting Up Your Variable Attenuator

Locking Control Key Access

Locking Control Key Access

To prevent unintended use of the FVA-3150 Variable Attenuator during operation, you can lock the control keys (the blue buttons on the front panel of the unit).

To lock the control key access:

1. Press the Setup button.
2. Use the left/right arrows until **LOCKOUT** is displayed.
3. Press ENTER.

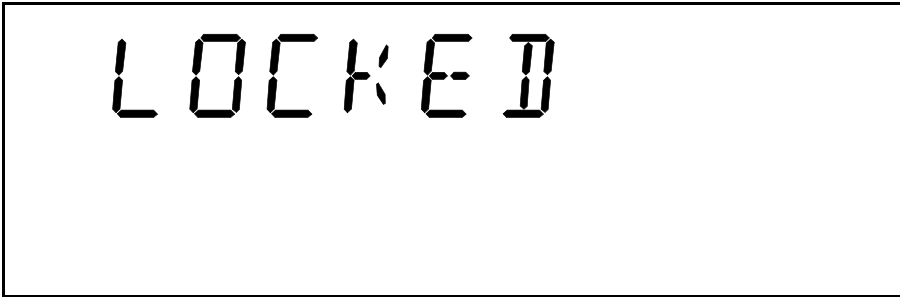

The **LOCKED** message is briefly displayed, then the unit reverts to the settings that were active before you entered the Setup menu. All control keys are deactivated.

To unlock the keypad:

1. Press the Setup button.
2. Press ENTER.

The **UNLOCKED** message is briefly displayed. All control keys are reactivated.

Managing the Wavelength Shortlist

The FVA-3150 Variable Attenuator can test at many wavelengths. The accepted wavelengths depend on the configuration of your unit. You can store the wavelengths you use most often in a shortlist so you can quickly access them. The shortlist includes up to 20 wavelengths.

Note: *When switching to a new wavelength, the attenuator motor will reposition itself to keep the current attenuation value for the new wavelength.*

Refer to *Technical Specifications* on page 69 for more information on the wavelength ranges that you can enter.

Setting Up Your Variable Attenuator

Managing the Wavelength Shortlist

To add a wavelength to the shortlist:

1. Press the Setup button.
2. Use the left/right arrows to move until **LAMBDA** is displayed.

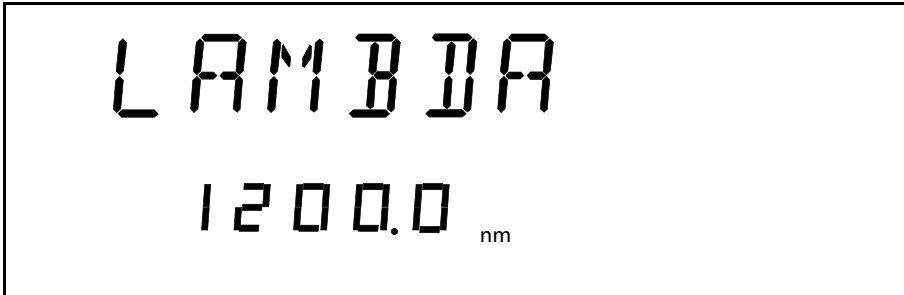

3. Use the up/down arrows to move until **Add** is displayed .
4. Press ENTER. A wavelength will be suggested and the first digit will flash.
5. Use the up/down arrows to change the flashing digit and the left/right arrows to activate the next digit.
6. Once all digits are set, press ENTER.
7. To exit the Setup menu, press the Setup button.

Note: *If you are trying to enter a wavelength that is outside the wavelength range, the Variable Attenuator will beep and reject the wavelength.*

To delete a wavelength from the shortlist:

1. Press the Setup button.
2. Press the left/right arrows until **LAMBDA** is displayed.
3. Use up/down arrows to move until the wavelength you want to delete appears in the lower portion of the display.
4. Press ENTER. The wavelength will start flashing.
5. Set all the wavelength digits to zero. To do so, use the up/down arrows to change the flashing digit and the left/right arrows to activate the next digit.
6. Press ENTER.
7. To exit the Setup menu, press the Setup button.

To delete all wavelengths from the shortlist:

1. Press the Setup button.
2. Press the left/right arrows until **LAMBDA** is displayed.
3. Press the up/down arrows until **DEL ALL** appears in the lower portion of the display.
4. Press ENTER.

Setting Up Your Variable Attenuator

Selecting the Attenuation

Selecting the Attenuation

The attenuation can be set using two methods:

- By using the up and down arrows buttons, the attenuation is modified one step (up or down) at a time.
- By using the Attenuation button, you can quickly and precisely set the attenuation to a specific value

The available step sizes are: 0.01, 0.02, 0.05, 0.1, 0.2, 0.5, 1, 2, 5, 10, 20, and 50 dB.

Note: *Selecting a larger step size allows for faster attenuation scanning.*

To change the step size:

1. Press the Setup button.
2. Press the left/right arrows until **STEP** is displayed.

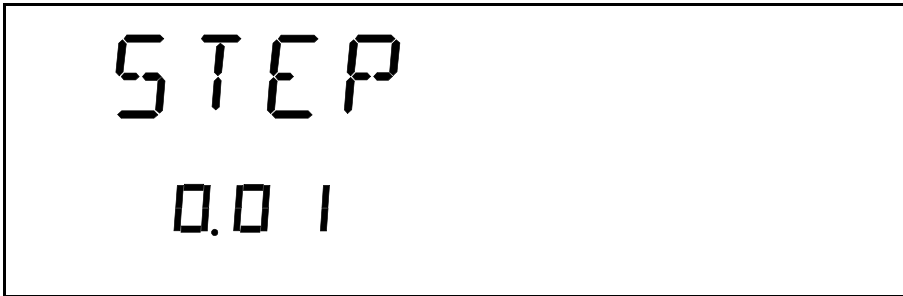

3. Press ENTER. The current step size will start flashing.
4. Using the up/down arrows, select one of the available step sizes.
5. Press ENTER.
6. To exit the Setup menu, press the Setup button.

To enter a specific attenuation value:

1. Press the Attenuation button. The first segment of the attenuation setting starts flashing.

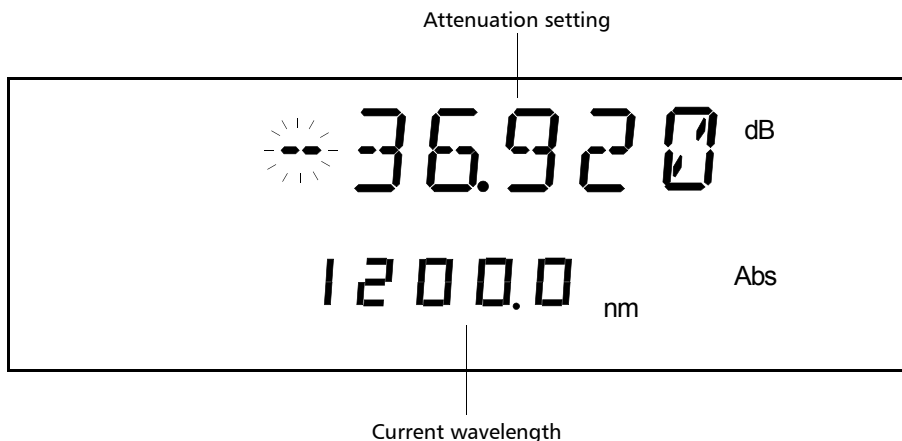

2. Enter a new attenuation value. Use the up/down arrows to change the flashing digit and the left/right arrows to activate the next digit.

Note: *The difference with the current attenuation must be of at least 0.002 dB for the new attenuation setting to be valid. For more information on the variable attenuator optical resolution see Technical Specifications on page 69.*

3. Once you have entered all the segments, press ENTER.

Note: *If you try to set an attenuation value that is outside the attenuation range, the Variable Attenuator will default to the minimum or maximum setting.*

The attenuation range (minimum and maximum possible attenuation) of your FVA-3150 Variable Attenuator depends on the model you have at hand. Although EXFO guarantees that the minimum insertion loss is below a specified value, it may vary slightly from one wavelength to another and from one variable attenuator to another.

Setting Up Your Variable Attenuator

Selecting the Attenuation

To set the minimum attenuation:

1. Select a wavelength, by pressing λ until you reach the desired wavelength.

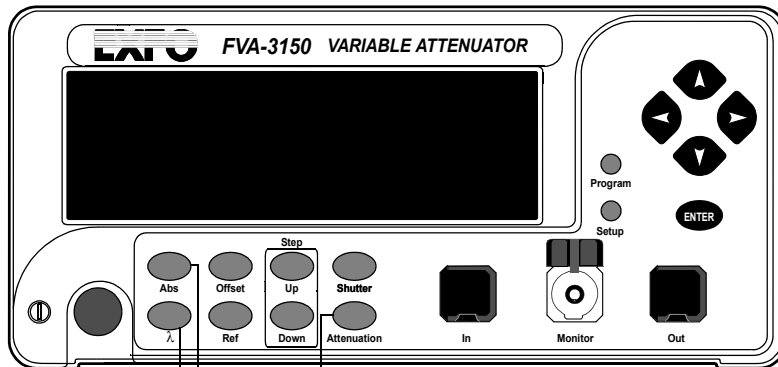

- Wavelength control
- Absolute mode access
- Attenuation
2. Press the Abs button.
 3. Press the Attenuation button and set an attenuation of 00.000 dB.
 4. Press ENTER. The Variable Attenuator will default to the minimum insertion loss.

To set the maximum attenuation:

- 1.** Select a wavelength by pressing λ until you reach the desired wavelength.
- 2.** Press the Abs button.
- 3.** Press the Attenuation button and set an attenuation of -99.999 dB.
- 4.** Press ENTER. The Variable Attenuator will default to the maximum attenuation.

Setting Up Your Variable Attenuator

Selecting and Using an Attenuation Display Mode

Selecting and Using an Attenuation Display Mode

Note: *The total or absolute attenuation referred to in this manual is the actual optical insertion loss between the input and output ports, including the connectors.*

The Variable Attenuator offers the following three attenuation display modes:

- Absolute attenuation mode
- Offset attenuation mode
- Reference attenuation mode

Display Mode	Description
Absolute	The displayed attenuation value takes into account both the absolute value and the offset value. Default mode upon initial activation.
Reference (relative)	The displayed attenuation value is the attenuation relative to a defined reference value, which can be any value within the unit's attenuation range and may be selected as the reference.

Setting Up Your Variable Attenuator

Selecting and Using an Attenuation Display Mode

Display Mode	Description
Offset (X + B)	<p>The displayed attenuation is the sum of two components:</p> <ul style="list-style-type: none">➤ X = physical attenuation introduced by the unit.➤ B = correction factor or offset; it may be used to compensate for losses along the connecting fibers or for losses displaying the attenuation as a power value. <p>Offset mode can be best explained by the following example:</p> <ul style="list-style-type: none">➤ An optical light source with a power output of -14 dBm at 1310 nm is connected to a variable attenuator. Because of internal losses, the minimum insertion loss at 1310 nm is approximately 2 dB. This means that the maximum optical power available at the output port of the attenuator is -16 dBm (-14 + -2). If we now set an offset value of -14 dBm, the (large digits) will display the optical power level at the output port of the attenuator. Using the above setup (that is, light source, variable attenuator, and an accurately determined offset value), EXFO has created a precise variable light source with a dynamic range of nearly 100 dB. <p>Note: You must define the appropriate B value for the operating wavelength before enabling X+B mode. A different B value may be assigned to each wavelength in the wavelength box.</p>

Note: The active display mode is always indicated on the display.

Setting Up Your Variable Attenuator

Selecting and Using an Attenuation Display Mode

To set Absolute attenuation mode:

Press the Abs button at any time to enable Absolute mode.

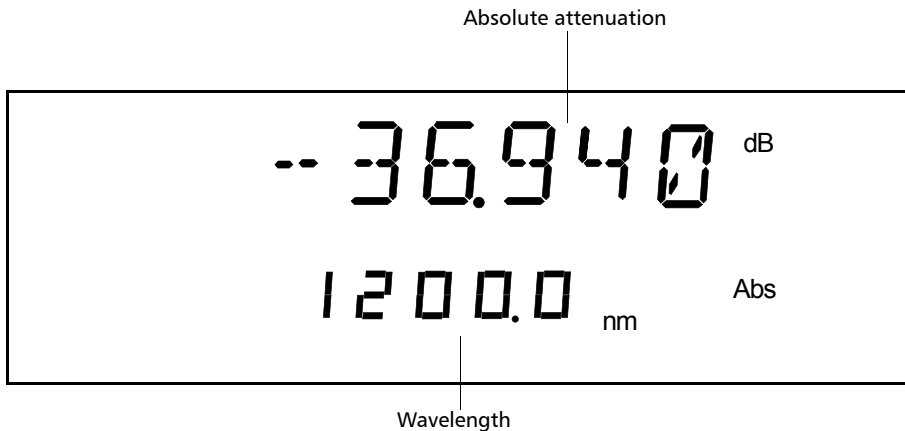

In Offset mode, the offset value is always displayed in the lower portion of the display while the upper portion (large digits) displays the sum of two values.

Before enabling the Offset mode, it is necessary to define the appropriate offset value for the operating wavelength. A different offset value can be associated with each wavelength in the shortlist.

Setting Up Your Variable Attenuator

Selecting and Using an Attenuation Display Mode

To define an offset value for a specific wavelength:

1. Set the Variable Attenuator to the appropriate wavelength.
2. Select Setup.
3. Press the left/right arrows until **OFFSET** is displayed.

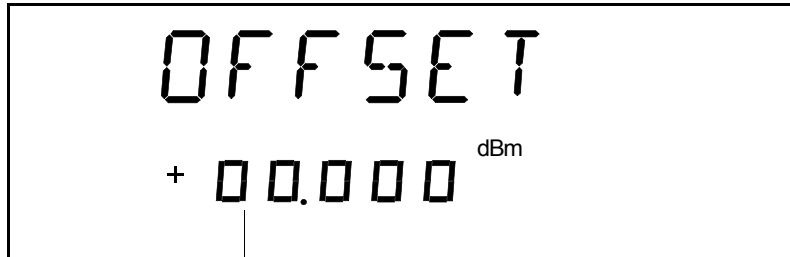

Current offset value for
the selected wavelength

4. Press ENTER. The first segment of the current offset value will start flashing.
5. Enter a new offset. Use the up/down arrows to change the flashing digit and the left/right arrows to activate the next digit.

Note: Offset values between -99.999 and 99.999 may be entered. Use dB when the offset represents loss and dBm when the offset represents power.

6. Once all the segments have been entered, press ENTER.
7. To exit the Setup menu, press the Setup button.

Setting Up Your Variable Attenuator

Selecting and Using an Attenuation Display Mode

To use the offset mode:

1. Ensure that the display is in Absolute mode (select Abs).
2. Select the appropriate wavelength by pressing λ until you reach the desired wavelength.
3. If necessary, set an offset value.
4. Select Offset. The display will switch to Offset mode.

Note: *The offset value can be modified while Offset mode is active.*

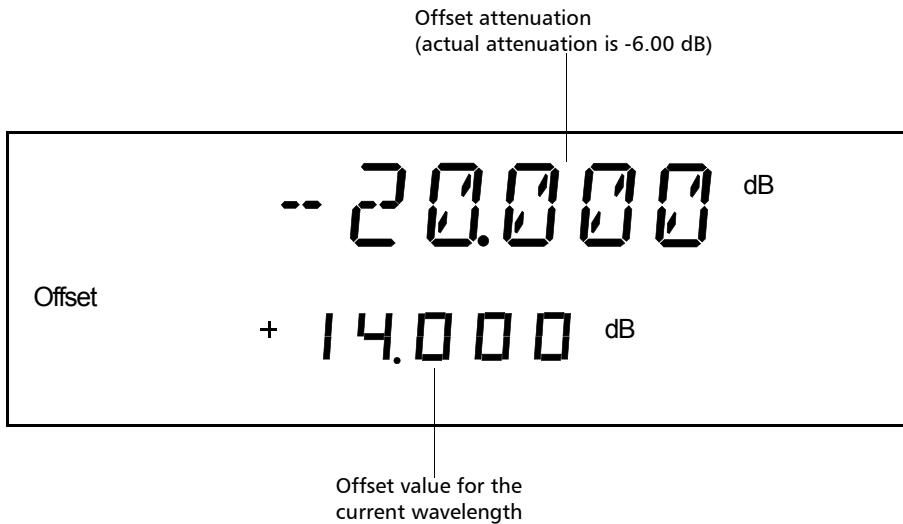

Setting Up Your Variable Attenuator

Selecting and Using an Attenuation Display Mode

Any value within the attenuation range may be selected as the reference. When Reference mode is enabled (by selecting Ref):

- the current absolute attenuation setting becomes the reference value and appears in the lower portion of the display; and
- **0.000 dB** (relative attenuation) is displayed in the upper portion of the display.

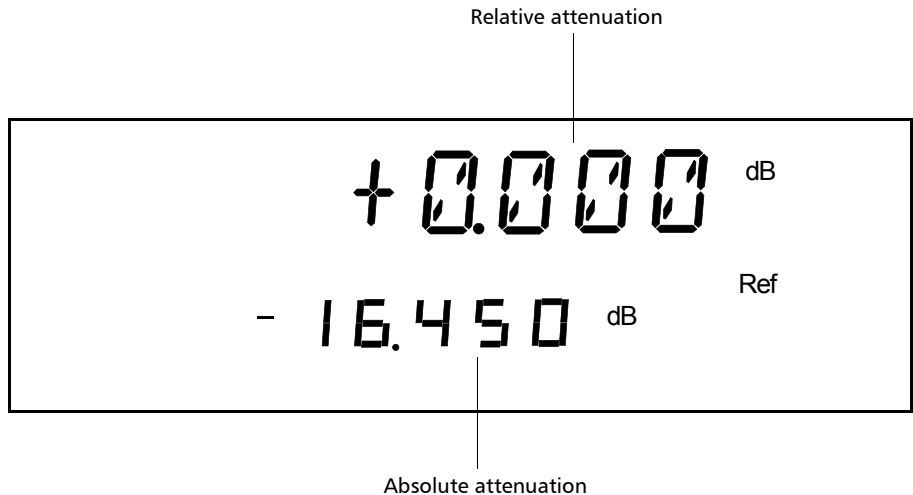

If the attenuation is increased by 1.0 dB, the upper digits (relative attenuation) will display **-1.000 dB** and the lower digits (absolute attenuation) will indicate **-17.450 dB**.

Setting Up Your Variable Attenuator

Selecting and Using an Attenuation Display Mode

To use the Reference mode:

1. Ensure that the display is in Absolute mode (select Abs).

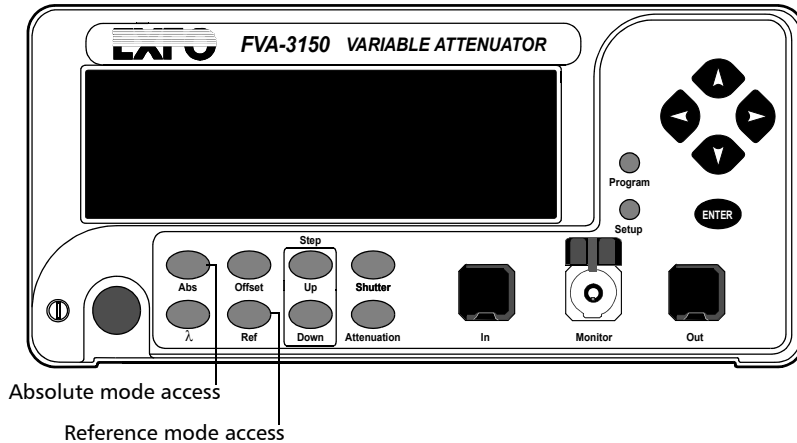

2. Select the appropriate wavelength.
3. Set the attenuation to the desired reference value.
4. Press the Ref. button. The display will switch to Reference mode.

Note: Pressing Ref with the Reference mode already active will reset the reference value to the current absolute attenuation setting.

Saving and Recalling a Configuration

Once the Variable Attenuator has been customized for a specific application or user, it is possible to save the configuration. Saved parameters are:

- current wavelength and attenuation
- display mode
- step size
- shortlisted wavelengths
- each wavelength offset
- programmed attenuation routine settings

Up to ten configurations can be saved and recalled.

Setting Up Your Variable Attenuator

Saving and Recalling a Configuration

To save a configuration:

1. Customize the Variable Attenuator as required.
2. Press the Setup button.
3. Press the left/right arrows until **SAVE** is displayed.

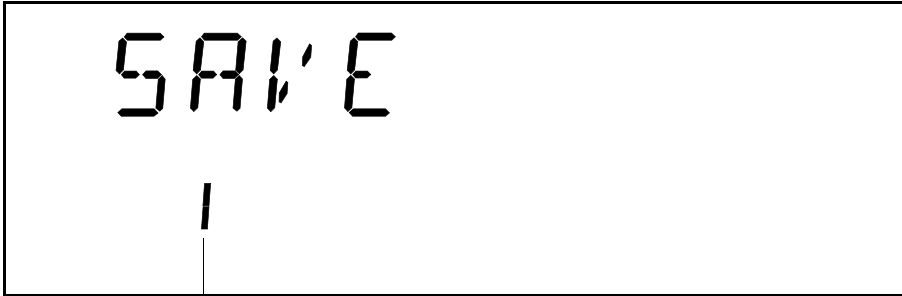

Configuration number

4. Press ENTER. The configuration number will start flashing.
5. Press the up/down arrows to modify the configuration number.
6. Press ENTER.
7. Press the Setup button to exit the menu.

Once you have saved a configuration (see *Saving and Recalling a Configuration* on page 31), you can recall it at any time.

To recall a configuration:

1. Press the Setup button.
2. Press the left/right arrows until **RECALL** is displayed.

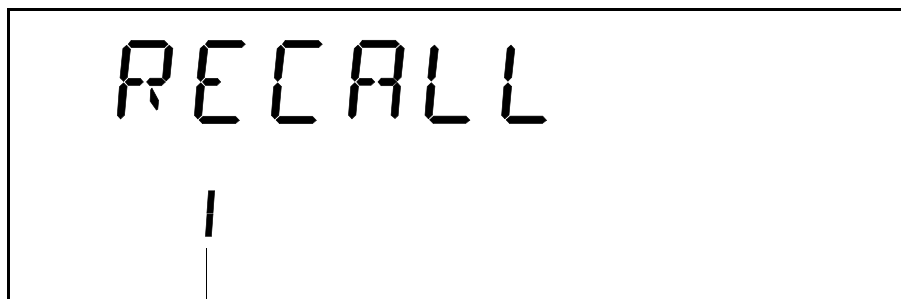

Configuration number

3. Press ENTER. The configuration number (bottom of the screen) will start flashing.
4. Use the up/down arrows to select the number of the configuration you want to recall.
5. Press ENTER.
6. To exit the Setup menu, press the Setup button.

5 **Operating Your Variable Attenuator**

Cleaning and Connecting Optical Fibers



IMPORTANT

To ensure maximum power and to avoid erroneous readings:

- Always inspect fiber ends and make sure that they are clean as explained below before inserting them into the port. EXFO is not responsible for damage or errors caused by bad fiber cleaning or handling.
- Ensure that your patchcord has appropriate connectors. Joining mismatched connectors will damage the ferrules.

To connect the fiber-optic cable to the port:

- 1.** Inspect the fiber using a fiber inspection microscope. If the fiber is clean, proceed to connecting it to the port. If the fiber is dirty, clean it as explained below.
- 2.** Clean the fiber ends as follows:
 - 2a.** Gently wipe the fiber end with a lint-free swab dipped in isopropyl alcohol.
 - 2b.** Use compressed air to dry completely.
 - 2c.** Visually inspect the fiber end to ensure its cleanliness.

Operating Your Variable Attenuator

Cleaning and Connecting Optical Fibers

- 3.** Carefully align the connector and port to prevent the fiber end from touching the outside of the port or rubbing against other surfaces.

If your connector features a key, ensure that it is fully fitted into the port's corresponding notch.

- 4.** Push the connector in so that the fiber-optic cable is firmly in place, thus ensuring adequate contact.

If your connector features a screwsleeve, tighten the connector enough to firmly maintain the fiber in place. Do not overtighten, as this will damage the fiber and the port.

Note: *If your fiber-optic cable is not properly aligned and/or connected, you will notice heavy loss and reflection.*

Installing the EXFO Universal Interface (EUI)

The EUI fixed baseplate is available for connectors with angled (APC) or non-angled (UPC) polishing. A green border around the baseplate indicates that it is for APC-type connectors.

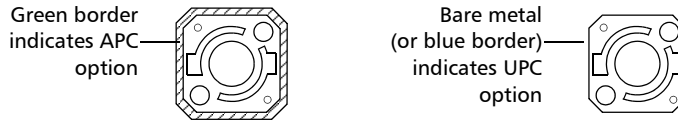

To install an EUI connector adapter onto the EUI baseplate:

- 1.** Hold the EUI connector adapter so the dust cap opens downwards.

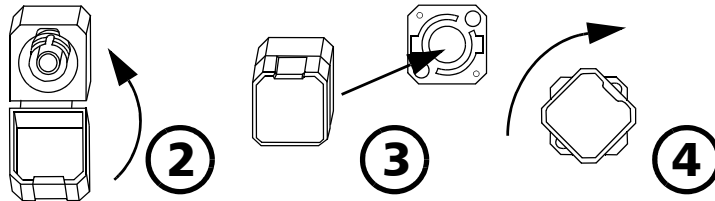

- 2.** Close the dust cap in order to hold the connector adapter more firmly.
- 3.** Insert the connector adapter into the baseplate.
- 4.** While pushing firmly, turn the connector adapter clockwise on the baseplate to lock it in place.

Performing an Attenuation Routine

You can program the FVA-3150 Variable Attenuator to perform an attenuation routine. Once the routine is started, the variable attenuator will automatically increase or decrease the inserted attenuation (by steps), return to the initial attenuation state, and perform the routine again until you stop it. The following parameters may be set:

- delay: the beginning of the attenuation routine may be delayed by up to 999 hours, 59 minutes and 59 seconds
- duration: the variable attenuator can remain up to 999 hours, 59 minutes and 59 seconds at each attenuation step
- number of steps: the attenuation routine may comprise up to 99 steps
- attenuation difference between two steps: the difference in attenuation between two steps may be up to 99.999 dB

Note: *Once set, the routine parameters remain in memory until new ones are entered.*

The following example shows how parameters are set up, as well as how an attenuation routine works.

If you start an attenuation routine with the following settings:

- Delay: 5 minutes
- Duration: 10 seconds
- Number of steps: 3
- Attenuation difference between each step: -1 dB, and
- Initial attenuation state: -10 dB

the Variable Attenuator will:

- Wait five minutes before starting the routine
- Remain at -10 dB attenuation for 10 seconds (step 0)

Operating Your Variable Attenuator

Performing an Attenuation Routine

- Switch to -11 dB attenuation for 10 seconds (step 1)
- Switch to -12 dB attenuation for 10 seconds (step 2)
- Switch to -13 dB attenuation for 10 seconds (step 3), and
- Return to the initial attenuation state (-10 dB) for 10 seconds (step 0) and repeat the routine until you stop it

To program the attenuation routine:

1. Press the Program button.
2. Press ENTER. The first digit will start flashing. Use the up/down arrows to change the flashing digit and the left/right arrows to activate the next digit.

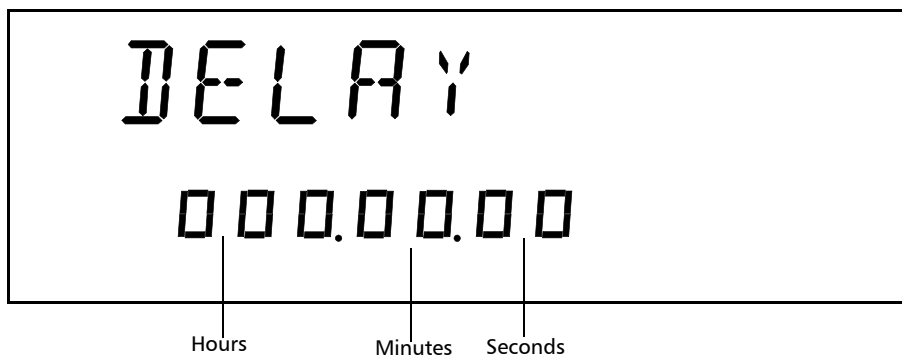

Operating Your Variable Attenuator

Performing an Attenuation Routine

3. If you do not want the routine to be delayed, leave the delay at 000.00.00.
4. Once the delay is set, press ENTER.

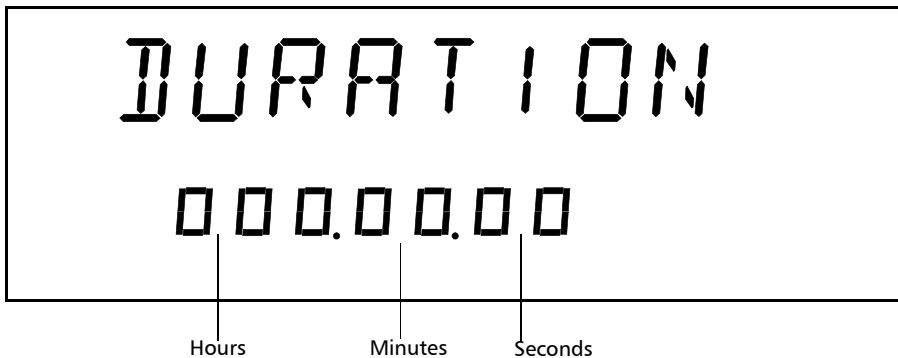

5. Select the duration (time for which the Variable Attenuator will remain at each step). Press the right arrow.
6. Press ENTER. The first digit will start flashing. Use the up/down arrows to change the flashing digit and the left/right arrows to activate the next digit.
7. Once the duration is set, press ENTER.
8. Press the right arrow. You will see the following display.

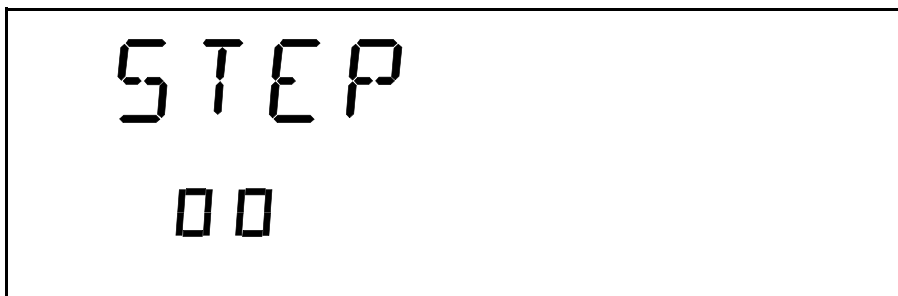

Operating Your Variable Attenuator

Performing an Attenuation Routine

9. Press ENTER. The first digit will start flashing. Use the up/down arrows to change the flashing digit and the left/right arrows to activate the next digit.
10. Once the number of steps is set, press ENTER.
11. Press the right arrow. To set the attenuation difference between the steps.

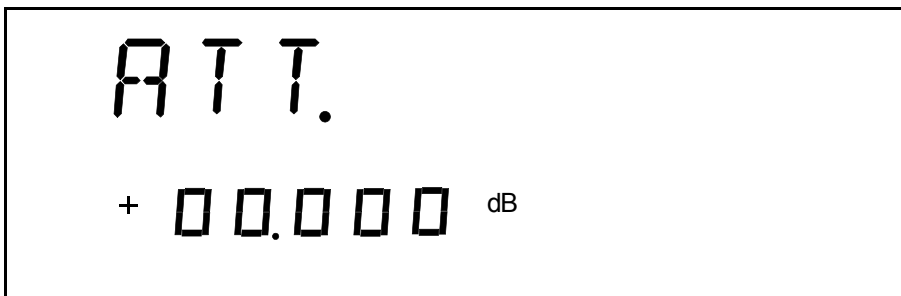

12. Press ENTER. The first segment will start flashing. Use the up/down arrows to change the flashing digit and the left/right arrows to activate the next digit.

Note: *Entering a negative value will increase the attenuation (in absolute value) during the routine. Entering a positive value will decrease it.*

13. Once the step size is set, press ENTER.

Note: *The difference with the current attenuation must be of at least 0.002 dB for the new attenuation step size to be valid.*

14. Press the Program button to exit the menu.

Note: *The initial attenuation state counts as a step.*

Operating Your Variable Attenuator

Performing an Attenuation Routine

To start a routine:

1. Set the wavelength by pressing λ until you reach the desired wavelength.
2. Set the Variable Attenuator to the initial attenuation.
3. Press Program.

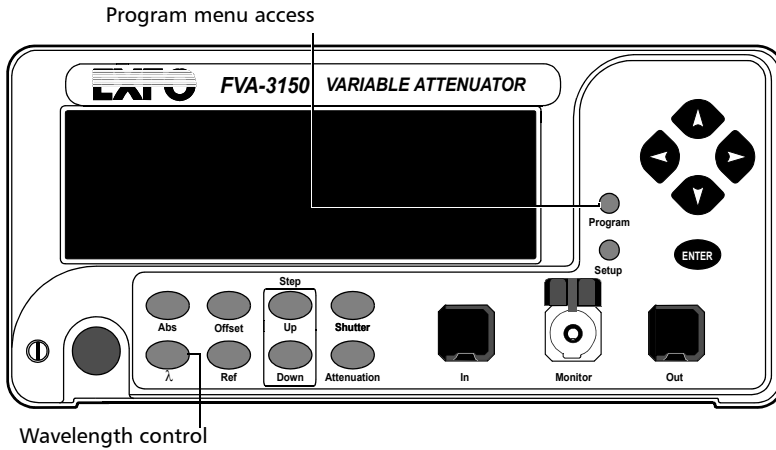

4. Press left/right arrows until **START** is displayed.
5. Press ENTER. **Program**, in the lower left portion of the display, indicates that an attenuation routine is in progress.

Note: During a program, if the attenuation reaches the limit of the attenuation range, it will remain set at this value until the routine is completed.

Once you have started the routine, the display goes back to the current attenuation mode display.

To know...	perform the following steps
how much time is left in the delay	Press Program Press the left/right arrows until DELAY is displayed.
how much time is left in the current step	Press Program Press the left/right arrows until DURATION is displayed.
how many steps are left in the current routine	Press Program Press the left/right arrows until STEP is displayed.

To stop the attenuation routine:

- 1.** Press Program.
- 2.** Press the left/right arrows until **STOP** is displayed.
- 3.** Press ENTER.

The routine completes the current attenuation step, then stops (Program disappears from the display).

Operating the Shutter

The optical shutter is an electro-mechanical device which, when activated, totally blocks light transmission.

To block light transmission:

Use the Shutter button to turn the shutter on or off. When the shutter is activated, **Shutter On** appears in the lower right portion of the display.

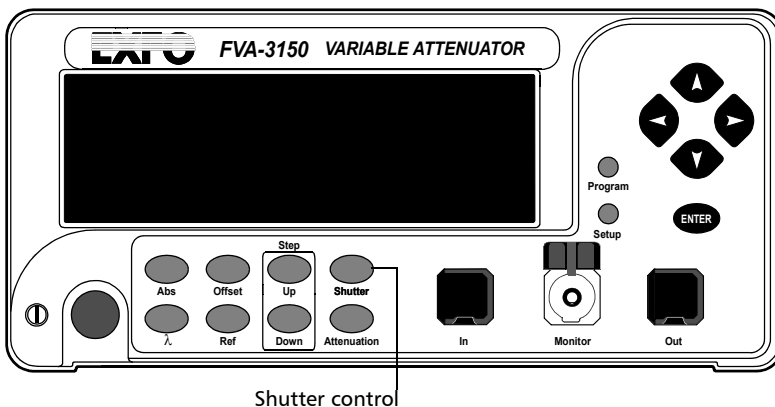

CAUTION

Using the shutter continuously at a rate of one cycle per three seconds may damage the instrument permanently or seriously reduce its life cycle.

6 **Controlling Your Variable Attenuator Remotely**

The FVA-3150 Variable Attenuator can be remotely controlled either by:

- a GPIB interface (through a GPIB cable connected to the GPIB port), or
- an RS-232 interface (through a serial cable connected to the serial port)

The commands used in both protocols are the same and are described in the following pages. When the Variable Attenuator is being remotely controlled, **Remote** appears in the lower left corner of the display.

Note: *If you have already designed a GPIB program to control an attenuator from EXFO's IQS Series (IQS-3100 or IQS-3150), you can reuse sections for the FVA-3150.*

Setting Up the Variable Attenuator for Remote Control

To remotely control the Variable Attenuator, you need to set a GPIB address or activate the RS-232 port from the FVA-3150 front panel.

To set up the Variable Attenuator for remote:

1. Press Setup.
2. Use the left/right arrows to select **GPIB-RS**.

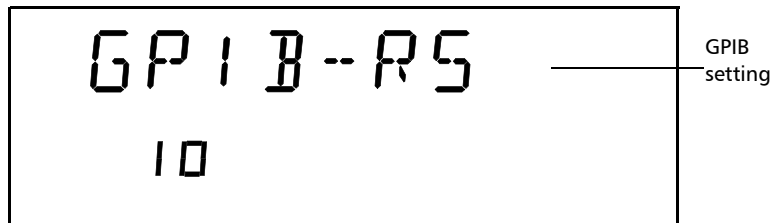

Controlling Your Variable Attenuator Remotely

Setting Up the Variable Attenuator for Remote Control

To select remote command mode:

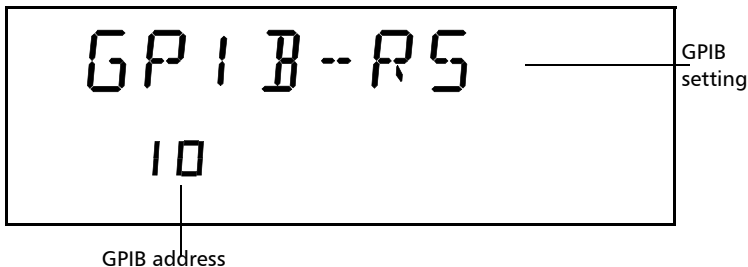

1. If you have select **GP1B-RS** as a command mode, you only need to set the address.
2. If you want to select the **RS-232** mode, press ENTER.

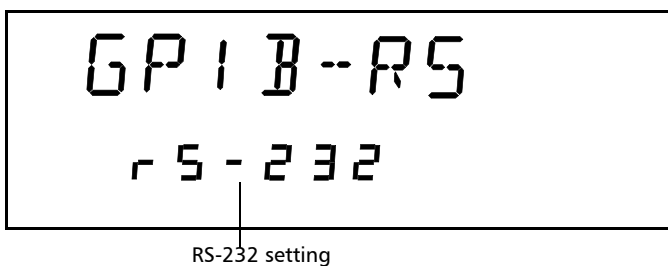

3. Use the up and down arrows to reach **RS-232** (before setting GPIB address 1 or GPIB address 30).
4. Press ENTER.
5. To exit the Setup menu, press the Setup button.

Controlling Your Variable Attenuator Remotely

Setting Up the Variable Attenuator for Remote Control

To select a GPIB address:

1. Once you selected GPIB as a command mode, you can set the GPIB address you want.
2. Press ENTER. The bottom part of the displays will start flashing.
3. Using the up and down arrows, select the GPIB address you want.

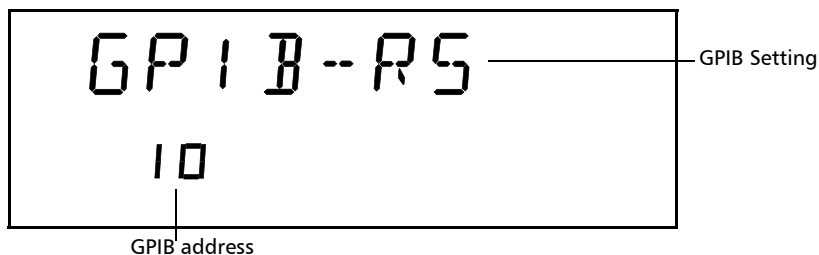

Communication Parameters

Note: *EOS* means End of String. *EOI* means End or Identify.

For GPIB Communication	
Terminate Read on EOS	Yes
Set EOI with EOS on Writes	Yes
Type of comparison on EOS	8-bits
EOS byte	0Ah
Sends EOI at end of Writes	Yes
GPIB primary address	10
GPIB secondary address	None

For RS-232 Communication	
EOS bytes	0Ah
Baud rate	9600 bps
Parity	None
Data bits	8 bits
Stop bits	1 bits
Flow control	None
Activation	see <i>Setting Up the Variable Attenuator for Remote Control</i> on page 45

Standard Status Data Structure

The following page illustrates the four common status and enable registers as defined by IEEE 488.2. This diagram is a useful aid in understanding the general commands and how a service request (SRQ) is generated. The four registers are:

- Standard Event Status Register (ESR)
- Standard Event Status Enable Register (ESE)
- Status Byte Register (STB)
- Service Request Enable Register (SRE)

Bit	ESR	ESE	STB	SRE
0	Operation Complete	Operation Complete	Source Status	Source Status
1	Request Control	Request Control		
2	Query Error	Query Error	Error Bit	
3	Device-Dependent Error	Device-Dependent Error	Questionable Status	Questionable Status
4	Execution Error	Execution Error	Event Status Bit	Event Status Bit
5	Command Error	Command Error	Message Available	Message Available
6	User Request	User Request	Master Summary Status	Request Service/Master Summary Status
7	Power On	Power On	Operation Status	Operation Status

Controlling Your Variable Attenuator Remotely

Standard Status Data Structure

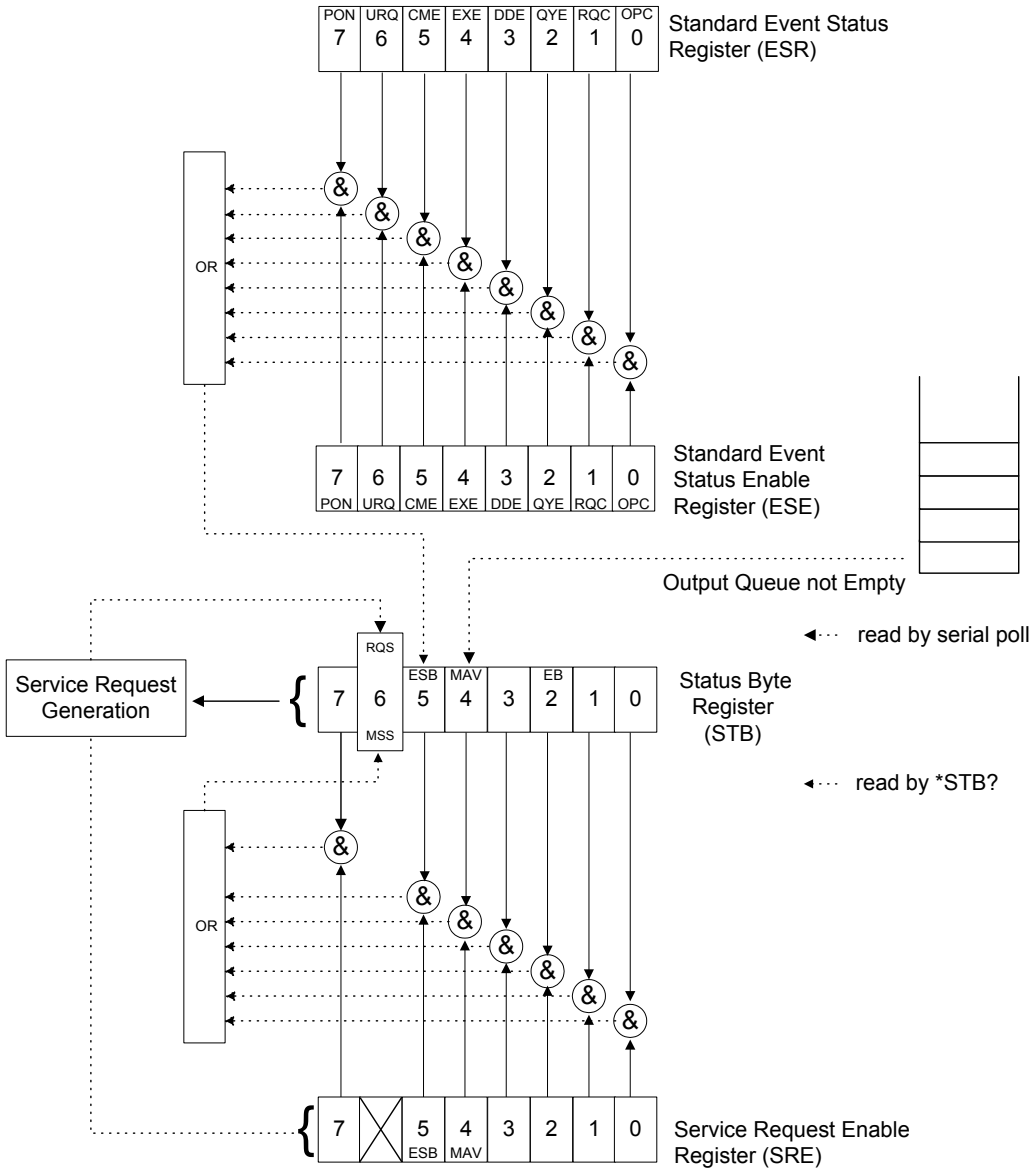

An SRQ is forced when a bit is set in the STB and at the same time the corresponding SRE bit is set. When the SRQ is generated, the RQS bit is set to 1 and remains set until read by a serial poll. Once the RQS is read, it returns to 0.

Command Structure

The GPIB and RS-232 commands follow the guidelines determined by the Standard Commands for Programmable Interface (SCPI) consortium. For example, the command syntax

```
OUTP[:STAT]<wsp><boolean>
```

is used to control the FVA-3150 shutter.

In this particular example:

- OUTP identifies that the command is a part of the OUTPut subset of commands;
- STAT is a keyword that defines the function of the command;
- [] indicates that a keyword or a parameter is optional;
- <wsp> indicates that a space is required and
- <boolean> is the command parameter.

All keywords must be UPPERCASE characters separated by a colon. A typical command would be

```
OUTP:STAT 1
```

This command instructs the Variable Attenuator to optically open the shutter.

Note: *It is recommended to retrieve the response immediately after each query.*

Error Messages

System and device-specific errors are managed by the FVA-3150 Variable Attenuator. The generic format for error messages is illustrated in the following figure.

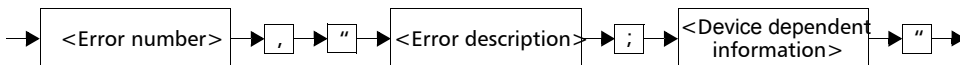

As shown in the above figure, the message contains three parts: the error number, error description, and device-dependent information. All error messages are stacked in a FIFO buffer. When there is at least one message in the buffer, bit 2 of the Status Byte Register is set to 1. Use the SYST:ERR?, ERR?, or LERR? command to read the most recent message. The error message buffer is initialized when starting the Variable Attenuator, when executing the *CLS command, or by reading the last message stored in the buffer.

SCPI Management Errors (System Errors)

Error Number	Description	Probable Cause
-100	“Command Error.”	An error occurred while validating a command.
-101	“Undefined Header.”	Unknown command.
-102	“Missing Parameter.”	A command parameter is missing.
-103	“Parameter Not Allowed.”	An extra parameter is present.
-104	“Data Type Error.”	Invalid parameter format.
-200	“Execution Error.”	An error occurred while executing a command.
-300	“Device Dependent Error.”	A command has taken longer than expected to complete execution.
-300	“Invalid Attenuation.”	A command has attempted to set the internal attenuation to an invalid value.
-300	“Invalid Offset.”	The reference value parameter entered is out of range.
-300	“Program Running.”	A command that will halt the currently running program has been received, or an attempt has been made to override a program setting.
-300	“Invalid Wavelength.”	The entered wavelength parameter is out of range.
-300	“Invalid Delay Time.”	The entered delay parameter is out of range.
-300	“Invalid Duration Time.”	The entered duration time parameter is out of range.

Controlling Your Variable Attenuator Remotely

RS-232 Connector Pinout

Error Number	Description	Probable Cause
-300	"Invalid Program Step."	The entered program step parameter is out of range.
-300	"Invalid Program Attenuation."	The entered program attenuation parameter is out of range.
-300	"Invalid CAL Factor."	The entered calibration factor parameter is out of range.
-400	"Query Error."	An error occurred while accessing the output queue.
-500	"System Error."	System is out of memory.

RS-232 Connector Pinout

The RS-232 connector (serial port) at the back of the Variable Attenuator uses a DTE pinout configuration.

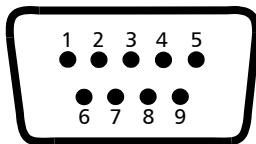

Pin	Description	Direction
2	Receive (Rx)	Input
3	Transmit (Tx)	Output
5	Signal ground (Gnd)	—

7 **Maintenance**

To help ensure long, trouble-free operation:

- Always inspect fiber-optic connectors before using them and clean them if necessary.
- Keep the unit free of dust.
- Clean the unit casing and front panel with a cloth slightly dampened with water.
- Store unit at room temperature in a clean and dry area. Keep the unit out of direct sunlight.
- Avoid high humidity or significant temperature fluctuations.
- Avoid unnecessary shocks and vibrations.
- If any liquids are spilled on or into the unit, turn off the power immediately, disconnect from any external power source, remove the batteries and let the unit dry completely.



WARNING

Use of controls, adjustments, and procedures for operation and maintenance other than those specified herein may result in hazardous radiation exposure.

Cleaning EUI Connectors

Regular cleaning of EUI connectors will help maintain optimum performance. There is no need to disassemble the unit.



IMPORTANT

If any damage occurs to internal connectors, the module casing will have to be opened and a new calibration will be required.

To clean EUI connectors:

1. Remove the EUI from the instrument to expose the connector baseplate and ferrule.

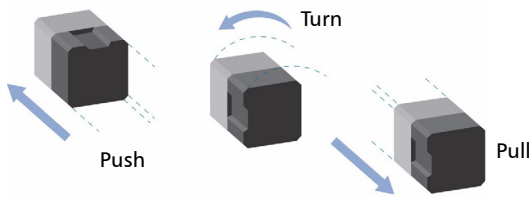

2. Moisten a 2.5 mm cleaning tip with *one drop* of isopropyl alcohol (alcohol may leave traces if used abundantly).
3. Slowly insert the cleaning tip into the EUI adapter until it comes out on the other side (a slow clockwise rotating movement may help).

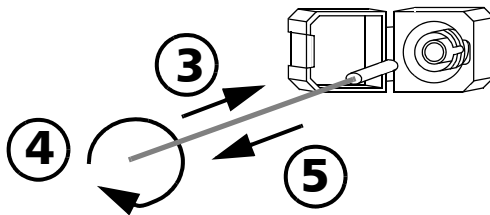

4. Gently turn the cleaning tip one full turn, then continue to turn as you withdraw it.

5. Repeat steps 3 to 4 with a dry cleaning tip.

Note: *Make sure you don't touch the soft end of the cleaning tip.*

6. Clean the ferrule in the connector port as follows:

6a. Deposit *one drop* of isopropyl alcohol on a lint-free wiping cloth.



IMPORTANT

Isopropyl alcohol may leave residues if used abundantly or left to evaporate (about 10 seconds).

Avoid contact between the tip of the bottle and the wiping cloth, and dry the surface quickly.

- 6b.** Gently wipe the connector and ferrule.
- 6c.** With a dry lint-free wiping cloth, gently wipe the same surfaces to ensure that the connector and ferrule are perfectly dry.
- 6d.** Verify connector surface with a portable fiber-optic microscope (for example, EXFO's FOMS) or fiber inspection probe (for example, EXFO's FIP).



WARNING

Verifying the surface of the connector **WHILE THE UNIT IS ACTIVE** WILL result in permanent eye damage.

7. Put the EUI back onto the instrument (push and turn clockwise).
8. Throw out cleaning tips and wiping cloths after one use.

Cleaning Detector Ports

Regular cleaning of detectors will help maintain measurement accuracy.



IMPORTANT

Always cover detectors with protective caps when unit is not in use.

To clean detector ports:

1. Remove the protective cap and adapter (FOA) from the detector.
2. If the detector is dusty, blow dry with compressed air.
3. Being careful not to touch the soft end of the swab, moisten a cleaning tip with *only one drop* of isopropyl alcohol.



IMPORTANT

Alcohol may leave traces if used abundantly. Do not use bottles that distribute too much alcohol at a time.

4. While applying light pressure (to avoid breaking the detector window), gently rotate the cleaning tip on the detector window.
5. Repeat step 4 with a dry cleaning tip or blow dry with compressed air.
6. Discard the cleaning tips after one use.

Recalibrating the Unit

Manufacturing and service center calibrations are based on the ISO/IEC 17025 Standard, which states that calibration documents must not contain a recommended calibration interval, unless this has been previously agreed upon with the customer.

Validity of specifications depends on operating conditions. For example, the calibration validity period can be longer or shorter depending on the intensity of use, environmental conditions and unit maintenance. You should determine the adequate calibration interval for your unit according to your accuracy requirements.

Under normal use, EXFO recommends calibrating your unit every year.

Maintenance

Recycling and Disposal (Applies to European Union Only)

Recycling and Disposal (Applies to European Union Only)



Recycle or dispose of your product (including electric and electronic accessories) properly, in accordance with local regulations. Do not dispose of it in ordinary garbage receptacles.

This equipment was sold after August 13, 2005 (as identified by the black rectangle).

- Unless otherwise noted in a separate agreement between EXFO and a customer, distributor, or commercial partner, EXFO will cover costs related to the collection, treatment, recovery, and disposal of end-of-lifecycle waste generated by electronic equipment introduced after August 13, 2005 to an European Union member state with legislation regarding Directive 2002/96/EC.
- Except for reasons of safety or environmental benefit, equipment manufactured by EXFO, under its brand name, is generally designed to facilitate dismantling and reclamation.

For complete recycling/disposal procedures and contact information, visit the EXFO Web site at www.exfo.com/recycle.

8 Troubleshooting

Contacting the Technical Support Group

To obtain after-sales service or technical support for this product, contact EXFO at one of the following numbers. The Technical Support Group is available to take your calls from Monday to Friday, 8:00 a.m. to 7:00 p.m. (Eastern Time in North America).

For detailed information about technical support, visit the EXFO Web site at www.exfo.com.

Technical Support Group

400 Godin Avenue
Quebec (Quebec) G1M 2K2
CANADA

1 866 683-0155 (USA and Canada)
Tel.: 1 418 683-5498
Fax: 1 418 683-9224
support@exfo.com

To accelerate the process, please have information such as the name and the serial number (see the product identification label—an example is shown below), as well as a description of your problem, close at hand.

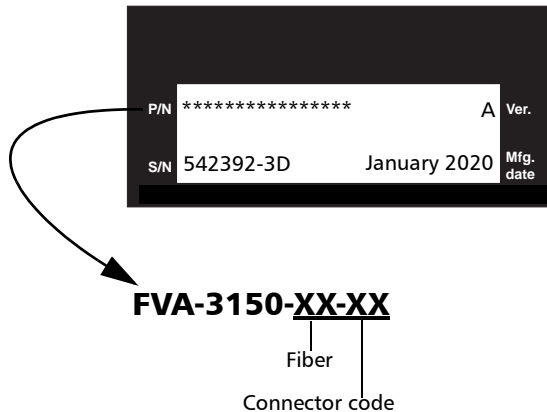

Transportation

Maintain a temperature range within specifications when transporting the unit. Transportation damage can occur from improper handling. The following steps are recommended to minimize the possibility of damage:

- Pack the unit in its original packing material when shipping.
- Avoid high humidity or large temperature fluctuations.
- Keep the unit out of direct sunlight.
- Avoid unnecessary shocks and vibrations.

9 **Warranty**

General Information

EXFO Inc. (EXFO) warrants this equipment against defects in material and workmanship for a period of two years from the date of original shipment. EXFO also warrants that this equipment will meet applicable specifications under normal use.

During the warranty period, EXFO will, at its discretion, repair, replace, or issue credit for any defective product, as well as verify and adjust the product free of charge should the equipment need to be repaired or if the original calibration is erroneous. If the equipment is sent back for verification of calibration during the warranty period and found to meet all published specifications, EXFO will charge standard calibration fees.



IMPORTANT

The warranty can become null and void if:

- **unit has been tampered with, repaired, or worked upon by unauthorized individuals or non-EXFO personnel.**
- **warranty sticker has been removed.**
- **case screws, other than those specified in this guide, have been removed.**
- **case has been opened, other than as explained in this guide.**
- **unit serial number has been altered, erased, or removed.**
- **unit has been misused, neglected, or damaged by accident.**

THIS WARRANTY IS IN LIEU OF ALL OTHER WARRANTIES EXPRESSED, IMPLIED, OR STATUTORY, INCLUDING, BUT NOT LIMITED TO, THE IMPLIED WARRANTIES OF MERCHANTABILITY AND FITNESS FOR A PARTICULAR PURPOSE. IN NO EVENT SHALL EXFO BE LIABLE FOR SPECIAL, INCIDENTAL, OR CONSEQUENTIAL DAMAGES.

Warranty

Liability

Liability

EXFO shall not be liable for damages resulting from the use of the product, nor shall be responsible for any failure in the performance of other items to which the product is connected or the operation of any system of which the product may be a part.

EXFO shall not be liable for damages resulting from improper usage or unauthorized modification of the product, its accompanying accessories and software.

Exclusions

EXFO reserves the right to make changes in the design or construction of any of its products at any time without incurring obligation to make any changes whatsoever on units purchased. Accessories, including but not limited to fuses, pilot lamps, batteries and universal interfaces (EUI) used with EXFO products are not covered by this warranty.

This warranty excludes failure resulting from: improper use or installation, normal wear and tear, accident, abuse, neglect, fire, water, lightning or other acts of nature, causes external to the product or other factors beyond the control of EXFO.



IMPORTANT

EXFO will charge a fee for replacing optical connectors that were damaged due to misuse or bad cleaning.

Certification

EXFO certifies that this equipment met its published specifications at the time of shipment from the factory.

Service and Repairs

EXFO commits to providing product service and repair for five years following the date of purchase.

To send any equipment for service or repair:

1. Call one of EXFO's authorized service centers (see *EXFO Service Centers Worldwide* on page 67). Support personnel will determine if the equipment requires service, repair, or calibration.
2. If equipment must be returned to EXFO or an authorized service center, support personnel will issue a Return Merchandise Authorization (RMA) number and provide an address for return.
3. If possible, back up your data before sending the unit for repair.
4. Pack the equipment in its original shipping material. Be sure to include a statement or report fully detailing the defect and the conditions under which it was observed.
5. Return the equipment, prepaid, to the address given to you by support personnel. Be sure to write the RMA number on the shipping slip. *EXFO will refuse and return any package that does not bear an RMA number.*

Note: *A test setup fee will apply to any returned unit that, after test, is found to meet the applicable specifications.*

After repair, the equipment will be returned with a repair report. If the equipment is not under warranty, you will be invoiced for the cost appearing on this report. EXFO will pay return-to-customer shipping costs for equipment under warranty. Shipping insurance is at your expense.

Routine recalibration is not included in any of the warranty plans. Since calibrations/verifications are not covered by the basic or extended warranties, you may elect to purchase FlexCare Calibration/Verification Packages for a definite period of time. Contact an authorized service center (see *EXFO Service Centers Worldwide* on page 67).

EXFO Service Centers Worldwide

If your product requires servicing, contact your nearest authorized service center.

EXFO Headquarters Service Center

400 Godin Avenue
Quebec (Quebec) G1M 2K2
CANADA

1 866 683-0155 (USA and Canada)
Tel.: 1 418 683-5498
Fax: 1 418 683-9224
quebec.service@exfo.com

EXFO Europe Service Center

Omega Enterprise Park, Electron Way
Chandlers Ford, Hampshire S053 4SE
ENGLAND

Tel.: +44 2380 246810
Fax: +44 2380 246801
europe.service@exfo.com

EXFO Telecom Equipment (Shenzhen) Ltd.

3rd Floor, Building 10,
Yu Sheng Industrial Park (Gu Shu
Crossing), No. 467,
National Highway 107,
Xixiang, Bao An District,
Shenzhen, China, 518126

Tel: +86 (755) 2955 3100
Fax: +86 (755) 2955 3101
beijing.service@exfo.com

A Technical Specifications



IMPORTANT

The following technical specifications can change without notice. The information presented in this section is provided as a reference only. To obtain this product's most recent technical specifications, visit the EXFO Web site at www.exfo.com.

SPECIFICATIONS*

SINGLEMODE CONFIGURATIONS

Description	without monitor port	with monitor port
Models	FVA-3150-B	FVA-3150-BM
Fiber type (µm)	9/125	9/125
Wavelength range (nm)	1250 to 1650	1250 to 1650
Maximum attenuation (dB) ^b	≥65	≥65
Insertion loss ^{c,d}		
Typical (dB)	1.0	1.5
Maximum (dB)	1.5	2.2
Attenuation setting resolution, typical (dB)	±0.002	±0.002
Attenuation linearity (dB) ^e	±0.1	±0.1
Attenuation repeatability (dB), 2 σ ^f	±0.01	±0.01
Spectral uniformity, 1510 nm to 1605 nm (dB) ^g	±0.05	±0.05
Spectral uniformity, 1450 nm to 1630 nm, typical (dB) ^g	±0.09	±0.09
PDL, peak to peak (dB) ^h	0.15	0.2
Return loss, typical (dB) ^{c,i}	60	60
Maximum input power (dBm)	23	23
Settling time, including command processing time, typical (ms) ^j	90 (for 0.1 dB step)	90 (for 0.1 dB step)
Transition speed, typical (dB/s)	up to 23	up to 23
Shutter isolation (dB)	>100	>100
Monitor output, typical (dB) ^k	N/A	12.8

MULTIMODE CONFIGURATIONS

Description	without monitor port	with monitor port
Models	FVA-3150-C, D	FVA-3150-CM, DM
Fiber type (µm)	50/125, 62.5/125	50/125, 62.5/125
Wavelength range (nm)	700 to 1350	700 to 1350
Maximum attenuation (dB) ^b	≥65	≥65
Insertion loss ^{c,d}		
Typical (dB)	1.3	1.5
Maximum (dB)	2.0	3.0
Attenuation setting resolution, typical (dB)	±0.002	±0.002
Attenuation linearity (dB) ^e	±0.1	±0.1
Attenuation repeatability (dB) ^f	±0.01	±0.01
Return loss, typical (dB) ^{c,g}	40	40
Maximum input power (dBm)	20	20
Settling time, including command processing time, typical (ms) ^j	90 (for 0.1 dB step)	90 (for 0.1 dB step)
Transition speed, typical (dB/s)	up to 23	up to 23
Shutter isolation (dB)	>100	>100
Monitor output, typical (dB) ^k	NA	12.8

Notes

- Valid at 23 °C ± 1 °C.
- Valid at 1550 nm and below.
- Measured at 1310 nm and 1550 nm for singlemode units and at 850 nm for multimode units.
- Excluding connectors.
- Measured at 1310 nm and 1550 nm (up to 60 dB) for singlemode units and at 850 nm and 1300 nm (up to 50 dB) for multimode units, with non-polarized light.
- Up to 45 dB attenuation.
- For 20 dB attenuation relative to 0 dB attenuation.
- Up to 20 dB attenuation at 1550 nm.
- For FC/APC connectors.
- Includes time for command via GPIB, interpretation and attenuation settling; 185 ms for 1 dB step; 3 s for full range.
- Ratio between output port and monitor port, expressed in dB.

Technical Specifications

GENERAL SPECIFICATIONS

Size (H X W X D)	117 mm X 222 mm X 333 mm	(4 5/8 in X 8 3/4 in X 13 1/8 in)
Weight	2.6 kg	(5.8 lb)
Temperature	Operating	0 °C to 40 °C (32 °F to 122 °F)
	Storage	-40 °C to 70 °C (-40 °F to 158 °F)
Relative humidity	0 % to 80 % non-condensing	

Instrument Drivers

LabVIEW™ drivers and SCPI commands.

Remote Control

GPIO (IEEE-488.1, IEEE-488.2), RS-232.

Standard Accessories

User guide, Certificate of Compliance, Certificate of Calibration and AC power cord.

B *Remote Control Commands*

IEEE 488.2 Required Commands

The Variable Attenuator recognizes the main commands identified in IEEE-488.2. These commands are fully explained on the following pages.

Command	Function
*CLS	Clear status command
*ESE	Standard event status enable command
*ESE?	Standard event status enable query
*ESR?	Standard event status register query
*IDN?	Identification query
*OPC	Operation complete command
*OPC?	Operation complete query
*RST	Reset command
*SRE	Service request enable command
*SRE?	Service request enable query
*STB?	Read status byte query
*TRG	Trigger command
*TST?	Self-test query
*WAI	Wait to continue command

The commands are fully explained in the following pages.

Remote Control Commands

IEEE 488.2 Required Commands

*CLS

Description This command sets the contents of the Standard Event Register (ESR), the Status Byte Register (STB), and the Error Queue (ERR) to zero. This command is commonly used to clear the status registers before enabling SRQ. Note that the output queue, Standard Event Status Enable Register (ESE), and Service Request Enable Register (SRE) are not affected.

Syntax *CLS

Note The CLR command is equivalent to the *CLS command. Both give the same result.

*ESE

Description This command is used to set bits in the Standard Event Status Enable Register (ESE) to a new value (default value is 255). The contents of the ESE register are logically ANDed with the ESR register. A non zero result will set the Event Summary Bit (ESB) of the Status Byte Register. This command is useful for selecting which events may generate an SRQ.

Syntax *ESE<wsp> <value>

Parameter The <value> parameter must be between 0 and 255.

*ESE?

Description This query reads the contents of the Event Status Register.

Syntax *ESE?

Response Binary integer with a value between 0 and 255.

***ESR?**

Description This query reads the contents of the Standard Event Register.

Syntax *ESR?

Response Binary integer with a value between 0 and 255.

***IDN?**

Description This query reads the FVA-3150 identification string.

Syntax *IDN?

Response "EXFO FVA-3150-XX-XX x.x.x.x", where XX-XX is the current product model and x.x.x.x is the current product version.

Note The SYST:VERS? and IDN? commands are equivalent to the *IDN? command. They give the same result.

***OPC**

Description This command causes the FVA-3150 to generate the operation complete message in the Standard Event Status Register (ESR) when all pending selected FVA-3150 operations have been finished.

Syntax *OPC

Example *OPC,*IDN?

Remote Control Commands

IEEE 488.2 Required Commands

*OPC?

Description	This query puts an ASCII 1 in the output queue when the contents of the input queue has been processed.
Syntax	*OPC?
Response	"1"
Note	The OPC? command is equivalent to the *OPC? command. Both give the same result.

*RST

Description	<p>This command empties the step response list. It is only seen when it is part of another multiple command. In the example below, by adding this command after *IDN?, you will not be able to access the answer. The *RST, in this instance, erases the identification string. In addition, this command performs the following operations:</p> <ul style="list-style-type: none">➤ Returns to initial state before command is sent, and not necessarily to previous settings.➤ Forces the device to enter into an Operation Complete Command Idle State (OCIS).➤ Forces the device to enter into an Operation Complete Query Active State (OQIS).➤ Initializes previous responses unless there has been a program message terminator preceded by an *RST.
Syntax	*RST
Example	*IDN?,*RST<NL>

***SRE**

Description This command sets bits in the Service Request Enable Register (default value is 255) and enables the corresponding bit in the Status Register. The command can be used to select which events can initiate a service request.

Syntax *SRE<wsp> <value>

Parameter The <value> parameter must be between 0 and 255.

***SRE?**

Description This query returns the contents of the Service Request Enable Register.

Syntax *SRE?

Response Binary integer between 0 and 255.

***STB?**

Description This query returns the contents of the Status Byte Register.

Syntax *STB?

Response A binary integer between 0 and 255.

Note The STB? command is equivalent to the *STB? command. Both give the same result.

Remote Control Commands

IEEE 488.2 Required Commands

*TRG

Description This command will trigger any event that was suspended and is waiting for a trigger.

Syntax *TRG

Parameters None

Note This command has no effect on the FVA-3150.

*TST?

Description This query initiates an internal self-test and returns a binary value indicating the results of the test.

Syntax *TST?

Response A binary value
“0” if the test is completed without error
“1” if the test is completed with errors

*WAI

Description This command prevents the FVA-3150 from processing any further commands until the No-Operation-Pending Flag is set. All pending operations must be complete before processing another command.

Syntax *WAI

Parameters None

Note This command has no effect on the FVA-3150.

The FVA-3150 Variable Attenuator also recognizes commands that can only be used with RS-232 communication. These commands are summarized below.

Command	Function
*LOK	Set Remote Lockout programming state
*LOK?	Remote Lockout programming state query

*LOK

Description This command is used to lock and unlock the FVA-3150 keypad. Once the FVA-3150 keypad is locked, no external input can interfere with the GPIB communication. The only way to unlock the keypad is to use the *LOK command again or turn off the unit.

Syntax *LOK <wsp> <data>

Parameters The <data> parameter can be “1” to lock the keypad or “0” to unlock the keypad.

Example *LOK 1

Note When the keypad is locked, the unit will beep twice if any key is pressed on the keypad. The *Remote* indicator appears in the lower left corner of the display while the unit is being controlled remotely.

This command can only be used when working with RS-232 communication.

Remote Control Commands

IEEE 488.2 Required Commands

***LOK?**

Description This query reads the FVA-3150 keypad lock state.

Syntax *LOK?

Response “1” if the FVA-3150 keypad is locked
“0” if the FVA-3150 keypad is unlocked

Example *LOK?

Note This command can only be used when working with RS-232 communication.

Specific commands-Quick Reference Command Tree

Command	Parameter/ Response	Description
ATT ^a , b	< ±99.999 [DB] MIN MAX >	set attenuation
ATT?	(± 99.999)	obtain attenuation
CAL ^a , b	< ±99.999 >	set offset
CAL?	(± 99.999)	obtain offset
D ^b	<0 1>	activate shutter
D?	(0 1)	obtain shutter state
DISP DIMM	<LO HI OFF >	adjust display intensity
DIMM?	<LO HI OFF >	obtain display intensity
Fiber ^a , b	<1 2>	set fiber type
Fiber?	(1 2)	obtain fiber type
INP ATT ^a	< ±99.999 [DB] MIN MAX >	set attenuation
ATT?	(± 99.999)	obtain attenuation
OFFS ^a	< ±99.999 [DB] >	set a reference value
DISP		set ref. to display
OFFS?	(±99.999)	read reference value
STEP	0.01 <step<50	set step
CATA?	list of available steps	obtain step list

Remote Control Commands

Specific commands-Quick Reference Command Tree

Command	Parameter/ Response	Description
STEP?	0.01 <step> <50	obtain current step
WAVE a	<9999.9 [NM]>	set wavelength
WAVE ?	(9999.9)	obtain wavelength
OUTP APM	<OFF ON 0 1>	set Absolute or Reference
APM?	(0 1)	is it in Absolute mode?
[STAT]	<OFF ON 0 1>	activate shutter
[STAT] ?	(0 1)	obtain shutter state
PROG SEL ATT	±99.999	set atten. parameter
DELA	<999,59,59	set delay parameter
DURA	<999,59,59	set duration parameter
STAT	<0 1 START STOP>	control the program
STAT?	(0 1)	obtain program state
STEP	<100	set step parameter
WVL ^a , b	<9999.9 [NM]>	set wavelength
WVL?	(9999.9)	obtain wavelength

- a. Valid parameters are determined by the type of module.
b. This command is GPIB-compatible.

ATTenuation

Description This command sets the attenuation to a specific value. The valid range of values depends on the configuration of the FVA-3150 and on the current wavelength. The difference with the current attenuation must be of at least 0.002 dB for the new attenuation step size to be valid.

Syntax ATT <wsp> <value> [<wsp>DB]

Remote Control Commands

Specific commands-Quick Reference Command Tree

- Parameters** The <value> parameter can be
- “MIN” (to set the FVA-3150 to the minimum setting for the current wavelength)
 - “MAX” (to set the FVA-3150 to the maximum setting for the current wavelength)
 - a valid attenuation value followed by the units [DB]. Note that, depending on the current measurement mode, the <value> parameter takes different values.

In Absolute mode:

$$\text{value} = \text{actual attenuation}$$

In Reference mode:

$$\text{value} = \text{actual attenuation} - \text{reference value (INP:OFFS?)}$$

In Offset mode:

$$\text{value} = \text{actual attenuation} + \text{wavelength-specific offset}$$

Therefore, when in Reference or Offset mode, the range of the accepted values for the <value> parameter will change according to the current reference or offset value.

Example ATT -15.350 DB

Note This command cannot be issued while a program is running. The ATT command is equivalent to the INP:ATT command. Both give the same result.

ATTenuation?

Description This query returns a value corresponding to the CAL parameter value added to either the current attenuation setting, the minimum attenuation, or the maximum attenuation setting.

Syntax ATT? [<wsp> <value>]

Parameters The <value> parameter is optional and can be “MIN” to obtain the minimum setting for the current wavelength “MAX” to obtain the maximum setting for the current wavelength

Response The attenuation value in the format “99.999”. The units are dB. Note that, depending on the current measurement mode, the response will include different parameters:

In Absolute mode:

$$\text{response} = \text{actual attenuator} + \text{general offset (CAL?)}$$

In Reference mode:

$$\text{response} = \frac{\text{actual}}{\text{attenuation}} - \frac{\text{reference value}}{(\text{INP:OFFS?})} + \frac{\text{general offset}}{(\text{CAL?})}$$

In Offset mode:

$$\text{response} = \frac{\text{actual}}{\text{attenuation}} + \frac{\text{wavelength-specific}}{\text{offset}} + \text{general offset}$$

Example ATT? MIN

Note The ATT? command is not equivalent to the INP:ATT? command.

Remote Control Commands

Specific commands-Quick Reference Command Tree

CAL

Description	This command stores an offset value that will be applied to all wavelengths in Absolute, Reference, and Offset modes. This offset value will be included in the measurement returned by ATT? but will not be taken into account on the FVA-3150 display. This offset value is deleted when the FVA-3150 is turned off.
Syntax	CAL<wsp><value>[<wsp><DB>]
Parameters	The <value> parameter must be a valid attenuation value in the format “±99.999”. The units (DB) are optional.
Example	CAL 99.999 DB

CAL?

Description	This query returns the offset value that is applied to all wavelengths in Absolute, Reference, and Offset modes.
Syntax	CAL?
Response	The offset value that is applied to all wavelengths in Absolute, Reference, and Offset modes in the format “±99.999”. The units are dB.
Note	This offset value is included in the measurement returned by ATT? but is not taken into account on the FVA-3150 display.
Example	CAL?

D

Description	This command controls the shutter, which can block optical continuity.
Syntax	D<wsp><numeric>
Parameters	The <numeric> parameter can be “0” to disable the shutter “1” to enable the shutter
Example	D 1
Note	This command cannot be issued while a program is running.

D?

Description	This query returns the current shutter state.
Syntax	D?
Response	The shutter state in the format “0” if the shutter is optically disabled “1” if the shutter is optically enabled
Example	D?

Remote Control Commands

Specific commands-Quick Reference Command Tree

DISPlay:DIMMer

Description	This command is used to adjust the intensity of the FVA-3150 display (high or low) or to turn off the display without turning off the unit.
Syntax	DISP:DIMM<wsp> <data>
Parameters	The <data> parameter can be “HI”, “LO”, or “OFF”.
Example	DISP:DIMM OFF
Note	When the display is turned off by this command, any key pressed on the FVA-3150 keypad will return the display to high intensity. To prevent this, lock the FVA-3150 keypad with the *LOK command.
See also	DISP:DIMM?, *LOK, and *LOK?

DISPlay:DIMMer?

Description	This query returns the intensity of the FVA-3150 display (high, low, or off).
Syntax	DISP:DIMM?
Response	“HI” if the intensity is high “LO” if the intensity is low “OFF” if the display is off
Example	DISP:DIMM?

Fiber

Description	This command specifies the type of fiber tested (singlemode or multimode).
Syntax	F<wsp><numeric>
Parameters	The <numeric> parameter can be “1” to specify singlemode fiber “2” to specify multimode fiber
Example	F 1
Note	This command has no effect on the FVA-3150. The FVA-3150 is designed to test either singlemode or multimode fiber but not both.

Fiber?

Description	This query returns the type of fiber (singlemode or multimode) that the FVA-3150 was designed to test (no matter what fiber type was entered with the F function).
Syntax	F?
Response	The appropriate fiber type in the format “1” for singlemode fiber (FVA-3150-B) “2” for multimode fiber (FVA-3150-C and FVA-3150-D)
Example	F?

Remote Control Commands

Specific commands-Quick Reference Command Tree

INPut:ATTenuation

Description This command sets the attenuation to a specific value. The valid range of values depends on the configuration of the FVA-3150 and on the current wavelength. The difference with the current attenuation must be of at least 0.002 dB for the new attenuation step size to be valid.

Syntax INP:ATT <wsp> <value> [<wsp>DB]

- Parameters** The <value> parameter can be
- “MIN” (to set the FVA-3150 to the minimum setting for the current wavelength)
 - “MAX” (to set the FVA-3150 to the maximum setting for the current wavelength)
 - a valid attenuation value followed by the units [DB]. Note that, depending on the current measurement mode, the <value> parameter takes different values.

In Absolute mode:

$$\text{value} = \text{actual attenuation}$$

In Reference mode:

$$\text{value} = \frac{\text{actual}}{\text{attenuation}} - \text{reference value(INP:OFFS?)}$$

In Offset mode:

$$\text{value} = \text{actual attenuation} + \text{wavelength-specific offset}$$

Therefore, when in Reference or Offset mode, the range of the accepted values for the <value> parameter will change according to the current reference or offset value.

Example INP:ATT -15.350 DB

Note This command cannot be issued while a program is running. The ATT command is equivalent to the INP:ATT command. Both give the same result.

Remote Control Commands

Specific commands-Quick Reference Command Tree

INPut:ATTenuation?

Description	This query returns a value indicating the current attenuation setting OR the minimum/maximum attenuation setting.
Syntax	INP:ATT? [<wsp> <value>]
Parameters	The <value> parameter is optional and can be “MIN” to obtain the minimum setting for the current wavelength “MAX” to obtain the maximum setting for the current wavelength
Response	The attenuation value in the format “999.99”. The units are dB. Note that, depending on the current measurement mode, the response will include different parameters: In Absolute mode: $\text{response} = \text{actual attenuation}$ In Reference mode: $\text{response} = \text{actual attenuation} - \text{reference value}(\text{INP:OFFS?})$ In Offset mode: $\text{response} = \text{actual attenuation} + \text{wavelength-specific offset}$
Example	INP:ATT? MIN or INP:ATT?

INPut:OFFSet

Description	This command stores a reference value for the current wavelength and sets the FVA-3150 to Reference mode. In Reference mode, the displayed attenuation is relative to this reference value. A different reference value must be stored for every wavelength. The reference values remain in memory until they are overwritten.
Syntax	INP:OFFS <wsp> <value> [<wsp>DB]
Parameters	The <value> parameter must be a valid attenuation value followed by the (optional) units (dB).
Example	INP:OFFS 99.99 DB
Note	This command cannot be issued while a program is running.

INPut:OFFSet:DISPlay

Description	This command sets the reference value (for the current wavelength) to the current absolute attenuation setting and sets the FVA-3150 to Reference mode. In Reference mode, the displayed attenuation is relative to the reference. A different reference value must be stored for every wavelength. The reference values remain in memory until they are overwritten.
Syntax	INP:OFFS:DISP
Parameters	N/A
Example	INP:OFFS:DISP
Note	This command cannot be issued while a program is running.

Remote Control Commands

Specific commands-Quick Reference Command Tree

INPut:OFFSet?

Description	This query returns the current reference value for the current wavelength.
Syntax	INP:OFFS?
Response	The current reference in the format “99.999”. The units are dB.
Example	INP:OFFS?

INPut:STEP

Description	This command is used to set the size of the step between two attenuation settings. Use the INP:STEP:CATA? query to obtain the list of available step sizes. If the requested step is not available, the FVA-3150 is set to the next available step. If the requested step is greater than the maximum available step, the FVA-3150 is set to the maximum available step.
Syntax	INP:STEP<wsp><step>[<wsp>dB]
Parameters	The <step> parameter is the requested step size. The unit of measurement (dB) is optional.
Example	INP:STEP 0.1
Note	This command cannot be issued while a program is running.

INPut:STEP?

Description	This command is used to obtain the current step size between two attenuation settings.
Syntax	INP:STEP?
Response	The current step size in the format “0.02”.
Example	INP:STEP?

INPut:STEP:CATAlog?

Description	This query returns the list of available step sizes between two attenuation settings. Use this command to determine the maximum resolution of the attenuation or reflection setting.
Syntax	INP:STEP:CATA?
Response	The list of available steps. The steps are divided by “;” and the units are dB. For example: 0.01;0.02;0.05;0.1;0.2;0.5;1;2;5;10;20;50
Example	INP:STEP:CATA?

Remote Control Commands

Specific commands-Quick Reference Command Tree

INPut:WAVElength

Description	This command selects a specific calibrated wavelength. The wavelength range depends on the type and configuration of the FVA-3150.
Syntax	INP:WAVE<wsp> <numeric_value> [<wsp> <NM>]
Parameters	The <numeric_value> parameter is the actual wavelength in the format “9999.9 NM”. The units are optional.
Example	INP:WAVE 1310 NM
Note	This command cannot be issued while a program is running. The INP:WAVE command is equivalent to the WVL command. Both give the same result.

INPut:WAVElength?

Description	This query returns a value indicating the currently selected wavelength, the minimum available wavelength, or the maximum available wavelength.
Syntax	INP:WAVE? [<wsp> <min_or_max>]
Parameters	The <min_or_max> parameter is optional and can be “MIN” to request the minimum wavelength “MAX” to request the maximum wavelength
Response	The wavelength in the format “9999.9”. The units are nm.
Example	INP:WAVE? MAX or INP:WAVE?
Note	The INP:WAVE? command is equivalent to the WVL? command. Both give the same result.

OUTPut:APMode

Description	This command selects Absolute or Reference attenuation mode. When Absolute mode is selected, the Absolute attenuation introduced by the FVA-3150 is displayed. When Reference mode is selected, the current absolute attenuation is set as the reference value, and then the displayed attenuation is relative to the reference.
Syntax	OUTP:APM<wsp> <boolean>
Parameters	The <boolean> parameter can be “0” or “OFF” to select Reference display mode “1” or “ON” to select Absolute display mode
Example	OUTP:APM ON
Note	This command cannot be issued while a program is running.

OUTPut:APMode?

Description	This query returns a value indicating whether or not Absolute display mode is selected.
Syntax	OUTP:APM?
Response	“0” if the unit is in Reference display mode “1” if the unit is in Absolute display mode
Example	OUTP:APM?

Remote Control Commands

Specific commands-Quick Reference Command Tree

OUTPut[:STATe]

Description	This command controls the shutter, which can block optical continuity.
Syntax	OUTP[:STAT] <wsp> <boolean>
Parameters	The <boolean> parameter can be “0” or “OFF” to optically enable the shutter “1” or “ON” to optically disable the shutter
Example	OUTP:STAT ON
Note	This command cannot be issued while a program is running.

OUTPut[:STATe]?

Description	This query returns the state of the shutter.
Syntax	OUTP[:STAT]?
Response	“0” if the shutter is optically enabled “1” if the shutter is optically disabled
Example	OUTP:STAT?

PROG:SEL:ATTenuation

Description	This command changes the attenuation parameter for the attenuation program.
Syntax	PROG:SEL:ATT<wsp><attenuation>[<wsp><DB>]
Parameters	The <attenuation> parameter is the difference in attenuation between each step in the program (maximum 99.999 dB). The units are optional.
Example	PROG:SEL:ATT 3
Note	This command cannot be issued while a program is running.

PROG:SEL:DELAy

Description	This command changes the delay parameter for the attenuation program.
Syntax	PROG:SEL:DELA<wsp><delay>
Parameters	The <delay> parameter is the delay preceding the program start. This value has the following format: “999,59,59” (hours,minutes,seconds).
Example	PROG:SEL:DELA 000,05,30
Note	This command cannot be issued while a program is running.

Remote Control Commands

Specific commands-Quick Reference Command Tree

PROG:SEL:SELEcted:DURAtion

Description	This command changes the duration parameter for the attenuation program.
Syntax	PROG:SEL:DURA<wsp><duration>
Parameters	The <duration> parameter is the time that the FVA-3150 remains at each attenuation step. This value has the following format: “999,59,59” (hours,minutes,seconds).
Example	PROG:SEL:DURA 000,10,00
Note	This command cannot be issued while a program is running.

PROG:SEL:SELEcted:STATe

Description	This command controls the status of the currently loaded program.
Syntax	PROG:SEL:STAT<wsp><value>
Parameters	The <value> parameter can be “1” or “START” to start the program “0” or “STOP” to stop the program
Example	PROG:SEL:STAT START

PROG:SEL:STAT?

Description	This query returns a value indicating the status of the loaded program.
Syntax	PROG:SEL:STAT?
Response	“0”: the program is stopped “1”: the program is in progress
Example	PROG:SEL:STAT?

PROG:SEL:STEP

Description	This command changes the number of steps parameter for the attenuation program.
Syntax	PROG:SEL:STEP <wsp> <step>
Parameters	The <step> parameter is the number of attenuation steps in the program (maximum 99 steps). Entering a value above 99 sets the number of steps parameter to 99.
Example	PROG:SEL:STEP 50
Note	This command cannot be issued while a program is running.

Remote Control Commands

Specific commands-Quick Reference Command Tree

WaVeLength

Description	This command selects a specific calibrated wavelength. The wavelength range depends on the type and configuration of the FVA-3150.
Syntax	WVL<wsp><numeric>[<wsp><NM>]
Parameters	The <numeric> parameter is the actual wavelength in the format “9999.9[NM]”. The units are optional.
Example	WVL 1310 NM
Note	This command cannot be issued while a program is running. The WVL command is equivalent to the INP:WAVE command. Both give the same result.

WaVeLength?

Description	This query returns a value indicating the currently selected wavelength, the minimum available wavelength, or the maximum available wavelength.
Syntax	WVL?[<wsp><min_or_max>]
Parameters	The <min_or_max> parameter is optional and can be “MIN” to request the minimum wavelength “MAX” to request the maximum wavelength
Response	The wavelength in the format “9999.9”. The units are nm.
Example	WVL? MAX or WVL?
Note	The WVL? command is equivalent to the INP:WAVE? command. Both give the same result.

SYSTem:ERRor?

Description	This command returns the next error on the list. The commands ERR? and LERR? give the same result. When an error is generated, an error number is sent to the error list. The error list can be accessed with the commands SYST:ERR?, ERR?, or LERR?.
Syntax	SYST:ERR?
Response	See error list and descriptions in <i>Error Messages</i> on page 52.

SYSTem:VERSion?

Description	This command returns the FVA-3150 identification string.
Syntax	SYST:VERS?
Response	“EXFO FVA-3150-XX-XX x.x.x.x” where XX-XX is the current product model and x.x.x.x is the current product version.
Note	The *IDN? and IDN? commands are equivalent to the SYST:VERS? command. They give the same result.

Index

A	
AC requirements	10
after-sales service	61
arrow buttons	2
attenuation	
display modes	24
entering a specific value	21
method of measurement	5
range	21
setting	20
setting maximum value	23
setting minimum value	22
attenuation display mode	
absolute	26
offset	28
reference	30
attenuation routine	
description	38
example	38
maximum delay	38
maximum duration	38
maximum number of steps	38
starting	42
stopping	43
available step sizes	20
B	
B value. see base offset value, setting	
back panel description	3
benchtop, installing in a rackmount	12
blocking light transmission	44
blocks	44
C	
calibration	
certificate	59
interval	59
Canadian Standards Association (CSA)	v
capacitors	9
caution	14
of personal hazard	6
of product hazard	6
certification information	v
cleaning	
detector ports	58
EUI connectors	56
fiber ends	35
front panel	55
comm. parameters for remote control	48
configuration	
description	31
for remote control	48
parameters saved	31
saving	31
connectors, cleaning	56
conventions, safety	6
correction factor, wavelength. see base offset value	
covers, unit	9
CSA	v
current, electrical	10
customer service	66
D	
delay before an attenuation routine	38
detector port, cleaning	58
diagram of the menus	14
dimmer, options	15
disconnecting FVA-3150	13
disconnecting unit	8
display	
intensity	15
OFF	15
display intensity, setting	15

Index

DTE pinout configuration 54
duration of the attenuation routine 38

E

entering
 a different step size 20
 an offset value 27
EOI (End or Identify) 48
EOS (End of String) 48
equipment returns 66
error messages in remote control 52
EUI
 baseplate 37
 connector adapter 37
 dust cap 37
EUI connectors, cleaning 56
EXFO universal interface. *see* EUI

F

fiber ends, cleaning 35
front panel description 2
front panel, cleaning 55
fuse
 replacement 9
FVA-3150, main features 1

G

GPIB
 communication parameters 48
 compatibility with the IQ Series 45

I

identification label 61
indoor use 9
inlets 8
input current 10
input port 2
installing
 rackmount 11
 unit 9

intensity of the display 15
IQ Series 45

K

keypad
 lockout 16
 to lock 16
 to unlock 16

L

label, identification 61
locking, control keys 16

M

maintenance
 detector ports 58
 EUI connectors 56
 front panel 55
 general information 55
maximum input current 10
meaning of the attenuation value 5
menu diagram 14
method of measurement of attenuation 5
mounting EUI connector adapter 37

N

non-volatile memory 13
number of steps in a programmed routine.. 38

O

offset value, defining 27
optical ports 2
output port 2

P		S	
pinout configuration	54	safety	
port		caution.....	6
input.....	2	conventions	6
output	2	power cable	8
power		warning	6
cable.....	8	saving a configuration.....	31
on/off	13	self-test.....	13
plug	8	serial port	54
power source, AC.....	10	service and repairs	66
product		service centers	67
identification label.....	61	setting	
specifications	69	display intensity	15
Program		the attenuation	20
button	14	the FVA-3150 for remote control	45
flashing on the display.....	14	the wavelength	17
menu	14	Setup	
programming an attenuation routine		button.....	14
duration.....	40	menu	14
<i>see also</i> attenuation routine		shipping to EXFO.....	66
protective cap	58	shortlist of wavelengths	
Q		adding wavelengths.....	18
quick reference RS-232.....	77	deleting all wavelengths	19
R		deleting wavelengths.....	19
rackmount, installing	11	description	17
read-only memory	13	shutter	
recalibration	59	operation	44
reference value.....	29	warning	44
remote control		specifications, product	69
address setting	45	step size	
command structure	51	available values	20
communication parameters.....	48	changing.....	20
description of commands	51–99	steps in a programmed routine	38
error messages	52	stopping, the signal.....	44
quick reference command tree	79	storage requirements	55
repairing unit	9	switching the wavelength	17
return merchandise authorization (RMA)	66	symbols, safety.....	6
RS-232, connector pinout configuration	54		

Index

T

technical specifications	69
technical support	61
temperature for storage.....	55
transportation requirements	55, 62
turning FVA-3150 on/off	14
type of fuses	9
typical applications	
component and system loss simulation ...	4
EDFA characterization.....	4
instrument calibration	4
power meter linearity	4
spectral tuning	4

U

unit	
covers	9
disconnecting	8
installing.....	9
repairing.....	9
ventilation	9
unit recalibration.....	59

V

ventilation	9
-------------------	---

W

warranty	
certification	65
exclusions	65
general	63
liability.....	64
null and void.....	63
wavelength	
setting	17
see <i>also</i> shortlist of wavelengths	
wavelength correction factor. see base offset value, setting	

NOTICE

通告

CHINESE REGULATION ON RESTRICTION OF HAZARDOUS SUBSTANCES 中国关于有害物质限制的规定

NAMES AND CONTENTS OF THE TOXIC OR HAZARDOUS SUBSTANCES OR ELEMENTS CONTAINED IN THIS EXFO PRODUCT

包含在本 EXFO 产品中的有毒有害物质或元素的名称和含量



O	Indicates that this toxic or hazardous substance contained in all of the homogeneous materials for this part is below the limit requirement in SJ/T11363-2006 表示该有毒有害物质在该部件所有均质材料中的含量均在 SJ/T11363-2006 标准规定的限量要求以下。
X	Indicates that this toxic or hazardous substance contained in at least one of the homogeneous materials used for this part is above the limit requirement in SJ/T11363-2006 表示该有毒有害物质至少在该部件的某一均质材料中的含量超出 SJ/T11363-2006 标准规定的限量要求。

Part Name 部件名称	Toxic or hazardous Substances and Elements 有毒有害物质和元素					
	Lead 铅 (Pb)	Mercury 汞 (Hg)	Cadmium 镉 (Cd)	Hexavalent Chromium 六价铬 (Cr VI)	Polybrominated biphenyls 多溴联苯 (PBB)	Polybrominated diphenyl ethers 多溴二苯醚 (PBDE)
Enclosure 外壳	O	O	O	O	O	O
Electronic and electrical sub-assembly 电子和电子组件	X	O	X	O	X	X
Optical sub-assembly ^a 光学组件 ^a	X	O	O	O	O	O
Mechanical sub-assembly ^a 机械组件 ^a	O	O	O	O	O	O

- a. If applicable.
如果适用。

MARKING REQUIREMENTS

标注要求

Product 产品	Environmental protection use period (years) 环境保护使用期限 (年)	Logo 标志
This Exfo product 本 EXFO 产品	10	
Battery ^a 电池 ^a	5	

- a. If applicable.
如果适用。

P/N: 1058928

www.EXFO.com · info@exfo.com

CORPORATE HEADQUARTERS	400 Godin Avenue	Quebec (Quebec) G1M 2K2 CANADA Tel.: 1 418 683-0211 · Fax: 1 418 683-2170
EXFO AMERICA	3701 Plano Parkway, Suite 160	Plano TX, 75075 USA Tel.: 1 972 907-1505 · Fax: 1 972 836-0164
EXFO EUROPE	Omega Enterprise Park, Electron Way	Chandlers Ford, Hampshire S053 4SE ENGLAND Tel.: +44 2380 246810 · Fax: +44 2380 246801
EXFO ASIA-PACIFIC	100 Beach Road, #22-01/03 Shaw Tower	SINGAPORE 189702 Tel.: +65 6333 8241 · Fax: +65 6333 8242
EXFO CHINA	Room 2711, Trade Center, No. 4028 Jintian Road, Futian District	Shenzhen 518035 P. R. CHINA Tel.: +86 (755) 8203 2300 · Fax: +86 (755) 8203 2306
	Beijing Global Trade Center, Tower C, Room 1207, 36 North Third Ring Road East, Dongcheng District	Beijing 100013 P. R. CHINA Tel.: +86 (10) 5825 7755 · Fax: +86 (10) 5825 7722
EXFO SERVICE ASSURANCE	270 Billerica Road	Chelmsford MA, 01824 USA Tel.: 1 978 367-5600 · Fax: 1 978 367-5700
TOLL-FREE	(USA and Canada)	1 800 663-3936

© 2011 EXFO Inc. All rights reserved.
Printed in Canada (2011-04)



EXFO
EXPERTISE REACHING OUT