IQS-2150

Light Source for IQS Platforms



Copyright © 2003–2015 EXFO Inc. All rights reserved. No part of this publication may be reproduced, stored in a retrieval system or transmitted in any form, be it electronically, mechanically, or by any other means such as photocopying, recording or otherwise, without the prior written permission of EXFO Inc. (EXFO).

Information provided by EXFO is believed to be accurate and reliable. However, no responsibility is assumed by EXFO for its use nor for any infringements of patents or other rights of third parties that may result from its use. No license is granted by implication or otherwise under any patent rights of EXFO.

EXFO's Commerce And Government Entities (CAGE) code under the North Atlantic Treaty Organization (NATO) is 0L8C3.

The information contained in this publication is subject to change without notice.

Trademarks

EXFO's trademarks have been identified as such. However, the presence or absence of such identification does not affect the legal status of any trademark.

Units of Measurement

Units of measurement in this publication conform to SI standards and practices.

Version number: 3.0.1.2

Contents

Certification Information	v
1 Introducing the IQS-2150 Light Source	1
Main Features	1
Available Models	2
Typical Applications	2
Conventions	3
2 Safety Information	5
3 Getting Started with Your Light Source	7
Inserting and Removing Test Modules	7
Starting the Light Source Application	12
Exiting the Application	15
4 Setting Up Your Light Source	17
Selecting a Wavelength	18
Setting the Attenuation	20
Selecting a Modulation Frequency	22
Saving and Recalling Configurations	24
5 Operating Your Light Source	27
Cleaning and Connecting Optical Fibers	27
Installing the EXFO Universal Interface (EUI)	29
Activating or Deactivating Light Emission	30
Viewing Results	31
6 Monitoring Light Source Modules	33
Using Monitor Windows	33
Using QuickTools	36
7 Maintenance	39
Cleaning Fixed Connectors	40
Cleaning EUI Connectors	42
Recalibrating the Unit	44
Recycling and Disposal (Applies to European Union Only)	45

Contents

8 Troubleshooting	47
Solving Common Problems	47
Viewing Online Documentation	48
Contacting the Technical Support Group	49
Transportation	51
9 Warranty	53
General Information	53
Liability	53
Exclusions	54
Certification	54
Service and Repairs	55
EXFO Service Centers Worldwide	56
A Technical Specifications	57
B SCPI Command Reference	59
Quick Reference Command Tree	60
Product-Specific Commands—Description	61
Index	77

Certification Information

North America Regulatory Statement

This unit was certified by an agency approved in both Canada and the United States of America. It has been evaluated according to applicable North American approved standards for product safety for use in Canada and the United States.

Electronic test and measurement equipment is exempt from FCC part 15, subpart B compliance in the United States of America and from ICES-003 compliance in Canada. However, EXFO Inc. makes reasonable efforts to ensure compliance to the applicable standards.

The limits set by these standards are designed to provide reasonable protection against harmful interference when the equipment is operated in a commercial environment. This equipment generates, uses, and can radiate radio frequency energy and, if not installed and used in accordance with the user guide, may cause harmful interference to radio communications. Operation of this equipment in a residential area is likely to cause harmful interference in which case the user will be required to correct the interference at his own expense.

Modifications not expressly approved by the manufacturer could void the user's authority to operate the equipment.



IMPORTANT

Use of shielded remote I/O cables, with properly grounded shields and metal connectors, is recommended in order to reduce radio frequency interference that may emanate from these cables.

1 Introducing the IQS-2150 Light Source

Main Features

The IQS-2150 Light Source is designed for scientific and industrial applications using the IQS Platforms. The IQS-2150 Light Source includes a choice of multimode LEDs and single-mode DFB laser emitters, in single- and dual-wavelength configurations, for both singlemode and multimode test applications.

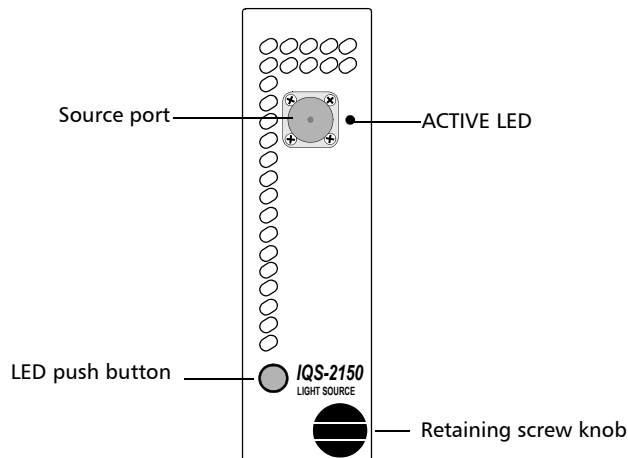

The IQS-2150 Light Source is designed for optimal stability. Steady drive circuitry maximizes optical output power and maintains excellent stability, while precision optical components ensure efficient, low-loss, narrow-beam output coupling.

Introducing the IQS-2150 Light Source

Available Models

A single-operation display screen lets you activate sources and select signal wavelength, power, and modulation characteristics. The nominal wavelength is also displayed. For easy repeat access, the software stores multiple power level and modulation configurations. Its Windows-based software allows the IQS-2150 Light Source to integrate easily into any test system.

The IQS-2150 Light Source supports local control (via the IQS Manager software) and remote control (through GPIB, RS-232, or Ethernet TCP/IP using SCPI commands or the provided LabVIEW drivers). For more information, refer to the *IQS platform* user guide.

Available Models

The IQS-2150 Light Source offers different models, which are distinguished by characteristics such as the type of LED or laser used:

- DFB laser
- LED

Typical Applications

This light source is suitable for quality control, acceptance testing, and insertion loss and return loss testing in laboratory and manufacturing environments.

Conventions

Before using the product described in this guide, you should understand the following conventions:



WARNING

Indicates a potentially hazardous situation which, if not avoided, could result in *death or serious injury*. Do not proceed unless you understand and meet the required conditions.



CAUTION

Indicates a potentially hazardous situation which, if not avoided, may result in *minor or moderate injury*. Do not proceed unless you understand and meet the required conditions.



CAUTION

Indicates a potentially hazardous situation which, if not avoided, may result in *component damage*. Do not proceed unless you understand and meet the required conditions.



IMPORTANT

Refers to information about this product you should not overlook.

2 **Safety Information**



WARNING

Do not install or terminate fibers while a light source is active. Never look directly into a live fiber and ensure that your eyes are protected at all times.



WARNING

The use of controls, adjustments and procedures, namely for operation and maintenance, other than those specified herein may result in hazardous radiation exposure or impair the protection provided by this unit.



IMPORTANT

When you see the following symbol on your unit , make sure that you refer to the instructions provided in your user documentation. Ensure that you understand and meet the required conditions before using your product.



IMPORTANT

Other safety instructions relevant for your product are located throughout this documentation, depending on the action to perform. Make sure to read them carefully when they apply to your situation.

Safety Information

Your IQS-2150 Light Source is a Class 1 laser or LED product in compliance with standards IEC 60825-1: 2007 and 21 CFR 1040.10, except for deviations pursuant to Laser Notice No. 50, dated June 24, 2007. Invisible laser radiation may be encountered at the output port.

The following labels indicate that a product contains a Class 1 source:

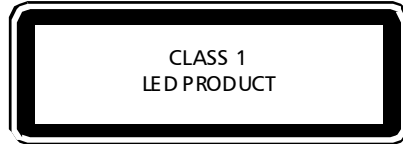

Note: *The above labels are shown for information purposes only. They are not affixed to your product.*

For more information on product safety and equipment ratings, refer to the user documentation of your platform.

The Light Source power consumption is 5 W.

3 ***Getting Started with Your Light Source***

Inserting and Removing Test Modules



CAUTION

Never insert or remove a module while the controller unit and its expansion units are turned on. This will result in immediate and irreparable damage to both the module and unit.



CAUTION

To avoid damaging your unit, use it only with modules approved by EXFO.

Getting Started with Your Light Source

Inserting and Removing Test Modules

To insert a module into the controller or expansion unit:

- 1.** Exit IQS Manager and turn off all your units.
- 2.** Remove the protective cover from the desired unused module slot.
 - 2a.** Pull the retaining screw knob firmly towards you and release the bottom of the cover.
 - 2b.** Gently pull the top of the protective cover downwards, to remove it from the unit grooves.

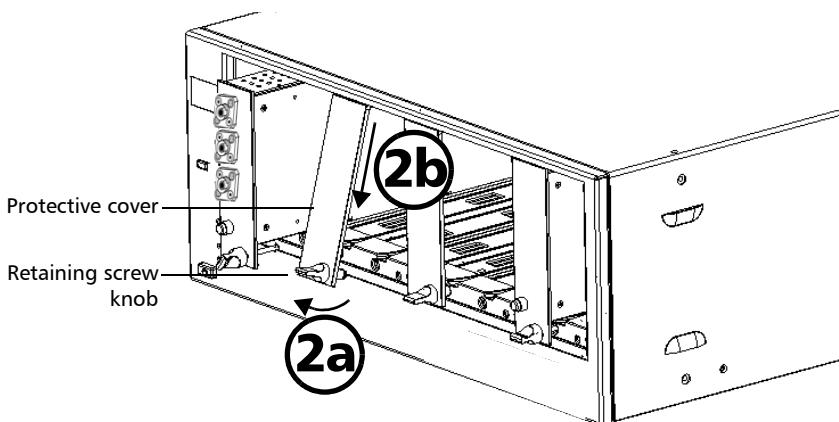

- 3.** Position the module so that its front panel is facing you and the top and bottom protruding edges are to your right.

Getting Started with Your Light Source

Inserting and Removing Test Modules

4. Insert the protruding edges of the module into the grooves of the unit's module slot.

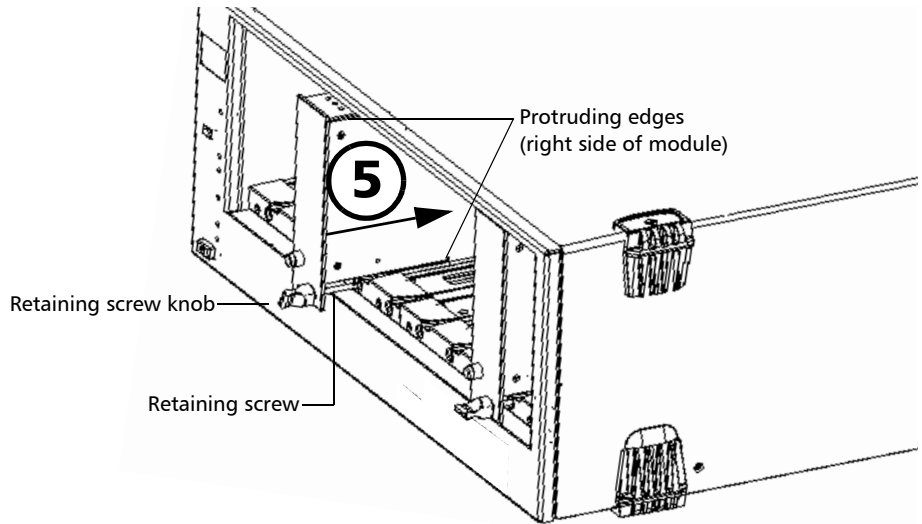

5. Push the module all the way to the back of the slot, until the retaining screw makes contact with the unit casing.
6. While applying slight pressure to the module, turn the retaining screw knob (located at the bottom of the panel) clockwise until the knob is horizontal.

This will secure the module into its “seated” position.

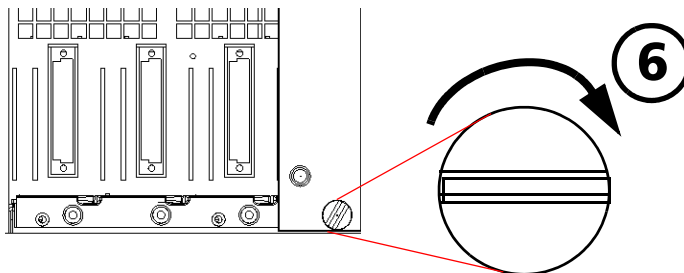

Getting Started with Your Light Source

Inserting and Removing Test Modules

The module is correctly inserted when its front panel is flush with the front panel of the controller or expansion unit.

When you turn on the controller unit, the startup sequence will automatically detect your module.

Note: You can insert IQ modules into your controller or expansion unit; the IQS Manager software will recognize them. However, the IQS-600 locking mechanism (retaining screw) will not work for IQ modules.

To remove a module from your controller or expansion unit:

1. While pulling gently on the knob, turn it counterclockwise until it stops.

The module will slowly be released from the slot.

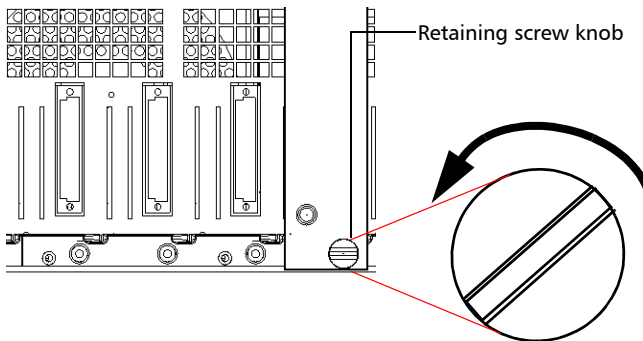

2. Place your fingers underneath the module or hold it by the retaining screw knob (*NOT by the connector*) and pull it out.

Getting Started with Your Light Source

Inserting and Removing Test Modules

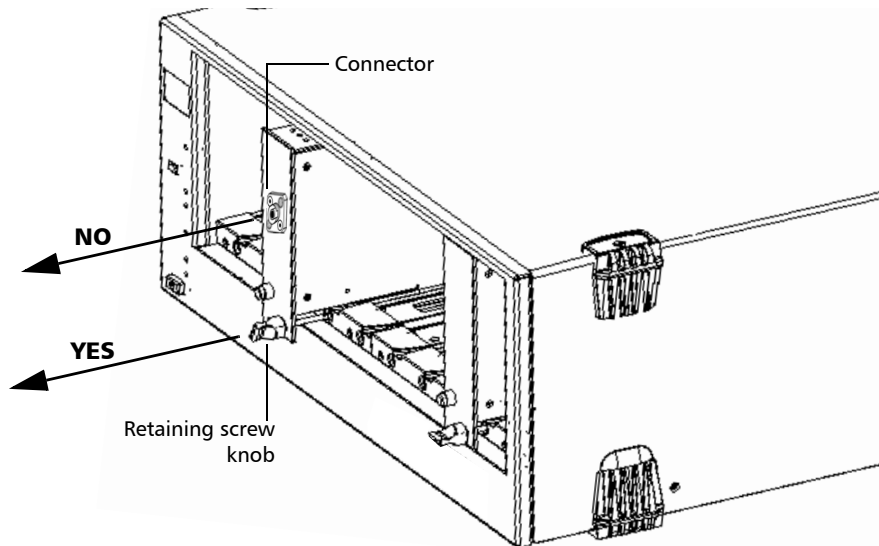

CAUTION

Pulling out a module by a connector could seriously damage both the module and connector. Always pull out a module by the retaining screw knob.

3. Cover empty slots with the supplied protective covers.
 - 3a. Slide the top of the protective cover into the upper grooves of the unit.
 - 3b. Snap the cover into place by pushing the retaining screw knob.



CAUTION

Failure to reinstall protective covers over empty slots will result in ventilation problems.

Getting Started with Your Light Source

Starting the Light Source Application

Starting the Light Source Application

Your IQS-2150 Light Source module can be configured and controlled from its dedicated IQS Manager application (available only in IQS Manager 4.0 or later).

Note: For details about IQS Manager, refer to the IQS platform user guide.

To start the application:

1. From the **Current Modules** function tab select the module to use.

It will turn white to indicate that it is highlighted.

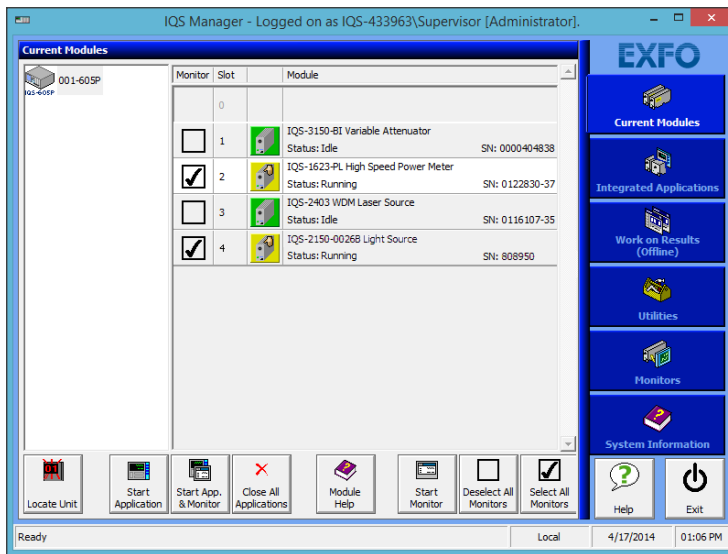

2. Click **Start Application**.

OR

Press the green LED push button on the front of the corresponding module.

You can also double-click its row.

Getting Started with Your Light Source

Starting the Light Source Application

Note: Pressing the LED push button will only enable you to switch to the module application. The laser emission will not be activated.

Note: To start the corresponding monitor window at the same time, click **Start App. & Monitor**. The window opens on the **Monitors** function tab.

The main window (shown below) contains all the commands required to control the Light Source:

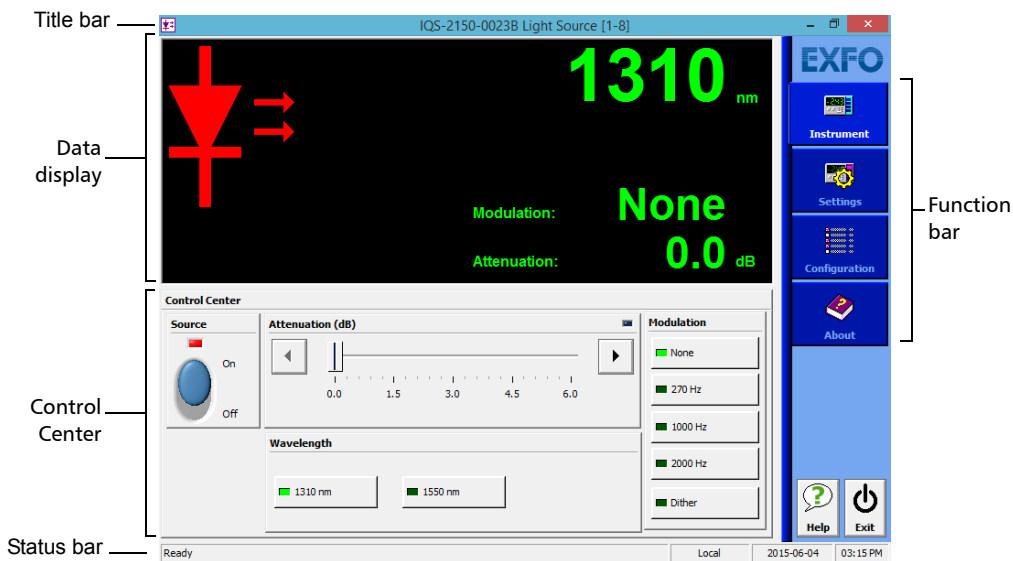

Getting Started with Your Light Source

Starting the Light Source Application

Title Bar

The title bar is located at the top of the main window. It displays the module name and its position in the controller or expansion unit. The module position is identified as follows:

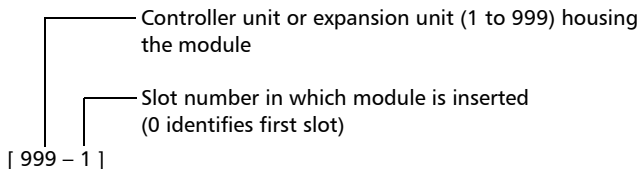

Status Bar

The status bar, located at the bottom of the main window, identifies the operational status of the IQS-2150 Light Source.

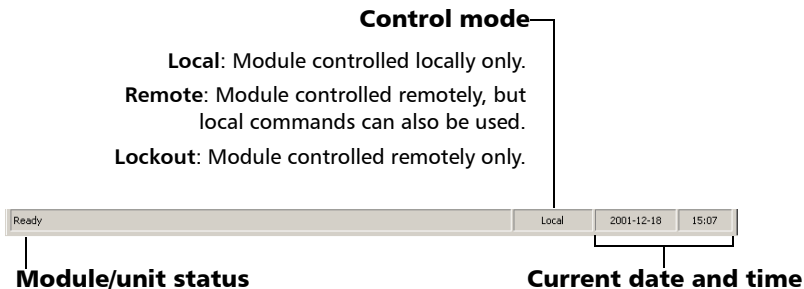

For more information about automating or remotely controlling the IQS-2150 Light Source, refer to your platform user guide.

Data Display

In addition to the **Control Center**, the main window also contains the data display, where the source status indicator, as well as values for wavelength, modulation, and attenuation controls are shown (see figure below).

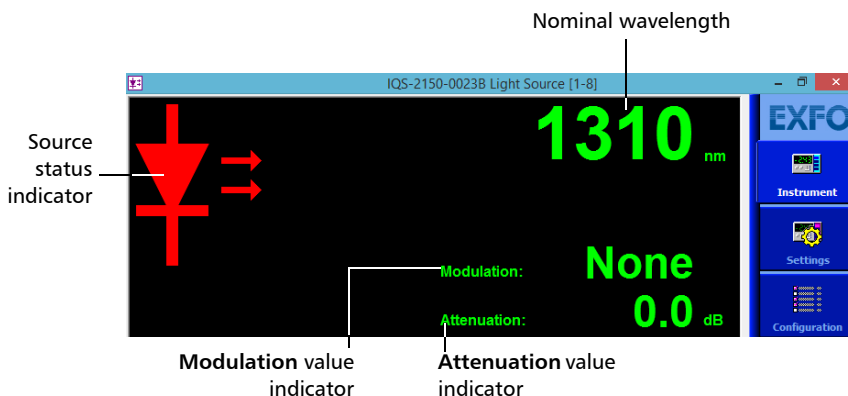

Exiting the Application

Closing any application that is not currently being used helps freeing system memory.

To close the application from the main window:

Click  in the top right corner of the main window.

OR

Click the **Exit** button located at the bottom of the function bar.

To close all currently running applications:

From IQS Manager, click **Close All Applications**.

4 Setting Up Your Light Source

Light source features are controlled with the Windows-compatible IQS Manager software. Please refer to the IQS Platforms user guides for information regarding the IQS-500/600 Controller Units and IQS Manager software conventions.

The source is controlled and operated from within the **Control Center**. Depending on your source model, some or all of the following operations are available:

- selecting wavelength (for dual-wavelength modules only)
- setting attenuation
- selecting modulation
- saving and recalling a configuration

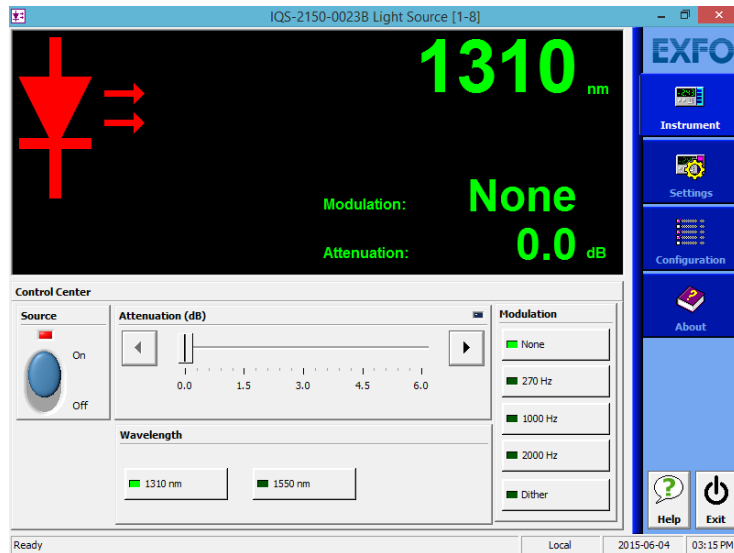

Note: You do not need to turn on the IQS-2150 Light Source or connect it to a DUT to set it up. To turn on the source, see Operating Your Light Source on page 27.

Setting Up Your Light Source

Selecting a Wavelength

Selecting a Wavelength

If you are using a dual-wavelength module, you can select a wavelength to perform your tests. When the source is activated, the wavelength appears in the top right corner.

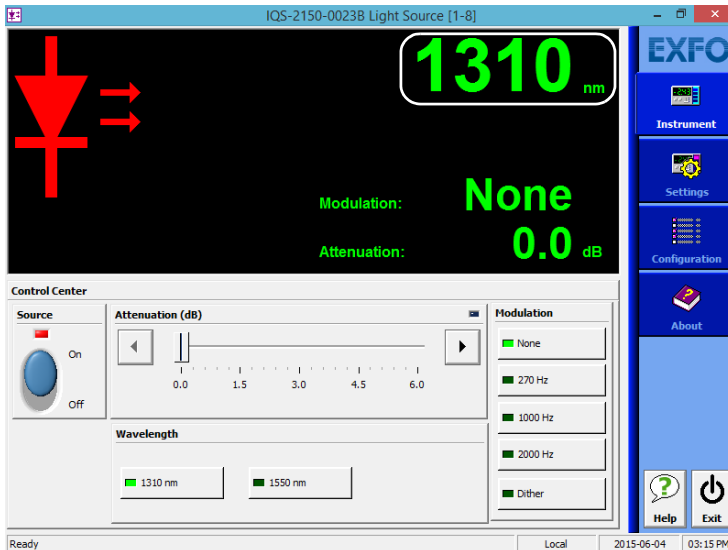

To select the desired wavelength:

Click the appropriate button in the **Wavelength** panel. A green light identifies the selected wavelength.

When you select a wavelength, you will see the message **Stabilization in progress...** on the data display until this new wavelength is active. Once the stabilization is complete, the selected wavelength is displayed on-screen.

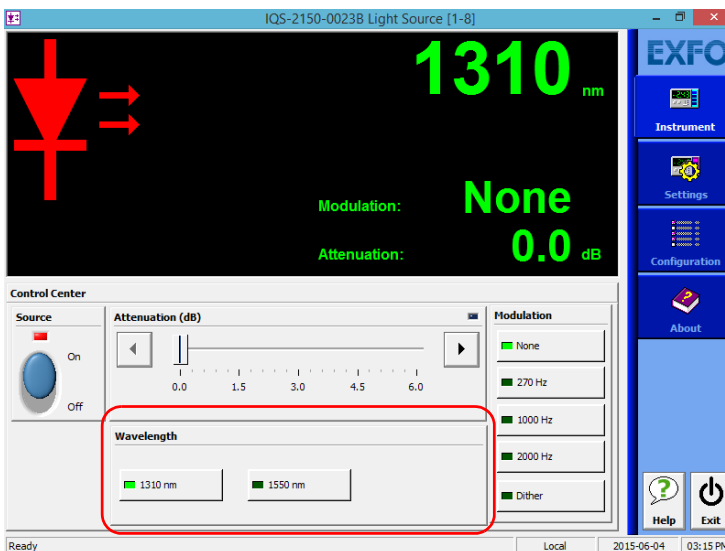

You can also select a wavelength from the QuickTools utility. For details, see *Monitoring Light Source Modules* on page 33.

Note: *The wavelength specified in the **Wavelength** panel corresponds to the nominal wavelength.*

Setting Up Your Light Source

Setting the Attenuation

You can modify the power of the IQS-2150 Light Source output by attenuating the emitted signal.

With some IQS-2150 Light Source models, the **Attenuation** control is grayed out during the stabilization period, which occurs after you have selected a wavelength if the source is activated.

To set the source attenuation:

1. Select the **Instrument** function tab.
2. Adjust the attenuation of the laser signal emitted by the source from the **Attenuation (dB)** panel.

Note: When a multimode source is used, the attenuation value increases or decreases by steps of 0.5 dB. With a singlemode source, the attenuation value increases or decreases by steps of 0.1 dB. The attenuation is not possible when the modulation mode is used.

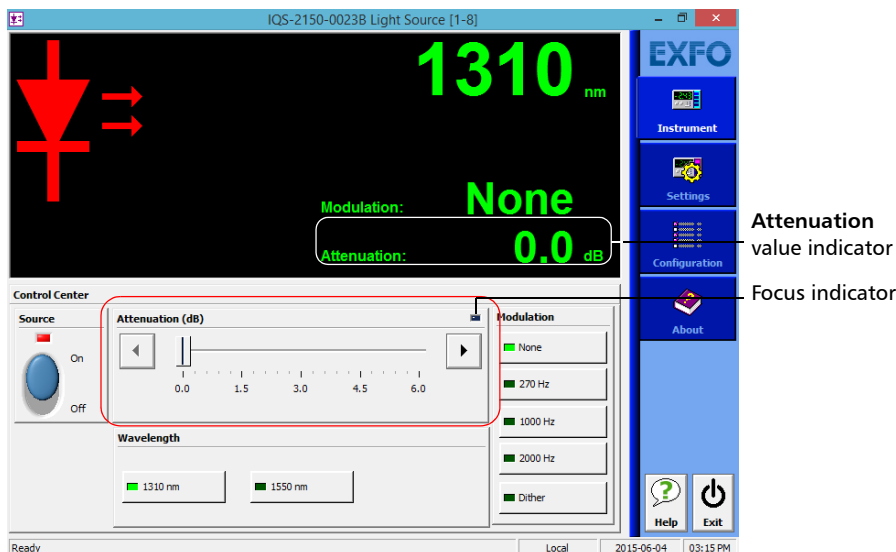

The attenuation value in the data display will then indicate the increased or decreased attenuation.

As you change the attenuation value, you will notice that the numbers change from green to orange. After you release the attenuation controls, they revert to their original green color to indicate that the change has been applied to the source (when it is active). The focus indicator rectangle on the control turns blue when setting the attenuation value.

The attenuation value indicator on the data display (see preceding figure) indicates the level of attenuation in dB, selected using the attenuation controls.

You can also set attenuation from the QuickTools utility. For details, see *Monitoring Light Source Modules* on page 33.

Note: *To obtain maximum output power, attenuation should be set to 0.0 dB and modulation should be set to None.*

Setting Up Your Light Source

Selecting a Modulation Frequency

Selecting a Modulation Frequency

You can modulate the laser output of the IQS-2150 Light Source to simulate data transfer. A number of modulation frequencies are available.

The modulation can be set to different values to better suit your testing needs.

When the modulation is set to dither, it activates the dither mode so the IQS-2150 can be used to perform ORL measurements. Dithering broadens the source spectrum and reduces light coherence and will therefore improve measurement stability. The dither mode is available in singlemode only.

To select a modulation frequency:

1. Select a modulation frequency by choosing a value in the **Modulation** panel, as shown in the following figure.

A green light identifies the selected modulation frequency.

To indicate a successful selection, **Stabilization in progress** appears in the data display (only if the source is an active laser).

The **Modulation** value indicator in the data display indicates the source modulation frequency selected.

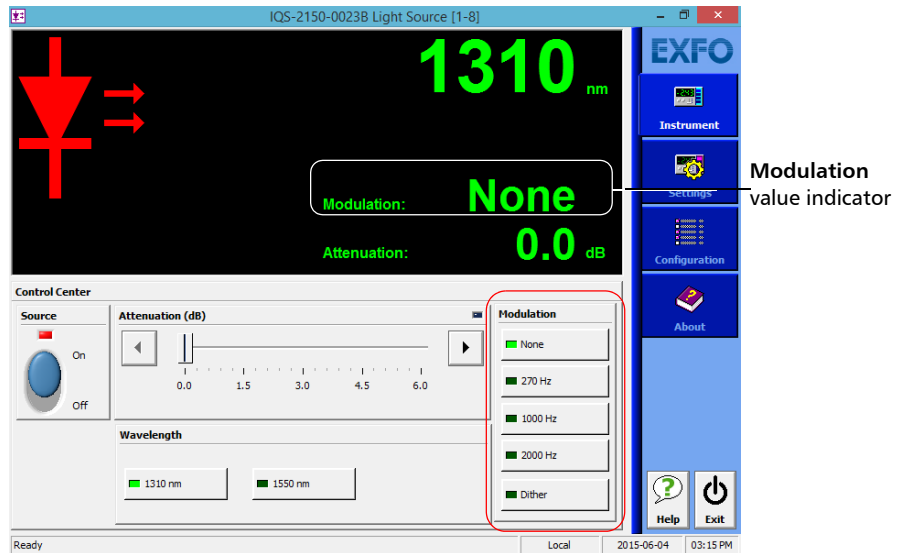

2. You can also select a modulation frequency from the QuickTools utility. For details, see *Monitoring Light Source Modules* on page 33.

Note: The internal modulation is full on/off modulation at a 50 % duty cycle.

Saving and Recalling Configurations

Once you have set the IQS-2150 Light Source parameters, you can save your custom configuration and recall it at any time. You can also recall the factory-defined settings.

Saved configurations include all parameters set in the **Control Center** (**Instrument** function tab) and in the **Settings** function tab (if present).

To save a configuration:

1. Select the **Configuration** function tab.

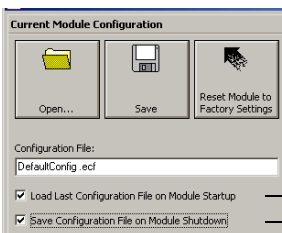

To always use the last saved parameters when starting.

To save parameters being used just before shutting down, *overwriting the previous file.*

2. In the **Current Module Configuration** panel, enter the name you wish to use for your configuration file.

It will be saved in

D:\IQS Manager\Configuration Files*(your_module)*.\

3. Click **Save**.

To recall a configuration:

1. Select the **Configuration** function tab.
2. Click **Open**.
3. Select the configuration file you wish to recall and confirm your action.

You are returned to the application and the new parameters are set.

To revert to factory settings:

1. Select the **Configuration** function tab.
2. Click the **Reset Module to Factory Settings** button.



IMPORTANT

Reverting to the factory settings will interrupt any module operation in progress.



IMPORTANT

The operation may take a few seconds to complete.

5 **Operating Your Light Source**

Once you have set your source parameters, you are ready to use the source in a test setup.

To operate the source, you must perform the following steps:

- Connect the source to other test components.
- Activate or deactivate the source.

Cleaning and Connecting Optical Fibers



IMPORTANT

To ensure maximum power and to avoid erroneous readings:

- Always inspect fiber ends and make sure that they are clean as explained below before inserting them into the port. EXFO is not responsible for damage or errors caused by bad fiber cleaning or handling.
- Ensure that your patchcord has appropriate connectors. Joining mismatched connectors will damage the ferrules.

To connect the fiber-optic cable to the port:

- 1.** Inspect the fiber using a fiber inspection microscope. If the fiber is clean, proceed to connecting it to the port. If the fiber is dirty, clean it as explained below.
- 2.** Clean the fiber ends as follows:
 - 2a.** Gently wipe the fiber end with a lint-free swab dipped in isopropyl alcohol.
 - 2b.** Use compressed air to dry completely.
 - 2c.** Visually inspect the fiber end to ensure its cleanliness.

Operating Your Light Source

Cleaning and Connecting Optical Fibers

3. Carefully align the connector and port to prevent the fiber end from touching the outside of the port or rubbing against other surfaces.

If your connector features a key, ensure that it is fully fitted into the port's corresponding notch.

4. Push the connector in so that the fiber-optic cable is firmly in place, thus ensuring adequate contact.

If your connector features a screwsleeve, tighten the connector enough to firmly maintain the fiber in place. Do not overtighten, as this will damage the fiber and the port.

Note: *If your fiber-optic cable is not properly aligned and/or connected, you will notice heavy loss and reflection.*

EXFO uses good quality connectors in compliance with EIA-455-21A standards.

To keep connectors clean and in good condition, EXFO strongly recommends inspecting them with a fiber inspection probe before connecting them. Failure to do so will result in permanent damage to the connectors and degradation in measurements.

Installing the EXFO Universal Interface (EUI)

The EUI fixed baseplate is available for connectors with angled (APC) or non-angled (UPC) polishing. A green border around the baseplate indicates that it is for APC-type connectors.

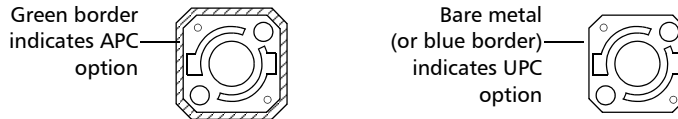

To install an EUI connector adapter onto the EUI baseplate:

- 1.** Hold the EUI connector adapter so the dust cap opens downwards.

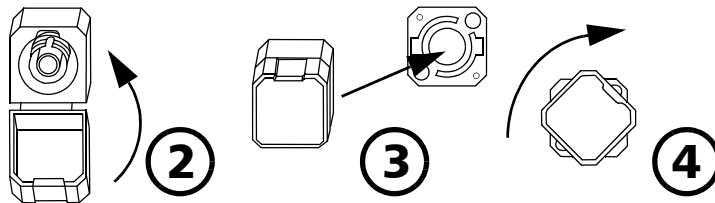

- 2.** Close the dust cap in order to hold the connector adapter more firmly.
- 3.** Insert the connector adapter into the baseplate.
- 4.** While pushing firmly, turn the connector adapter clockwise on the baseplate to lock it in place.

Operating Your Light Source

Activating or Deactivating Light Emission

Activating or Deactivating Light Emission

Before activating the source, read carefully *Safety Information* on page 5. Upon source activation, the set parameter values are used. Therefore, make sure the source setup is correct before activation.

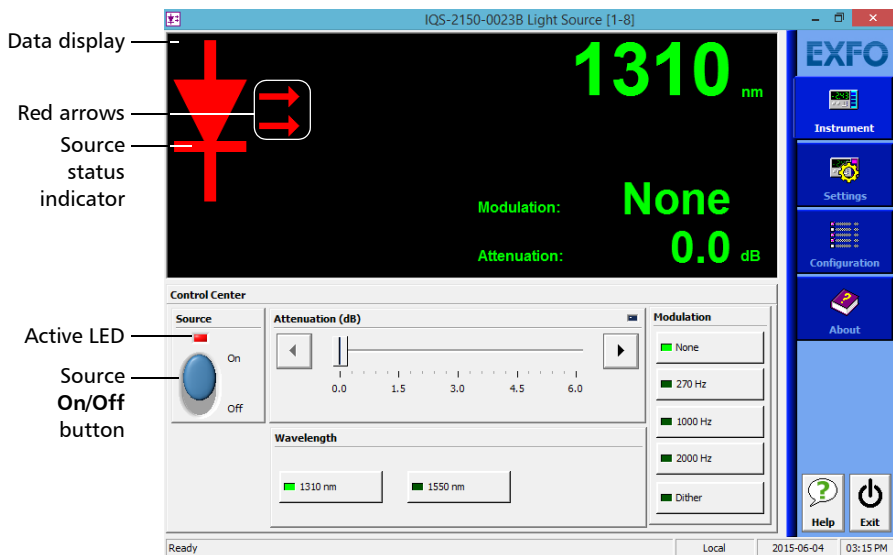

To activate or deactivate light emission:

- Select **ON** to activate the light emission. The ACTIVE LED on the module's front panel lights up, indicating that the source is active.

The data display lights up and two red arrows appear beside the status indicator on the data display, indicating that the source is on (see preceding figure).

- Select **OFF** to deactivate the light emission. The ACTIVE LED on the module's front panel turns off, indicating that the source is off.

The status indicator on the data display is dimmed and the two red arrows disappear from the data display indicating that the source has been deactivated.

Note: *You should let the source warm up for 15 minutes to obtain optimum wavelength stability.*

You can also activate or deactivate the light source from the QuickTools utility. For more information, see *Monitoring Light Source Modules* on page 33.

Viewing Results

You cannot view results directly using the IQS-2150 Light Source software. To view results, you must use modules and systems which perform tests. For more information, refer to test modules or system user guides, or call EXFO.

6 **Monitoring Light Source Modules**

When using your IQS-2150 Light Source module, either alone or with other modules in a test setup, you can view module data and status using its monitor window in IQS Manager.

Using Monitor Windows

Monitor windows display basic data about modules. A combination of resizable windows allows you to create an integrated data display (refer to the platform user guide).

From the monitor window, you can change module parameters either by:

- opening the module application to access all the functions

OR

- using the QuickTools utility, which provides frequently used functions from the application.

Monitoring Light Source Modules

Using Monitor Windows

To select modules and display their monitor windows:

1. On the **Current Modules** function tab, select the controller or expansion unit containing the modules you want to monitor.

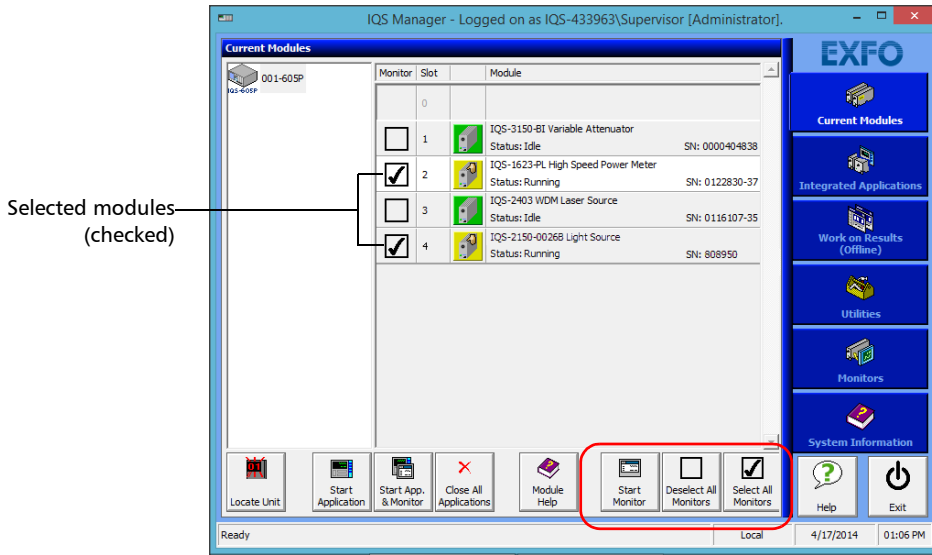

2. In the **Monitor** column, select the box next to each module you want to monitor.

If you want to monitor all the modules *in the current unit*, click **Select All Monitors**. If you want to clear your choices, click **Deselect All Monitors**.

3. Click **Start Monitor** to apply your selection.

IQS Manager will display the selected monitor windows on the **Monitors** function tab.

Note: To start the highlighted module's corresponding application at the same time, click **Start App. & Monitor**. The application will appear in a different window.

Monitoring Light Source Modules

Using Monitor Windows

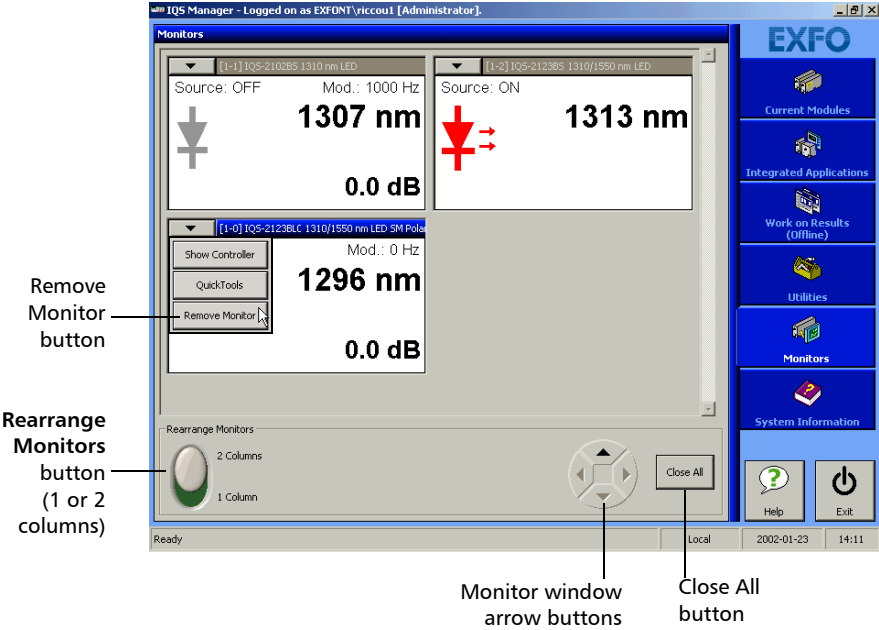

Monitoring Light Source Modules

Using QuickTools

Using QuickTools

With QuickTools, you can fine-tune your module directly, while keeping an eye on your entire test setup.

Note: You can only access QuickTools if the module's monitor window is selected from the **Monitors** function tab and is currently active.

To start QuickTools:

1. From the **Monitors** function tab, select the monitor window of the module you wish to control.
2. Using the arrow button in the upper left corner, select **QuickTools**.

The corresponding monitor window flashes when QuickTools is activated.

Note: If you want to open the actual application for your module rather than QuickTools, click **Show Controller**.

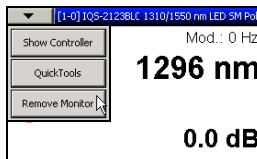

For the IQS-2150 Light Source, one of the two QuickTools utility versions will be displayed, depending on the selected module, as shown in the following figure.

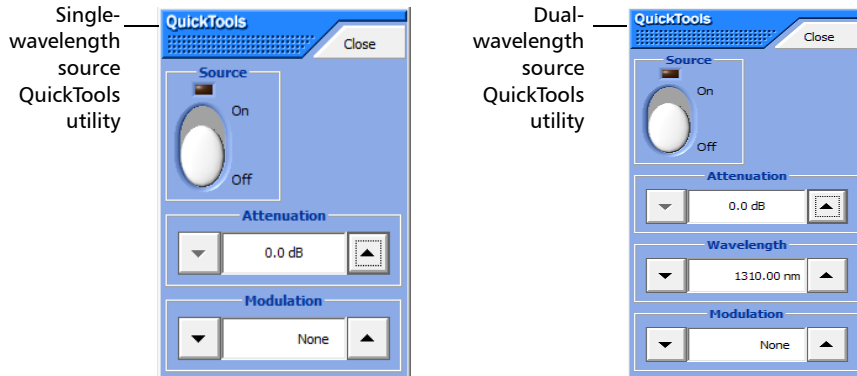

To control a specific source with QuickTools:

Make sure that the IQS-2150 Light Source monitor window is selected (its title bar should be displayed in the same color as the sidebar buttons).

- Turn the source on (for more information, see *Activating or Deactivating Light Emission* on page 30).
- From the **Attenuation** section, you can set the attenuation by clicking the selection arrows on both sides of the list to increase or lower the attenuation. The current Attenuation value is displayed between the button (for details, see *Setting the Attenuation* on page 20).

Note: When a multimode source is used, the attenuation value increases or decreases by steps of 0.5 dB. With a singlemode source, the attenuation value increases or decreases by steps of 0.1 dB. The attenuation is not possible when the modulation mode is used.

Note: To obtain maximum output power, the attenuation should be set to 0.0 dB and modulation should be set to None.

Monitoring Light Source Modules

Using QuickTools

- From the **Wavelength** section, you can select a wavelength by clicking the selection arrows on both sides of the list (for details, see *Selecting a Wavelength* on page 18).

Note: For single-source IQS-2150 modules, the **Wavelength** panel is not displayed.

- From the **Modulation** section, select a modulation frequency by clicking the selection arrows on both sides of the list (for details, see *Selecting a Modulation Frequency* on page 22).

To close QuickTools:

Click the **Close** button located at the top of the window.

OR

Click outside the QuickTools window.

To close a monitor window:

Click the button on the upper left of the monitor window and select **Remove Monitor**.

OR

Click the **Close All** button at the bottom of the window.

7 **Maintenance**

To help ensure long, trouble-free operation:

- Always inspect fiber-optic connectors before using them and clean them if necessary.
- Keep the unit free of dust.
- Clean the unit casing and front panel with a cloth slightly dampened with water.
- Store unit at room temperature in a clean and dry area. Keep the unit out of direct sunlight.
- Avoid high humidity or significant temperature fluctuations.
- Avoid unnecessary shocks and vibrations.
- If any liquids are spilled on or into the unit, turn off the power immediately, disconnect from any external power source, remove the batteries and let the unit dry completely.



WARNING

The use of controls, adjustments and procedures, namely for operation and maintenance, other than those specified herein may result in hazardous radiation exposure or impair the protection provided by this unit.

Cleaning Fixed Connectors

Regular cleaning of connectors will help maintain optimum performance. *Do not try to disassemble the unit. Doing so would break the connector.*



WARNING

Looking into the optical connector while the light source is active **WILL** result in permanent eye damage. EXFO strongly recommends to **TURN OFF** the unit before proceeding with the cleaning procedure.

To clean fixed connectors:

1. Fold a lint-free wiping cloth in four to form a square.
2. Moisten the center of the lint-free wiping cloth with *only one drop* of isopropyl alcohol.



IMPORTANT

Alcohol may leave traces if used abundantly. Avoid contact between the tip of the bottle and the wiping cloth, and do not use bottles that distribute too much alcohol at a time.

3. Gently wipe the connector threads three times with the folded and moistened section of the wiping cloth.



IMPORTANT

Isopropyl alcohol takes approximately ten seconds to evaporate. Since isopropyl alcohol is not absolutely pure, evaporation will leave microscopic residue. Make sure you dry the surfaces before evaporation occurs.

4. With a dry lint-free wiping cloth, gently wipe the same surfaces three times with a rotating movement.

5. Throw out the wiping cloths after one use.
6. Moisten a cleaning tip (2.5 mm tip) with *only one drop* of isopropyl alcohol.



IMPORTANT

Alcohol may leave traces if used abundantly. Avoid contact between the tip of the bottle and the cleaning tip, and do not use bottles that distribute too much alcohol at a time.

7. Slowly insert the cleaning tip into the connector until it reaches the ferrule inside (a slow clockwise rotating movement may help).

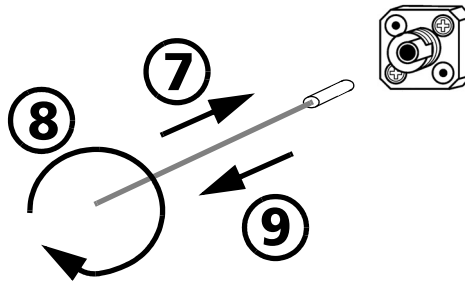

8. Gently turn the cleaning tip one full turn.
9. Continue to turn as you withdraw the cleaning tip.
10. Repeat steps 7 to 9, but this time with a dry cleaning tip (2.5 mm tip provided by EXFO).

Note: Make sure you don't touch the soft end of the cleaning tip and verify the cleanliness of the cotton tip.

11. Throw out the cleaning tips after one use.

Cleaning EUI Connectors

Regular cleaning of EUI connectors will help maintain optimum performance. There is no need to disassemble the unit.



IMPORTANT

If any damage occurs to internal connectors, the module casing will have to be opened and a new calibration will be required.



WARNING

Looking into the optical connector while the light source is active **WILL** result in permanent eye damage. EXFO strongly recommends to **TURN OFF** the unit before proceeding with the cleaning procedure.

To clean EUI connectors:

1. Remove the EUI from the instrument to expose the connector baseplate and ferrule.

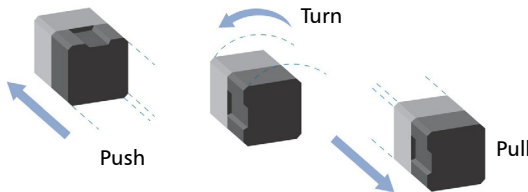

2. Moisten a 2.5 mm cleaning tip with *one drop* of isopropyl alcohol (alcohol may leave traces if used abundantly).
3. Slowly insert the cleaning tip into the EUI adapter until it comes out on the other side (a slow clockwise rotating movement may help).

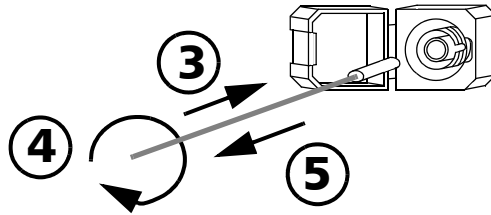

4. Gently turn the cleaning tip one full turn, then continue to turn as you withdraw it.
5. Repeat steps 3 to 4 with a dry cleaning tip.

Note: Make sure you don't touch the soft end of the cleaning tip.

6. Clean the ferrule in the connector port as follows:
 - 6a. Deposit *one drop* of isopropyl alcohol on a lint-free wiping cloth.



IMPORTANT

Isopropyl alcohol may leave residues if used abundantly or left to evaporate (about 10 seconds).

Avoid contact between the tip of the bottle and the wiping cloth, and dry the surface quickly.

- 6b. Gently wipe the connector and ferrule.
- 6c. With a dry lint-free wiping cloth, gently wipe the same surfaces to ensure that the connector and ferrule are perfectly dry.
- 6d. Verify connector surface with a portable fiber-optic microscope (for example, EXFO's FOMS) or fiber inspection probe (for example, EXFO's FIP).
7. Put the EUI back onto the instrument (push and turn clockwise).
8. Throw out cleaning tips and wiping cloths after one use.

Recalibrating the Unit

EXFO manufacturing and service center calibrations are based on the ISO/IEC 17025 standard (*General Requirements for the Competence of Testing and Calibration Laboratories*). This standard states that calibration documents must not contain a calibration interval and that the user is responsible for determining the re-calibration date according to the actual use of the instrument.

The validity of specifications depends on operating conditions. For example, the calibration validity period can be longer or shorter depending on the intensity of use, environmental conditions and unit maintenance, as well as the specific requirements for your application. All of these elements must be taken into consideration when determining the appropriate calibration interval of this particular EXFO unit.

Under normal use, the recommended interval for your IQS-2150 Light Source is: one year.

For newly delivered units, EXFO has determined that the storage of this product for up to six months between calibration and shipment does not affect its performance (EXFO Policy PL-03).

To help you with calibration follow-up, EXFO provides a special calibration label that complies with the ISO/IEC 17025 standard and indicates the unit calibration date and provides space to indicate the due date. Unless you have already established a specific calibration interval based on your own empirical data and requirements, EXFO would recommend that the next calibration date be established according to the following equation:

Next calibration date = Date of first usage (if less than six months after the calibration date) + Recommended calibration period (one year)

To ensure that your unit conforms to the published specifications, calibration may be carried out at an EXFO service center or, depending on the product, at one of EXFO's certified service centers. Calibrations at EXFO are performed using standards traceable to national metrology institutes.

Note: *You may have purchased a FlexCare plan that covers calibrations. See the Service and Repairs section of this user documentation for more information on how to contact the service centers and to see if your plan qualifies.*

Recycling and Disposal (Applies to European Union Only)

For complete recycling/disposal information as per European Directive WEEE 2012/19/UE, visit the EXFO Web site at www.exfo.com/recycle.

8 Troubleshooting

Solving Common Problems

The following is a list of common problems along with their possible causes and some recommended actions to solve them.

Note: *In all cases, if problem persists after performing the recommended actions, contact EXFO.*

Problem	Possible Cause	Recommended Action
LED push button does not light up.	Power not on.	Check AC power cord and turn on the IQS-500/600 Controller or Expansion Unit
	Module is not properly inserted.	Turn off the IQS-500/600 Controller or Expansion Unit, then remove and reinstall the module.
	Computer is locked up.	Reboot the IQS-500/600 Controller Unit.
	LED is burnt.	Call EXFO.
Pushing the LED push button does not open the module main window.	Computer is locked up.	Reboot the IQS-500/600 Controller Unit.
Impossible to open a window.	Too many windows are open at the same time.	Close unused windows, then try to open the needed window again.

Troubleshooting

Viewing Online Documentation

Viewing Online Documentation

An online version of the IQS-2150 Light Source user guide is available at all times from the application.

To access the online user guide:

Click **Help** in the function bar.

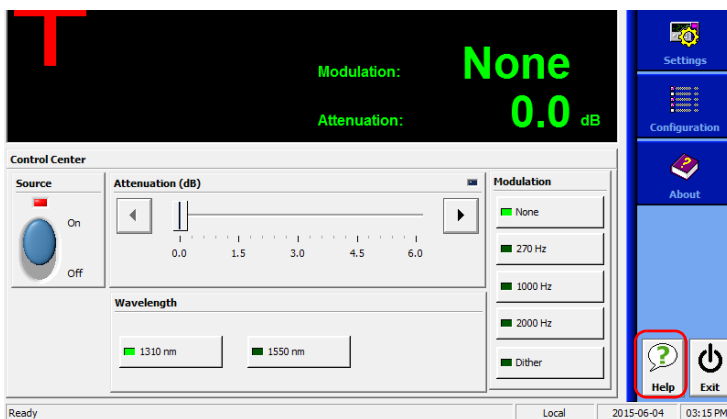

Contacting the Technical Support Group

To obtain after-sales service or technical support for this product, contact EXFO at one of the following numbers. The Technical Support Group is available to take your calls from Monday to Friday, 8:00 a.m. to 7:00 p.m. (Eastern Time in North America).

Technical Support Group

400 Godin Avenue
Quebec (Quebec) G1M 2K2
CANADA

1 866 683-0155 (USA and Canada)
Tel.: 1 418 683-5498
Fax: 1 418 683-9224
support@exfo.com

For detailed information about technical support, and for a list of other worldwide locations, visit the EXFO Web site at www.exfo.com.

If you have comments or suggestions about this user documentation, you can send them to customer.feedback.manual@exfo.com.

To accelerate the process, please have information such as the name and the serial number (see the product identification label), as well as a description of your problem, close at hand.

Troubleshooting

Contacting the Technical Support Group

You may also be requested to provide software and module version numbers. This information, as well as technical support contact information, can be found in the **About** function tab.

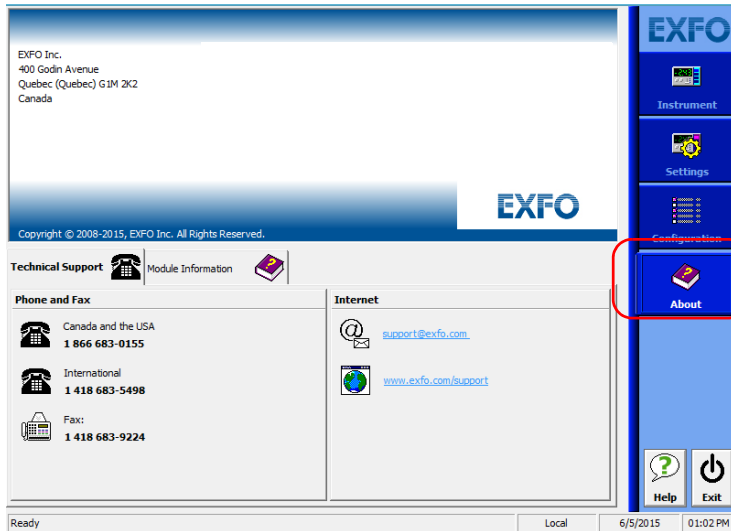

- Select the **Technical Support** tab to view phone numbers and active Internet links to EXFO's Technical Support Group. Use these links to send an information request by e-mail or to access EXFO's web site.
- Select the **Module Information** tab to view the module identification, serial number and firmware version.

Transportation

Maintain a temperature range within specifications when transporting the unit. Transportation damage can occur from improper handling. The following steps are recommended to minimize the possibility of damage:

- Pack the unit in its original packing material when shipping.
- Avoid high humidity or large temperature fluctuations.
- Keep the unit out of direct sunlight.
- Avoid unnecessary shocks and vibrations.

9 **Warranty**

General Information

EXFO Inc. (EXFO) warrants this equipment against defects in material and workmanship for a period of two years from the date of original shipment. EXFO also warrants that this equipment will meet applicable specifications under normal use.

During the warranty period, EXFO will, at its discretion, repair, replace, or issue credit for any defective product, as well as verify and adjust the product free of charge should the equipment need to be repaired or if the original calibration is erroneous. If the equipment is sent back for verification of calibration during the warranty period and found to meet all published specifications, EXFO will charge standard calibration fees.

THIS WARRANTY IS IN LIEU OF ALL OTHER WARRANTIES EXPRESSED, IMPLIED, OR STATUTORY, INCLUDING, BUT NOT LIMITED TO, THE IMPLIED WARRANTIES OF MERCHANTABILITY AND FITNESS FOR A PARTICULAR PURPOSE. IN NO EVENT SHALL EXFO BE LIABLE FOR SPECIAL, INCIDENTAL, OR CONSEQUENTIAL DAMAGES.

Liability

EXFO shall not be liable for damages resulting from the use of the product, nor shall be responsible for any failure in the performance of other items to which the product is connected or the operation of any system of which the product may be a part.

EXFO shall not be liable for damages resulting from improper usage or unauthorized modification of the product, its accompanying accessories and software.

Warranty

Exclusions

Exclusions

EXFO reserves the right to make changes in the design or construction of any of its products at any time without incurring obligation to make any changes whatsoever on units purchased. Accessories, including but not limited to fuses, pilot lamps, batteries and universal interfaces (EUI) used with EXFO products are not covered by this warranty.

This warranty excludes failure resulting from: improper use or installation, normal wear and tear, accident, abuse, neglect, fire, water, lightning or other acts of nature, causes external to the product or other factors beyond the control of EXFO.

Certification

EXFO certifies that this equipment met its published specifications at the time of shipment from the factory.

Service and Repairs

EXFO commits to providing product service and repair for five years following the date of purchase.

To send any equipment for service or repair:

1. Call one of EXFO's authorized service centers (see *EXFO Service Centers Worldwide* on page 56). Support personnel will determine if the equipment requires service, repair, or calibration.
2. If equipment must be returned to EXFO or an authorized service center, support personnel will issue a Return Merchandise Authorization (RMA) number and provide an address for return.
3. If possible, back up your data before sending the unit for repair.
4. Pack the equipment in its original shipping material. Be sure to include a statement or report fully detailing the defect and the conditions under which it was observed.
5. Return the equipment, prepaid, to the address given to you by support personnel. Be sure to write the RMA number on the shipping slip. *EXFO will refuse and return any package that does not bear an RMA number.*

Note: *A test setup fee will apply to any returned unit that, after test, is found to meet the applicable specifications.*

After repair, the equipment will be returned with a repair report. If the equipment is not under warranty, you will be invoiced for the cost appearing on this report. EXFO will pay return-to-customer shipping costs for equipment under warranty. Shipping insurance is at your expense.

Routine recalibration is not included in any of the warranty plans. Since calibrations/verifications are not covered by the basic or extended warranties, you may elect to purchase FlexCare Calibration/Verification Packages for a definite period of time. Contact an authorized service center (see *EXFO Service Centers Worldwide* on page 56).

Warranty

EXFO Service Centers Worldwide

EXFO Service Centers Worldwide

If your product requires servicing, contact your nearest authorized service center.

EXFO Headquarters Service Center

400 Godin Avenue
Quebec (Quebec) G1M 2K2
CANADA

1 866 683-0155 (USA and Canada)
Tel.: 1 418 683-5498
Fax: 1 418 683-9224
support@exfo.com

EXFO Europe Service Center

Winchester House, School Lane
Chandlers Ford, Hampshire S053 4DG
ENGLAND

Tel.: +44 2380 246800
Fax: +44 2380 246801
support.europe@exfo.com

EXFO Telecom Equipment (Shenzhen) Ltd.

3rd Floor, Building 10,
Yu Sheng Industrial Park (Gu Shu
Crossing), No. 467,
National Highway 107,
Xixiang, Bao An District,
Shenzhen, China, 518126

Tel: +86 (755) 2955 3100
Fax: +86 (755) 2955 3101
support.asia@exfo.com

To view EXFO's network of partner-operated Certified Service Centers nearest you, please consult EXFO's corporate website for the complete list of service partners:

<http://www.exfo.com/support/services/instrument-services/exfo-service-centers>.

A Technical Specifications



IMPORTANT

The following technical specifications can change without notice. The information presented in this section is provided as a reference only. To obtain this product's most recent technical specifications, visit the EXFO Web site at www.exfo.com.

TECHNICAL SPECIFICATIONS ^{a, b}				
DFB Laser Specifications				
Wavelength (nm)	1310	1490	1550	1625
Central wavelength accuracy (nm) ^c	±20	±20	±20	±20
Spectral width (nm)	< 5	< 5	< 5	< 5
Output power (dBm) ^c	≥ 0	≥ 0	≥ 0	≥ 0
Modulation	CW; 270 Hz, 1 KHz, 2 KHz (50 % duty cycle)			
LED Specifications				
Wavelength (nm)	850		1300	
Central wavelength (nm) ^c	±25		+40/-20	
Spectral width (FWHM) (nm)	≥ 30		≥ 100	
Output power (dBm) ^c	≥ -24		≥ -21	
Launching conditions C fiber type (50 μm) D fiber type (62.5 μm) ^a	Compliant to IEC 61280-4-1			
Modulation	CW; 270 Hz, 1 KHz, 2 KHz (50 % duty cycle)			

GENERAL SPECIFICATIONS	
Size (H x W x D)	125 mm x 36 mm x 282 mm (4 ¹⁵ / ₁₆ in x 1 ⁷ / ₁₆ in x 11 ¹ / ₈ in)
Temperature	
Operating	10 °C to 40 °C (50 °F to 104 °F)
Storage	-30 °C to 70 °C (-22 °F to 158 °F)
Relative humidity	0% to 95% non-condensing

LASER SAFETY
Class 1 Laser Product and Class 1 LED Product

Notes

- All specifications are typical and applicable without any attenuation applied.
- All specifications are valid at 23 °C ± 1 °C, with an FC connector.
- After a 15-minute warm-up time in continuous-wave (CW) source mode.

B **SCPI Command Reference**

This appendix presents detailed information on the commands and queries supplied with your IQS-2150 Light Source.



IMPORTANT

Since the IQS controllers and expansion units can house many instruments, you must explicitly specify which instrument you want to remotely control.

You must add the following mnemonic *at the beginning of any command or query* that you send to an instrument:

LINstrument<LogicalInstrumentPos>:

where *<LogicalInstrumentPos>* corresponds to the identification number of the instrument.

IQS controller or expansion unit
identification number (for example, 001)

┌
XXX
└

Instrument slot number (0 to 9)

For information on modifying unit identification, refer to your platform user guide.

Quick Reference Command Tree

Command						Parameter(s)	P.
SNUMBER?							61
SOURCE[1..n]	AM	INTERNAL	FREQUENCY			<ModulationFreq[<wsp>HZ]>	62
			FREQUENCY?				63
	POWER	ATTENUATION				<Attenuation[<wsp>DB]> MAXimum MINimum DEFAULT	64
		ATTENUATION?				[MAXimum MINimum DEFAULT]	66
		STATE				<PowerState>	68
		STATE?					69
		WAVELENGTH				UPPER LOWER	70
		WAVELENGTH?					71
		WAVELENGTH	COUNT?				72
			LOWER?				73
			UPPER?				74
STATUS?							75

Product-Specific Commands—Description

:SNUMber?	
Description	This query returns a value indicating the serial number of the module.
Syntax	:SNUMber?
Parameter(s)	None
Response Syntax	<SerialNumber>
Response(s)	<i>SerialNumber:</i> The response data syntax for <SerialNumber> is defined as a <STRING RESPONSE DATA> element. The <SerialNumber> response represents a string containing the serial number of the module.
Example(s)	SNUM? Returns "123456-AB"

SCPI Command Reference

Product-Specific Commands—Description

:SOURce[1..n]:AM:INTernal:FREQuency

Description	<p>This command selects the internal modulation frequency. The internal modulation is 50 % duty cycle at the selected frequency.</p> <p>*RST sets the modulation frequency to 0 Hz (CW).</p>
Syntax	<p>:SOURce[1..n]:AM:INTernal:FREQuency<wsp> <ModulationFreq[<wsp>HZ]></p>
Parameter(s)	<p><i>ModulationFreq:</i></p> <p>The program data syntax for <ModulationFreq> is defined as a <DECIMAL NUMERIC PROGRAM DATA> element followed by an optional <SUFFIX PROGRAM DATA> element. The allowed <SUFFIX PROGRAM DATA> element is HZ.</p> <p>The <ModulationFreq> parameter is the new modulation frequency: 270, 1000, 2000, 100000 (Dither) or 0 (CW).</p>
Example(s)	<p>SOUR:POW:STAT ON SOUR:AM:INT:FREQ 2000Hz</p>
See Also	<p>SOURce[1..n]:AM:INTernal:FREQuency?</p>

:SOURce[1..n]:AM:INTernal: FREQUency?

Description	<p>This query returns a value indicating the current internal modulation frequency. If the source is in CW mode, the function will return 0.</p> <p>*RST sets the modulation frequency to 0 Hz (CW).</p>
Syntax	:SOURce[1..n]:AM:INTernal:FREQUency?
Parameter(s)	None
Response Syntax	<ModulationFrequency>
Response(s)	<p><i>ModulationFrequency:</i></p> <p>The response data syntax for <ModulationFrequency> is defined as a <NR3 NUMERIC RESPONSE DATA> element.</p> <p>The <ModulationFrequency> response is the internal modulation frequency of the source, in Hz. If the source is in CW mode, the returned value is 0.</p>
Example(s)	<p>SOUR:POW:STAT ON SOUR:AM:INT:FREQ 270 SOUR:AM:INT:FREQ?</p>
See Also	SOURce[1..n]:AM:INTernal:FREQUency

:SOURce[1..n]:POWer:ATTenuation

Description	<p>This command changes the internal attenuation of the source. The source power is at its maximum when the attenuation is set to 0.0 dB.</p> <p>*RST sets the attenuation to 0 dB.</p>
Syntax	<p>:SOURce[1..n]:POWer:ATTenuation<wsp><Attenuation[<wsp>DB]> MAXimum MINimum DEFault</p>
Parameter(s)	<p><i>Attenuation:</i></p> <p>The program data syntax for <Attenuation> is defined as a <numeric_value> element followed by an optional <SUFFIX PROGRAM DATA> element. The allowed <SUFFIX PROGRAM DATA> element is DB. The <Attenuation> special forms MINimum, MAXimum and DEFault are accepted on input.</p> <p>MINimum allows to set the instrument to the smallest supported value. MAXimum allows to set the instrument to the greatest supported value.</p> <p>DEFault allows the instrument to select a value for the <Attenuation> parameter.</p> <p>The <Attenuation> parameter is the new power attenuation in dB. The power attenuation is always a positive value.</p>

:SOURce[1..n]:POWER:ATTenuation

Example(s)	SOUR:POW:STAT ON SOUR:POW:ATT 2
Notes	Instrument must be in the Ready state to execute this command.
See Also	SOURce[1..n]:POWER:ATTenuation?

:SOURce[1..n]:POWer:ATTenuation?

Description	<p>This query returns a value corresponding to the internal power attenuation of the source.</p> <p>*RST sets the attenuation to 0 dB.</p>
Syntax	<p>:SOURce[1..n]:POWer:ATTenuation?[<wsp>MAXimum MINimum DEFAULT]</p>
Parameter(s)	<p><i>Parameter 1:</i></p> <p>The program data syntax for the first parameter is defined as a <CHARACTER PROGRAM DATA> element. The allowed <CHARACTER PROGRAM DATA> elements for this parameter are: MAXimum MINimum DEFAULT.</p> <p>MINimum is used to retrieve the instrument's smallest supported value. MAXimum is used to retrieve the instrument's greatest supported value. DEFAULT is used to retrieve the instrument's default value.</p>
Response Syntax	<p><Attenuation></p>

:SOURce[1..n]:POWer:ATTenuation?

Response(s)	<p><i>Attenuation:</i></p> <p>The response data syntax for <Attenuation> is defined as a <NR3 NUMERIC RESPONSE DATA> element.</p> <p>The <Attenuation> response is the power attenuation of the source, in dB.</p>
Example(s)	<p>SOUR:POW:STAT ON SOUR:POW:ATT 3 SOUR:POW:ATT?</p>
See Also	<p>SOURce[1..n]:POWer:ATTenuation</p>

SCPI Command Reference

Product-Specific Commands—Description

:SOURce[1..n]:POWER:STATE

Description	<p>This command turns the optical source on or off. When source is on, the red LED (Active) on the front of the instrument lights up.</p> <p>*RST sets the optical source to OFF.</p>
Syntax	<p>:SOURce[1..n]:POWER:STATe<wsp> <PowerState></p>
Parameter(s)	<p><i>PowerState:</i></p> <p>The program data syntax for <PowerState> is defined as a <Boolean Program Data> element. The <PowerState> special forms ON and OFF are accepted on input for increased readability. ON corresponds to 1 and OFF corresponds to 0.</p> <p>The <PowerState> parameter is the new power state of the source.</p>
Example(s)	<p>SOUR:POW:STAT ON</p>
Notes	<p>Instrument must be in the Ready state to execute this command.</p>
See Also	<p>SOURce[1..n]:POWER:STATE?</p>

:SOURce[1..n]:POWer:STATe?

Description	<p>This query returns a value indicating the state of the optical source (on or off).</p> <p>*RST sets the optical source to OFF.</p>
Syntax	:SOURce[1..n]:POWer:STATe?
Parameter(s)	None
Response Syntax	<PowerState>
Response(s)	<p><i>PowerState:</i></p> <p>The response data syntax for <PowerState> is defined as a <NR1 NUMERIC RESPONSE DATA> element.</p> <p>The <PowerState> response corresponds to the power state of the source, as follows:</p> <p>0, the optical source is off. 1, the optical source is on.</p>
Example(s)	<p>SOUR:POW:STAT OFF SOUR:POW:STAT?</p>
See Also	SOURce[1..n]:POWer:STATe

:SOURce[1..n]:POWER:WAVelength

Description	<p>This command selects a wavelength when using a dual-wavelength source instrument.</p> <p>*RST sets the selected wavelength to the LOW value.</p>
Syntax	<p>:SOURce[1..n]:POWER:WAVelength<wsp>UPPer LOWer</p>
Parameter(s)	<p><i>SelectedSources:</i></p> <p>The program data syntax for the first parameter is defined as a <CHARACTER PROGRAM DATA> element. The allowed <CHARACTER PROGRAM DATA> elements for this parameter are: UPPer LOWer.</p> <p>UPPer, switches to the highest wavelength. LOWer, switches to the lowest wavelength.</p>
Example(s)	<p>SOUR:POW:WAV LOW Wait 3 seconds. SOUR:POW:STAT ON</p>
Notes	<p>Instrument must be in the Ready state to execute this command. This command can cause the instrument to enter the Stabilizing state.</p>
See Also	<p>SOURce[1..n]:POWER:WAVelength? SOURce[1..n]:POWER:WAVelength:LOWer? SOURce[1..n]:POWER:WAVelength:UPPer?</p>

:SOURce[1..n]:POWER:WAVelength?

Description	<p>This query returns a value indicating which wavelength is currently selected.</p> <p>*RST sets the selected wavelength to the LOW value.</p>
Syntax	:SOURce[1..n]:POWER:WAVelength?
Parameter(s)	None
Response Syntax	<SelectedSources>
Response(s)	<p><i>SelectedSources:</i></p> <p>The response data syntax for <SelectedSources> is defined as a <CHARACTER RESPONSE DATA> element.</p> <p>LOWer, the lower wavelength is activated. UPPer, the upper wavelength is activated.</p>
Example(s)	SOUR:POW:WAV?
See Also	<p>SOURce[1..n]:POWER:WAVelength</p> <p>SOURce[1..n]:POWER:WAVelength:LOWer?</p> <p>SOURce[1..n]:POWER:WAVelength:UPPer?</p>

:SOURce[1..n]:POWER:WAVelength:COUNT?

Description	<p>This query returns the number of available wavelengths on the instrument.</p> <p>*RST has no effect on this command.</p>
Syntax	:SOURce[1..n]:POWER:WAVelength:COUNT?
Parameter(s)	None
Response Syntax	<NbWavelength>
Response(s)	<p><i>NbWavelength:</i></p> <p>The response data syntax for <NbWavelength> is defined as a <NR1 NUMERIC RESPONSE DATA> element.</p> <p>The <NbWavelength> response is the number of wavelengths available on the instrument:</p> <p>1, one wavelength available 2, two wavelengths available</p>
Example(s)	SOUR:POW:WAV:COUN?

:SOURce[1..n]:POWER:WAVelength: LOWer?

Description	<p>This query returns a value indicating the lower wavelength.</p> <p>*RST has no effect on this command.</p>
Syntax	:SOURce[1..n]:POWER:WAVelength:LOWer?
Parameter(s)	None
Response Syntax	<LowerWavelength>
Response(s)	<p><i>LowerWavelength:</i></p> <p>The response data syntax for <LowerWavelength> is defined as a <NR3 NUMERIC RESPONSE DATA> element.</p> <p>The <LowerWavelength> response is the lowest source wavelength value in meters.</p>
Example(s)	SOUR:POW:WAV:LOW?
Notes	If you do not have a dual-wavelength instrument, use this function to determine the wavelength of your source.
See Also	<p>SOURce[1..n]:POWER:WAVelength</p> <p>SOURce[1..n]:POWER:WAVelength?</p> <p>SOURce[1..n]:POWER:WAVelength:UPPer?</p>

:SOURce[1..n]:POWER:WAVelength:UPPer?

Description	This query returns a value indicating the upper wavelength. *RST has no effect on this command.
Syntax	:SOURce[1..n]:POWER:WAVelength:UPPer?
Parameter(s)	None
Response Syntax	<UpperWavelength>
Response(s)	<i>UpperWavelength:</i> The response data syntax for <UpperWavelength> is defined as a <NR3 NUMERIC RESPONSE DATA> element. The <UpperWavelength> response is the highest source wavelength value in meters.
Example(s)	SOUR:POW:WAV:UPP?
Notes	Not available on single-source instruments.
See Also	SOURce[1..n]:POWER:WAVelength SOURce[1..n]:POWER:WAVelength? SOURce[1..n]:POWER:WAVelength:LOWer?

:STATus?

Description This query returns a value indicating the status of the module (READY, BUSY, etc.).

Syntax

Parameter(s) None

Response Syntax

Response(s) *Status:*

Example(s) STAT? Returns READY (Module is ready.)

Index

A	
About function tab	50
activating the light source.....	30
active LED.....	1
after-sales service	49
application	
contacting EXFO support from	50
exiting	15
main window description	12
setting up	17
starting, single-module.....	12
viewing results.....	31
see also light source	
attenuation setting, light source	20
B	
Busy, module status	14
C	
caution	
of personal hazard.....	3
of product hazard.....	3
certification information	v
cleaning	
EUI connectors.....	42
fiber ends	27
fixed connectors	40
front panel.....	39
closing monitor window	38
configuration	
recall.....	24
save	24
connectors, cleaning	40, 42
contact information, EXFO.....	50
conventions, safety	3
customer service.....	50, 55
D	
deactivating the light source	30
dither mode.....	22
E	
equipment returns.....	55
EUI	
baseplate	29
connector adapter	29
EUI connectors, cleaning	42
EXFO support e-mail.....	50
EXFO universal interface. see EUI	
EXFO Web site	50
exiting application	15
F	
fiber ends, cleaning	27
firmware version, module.....	50
front panel description, light source.....	1
front panel, cleaning	39
H	
help. see online user guide	
I	
identification label.....	49
identification, slot	14
inserting a module	7
IQS-2100 Light Source. see light source	
L	
label, identification.....	49
LabVIEW drivers.....	2
LED push button	
location.....	1
problem with	47

Index

light source
 activating/deactivating 30
 available models 2
 connecting optical fiber 27
 front panel 1
 operating manually 27
 operating with QuickTools 37
 selecting a wavelength 17, 18
 setting the attenuation 20
 setting up 17

M

main window, application 12
maintenance
 EUI connectors 42
 fixed connectors 40
 front panel 39
 general information 39
modulation selection, light source 22
module
 insertion 7
 monitoring 33
 removal 7
 status 14
 see also light source
module information
 firmware version number 50
 module identification number 50
 serial number 50
module position 14
monitor window
 closing 38
 description 33
 opening 34
monitoring modules 33
mounting EUI connector adapter 29

O

online user guide 48
opening monitor window 34
operating the light source 27, 37

P

PDF. *see* online user guide
port, source 1
position, module 14
product
 identification label 49
 specifications 57

Q

QuickTools utility 33, 36

R

Ready, module status 14
recalling a configuration 24
remote control
 methods 2
 SCPI commands 59
removing a module 7
results, viewing 31
retaining screw knob location 1
return merchandise authorization (RMA) 55

S

safety
 caution 3
 conventions 3
 warning 3
saving configuration 24
selecting
 modulation, light source 22
 wavelength, light source 18
serial number, module 50
service and repairs 55
service centers 56
setting up
 attenuation, light source 20
 light source 17
shipping to EXFO 55
slot number 14
software. *see* application

source port..... 1
 source. see light source
 specifications, product 57
 status bar 14
 storage requirements 39
 symbols, safety..... 3

T

technical specifications..... 57
 technical support 49, 50
 temperature for storage..... 39
 title bar 14
 transportation requirements 39, 51

U

user guide. see online user guide

V

viewing results, using light source 31

W

warranty
 certification 54
 exclusions 54
 general 53
 liability..... 53
 wavelength selection, light source 18
 window, impossible to open 47

NOTICE

通告

CHINESE REGULATION ON RESTRICTION OF HAZARDOUS SUBSTANCES

中国关于有害物质限制的规定

NAMES AND CONTENTS OF THE TOXIC OR HAZARDOUS SUBSTANCES OR ELEMENTS

CONTAINED IN THIS EXFO PRODUCT



包含在本 EXFO 产品中的有毒有害物质或元素的名称和含量

O	Indicates that this toxic or hazardous substance contained in all of the homogeneous materials for this part is below the limit requirement in SJ/T11363-2006 表示该有毒有害物质在该部件所有均质材料中的含量均在 SJ/T11363-2006 标准规定的限量要求以下。
X	Indicates that this toxic or hazardous substance contained in at least one of the homogeneous materials used for this part is above the limit requirement in SJ/T11363-2006 表示该有毒有害物质至少在该部件的某一均质材料中的含量超出 SJ/T11363-2006 标准规定的限量要求。

Part Name 部件名称	Toxic or hazardous Substances and Elements 有毒有害物质和元素					
	Lead 铅 (Pb)	Mercury 汞 (Hg)	Cadmium 镉 (Cd)	Hexavalent Chromium 六价铬 (Cr VI)	Polybrominated biphenyls 多溴联苯 (PBB)	Polybrominated diphenyl ethers 多溴二苯醚 (PBDE)
Enclosure 外壳	O	O	O	O	O	O
Electronic and electrical sub-assembly 电子和电子组件	X	O	X	O	X	X
Optical sub-assembly ^a 光学组件 ^a	X	O	O	O	O	O
Mechanical sub-assembly ^a 机械组件 ^a	O	O	O	O	O	O

a. If applicable.
如果适用。

MARKING REQUIREMENTS
标注要求

Product 产品	Environmental protection use period (years) 环境保护使用期限 (年)	Logo 标志
This EXFO product 本 EXFO 产品	10	
Battery ^a 电池 ^a	5	

a. If applicable.
如果适用。

P/N: 1068463

www.EXFO.com · info@exfo.com

CORPORATE HEADQUARTERS	400 Godin Avenue	Quebec (Quebec) G1M 2K2 CANADA Tel.: 1 418 683-0211 · Fax: 1 418 683-2170
EXFO AMERICA	3400 Waterview Parkway Suite 100	Richardson, TX 75080 USA Tel.: 1 972-761-9271 · Fax: 1 972-761-9067
EXFO EUROPE	Winchester House, School Lane	Chandlers Ford, Hampshire S053 4DG ENGLAND Tel.: +44 2380 246 800 · Fax: +44 2380 246 801
EXFO ASIA-PACIFIC	62 Ubi Road 1, #09-01/02 Oxley Bizhub 2	SINGAPORE 408734 Tel.: +65 6333 8241 · Fax: +65 6333 8242
EXFO CHINA	Beijing Global Trade Center, Tower C, Room 1207, 36 North Third Ring Road East, Dongcheng District	Beijing 100013 P. R. CHINA Tel.: +86 (10) 5825 7755 · Fax: +86 (10) 5825 7722
EXFO SERVICE ASSURANCE	270 Billerica Road	Chelmsford MA, 01824 USA Tel.: 1 978 367-5600 · Fax: 1 978 367-5700
EXFO FINLAND	Elektroniikkatie 2	FI-90590 Oulu, FINLAND Tel.: +358 (0) 403 010 300 · Fax: +358 (0) 8 564 5203
TOLL-FREE	(USA and Canada)	1 800 663-3936

© 2015 EXFO Inc. All rights reserved.
Printed in Canada (2015-07)



EXFO
EXPERTISE REACHING OUT