

MaxTester Series



Copyright © 2013–2022 EXFO Inc. All rights reserved. No part of this publication may be reproduced, stored in a retrieval system or transmitted in any form, be it electronically, mechanically, or by any other means such as photocopying, recording or otherwise, without the prior written permission of EXFO Inc. (EXFO).

Information provided by EXFO is believed to be accurate and reliable. However, no responsibility is assumed by EXFO for its use nor for any infringements of patents or other rights of third parties that may result from its use. No license is granted by implication or otherwise under any patent rights of EXFO.

EXFO's Commerce And Government Entities (CAGE) code under the North Atlantic Treaty Organization (NATO) is 0L8C3.

The information contained in this publication is subject to change without notice.

Trademarks

EXFO's trademarks have been identified as such. However, the presence or absence of such identification does not affect the legal status of any trademark.

Where applicable, the Bluetooth® word mark and logos are registered trademarks owned by Bluetooth SIG, Inc. and any use of such marks by EXFO Inc. is under license. Other third party trademarks and trade names are those of their respective owners.

Units of Measurement

Units of measurement in this publication conform to SI standards and practices.

Patents

The exhaustive list of patents is available at EXFO.com/patent.

Version number: 9.0.0.1

End-User License Agreement

You have acquired a device ("DEVICE") that includes software licensed by EXFO Inc. (EXFO) from an affiliate of Microsoft Corporation ("MS"). Those installed software products of MS origin, as well as associated media, printed materials, and "online" or electronic documentation ("SOFTWARE") are protected by international intellectual property laws and treaties. Manufacturer, MS and its suppliers (including Microsoft Corporation) own the title, copyright, and other intellectual property rights in the SOFTWARE. The SOFTWARE is licensed, not sold. All rights reserved.

This EULA is valid and grants the end-user rights ONLY if the SOFTWARE is genuine and a genuine Certificate of Authenticity for the SOFTWARE is included. For more information on identifying whether your software is genuine, please see <http://www.microsoft.com/piracy/howtotell>.

IF YOU DO NOT AGREE TO THIS END USER LICENSE AGREEMENT ("EULA"), DO NOT USE THE DEVICE OR COPY THE SOFTWARE. INSTEAD, PROMPTLY CONTACT EXFO FOR INSTRUCTIONS ON RETURN OF THE UNUSED DEVICE(S) FOR A REFUND. **ANY USE OF THE SOFTWARE, INCLUDING BUT NOT LIMITED TO USE ON THE DEVICE, WILL CONSTITUTE YOUR AGREEMENT TO THIS EULA (OR RATIFICATION OF ANY PREVIOUS CONSENT).**

GRANT OF SOFTWARE LICENSE. This EULA grants you the following license:

- You may use the SOFTWARE only on the DEVICE.
- **Restricted Functionality.** You are licensed to use the SOFTWARE to provide only the limited functionality (specific tasks or processes) for which the DEVICE has been designed and marketed by EXFO. This license specifically prohibits any other use of the software programs or functions, or inclusion of additional software programs or functions that do not directly support the limited functionality on the DEVICE. Notwithstanding the foregoing, you may install or enable on a DEVICE, systems utilities, resource management or similar software solely for the purpose of administration, performance enhancement and/or preventive maintenance of the DEVICE.
- If you use the DEVICE to access or utilize the services or functionality of Microsoft Windows Server products (such as Microsoft Windows Server 2003), or use the DEVICE to permit workstation or computing devices to access or utilize the services or functionality of Microsoft Windows Server products, you may be required to obtain a Client Access License for the DEVICE and/or each such workstation or computing device. Please refer to the end user license agreement for your Microsoft Windows Server product for additional information.
- **NOT FAULT TOLERANT.** THE SOFTWARE IS NOT FAULT TOLERANT. EXFO HAS INDEPENDENTLY DETERMINED HOW TO USE THE SOFTWARE IN THE DEVICE, AND MS HAS RELIED UPON EXFO TO CONDUCT SUFFICIENT TESTING TO DETERMINE THAT THE SOFTWARE IS SUITABLE FOR SUCH USE.
- **NO WARRANTIES FOR THE SOFTWARE.** THE SOFTWARE is provided "AS IS" and with all faults. THE ENTIRE RISK AS TO SATISFACTORY QUALITY, PERFORMANCE, ACCURACY, AND EFFORT (INCLUDING LACK OF NEGLIGENCE) IS WITH YOU. ALSO, THERE IS NO WARRANTY AGAINST INTERFERENCE WITH YOUR ENJOYMENT OF THE SOFTWARE OR AGAINST INFRINGEMENT. IF YOU HAVE RECEIVED ANY WARRANTIES REGARDING THE DEVICE OR THE SOFTWARE, THOSE WARRANTIES DO NOT ORIGINATE FROM, AND ARE NOT BINDING ON, MS.
- **No Liability for Certain Damages. EXCEPT AS PROHIBITED BY LAW, MS SHALL HAVE NO LIABILITY FOR ANY INDIRECT, SPECIAL, CONSEQUENTIAL OR INCIDENTAL DAMAGES ARISING FROM OR IN CONNECTION WITH THE USE OR PERFORMANCE OF THE SOFTWARE. THIS LIMITATION SHALL APPLY EVEN IF ANY REMEDY FAILS OF ITS ESSENTIAL PURPOSE. IN NO EVENT SHALL MS BE LIABLE FOR ANY AMOUNT IN EXCESS OF U.S. TWO HUNDRED FIFTY DOLLARS (U.S.\$250.00).**
- **Restricted Uses.** The SOFTWARE is not designed or intended for use or resale in hazardous environments requiring fail-safe performance, such as in the operation of nuclear facilities, aircraft navigation or communication systems, air traffic control, or other devices or systems in which a malfunction of the SOFTWARE would result in foreseeable risk of injury or death to the operator of the device or system, or to others.
- **Limitations on Reverse Engineering, Decompilation, and Disassembly.** You may not reverse engineer, decompile, or disassemble the SOFTWARE, except and only to the extent that such activity is expressly permitted by applicable law notwithstanding this limitation.
- **SOFTWARE as a Component of the DEVICE - Transfer.** This license may not be shared, transferred to or used concurrently on different computers. The SOFTWARE is licensed with the DEVICE as a single integrated product and may only be used with the DEVICE. If the SOFTWARE is not accompanied by a DEVICE, you may not use the SOFTWARE. You may permanently transfer all of your rights under this EULA only as part of a permanent sale or transfer of the DEVICE, provided you retain no copies of the SOFTWARE. If the SOFTWARE is an upgrade, any transfer must also include all prior versions of the SOFTWARE. This transfer must also include the Certificate of Authenticity label. The transfer may not be an indirect transfer, such as a consignment. Prior to the transfer, the end user receiving the SOFTWARE must agree to all the EULA terms.
- **Consent to Use of Data.** You agree that MS, Microsoft Corporation and their affiliates may collect and use technical information gathered in any manner as part of product support services related to the SOFTWARE. MS, Microsoft Corporation and their affiliates may use this information solely to improve their products or to provide customized services or technologies to you. MS, Microsoft Corporation and their affiliates may disclose this information to others, but not in a form that personally identifies you.

-
- **Internet Gaming/Update Features.** If the SOFTWARE provides, and you choose to utilize, the Internet gaming or update features within the SOFTWARE, it is necessary to use certain computer system, hardware, and software information to implement the features. By using these features, you explicitly authorize MS, Microsoft Corporation and/or their designated agent to use this information solely to improve their products or to provide customized services or technologies to you. MS or Microsoft Corporation may disclose this information to others, but not in a form that personally identifies you.
 - **Internet-Based Services Components.** The SOFTWARE may contain components that enable and facilitate the use of certain Internet-based services. You acknowledge and agree that MS, Microsoft Corporation or their affiliates may automatically check the version of the SOFTWARE and/or its components that you are utilizing and may provide upgrades or supplements to the SOFTWARE that may be automatically downloaded to your DEVICE. Microsoft Corporation or their affiliates do not use these features to collect any information that will be used to identify you or contact you. For more information about these features, please see the privacy statement at <http://go.microsoft.com/fwlink/?LinkId=25243>.
 - **Links to Third Party Sites.** You may link to third party sites through the use of the SOFTWARE. The third party sites are not under the control of MS or Microsoft Corporation, and MS or Microsoft are not responsible for the contents of any third party sites, any links contained in third party sites, or any changes or updates to third party sites. MS or Microsoft Corporation is not responsible for webcasting or any other form of transmission received from any third party sites. MS or Microsoft Corporation are providing these links to third party sites to you only as a convenience, and the inclusion of any link does not imply an endorsement by MS or Microsoft Corporation of the third party site.
 - **Notice Regarding Security.** To help protect against breaches of security and malicious software, periodically back up your data and system information, use security features such as firewalls, and install and use security updates.
 - **No Rental/Commercial Hosting.** You may not rent, lease, lend or provide commercial hosting services with the SOFTWARE to others.
 - **Separation of Components.** The SOFTWARE is licensed as a single product. Its component parts may not be separated for use on more than one computer.
 - **Additional Software/Services.** This EULA applies to updates, supplements, add-on components, product support services, or Internet-based services components ("Supplemental Components"), of the SOFTWARE that you may obtain from EXFO, MS, Microsoft Corporation or their subsidiaries after the date you obtain your initial copy of the SOFTWARE, unless you accept updated terms or another agreement governs. If other terms are not provided along with such Supplemental Components and the Supplemental Components are provided to you by MS, Microsoft Corporation or their subsidiaries then you will be licensed by such entity under the same terms and conditions of this EULA, except that (i) MS, Microsoft Corporation or their subsidiaries providing the Supplemental Components will be the licensor with respect to such Supplemental Components in lieu of the "COMPANY" for the purposes of the EULA, and (ii) TO THE MAXIMUM EXTENT PERMITTED BY APPLICABLE LAW, THE SUPPLEMENTAL COMPONENTS AND ANY (IF ANY) SUPPORT SERVICES RELATED TO THE SUPPLEMENTAL COMPONENTS ARE PROVIDED AS IS AND WITH ALL FAULTS. ALL OTHER DISCLAIMERS, LIMITATION OF DAMAGES, AND SPECIAL PROVISIONS PROVIDED BELOW AND/OR OTHERWISE WITH THE SOFTWARE SHALL APPLY TO SUCH SUPPLEMENTAL COMPONENTS. MS, Microsoft Corporation or their subsidiaries reserve the right to discontinue any Internet-based services provided to you or made available to you through the use of the SOFTWARE.
 - **Recovery Media.** If SOFTWARE is provided by EXFO on separate media and labeled "Recovery Media" you may use the Recovery Media solely to restore or reinstall the SOFTWARE originally installed on the DEVICE.
 - **Backup Copy.** You may make one (1) backup copy of the SOFTWARE. You may use this backup copy solely for your archival purposes and to reinstall the SOFTWARE on the DEVICE. Except as expressly provided in this EULA or by local law, you may not otherwise make copies of the SOFTWARE, including the printed materials accompanying the SOFTWARE. You may not loan, rent, lend or otherwise transfer the backup copy to another user.
 - **End User Proof of License.** If you acquired the SOFTWARE on a DEVICE, or on a compact disc or other media, a genuine Microsoft "Proof of License"/Certificate of Authenticity label with a genuine copy of the SOFTWARE identifies a licensed copy of the SOFTWARE. To be valid, the label must be affixed to the DEVICE, or appear on [COMPANY's] software packaging. If you receive the label separately other than from EXFO, it is invalid. You should keep the label on the DEVICE or packaging to prove that you are licensed to use the SOFTWARE.
 - **Product Support.** Product support for the SOFTWARE is not provided by MS, Microsoft Corporation, or their affiliates or subsidiaries. For product support, please refer to EXFO support number provided in the documentation for the DEVICE. Should you have any questions concerning this EULA, or if you desire to contact EXFO for any other reason, please refer to the address provided in the documentation for the DEVICE.
 - **Termination.** Without prejudice to any other rights, EXFO may terminate this EULA if you fail to comply with the terms and conditions of this EULA. In such event, you must destroy all copies of the SOFTWARE and all of its component parts.
 - **EXPORT RESTRICTIONS.** You acknowledge that SOFTWARE is subject to U.S. and European Union export jurisdiction. You agree to comply with all applicable international and national laws that apply to the SOFTWARE, including the U.S. Export Administration Regulations, as well as end-user, end-use and destination restrictions issued by U.S. and other governments. For additional information see <http://www.microsoft.com/exporting/>.

Contents

Regulatory Information	viii
1 Introducing the MaxTester Series Unit	1
Main Features	1
LED Indicator Description	5
Function Buttons Description	6
Power Sources	7
Technical Specifications	7
Conventions	8
2 Safety Information	9
Other Safety Symbols on Your Unit	11
Laser Safety Information	12
Electrical Safety Information	13
3 Getting Started with Your Unit	17
Using the Built-In Supports	17
Installing and Using the Optional Stand	18
Turning On or Off the Unit	22
Configuring Your Unit At First Startup	24
Navigating Through the Applications	27
Using the On-Screen (Virtual) Keyboard	29
Installing or Upgrading the Applications	30
Activating Software Options	35
Using a Keyboard, Mouse or Other USB Devices	38

Contents

4	Setting Up Your Unit	41
	Adjusting Brightness	41
	Adjusting the Date, Time and Time Zone	43
	Selecting the Language of Operation	44
	Selecting the Layout of the On-Screen Keyboard	46
	Selecting the Global Language Format (Locale)	49
	Setting Date and Time Formats	51
	Setting the Decimal Separator	52
	Changing the Background Picture	53
	Configuring the Power Management Options	57
	Configuring the Internet Options	59
	Recalibrating the Touchscreen	60
	Selecting the Startup Application	62
	Configuring the Network Settings	64
	Using Password Protection for Your Unit	66
5	Working with Your Unit	77
	Accessing the Online Documentation	77
	Taking Screen Captures	82
	Setting Storage Parameters for Screen Captures	84
	Browsing the Web	88
6	Using the Optional Built-In Power Meter and VFL	91
7	Inspecting Fibers with a Probe	93
8	Managing Data	95
	Viewing Disk Space and Managing Files	95
	Transferring Data via Bluetooth	96
	Connecting to a Wireless Network	106
	Enabling or Disabling the Wi-Fi and Bluetooth Module	112
	Managing Security Certificates	114
	Transferring Files with the Data Mover Application	115
9	Accessing Your Unit Remotely	121
	Configuring the VNC Server	123
	Installing the TightVNC Viewer on a Client Computer	127
	Connecting to Your Unit with TightVNC	128
	Configuring VNC Server to Start Automatically	130

10 Maintenance	131
Cleaning Detector Ports	132
Cleaning VFL-Type Connectors	133
Cleaning the Touchscreen of Your Unit	134
Battery Safety Recommendations	134
Recharging the Battery	135
Replacing the Battery	138
Installing or Removing the Power Meter and VFL	139
Recycling and Disposal	146
11 Troubleshooting	147
Solving Common Problems	147
Restoring Your Unit to Normal Operation	152
Contacting the Technical Support Group	155
Viewing System Information	156
Transportation	159
12 Warranty	161
General Information	161
Gray Market and Gray Market Products	162
Liability	163
Exclusions	164
Certification	164
Service and Repairs	165
EXFO Service Centers Worldwide	166
Index	167

Regulatory Information

USA Electromagnetic Interference Regulatory Statement

Electronic test and measurement equipment is exempt from FCC part 15, subpart B compliance in the United States of America. However, EXFO Inc. makes reasonable efforts to ensure compliance to the applicable standards.

The limits set by these standards are designed to provide reasonable protection against harmful interference when the equipment is operated in a commercial environment. This equipment generates, uses, and can radiate radio frequency energy and, if not installed and used in accordance with the user documentation, may cause harmful interference to radio communications. Operation of this equipment in a residential area is likely to cause harmful interference in which case the user will be required to correct the interference at his own expense.

Modifications not expressly approved by the manufacturer could void the user's authority to operate the equipment.

Note: *The compliance to EN 55022 has been achieved by using a Laird Technology ferrite (number 28A2736-0A2) on the Ethernet cable.*

Canada Electromagnetic Interference Regulatory Statement

This equipment generates, uses, and can radiate radio frequency energy and, if not installed and used in accordance with the instruction manual, may cause harmful interference to radio communications. Operation of this equipment in a residential area is likely to cause harmful interference.

Cet équipement génère, utilise et peut émettre de l'énergie radio-fréquence et, s'il n'est pas installé et utilisé conformément à la documentation de l'utilisateur, il peut occasionner une interférence néfaste aux communications radio. L'utilisation de cet équipement dans une zone résidentielle est susceptible d'occasionner une interférence néfaste.

Caution: This equipment is not intended for use in residential environments and may not provide adequate protection to radio reception in such environments.

Attention: Cet appareil n'est pas destiné à être utilisé dans des environnements résidentiels et peut ne pas assurer la protection adéquate à la réception radioélectrique dans ce type d'environnements.

This is a class A, group 1 product.

- **Class A equipment:** Equipment that is, by virtue of its characteristics, highly unlikely to be used in a residential environment, including a home business shall be classified as class A and shall comply with the class A limits specified in the applicable ICES standard. Characteristics considered in this assessment include price, marketing and advertising methodology, the degree to which the functional design inhibits applications suitable to residential environments, or any combination of features that would effectively preclude the use of such equipment in a residential environment.

Classe A: Matériel qui, en raison de ses caractéristiques, ne sera fort probablement pas utilisé dans un milieu domiciliaire ni par des entreprises établies à domicile. Parmi les caractéristiques considérées dans cette évaluation, il y a le prix, les méthodes de commercialisation et de publicité, la mesure dans laquelle les fonctions de l'appareil font qu'il ne se prête pas à des applications convenant au milieu domiciliaire ou toute combinaison de ces caractéristiques qui aurait pour conséquence d'en prévenir effectivement l'utilisation à domicile. Utilisé également pour indiquer les limites d'émission correspondantes qui s'appliquent à un tel matériel.

Regulatory Information

- Group 1 equipment: group 1 contains all equipment which is not classified as group 2 equipment, and includes equipment such as laboratory and scientific equipment, industrial process, measurement and control equipment.

Group 2 equipment: group 2 contains all ISM RF equipment in which radio-frequency energy in the frequency range 9 kHz to 400 GHz is intentionally generated and used or only used locally, in the form of electromagnetic radiation, inductive and/or capacitive coupling, for the treatment of material for inspection/analysis purposes, or for transfer of electromagnetic energy.

Appareils du groupe 1 : le groupe 1 réunit tous les appareils compris dans le domaine d'application de la présente Norme, qui ne sont pas classés comme étant des appareils du groupe 2. Le groupe 1 inclut les appareils scientifiques et de laboratoire, les processus industriels, appareils de mesure ou de contrôle.

Appareils du groupe 2 : le groupe 2 réunit tous les appareils ISM à fréquences radioélectriques dans lesquels de l'énergie à fréquences radioélectriques dans la plage de fréquences comprises entre 9 kHz et 400 GHz est produite et utilisée volontairement ou uniquement utilisée localement sous forme de rayonnement électromagnétique, de couplage inductif et/ou capacitif, pour le traitement de la matière, à des fins d'examen ou d'analyse ou pour le transfert d'énergie électromagnétique.

Supplier's Declaration of Conformity (SDoC)

The SDoC for your product is as follows:

CAN ICES-001 (A) / NMB-001 (A)

European Electromagnetic Compatibility Regulatory Statement

Warning: This is a class A product. In a domestic environment, this product may cause radio interference in which case the user may be required to take adequate measures. Your product is suitable for use in industrial electromagnetic environments.

General Wireless Compliance Related Information

If you purchased the Wi-Fi and Bluetooth option, your unit comes with an internal wireless module (adapter) and antenna for which the information hereafter applies:

This product does not contain any wireless user-serviceable components. Any unauthorized product changes or modifications will invalidate warranty and all applicable regulatory certifications and approvals.

Canada and USA Wireless Compliance Related Information

If you purchased the Wi-Fi and Bluetooth option, your unit comes with an internal wireless module (adapter) and antenna for which the information hereafter applies:

- This device complies with Part 15 of the FCC Rules.
- This device complies with Innovation, Sciences and Economic Development Canada license-exempt RSS standards.
- Operation is subject to the following two conditions:
 - (1) This device may not cause harmful interference
 - and
 - (2) this device must accept any interference received, including interference that may cause undesired operation.

Regulatory Information

Use in Specific Environments:

- The use of wireless products in hazardous locations is limited by the constraints posed by the safety directors of such environments.
- The use of wireless products on airplanes is governed by the Federal Aviation Administration (FAA).
- The use of wireless products in hospitals is restricted to the limits set forth by each hospital.
- Do not operate a portable transmitter near unshielded blasting caps or in an explosive environment.
- This wireless product is restricted to indoor use due to its operation in the 5.15 to 5.25 GHz and 5.470 to 5.75 GHz frequency ranges.
- Innovation, Sciences and Economic Development Canada requires this product to be used indoors for the frequency range of 5.15 GHz to 5.25 GHz to reduce the potential for harmful interference to co-channel mobile satellite systems.
- High-power radars are allocated as the primary users of the 5.25 to 5.35 GHz, and 5.65 to 5.85 GHz bands. These radar stations can cause interference with and/or damage to this device.

Radiation Exposure Statement:

- The product complies with the US/Canada portable RF exposure limit set forth for an uncontrolled environment and is safe for intended operation as described in this user documentation.
- Further RF exposure reduction can be achieved if the device can be kept as far as possible from the user's body.

European Wireless Compliance Related Information

The information about the Bluetooth and Wi-Fi frequency bands is as follows:

- Bluetooth: Between the frequencies 2400.0 MHz - 2483.5 MHz.
The output power is -0.5 dBm typical.
- Wi-Fi: Between the frequencies 2400.0 MHz - 2483.5 MHz.
The maximum output power is 17 dBm.
- Wi-Fi: Between the frequencies 5150.0 MHz - 5825.0 MHz.
The maximum output power is 17 dBm.

This is a 2.4 GHz and 5 GHz wideband transmission system (transceiver), intended for use in all EU member states and EFTA countries, except in France and Italy where restrictive use applies.

In Italy, the end-user should apply for a license at the national spectrum authorities in order to obtain authorization to use the device for setting up outdoor radio links and/or for supplying access to telecommunications and/or network services.

This device may not be used for setting up radio links in France, and in some areas the RF output power may be limited to 10 mW EIRP in the frequency range of 2454 - 2483.5 MHz. For detailed information, the end-user should contact the national spectrum authority in France. In the European Union, the low band 5.15 - 5.35 GHz is for indoor use only.

Local Restrictions on 802.11a, 802.11b, 802.11d, 802.11g, 802.11n, and 802.11ac Radio Usage

Due to the fact that the frequencies used by 802.11a, 802.11b, 802.11d, 802.11g, 802.11n, and 802.11ac wireless LAN devices may not yet be harmonized in all countries, 802.11a, 802.11b, 802.11d, 802.11g, 802.11n, and 802.11ac products are designed for use only in specific countries, and are not allowed to be operated in countries other than those of designated use. As a user of these products, you are responsible for ensuring that the products are used only in the countries for which they were intended and for verifying that they are configured with the correct selection of frequency and channel for the country of use.

European Declaration of Conformity

Hereby, EXFO declares that the radio equipment type “MaxTester Series” is in compliance with European Directive 2014/53/EU.

The full text of the EU declaration of conformity is available at the following Internet address: www.exfo.com/en/resources/legal-documentation.

1 Introducing the MaxTester Series Unit

Note: *The appearance of your applications and tools may vary from the ones presented in this documentation, depending on the unit model and the options that you have purchased.*

Note: *In this documentation, the words “tap” and “double-tap” (related to the use of a touchscreen) replace the words “click” and “double-click”.*

Main Features

Your MaxTester Series unit includes the following:

- Seven-inch color touchscreen
- Two USB 2.0 ports (host)
- Ethernet port (10/100 Base-T)
- Optional internal Wi-Fi and Bluetooth module
- Windows Embedded Compact operating system
- Optional built-in power meter and VFL
- Battery autonomy of 12 hours
- Multitasking possibilities
- Remote access to your unit (via VNC)
- Direct Web access from your unit
- Possibility to take screen captures
- PDF file viewer available from your unit
- Easy transfer of files and folders to an external storage device
- Easy software updates
- EXFO Connect Client

Introducing the MaxTester Series Unit

Main Features

Front

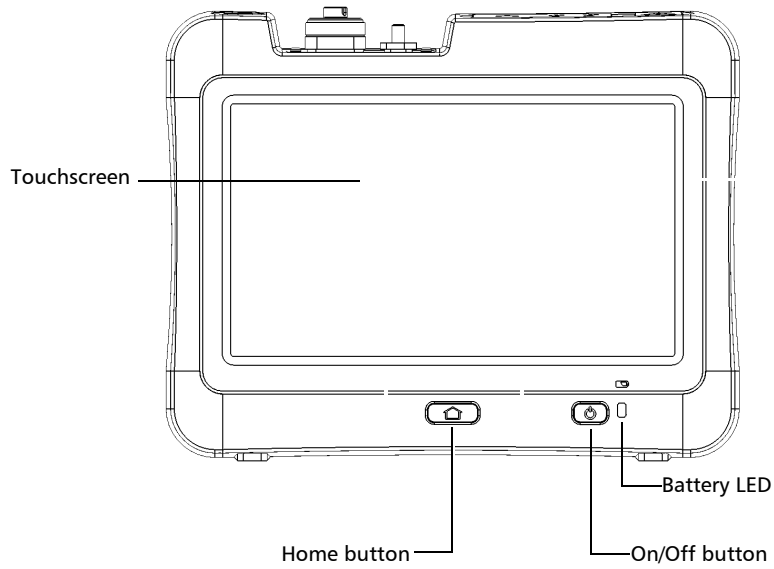

Back

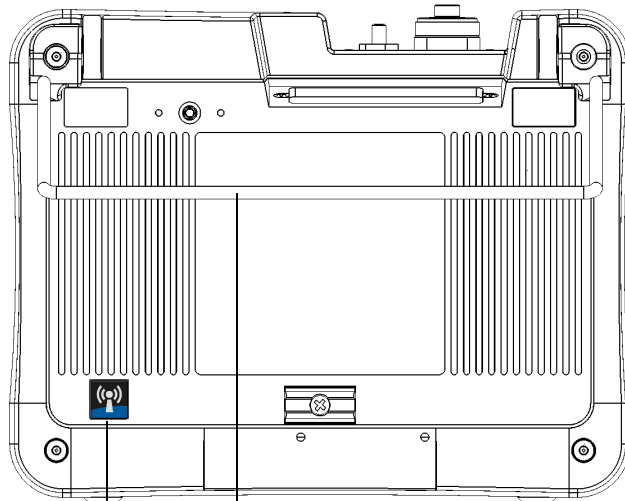

Optional stand (to modify the position of the unit);
not assembled on the unit at time of shipment

Internal Wi-Fi and Bluetooth module
(optional; sticker indicates that module is present)

Introducing the MaxTester Series Unit

Main Features

Top

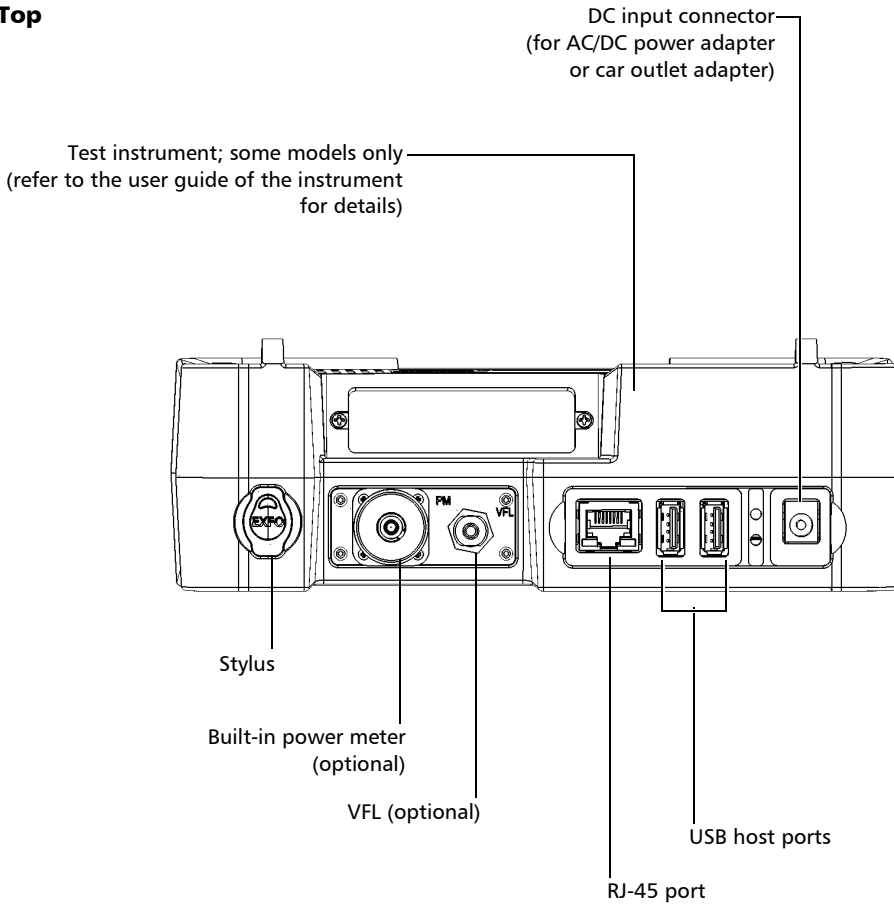

LED Indicator Description

There is one LED indicator located on the front panel of your unit, providing you with information about the battery.

This LED is identified by the  symbol.



The LED blinks when the battery is charging and its color changes according to the charge level of the battery, as explained in the table below.

Color of the LED	Meaning
Green	Battery level is between 25 % and 100 %.
Yellow	Battery level is between 10 % and 24 %.
Red	<p>Battery level is low (less than 10 %).</p> <ul style="list-style-type: none"> ➤ A rapid blinking LED indicates that the unit's temperature is out of the operating specifications, or that the battery has reached a critically low level and needs to be recharged. ➤ A slow blinking LED indicates that the adapter/charger in use has the wrong voltage for your unit. Ensure that you use the adapter/charger provided with your unit (see <i>Electrical Safety Information</i> on page 13 for more information).
None (LED is off)	<ul style="list-style-type: none"> ➤ Unit is powered by battery and the unit is in Suspend mode. ➤ Unit is off. ➤ Unit is powered by battery and the battery is empty.

Function Buttons Description

Your unit is equipped with function buttons which give you access to various tools at all times.

The table below shows an overview of their purpose.

Button	Meaning
	<ul style="list-style-type: none">▶ Press the button to switch between the Home screen and the last used application. Note: <i>If a keyboard is connected to your unit, or if you are controlling your unit remotely via VNC, you can also press CTRL + HOME.</i>▶ Press and hold the button to display a shortcut from which you can take a screen capture, or adjust brightness to the medium or maximum level. Note: <i>If a keyboard is connected to your unit, or if you are controlling your unit remotely via VNC, you can also press CTRL + ALT + HOME.</i>
	<p>Turns your unit on and off:</p> <ul style="list-style-type: none">▶ Suspend: Press the button. The unit's backlight will turn off.▶ Shutdown: Press and hold the button a few seconds until the unit beeps once. <p>For more information on the various ways to turn on and off your unit, see <i>Turning On or Off the Unit</i> on page 22.</p>

Note: *When you are connected via VNC, due to the normal remote control delays, it may take a few seconds before the unit processes the combination of keys.*

Power Sources

Your unit operates with the following power sources:

- AC/DC power adapter (connected to standard power outlet—indoor use only). Compatible car outlet adapter available upon request.
- One lithium-polymer rechargeable battery (automatically takes over if you disconnect the unit from its external power source).
 - Possible to switch from an external power source to battery power or vice versa without affecting operation.
 - The battery recharges automatically when the unit is connected to an external power source (with the AC/DC power adapter or car outlet adapter).

Note: *The battery will not recharge when the ambient temperature is below 5 °C (41 °F) or above 40 °C (104 °F).*

Note: *When the unit is powered by battery and the battery level becomes critically low, the unit will be shut down and unsaved data will be lost.*

For more information, see *Electrical Safety Information* on page 13.

Technical Specifications

To obtain this product's technical specifications, visit the EXFO Web site at www.exfo.com.

Conventions

Before using the product described in this guide, you should understand the following conventions:



WARNING

Indicates a potentially hazardous situation which, if not avoided, could result in *death or serious injury*. Do not proceed unless you understand and meet the required conditions.



CAUTION

Indicates a potentially hazardous situation which, if not avoided, may result in *minor or moderate injury*. Do not proceed unless you understand and meet the required conditions.



CAUTION

Indicates a potentially hazardous situation which, if not avoided, may result in *component damage*. Do not proceed unless you understand and meet the required conditions.



IMPORTANT

Refers to information about this product you should not overlook.

2 **Safety Information**



WARNING

Do not install or terminate fibers while a light source is active. Never look directly into a live fiber and ensure that your eyes are protected at all times.



WARNING

The use of controls, adjustments and procedures, namely for operation and maintenance, other than those specified herein may result in hazardous radiation exposure or impair the protection provided by this unit.



WARNING

If the equipment is used in a manner not specified by the manufacturer, the protection provided by the equipment may be impaired.



WARNING

Use only accessories designed for your unit and approved by EXFO. For a complete list of accessories available for your unit, refer to its technical specifications or contact EXFO.



IMPORTANT

Refer to the documentation provided by the manufacturers of any accessories used with your EXFO product. It may contain environmental and/or operating conditions limiting their use.



IMPORTANT



When you see the following symbol on your unit , make sure that you refer to the instructions provided in your user documentation. Ensure that you understand and meet the required conditions before using your product.



IMPORTANT



When you see the following symbol on your unit , it indicates that the unit is equipped with a laser source, or that it can be used with instruments equipped with a laser source. These instruments include, but are not limited to, modules and external optical units.













IMPORTANT

Other safety instructions relevant for your product are located throughout this documentation, depending on the action to perform. Make sure to read them carefully when they apply to your situation.

Other Safety Symbols on Your Unit

One or more of the following symbols may also appear on your unit.

Symbol	Meaning
	Direct current
	Alternating current
	The unit is equipped with an earth (ground) terminal.
	The unit is equipped with a protective conductor terminal.
	The unit is equipped with a frame or chassis terminal.
	On (Power)
	Off (Power)
 OR 	On/off (Power)
	Fuse

Laser Safety Information

Units with Built-In VFL

Your instrument is in compliance with standard IEC 60825-1: 2014.

Laser radiation may be encountered at the optical output port.

The following label(s) indicate that the product contains a Class 2 source:

The following symbol means
"DO NOT STARE INTO THE BEAM".



Units without Built-In VFL

Your instrument is in compliance with standard IEC 60825-1: 2014.

If your unit is not equipped with a VFL, refer to the user guide of the test instrument (when applicable) for further laser safety details and instructions.

Electrical Safety Information

Your unit uses an external AC/DC power adapter connected to an international safety standard three-wire power cable.



WARNING

If you need to ensure that the unit is completely turned off, disconnect the power cable and remove the battery. For more information on how to remove the battery, see the section about replacing the battery in this user documentation.

Note: *There is no need to remove the battery before inserting or removing a power meter or a VFL, but you need to follow the instructions provided in the user documentation carefully.*



WARNING

- Use the external power supply (AC/DC power adapter) indoors only.
- Operation of any electrical instrument around flammable gases or fumes constitutes a major safety hazard.
- To avoid electrical shock, do not operate the unit if any part of the outer surface (covers, panels, etc.) is damaged.
- Only authorized personnel should carry out adjustments, maintenance or repair of opened units under voltage. A person qualified in first aid must also be present. Do not replace any components while the power cable and battery are connected. There is no need to remove the battery before inserting or removing a power meter or a VFL, but you need to follow the instructions provided in the user documentation carefully.

Safety Information

Electrical Safety Information



WARNING

- Unless otherwise specified, all interfaces are intended for connection to ES1 circuits only.
- Capacitors inside the unit may be charged even if the unit has been disconnected from its electrical supply.
- Use only the listed and certified AC/DC power adapter provided by EXFO with your unit. It provides reinforced insulation between primary and secondary, and is suitably rated for the country where the unit is sold.
- Use only the car outlet adapter designed for your unit and approved by EXFO. The car outlet adapter contains a replaceable fuse. Replace the damaged fuse **ONLY** with a fuse of the same type: 3AG certified, 16 VDC, 3 A, with an I²t between 40 A²sec and 80 A²sec.



CAUTION

- Position the unit so that the air can circulate freely around it.
- When you use the unit outdoors, ensure that it is protected from liquids, dust, direct sunlight, precipitation, and full wind pressure.

Equipment Ratings

Temperature

➤ Operation^a

- unit powered by batteries: -10 °C to 50 °C (14 °F to 122 °F)
- unit connected to AC/DC power adapter: 5 °C to 40 °C (41 °F to 104 °F)

Equipment Ratings	
➤ Storage ^b	<ul style="list-style-type: none"> ➤ unit without batteries: -30 °C to 70 °C (-22 °F to 158 °F) ➤ unit with batteries: -20 °C to 60 °C (-4 °F to 140 °F)
Relative humidity ^c	<ul style="list-style-type: none"> ➤ unit: ≤ 95 % non-condensing ➤ AC/DC power adapter: 10 % to 80 % non-condensing
Maximum operation altitude	<ul style="list-style-type: none"> ➤ 2000 m (6562 ft) (unit connected to external power source) ➤ 5000 m (16405 ft) (unit operated from battery)
Pollution degree	<ul style="list-style-type: none"> ➤ 2 (unit connected to external power source) ➤ 3 (unit operated from battery)^d
Overvoltage category	I
Input power ^e	<ul style="list-style-type: none"> ➤ unit: 8 - 16 V ---; 2 A ➤ AC/DC power adapter: 100 - 240 V ~; 50/60 Hz; 0.7 A

- a. The battery will not recharge when the ambient temperature is below 5 °C (41 °F) or above 40 °C (104 °F). Depending on the ambient temperature, at maximum power, the battery recharge may be interrupted automatically after 15 minutes.
Operating time is dependent upon power consumption and temperature. If the unit is used at maximum power and maximum rated temperature, to prevent any damage to the battery, the unit will be powered off automatically after 15 minutes.
- b. To optimize the performance of the battery, you should store the unit in a cool dry place.
- c. Measured in 0 °C to 31 °C (32 °F to 87.8 °F) range, decreasing linearly to 50 % at 40 °C (104 °F).
- d. Equipment must be normally protected against exposure to direct sunlight, precipitation and full wind pressure.
- e. Not exceeding ± 10 % of the nominal voltage.

Safety Information

Electrical Safety Information



CAUTION

- The use of voltages higher than those indicated on the label affixed to your unit may damage the unit.
- The operation and storage temperatures, as well as the altitude and relative humidity values of some modules may differ from those specified for your platform. In this case, always ensure that you comply with the most restrictive conditions (either module or platform).

3 Getting Started with Your Unit

Using the Built-In Supports

Your unit has been designed to stand either vertically (with the screen facing you), or at an angle, using either the two built-in supports or the optional stand.

Note: Depending on the model you have purchased, your unit may not be equipped with built-in supports. For more information, see *Installing and Using the Optional Stand on page 18*.

The supports have been designed to be fully extended or fully retracted. They are already assembled on your unit.

Note: The supports ensure optimum stability to the unit during your tests.

To change the orientation of the unit using the supports:

Pull out the two supports.

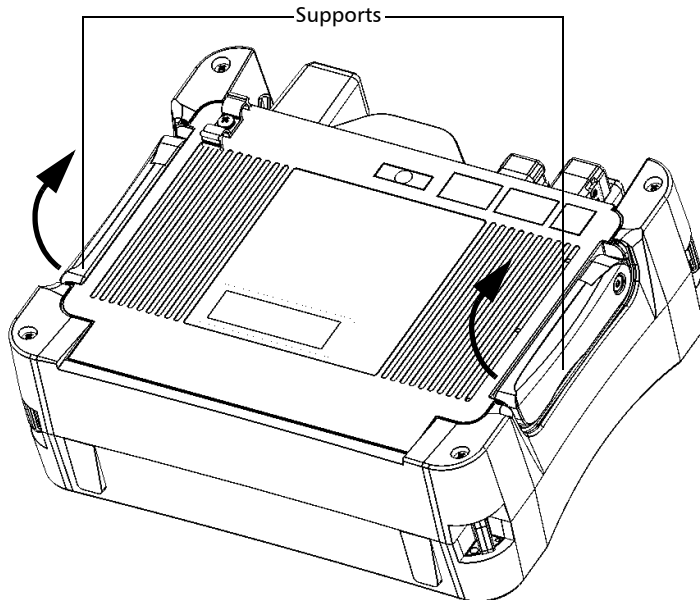

Getting Started with Your Unit

Installing and Using the Optional Stand

Installing and Using the Optional Stand

Your unit has been designed to be positioned either vertically (with the screen facing you), or at an angle, using the optional stand (or the optional utility glove).

Note: *The stand ensures optimum stability to the unit during your tests.*

The stand is not assembled on your unit at time of shipment. You must install it when you receive your unit.

To install the stand on your unit:

1. Position the unit so that its front panel rests on a flat surface such as a table.
2. Using the provided hex key (“Allen” key), remove the two top screws that secure the back of the unit in place.

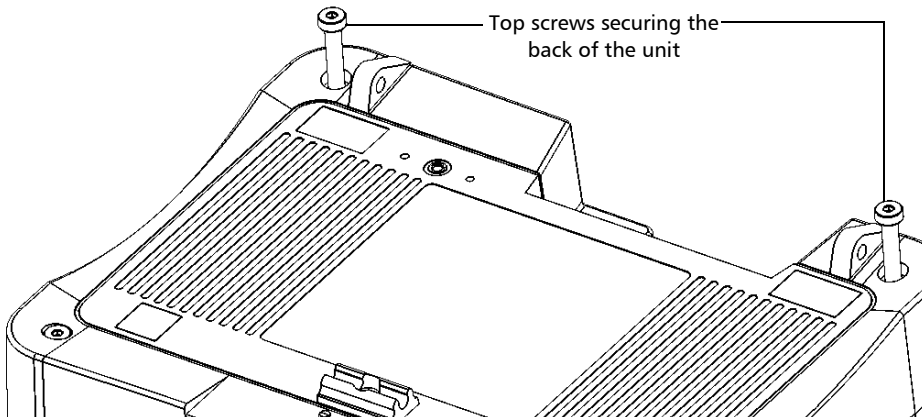

Getting Started with Your Unit

Installing and Using the Optional Stand

3. Align the side of the stand blockers with the side of the anchor eyelets, and then slide the blockers towards the eyelets until they stop. There should be no gap between the blockers and the eyelets.

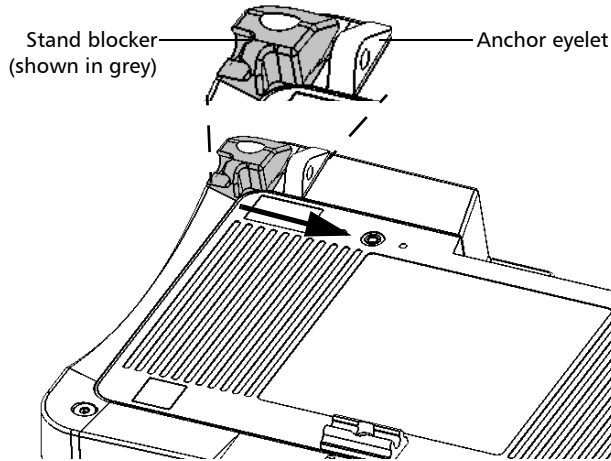

4. Using the provided hex key (“Allen” key), put the two top screws back in place (in the center of the blockers).

Getting Started with Your Unit

Installing and Using the Optional Stand

5. Hold the stand by its sides, and then slightly widen it to be able to insert it into the blockers.

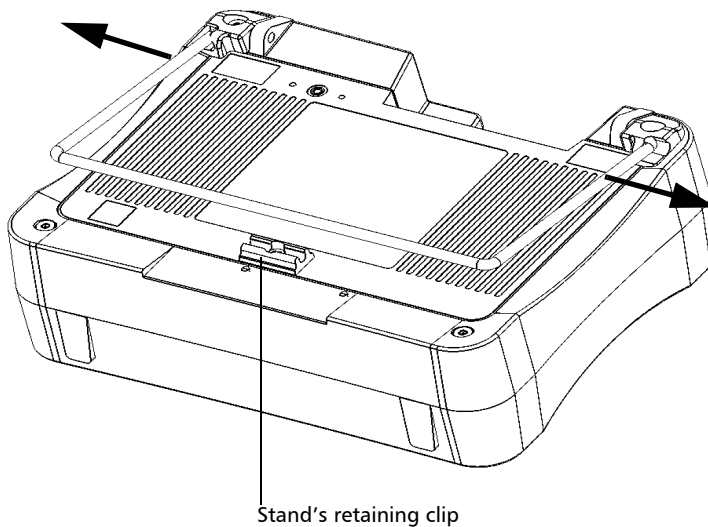

6. Release the stand as soon as it is properly inserted into the blockers.
7. If desired, secure the stand in its retaining clip by pushing it downwards.

To change the orientation of the unit using the stand:

Pull out the stand.

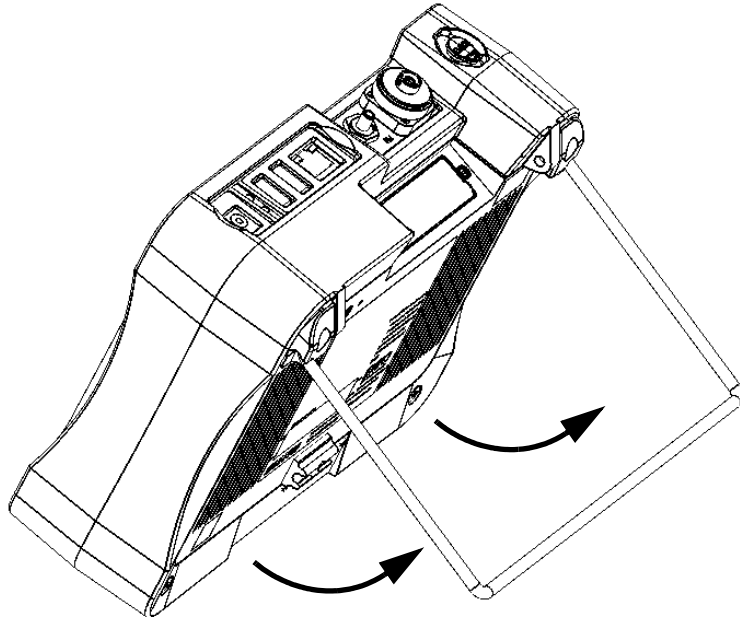

Turning On or Off the Unit

There are several ways to turn off the unit, including the following:

- *Suspend*: keeps the unit's status information in memory (RAM). The next time you turn your unit on, you will quickly return to your work environment (running applications will still be running). This mode will take more battery power while the unit is off. When powered by battery, the unit will be shut down automatically after four hours in suspend mode.
- *Shutdown*: completely cuts power to the test instruments and unit; the unit will perform a complete restart routine the next time you use it. You should perform a shutdown if you do not intend to use your unit for a day or more.

After a shutdown, the unit will start in the Home screen or in the application you defined as the startup application.

Note: *Should the unit ever stop responding, you can force a hardware reset by pressing and holding down the on/off button for at least 12 seconds. To restart your unit, release the on/off button, and then press it again as you would normally do to start your unit.*

When a power outage occurs while the unit is connected to the AC power, the unit will restart automatically when the AC power comes back.

When the unit is in suspend mode and is powered by battery, the unit will remain in suspend mode if you connect the AC power, but the battery LED will light up.

To turn on the unit:

Press the On/Off button. The unit will beep once.

Note: *If you turn on the unit for the very first time, a configuration wizard will be displayed (see the corresponding section for more information).*

To enter the suspend mode:

Press the on/off button. The unit's backlight will turn off.

To exit the suspend mode and resume your work:

Press the on/off button.

To perform a shutdown:

Press and hold the On/Off button a few seconds until the unit beeps once.

Configuring Your Unit At First Startup

The first time you turn on the unit, a configuration wizard is displayed, enabling you to set all the regional and language settings such as the date, time, and operation language. If you modify the operation language, the wizard will prompt you to restart the unit (changes will be effective at next startup). Once the unit will have restarted, the configuration wizard will be displayed in the selected language.

During the configuration process, you will also be asked to read and accept the end-user license agreement (EULA), and to read the user documentation for important safety information.

Finally, you will have the possibility to browse the EXFO Web site, and to register your new product online (provided that to you have access to an Internet connection and that the Internet options by default are compatible with your network configuration).

Note: *The acceptance of the EULA and the acknowledgment of the security information are mandatory to be able to work with the unit. However, you can modify the regional and language settings, or register your new product online later if you prefer.*

To configure your unit at the first startup:

1. If it is not already done, turn on the unit (see *Turning On or Off the Unit* on page 22).
2. When the wizard is displayed, set the parameters according to your needs.

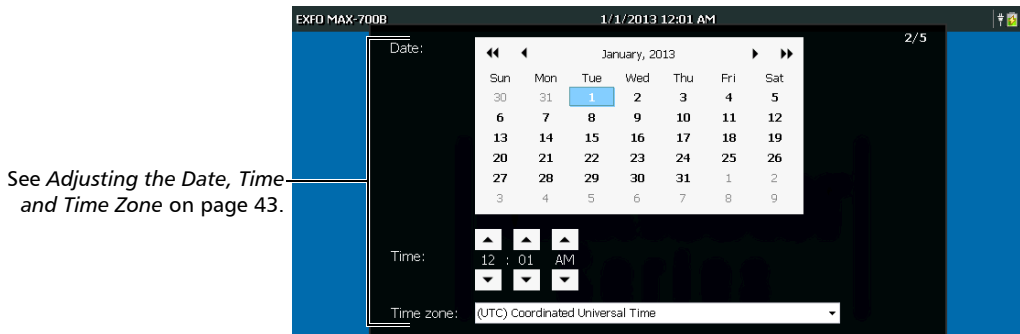
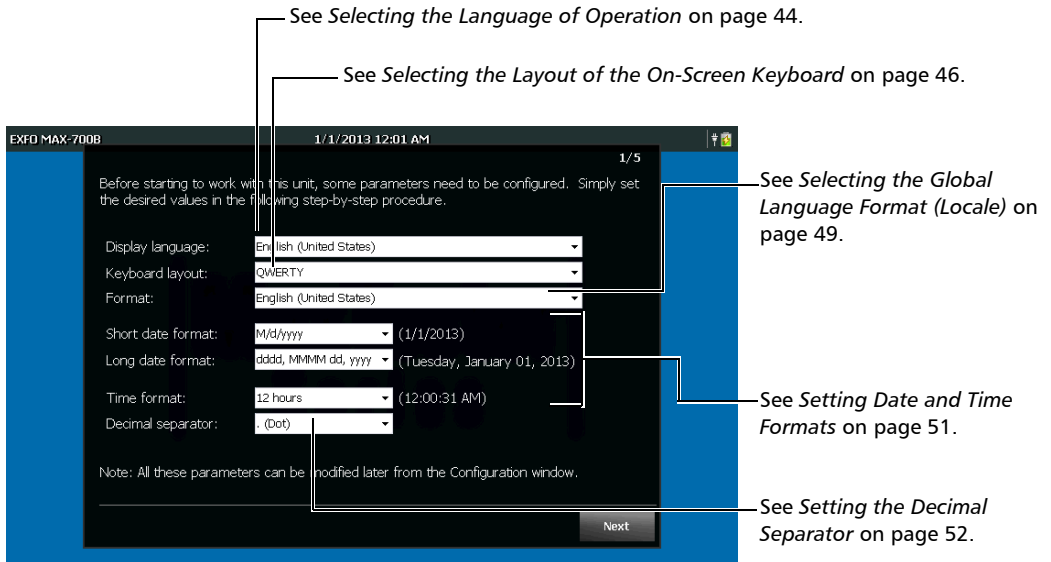

Note: The images above show the default values for each setting.

Getting Started with Your Unit

Configuring Your Unit At First Startup

3. Continue with the remaining steps.



See Accessing the Online Documentation on page 77.

4. When the configuration is complete, tap **Finish**. The Web browser will be launched automatically if you selected the check box.

Navigating Through the Applications

The central point on your unit is the Home screen. From there, you can access all the available applications and tools.

Several applications can run simultaneously on your unit, but only one instance of a specific application at a time. You can switch to the last used application, or to the application of your choice easily, without having to close the applications each time.

To start an application:

From the Home screen, tap the icon corresponding to the desired application or tool.

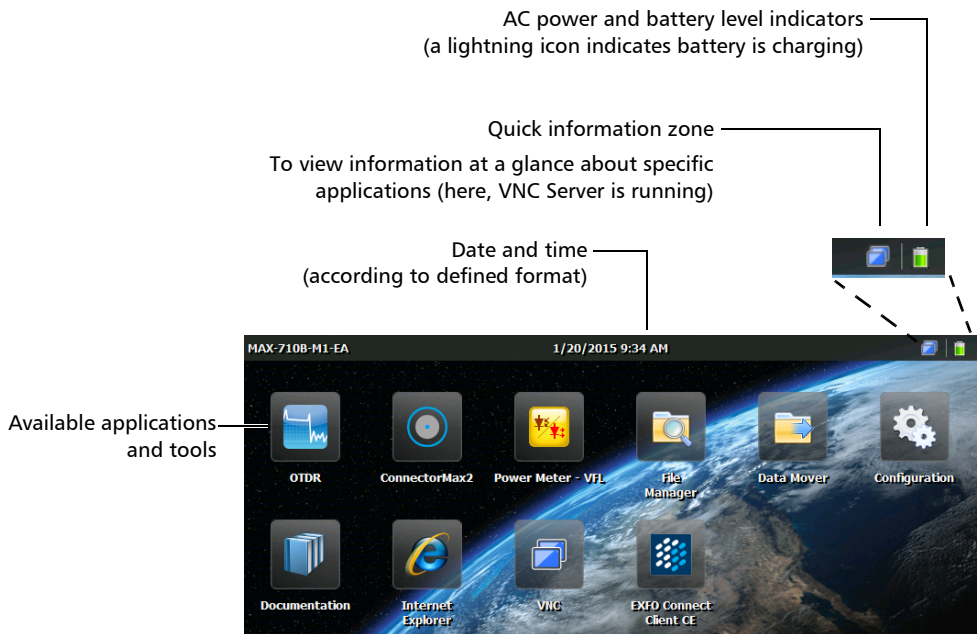

Getting Started with Your Unit

Navigating Through the Applications

To switch from Home to the last used application (and vice versa):

From the unit's front panel, press the  button.

Note: *If a keyboard is connected to your unit, or if you are controlling your unit remotely via VNC, you can also press CTRL + HOME.*

Note: *You cannot switch back to the Configuration window using this button. If you wish to access the Configuration window again, tap the corresponding icon from the Home screen.*

To switch to the application of your choice:

1. From the unit's front panel, press the  button to return to the Home screen.
2. Tap the icon corresponding to the desired application or tool.

To close an application:

Tap the X button.

Note: *Some windows and tools do not have a close button. In this case, simply press the  button to exit the application or tool, and go back to the last used application.*

Using the On-Screen (Virtual) Keyboard

Your unit is equipped with an on-screen keyboard that is displayed automatically when you select any location where data entry is possible.

Note: You can close the keyboard temporarily with the  button (located in the lower-right corner of the virtual keyboard). Next time you select a location where data entry is possible, the keyboard will be displayed again automatically.

By default, the keyboard layout is set to QWERTY, but you can select any of the provided layouts. You can also hide the virtual keyboard so that it is not displayed when you select a location where data entry is possible. This could be particularly useful when you connect a hardware keyboard to your unit. For more information about the choice of another keyboard layout, or the way to hide the keyboard, see *Selecting the Layout of the On-Screen Keyboard* on page 46.

To use the on-screen keyboard:

1. Select the location where you want to enter text.
2. Enter the data as required.
3. Exit the location when you have finished entering data.

Installing or Upgrading the Applications

All the necessary applications have been preinstalled and configured at the factory. However, you may have to upgrade the applications when new versions become available. You can either install all the applications at a time using a single system image file, or install specific products using their individual upgrade files.

When updates are available, you can download the new installation files (system image file or specific products) from the EXFO Web site to a computer. You can then transfer the files to your unit with a USB memory key.

You can install new versions of system images or products, or revert to previous ones, but you cannot reinstall versions that are currently installed on your unit.

At the end of the upgrade process, you will be presented with the configuration wizard. By default, the regional and language settings that were in use before the update will be kept, but you can modify them if you prefer.

To install or upgrade the applications:

1. Using your computer, if necessary, retrieve the desired system image file or product upgrade files from the EXFO Web site.



IMPORTANT

If you want to upgrade specific products, ensure that you retrieve both the .bin and .xlm files. Otherwise, the application will not be able to upgrade the product.

2. From your computer, copy the installation files to the root of a USB memory key.



IMPORTANT

- The application only takes into account the upgrade files (system images or products) that are not already installed on your unit. The other upgrade files will be ignored.
- System image files have precedence over product's upgrade files. This means that if there is a system image (not currently installed on your unit) at the root of the USB key, the application will ignore the upgrade files that may be present for specific products. If you want to upgrade specific products, ensure that there is no system image file at the root of the USB key that could prevent the upgrade.

3. Ensure that your unit will remain powered on during the operation by connecting it to a power outlet using the provided AC/DC power adapter.
4. From your unit, exit all the running applications.
5. Connect the USB memory key to one of the USB ports of your unit.
6. From the Home screen, on your unit, tap **Configuration**.

Getting Started with Your Unit

Installing or Upgrading the Applications

7. Tap Software Updates.

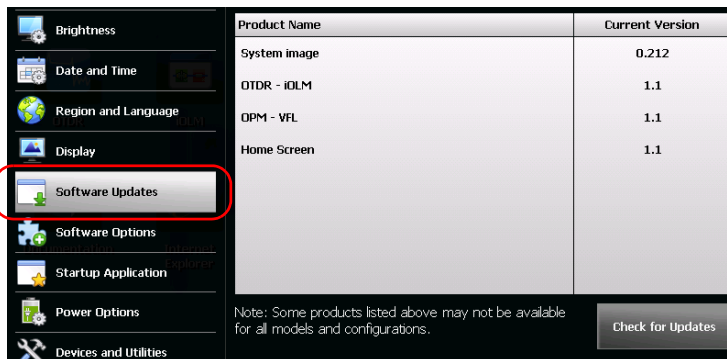

8. Tap Check for Updates.

Note: *If no appropriate system image file or product upgrade files are found on the USB memory key, the application will prompt you to browse for a folder containing upgrade files.*

Note: *If several versions of the system image or of the products are found, the application will install the most recent version.*

9. When the application prompts you to confirm the replacement of the current system image or products with new ones, tap **Yes** (system image) or **Update** (products) to start the process.

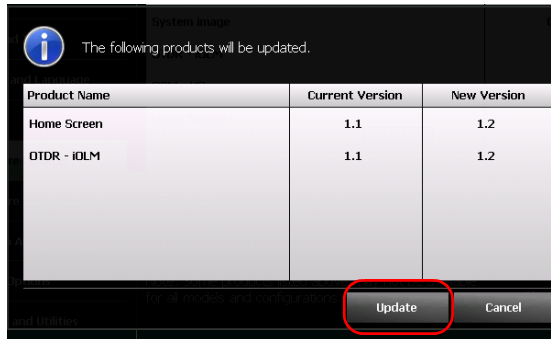

10. Read the end-user license agreement (EULA), and if you agree with the terms, tap **Accept**.

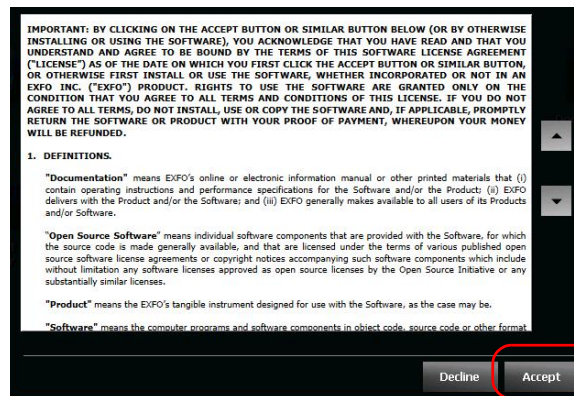

Note: *The acceptance of the license agreement is mandatory to be able to proceed with the upgrade.*

Note: *The installation process may take a few minutes.*

Getting Started with Your Unit

Installing or Upgrading the Applications

11. When the application prompts you to restart the unit, tap **OK**.



CAUTION

It is normal that your unit restarts a few times during the upgrade process.

To avoid causing irreparable damage to your unit, do not turn off your unit or force a power reset during the upgrade process. You will know that the upgrade is over when the configuration wizard is displayed.

12. When the configuration wizard is displayed, follow the on-screen instructions (see *Configuring Your Unit At First Startup* on page 24).

Note: *At this point, if you have used a USB memory key to update your unit, you can remove it.*

Activating Software Options

The software options purchased at the same time as your unit have been activated for you already. However, if you purchase options afterwards, you will have to activate them yourself.

Before being able to activate options, you need to contact EXFO with the following information:

- Purchase order number of the newly purchased options
- Unit serial number
- Customer's name
- Customer's company name
- Customer's phone number
- Customer's e-mail address
- Unit on which the options will be installed

You will receive a single key (.key) file with which you will be able to unlock all the new options that you have purchased.

If you have several units for which you need to activate options, you can copy all the key files (one file per unit) to the root of a USB memory key and use this USB key with all your units, in turn. If the appropriate key file is present on the USB key, the application will retrieve it, activate the options and then remove the file from the USB key automatically. This enables you to manage the options of all units without having to match the right key file with the current unit.

Note: *If you prefer that the key files remain on the USB memory key after the activation of the options, you have to change the attribute of the file to read-only before starting to activate the options.*

Getting Started with Your Unit

Activating Software Options

To activate the options for your unit:

1. From your computer, copy the key file to the root of a USB memory key.
2. Connect the USB memory key to one of the USB ports of your unit.
3. From the Home screen, tap **Configuration**.
4. Tap **Software Options**.

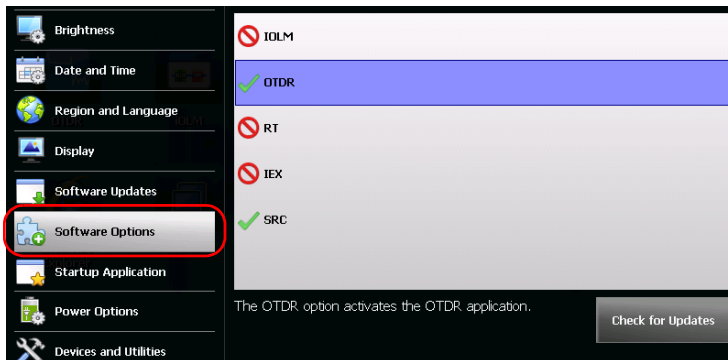

5. Tap **Check for Updates**.

When the operation is successful, the option indicator will turn into a green check mark to confirm that the option is now active.

Note: *If no appropriate key file is found on the USB key, the application will prompt you to browse for a folder containing a key file.*

6. When the application prompts you to restart the unit, tap **OK** to close the message.

Note: *At this point, if you have used a USB key to copy your key file, you can remove it as it is not required to use your new options.*



IMPORTANT

Before restarting your unit, you may wish to browse through the running applications and save any data that you want to keep.

7. Restart your unit to complete the activation process:
 - 7a. Press and hold the On/Off button a few seconds until the unit beeps once.
 - 7b. Turn the unit on again.

Using a Keyboard, Mouse or Other USB Devices

Your unit supports many USB devices. The table below lists the supported USB devices.

Device	Details
Memory key	For data transfer between your unit and a computer when you do not have access to a network. If you need information on how to transfer data using a memory key, see <i>Managing Data</i> on page 95.
Keyboard	When you are required to enter alphanumeric data, an on-screen (virtual) keyboard is displayed. However, if you prefer, you can use a hardware keyboard. Note: <i>Even if a keyboard is connected, the on-screen keyboard will still be displayed when you work with the various applications on your unit, unless you hide it (see Selecting the Layout of the On-Screen Keyboard on page 46).</i>
Mouse	If you prefer to use a mouse instead of the touchscreen, you can connect one.
Composite device	You can use composite devices, that is devices that input information to your unit using more than one mean (for example, combinations of keyboard and mouse).
Hub	This device will be particularly useful to you if you need extra USB ports.
EXFO fiber inspection probe	Only the probes of the FIP-400B series are supported on your unit. For more information on how to start the probe application, see <i>Inspecting Fibers with a Probe</i> on page 93.

You can connect several devices at the same time.



IMPORTANT

Your unit does not support USB printers. If you want to print documents, you must transfer your files to a computer (see *Managing Data* on page 95) that has access to a network printer.

To use a USB device with your unit:

Connect the USB device to any of the USB ports (located on top of the unit).

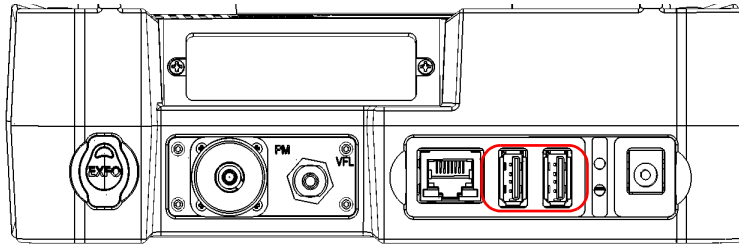

Note: *It is not necessary to turn off the unit before connecting the USB device. The software will automatically detect its presence.*

Your device is automatically recognized and immediately usable (provided that it uses the drivers already available on your unit).

4 **Setting Up Your Unit**

Adjusting Brightness

To fit your work environment, you may adjust the LCD brightness. You can adjust brightness with a slider for more accuracy, or with shortcuts to go to the medium (50 %) or maximum brightness level quickly. Values are kept in memory even when you turn the unit off.

If you want to set the delay after which the display is dimmed to save power, see *Configuring the Power Management Options* on page 57.

To adjust the display brightness:

1. From the Home screen, tap **Configuration**.
2. Tap **Brightness**.

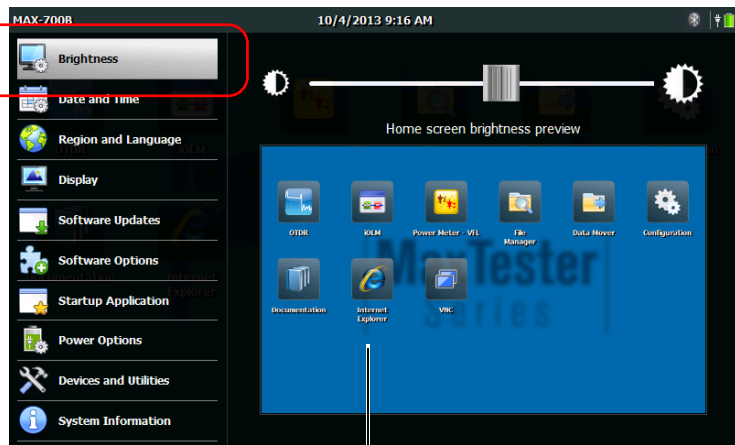

To help you view the changes in brightness in real time

3. Move the slider until the screen appearance is to your liking.
The new brightness value is taken into account immediately.
4. From the unit's front panel, press the  button to return to the Home screen.

Setting Up Your Unit

Adjusting Brightness

To quickly set the brightness to the medium or maximum level:

1. From the unit's front panel, press the  button for two seconds.

Note: *Once you have press the button, the brightness is set to the maximum value temporarily to ensure optimal readability.*

2. From the shortcut toolbar, tap the button corresponding to the desired brightness level.

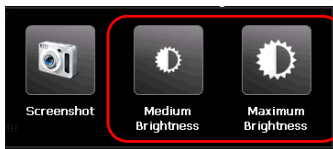

The new brightness value is taken into account immediately.

Adjusting the Date, Time and Time Zone

The current date and time are displayed at the top of the Home screen. When saving results, the unit also saves the corresponding date and time.

For information on how to modify the format in which the date and time are displayed, see *Setting Date and Time Formats* on page 51.

To adjust the date, time or time zone:

1. From the Home screen, tap **Configuration**.
2. Tap **Date and Time**.

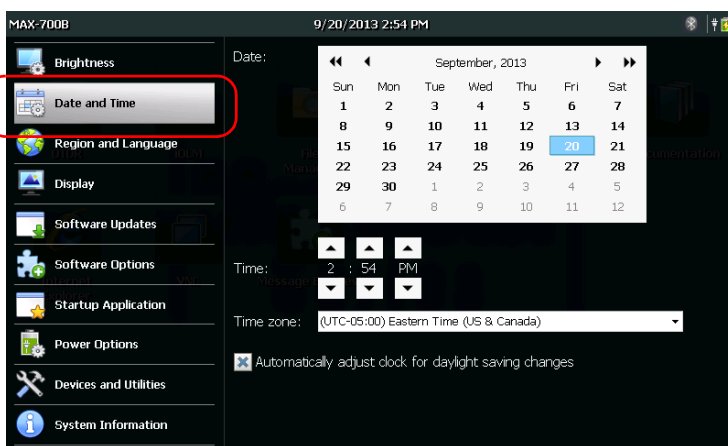

3. Modify the settings according to your needs.
4. From the unit's front panel, press the  button to return to the Home screen.

The new values are taken into account immediately.

Setting Up Your Unit

Selecting the Language of Operation

Selecting the Language of Operation

You may display the user interface in one of the available languages (default is English). The value is kept in memory even when you turn the unit off.

Note: *Certain applications or tools may not be offered in all languages.*

Note: *Changing the interface language has no effect on the keyboard layout. This means that you may have to change the layout manually if it no longer suits your needs (see Selecting the Layout of the On-Screen Keyboard on page 46).*

To select a new interface language:

1. From the Home screen, tap **Configuration**.
2. Tap **Region and Language**.

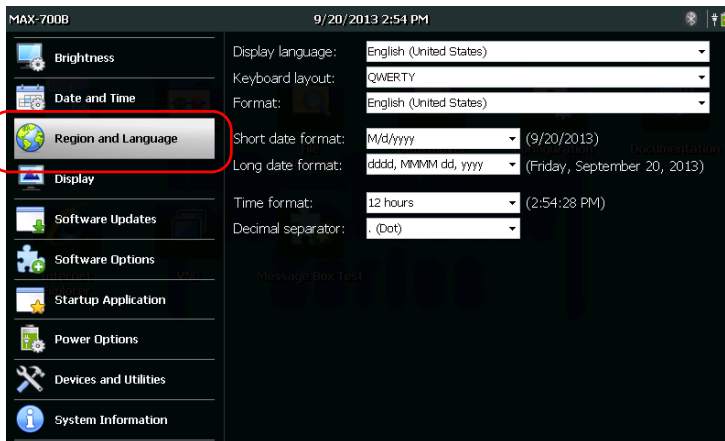

3. From the **Display language** list, select the desired language.

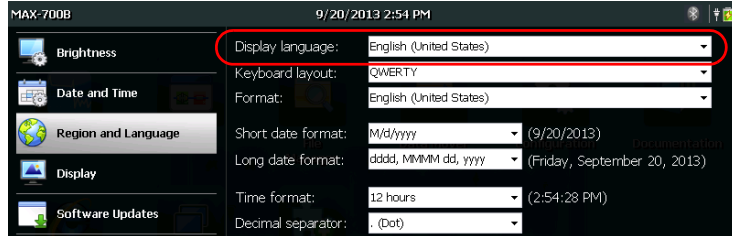

4. When the application prompts you to restart the unit, tap **OK** to confirm.

The new interface language will become available at the next startup.

Setting Up Your Unit

Selecting the Layout of the On-Screen Keyboard

Selecting the Layout of the On-Screen Keyboard

You can select the layout of the on-screen keyboard. By default, the keyboard layout is set to QWERTY, but you can select any of the provided layouts.

If you prefer, you can also hide the virtual keyboard so that it is not displayed when you select a location where data entry is possible. This could be particularly useful if you do not wish to view the on-screen keyboard when you connect a hardware keyboard to your unit, or when you access your unit remotely via VNC.

- If you select the QWERTY (Pinyin) layout, in addition to the virtual keyboard, the following floating toolbar is displayed.

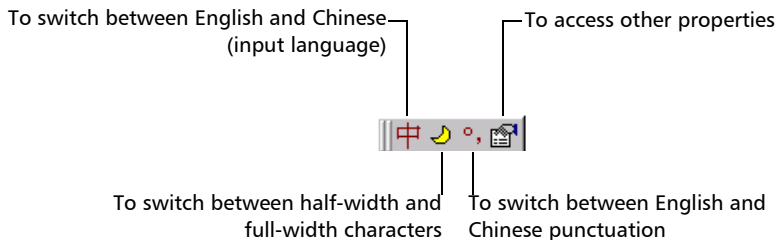

- If you select the QWERTY (Japanese) layout, in addition to the virtual keyboard, the following floating toolbar is displayed.

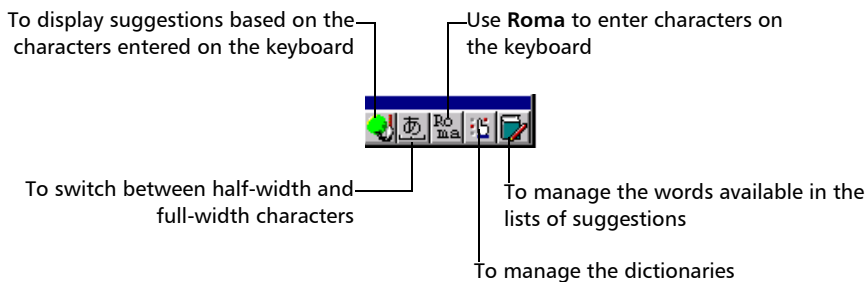

- If you select the Hangul layout, in addition to the virtual keyboard, the following floating toolbar is displayed.

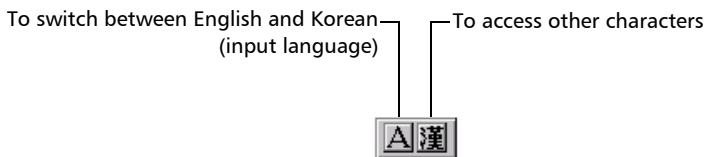

Note: *If the Pinyin, Japanese or Hangul toolbar are not visible, they could be hidden under the virtual keyboard. In this case, simply move the virtual keyboard until you can see the toolbar. Once the toolbar is visible, you can move it to a location of your choice on the screen.*

Setting Up Your Unit

Selecting the Layout of the On-Screen Keyboard

To select the layout of the on-screen keyboard:

1. From the Home screen, tap **Configuration**.
2. Tap **Region and Language**.

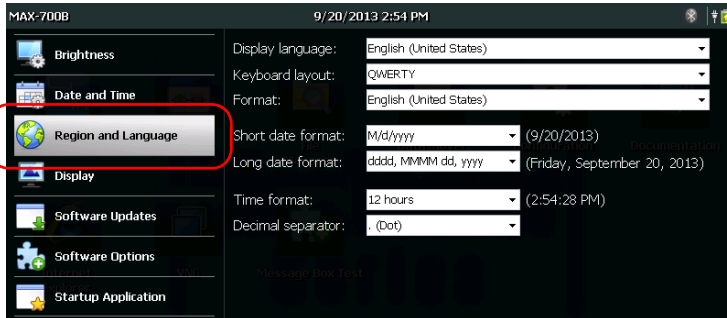

3. From the **Keyboard layout** list, select the desired layout.

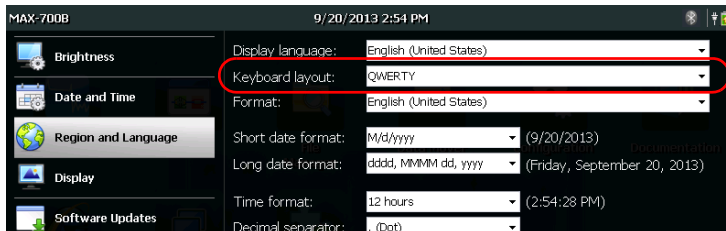

Note: If you want to hide the keyboard, select *None*. If you want to display it again, select any other layout.

Note: Switching from a given keyboard layout to a QWERTY (Pinyin), QWERTY (Japanese) or Hangul layout (or vice versa) requires that you restart your unit manually.

4. From the unit's front panel, press the  button to return to the Home screen.

The on-screen keyboard will use the new layout next time you need to enter data.

Selecting the Global Language Format (Locale)

By default, the dates (short and long), time and decimal separator are displayed in the formats associated with the global language format (locale). This means that by selecting the global language format, you can quickly define date, time and decimal separator formats.

For information on how to refine the date, time or decimal separator formats, see *Setting Date and Time Formats* on page 51 and *Setting the Decimal Separator* on page 52.

To set the global language format:

1. From the Home screen, tap **Configuration**.
2. Tap **Region and Language**.

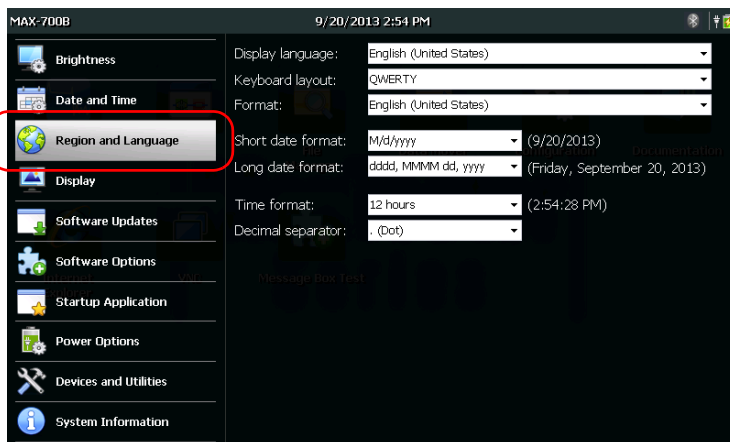

Setting Up Your Unit

Selecting the Global Language Format (Locale)

3. From the **Format** list, select the desired global language (locale). This will determine the date formats available for the dates, time and decimal separator.

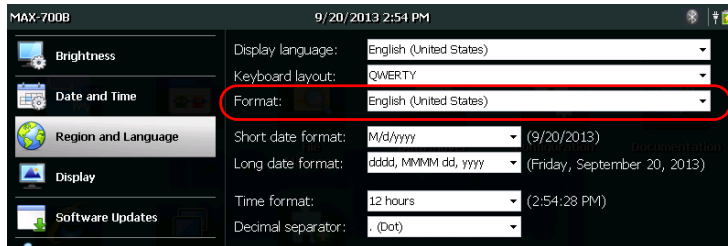

4. From the unit's front panel, press the  button to return to the Home screen.

The new values are taken into account immediately.

Setting Date and Time Formats

By default, the dates (short and long) and time are displayed in the formats associated with the global language format (locale). The time can be expressed with a 12- or a 24-hour notation. You can modify the way dates and time are displayed if the default values do not suit your needs.

For information on how to adjust the date, the time, and the time zone, see *Adjusting the Date, Time and Time Zone* on page 43.

To set date and time formats:

1. From the Home screen, tap **Configuration**.
2. Tap **Region and Language**.

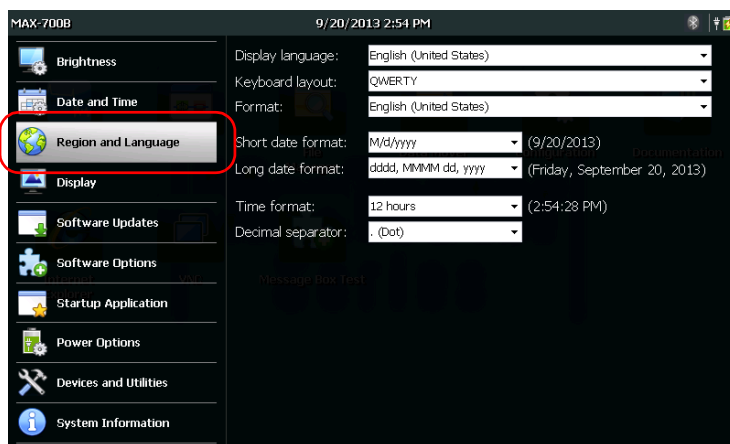

3. Refine the settings according to your needs.
4. From the unit's front panel, press the  button to return to the Home screen.

The new values are taken into account immediately.

Setting Up Your Unit

Setting the Decimal Separator

Setting the Decimal Separator

By default, the decimal separator used in numeric values corresponds to the one associated with the global language format (locale). However, you can select another decimal separator if you prefer.

To set the decimal separator:

1. From the Home screen, tap **Configuration**.
2. Tap **Region and Language**.



3. From the **Decimal separator** list, select the desired separator.



4. From the unit's front panel, press the  button to return to the Home screen.

The new value is taken into account immediately.

Changing the Background Picture

The Home screen comes with a default background picture. However, you can change it by either selecting another image from those provided with your unit, or by adding one of your own images.

For an optimum display, the size of the images must be 800 pixels x 480 pixels. The images that are smaller will be ignored (not visible on the list of possible background images). The images exceeding the optimum dimensions will be truncated to the right dimensions automatically at time of display.

You can use images in .bmp, .jpg, or .png format. Your background images are kept in the following folder:

DATA\Home screen\Backgrounds.



IMPORTANT

The unit takes into account *only a limited number of the most recent images* whose sizes are 800 pixels x 480 pixels or more. Adding a large number of images to your unit will have an impact on the loading time of the background images list.

Setting Up Your Unit

Changing the Background Picture

To add your own background pictures:

1. Transfer the images that you want to use to a USB memory key.
2. Connect the USB memory key to one of the USB ports on your unit.
3. From the Home screen, tap **File Manager**.

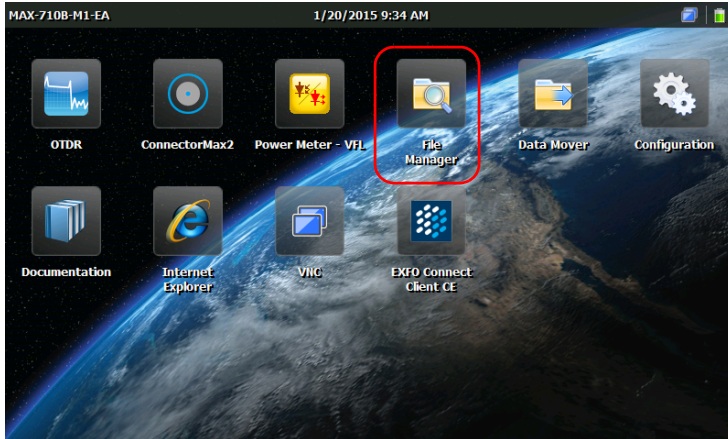

4. Tap the parent folder button once.

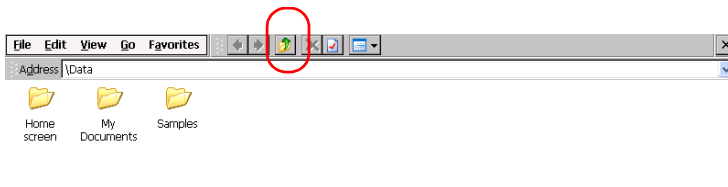

5. Localize your USB memory key (identified by “Removable Disk” or “Removable Disk 2”).

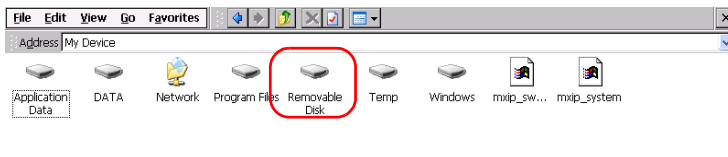

6. Double-tap the USB memory key identifier to access the key contents.
7. Copy the image that you need:
 - 7a. Select the desired file.

Note: *If you want to copy all files at the same time, from the **Edit** menu, select **Select All**.*

- 7b. From the **Edit** menu, select **Copy**.
8. Tap the parent folder button once to exit the USB memory key.
9. Double-tap **DATA**, then **Home screen** > **Backgrounds**.
10. From the **Edit** menu, select **Paste**.

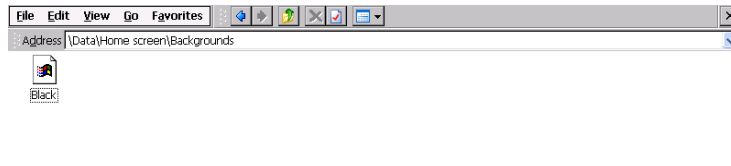

11. If necessary, repeat steps 6 to 10 with all the images that you want to transfer to your unit.
 12. Disconnect the USB memory key.
- Your new images are now available on your unit.

Setting Up Your Unit

Changing the Background Picture

To change the background picture:

1. From the Home screen, tap **Configuration**.
2. Tap **Display**.

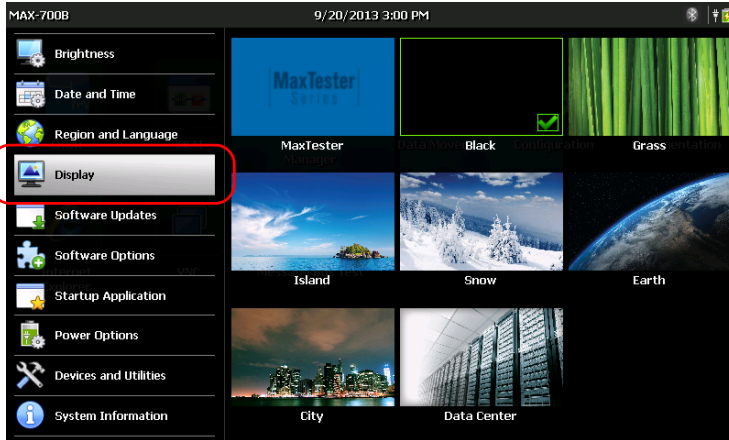

3. Tap the image that you want to select as the new background image. The edge of the selected image will be highlighted and a check mark will appear, confirming your selection.
4. From the unit's front panel, press the  button to return to the Home screen.

The background image is refreshed immediately.

Configuring the Power Management Options

When you do not use the unit for a while, the display may be dimmed to save power. You can also configure the unit to go into suspend (sleep) mode after the specified duration has expired (see *Turning On or Off the Unit* on page 22).

For these actions, you can set idle durations for AC/DC power adapter and battery operation. The values that you set are kept in memory even when you turn the unit off.



IMPORTANT

The sleep delay (time before the unit switches to suspend mode) will only be taken into account once the dim delay (time before the display is dimmed) has expired. For example, if the dim delay is set to 5 minutes and the sleep delay is set to 10 minutes, the unit will switch to suspend mode (sleep) after 15 minutes. If you set the dim delay to *Never*, the sleep delay will also be set to *Never* automatically.

Note: *When the unit is in suspend mode and powered by battery, to save battery power, the unit will switch from suspend to shutdown automatically after four hours.*

Note: *When the backlight is dimmed, the unit operation is not interrupted. Touch anywhere on the screen to return to normal operation.*

Setting Up Your Unit

Configuring the Power Management Options

To configure the power management options:

1. From the Home screen, tap **Configuration**.
2. Tap **Power Options**.

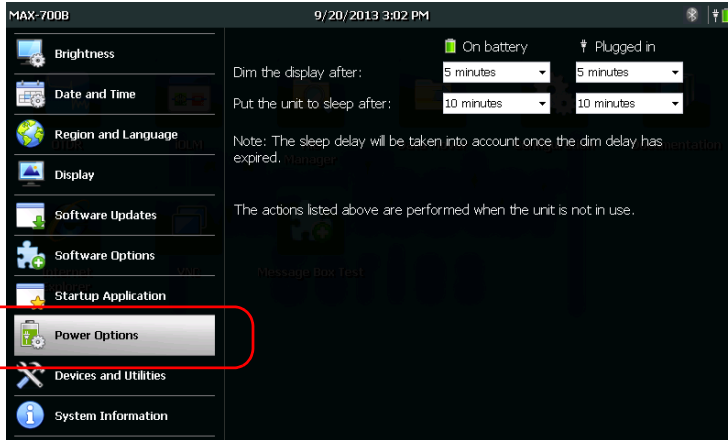

3. Modify the settings according to your needs.
4. From the unit's front panel, press the  button to return to the Home screen.

The new values are taken into account immediately.

Configuring the Internet Options

You can browse the Web directly from your unit, provided that you have access to an Internet connection and that the Internet options are configured properly.

If you are not sure about how to configure your Internet access, contact your network administrator.

To configure the Internet options:

1. From the Home screen, tap **Configuration**.
2. Tap **Devices and Utilities**.

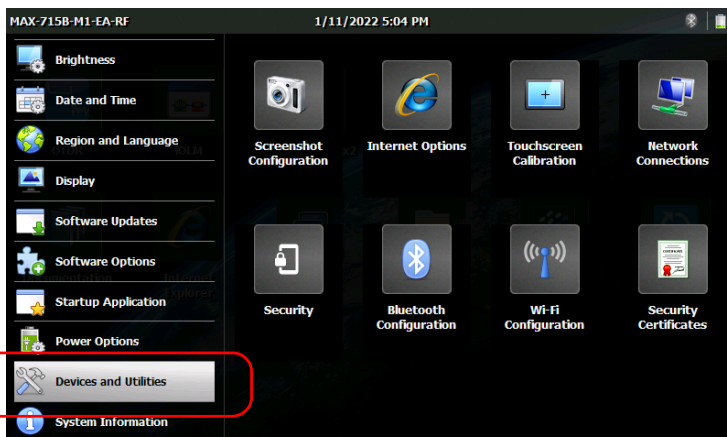

3. Tap **Internet Options**.
4. Go to the **Connection** tab.
5. Modify the settings using the information provided by your network administrator.
6. From the unit's front panel, press the  button to return to the Home screen.

The new values are taken into account immediately.

Setting Up Your Unit

Recalibrating the Touchscreen

Recalibrating the Touchscreen

If you notice the touchscreen does not behave in the way it used to (for example, it is now difficult to select items) it probably needs a recalibration. The calibration method is performed using five points.

You can stop the calibration process at any time, but the touchscreen will still need calibration. The parameters are taken into account only when the process is complete.

Note: *If a keyboard is connected to your unit, you can start the calibration application directly by pressing CTRL + ALT + T.*

To recalibrate the touchscreen:

1. If you have started the calibration application already, go directly to step 4. Otherwise, from the Home screen, tap **Configuration**.
2. Tap **Devices and Utilities**.

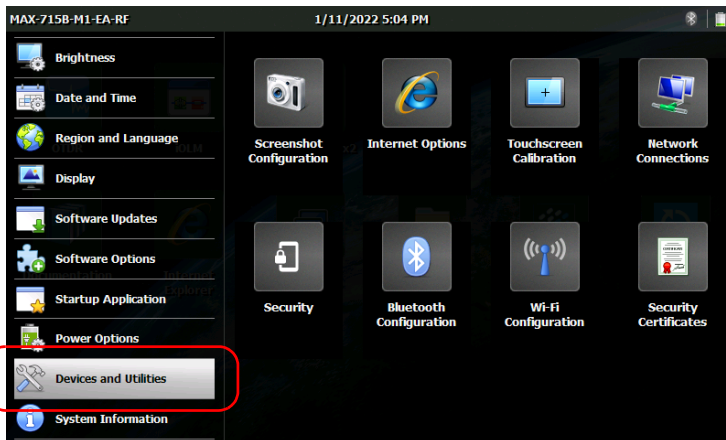

3. Tap **Touchscreen Calibration**.

4. Using the stylus (or any blunt pointing device), simply press the center of the different targets that appear on the screen.

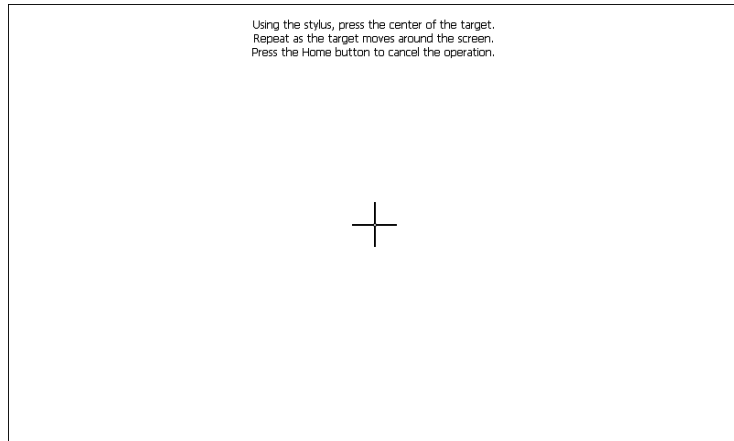

Note: *If you want to stop the calibration process, from the unit's front panel, press the  button. The application will close automatically after a few seconds.*

5. When the calibration is complete, you will return to the Configuration window automatically.
6. Press the  button to close the Configuration window and return to the Home screen.

Setting Up Your Unit

Selecting the Startup Application

Selecting the Startup Application

The first time you start your unit, the Home screen is displayed. However, you can configure your unit to automatically start in any of the available applications.

You can also configure your unit to start services such as the VNC server (for remote control) or EXFO Connect Client CE. For more information on remote control with VNC, see *Accessing Your Unit Remotely* on page 121. For more information on EXFO Connect Client CE, refer to the corresponding user guide.

The selected application and service will start automatically the next time you turn on your unit after a *shutdown* (not after resuming from the suspend mode, and not after updating the applications). For more information, see *Turning On or Off the Unit* on page 22.

To select a startup application:

1. From the Home screen, tap **Configuration**.
2. Tap **Startup Application**.

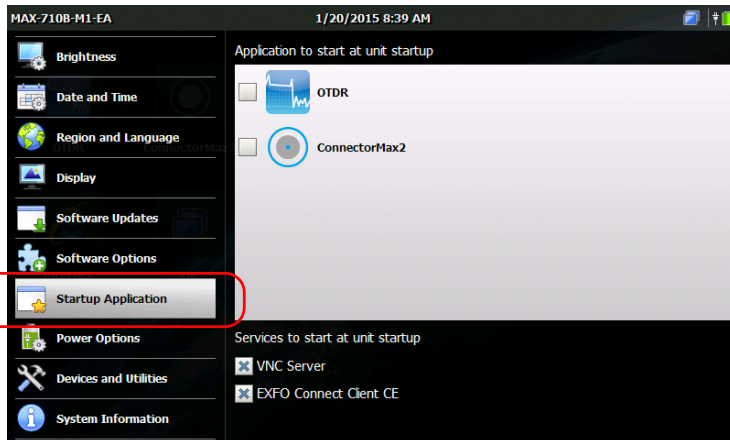

3. Select the application and/or the service you want to start automatically when you turn on your unit.

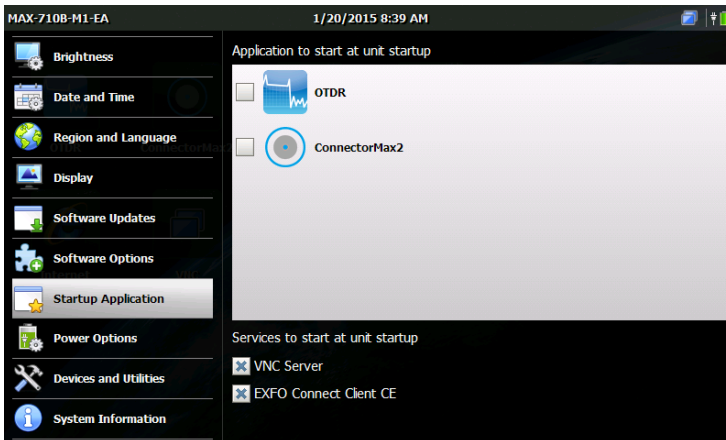

Note: You can select more than one service, but only one application at a time.

4. From the unit's front panel, press the  button to return to the Home screen.

Your selection will be taken into account next time you restart the unit.

Setting Up Your Unit

Configuring the Network Settings

Configuring the Network Settings

You can configure the various network settings that your unit uses to connect to the network or to the Internet. By default, the IP address of the unit is assigned dynamically (automatically) by a DHCP server on your network. However, if you prefer, you can define your own static IP address.

Note: *If you are not sure on how to proceed or need more information about the configuration, contact your network administrator.*

To configure the network settings:

1. From the Home screen, tap **Configuration**.
2. Tap **Devices and Utilities**.

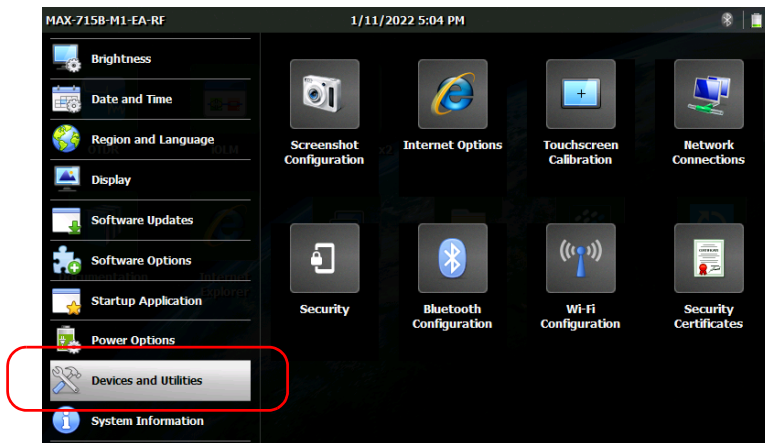



3. Tap **Network Connections**.

4. Double-tap FEC1.

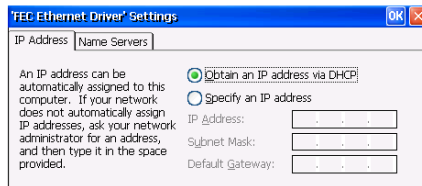

5. Go to the IP Address tab.



- 6.** Modify the settings using the information provided by your network administrator.
- 7.** Tap **OK** to confirm the changes.
- 8.** Close the window to return to the Configuration window.
- 9.** From the unit's front panel, press the  button to return to the Home screen.

The new values are taken into account immediately.

Setting Up Your Unit

Using Password Protection for Your Unit

Using Password Protection for Your Unit

If you have purchased the PSWRD option, as an administrator, you can set passwords to secure access to your units and applications.

There are two types of passwords:

- **Admin:** Allows to open and use the applications, plus manage the password feature settings.
- **User:** Allows to open and use the applications.

The user password can remain the same until you decide to modify it, or you can specify an expiration date at which it will need to be changed. You can set passwords individually on each unit, or you can use the export feature once you have set a first unit, and import the settings to the rest of your units. You can also include a short message that will appear on the title bar of the unit once the user or administrator has logged in.

Note: *Once you have enabled passwords on your unit, you will need the administrator password to deactivate the feature, or to revert to a previous version of the application and remove the option.*



IMPORTANT

You need the product key, located on the provided USB key to enable the software option.



IMPORTANT

As a user, if you lose your password, contact your administrator to retrieve it or receive a new file to import.

As an administrator, if you lose your passwords, contact EXFO for assistance.

To set passwords for your unit (administrator level only):

1. From the Home screen, tap **Configuration**.
2. Tap **Devices and Utilities**.

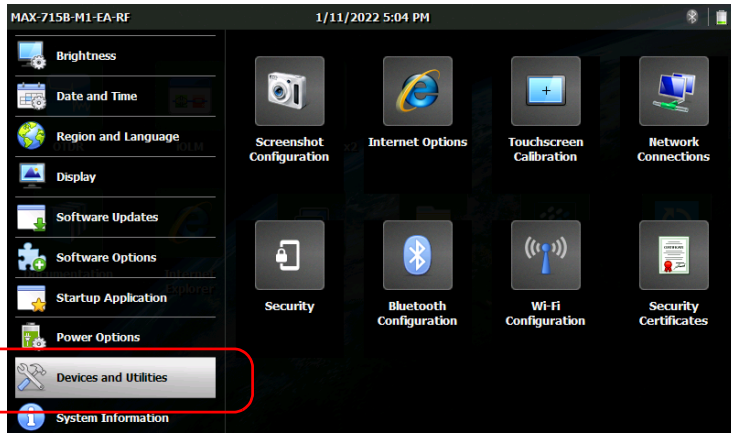

3. Tap **Security**.

Setting Up Your Unit

Using Password Protection for Your Unit

4. Enable the password feature by selecting the corresponding option.

The screenshot shows a settings window with a dark background. At the top, there is a checkbox labeled "Ask for password when starting the unit" which is currently unchecked and highlighted with a red circle. Below this, there are two sections for "Admin" and "User". Each section has a "Password:" field with masked characters (*****), a "Modify" button, and an "Expiration:" field with a date (6/25/2022) and navigation arrows. Below these is a "Customer Message" section with a checkbox "Display message in application" and an empty text input field. At the bottom of the window, there are buttons for "Import", "Export", "Reset", "OK", and "Cancel".

5. Select which password you want to set by tapping the corresponding **Modify** button.

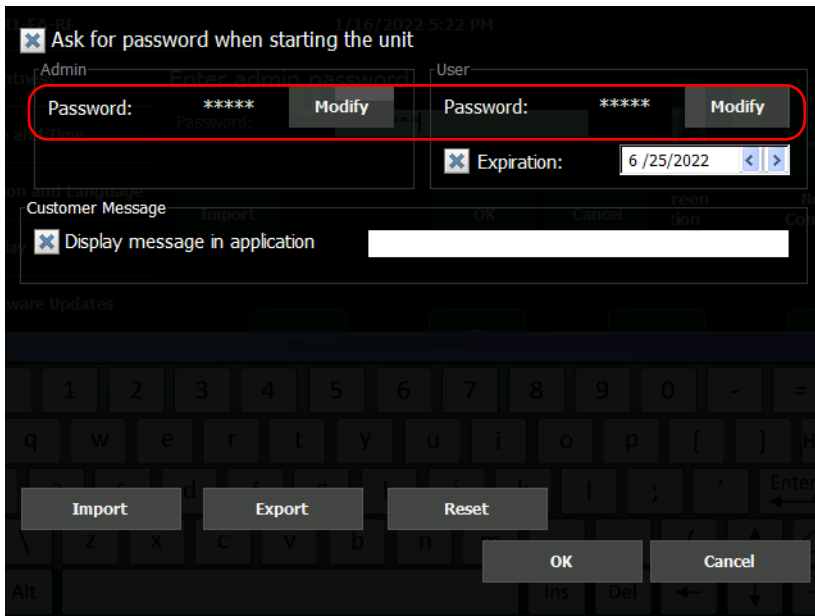

6. Enter the desired password, then tap **OK**. The password must be between 4 and 12 characters.

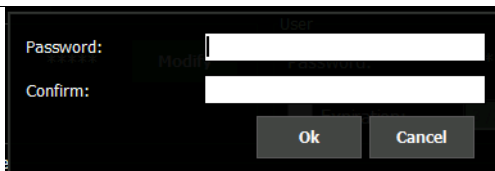

Setting Up Your Unit

Using Password Protection for Your Unit

7. If you want the user password to expire, enable the option, then select a suitable date.

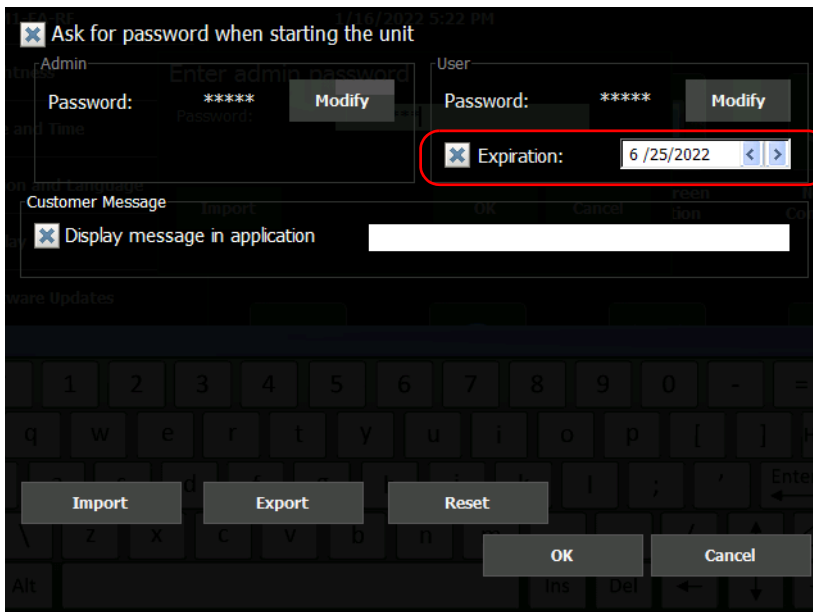

8. If you want to add a short message on the title bar of the Home screen, enable the corresponding option, then enter your message.

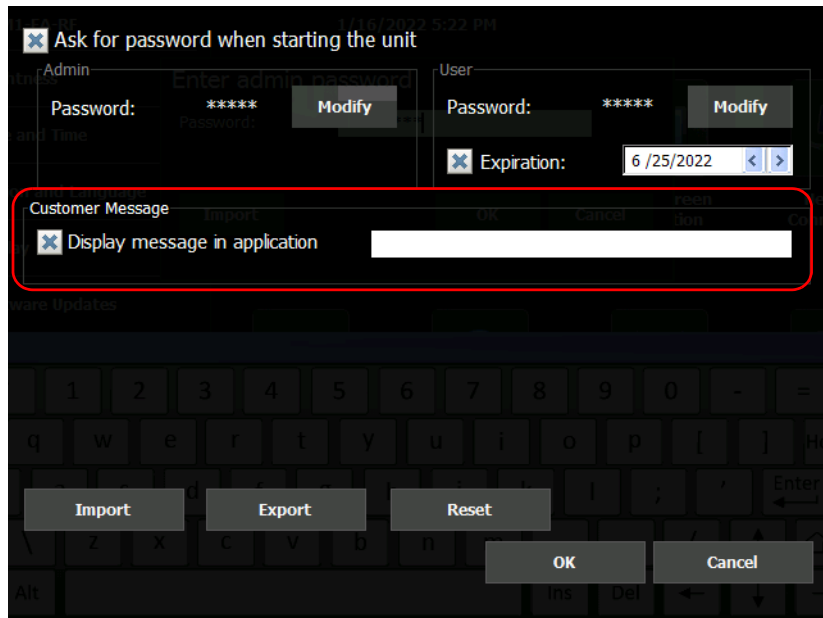

Setting Up Your Unit

Using Password Protection for Your Unit

9. If you are setting up only one unit, tap **OK** to close the window.

OR

If you want to export your settings to other units, tap **Export**. The file will be saved onto the USB key.

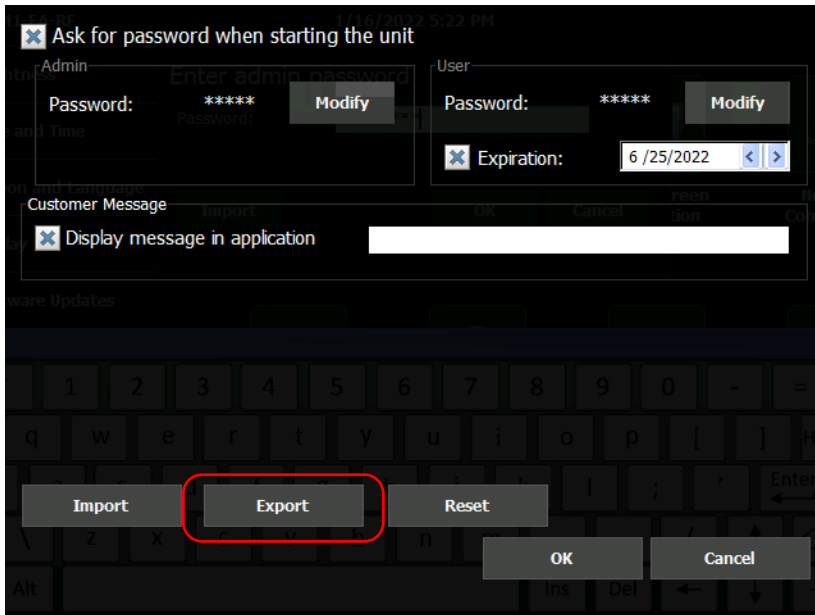

You can now import this file on other units, or send it to a user should they require new password information.

To import password settings from another unit (administrator level only):

1. From the Home screen, tap **Configuration**.
2. Tap **Devices and Utilities**.

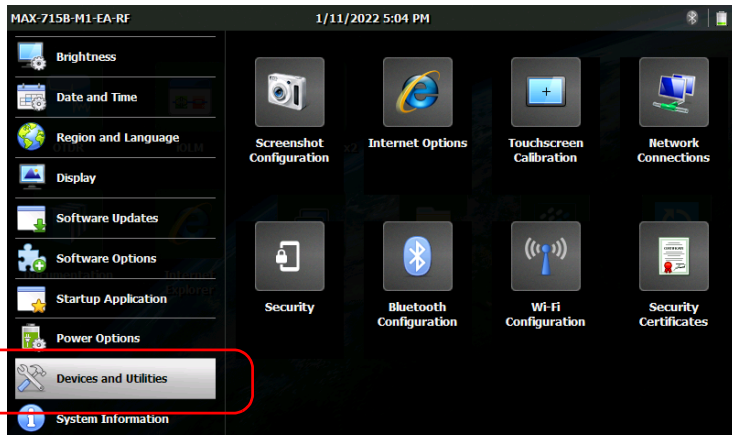

3. Tap **Security**, then enter the administrator password.

Setting Up Your Unit

Using Password Protection for Your Unit

4. Tap **Import**. The most recent file is automatically used.

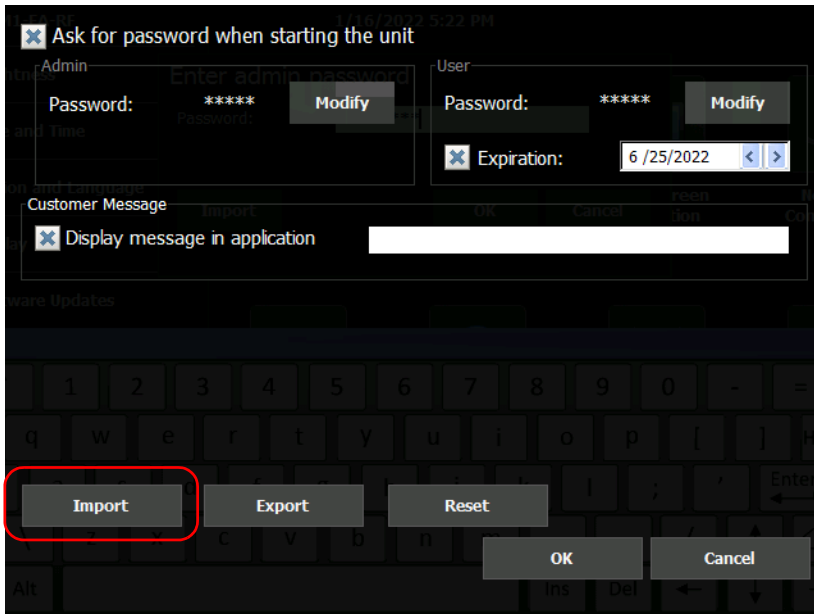

To clear the password settings (administrator level only):

1. From the Home screen, tap **Configuration**.
2. Tap **Devices and Utilities**.

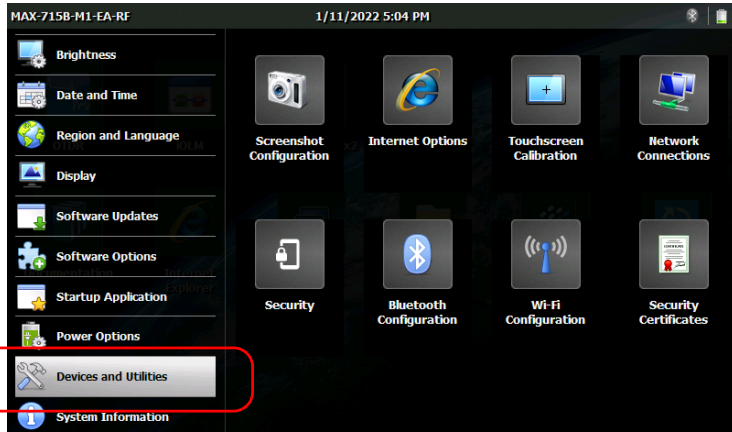

3. Tap **Security**, then enter the administrator password.

Setting Up Your Unit

Using Password Protection for Your Unit

4. Tap **Reset**.

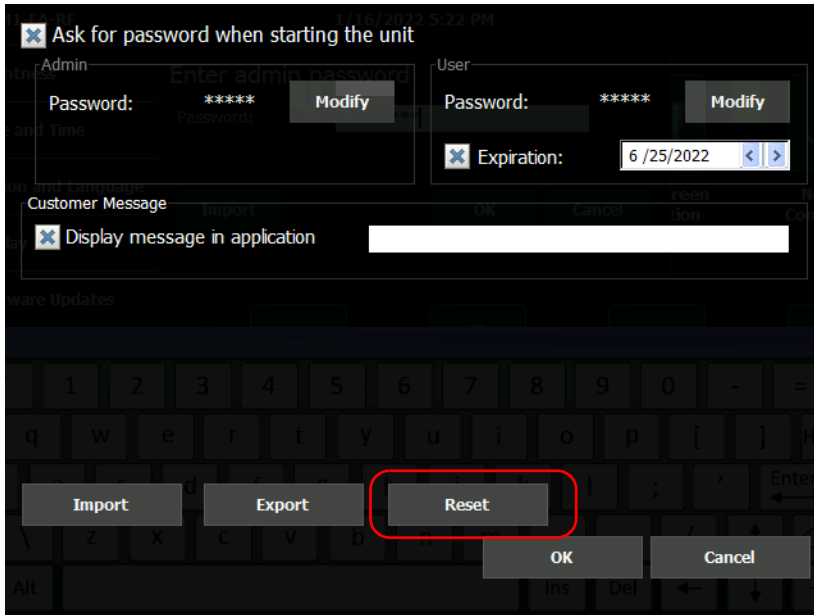

To log on to the unit:

When prompted, enter your user or administrator password.

If your administrator has provided you with updated password information, for example, if your password has expired or if you have lost your password, tap **Import**, then locate the key file on your USB key to enable the new information. You can then proceed by entering the new password.

5 Working with Your Unit

Accessing the Online Documentation

You can access the user documentation as well as the license agreements at all times from your unit. When you open user documentation from the Home screen (or the configuration wizard), the PDF files are displayed automatically in the PDF reader.

If you want to print the user documentation, from a computer having access to the Internet, you can sign in to your EXFO account from the EXFO Web site (www.exfo.com) and download it directly. You can also retrieve the user documentation from your unit and transfer the PDF file to a USB memory key.

To access the online documentation:

1. From the Home screen, tap **Documentation**.



2. Tap the desired document.

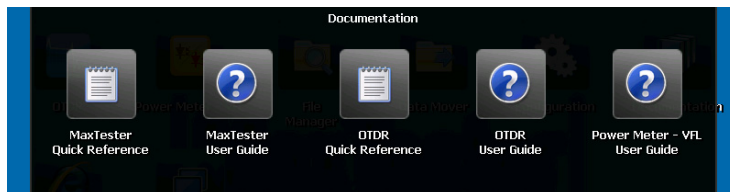



Note: The available documents depend on your unit's configuration.

Working with Your Unit

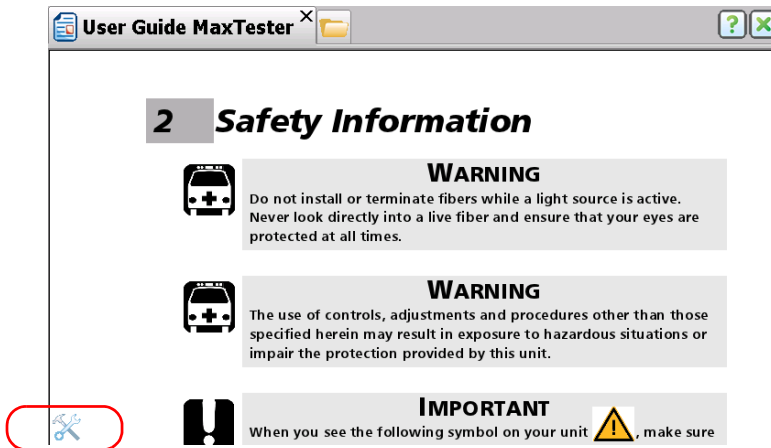

Accessing the Online Documentation

3. If you wish to access navigation tools, tap anywhere on the screen to display the tools icon.

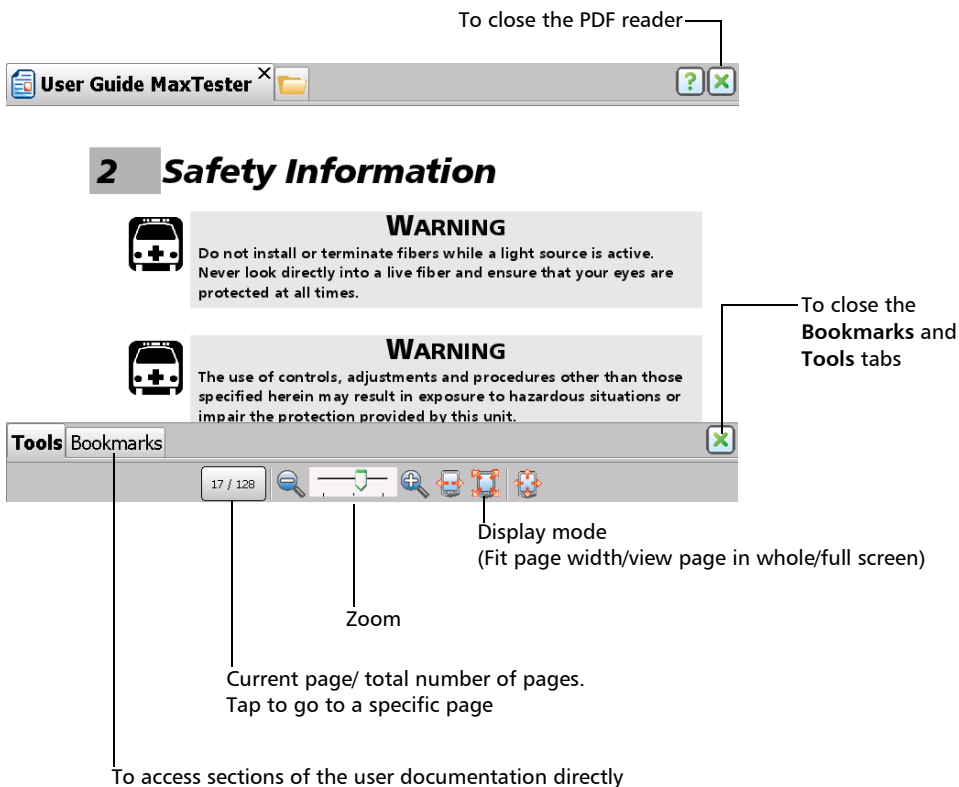

4. Tap the  icon to display the **Tools** and **Bookmarks** tabs.



Note: As soon as you switch to full screen mode, only the content of the file remains displayed (all the other elements are hidden). For this reason, to close the PDF reader, you need to go back to the **Tools** tab (steps 3 and 4 explained above), and then exit the full screen mode with the  button. You will then be able to close the reader as usual with the  button.

Working with Your Unit

Accessing the Online Documentation

To transfer the user documentation to a USB memory key:

1. Connect a USB memory key to one of the USB ports of the unit.
2. From the Home screen, tap **File Manager**.
3. In the **Address** bar, type `|Program Files|Metrino|`, and press ENTER.

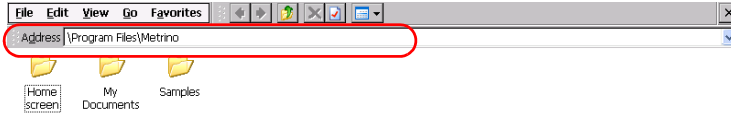

4. Double-tap the folder corresponding to the application for which you want to retrieve the documentation.
5. Locate the desired PDF file. The English version is available directly at the root of the folder. For the other languages, double-tap the folder corresponding to the desired language.

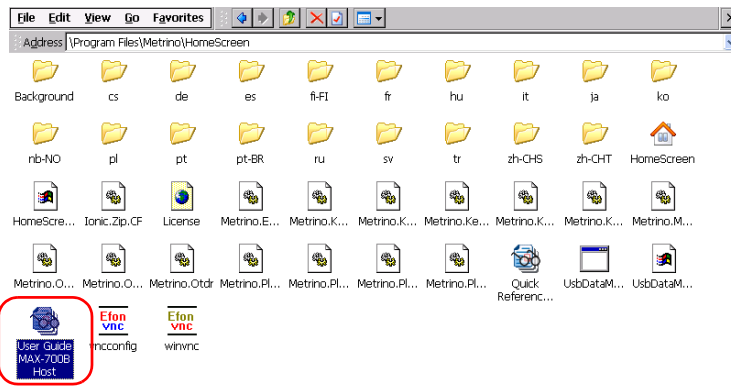

Note: The user documentation may not be available in all of the listed languages.

6. From the **Edit** menu, select **Copy**.
7. Tap the parent folder button several times until you can see your USB memory key (identified by “Removable Disk” or “Removable Disk 2”).

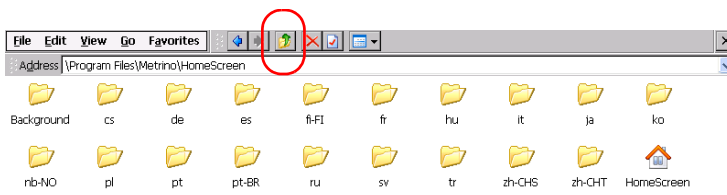

8. Double-tap the USB memory key identifier to access the key contents.
9. From the **Edit** menu, select **Paste**.
10. Disconnect your USB memory key.

Taking Screen Captures

You can take captures of what is displayed on your screen, directly from your unit. This could be useful for troubleshooting when you need another person to have a look at a specific configuration or problem. You could also use this tool for training purposes.

For more information on how to modify the default file format and destination folder, see *Setting Storage Parameters for Screen Captures* on page 84.

- Images are saved using the defined file format. By default, images are created in .jpg format, but you can modify this parameter. By default, they are kept in the following folder:

`|DATA|My Documents|Screenshots`

It is possible to modify the folder in which images are automatically saved.

- By default, the application generates file names as follows:

`IMG_<Selected_date_format>_<Selected_time_format>.jpg`

where

Selected_date_format corresponds to the short date format defined in the **Configuration > Region and Language** window.



Selected_time_format corresponds to the time format defined in the **Configuration > Region and Language** window.

Examples:

For a screen capture taken on August 20, 2013, the file name could be:

Short Date Format	Time Format	File Name
MM/dd/yy	12 hours	IMG_08_20_13_4_23_10_PM.jpg
yyyy-MM-dd	12 hours	IMG_2013_08_20_4_23_10_PM.jpg
yyyy-MM-dd	24 hours	IMG_2013_08_20_16_23_10.jpg

To take a screen capture:

1. From the unit's front panel, press the  button for two seconds.
2. From the shortcut toolbar, tap the  button.

The screen capture is automatically taken (a visual effect typical of a camera taking a picture indicates that the capture is complete).

Note: *The shortcut toolbar will not appear in the screen capture.*

Setting Storage Parameters for Screen Captures

You can modify the file format of the screen captures as well as the destination folder, that is the folder to which the captures will be sent.

- By default, images are saved in .jpg format, but you can configure the application to save them in .png or .bmp format.
- By default, images are kept in the following folder:

`|DATA|My Documents|Screenshots`

You can select any other folder as the destination either locally on your unit, on a USB memory key. If you wish to create your own folders on the unit, use the File Manager from the Home screen.

Note: *If the specified folder is no longer available (folder name has been modified, folder has been deleted), the screen captures will be sent to a new folder whose name and path correspond to those of the specified folder. However, if you have defined a destination folder on a USB key and this key is not connected to your unit when you take screen captures, the latter will be sent to the default folder.*

To set the default image format:

1. From the Home screen, tap **Configuration**.
2. Tap **Devices and Utilities**.

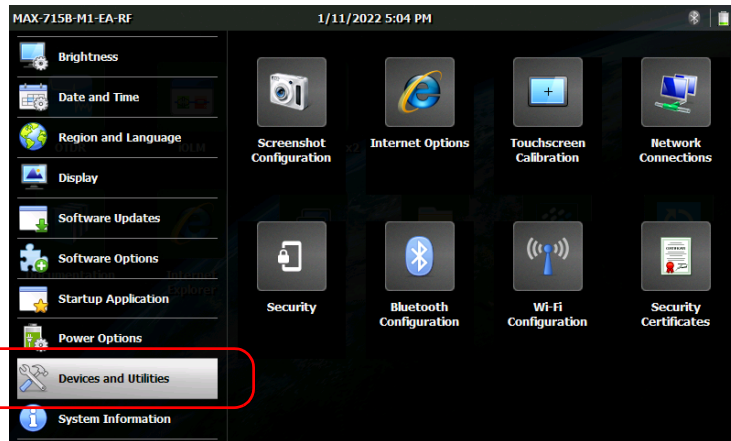

3. Tap **Screenshot Configuration**.
4. Under **Image format**, select the option corresponding to the desired format.



5. Tap **OK** to confirm the changes and close the window.

Working with Your Unit

Setting Storage Parameters for Screen Captures

To modify the destination folder:

1. From the Home screen, tap **Configuration**.
2. Tap **Devices and Utilities**.

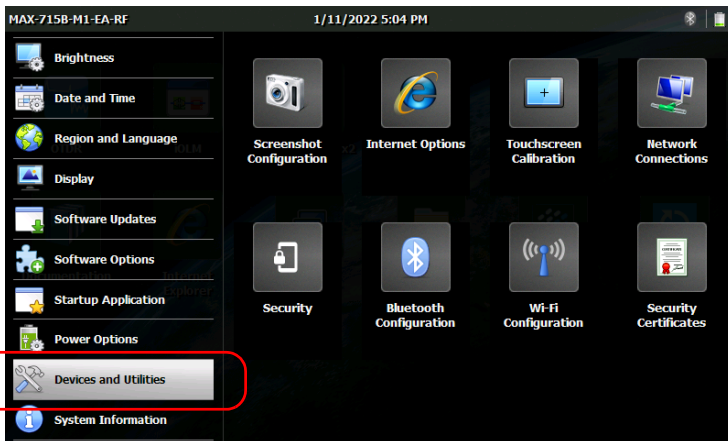

3. Tap **Screenshot Configuration**.
4. Under **Destination folder**, tap **Browse**.

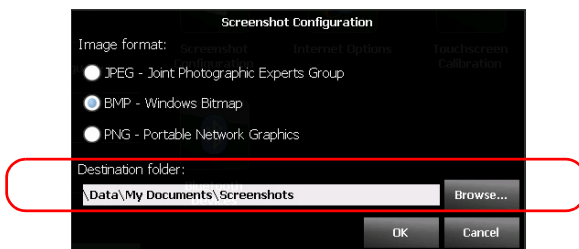

5. From the **Browse for Folder** window, select the folder that you want to use to store the screen captures.



6. When your selection is made, tap **OK**.
7. Tap **OK** to confirm the changes and close the window.

Browsing the Web

You can browse the Web directly from your unit, provided that you have access to an Internet connection.

If you need to modify the Internet options, see *Configuring the Internet Options* on page 59.

To browse the Web:

1. From the Home screen, tap the **Internet Explorer** icon to open the browser.

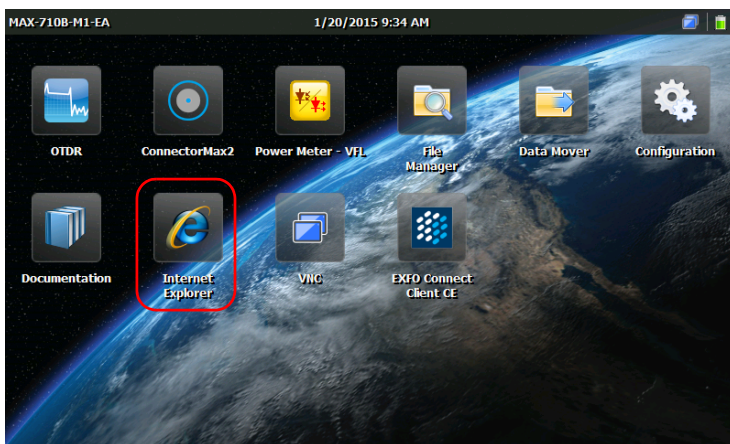

2. Enter the desired Web address in the address bar and tap the ENTER key from the on-screen keyboard to start browsing.



3. Press the  button or close the window to return to the Home screen.

6 **Using the Optional Built-In Power Meter and VFL**

Your unit can be equipped with an optical power meter to measure absolute power (dBm or W) or insertion loss (dB). The power meter can detect modulated signals (1 kHz, 2 kHz, 270 Hz, and 330 Hz).

Your unit can also include a visual fault locator (VFL) to inspect or identify fibers.

For more information on how to use the power meter or the VFL, refer to the power meter online help. You can access this online help directly from the Home screen (see *Accessing the Online Documentation on page 77*), or by tapping the  button from the power meter application.

Note: *The appearance of your application may vary depending on the options that you have purchased. The illustrations presented hereafter show the application as it appears when the unit is equipped with a built-in power meter and a VFL.*

To access the built-in power meter or the VFL:

From the Home screen, tap the **Power Meter - VFL** icon to open the application.



7 *Inspecting Fibers with a Probe*

The fiber inspection probe (FIP) is used to find dirty or damaged connectors by displaying an enlarged view of the connector surface. You can connect an FIP to your unit to view fiber ends.



IMPORTANT

Only the probes of the FIP-400B series are supported on your unit.

Fiber inspections are made using the ConnectorMax2 application. For more information, refer to the ConnectorMax2 online help. You can access this online help directly from the Home screen (see *Accessing the Online Documentation on page 77*), or by tapping the  button from the ConnectorMax2 application.

To inspect fibers with a probe:

1. Connect the probe to one of the USB ports on the top panel of your unit.
2. From the Home screen, tap the **ConnectorMax2** icon to open the application.

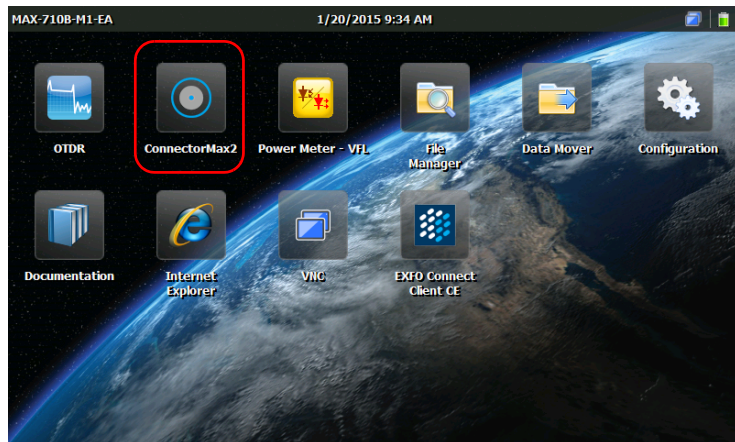

8 *Managing Data*

You can copy, move, rename, delete files and folders directly on your unit.

You can transfer files from your unit to a USB memory key or a computer. You can also transfer data from a storage device or a computer to your unit.

Your unit is equipped with the following ports and devices for data transfer:

- Two USB 2.0 ports to connect a memory key
- internal Wi-Fi and Bluetooth module (optional) to connect to a wireless network or transfer data via Bluetooth

Viewing Disk Space and Managing Files

To help you manage the data that is stored on your unit, you can easily view the remaining disk space. You can also copy, move, rename, delete files and folders directly on your unit.

To view the free disk space on your unit (DATA partition):

1. From the Home screen, tap **Configuration**.
2. Tap **System Information** > **Capacity**.

The free disk space is displayed under **Data (\Data) space used**.



3. From the unit's front panel, press the  button to return to the Home screen.

Managing Data

Transferring Data via Bluetooth

To manage files or folders on your unit only:

From the Home screen, select **File Manager**.

To transfer files or folders between your unit and a USB memory key:

Use the Data Mover application to easily transfer files and folders to a USB memory key (see *Transferring Files with the Data Mover Application* on page 115).

Transferring Data via Bluetooth

If your unit is equipped with the optional wireless module (internal), you can transfer data between your unit and a computer using the Bluetooth technology. By default, the Wi-Fi and Bluetooth module is enabled, but not connected to a network or a device.

If you have disabled the module, you must enable it before trying to transfer data via Bluetooth (see *Enabling or Disabling the Wi-Fi and Bluetooth Module* on page 112).

The computer that you use must run Windows, be equipped with a Bluetooth module (or adapter), and be configured properly.

Your unit must be located within a 9-meter area from your computer (limitation of the Bluetooth technology).

If you need to transfer large files (more than 100 MB), use a USB key, or connect to a Wi-Fi or an Ethernet network.

Configuring the Computer

To communicate via Bluetooth, your unit uses mobile device services, which means that Mobile Device Center (Windows Vista, Windows 7, and Windows 8), or ActiveSync (Windows XP) must be installed on your computer.

You can download and install the required application from the Microsoft Web site:

- ActiveSync for Windows XP:
<http://www.microsoft.com/en-us/download/details.aspx?id=15>
- Mobile Device Center for Windows Vista 32 bits, Windows 7 32 bits, or Windows 8 32 bits:
<http://www.microsoft.com/en-us/download/details.aspx?id=14>
- Mobile Device Center for Windows Vista 64 bits, Windows 7 64 bits, Windows 8 64 bits:
<http://www.microsoft.com/en-ca/download/details.aspx?id=3182>

To configure the computer:

- 1.** If necessary, download and install Mobile Device Center (or ActiveSync for Windows XP) on your computer.
- 2.** Configure the Bluetooth settings as follows:
 - 2a.** On the computer, from the taskbar, click the Bluetooth icon.
 - 2b.** Select **Open Settings**.
 - 2c.** Ensure that the option allowing Bluetooth devices to find the computer is selected.
 - 2d.** Click **OK** to confirm.

Pairing Devices with Your Unit

After the computer that you intend to use has been properly configured, you can pair (associate) it with your unit.

Once a device has been paired successfully with your unit, it remains paired (that is, ready for data transfer) as long as you do not remove the pairing yourself. Each time you turn on your unit, or resume your work after the unit has switched to suspend mode, the unit will try to establish a connection with the paired devices automatically.

The next time you open the Bluetooth configuration window, only the devices that have already been paired will be shown by default. However, if you prefer, you can scan for all of the devices available in the area (paired and not paired).

If no Bluetooth devices have been paired yet (or if all pairings have been removed), you will see an empty list when you open the configuration window. You can also scan for all available devices.

The  icon, displayed in the title bar, indicates the status of the Bluetooth connection. The following table shows the possibilities:

Icon	Meaning
Grey	The Wi-Fi and Bluetooth module is enabled, but no pairing and no choice of mobile service has been made.
Blue	At least one Bluetooth device has been paired successfully with your unit.
Not visible	<ul style="list-style-type: none">➤ Unit is not equipped with Wi-Fi and Bluetooth option.➤ Wi-Fi and Bluetooth are not supported on this model.➤ Wi-Fi and Bluetooth module is disabled (see <i>Enabling or Disabling the Wi-Fi and Bluetooth Module</i> on page 112).

Once the communication is established between your unit and the computer, you are ready to transfer data.

Managing Data

Transferring Data via Bluetooth



IMPORTANT

To avoid problems, always initiate the pairing *from* your unit (not from the Bluetooth devices).

To pair devices with your unit:

1. On your unit, from the Home screen, tap **Configuration**.
2. Tap **Devices and Utilities**.

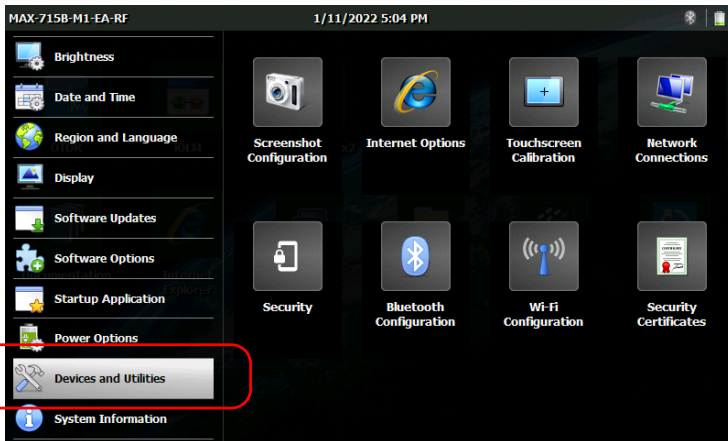

3. Tap **Bluetooth Configuration**.

Note: The **Bluetooth Configuration** icon is only visible on units that support wireless communication, and that are equipped with the optional wireless module.

4. Ensure that the **Enable Wi-Fi and Bluetooth** check box is selected.

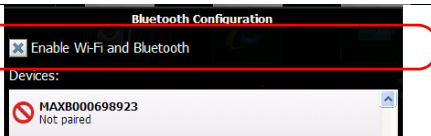

5. Tap **Find Devices** if you want to scan for all the Bluetooth devices that are available within your unit's range.

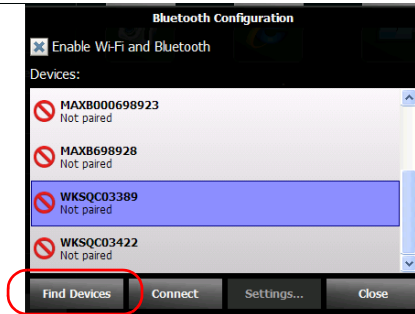

Note: If you do not scan for all the available devices, the application will either show you the list of paired devices, or an empty list if no pairing exist.

6. Tap the row corresponding to your computer.

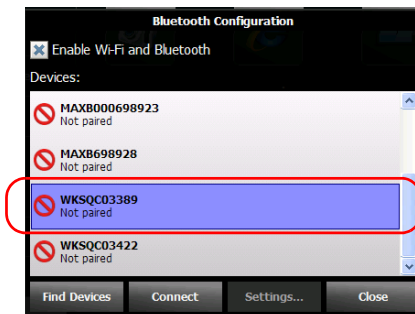

7. Tap **Connect**.

Note: Depending on the computer that you are using, the application will either provide you with a passkey, or prompt you to confirm that the displayed passkey matches the passkey used on the computer.

8. If necessary, write down the passkey displayed on screen.

Managing Data

Transferring Data via Bluetooth

9. On the computer, when the application prompts you, click the Bluetooth icon (located on the taskbar) to display the wizard allowing you to add a Bluetooth device.
10. Follow the on-screen instructions. Enter the passkey that you wrote down earlier, or confirm the correspondence between the two passkeys.

Note: On your unit, if necessary, tap **Yes** to close the passkey window.

Note: Once you have established a secured connection using a passkey, this passkey is kept in memory both on your unit and on the computer until you remove this connection from your unit (**Configuration > Devices and Utilities > Bluetooth Configuration > Disconnect**).

11. Ensure that the row corresponding to your paired computer is selected, and then tap **Settings** to activate the desired mobile service.

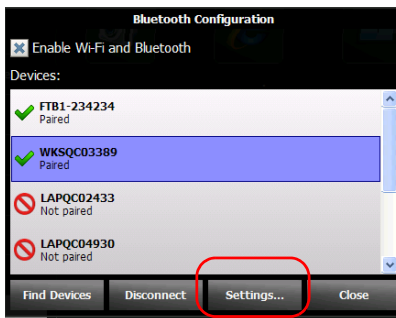

12. Select **Windows Mobile**, and then tap **OK**.

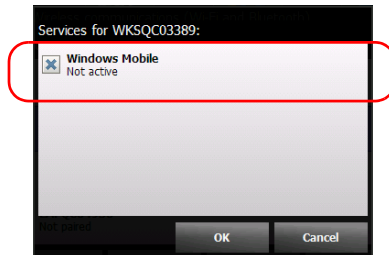

The unit tries to establish communication with the computer. Mobile Device Center starts automatically (on the computer).

13. On your unit, tap **Close** to close the Bluetooth configuration window.

You are now ready to start transferring files.

The unit will try to establish a connection with the paired devices automatically next at the next startup, or return from the suspend mode (a connection window will appear briefly).

Managing Data

Transferring Data via Bluetooth

Transferring Data

Once the Bluetooth communication is established between your unit and the computer, you can either transfer data using a file explorer or the file management feature of Mobile Device Center (both available from the computer).

Note: *On Windows 8, you cannot access the folders of your unit from a file explorer. You must use Mobile Device Center to transfer data.*

To transfer data from your unit to a computer with Mobile Device Center:

1. On the computer, from Mobile Device Center, click **Connect without setting up your device**.



2. Click File Management.



3. Click Browse the contents of your device.

4. Double-click the drive that is identified with “\” to access the folders on your unit.

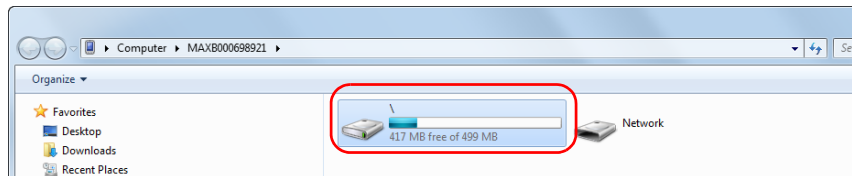

Note: *If you close Mobile Device Center, you may have to open it manually at next startup of the unit or when the unit returns from the suspend mode.*

Connecting to a Wireless Network

If your unit is equipped with the optional wireless module (internal), you can connect to a wireless network and benefit from all resources that are available on this network. You can transfer data exactly as you would do from an Ethernet network. By default, both the Bluetooth and Wi-Fi module is enabled, but not connected to a network or a device.

If you have disabled the module, you must enable it before trying to connect to a wireless network (see *Enabling or Disabling the Wi-Fi and Bluetooth Module* on page 112).

Once a connection has been established successfully with a wireless network, your unit remains connected to this network as long as you do not disconnect it yourself.

The networks to which the unit has been successfully connected are identified as “Saved” (favorite networks) and placed at the top of the list of networks. Each time that you work with your unit, it will attempt to connect to the first of the saved networks automatically (if the wireless module is enabled). If a specific saved network is not available, the unit switches to the next saved network on the list automatically.

You can remove saved networks from the list of networks to prevent automatic connections to these networks. If these networks are still in range, they will reappear in the list of networks so that they remain available for manual connection later.

The  icon, displayed both in the title bar and next to each of the available wireless networks, indicates the strength of the wireless signal.

The following table shows the possibilities:

Icon	Meaning
Entirely grey (in the list of networks)	The wireless network is out of range.
Partially or entirely green	The wireless network is in range of your unit. The number of displayed waves in green reflects the quality of the signal.
Not visible (in the title bar)	<ul style="list-style-type: none"> ➤ Unit is not equipped with Wi-Fi and Bluetooth option. ➤ Wi-Fi and Bluetooth are not supported on this model. ➤ Wi-Fi and Bluetooth module is disabled (see <i>Enabling or Disabling the Wi-Fi and Bluetooth Module</i> on page 112). ➤ The wireless network to which the unit was connected is now out of range. ➤ The unit is not connected to any wireless network.

By default, your unit supports unsecured networks and networks secured with the WPA2-PSK protocol. This means that you do not have any special configuration to make on your unit before connecting to such networks.

Note: *It is also possible to configure other types of protocols to match the type of network that you may have (Advanced configuration tool).*

The networks are identified either as “Unsecured” (no protocol) or “Secured” with the protocol that is used. Dimmed rows indicate networks that use a protocol requiring a manual configuration. In this case, you may need to contact your network administrator about the configuration details.

Managing Data

Connecting to a Wireless Network

To connect to a wireless network:

1. If it is not already done, share all the required folders on your computer. If you are not sure on how to proceed, contact your network administrator.
2. On your unit, from the Home screen, tap **Configuration**.
3. Tap **Devices and Utilities**.

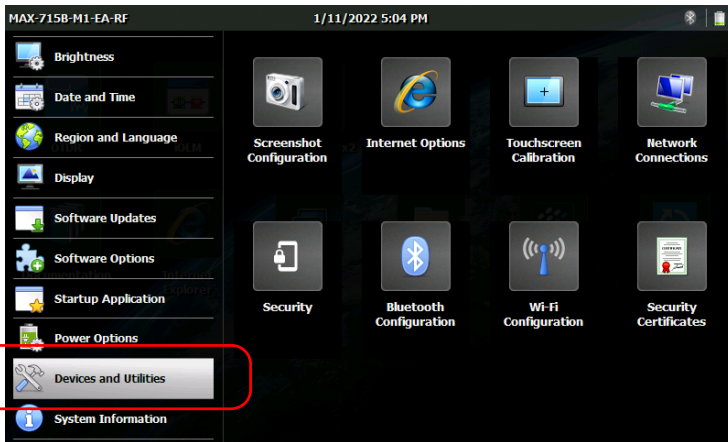

4. Tap **Wi-Fi Configuration**.

Note: *The **Wi-Fi Configuration** icon is only visible on units that support wireless communication, and that are equipped with the optional wireless module.*

5. Ensure that the **Enable Wi-Fi and Bluetooth** check box is selected.

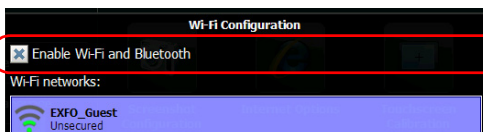

6. Tap the row corresponding to the network that you want to use.

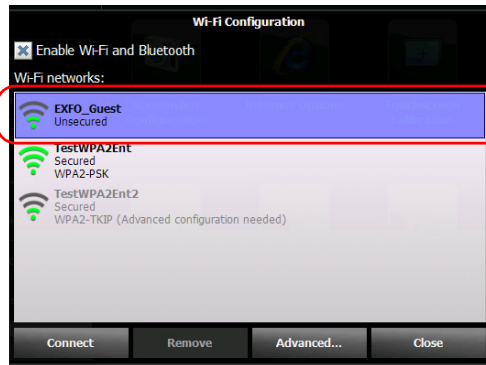

Note: The list of wireless networks is refreshed automatically at regular intervals.

7. Tap **Connect**.
8. If the network is protected by a network key (password) enter it in the corresponding box and tap **OK**.

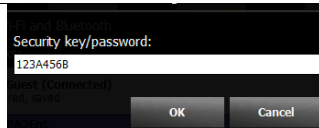

Note: Since all networks are different, you may also need to configure other parameters before being able to transfer data via Wi-Fi. For information on the configuration specific to your network, contact your network administrator.

As soon as the connection is established, you can start working with the selected wireless network. When you have finished, from the **Wi-Fi Configuration** window, tap **Disconnect** to stop communication with the wireless network.

Managing Data

Connecting to a Wireless Network

To define manual configurations:

1. If the network that you want to use requires a manual configuration, on your unit, from the Home screen, tap **Configuration**.
2. Tap **Devices and Utilities**.

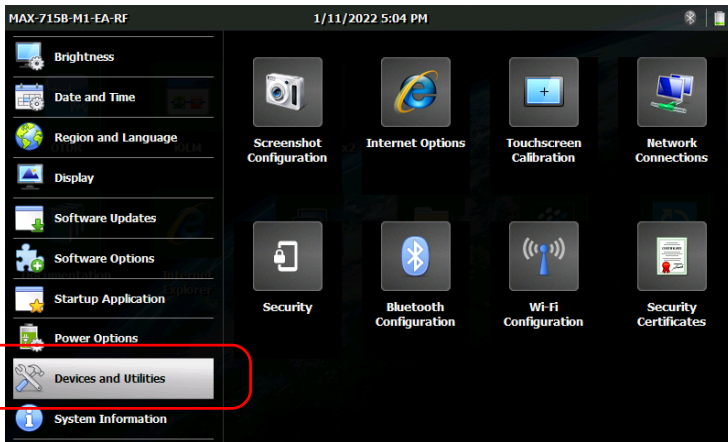

3. Tap **Wi-Fi Configuration**.

Note: The **Wi-Fi Configuration** icon is only visible on units that support wireless communication, and that are equipped with the optional wireless module.

4. Ensure that the **Enable Wi-Fi and Bluetooth** check box is selected.

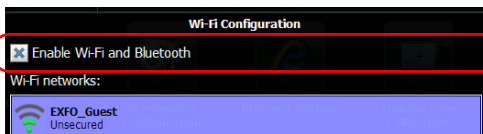

5. Tap **Advanced** to access the configuration tool.
The Wi-Fi Configuration window is closed automatically.

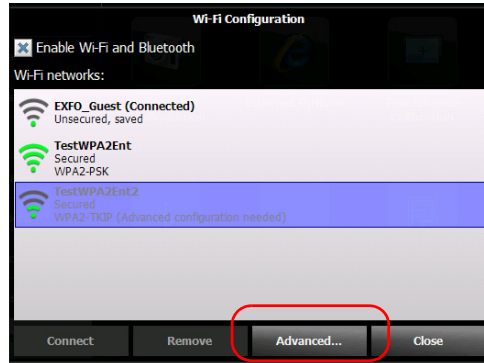

6. Set the parameters as needed.

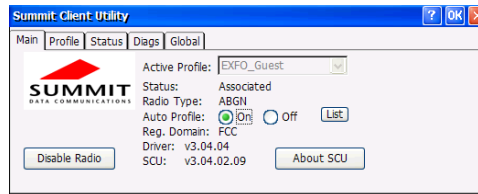

Note: Depending on the type of protocol that you select, you may have to use security certificates for authentication. For more information on the importation of such certificates in your unit, see *Managing Security Certificates* on page 114.

7. When the configuration is complete, tap **OK** to close the configuration window.

You are now ready to connect to the wireless network for which you have configured the connection parameters.

Managing Data

Enabling or Disabling the Wi-Fi and Bluetooth Module

Enabling or Disabling the Wi-Fi and Bluetooth Module

By default, the Wi-Fi and Bluetooth module is enabled on units that are equipped with the corresponding option.

However, if you do not intend to transfer files via Bluetooth or to work with a wireless network for a certain period of time, you may wish to disable the module to extend battery life. You may also wish to turn off wireless communication for a while (“airplane mode”).

As soon as you disable the wireless module, both the Wi-Fi and Bluetooth capabilities are disabled.

You can enable the module again at any time.

To enable or disable the Wi-Fi and Bluetooth module:

1. From the Home screen, tap **Configuration**.
2. Tap **Devices and Utilities**.

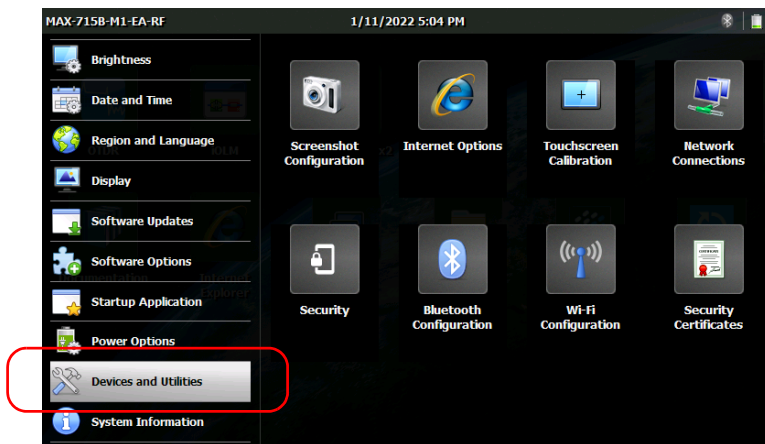

3. Tap Bluetooth Configuration or Wi-Fi Configuration.

Note: The **Bluetooth Configuration** and **Wi-Fi Configuration** icons are only visible on models that support wireless communication, and that are equipped with the optional wireless module.

4. Select the **Enable Wi-Fi and Bluetooth check box if you want to enable wireless communication, or clear it if you want to disable it.**

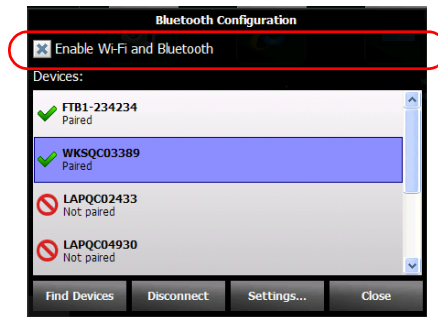

5. Tap **Close to return to the Configuration window.**

6. From the unit's front panel, press the  button to return to the Home screen.

The new selection is taken into account immediately.

Managing Data

Managing Security Certificates

Managing Security Certificates

You can import, view, or delete the certificates and private keys that are used for server and user authentication directly from your unit. The security certificates that are required depend on your network configuration. Contact your network administrator for more information.

To manage security certificates:

1. From the Home screen, tap **Configuration**.
2. Tap **Devices and Utilities**.

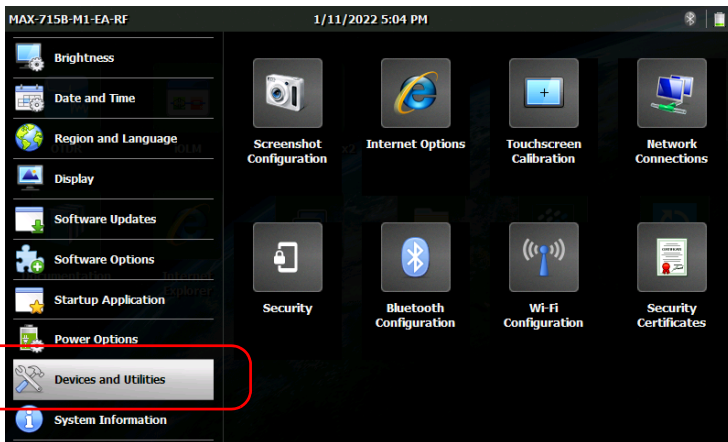

3. Tap **Security Certificates**.
4. Import, view, or remove the certificates as needed.

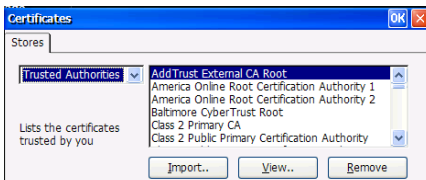

5. When you have finished, tap **OK**.

Transferring Files with the Data Mover Application

You cannot print documents and images directly from your unit. You must use a USB memory key to transfer the files to a computer that has access to a printer. If you need more flexibility and a greater choice of report types, you can also transfer result files to a computer onto which applications such as EXFO FastReporter 2 are installed.

With the Data Mover application, you can copy folders and files from your unit to a USB storage device quickly.

You can retrieve files from the predefined source folders or specify your own folders.

The predefined folder is:

My Documents, which path is `|DATA|My Documents`

Note: *You cannot remove the predefined folders from the list of source folders, but you can remove the ones that you have added.*

By default, the application retrieves the files from all the folders appearing on the list of source folders. However, you can specify which folders you want to take into account.

Managing Data

Transferring Files with the Data Mover Application

Each time you copy data, the application creates a folder on the storage device. This folder will contain the copied files and subfolders (original folder structure as well as folder and file names are kept).

The application generates folder names as follows:

[YEAR]-[MONTH]-[DAY]_[HOUR]-[MINUTE]-[SECOND]

Example:

For a copy operation requested on September 20, 2013, the folder name could be:

2013-09-20-13_23-01-45.

Note: *The HOUR value will appear in a 24-hour format, regardless of your unit's time settings.*

To transfer files with the Data Mover:

1. Connect a USB storage device to one of the USB ports.
2. From the Home screen, tap **Data Mover**.

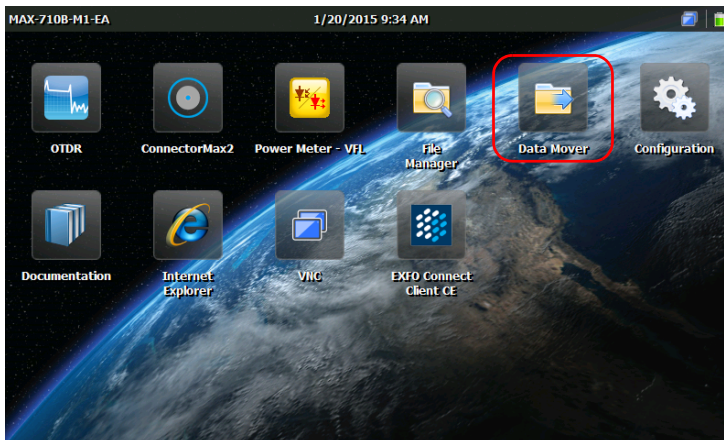

3. Select or clear the check boxes to adjust the folder selection to your needs.

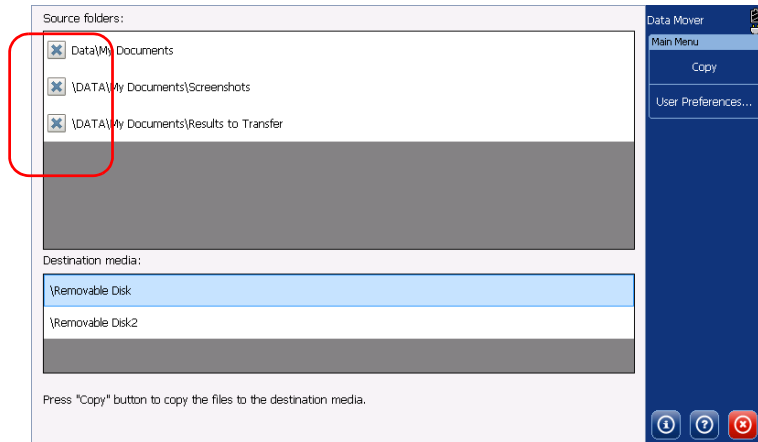

4. If necessary, under **Destination media**, select the desired USB storage device.
5. Tap **Copy**. The files will remain on your unit after the transfer.
6. When you have finished, tap  to exit the Data Mover application.

Managing Data

Transferring Files with the Data Mover Application

To manage the list of source folders:

1. From the Home screen, tap **Data Mover**.

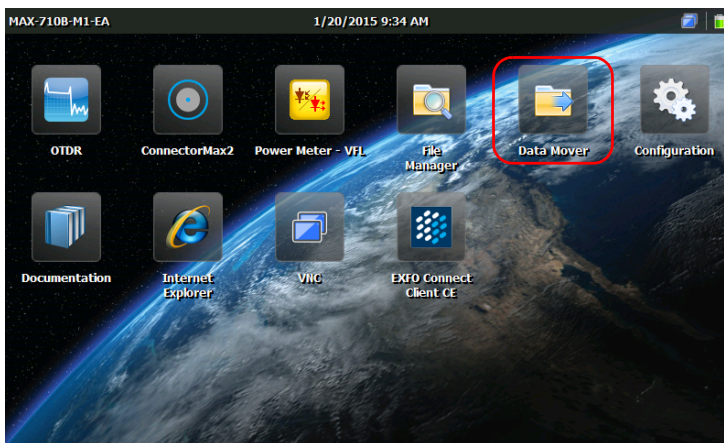

2. Tap **User Preferences**.



3. If you want to add your own folders to the list of source folders, proceed as follows:

- 3a. Tap Add a Folder.**

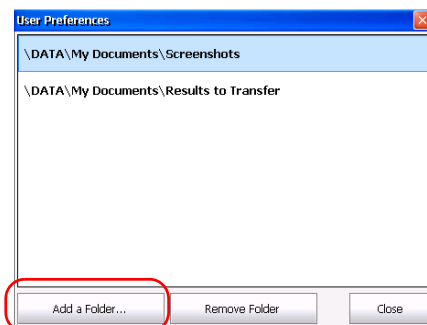

- 3b. Select the desired folder, and then tap OK.**

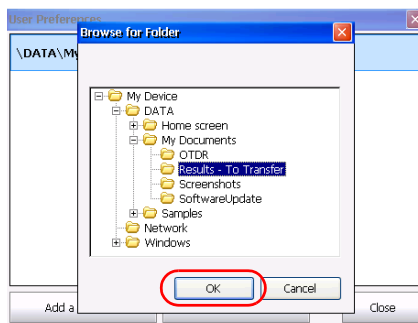

Managing Data

Transferring Files with the Data Mover Application

4. If you want to remove folders from the list of source folders, proceed as follows:
 - 4a. Select the folder that you want to remove.

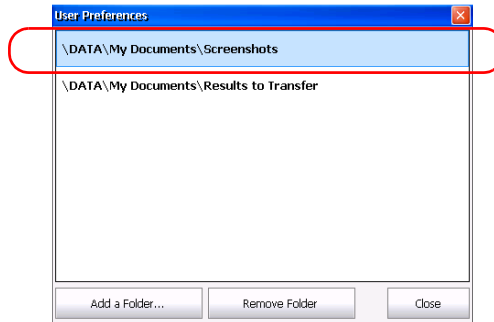

- 4b. Tap **Remove Folder**.

Note: *The application will not prompt you to confirm the removal of the folder from the list.*

5. When you have finished, tap **Close**. Your changes are reflected automatically. All the newly added folders are selected by default.
6. Tap  to exit the Data Mover application.

9 **Accessing Your Unit Remotely**

You can access your unit remotely from a computer using the TightVNC Client application.

The table below presents the characteristics of this application.

Characteristic	TightVNC Client
Type of connection	Not exclusive; several users can be connected to the unit at the same time (sharing the same session).
Password-protected	Yes; but not mandatory. For a more secure connection, you can define a password on the VNC Server from the VNC Server Properties window. By default, all people that use the TightVNC Client will enter the same password (as defined on the server). Each user to whom you provide the password will be able to connect to the unit via TightVNC.

Accessing Your Unit Remotely

The control of your unit with TightVNC requires the VNC Server (already installed on your unit) and the TightVNC Client Viewer (that you must install on your computer).

The first time you start the VNC Server on your unit, you may want to define a connection password for increased security. This is not mandatory; you can also configure the VNC Server to allow connections without authentication.

If you want VNC Server to start automatically when you turn on your unit, see *Selecting the Startup Application* on page 62.



IMPORTANT

As soon as you restart the unit (to change the display language, for example), the VNC Server will be stopped and the remote connection with the unit will be lost. You will need to restart the VNC Server locally on the unit before being able to reconnect via VNC.

To be able to connect to the unit using TightVNC, you must:

- Know the IP address of the unit and provide it in the connection settings on the computer.
- Know the password (same for all users by default).

This section provides you with the basic information to control your unit with TightVNC.

Configuring the VNC Server

The VNC Server is already installed on your unit. By default, the server is configured to accept secured connections only. This means that you must configure a password before establishing a connection between a computer and your unit.

However, you can modify the desired type of connection if you prefer not to be prompted for a password. You can also modify other connection settings to better suit your needs.



IMPORTANT

If you have configured the VNC Server to start automatically when you turn on your unit, you must stop the Server before being able to modify the VNC configuration.

Accessing Your Unit Remotely

Configuring the VNC Server

To configure the VNC Server:

1. From the Home screen, tap **VNC**.

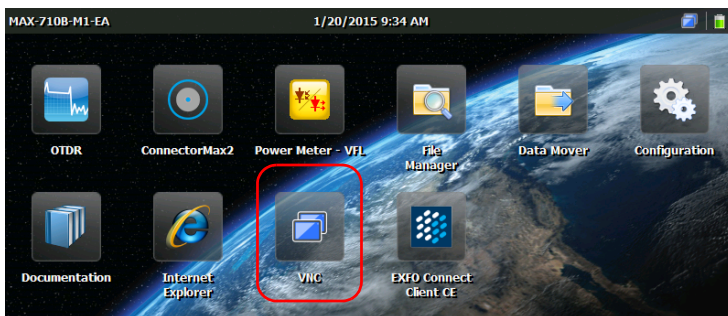

2. From the VNC toolbar, tap **Server Configuration**.

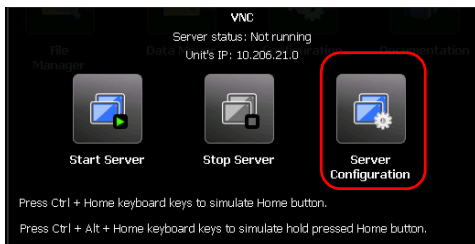

3. Select the option that best suits your needs.

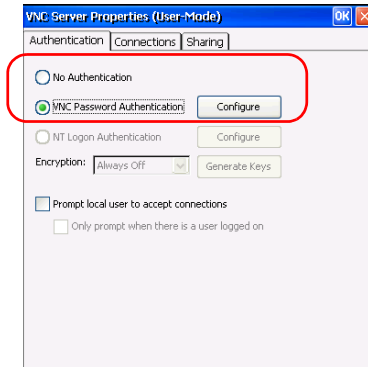

- If you do not want to be prompted for a password when you connect with TightVNC, select **No Authentication**.
- If you prefer to secure the connection with a password, select **VNC Password Authentication**.

Accessing Your Unit Remotely

Configuring the VNC Server

4. If you selected the **VNC Password Authentication** option, define the password as follows:
 - 4a. Tap the **Configure** button located next to the option.
 - 4b. Type the desired password.



- 4c. Tap **OK** to keep the new password.
5. From the **VNC Server Properties** window, tap **OK** to confirm the changes. If you prefer to discard all the modifications that you made (including the password), tap the  button.

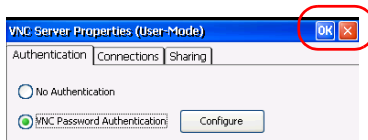

Installing the TightVNC Viewer on a Client Computer

If the TightVNC Viewer is not already installed on your computer, you can download it from the Web for free.



IMPORTANT

EXFO does not provide licenses for TightVNC Viewer. Always ensure that you are entitled to install it on your computer.

To install the TightVNC Viewer on your computer:

- 1.** Open a Web browser and go to <http://www.tightvnc.com/>.
- 2.** Download the version of the viewer that corresponds to the operating system that your computer is running.
- 3.** Double-click the file that you have just downloaded to start the installation.
- 4.** Follow the on-screen instructions.

Accessing Your Unit Remotely

Connecting to Your Unit with TightVNC

Connecting to Your Unit with TightVNC

Once the TightVNC Viewer is installed on your computer, you are ready to access your unit remotely.

To connect to your unit with TightVNC:

1. Connect both the computer and your unit to the same network and make sure they can “see” each other as network restrictions might prevent them from communicating.

Note: To use an Ethernet network, connect an RJ-45 (network) cable to the unit’s RJ-45 port located on its top panel.

2. Turn on both the computer and the unit.
3. On your unit, from the Home screen, tap VNC.

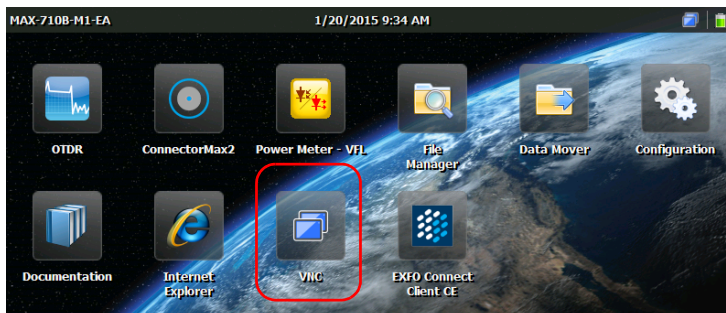

4. Write down the IP address.



Note: *It may take a few seconds before you can see the IP address.*

5. If you have configured VNC Server to start automatically when you turn on your unit, go directly to step 7. Otherwise, from the **VNC** toolbar, tap **Start Server**.
6. From the **VNC** toolbar, tap **Start Server**.



Note: The  icon appears in the upper right corner of the Home screen to indicate that the VNC Server is running, and that remote connections can be established with the unit.

7. From your computer, start the TightVNC Viewer.

Accessing Your Unit Remotely

Configuring VNC Server to Start Automatically

8. In the **Remote Host** list, type the IP address of your unit that you wrote down at step 4.

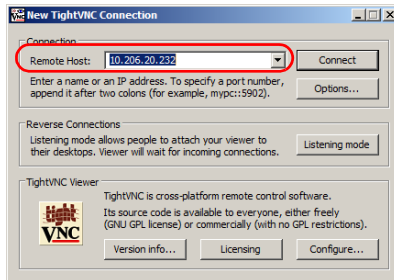

Note: *The appearance of the TightVNC Viewer window may vary depending on the version of the viewer that you have.*

9. Click **Connect**.
10. If the application prompts you for a password, enter it and click **OK** to confirm.

Configuring VNC Server to Start Automatically

By default, the VNC Server is not started automatically when you turn on your unit. However, you can modify this setting. This is especially useful if you need to remotely connect to your unit without having the unit close at hand.

If you want VNC Server to start automatically when you turn on your unit, see *Selecting the Startup Application* on page 62.

10 *Maintenance*

To help ensure long, trouble-free operation:

- Always inspect fiber-optic connectors before using them and clean them if necessary.
- Keep the unit free of dust.
- Clean the unit casing and front panel with a cloth slightly dampened with water.
- Store unit at room temperature in a clean and dry area. Keep the unit out of direct sunlight.
- Avoid high humidity or significant temperature fluctuations.
- Avoid unnecessary shocks and vibrations.
- If any liquids are spilled on or into the unit, turn off the power immediately, disconnect from any external power source, remove the batteries and let the unit dry completely.



WARNING

The use of controls, adjustments and procedures, namely for operation and maintenance, other than those specified herein may result in hazardous radiation exposure or impair the protection provided by this unit.

Cleaning Detector Ports

Regular cleaning of detectors will help maintain measurement accuracy.



IMPORTANT

Always cover detectors with protective caps when unit is not in use.

To clean detector ports:

1. Remove the protective cap and adapter (FOA) from the detector.
2. If the detector is dusty, blow dry with compressed air.
3. Being careful not to touch the soft end of the swab, moisten a cleaning tip with *only one drop* of optical-grade liquid cleaner.



IMPORTANT

Some cleaners may leave traces if used abundantly. Do not use bottles that distribute too much liquid at a time.

4. While applying light pressure (to avoid breaking the detector window), gently rotate the cleaning tip on the detector window.
5. Repeat step 4 with a dry cleaning tip or blow dry with compressed air.
6. Discard the cleaning tips after one use.

Cleaning VFL-Type Connectors

VFL-type connectors are fixed on your unit and can be cleaned using a mechanical cleaner.



WARNING

Verifying the surface of the connector with a fiber-optic microscope WHILE THE UNIT IS ACTIVE WILL result in permanent eye damage.

To clean a connector using a mechanical cleaner:

1. Insert the cleaning tip into the optical adapter, and push the outer shell into the cleaner.

Note: *The cleaner makes a clicking sound to indicate that the cleaning is done.*

2. Verify connector surface with a fiber inspection probe (for example, EXFO's FIP).

Maintenance

Cleaning the Touchscreen of Your Unit

Cleaning the Touchscreen of Your Unit

Clean the touchscreen with a soft, non-abrasive cloth, such as one used for cleaning reading glasses, dampened with water.



CAUTION

Using anything else than water can damage the special coating of the touchscreen.

Battery Safety Recommendations



WARNING

Risk of explosion if battery is replaced by an incorrect type. Dispose of used batteries according to the manufacturer's instructions.



WARNING

Do not throw batteries into fire or water and do not short-circuit their electrical contacts. Do not disassemble.



IMPORTANT

Recycle or dispose of used batteries properly, in accordance with local regulations. Do not dispose of them in ordinary garbage receptacles. For more information, see the section about recycling and disposal in this user documentation.

Recharging the Battery

Note: *Depending on the ambient temperature, the charge cycle may be interrupted automatically to prevent any damage to the battery.*

The battery in your unit is a lithium-polymer battery.

- The charge status is shown in the upper right corner of the Home screen.
- The information about the charge status is also available from **Configuration > System Information > Capacity**.
- Finally, the unit indicates the charge status with the LED on its front panel (see *LED Indicator Description* on page 5).



CAUTION

Only charge the battery with the AC/DC power adapter (or the car outlet adapter) provided by EXFO with your unit.



IMPORTANT

- ▶ Batteries are not charged at the factory. You must fully charge the battery before using the unit for the first time. The battery is fully charged after a few hours or when the battery LED indicator stops flashing.
- ▶ The time required to charge batteries depends on various factors such as the ambient temperature.
- ▶ To ensure that the battery functions and charges properly, keep it in temperatures between 10 °C and 40 °C (50 °F and 104 °F). Store it between -20 °C to 60 °C (-4 °F to 140 °F).
- ▶ The battery will not recharge when the ambient temperature is below 5 °C (41 °F) or above 40 °C (104 °F).
- ▶ To optimize the lifespan of the battery, disconnect the unit from the external AC power source once the battery is charged.
- ▶ Do not leave a battery discharged for more than two weeks.
- ▶ After 300 cycles (approximately 18 months of use), you may want to replace the battery with a new one to maintain optimal operation conditions. Otherwise, the operating time might be reduced.



IMPORTANT

- ▶ If the unit will not be used for more than two weeks, ensure that the battery is charged at around 50 % of its capacity, and then turn the unit off (shutdown). For optimum battery performance, follow the recommendations below about battery storage.
- ▶ If you need to store the battery for an extended period of time, place it in a cool dry place, and ensure that it is charged at around 50 % of its capacity. Every three months during the storage period, verify the battery level. Recharge the battery when necessary, so that its charge level remains around 50 % of the total capacity. This will ensure that you get the optimum performance out of the battery.

To recharge the battery:

Connect the unit to a power outlet using the AC/DC power adapter (or the car outlet adapter). The charge cycle will start and end automatically.

Note: *If the battery level is very low and the charge cycle does not start immediately, leave the unit connected to the power outlet for a few hours to allow the battery to recharge properly.*

Replacing the Battery

Your unit can be powered either by battery or from an appropriate power outlet when used with the provided AC/DC power adapter.



WARNING

- Your unit uses a lithium-polymer battery with built-in protection that has been especially designed for EXFO. For this reason, you can only replace it with batteries of the same type and model.
- To avoid damaging your unit, EXFO recommends that you send it to an authorized service center if it requires a battery replacement.
- However, you can purchase a new battery from EXFO. Only trained personnel should replace the battery in your unit. To avoid serious injuries as well as irreparable damages to your unit, **ALWAYS** follow the instructions provided with the new battery carefully.

Installing or Removing the Power Meter and VFL

If your unit was not equipped with a power meter (or a power meter and a VFL) at time of your initial purchase, you can purchase one afterwards and install it yourself.

You may also need to remove the power meter to send it to an authorized service center for recalibration.

Note: *If you prefer not to remove the power meter from your unit when a calibration is needed, you can also send the complete unit to the service center.*

Note: *The illustrations presented hereafter show a power meter and a VFL. The appearance of your test instrument may vary slightly depending on the model that you have purchased.*



WARNING

- To avoid serious injuries as well as irreparable damages both to your unit and your power meter, **ALWAYS TURN OFF YOUR UNIT** (shutdown mode, not suspend) and **DISCONNECT IT FROM THE EXTERNAL POWER SOURCE**. For more information on the ways to turn off your unit, see *Turning On or Off the Unit* on page 22.
- Always use caution during the installation or removal process. Even if the unit is disconnected from its external power source, the battery continues to provide power to certain areas of the unit.
- Be careful not to drop metal objects such as screws inside the unit. These could cause a short-circuit leading to a fire or an explosion.

Maintenance

Installing or Removing the Power Meter and VFL



CAUTION

Electrostatic discharge (ESD) damage can cause complete or intermittent equipment failures.

- Always use an ESD-preventive wrist or ankle strap when handling the power meter. Ensure that the antistatic strap makes good skin contact and that the end of its wire is grounded properly.
- Always handle the power meter by the edges of its metal faceplate (where the detector port is located).
- Never touch the circuit board.
- Keep any piece of clothing away from the power meter during the handling.
- Never touch any component inside the unit either with tools or your fingers.
- Only place the power meter on antistatic surfaces such as an antistatic mat, and quickly put power meters that need recalibration into antistatic bags.



CAUTION

Use only power meters and VFL designed for your unit and approved by EXFO.

To install a power meter:

1. Press and hold the On/Off button a few seconds until the unit beeps once to put it in shutdown mode.
2. Disconnect the unit from its external power source.
3. Put on a wrist (or an ankle) antistatic strap and ensure that the end of its wire is grounded properly.
4. Place the unit vertically so that its front panel is facing you.
5. On the top panel of the unit, locate the protective cover that hides the power meter bay.

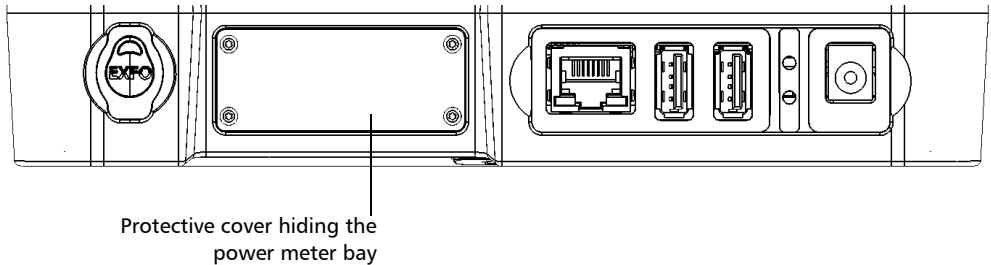

6. Using a screwdriver, remove the four screws of the protective cover.

Note: *Keep the screws close at hand because you will need them to secure the power meter in place later.*

7. Remove the protective cover.



IMPORTANT

Do not discard the protective cover. You will need it to protect the power meter bay if you ever send the power meter for recalibration.

Maintenance

Installing or Removing the Power Meter and VFL

8. By holding the power meter by its faceplate, position it so that the writings are right-side up.

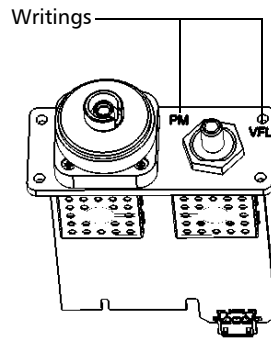

9. Carefully align the power meter with the corresponding bay.

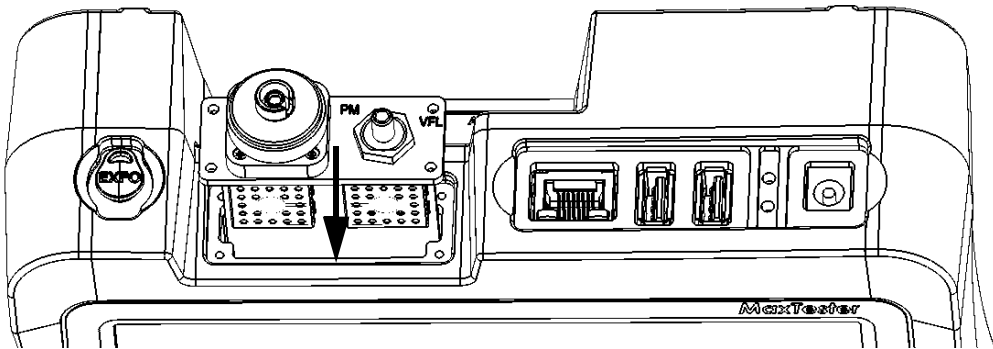

10. Gently slide the power meter into the bay until its faceplate is flush with the edge of the bay.
11. Using a screwdriver, secure the power meter in place with all the screws that you have removed at step 6.

- 12.** Remove your antistatic strap.
- 13.** Connect your unit to an external power source if desired.
- 14.** If it is not already done, turn on your unit.
- 15.** Start the power meter application to ensure that the instrument is working properly.

Note: *If the power meter is not detected, this could mean that it is not inserted properly in the unit. In this case, repeat the installation procedure. If the problem persists, contact EXFO.*

To remove the power meter for recalibration:

- 1.** Press and hold the On/Off button a few seconds until the unit beeps once to put it in shutdown mode.
- 2.** Disconnect the unit from its external power source.
- 3.** Put on a wrist (or an ankle) antistatic strap and ensure that the end of its wire is grounded properly.
- 4.** Place the unit vertically so that its front panel is facing you.

Maintenance

Installing or Removing the Power Meter and VFL

5. On the top panel of the unit, locate the power meter.
6. Using a screwdriver, remove the four screws of the power meter.

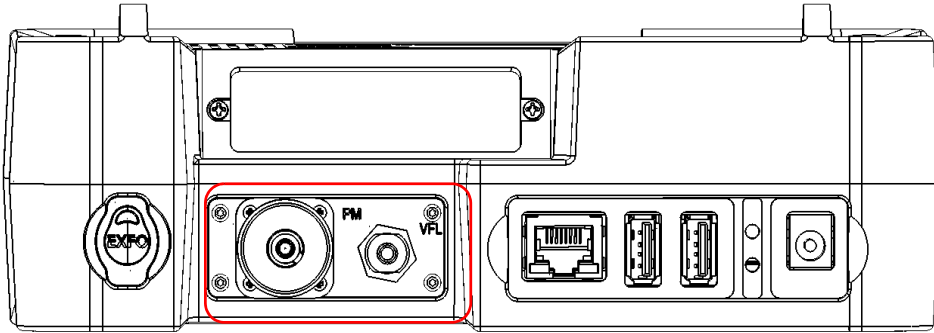

Note: *If you have a protective cover for the power meter bay, keep the screws close at hand. You will need them to secure the protective cover in place later.*



IMPORTANT

Do not discard the screws. You will need them to secure the power meter in its bay when it is back from calibration.

- 7.** By holding the power meter by its faceplate, gently pull it out of the bay completely.

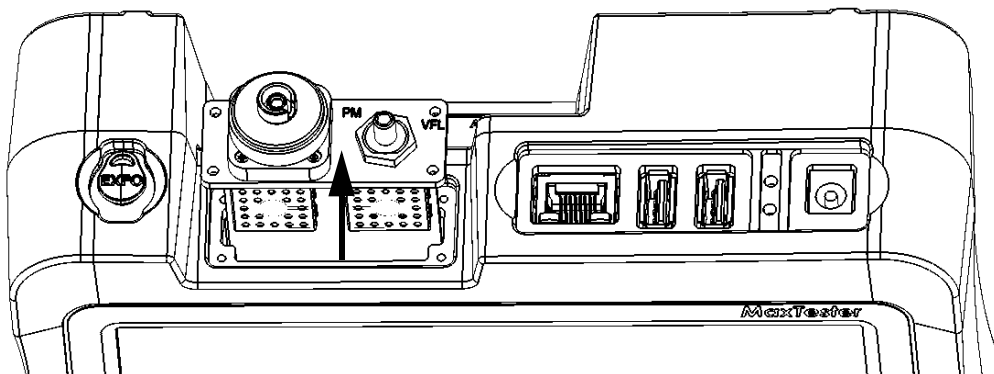

- 8.** Place the power meter in an antistatic bag.
- 9.** If you have a protective cover, proceed as follows:
 - 9a.** Carefully place the cover over the power meter bay.
 - 9b.** Using a screwdriver, secure the protective cover in place with all the screws that you have removed at step 6.
- 10.** Remove your antistatic strap.
- 11.** Connect your unit to an external power source if desired.

Maintenance

Recycling and Disposal

Recycling and Disposal



This symbol on the product means that you should recycle or dispose of your product (including electric and electronic accessories) properly, in accordance with local regulations. Do not dispose of it in ordinary garbage receptacles.

For complete recycling/disposal information, visit the EXFO Web site at www.exfo.com/recycle.

11 Troubleshooting

Solving Common Problems

Problem	Cause	Solution
Unit does not turn on.	Battery is discharged.	<ul style="list-style-type: none">➤ Charge the battery.➤ Connect the unit to an external power supply using the AC/DC power adapter (or the car outlet adapter). <p>If the unit still does not turn on, press and hold down the power button for at least 12 seconds to force a hardware reset on the unit. Release the power button, and then restart your unit as usual.</p>
	Unit is not connected to an external power supply.	<p>Connect the unit to an external power supply using the AC/DC power adapter (or the car outlet adapter).</p> <p>If the unit still does not turn on, press and hold down the power button for at least 12 seconds to force a hardware reset on the unit. Release the power button, and then restart your unit as usual.</p>
	External power supply is disconnected.	<p>Make sure the external power supply is connected at both ends.</p> <p>If the unit still does not turn on, press and hold down the power button for at least 12 seconds to force a hardware reset on the unit. Release the power button, and then restart your unit as usual.</p>

Troubleshooting

Solving Common Problems

Problem	Cause	Solution
Unit screen is dark.	Unit's backlight is set to minimum value.	Modify brightness (see <i>Adjusting Brightness</i> on page 41).
	Battery is discharged and unit has shut down.	<ul style="list-style-type: none">➤ Charge the battery.➤ Connect the unit to an external power supply using the AC/DC power adapter (or the car outlet adapter).
External keyboard is not working.	External keyboard has not been detected.	<ul style="list-style-type: none">➤ Disconnect the keyboard, and then connect it again.➤ Turn off the unit, connect the keyboard, and turn on the unit.
The USB memory key is not working.	The USB memory key has not been detected.	Disconnect the memory key, and then connect it again.
	The file system used on the memory key may not be supported. The supported file systems are: FAT, FAT32, and exFAT. The NTFS file system is not supported.	To avoid losing data, proceed as follows: <ul style="list-style-type: none">➤ On a computer, connect the USB memory key, and then back up any important data that you want to keep.➤ Format the USB memory key to one of the supported file system (FAT, FAT32, or exFAT). The USB memory key should now be detected properly.
The keyboard, mouse or USB memory key no longer seem to be detected properly after browsing the Maintenance and Recovery menu.	The maintenance mode has been enabled by mistake.	Restart your unit.

Problem	Cause	Solution
Screen characters are dim.	Brightness is not set properly.	Modify brightness (see <i>Adjusting Brightness</i> on page 41).
Even though you have performed a screen calibration recently, the screen is no longer calibrated properly.	The unit is no longer powered by the same power source (battery or AC) that was in use at the time of screen calibration.	<p>Changes in the power source require a new calibration. The new calibration values will be kept in memory for future use in the exact same conditions.</p> <p>Before proceeding with the new calibration, you may want to ensure that your unit currently uses the power source (battery or AC) that will be used most of the time.</p> <p>For more information on how to perform a new calibration, see <i>Recalibrating the Touchscreen</i> on page 60.</p>
One of the applications is not responding.		<p>Press and hold the On/Off button a few seconds until the unit beeps once.</p> <p>Turn the unit on again to reset it.</p>
The unit only remains connected to the Wi-Fi network for a few seconds before being disconnected. The unit then tries to reconnect to the network several times, but is disconnected after a few seconds each time.	There could have been an error in the password used to connect to the Wi-Fi network.	Disconnect the unit from the Wi-Fi network (see <i>Connecting to a Wireless Network</i> on page 106), and then try to establish a new connection with the password.

Troubleshooting

Solving Common Problems

Problem	Cause	Solution
Unit's operating time is reduced.	Battery was not fully charged.	Charge the battery.
	Battery is probably worn out.	See <i>Service and Repairs</i> on page 165.
Batteries are not charging.	Ambient temperature is too high or too low.	Ensure that the temperature in the location where you charge the batteries is within the specifications.
	AC/DC power adapter (or the car outlet adapter) is not connected properly.	Ensure that the adapter/charger (or the car adapter) is connected both to your unit and the power outlet.
	AC/DC power adapter in use has the wrong voltage for your unit (slow blinking red LED).	Ensure that you use the adapter/charger provided with your unit (see <i>Electrical Safety Information</i> on page 13 for more information).
Even though the battery has been charged, the battery LED remains red and the displayed charge status (visible from Home screen or from Configuration > System Information > Capacity) indicates a battery level below the critical value.	Battery level has not been refreshed properly.	Press and hold down the power button for at least 12 seconds to force a hardware reset on the unit. Release the power button, and then restart your unit as usual. The battery level should now be indicated correctly.

Problem	Cause	Solution
Unit switches to suspend mode unexpectedly.	Power management options are not defined correctly.	Ensure that the definition of the power options suits your needs. For more information, see <i>Configuring the Power Management Options</i> on page 57.
Unit is not responding.		Restore your unit (see <i>Restoring Your Unit to Normal Operation</i> on page 152).

Troubleshooting

Restoring Your Unit to Normal Operation

Restoring Your Unit to Normal Operation

If you ever encounter major problems with your MaxTester Series unit (for example, you cannot start it), you can revert your unit to its initial state (as it was when you purchased it). For current updates, use the Software Update tool.



CAUTION

- ▶ Before starting the recovery operation, connect your unit to a power outlet using the provided AC adapter/charger.
- ▶ **DO NOT TURN OFF** your unit while the recovery operation is underway. Doing so may severely damage your unit. Damaged units will need to be sent back to EXFO for repair.





IMPORTANT

The recovery operation cannot be undone or stopped once it is started.



If you have installed software updates on your unit, you will have to reinstall them afterwards.

To avoid losing the data that is stored on the DATA partition (such as result files or custom background images), you may want to transfer it to a USB key before restoring your unit. Otherwise, all your files will be lost.

To navigate in the various windows using the unit's buttons:

- Press the  button to select an item. Repeat until the desired item is selected (highlighted).
- Press the  button for two seconds to confirm the selection.

To restore your unit to normal operation:

1. Turn off the unit.
2. Ensure that your unit will remain powered on during the operation by connecting it to a power outlet using the provided AC adapter/charger.
3. Press the  and  buttons simultaneously to display the **Maintenance and Recovery** menu.

Troubleshooting

Restoring Your Unit to Normal Operation

4. Select **Start Recovery Procedure** and confirm your choice.

```
--- Maintenance and Recovery ---
A) Exit
B) Start Recovery Procedure
C) Maintenance Mode: Disabled

Press Home button to select an item.
Press Home button for 2 sec. to activate the selected item.
Press Power button to turn off unit.
```

5. Select **Start** and confirm your choice to proceed with the recovery operation. The operation may take a few minutes. The unit will restart upon completion of the process.

```
*** CAUTION ***

Connect the external power supply to unit.
Do not turn off unit during recovery procedure.

*** IMPORTANT ***

Configuration and measurement data will be erased.
Any software update previously installed will need to be
reinstalled.

Do you want to proceed? [ Cancel ] [ Start ]

Press Home button to select an item.
Press Home button for 2 sec. to activate the selected item.
Press Power button to turn off unit.
```

Contacting the Technical Support Group

To obtain after-sales service or technical support for this product, contact EXFO at one of the following numbers. The Technical Support Group is available to take your calls from Monday to Friday, 8:00 a.m. to 7:00 p.m. (Eastern Time in North America).

Technical Support Group

400 Godin Avenue
Quebec (Quebec) G1M 2K2
CANADA

1 866 683-0155 (USA and Canada)
Tel.: 1 418 683-5498
Fax: 1 418 683-9224
support@exfo.com

For detailed information about technical support, and for a list of other worldwide locations, visit the EXFO Web site at www.exfo.com.

To accelerate the process, please have information such as the name and the serial number (see the product identification label), as well as a description of your problem, close at hand.

Viewing System Information

You can easily access important information such as serial numbers, or version numbers for kits and components directly from your unit. You can also find the contact information if you ever need to reach EXFO.

Retrieving the Serial Numbers

Your unit may display one or more serial numbers, depending on the test instruments that you have.

To retrieve the serial numbers:

1. From the Home screen, tap **Configuration**.
2. Tap **System Information** > **Hardware**.

The serial numbers are all listed.

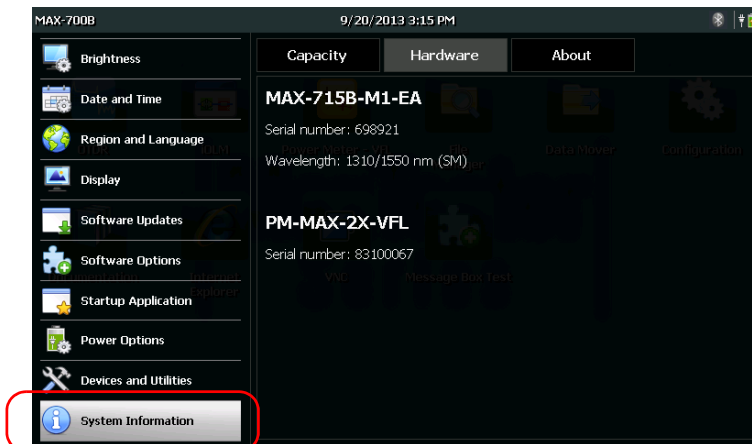

3. From the unit's front panel, press the  button to return to the Home screen.

Retrieving the Component Versions

You can view the system image version as well as the software version of the Home screen application that are installed on your unit.

To retrieve the component versions:

1. From the Home screen, tap **Configuration**.
2. Tap **System Information** > **About**.

The component versions are listed above the contact information.



3. From the unit's front panel, press the  button to return to the Home screen.

Troubleshooting

Viewing System Information

Retrieving the Contact Information

All the information necessary to contact EXFO is available from your unit.

To retrieve the contact information:

1. From the Home screen, tap **Configuration**.
2. Tap **System Information** > **About**.

The contact information is displayed.



3. From the unit's front panel, press the  button to return to the Home screen.

Transportation

Maintain a temperature range within specifications when transporting the unit. Transportation damage can occur from improper handling. The following steps are recommended to minimize the possibility of damage:

- Pack the unit in its original packing material when shipping.
- Avoid high humidity or large temperature fluctuations.
- Keep the unit out of direct sunlight.
- Avoid unnecessary shocks and vibrations.

12 Warranty

General Information

EXFO Inc. (EXFO) warrants this equipment against defects in material and workmanship for a period of one year from the date of original shipment. EXFO also warrants that this equipment will meet applicable specifications under normal use.

During the warranty period, EXFO will, at its discretion, repair, replace, or issue credit for any defective product, as well as verify and adjust the product free of charge should the equipment need to be repaired or if the original calibration is erroneous. If the equipment is sent back for verification of calibration during the warranty period and found to meet all published specifications, EXFO will charge standard calibration fees.



IMPORTANT

The warranty can become null and void if:

- unit has been tampered with, repaired, or worked upon by unauthorized individuals or non-EXFO personnel.
- warranty sticker has been removed.
- case screws, other than those specified in this guide, have been removed.
- case has been opened, other than as explained in this guide.
- unit serial number has been altered, erased, or removed.
- unit has been misused, neglected, or damaged by accident.

THIS WARRANTY IS IN LIEU OF ALL OTHER WARRANTIES EXPRESSED, IMPLIED, OR STATUTORY, INCLUDING, BUT NOT LIMITED TO, THE IMPLIED WARRANTIES OF MERCHANTABILITY AND FITNESS FOR A PARTICULAR PURPOSE. IN NO EVENT SHALL EXFO BE LIABLE FOR SPECIAL, INCIDENTAL, OR CONSEQUENTIAL DAMAGES.

Warranty

Gray Market and Gray Market Products

Gray Market and Gray Market Products

Gray market is a market where products are traded through distribution channels that are legal but remain unofficial, unauthorized, or unintended by the original manufacturer. Intermediaries using such channels to distribute products are considered to be part of the gray market (hereafter unauthorized intermediary).

EXFO considers that a product originates from the gray market (hereafter gray market product) in the following situations:

- A product is sold by an unauthorized intermediary.
- A product is designed and destined for a particular market and sold on a second market.
- A product is resold, despite being reported lost or stolen.

When products are purchased on the gray market, rather than through an authorized EXFO distribution channel, EXFO is unable to guarantee the source and quality of those products nor the local safety regulations and certifications (CE, UL, etc.).

EXFO will not honor warranty, install, maintain, repair, calibrate, provide technical support nor make any support contracts available for gray market products.

For complete information, refer to EXFO's policy regarding gray market products at www.exfo.com/en/how-to-buy/sales-terms-conditions/gray-market/

Liability

EXFO shall not be liable for damages resulting from the use of the product, nor shall be responsible for any failure in the performance of other items to which the product is connected or the operation of any system of which the product may be a part.

EXFO shall not be liable for damages resulting from improper usage or unauthorized modification of the product, its accompanying accessories and software.

Warranty

Exclusions

Exclusions

EXFO reserves the right to make changes in the design or construction of any of its products at any time without incurring obligation to make any changes whatsoever on units purchased. Accessories, including but not limited to fuses, pilot lamps, batteries and universal interfaces (EUI) used with EXFO products are not covered by this warranty.

This warranty excludes failure resulting from: improper use or installation, normal wear and tear, accident, abuse, neglect, fire, water, lightning or other acts of nature, causes external to the product or other factors beyond the control of EXFO.



IMPORTANT

In the case of products equipped with optical connectors, EXFO will charge a fee for replacing connectors that were damaged due to misuse or bad cleaning.

Certification

EXFO certifies that this equipment met its published specifications at the time of shipment from the factory.

Service and Repairs

EXFO commits to providing product service and repair for five years following the date of purchase.

To send any equipment for service or repair:

- 1.** Call one of EXFO's authorized service centers (see *EXFO Service Centers Worldwide* on page 166). Support personnel will determine if the equipment requires service, repair, or calibration.
- 2.** If equipment must be returned to EXFO or an authorized service center, support personnel will issue a Return Merchandise Authorization (RMA) number and provide an address for return.
- 3.** If possible, back up your data before sending the unit for repair.
- 4.** Pack the equipment in its original shipping material. Be sure to include a statement or report fully detailing the defect and the conditions under which it was observed.
- 5.** Return the equipment, prepaid, to the address given to you by support personnel. Be sure to write the RMA number on the shipping slip. *EXFO will refuse and return any package that does not bear an RMA number.*

Note: *A test setup fee will apply to any returned unit that, after test, is found to meet the applicable specifications.*

After repair, the equipment will be returned with a repair report. If the equipment is not under warranty, you will be invoiced for the cost appearing on this report. EXFO will pay return-to-customer shipping costs for equipment under warranty. Shipping insurance is at your expense.

Routine recalibration is not included in any of the warranty plans. Since calibrations/verifications are not covered by the basic or extended warranties, you may elect to purchase FlexCare Calibration/Verification Packages for a definite period of time. Contact an authorized service center (see *EXFO Service Centers Worldwide* on page 166).

Warranty

EXFO Service Centers Worldwide

EXFO Service Centers Worldwide

If your product requires servicing, contact your nearest authorized service center.

EXFO Headquarters Service Center

400 Godin Avenue
Quebec (Quebec) G1M 2K2
CANADA

1 866 683-0155 (USA and Canada)
Tel.: 1 418 683-5498
Fax: 1 418 683-9224
support@exfo.com

EXFO Europe Service Center

Winchester House, School Lane
Chandlers Ford, Hampshire S053 4DG
ENGLAND

Tel.: +44 2380 246800
Fax: +44 2380 246801
support.europe@exfo.com

EXFO Telecom Equipment (Shenzhen) Ltd.

3rd Floor, Building C,
FuNing Hi-Tech Industrial Park, No. 71-3,
Xintian Avenue,
Fuhai, Bao'An District,
Shenzhen, China, 518103

Tel: +86 (755) 2955 3100
Fax: +86 (755) 2955 3101
support.asia@exfo.com

To view EXFO's network of partner-operated Certified Service Centers nearest you, please consult EXFO's corporate website for the complete list of service partners:

<http://www.exfo.com/support/services/instrument-services/exfo-service-centers>.

Index

A

AC power	
adapter.....	7
indicator.....	27
operation.....	57
AC requirements.....	15, 16
accessing power meter.....	91
ActiveSync.....	97
adapter.....	14, 135
adding custom backgrounds.....	54
adjusting	
brightness.....	41
date, time and time zone.....	43
admin password.....	66
after-sales service.....	155
airplane mode.....	112
amber LED.....	5
appearance, date and time.....	51
applications, installing.....	30
asian characters.....	46
associating devices.....	98, 100
AZERTY.....	46

B

background picture, changing.....	53, 56
backlight, setting.....	41
battery	
error.....	5
LED.....	2
level.....	5, 27, 135
maintenance recommendations.....	135
operation.....	57
recharging.....	137
replacing or removing.....	138
type allowed.....	138
black LED.....	5
blinking LED.....	5

Bluetooth

data transfer.....	96, 104
frequency band data.....	xiii
icon.....	99
limitations.....	96
pairing.....	98, 100
sticker.....	3
boot, first.....	24
brightness, adjusting.....	41
browsing Web.....	88
button description.....	6

C

calibrating the touchscreen.....	60
capacitors.....	14
capacity, storage.....	95
capturing images.....	82
car outlet adapter.....	7, 137
caution	
of personal hazard.....	8
of product hazard.....	8
changing	
background picture.....	53, 56
batteries.....	138
default formats.....	49
charge icon.....	135
charger.....	14, 135
cleaning	
detector ports.....	132
front panel.....	131
touchscreen.....	134
VFL connectors.....	133
clearing passwords.....	75
client, TightVNC.....	121, 127
closing applications.....	28
component versions.....	157
computer, configuring.....	97

Index

configuring		
computer.....	97	
network settings.....	64	
power schemes.....	57	
unit.....	24	
VNC server parameters.....	123	
VNC server to start automatically.....	130	
wireless connection.....	110	
connecting		
unit to network.....	4	
unit to wireless network.....	106	
unit with TightVNC.....	128	
USB device.....	38	
connector cleaner.....	133	
ConnectorMax2.....	93	
contact information.....	158	
conventions, safety.....	8	
copying files and folders.....	96	
creating passwords.....	67	
current, electrical.....	15	
custom		
backgrounds, adding.....	54	
configuration.....	110	
customer service.....	165	
D		
data		
entry.....	29	
transfer.....	96	
date and time formats.....	51	
date, setting.....	43	
deactivating		
keyboard.....	46	
Wi-Fi and Bluetooth.....	112	
decimal separator.....	52	
defining personal folders.....	115	
deleting files and folders.....	96	
description		
keypad.....	6	
LED.....	5	
detector port, cleaning.....	132	
device, not working properly.....	152	
dimming screen.....	57	
dirty fibers.....	93	
disk space, free.....	95	
display, language.....	44	
documents, printing.....	77	
E		
enabling wireless device.....	112	
encryption and protocol.....	110	
end-user license agreement.....	24	
entering data.....	29	
ethernet port.....	4	
exiting applications.....	28	
Explorer, Internet.....	88	
exporting passwords.....	72	
external power supply.....	14, 135	
F		
factory settings.....	152, 153	
favorite networks.....	106	
fiber probe.....	93	
file size limit, Bluetooth.....	96	
files and folders, managing.....	96	
first startup.....	24	
flashing LED.....	5	
folders, removing.....	115	
format, global language.....	49	
free disk space.....	95	
frequency, Bluetooth and Wi-Fi.....	xiii	
front panel, cleaning.....	131	
G		
global language format.....	49	
green LED.....	5	
H		
hardware buttons.....	6	
hazard, laser radiation.....	12	

Index

new version of software 30
normal operation 153
numeric values 52

O

off, LED 5
on/off button 2, 6
on-screen keyboard 29
opening ConnectorMax2 93
options
 Internet 59
 power meter and VFL 1
 software 35
 stand 18
 supports 17
 used at startup 62

P

pairing Bluetooth devices 98, 100
parameters, network 64
passwords
 administrator 66
 creating 67
 exporting 72
 importing 73
 resetting 75
 user 66
PDF files, viewing 77
physical keyboard 38
pinyin 46
ports, unit 4
power
 button 6
 configuring schemes 57
 management options 57
 sources 7, 15
 supply 14, 135
power meter
 accessing 91
 installing 139, 141
 location 4

 maintenance 139
 removing 139, 143
predefined folders 115
preferred networks 106
printing documents 77
product
 identification label 155
 specifications 7
protection with a password 66
protective cap 132
protocol 110
purchased options 35

Q

quick settings, brightness 42
QWERTY/QWERTZ 46

R

radiation hazard, laser 12
real keyboard 38
recalibrating touchscreen 60
recovery 152
red LED 5
regional and language settings 24
regulatory information viii, xi
remaining disk space 95
remote control 121
removing
 power meter 139, 143
 VFL 139
repairing unit 13, 153
replacing or removing battery 138
resetting passwords 75
restoring unit 153
retrieving
 component versions 157
 contact information 158
 serial numbers 156
RJ-45 port 4

S	
safety	
caution	8
conventions	8
information	12
warning	8
saved networks	106
screenshots, taking	82
security certificates	114
serial numbers	156
server, VNC	121
service and repairs	165
service centers	166
setting	
computer parameters	97
date and time	51
decimal separator	52
short and long formats, date	51
shutdown modes	22
sleep mode	57
software	
installation	30
options	35
options at startup	62
specifications, product	7
stand, unit	3
starting	
applications	27, 28
power meter application	91
probe application	93
wireless module	112
startup option	62
status	
Bluetooth connection	99
wireless communication	106
stopping wireless module	112
storage path	84
storage requirements	131, 137
surfing the Internet	88
suspend mode	22
T	
switching	
between applications	28
language	44
symbols, safety	8
T	
technical specifications	7
technical support	155
temperature for storage	131
TightVNC	
connection to the unit	128
viewer	121, 127
time and time zone, setting	43
touchscreen	
calibrating	60
cleaning	134
transferring	
data	104
data via Bluetooth	96
files to USB key	96
transportation requirements	131, 159
turning off	
unit	22
Wi-Fi and Bluetooth	112
U	
unit	
buttons	6
first configuration	24
password	66
repairing	13
restoring	152, 153
stand	3
upgrading applications	30
USB	
device	38
key for transfer	96
ports	4
user password	66

Index

V

VFL	
cleaning	133
installing	139
location	4
maintenance	139
removing	139
viewer, TightVNC	127
viewing	
PDF files	77
system information	156, 157, 158
virtual keyboard	29
VNC server	
automatic start	130
configuration	121, 123

W

wallpaper, changing	53, 56
warranty	
certification	164
exclusions	164
general	161
liability	163
null and void	161
Web	
browser	88
options	59
Wi-Fi	
connecting	106
frequency band data	xiii
manual configuration	110
signal strength	106
Windows Mobile Device Center	97

wireless

encryption and protocol	110
icon	106
internal device	112
network	106
sticker	3
wizard, configuration	24

Y

yellow LED	5
------------------	---

CHINESE REGULATION ON RESTRICTION OF HAZARDOUS SUBSTANCES (RoHS)

中国关于有害物质限制的规定

NAMES AND CONTENTS OF THE TOXIC OR HAZARDOUS SUBSTANCES OR ELEMENTS
CONTAINED IN THIS EXFO PRODUCT

包含在本 EXFO 产品中的有毒有害物质或元素的名称及含量

Part Name 部件名称	Lead 铅 (Pb)	Mercury 汞 (Hg)	Cadmium 镉 (Cd)	Hexavalent Chromium 六价铬 (Cr(VI))	Polybrominated biphenyls 多溴联苯 (PBB)	Polybrominated diphenyl ethers 多溴二苯醚 (PBDE)
Enclosure 外壳	O	O	O	O	O	O
Electronic and electrical sub-assembly 电子和电气组件	X	O	X	O	X	X
Optical sub-assembly ^a 光学组件 ^a	X	O	O	O	O	O
Mechanical sub-assembly ^a 机械组件 ^a	O	O	O	O	O	O

Note:

注:

This table is prepared in accordance with the provisions of SJ/T 11364.

本表依据 SJ/T 11364 的规定编制。

O: Indicates that said hazardous substance contained in all of the homogeneous materials for this part is below the limit requirement of GB/T 26572.

O: 表示该有害物质在该部件所有均质材料中的含量均在 GB/T 26572 标准规定的限量要求以下。

X: indicates that said hazardous substance contained in at least one of the homogeneous materials used for this part is above the limit requirement of GB/T 26572. Due to the limitations in current technologies, parts with the "X" mark cannot eliminate hazardous substances.



X: 表示该有害物质至少在该部件的某一均质材料中的含量超出 GB/T 26572 标准规定的限量要求。

标记 "X" 的部件, 皆因全球技术发展水平限制而无法实现有害物质的替代。

a. If applicable.

如果适用。

MARKING REQUIREMENTS
标注要求

Product 产品	Environmental protection use period (years) 环境保护使用期限 (年)	Logo 标志
This EXFO product 本 EXFO 产品	10	
Battery ^a 电池	5	

a. If applicable.
如果适用。

P/N: 1082140

www.EXFO.com · info@EXFO.com

CORPORATE HEADQUARTERS 400 Godin Avenue

Quebec (Quebec) G1M 2K2 CANADA
Tel.: 1 418 683-0211 · Fax: 1 418 683-2170

TOLL-FREE (USA and Canada)

1 800 663-3936

© 2022 EXFO Inc. All rights reserved.
Printed in Canada (2022-02)

