

---

# PPM1

## PON Power Meter



---

Copyright © 2022 EXFO Inc. All rights reserved. No part of this publication may be reproduced, stored in a retrieval system or transmitted in any form, be it electronically, mechanically, or by any other means such as photocopying, recording or otherwise, without the prior written permission of EXFO Inc. (EXFO).

Information provided by EXFO is believed to be accurate and reliable. However, no responsibility is assumed by EXFO for its use nor for any infringements of patents or other rights of third parties that may result from its use. No license is granted by implication or otherwise under any patent rights of EXFO.

EXFO's Commerce And Government Entities (CAGE) code under the North Atlantic Treaty Organization (NATO) is 0L8C3.

The information contained in this publication is subject to change without notice.

### ***Trademarks***

EXFO's trademarks have been identified as such. However, the presence or absence of such identification does not affect the legal status of any trademark.

Where applicable, the Bluetooth<sup>®</sup> word mark and logos are registered trademarks owned by Bluetooth SIG, Inc. and any use of such marks by EXFO Inc. is under license. Other third party trademarks and trade names are those of their respective owners.

### ***Units of Measurement***

Units of measurement in this publication conform to SI standards and practices.

### ***Patents***

The exhaustive list of patents is available at [EXFO.com/patent](http://EXFO.com/patent).

Version number: 2.0.0.1

---

# Contents

Regulatory Information .....	vi
<b>1 Introducing the PPM1 PON Power Meter .....</b>	<b>1</b>
Main Features .....	2
Available Options .....	4
LED Indicator Description .....	5
Battery Status Icon Description .....	6
Power Sources .....	7
Temperature Management .....	8
Technical Specifications .....	8
Conventions .....	9
<b>2 Safety Information .....</b>	<b>11</b>
General Safety Information .....	11
Other Safety Symbols on Your Unit .....	13
Laser Safety Information (Units with VFL) .....	14
Electrical Safety Information .....	15

# Contents

---

<b>3</b>	<b>Setting up and Using Your PPM1</b>	<b>19</b>
	Turning on Your Unit	19
	Cleaning and Connecting Optical Fibers	20
	Turning off Your Unit	22
	Understanding the Main Window	23
	Selecting the Power Meter Mode	24
	Configuring the Auto-Off Value	26
	Adjusting Brightness	28
	Enabling or Disabling Sound Notifications	29
	Selecting the User Interface Language	31
	Adjusting the Date and Time	33
	Changing the Power Units	35
	Enabling the PON-aware Feature	36
	Setting up PON Thresholds	38
	Selecting PON Wavelengths and Layers	41
	Changing Wavelengths (Pro Models)	43
	Defining a List of Favorite Wavelengths (Pro Models)	45
	Automatically Detecting Wavelengths (Pro Models)	50
	Working With Broadband Pass/Fail Thresholds (Pro Models)	52
	Setting Reference Values on Your PPM1	55
	Switching Between Power and Loss Measurements	57
	Nulling Electrical Offsets	60
	Measuring Power or Loss	61
	Working in Min./Max. Mode	63
	Using the VFL	65
	Reverting to Factory Settings	68
<b>4</b>	<b>Managing Test Results</b>	<b>71</b>
	Viewing Measurements	71
	Viewing Results in the Margin Meter	73
	Deleting Measurements (Clearing Data)	74
	Transferring Results to a Computer	77
<b>5</b>	<b>Maintenance</b>	<b>79</b>
	Cleaning Optical Connectors Using a Mechanical Cleaner	80
	Cleaning the Touchscreen	81
	Recharging the Battery	81
	Battery Maintenance Recommendations	84
	Replacing the Battery	86
	Updating the Application	94
	Recalibrating the Unit	96
	Recycling and Disposal	97

<b>6 Troubleshooting .....</b>	<b>99</b>
Solving Common Problems .....	99
Accessing the Online Documentation .....	100
Contacting the Technical Support Group .....	101
Viewing System Information .....	102
Transportation .....	103
<b>7 Warranty .....</b>	<b>105</b>
General Information .....	105
Gray Market and Gray Market Products .....	106
Liability .....	107
Exclusions .....	107
Certification .....	107
Service and Repairs .....	108
EXFO Service Centers Worldwide .....	109
<b>Index .....</b>	<b>111</b>

# Regulatory Information

## **USA Electromagnetic Interference Regulatory Statement**

Electronic test and measurement equipment is exempt from FCC part 15, subpart B compliance in the United States of America. However, EXFO Inc. makes reasonable efforts to ensure compliance to the applicable standards.

The limits set by these standards are designed to provide reasonable protection against harmful interference when the equipment is operated in a commercial environment. This equipment generates, uses, and can radiate radio frequency energy and, if not installed and used in accordance with the user documentation, may cause harmful interference to radio communications. Operation of this equipment in a residential area is likely to cause harmful interference in which case the user will be required to correct the interference at his own expense.

Modifications not expressly approved by the manufacturer could void the user's authority to operate the equipment.

### Canada Electromagnetic Interference Regulatory Statement

This equipment generates, uses, and can radiate radio frequency energy and, if not installed and used in accordance with the instruction manual, may cause harmful interference to radio communications. Operation of this equipment in a residential area is likely to cause harmful interference.

Cet équipement génère, utilise et peut émettre de l'énergie radio-fréquence et, s'il n'est pas installé et utilisé conformément à la documentation de l'utilisateur, il peut occasionner une interférence néfaste aux communications radio. L'utilisation de cet équipement dans une zone résidentielle est susceptible d'occasionner une interférence néfaste.

**Caution:** This equipment is not intended for use in residential environments and may not provide adequate protection to radio reception in such environments.

**Attention :** Cet appareil n'est pas destiné à être utilisé dans des environnements résidentiels et peut ne pas assurer la protection adéquate à la réception radioélectrique dans ce type d'environnements.

## Regulatory Information

---

This is a class A, group 1 product.

Ceci est un produit de classe A, groupe 1.

- **Class A equipment:** Equipment that is, by virtue of its characteristics, highly unlikely to be used in a residential environment, including a home business shall be classified as class A and shall comply with the class A limits specified in the applicable ICES standard. Characteristics considered in this assessment include price, marketing and advertising methodology, the degree to which the functional design inhibits applications suitable to residential environments, or any combination of features that would effectively preclude the use of such equipment in a residential environment.

Classe A : Matériel qui, en raison de ses caractéristiques, ne sera fort probablement pas utilisé dans un milieu domiciliaire ni par des entreprises établies à domicile. Parmi les caractéristiques considérées dans cette évaluation, il y a le prix, les méthodes de commercialisation et de publicité, la mesure dans laquelle les fonctions de l'appareil font qu'il ne se prête pas à des applications convenant au milieu domiciliaire ou toute combinaison de ces caractéristiques qui aurait pour conséquence d'en prévenir effectivement l'utilisation à domicile. Utilisé également pour indiquer les limites d'émission correspondantes qui s'appliquent à un tel matériel.

- **Class B equipment:** Equipment that cannot be classified as Class A shall comply with the Class B limits specified in the applicable ICES standard.

Classe B : Matériel qui ne peut pas être inclus dans la classe A. Utilisé également pour indiquer les limites d'émission correspondantes qui s'appliquent à un tel matériel.



- Group 1 equipment: group 1 contains all equipment which is not classified as group 2 equipment, and includes equipment such as laboratory and scientific equipment, industrial process, measurement and control equipment.

Group 2 equipment: group 2 contains all ISM RF equipment in which radio-frequency energy in the frequency range 9 kHz to 400 GHz is intentionally generated and used or only used locally, in the form of electromagnetic radiation, inductive and/or capacitive coupling, for the treatment of material for inspection/analysis purposes, or for transfer of electromagnetic energy.

Appareils du groupe 1 : le groupe 1 réunit tous les appareils compris dans le domaine d'application de la présente Norme, qui ne sont pas classés comme étant des appareils du groupe 2. Le groupe 1 inclut les appareils scientifiques et de laboratoire, les processus industriels, appareils de mesure ou de contrôle.

Appareils du groupe 2 : le groupe 2 réunit tous les appareils ISM à fréquences radioélectriques dans lesquels de l'énergie à fréquences radioélectriques dans la plage de fréquences comprises entre 9 kHz et 400 GHz est produite et utilisée volontairement ou uniquement utilisée localement sous forme de rayonnement électromagnétique, de couplage inductif et/ou capacitif, pour le traitement de la matière, à des fins d'examen ou d'analyse ou pour le transfert d'énergie électromagnétique.

### **Supplier's Declaration of Conformity (SDoC)**

The SDoC for your product is as follows:

CAN ICES-001 (A) / NMB-001 (A)

### **EU and UK Electromagnetic Compatibility Regulatory Statement**

Warning: This is a class A product. In a domestic environment, this product may cause radio interference in which case the user may be required to take adequate measures. Your product is suitable for use in industrial electromagnetic environments.

### **General Wireless Compliance Related Information**

Your unit comes with an internal wireless module (adapter) and antenna for which the information hereafter applies:

This product does not contain any wireless user-serviceable components. Any unauthorized product changes or modifications will invalidate warranty and all applicable regulatory certifications and approvals.

### **Canada and USA Wireless Compliance Related Information**

Your unit comes with an internal wireless module (adapter) and antenna for which the information hereafter applies:

- This device complies with Part 15 of the FCC Rules.
- This device complies with Innovation, Sciences and Economic Development Canada license-exempt RSS standards.
- Operation is subject to the following two conditions:
  - (1) This device may not cause harmful interference
  - and
  - (2) this device must accept any interference received, including interference that may cause undesired operation.

### ***Use in Specific Environments:***

- The use of wireless products in hazardous locations is limited by the constraints posed by the safety directors of such environments.
- The use of wireless products on airplanes is governed by the Federal Aviation Administration (FAA).
- The use of wireless products in hospitals is restricted to the limits set forth by each hospital.
- High-power radars are allocated as the primary users of the 5.25 to 5.35 GHz, and 5.65 to 5.85 GHz bands. These radar stations can cause interference with and/or damage to this device.

### ***Radiation Exposure Statement:***

- The product complies with the US/Canada portable RF exposure limit set forth for an uncontrolled environment and is safe for intended operation as described in this user documentation.
- Further RF exposure reduction can be achieved if the device can be kept as far as possible from the user's body.

### ***RF Function and Frequency Range:***

Your unit is designed to operate in the Bluetooth 2.4 GHz bands, channels 0 through 80, 2400 MHz – 2480 MHz.

### **EU and UK Wireless Compliance Related Information**

Your unit is designed to operate in the Bluetooth 2.4 GHz band.

The information about the Bluetooth band is Channels 0 through 80 -2400 MHz - 2480 MHz.

The output power is 4 dBm typical.

This device is a 2.4 GHz wideband transmission system (transceiver), intended for use in all EU member states, United Kingdom, and EFTA countries, except in France and Italy where restrictive use applies.

In Italy, the end-user should apply for a license at the national spectrum authorities in order to obtain authorization to use the device for setting up outdoor radio links and/or for supplying access to telecommunications and/or network services.

This device may not be used for setting up radio links in France, and in some areas the RF output power may be limited to 10 mW EIRP in the frequency range of 2454 - 2483.5 MHz. For detailed information, the end-user should contact the national spectrum authority in France.

### **Simplified EU and UK Declaration of Conformity**

Hereby, EXFO declares that the radio equipment type “PPM1” is in compliance with European Directive 2014/53/EU and the UK legislation S.I. 2017/1206 Radio Equipment Regulations 2017.

The full text of the declaration of conformity is available at the following Internet address: *[www.exfo.com/en/resources/legal-documentation](http://www.exfo.com/en/resources/legal-documentation)*.

## EU Economic Operator

**EXFO Solutions SAS**  
2, rue Jacqueline Auriol,  
Saint-Jacques-de-la-Lande,  
35091 Rennes Cedex 9  
FRANCE

## Japanese Technical Conformity Mark for Radio Law

This equipment contains specified radio equipment that has been certified to the Technical Regulation Conformity Certification for Japan, under the Radio Law.

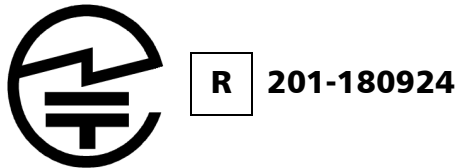

## Japan Wireless Compliance Related Information

Your unit is designed to operate in the Bluetooth 2.4 GHz bands.

The information about the Bluetooth bands is Channels 0 through 80, 2400 MHz – 2480 MHz.

The output power is 4 dBm typical.



# 1 **Introducing the PPM1 PON Power Meter**

The PPM1 PON Power Meter is an ultra-simple and ultra-fast tool that allows you to measure optical signal power or link loss values and store them at the touch of a button.

Pocket-sized and rugged, the PPM1 is designed for extensive use in the field. It has a high capacity data storage for test results. The PON-aware™ lets you select the active PON layers on the network under test and if the unit detects a signal which does not correspond to the layer you have selected.

The Pro unit comes with built-in expertise with automation that avoids human error (smart features such as auto-wavelength recognition and switching). The Pro configuration includes a broadband power meter, which can detect different tones from a source (270 Hz, 330 Hz, 1 kHz and 2 kHz), plus a visual fault locator that emits light in three different modes (continuous, slow blink and fast blink) to trace fibers and identify breaks and macrobends.

## Main Features

Your PPM1 includes the following features:

- Color display
- Capacitive touchscreen
- Power and storage buttons for quick action
- Rechargeable battery
- Operates with USB power, even when charging battery and you can switch between the two modes without affecting operation
- Bluetooth® ready
- Easy software updates using an USB connection
- Dual PON-technology measurement
- PON-aware™ active PON layer detection feature
- Visual graph bar representation with pass/fail limits thresholds
- Easy retrieval of the measurements through USB connection; no need for additional software or drivers
- Batch post processing and reporting available on your computer with FastReporter
- Optional VFL (Pro model)
- Broadband measurements for the available measurement ranges (Pro model)
- Min/Max monitoring mode (Pro model)



# Introducing the PPM1 PON Power Meter

*Main Features*

---

## Front panel

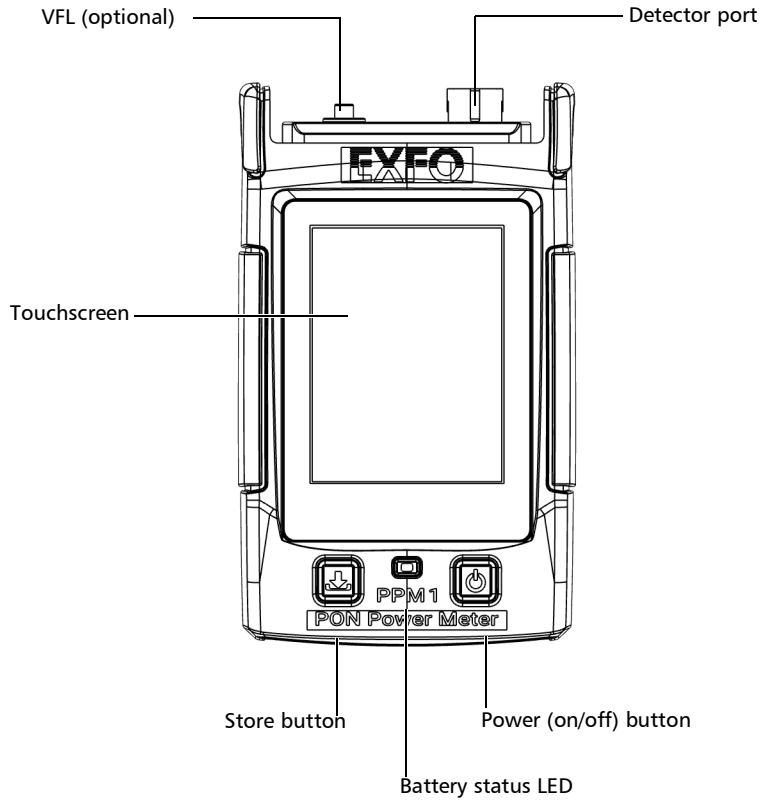

# Introducing the PPM1 PON Power Meter

## Available Options

---

### Top panel

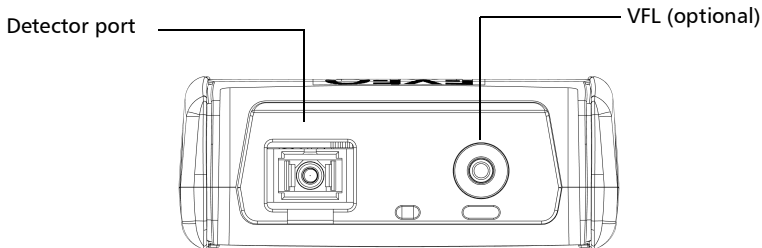

### Bottom panel

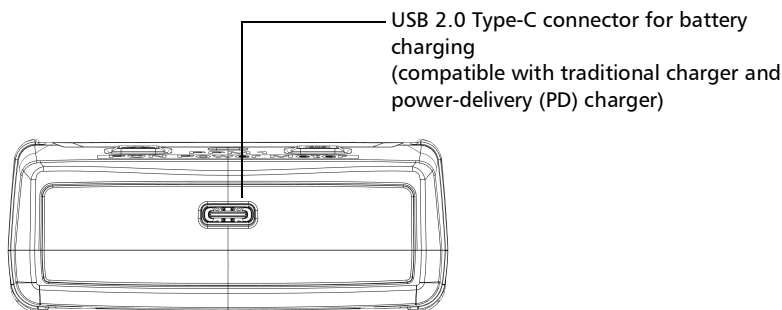

## Available Options

Several options are available for the PON Power Meter:

Option	Description
PPM1-D	Entry model, (1490, 1550 and 1577 nm) with standard range of 15 to -45 dBm.
PPM1-PRO-D	High end model (1490, 1550, 1577, 1310 and 1625 nm) with VFL and broadband options and standard range of 15 to -45 dBm.

## LED Indicator Description

The LED indicator, located between the two buttons, provides you with information about the battery status.



<b>Unit</b>	<b>Status</b>	<b>Meaning</b>
Connected to an external power source	On	The battery is charging and the power level is equal to 95 % or more.
	Blinking – slow	The battery is charging and the power level is below 95 %.
	Blinking – fast	An error occurred. This could mean a charger error or that the temperature is too high.
Not connected to an external power source	Off	The unit is not charging and there are no errors.
	Red – unblinking	The battery power is too low to operate the unit.

# Introducing the PPM1 PON Power Meter

## Battery Status Icon Description

---

The battery status icon is shown in the upper right corner of the title bar. It complements the information provided by the unit's LED.

Icon	Meaning
	The portion of the icon that appears in white in the title bar (in black here) reflects the current battery level.
	A red icon indicates that the battery level is running low and that you should connect the unit to a power outlet.
	A flash symbol indicates that the unit is charging.

### Power Sources

The PON Power Meter operates with the following power sources:

- Indoor use only: USB power adapter connected to a power outlet (fastest way to charge the battery).

**Note:** *The standard USB ports of a computer can power your unit or charge its battery, but it will be slower than if you are using the adapter.*

**Note:** *If you have a vehicle equipped with dedicated USB charging ports, you could connect your unit to one of these ports to charge the battery. The actual results will vary with each vehicle. You could also use a certified USB power bank (portable charger) to charge your unit.*

- Indoor and outdoor use: One lithium-polymer (Li-Po) rechargeable battery (main battery that automatically takes over if you disconnect the unit from its external power source). You can switch from an external power source to battery power or vice versa without affecting operation. The real-time clock is also powered by the battery; should the unit be fully discharged however, the real-time clock will retain the date and time values for a few days (typically a little over a week) until you recharge it again.

**Note:** *You can replace the main battery yourself (see Replacing the Battery on page 86), but this will reset the real-time clock.*

**Note:** *When the ambient temperature is below 0 °C (32 °F) or when it reaches or exceeds about 45 °C (113°F), the main battery can either charge slower than usual, or not charge at all, depending on the internal temperature of your unit.*

For more information, see *Electrical Safety Information* on page 15.

### Temperature Management

The internal temperature of your unit will vary with the ambient temperature. Your unit has been designed to adapt its behavior as necessary to regulate its temperature. For this reason, in high-temperature conditions, you could receive warning messages. If the temperature keeps rising and reaches the limit: your unit will turn off as self-protection.

For more information on the effects of temperature on battery charging, see *Power Sources* on page 7.



#### IMPORTANT

For optimum performance of your unit:

- Ensure that it remains within the recommended operation and storage temperatures (see *Equipment Ratings* on page 16).
- Avoid leaving your unit in an overheated vehicle. You may have to let your unit cool down before being able to use it.
- Ensure that your unit is normally protected from direct sunlight (during use and storage).

### Technical Specifications

To obtain this product's technical specifications, visit the EXFO Web site at [www.exfo.com](http://www.exfo.com).

## Conventions

Before using the product described in this guide, you should understand the following conventions:



### WARNING

Indicates a potentially hazardous situation which, if not avoided, could result in *death or serious injury*. Do not proceed unless you understand and meet the required conditions.



### CAUTION

Indicates a potentially hazardous situation which, if not avoided, may result in *minor or moderate injury*. Do not proceed unless you understand and meet the required conditions.



### CAUTION

Indicates a potentially hazardous situation which, if not avoided, may result in *component damage*. Do not proceed unless you understand and meet the required conditions.



### IMPORTANT

Refers to information about this product you should not overlook.





## 2 **Safety Information**

### **General Safety Information**



#### **WARNING**

Do not install or terminate fibers while a light source is active. Never look directly into a live fiber and ensure that your eyes are protected at all times.



#### **WARNING**

The use of controls, adjustments and procedures, namely for operation and maintenance, other than those specified herein may result in hazardous radiation exposure or impair the protection provided by this unit.



#### **WARNING**

If the equipment is used in a manner not specified by the manufacturer, the protection provided by the equipment may be impaired.



#### **WARNING**

Use only accessories designed for your unit and approved by EXFO. For a complete list of accessories available for your unit, refer to its technical specifications or contact EXFO.

## Safety Information

### General Safety Information

---



### IMPORTANT

Refer to the documentation provided by the manufacturers of any accessories used with your EXFO product. It may contain environmental and/or operating conditions limiting their use.



### IMPORTANT

When you see the following symbol on your unit , make sure that you refer to the instructions provided in your user documentation. Ensure that you understand and meet the required conditions before using your product.



### IMPORTANT

When you see the following symbol on your unit , it indicates that the unit is equipped with a laser source, or that it can be used with instruments equipped with a laser source. These instruments include, but are not limited to, modules and external optical units.













### IMPORTANT

Other safety instructions relevant for your product are located throughout this documentation, depending on the action to perform. Make sure to read them carefully when they apply to your situation.

## Other Safety Symbols on Your Unit

One or more of the following symbols may also appear on your unit.

Symbol	Meaning
	Direct current
	Alternating current
	The unit is equipped with an earth (ground) terminal.
	The unit is equipped with a protective conductor terminal.
	The unit is equipped with a frame or chassis terminal.
	On (Power)
	Off (Power)
 OR 	On/off (Power)
	Fuse

## Safety Information

Laser Safety Information (Units with VFL)

### Laser Safety Information (Units with VFL)

Your instrument is in compliance with standard IEC 60825-1: 2014.

Laser radiation may be encountered at the optical output port.

The following label(s) indicate that the product contains a Class 2 source:

The following symbol means  
"DO NOT STARE INTO THE BEAM".

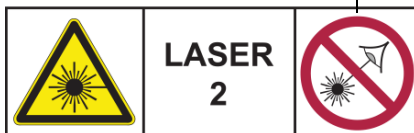

Located at the  
back of the unit

## Electrical Safety Information



### **WARNING**

If you need to ensure that the unit is completely turned off, disconnect the power cable and remove the battery. For more information on how to remove the battery, see the section about replacing the battery in this user documentation.



### **WARNING**

- Use the external power supply (USB power adapter) indoors only.
- Never connect the unit to the AC mains (with the USB power adapter) when it is used outdoors.
- To avoid electrical shock, do not operate the unit if any part of the outer surface (covers, panels, etc.) is damaged.
- Only authorized personnel should carry out adjustments, maintenance or repair of opened units under voltage. A person qualified in first aid must also be present. Do not replace any components while the USB cable and battery are connected.
- Unless otherwise specified, all interfaces are intended for connection to ES1 circuits only.
- Use only the listed and certified USB power adapter provided by EXFO with your unit. It provides reinforced insulation between primary and secondary, and is suitably rated for the country where the unit is sold.
- Capacitors inside the unit may be charged even if the unit has been disconnected from its electrical supply.

## Safety Information

### Electrical Safety Information



### CAUTION

- Position the unit so that the air can circulate freely around it.
- When you use the unit outdoors, ensure that it is protected from liquids, dust, direct sunlight, precipitation, and full wind pressure.



### CAUTION

The use of voltages higher than those indicated on the label affixed to your unit may damage the unit.

#### Equipment Ratings

Temperature	
➤ Operation	<ul style="list-style-type: none"><li>➤ unit powered by battery: <math>-10\text{ }^{\circ}\text{C}</math> to <math>50\text{ }^{\circ}\text{C}</math> (<math>14\text{ }^{\circ}\text{F}</math> to <math>122\text{ }^{\circ}\text{F}</math>)<sup>a</sup></li><li>➤ unit connected to AC power (with USB power adapter): <math>0\text{ }^{\circ}\text{C}</math> to <math>40\text{ }^{\circ}\text{C}</math> (<math>32\text{ }^{\circ}\text{F}</math> to <math>104\text{ }^{\circ}\text{F}</math>)<sup>b</sup></li></ul>
➤ Storage	<ul style="list-style-type: none"><li>➤ unit – short-term storage<sup>c</sup>: <math>-40\text{ }^{\circ}\text{C}</math> to <math>70\text{ }^{\circ}\text{C}</math> (<math>-40\text{ }^{\circ}\text{F}</math> to <math>158\text{ }^{\circ}\text{F}</math>)</li><li>➤ unit – long-term storage<sup>d</sup>: <math>10\text{ }^{\circ}\text{C}</math> to <math>45\text{ }^{\circ}\text{C}</math> (<math>50\text{ }^{\circ}\text{F}</math> to <math>113\text{ }^{\circ}\text{F}</math>)</li><li>➤ unit – recommended storage: <math>15\text{ }^{\circ}\text{C}</math> to <math>35\text{ }^{\circ}\text{C}</math> (<math>59\text{ }^{\circ}\text{F}</math> to <math>95\text{ }^{\circ}\text{F}</math>)</li></ul>
Relative humidity <sup>e</sup>	<ul style="list-style-type: none"><li>➤ unit: <math>\leq 95\%</math> non-condensing</li><li>➤ USB power adapter: <math>10\%</math> to <math>90\%</math> non-condensing</li></ul>
Maximum operation altitude	<ul style="list-style-type: none"><li>➤ <math>2000\text{ m}</math> (<math>6562\text{ ft}</math>) (unit connected to external power source)</li><li>➤ <math>5000\text{ m}</math> (<math>16405\text{ ft}</math>) (unit operated from battery)</li></ul>

Equipment Ratings	
Pollution degree	<ul style="list-style-type: none"> <li>➤ 2 (unit connected to external power source)</li> <li>➤ 3 (unit operated from battery)<sup>f</sup></li> </ul>
IP rating	IP54 design for dust and water protection
Overvoltage category	<ul style="list-style-type: none"> <li>➤ unit: I</li> <li>➤ USB power adapter: II</li> </ul>
Measurement category	Not rated for measurement categories II, III, or IV
Input power <sup>g</sup>	<ul style="list-style-type: none"> <li>➤ unit: 5 V ---; 2 A</li> <li>➤ USB power adapter: 100 - 240 V ~; 50/60 Hz; 1 A max</li> </ul>

- a. When the unit is used at an altitude of 5000 m, the maximum operating temperature is 45 °C (113 °F).
- b. When the ambient temperature is below 5 °C (41 °F) or when it reaches or exceeds about 45 °C (113°F), the main battery can either charge more slowly than usual, or not charge at all, depending on the internal temperature of your unit.
- c. Short-term storage corresponds to the storage of the unit for a maximum of 48 hours.
- d. Long-term storage corresponds to the storage of the unit for more than three months.
- e. Measured in 0 °C to 31 °C (32 °F to 87.8 °F) range, decreasing linearly to 50 % at 40 °C (104 °F).
- f. Equipment must be normally protected against exposure to direct sunlight, precipitation and full wind pressure.
- g. Not exceeding  $\pm 10\%$  of the nominal voltage.





# 3 **Setting up and Using Your PPM1**

## **Turning on Your Unit**

When you turn on the unit for the very first time, a wizard is displayed, enabling you to read and accept the EXFO license agreement, then set the language, date, time, and then view where you can consult the user documentation.

**To turn on the unit:**

Press the on/off button until the unit beeps once.

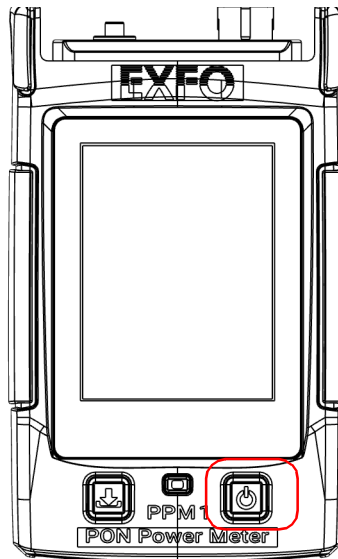

# Cleaning and Connecting Optical Fibers



## IMPORTANT

To ensure maximum power and to avoid erroneous readings:

- Always inspect fiber ends and make sure that they are clean as explained below before inserting them into the port. EXFO is not responsible for damage or errors caused by bad fiber cleaning or handling.
- Ensure that your patchcord has appropriate connectors. Joining mismatched connectors will damage the ferrules.

### ***To connect the fiber-optic cable to the port:***

- 1.** Inspect the fiber using a fiber inspection scope (or probe). If the fiber is clean, proceed to connecting it to the port. If the fiber is dirty, clean it as explained below.
- 2.** Clean the fiber ends as follows:
  - 2a.** Gently wipe the fiber end with a lint-free swab dipped in optical-grade liquid cleaner.
  - 2b.** Use a dry swab to dry the connector completely.
  - 2c.** Visually inspect the fiber end to ensure its cleanliness.

3. Carefully align the connector and port to prevent the fiber end from touching the outside of the port or rubbing against other surfaces.

If your connector features a key, ensure that it is fully fitted into the port's corresponding notch.

4. Push the connector in so that the fiber-optic cable is firmly in place, thus ensuring adequate contact.

If your connector features a screw sleeve, tighten the connector enough to firmly maintain the fiber in place. Do not overtighten, as this will damage the fiber and the port.

**Note:** *If your fiber-optic cable is not properly aligned and/or connected, you will notice heavy loss and reflection.*

EXFO uses good quality connectors in compliance with EIA-455-21A standards.

To keep connectors clean and in good condition, EXFO strongly recommends inspecting them with a before connecting them. Failure to do so may result in permanent damage to the connectors and degradation in measurements.

## Setting up and Using Your PPM1

### *Turning off Your Unit*

---

## Turning off Your Unit

Unless specified otherwise in this documentation, the settings you configure on your unit are kept in memory even when you turn the unit off.

### **To turn off the unit:**

Press the on/off button. The unit will beep once.

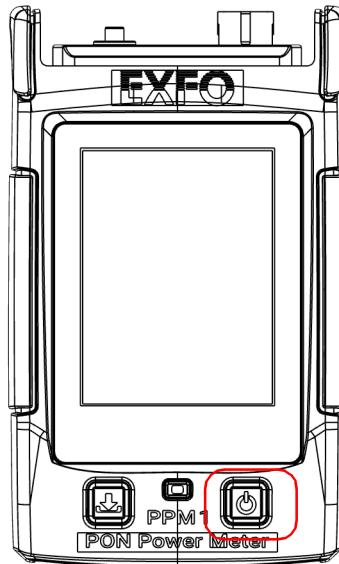

## Understanding the Main Window

The main window of the PON Power Meter can be seen as the starting point of the application. You can perform measurements and navigate through the results.

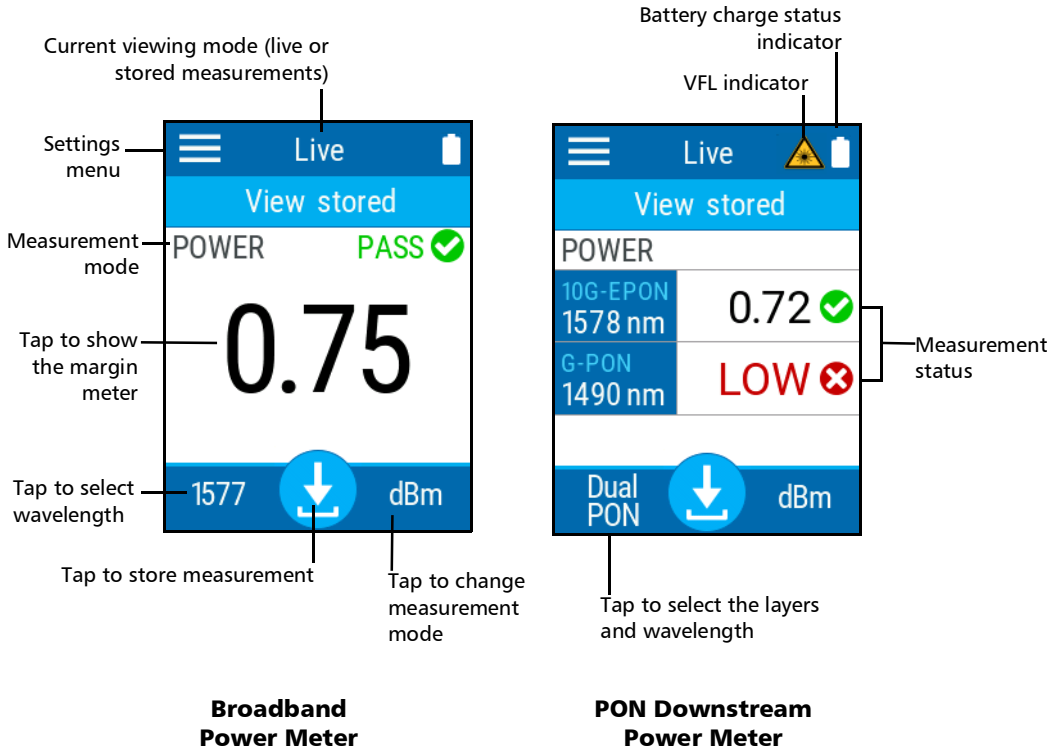

## Setting up and Using Your PPM1

### Selecting the Power Meter Mode

---

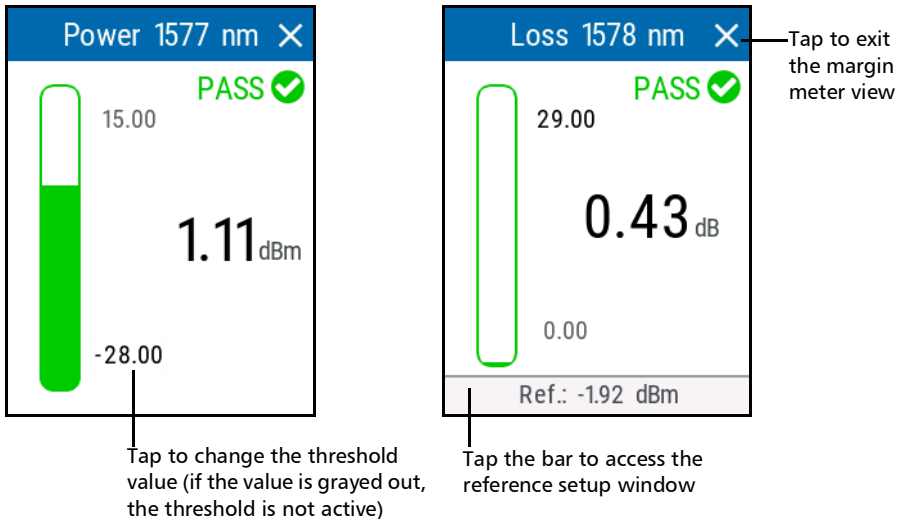

## Selecting the Power Meter Mode

Your PPM1 can be used in two modes:

- **PON Downstream:** The PPM1 is designed to test a variety of PON network technologies such as G-PON, E-PON, B-PON, XGS-PON, 10G-EPON, RFvideo and RFoG. These different technologies, or layers, can co-exist on the same network. You can preset the PPM1 to measure using the correct wavelength and pass/fail thresholds proper to each layer. Typically, networks feature one or two layers.
- **Broadband (Pro models only):** This mode allows to use the PPM1 as a broadband power meter to measure loss or power at various wavelengths selected manually or automatically.

**Note:** *The PPM1 is a PON power meter based on optical filters. In order to perform a broadband measurement, the selected wavelength must correspond to the wavelength present on the fiber under test.*

**To select the power meter mode:**

From the main page, tap the  icon to access the menu, then select the desired mode.

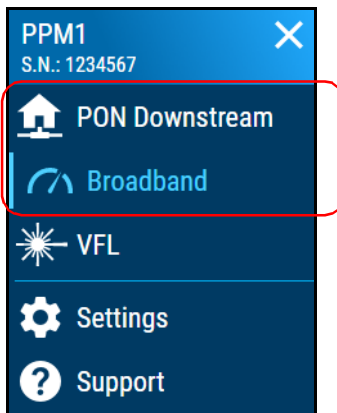

## Configuring the Auto-Off Value

To help you get the optimum performance out of your unit, it comes with a predefined set of parameters to manage power. When you do not use your unit for a while, it will shut down automatically to save power.

By default, the duration after which the unit turns automatically off is two minutes, but you can select another value. The value that you set is kept in memory even when you turn the unit off.

### **To configure the auto-off value:**

1. From the main page, tap the  icon to access the menu, then select .
2. Under **Unit settings**, tap **Auto off**.

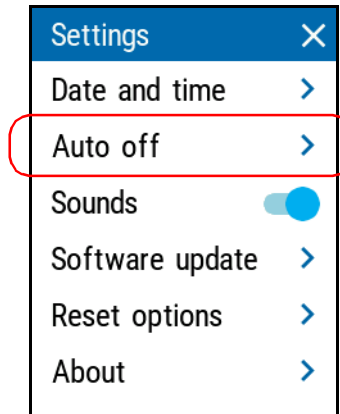



3. Select the desired number of minutes.

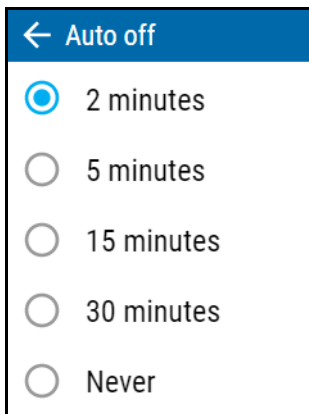

The screenshot shows a settings menu titled "Auto off" with a back arrow on the left. Below the title are five radio button options: "2 minutes" (selected), "5 minutes", "15 minutes", "30 minutes", and "Never".

The new value is taken into account immediately.



## Adjusting Brightness

You may want to adjust the display brightness yourself to better fit your work environment or preferences.

You may also want to reduce the display brightness to save battery power (the higher the brightness level, the higher the power consumption).

The brightness value is kept in memory even when you turn the unit off.

### **To adjust the display brightness:**

1. From the main page, tap the  icon to access the menu, then select .
2. Under **Brightness**, tap the dots until the screen appearance is to your liking. You can also tap the desired brightness icon to quickly set the brightness to the minimum or the maximum value.

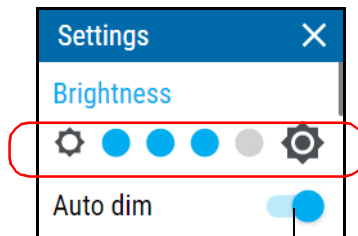

The screen will dim automatically after a while if there is no activity on the unit.

The new brightness value is taken into account immediately.

## Enabling or Disabling Sound Notifications

By default, your unit emits a sound when certain events occur. You can choose to disable some of them if you prefer. This preference will be kept in memory even when you turn the unit off.

The table below shows which notifications can be disabled.



<b>Notifications that can be disabled</b>	<b>Notifications that cannot be disabled</b>
<ul style="list-style-type: none"><li>➤ Modulation detection</li><li>➤ Measurement is being stored</li><li>➤ Auto-wavelength/switching detection</li></ul>	<ul style="list-style-type: none"><li>➤ Unit is turned On/Off</li><li>➤ External power supply connected or disconnected.</li><li>➤ High power detected (over 19 dBm)</li></ul>

## Setting up and Using Your PPM1

### Enabling or Disabling Sound Notifications

---

#### **To enable or disable the sound notifications on your unit:**

1. From the main page, tap the  icon to access the menu, then select .
2. With the **Sounds** toggle, enable or disable the sound notifications.

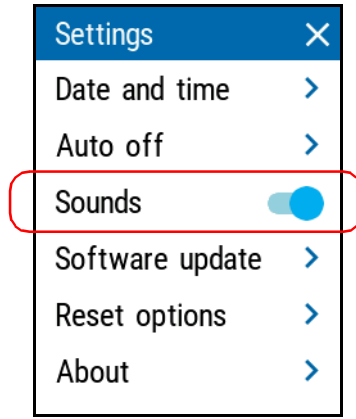

The new value is taken into account immediately.

### Selecting the User Interface Language

The user interface is available in several languages.

**To change the language:**

1. From the main PPM1 page, tap the  icon to access the menu, then select .
2. Tap **Language**.

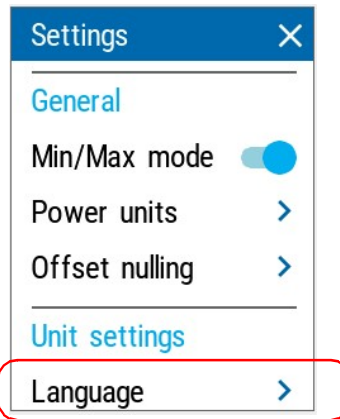

## Setting up and Using Your PPM1

### *Selecting the User Interface Language*

---

3. Select the language you want to use in the list of available choices.

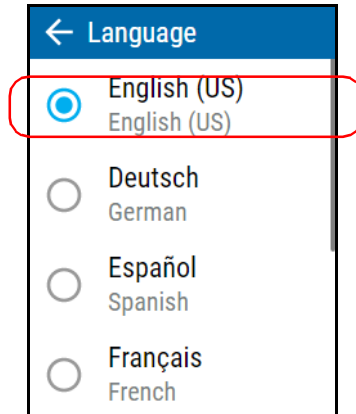

4. Confirm your choice.

**Note:** *The language will be changed automatically.*



# Adjusting the Date and Time

The time is displayed in the title bar. When saving results, the unit also saves the corresponding date and time.

**Note:** *Time is expressed in a 24-hour format.*

**Note:** *The date is displayed in the international standard date notation (yyyy mm dd).*

### **To adjust the date and time:**

1. From the main page, tap the  icon to access the menu, then select .
2. Under **Unit settings**, tap **Date and time**.

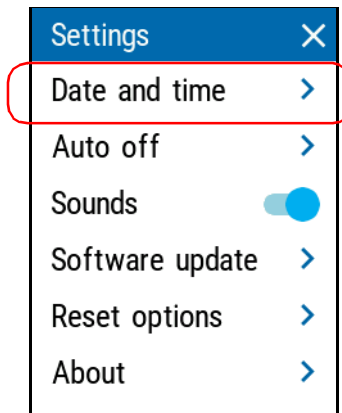

## Setting up and Using Your PPM1

### *Adjusting the Date and Time*

---

3. Tap the element corresponding to the value that you want to modify.

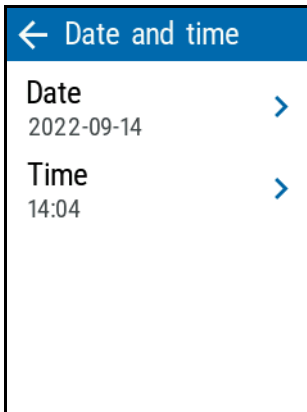

4. Using the arrow buttons, modify the settings according to your needs, and then tap **OK** to confirm.

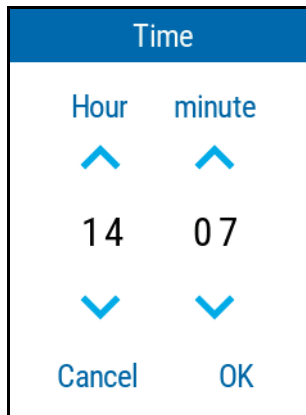
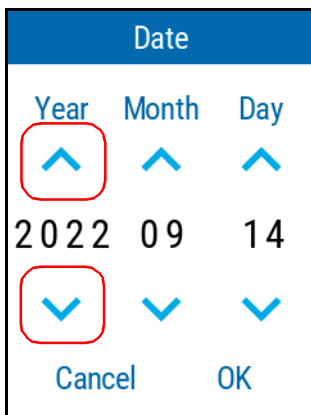



The new values are taken into account immediately.



## Changing the Power Units

You can work with your PPM1 using either dBms or watts.

### To change the power units:

1. From the main page, tap the  icon to access the menu, then select .
2. Under **Power Meter**, tap **Power units**.



3. Select the desired units, dBm or watts.

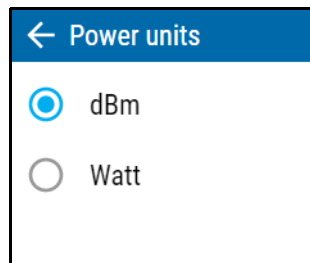

The changes are effective immediately.

## Setting up and Using Your PPM1

*Enabling the PON-aware Feature*



---

### Enabling the PON-aware Feature

The PON-aware feature allows to automatically detect the active PON layers on the network under test. If the unit detects a signal which does not seem to correspond to the layer you have selected, the PON-aware feature will prompt you accordingly and offer a selection of possible configurations to use instead to properly assess the layers present on the network.

**Note:** *If the feature is not active, you will need to manually select the layers and wavelengths.*

#### **To enable PON-aware:**

1. From the main page, tap the  icon to access the menu, then select .
2. Under **PON power meter**, tap **PON-aware**.

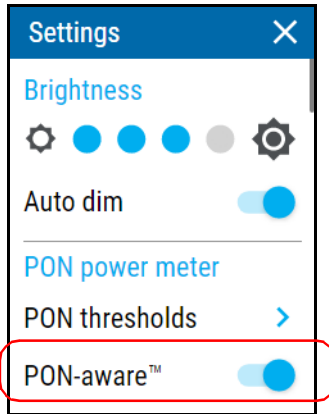

Each time the unit detects a signal that does not seem to correspond to the selected layer, the message below appears.

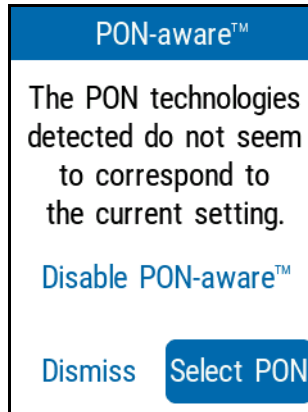

- Tap **Disable PON-aware** to deactivate the option. It will remain inactive until you enable it again.
- Tap **Dismiss** to ignore the message; it will be active again the next time you reboot your unit.
- Tap **Select PON** to select a new technology from a list of compatible choices.

## Setting up PON Thresholds

The PPM1 comes pre-set with PON thresholds. Since the PPM1 is intended for service activations tasks, thresholds are preset according to a test location at the ONT location of the premise.

### To set up the PON thresholds:

1. From the main page, tap the  icon to access the menu, then select .
2. Under **PON power meter**, tap **PON thresholds**.

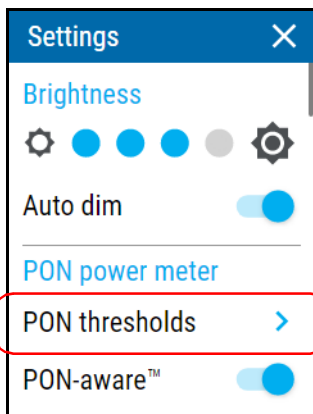

3. Activate PON downstream thresholds by selecting the corresponding option.

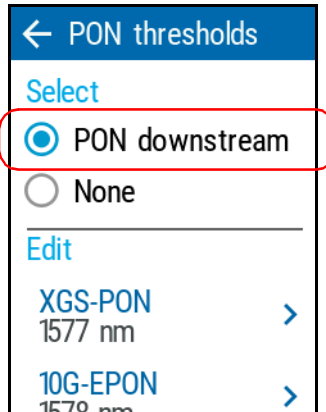

4. Select the relevant PON technology thresholds and tap the arrow to change the thresholds. Each technology has its own threshold values.
5. Enable the minimum and maximum power and loss thresholds as needed.

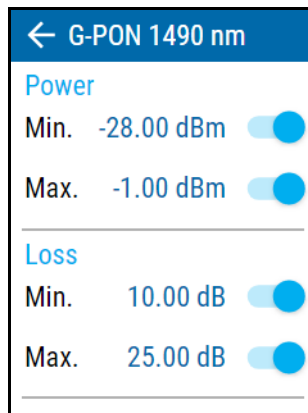

## Setting up and Using Your PPM1

### *Setting up PON Thresholds*

---

6. To modify the threshold value, tap on it, then use the arrow buttons as needed. Tap **OK** to confirm the change.

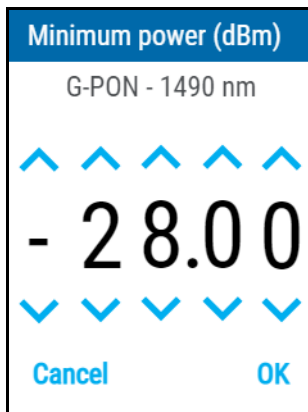

## Selecting PON Wavelengths and Layers

You can use the PON-aware feature to select the layers and configurations automatically, or select the layers and wavelengths manually.

**To select the PON wavelengths or layers:**

1. Make sure you are in PON downstream mode as explained in *Selecting the Power Meter Mode* on page 24.
2. From the main page, tap the wavelength at the bottom left part of the screen to open the selection menu.

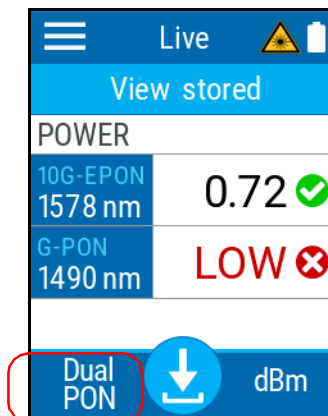

## Setting up and Using Your PPM1

### Selecting PON Wavelengths and Layers

---

3. If you want to use PON-aware, use the arrows at the top of the window to select the option, then select the layer you want to use.

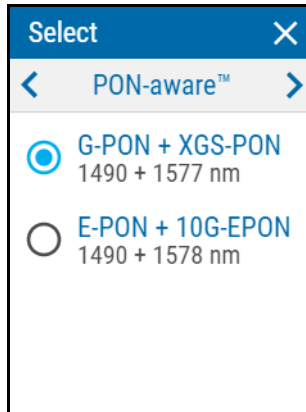

OR

If you want to select the layers and wavelengths manually, use the arrow buttons at the top of the window to select PON Downstream. Then, enable the layers and wavelengths you want to use.

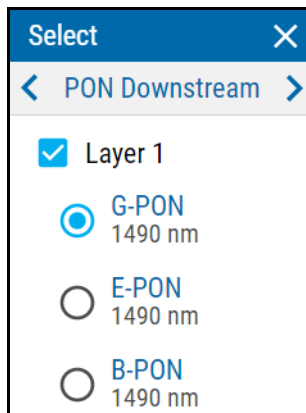

4. Tap  to exit the page and return to the main window.



## Changing Wavelengths (Pro Models)

A list of wavelengths is available for you to perform your tests.

**To select the wavelength you want to use:**

1. Make sure you have selected the broadband mode as explained in *Selecting the Power Meter Mode* on page 24.
2. From the main page, tap the wavelength at the bottom left part of the screen to open the selection menu.

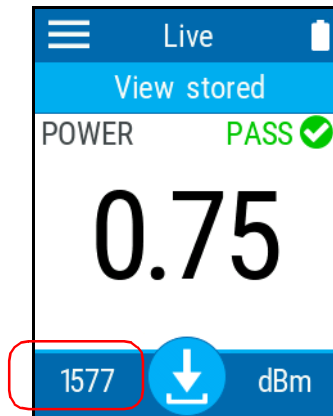

## Setting up and Using Your PPM1

### *Changing Wavelengths (Pro Models)*

---

3. Select the desired value in the list. Scroll up or down by dragging your finger on the screen to see more available values.

If you select **Auto** the wavelength will automatically change to match the one used by a compatible light source when connected.

**Note:** *If you have a Pro model, you will also have access to the default broadband, favorite and CWDM wavelength lists. Use the arrow buttons at the top of the window to access the corresponding list.*

**Note:** *This is independent from the Auto-detect mode (see Automatically Detecting Wavelengths (Pro Models) on page 50) and overrides that setting even if it is set to off.*

After selecting the value, you automatically return to the main page.

## Defining a List of Favorite Wavelengths (Pro Models)

You must put the wavelengths you want to use on a list of favorite wavelengths. Only wavelengths on this list are available for measurements. You may enter up to 24 favorite wavelengths. At the factory (or after recalibration), the default list is empty.

You can obtain the highest accuracy using the calibrated wavelengths. For other wavelengths, the unit will determine values based on the calibrated wavelengths (3-point interpolation).

<b>Default Wavelengths Pro Unit (nm)</b>
1270, 1280, 1290, 1300, 1310, 1320, 1330, 1340, 1350, 1370, 1390, 1410, 1430, 1450, 1460, 1490, 1520, 1530, 1540, 1550, 1560, 1570, 1577, 1580, 1590, 1600, 1610, 1620, 1625.

The valid wavelength ranges are as follow:



- 1260 nm – 1469 nm
- 1481 nm – 1499 nm
- 1511 nm – 1625 nm

## Setting up and Using Your PPM1

### Defining a List of Favorite Wavelengths (Pro Models)

---

#### To add wavelengths to the list:

1. From the main page, tap the  icon to access the menu, then select .
2. Under **Broadband power meter**, tap **Favorite**.

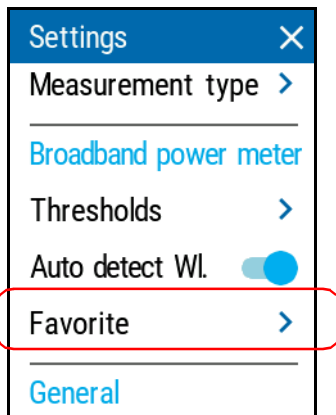

3. Tap **Add**.

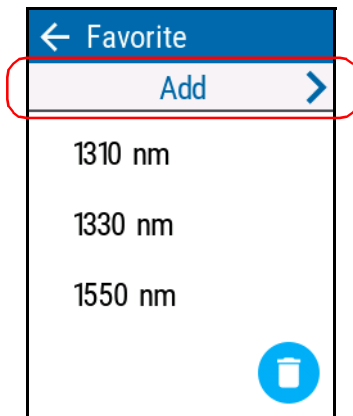

## Setting up and Using Your PPM1

### *Defining a List of Favorite Wavelengths (Pro Models)*

---

4. Enter a new value using the arrow buttons.

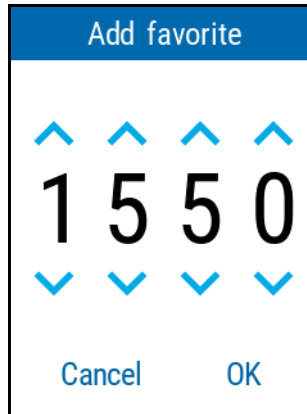



5. Tap **OK** to confirm the new wavelength and return to the list of favorites.
6. Repeat steps 3 to 5 for each new wavelength you want to add.

## Setting up and Using Your PPM1

### Defining a List of Favorite Wavelengths (Pro Models)

---

#### To delete wavelengths from the list:

1. From the main page, tap the  icon to access the menu, then select .
2. Under **Broadband power meter**, tap **Favorite**.

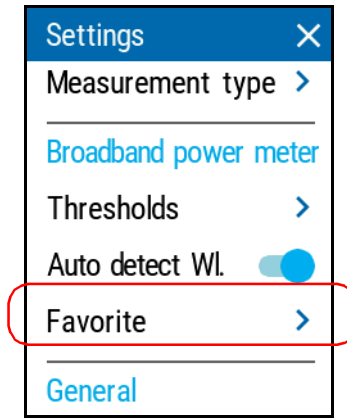

3. Tap the corresponding button.

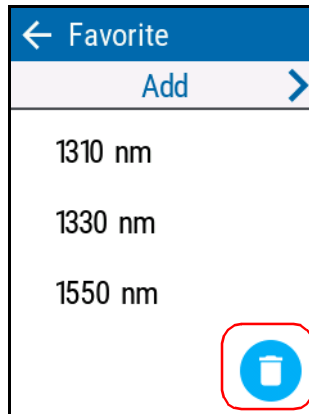

**Note:** To delete a single wavelength, you can press and hold the corresponding wavelength in the list for two seconds, then confirm your choice.

## Setting up and Using Your PPM1

### *Defining a List of Favorite Wavelengths (Pro Models)*

---

4. Select which wavelength or wavelengths you want to remove, then tap **Remove**.

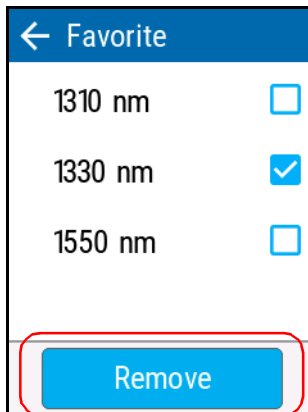

# Automatically Detecting Wavelengths (Pro Models)

Compatible sources can transmit their wavelength value through the fiber, avoiding the need to manually match the source and power meter wavelengths.

You can choose for the PPM1 to automatically detect the wavelength sent by the source. Enabling this option signifies that the test unit is always verifying if the wavelength is included in the incoming signal.

This means, however, that when the automatic detection option is active and that your unit receives a signal or when the source is in auto-switching mode, you cannot manually change the power meter wavelength. The power meter behavior is totally determined by the source.



**Note:** *The auto detection option is activated by default.*

**Note:** *The automatic wavelength detection is only available for the broadband mode.*

When the automatic detection is not active, you can still select the auto-wavelength parameters; this mean that you have control to select a specific wavelength even if the PX1 receives an auto-wavelength or auto-switching signal.



**To receive the auto-wavelength signal or detect the source's auto-switching mode:**

1. From the main page, tap the  icon to access the menu, then select .
2. Under **Broadband power meter**, tap **Auto detect WL**.

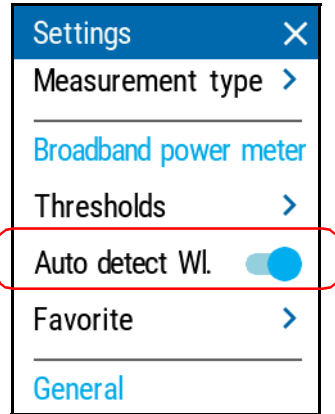

3. Connect a compatible source to your power meter.
4. Activate the source in auto mode (refer to the user documentation of the source for more information) or in auto-switching mode.

Your power meter automatically matches the source wavelength. If the wavelengths differ, it also beeps and returns you to normal operating mode.

## Setting up and Using Your PPM1



*Working With Broadband Pass/Fail Thresholds (Pro Models)*

---

# Working With Broadband Pass/Fail Thresholds (Pro Models)

Either in live measurement or stored measurement mode, the application displays a pass or fail status when thresholds are applied.

### **To configure thresholds**

1. From the main page, tap the  icon to access the menu, then select .
2. Under **Broadband power meter**, tap **Thresholds**.

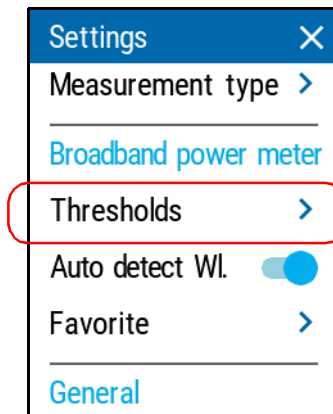

## Setting up and Using Your PPM1

### Working With Broadband Pass/Fail Thresholds (Pro Models)

---

3. Select whether the threshold values will be valid for all wavelengths, if each wavelength will have specific thresholds or if no thresholds will be used for the measurements.

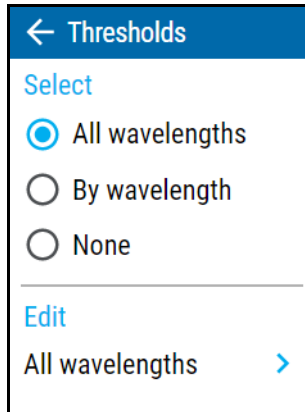

4. Depending on the option you have selected, select the corresponding menu.

**Note:** If you select **By wavelength**, select the desired wavelength as well.

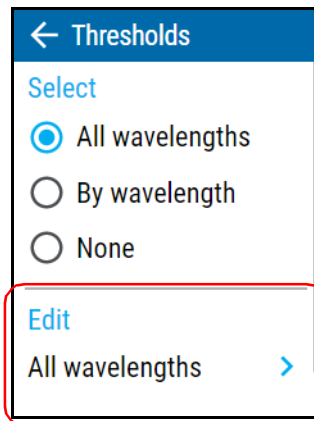

## Setting up and Using Your PPM1

### *Working With Broadband Pass/Fail Thresholds (Pro Models)*

---

5. You can enable or disable the thresholds using the corresponding sliders. If you want to change the value, tap on the threshold you want to modify.

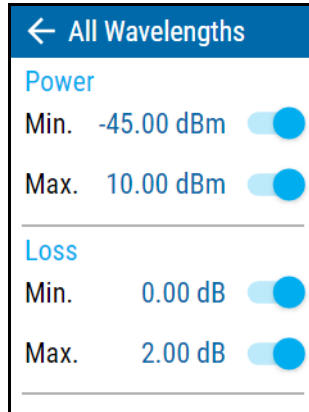

6. Enter a new value using the arrow buttons.

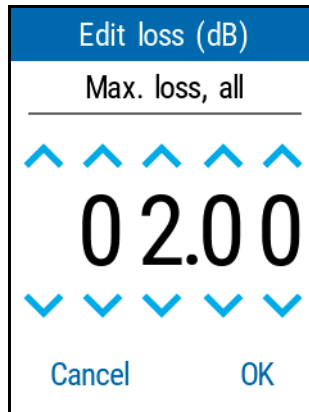

7. Tap **OK** to return to the page you were beforehand. The new thresholds are taken into account for the next measurement.

## Setting Reference Values on Your PPM1

In loss measurement mode, your unit displays on screen the loss created by the fiber under test, since it subtracts a reference value from the measured power.

You can set a different reference value for each wavelength. The reference values are kept in memory until you define new ones.

### **To set reference values:**

1. Inspect your fibers and clean them properly.
2. Using the proper adapter and test jumpers, connect a light source to your unit.
3. Select the wavelength for which you want to take a reference, as explained in *Changing Wavelengths (Pro Models)* on page 43.
4. From the main window, tap **REF**.

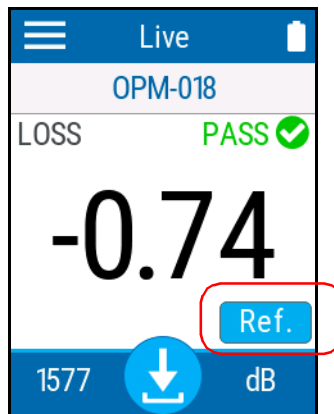

## Setting up and Using Your PPM1

### *Setting Reference Values on Your PPM1*

---

5. You can set the reference in two different ways:
  - Tap in the Ref. section to change the value as needed.OR
  - Measure the power of the source as the reference and tap **Take Reference** to use the resulting measurement.

Set reference <span>×</span>		
WL. (nm)	Power (dBm)	Ref. (dBm)
1310	-11.23	0.00
1490	-8.67	0.00
1550	-24.92	0.00

Tap on reference to edit.

**Take Reference**

You are returned to the main window automatically and the reference is effective immediately.



6. Select another wavelength and repeat the process to set another reference.

## Switching Between Power and Loss Measurements

You can switch between the power and loss measurement modes of the unit directly on the main page. The power units you have selected in *Changing the Power Units* on page 35 will apply accordingly when you change the mode.

When using the unit in PON mode, the loss measurement mode is not enabled by default. If you want to use this mode, you will have to enable it.

### **To select the available measurement types in PON mode:**

1. From the main page, tap the  icon to access the menu, then select .
2. Under **PON power meter**, tap **Measurement type**.

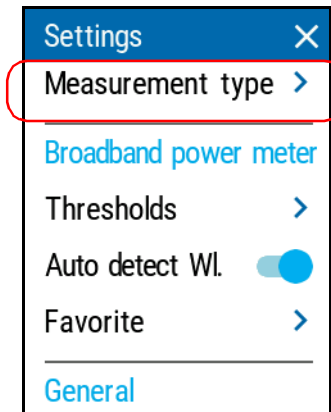

## Setting up and Using Your PPM1

### *Switching Between Power and Loss Measurements*

---

3. Select whether you want to measure power, or power and loss.

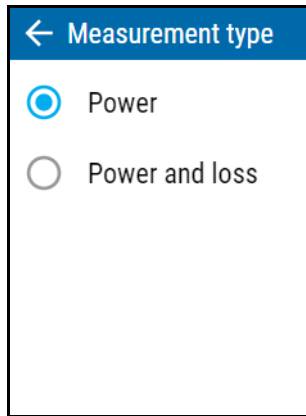

4. Tap the arrow to return to the **Settings** window.



#### **To change the measurement mode:**

From the main page, tap the mode at the bottom right part of the screen to switch modes.

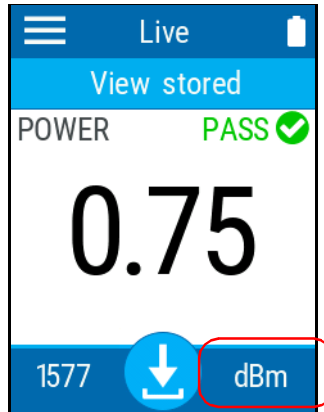

**Note:** *When the selected wavelength does not match the one measured by the unit's internal detector, you might see the screen display "Low", but the modulation will still be detected and displayed on-screen. This is due to the fact that your PPM1 is equipped with two detectors and while the power value does not correspond to the expected value, the unit is still able to display the detected modulation.*

## Nulling Electrical Offsets



Temperature and humidity variations affect the performance of electronic circuits and optical detectors. Nulling the electrical offsets eliminates these effects.



### IMPORTANT

If light reaches the detector when nulling offsets, you will be notified and the nulling is not performed. You can retry after putting a cap on the detector.

#### To perform an offset nulling:

1. If you have not done so already, put a cap on the detector.
2. From the main page, tap the  icon to access the menu, then select .
3. Under **General**, tap **Offset nulling**.

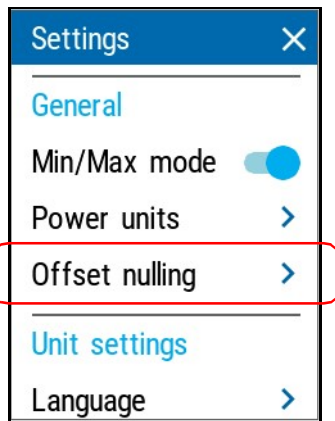

4. Tap **Nulling** and wait for the operation to complete. Once it is done, tap **OK** to return to the **Settings** page.

### Measuring Power or Loss

Measuring absolute power or link loss is done the same way, except for the referencing step.

**To perform power measurements:**

1. Inspect both connectors of the fiber under test and the power meter input connector and clean them properly.
2. Connect the fiber to the connector port.
3. Select a wavelength and activate the source at the same wavelength.

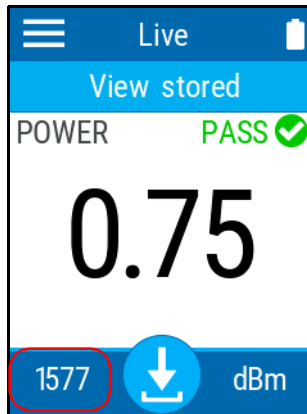



## Setting up and Using Your PPM1

### Measuring Power or Loss

---

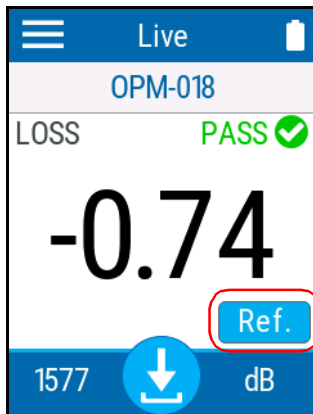
4. If you have not done so already, take a reference for the wavelength as explained in *Setting Reference Values on Your PPM1* on page 55.





5. Tap  or press the  button to store the measurement.
6. Repeat the procedure for other wavelengths.

### Working in Min./Max. Mode

With the Hold Min/Max mode you can record extreme values of a varying power signal. You could use it to test the variations of the live fiber signal over time. In this mode, the unit displays the minimum or maximum power value read up to now. It continuously updates the display if a new min/max is measured.

**To enable the min./max. mode:**

1. From the main PPM1 page, tap the  icon to access the menu, then select .
2. Under **General**, tap **Min./Max mode**.

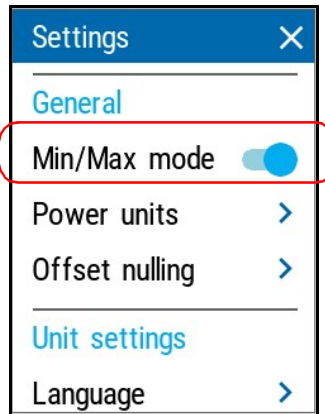

## Setting up and Using Your PPM1

*Working in Min./Max. Mode*

---

The minimum and maximum values will be indicated on screen when you return to the main window.

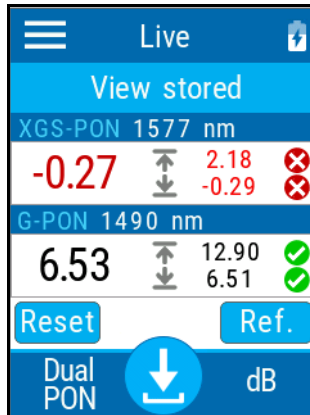

### Using the VFL

Your unit may be equipped with a VFL that you can set to the following modes:

- Continuous
- Slow blink
- Fast blink.



### WARNING

Do not install or terminate fibers while a light source is active. Never look directly into a live fiber and ensure that your eyes are protected at all times.

#### **To activate the VFL:**

1. From the main page, tap the  icon to access the menu, then select .

**Note:** *If the VFL is enabled already, you can also access the VFL menu using the active VFL icon in the main window.*

## Setting up and Using Your PPM1

Using the VFL

---

2. Select the desired mode for the signal from the available choices.

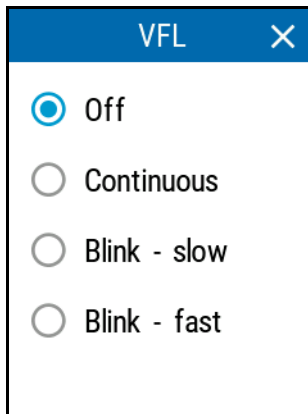

3. Tap  to exit the page and return to the main window. The active VFL icon will appear at the top to indicate that it is emitting.





**Note:** *The icon can also be used to access the VFL menu.*

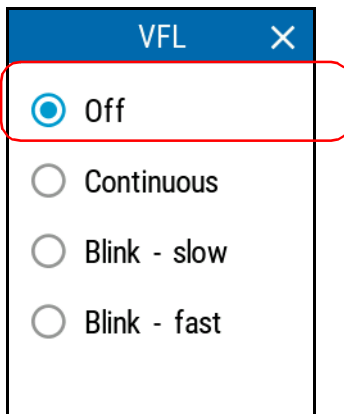

### **To deactivate the VFL:**

1. From the main page, tap the  icon to access the menu, then select .
2. Select **Off**.





3. Tap  to exit the page and return to the main window.

## Reverting to Factory Settings

At any time, you can use one of these options, according to your needs:

- reset all settings of the unit that you have customized, such as the thresholds, to their default values
- reset the PPM1 to factory settings

### **To revert values to factory settings:**

1. From the main page, tap the  icon to access the menu, then select .
2. Scroll down to the **Unit settings** section.
3. Tap **Reset options**.

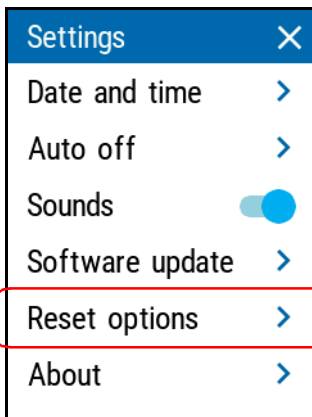

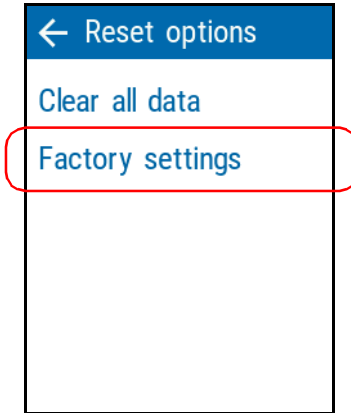

4. Select the desired option.



5. Tap **OK** to confirm your choice.

**To reset threshold settings:**

1. From the main page, tap the  icon to access the menu, then select .
2. Under **Broadband power meter**, tap **Thresholds**.

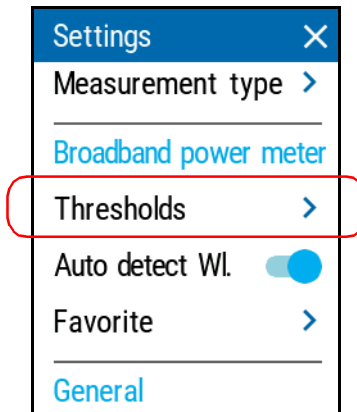

## Setting up and Using Your PPM1

### Reverting to Factory Settings

---

3. Select the category for which you want to reset the thresholds, then enter the edit mode.

**Note:** If you select the **By wavelength** menu, select the desired wavelength as well.

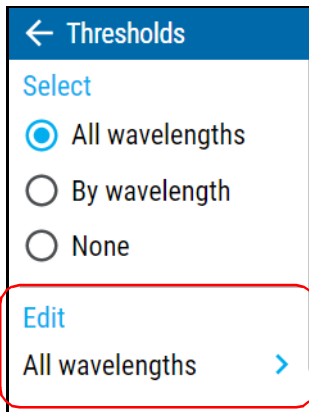

4. Scroll down to the bottom of the page and tap **Reset to defaults**.

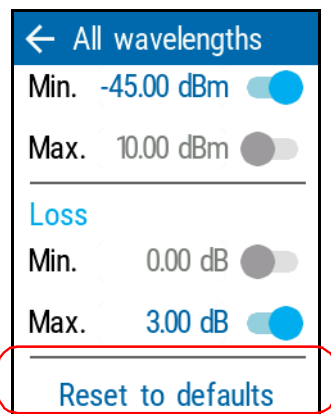

## 4 **Managing Test Results**

You can view measurements directly from your unit, or transfer them to a computer by connecting it with a USB cable.

### **Viewing Measurements**

Every time you perform a measurement, the unit saves it using OPM, then a sequential number. You can save up to 1000 measurements. When you reach 1001, the unit will start to overwrite the oldest measurement with the new one.

**Note:** *The unit will prompt you before overwriting old measurements.*

**To view the stored measurements:**

1. From the main window, tap **View stored**.

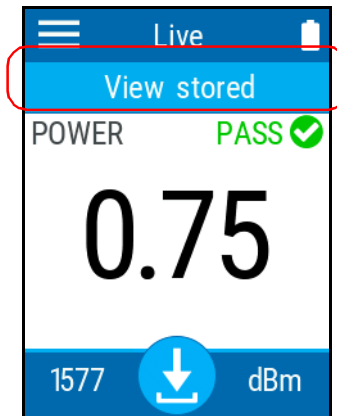

## Managing Test Results

### Viewing Measurements

---

2. Use the arrow button on each side of the page to go to the previous or next measurement.

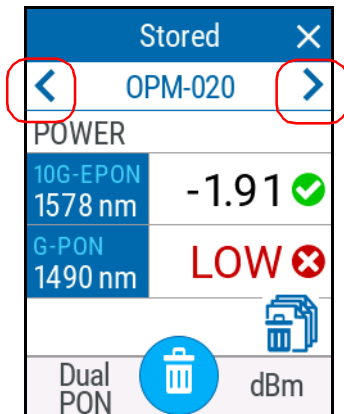



## Viewing Results in the Margin Meter

The margin meter allows you to see at a glance whether your measurement is within the threshold range that you have set.

### **To see the margin meter view:**

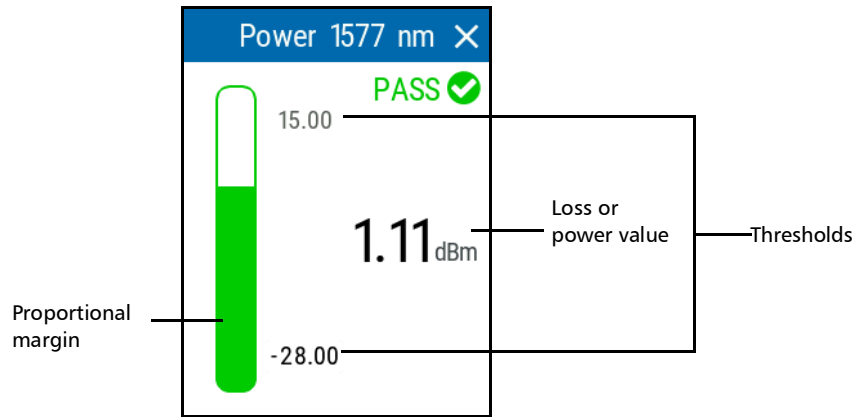
Once you have a value on-screen, simply tap on it to see the view.



Tap on  to close the view.

## Managing Test Results

### *Deleting Measurements (Clearing Data)*

---

## Deleting Measurements (Clearing Data)

To free up some disk space on your unit, you can manually delete the stored measurements. You can delete all of the measurements from the **Settings** window, or you can delete individual or all results from the stored measurement window.



**Note:** *The unit will always use the next name in sequence to store a measurement. This means that, for example, even if you delete the OPM-003 measurement right after it is complete, the unit will not reuse OPM-003 for the next measurement but will use OPM-004.*



### IMPORTANT

All of the stored measurements will be deleted, you cannot select them. Deleted measurements cannot be recovered.

#### ***To delete measurements from the Settings window:***

1. From the main PPM1 page, tap the  icon to access the menu, then select .
2. Scroll down to the **Unit settings** section.



3. Tap **Reset options**.

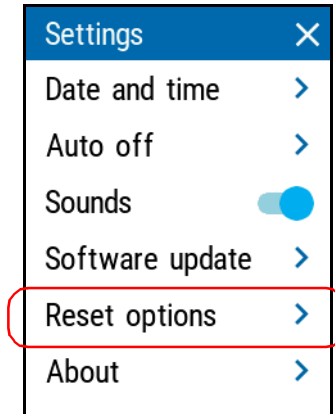

4. Select the desired option.

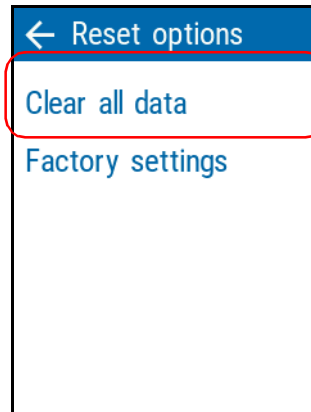

5. Tap **OK** to confirm your choice.

## Managing Test Results

### *Deleting Measurements (Clearing Data)*

---

**To delete measurements from the stored measurements window:**

1. From the main window, tap **View stored**.

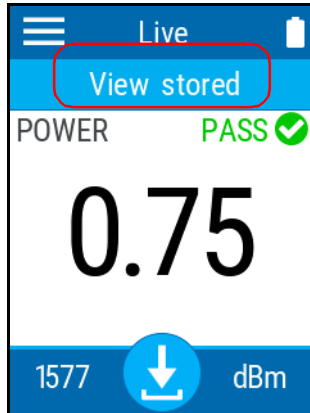

2. To remove the current measurement, tap .

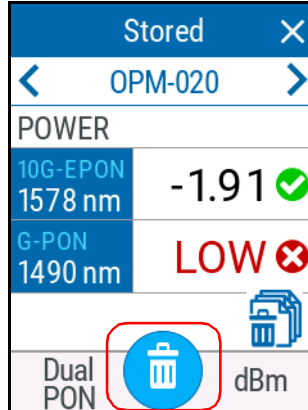

3. Confirm your choice by tapping **Delete**.

## Transferring Results to a Computer

You can use the USB connection to transfer your test results directly to a computer. The files are not deleted from your unit.

**Note:** *Depending on the number of results, this process may take some time.*

**Note:** *You cannot delete tests on the unit from the computer. Use the corresponding option as explained in Deleting Measurements (Clearing Data) on page 74.*

**Note:** *You cannot upload results from the computer to the unit.*

### **To transfer the results to a computer:**

1. While your unit is on, connect the USB cable to an available port on the computer. The unit will prepare the results. You can see the progress on-screen.

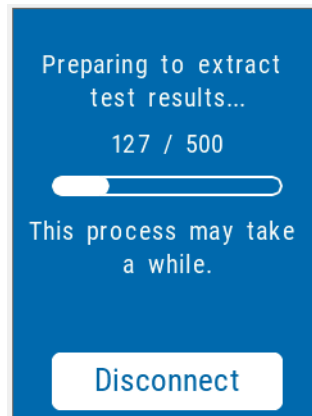

**Note:** *Tapping **Disconnect** at this moment will stop the process.*

## Managing Test Results

### *Transferring Results to a Computer*

---

2. Once the process is complete, a window opens on the computer to display the list of results, under a subfolder named *My Tests*. You can take them and copy them to the location of your choice on your computer.
3. To exit the file transfer mode on your unit and return to the main window, tap **Disconnect**.

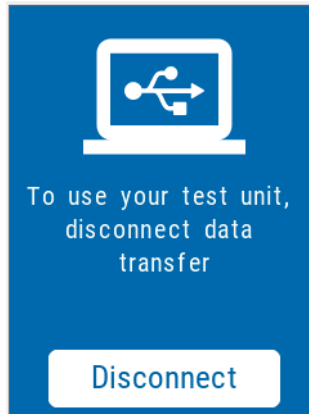

**Note:** *The charging process will continue even if you disconnect the transfer mode.*

# 5 **Maintenance**

To help ensure long, trouble-free operation:

- Always inspect fiber-optic connectors before using them and clean them if necessary.
- Keep the unit free of dust.
- Clean the unit casing and front panel with a cloth slightly dampened with water.
- Store unit at room temperature in a clean and dry area. Keep the unit out of direct sunlight.
- Avoid high humidity or significant temperature fluctuations.
- Avoid unnecessary shocks and vibrations.
- If any liquids are spilled on or into the unit, turn off the power immediately, disconnect from any external power source, remove the batteries and let the unit dry completely.



## **WARNING**

The use of controls, adjustments and procedures, namely for operation and maintenance, other than those specified herein may result in hazardous radiation exposure or impair the protection provided by this unit.

## Maintenance

### *Cleaning Optical Connectors Using a Mechanical Cleaner*

---

# Cleaning Optical Connectors Using a Mechanical Cleaner

Optical connectors are fixed on your unit and can be cleaned using a mechanical cleaner.



## WARNING

Verifying the surface of the connector with a fiber-optic microscope **WHILE THE UNIT IS ACTIVE** will result in permanent eye damage.



## CAUTION

If you are cleaning an with a mechanical cleaner, do not remove it from your device to clean it.

### ***To clean a connector using a mechanical cleaner:***

1. Insert the cleaning tip into the optical adapter, and push the outer shell into the cleaner.

**Note:** *The cleaner makes a clicking sound to indicate that the cleaning is done.*

2. Verify connector surface with a fiber inspection probe (for example, EXFO's FIP).

## Cleaning the Touchscreen

Clean the touchscreen with a soft, non-abrasive cloth, such as one used for cleaning reading glasses, dampened with water.



### **CAUTION**

Using anything else than water can damage the special coating of the touchscreen.

## Recharging the Battery

Your unit uses one lithium-polymer (Li-Po) battery.

- The charge status is shown in the upper right corner of the title bar. A red icon indicates that the battery level is running low and that you should connect the unit to a power outlet.
- The unit also indicates the charge status with the LED on its front panel.



### **CAUTION**

Only charge the battery with the USB cable or power adapter provided by EXFO with your unit.

## Maintenance

### Recharging the Battery

---



## IMPORTANT

- ▶ The battery is not charged at the factory. You must fully charge it before using the unit for the first time. The battery is fully charged after a few hours or when the battery LED indicator is steady blue.
- ▶ The time required to charge the battery depends on various factors such as the type of tests currently performed and the ambient temperature.
- ▶ To ensure that the battery functions properly, keep it in temperatures between  $-10\text{ }^{\circ}\text{C}$  and  $45\text{ }^{\circ}\text{C}$  ( $14\text{ }^{\circ}\text{F}$  and  $113\text{ }^{\circ}\text{F}$ ). Store it between  $10\text{ }^{\circ}\text{C}$  to  $35\text{ }^{\circ}\text{C}$  ( $50\text{ }^{\circ}\text{F}$  to  $95\text{ }^{\circ}\text{F}$ ).  
When the ambient temperature is below  $0\text{ }^{\circ}\text{C}$  ( $32\text{ }^{\circ}\text{F}$ ) or when it reaches or exceeds about  $40\text{ }^{\circ}\text{C}$  ( $104\text{ }^{\circ}\text{F}$ ), the battery can either charge more slowly than usual, or not charge at all, depending on the internal temperature of your unit.
- ▶ Do not leave a battery discharged for several days.
- ▶ Should you notice a decrease of the autonomy each battery charge provides, you may want to replace the battery with a new one to maintain optimal operation conditions.





## IMPORTANT

- If you need to store the unit (or a battery) for an extended period of time, ensure that the battery is charged at around 50 % of its capacity, and then turn the unit off (shutdown).
- Place the unit (or the battery) in a cool dry place. Every three months during the storage period, verify the battery level. Recharge the battery when necessary, so that its charge level remains around 50 % of the total capacity. This will ensure that you get the optimum performance out of the battery.

### **To recharge the battery:**

Connect the unit to a power outlet using the USB power adapter (fastest way to charge the battery).

**Note:** *The standard USB ports of a computer might not provide sufficient power for your unit or charge its battery while the unit is on. If you connect your unit to such a USB port with the cable, the unit may still consume battery power. If the unit is off when you connect it to the USB port of a computer, its battery will charge, but slowly.*

**Note:** *If you have a vehicle equipped with dedicated USB charging ports, you could connect your unit to one of these ports to charge the battery. The actual results will vary with each vehicle. You could also use a certified USB power bank (portable charger) to charge your unit.*

The charge cycle will start and end automatically.

## Maintenance

### Battery Maintenance Recommendations

---



#### **WARNING**

Your unit uses the following type of batteries: smart lithium-polymer (Li-Po).

These are batteries with built-in protection that have been especially designed for EXFO. For this reason, you can only replace them with EXFO-approved batteries of the same type and model.



#### **WARNING**

The use of unapproved batteries may result in the batteries expanding or igniting (that is, catching fire).



#### **WARNING**

Risk of explosion if battery is replaced by an incorrect type. Dispose of used batteries according to the manufacturer's instructions.



#### **WARNING**

Do not throw batteries into fire or water and do not short-circuit their electrical contacts. Do not disassemble.



#### **IMPORTANT**

Recycle or dispose of used batteries properly, in accordance with local regulations. Do not dispose of them in ordinary garbage receptacles. For more information, see the section about recycling and disposal in this user documentation.

- At EXFO, we take the safety of our customers very seriously and want to make sure any battery replacement is done properly.

The batteries of all EXFO-branded products are tested, certified, and in compliance with these international safety standards:

- United Nations (UN) Transport Regulations UN38.3: Covers battery safety during air transport.
- UL 61010-1, CAN/CSA C22.2 61010-1 and International Standard IEC/EN 61010-1: Covers the use of batteries for test and measurement equipment.
- International Standard IEC 62133: Covers secondary cells and batteries containing alkaline or other non-acid electrolytes.
- In some countries, when required, EXFO-approved batteries have been certified and are marked as per local regulation.
- To get pricing and correct part number for replacement batteries for your products, please contact (via email):
  - For Americas: [Isales.us@exfo.com](mailto:Isales.us@exfo.com)
  - For Europe: [Isales.emea@exfo.com](mailto:Isales.emea@exfo.com)
  - For APAC: [Isales.apac@exfo.com](mailto:Isales.apac@exfo.com)
  - For China: [Isales.China@exfo.com](mailto:Isales.China@exfo.com)
- You may also obtain replacement batteries for your products by contacting your local distributor:  
<https://www.exfo.com/en/how-to-buy/find-distributor>
- You may return your unit for service at your local service center:  
<https://www.exfo.com/en/services/field-network-testing/exfo-service-centers/>

## Replacing the Battery

Your unit can be powered either by battery or from an appropriate power outlet when used with the provided USB power adapter.

For more information on the available power sources for your unit, as well as their characteristics, refer to the *Technical Specifications* of your product.



### CAUTION

Electrostatic discharge (ESD) damage can cause complete or intermittent equipment failures.

- Always use an ESD-preventive wrist or ankle strap when replacing the battery. Ensure that the antistatic strap makes good skin contact and that the end of its wire is grounded properly.
- Never touch any component inside the unit other than those identified in the procedure hereafter, either with tools or your fingers.

#### **To replace the battery:**

- 1.** Turn off the unit and disconnect the fiber and USB cable (if applicable).
- 2.** Position the unit so that its front panel rests on a flat surface such as a table.
- 3.** On the back of the unit, using a Phillips screwdriver, turn the screws (4) counterclockwise until they are loose, and remove them.

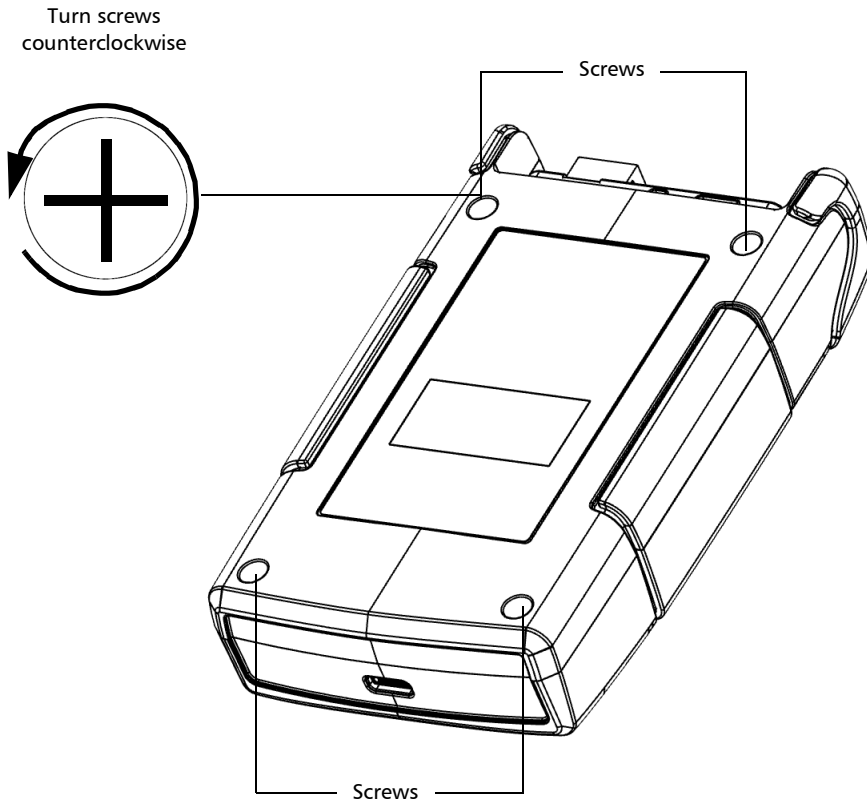

## Maintenance

### *Replacing the Battery*

---

4. Hold the back panel by its sides and pull it up to remove it.

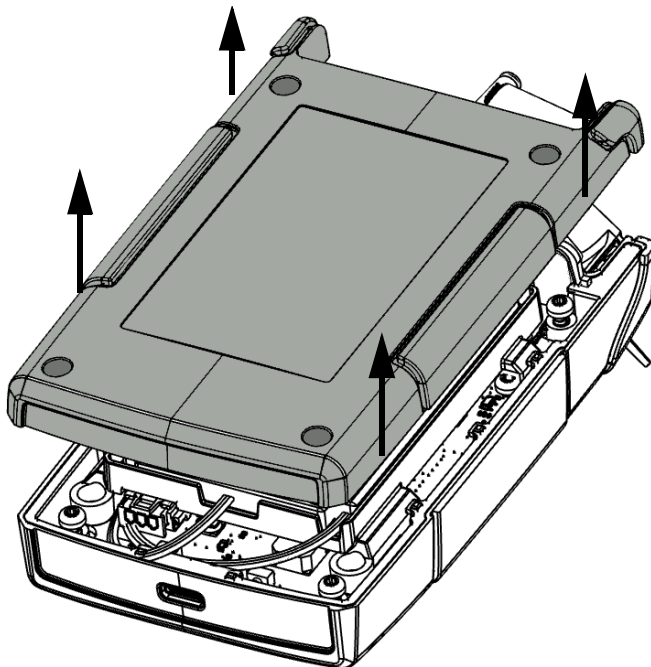

5. Gently pull on the battery connector to disconnect it from its socket.

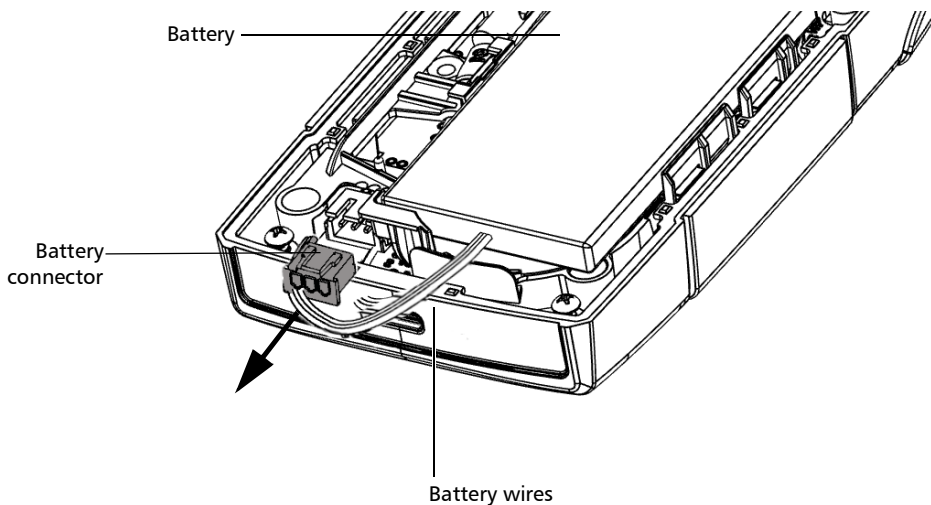

6. Pull the battery up to remove it.

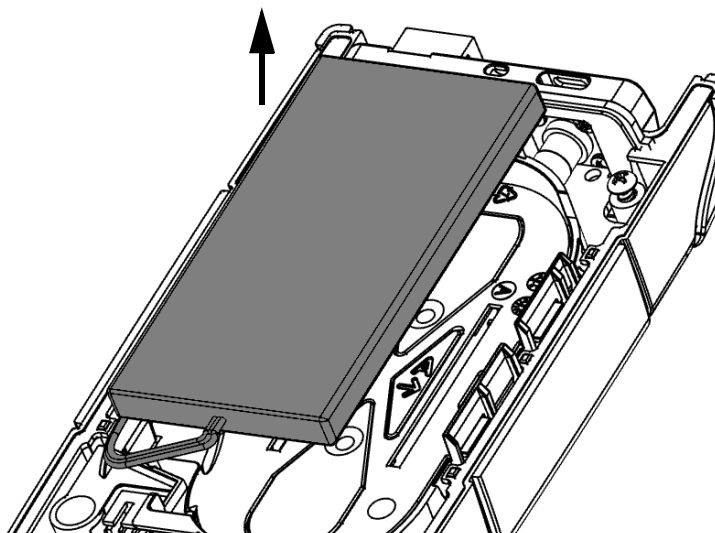

## Maintenance

### Replacing the Battery

---

7. Place the new battery so that its wires are located on the right side, toward the front.

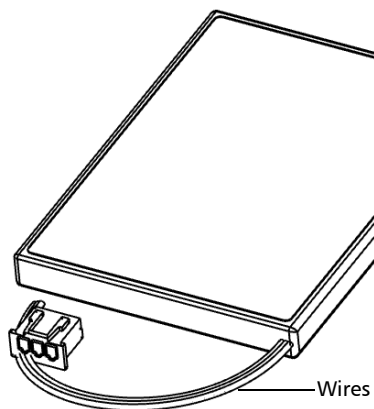

8. Place the new battery into the case.

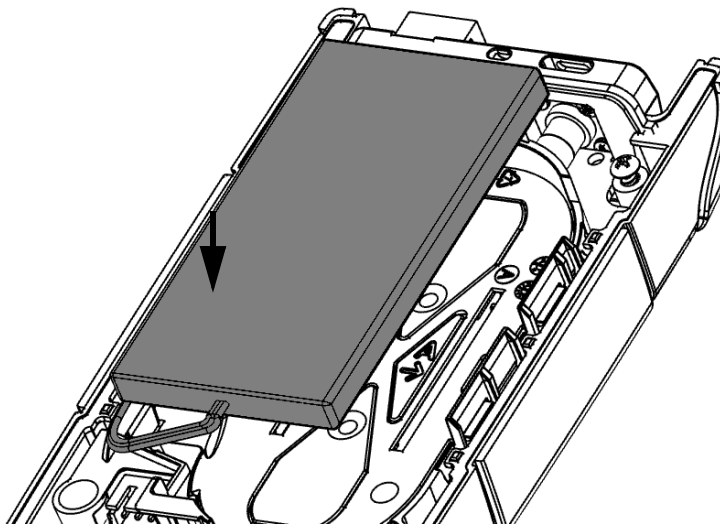



- 9.** Connect the battery connector to the corresponding socket.

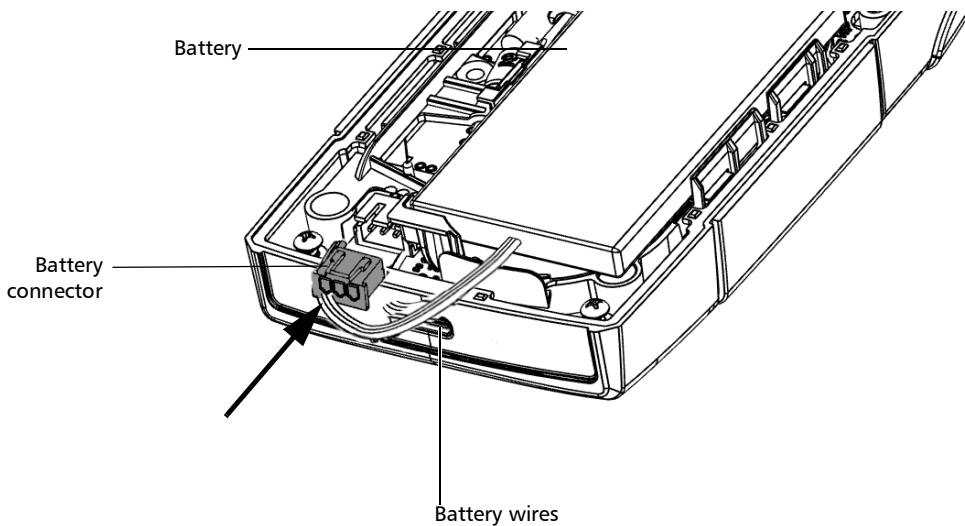

## Maintenance

### *Replacing the Battery*

---

- 10.** If the rubber gasket has moved while you replaced the battery, make sure to set it back in place, anchoring it to the small holding pins around the unit.



## CAUTION

Make sure the gasket is anchored all around and not displaced or folded as it contributes to fully sealing your unit.

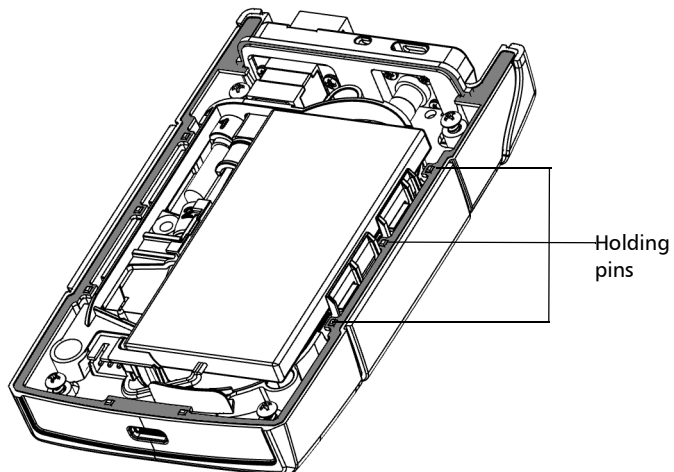

- 11.** Place the back panel on the unit, making sure that it is aligned properly with the front of the unit. The sides of the back panel should be flush with those of the front. There should be no gap between the back panel and the front of the unit. If necessary, slightly move the back panel until alignment is correct.

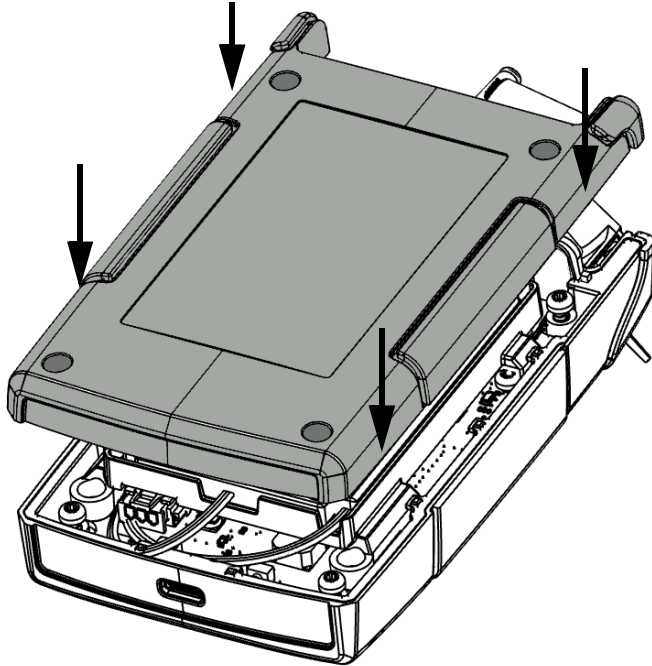

- 12.** Using a Phillips screwdriver, turn the screws (4) clockwise until they are tightened.

This will secure the back panel into place.

## Updating the Application

The application on your unit has been preinstalled and configured at the factory. However, you may have to update it when new versions become available. Your unit allows you to check for updates, download these updates and install them directly. You can update your unit by connecting to a computer using a USB cable.

### Updating Using the USB Connection

You must download the latest version of the firmware binary file from the EXFO web site and have it on the computer you plan to use for the update prior to updating your unit.

#### ***To update the application:***

- 1.** On the computer you plan to use for the update, go to the EXFO Apps web site at <https://www.exfo.com/en/exfoapps>, select your unit, then download the latest software package version.
- 2.** If you have not already done so, turn on your unit.
- 3.** Connect the USB cable to an available port on the computer and to the PPM1.
- 4.** If you have results on your unit and want to copy them elsewhere on your computer, see *Transferring Results to a Computer* on page 77. Once the file preparation is complete, a window opens on the computer to display the list. Leave this window open.
- 5.** Still in the transfer window on the computer, select the **Software Update** folder and place the new firmware binary file in it.

6. Once the file is copied to the unit, tap **Disconnect** or disconnect the USB cable from the computer.

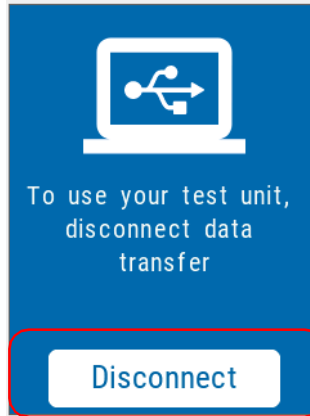

The unit will restart automatically and the update process begins. Once the update is complete, the binary file will be automatically deleted from your unit.

## Recalibrating the Unit

EXFO manufacturing and service center calibrations are based on the ISO/IEC 17025 standard (*General Requirements for the Competence of Testing and Calibration Laboratories*). This standard states that calibration documents must not contain a calibration interval and that the user is responsible for determining the re-calibration date according to the actual use of the instrument.

The validity of specifications depends on operating conditions. For example, the calibration validity period can be longer or shorter depending on the intensity of use, environmental conditions and unit maintenance, as well as the specific requirements for your application. All of these elements must be taken into consideration when determining the appropriate calibration interval of this particular EXFO unit.

Under normal use, the recommended interval for your PPM1 PON Power Meter is: three years.

For newly delivered units, EXFO has determined that the storage of this product for up to six months between calibration and shipment does not affect its performance.

To help you with calibration follow-up, EXFO provides a special calibration label that complies with the ISO/IEC 17025 standard and indicates the unit calibration date and provides space to indicate the due date. Unless you have already established a specific calibration interval based on your own empirical data and requirements, EXFO would recommend that the next calibration date be established according to the following equation:

**Next calibration date = Shipping date + Recommended calibration period (three years)**

To ensure that your unit conforms to the published specifications, calibration may be carried out at an EXFO service center or, depending on the product, at one of EXFO's certified service centers. Calibrations at EXFO are performed using standards traceable to national metrology institutes.

## Recycling and Disposal



This symbol on the product means that you should recycle or dispose of your product (including electric and electronic accessories) properly, in accordance with local regulations. Do not dispose of it in ordinary garbage receptacles.

For complete recycling/disposal information, visit the EXFO Web site at [www.exfo.com/recycle](http://www.exfo.com/recycle).

## **Maintenance**

*Recycling and Disposal*

---



# 6 Troubleshooting

## Solving Common Problems

Problem	Possible Cause	Solution
My unit does not start.	The battery is completely discharged (if the battery level allows it, the unit's LED will blink quickly to indicate the low battery status).	Connect the unit to an external power source to recharge the battery. If the battery is no longer charging properly, you may need to replace it with a new one (see <i>Replacing the Battery</i> on page 86).
My unit is not responding.	The system has encountered a problem.	Restart the unit.
The battery is not recharging.	Ambient temperature is too high or too low.	Make sure that the temperature in the location where you recharge the battery is within the specifications.
	The USB power adapter is not connected properly.	Make sure that the USB power adapter is connected to the unit and the AC outlet.  If the USB power adapter is connected properly and the problem persists, it could mean that the USB power adapter is defective. In this case, try replacing the adapter. You can purchase new USB power adapters from EXFO.
<ul style="list-style-type: none"><li>▶ I have just replaced the battery and the battery gauge is not accurate on-screen</li><li>▶ The battery level indicator does not reflect the actual charge level.</li></ul>	The recharge cycle must be reset for this new battery.	Perform a full discharge and charge cycle of the unit.

# Accessing the Online Documentation

You can also access the user guide at all times from a smart device or a computer:

- by scanning the QR code displayed on your unit
- by entering the corresponding link in a web browser

**To access the user guide access information:**

1. From the main PPM1 page, tap the  icon to access the menu, then select .
2. Scan the QR code with your smart device or enter the link on your web browser.



## **Contacting the Technical Support Group**

To obtain after-sales service or technical support for this product, contact EXFO at one of the following numbers. The Technical Support Group is available to take your calls from Monday to Friday, 8:00 a.m. to 7:00 p.m. (Eastern Time in North America).

### **Technical Support Group**

400 Godin Avenue  
Quebec (Quebec) G1M 2K2  
CANADA

1 866 683-0155 (USA and Canada)  
Tel.: 1 418 683-5498  
Fax: 1 418 683-9224  
support@exfo.com

For detailed information about technical support, and for a list of other worldwide locations, visit the EXFO Web site at [www.exfo.com](http://www.exfo.com).



If you have comments or suggestions about this user documentation, you can send them to [customer.feedback.manual@exfo.com](mailto:customer.feedback.manual@exfo.com).

To accelerate the process, please have information such as the name and the serial number (see the product identification label), as well as a description of your problem, close at hand.

## Viewing System Information



You can easily access important information such as the model of your unit, the serial number, the software and hardware versions, as well as the latest hardware calibration, directly from your unit. You can also find the contact information if you ever need to reach EXFO.

### **To view the system information:**

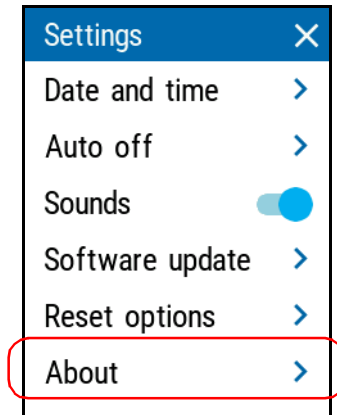
1. From the main PPM1 page, tap the  icon to access the menu, then select .
2. Under **Unit settings**, tap **About**.



#### To retrieve the contact information:

1. From the main PPM1 page, tap the  icon to access the menu, then select .
2. Scroll down the window. The information you want to view is displayed on screen.

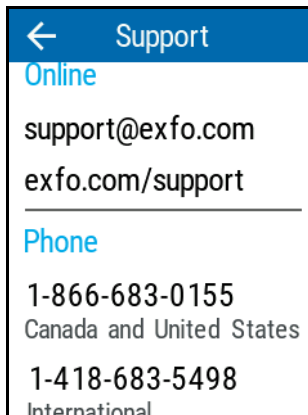

## Transportation

Maintain a temperature range within specifications when transporting the unit. Transportation damage can occur from improper handling. The following steps are recommended to minimize the possibility of damage:

- Pack the unit in its original packing material when shipping.
- Avoid high humidity or large temperature fluctuations.
- Keep the unit out of direct sunlight.
- Avoid unnecessary shocks and vibrations.



# 7 **Warranty**

## **General Information**

EXFO Inc. (EXFO) warrants this equipment against defects in material and workmanship for a period of three years from the date of original shipment. EXFO also warrants that this equipment will meet applicable specifications under normal use.

During the warranty period, EXFO will, at its discretion, repair, replace, or issue credit for any defective product, as well as verify and adjust the product free of charge should the equipment need to be repaired or if the original calibration is erroneous. If the equipment is sent back for verification of calibration during the warranty period and found to meet all published specifications, EXFO will charge standard calibration fees.



### **IMPORTANT**

The warranty can become null and void if:

- **unit has been tampered with, repaired, or worked upon by unauthorized individuals or non-EXFO personnel.**
- **warranty sticker has been removed.**
- **case screws, other than those specified in this guide, have been removed.**
- **case has been opened, other than as explained in this guide.**
- **unit serial number has been altered, erased, or removed.**
- **unit has been misused, neglected, or damaged by accident.**

THIS WARRANTY IS IN LIEU OF ALL OTHER WARRANTIES EXPRESSED, IMPLIED, OR STATUTORY, INCLUDING, BUT NOT LIMITED TO, THE IMPLIED WARRANTIES OF MERCHANTABILITY AND FITNESS FOR A PARTICULAR PURPOSE. IN NO EVENT SHALL EXFO BE LIABLE FOR SPECIAL, INCIDENTAL, OR CONSEQUENTIAL DAMAGES.

## **Warranty**

### *Gray Market and Gray Market Products*

---

## **Gray Market and Gray Market Products**

Gray market is a market where products are traded through distribution channels that are legal but remain unofficial, unauthorized, or unintended by the original manufacturer. Intermediaries using such channels to distribute products are considered to be part of the gray market (hereafter unauthorized intermediary).

EXFO considers that a product originates from the gray market (hereafter gray market product) in the following situations:

- A product is sold by an unauthorized intermediary.
- A product is designed and destined for a particular market and sold on a second market.
- A product is resold, despite being reported lost or stolen.

When products are purchased on the gray market, rather than through an authorized EXFO distribution channel, EXFO is unable to guarantee the source and quality of those products nor the local safety regulations and certifications (CE, UL, etc.).

EXFO will not honor warranty, install, maintain, repair, calibrate, provide technical support nor make any support contracts available for gray market products.

For complete information, refer to EXFO's policy regarding gray market products at [www.exfo.com/en/how-to-buy/sales-terms-conditions/gray-market/](http://www.exfo.com/en/how-to-buy/sales-terms-conditions/gray-market/)



## Liability

EXFO shall not be liable for damages resulting from the use of the product, nor shall be responsible for any failure in the performance of other items to which the product is connected or the operation of any system of which the product may be a part.

EXFO shall not be liable for damages resulting from improper usage or unauthorized modification of the product, its accompanying accessories and software.

## Exclusions

EXFO reserves the right to make changes in the design or construction of any of its products at any time without incurring obligation to make any changes whatsoever on units purchased. Accessories, including but not limited to fuses, pilot lamps, batteries and universal interfaces (EUI) used with EXFO products are not covered by this warranty.

This warranty excludes failure resulting from: improper use or installation, normal wear and tear, accident, abuse, neglect, fire, water, lightning or other acts of nature, causes external to the product or other factors beyond the control of EXFO.

## Certification



### **IMPORTANT**

In the case of products equipped with optical connectors, EXFO will charge a fee for replacing connectors that were damaged due to misuse or bad cleaning.

EXFO certifies that this equipment met its published specifications at the time of shipment from the factory.

# Service and Repairs

EXFO commits to providing product service and repair for five years following the date of purchase.

**To send any equipment for service or repair:**

1. Call one of EXFO's authorized service centers (see *EXFO Service Centers Worldwide* on page 109). Support personnel will determine if the equipment requires service, repair, or calibration.
2. If equipment must be returned to EXFO or an authorized service center, support personnel will issue a Return Merchandise Authorization (RMA) number and provide an address for return.
3. If possible, back up your data before sending the unit for repair.
4. Pack the equipment in its original shipping material. Be sure to include a statement or report fully detailing the defect and the conditions under which it was observed.
5. Return the equipment, prepaid, to the address given to you by support personnel. Be sure to write the RMA number on the shipping slip. *EXFO will refuse and return any package that does not bear an RMA number.*

**Note:** *A test setup fee will apply to any returned unit that, after test, is found to meet the applicable specifications.*

After repair, the equipment will be returned with a repair report. If the equipment is not under warranty, you will be invoiced for the cost appearing on this report. EXFO will pay return-to-customer shipping costs for equipment under warranty. Shipping insurance is at your expense.

Routine recalibration is not included in any of the warranty plans. Since calibrations/verifications are not covered by the basic or extended warranties, you may elect to purchase FlexCare Calibration/Verification Packages for a definite period of time. Contact an authorized service center (see *EXFO Service Centers Worldwide* on page 109).

## **EXFO Service Centers Worldwide**

If your product requires servicing, contact your nearest authorized service center.

### **EXFO Headquarters Service Center**

400 Godin Avenue  
Quebec (Quebec) G1M 2K2  
CANADA

1 866 683-0155 (USA and Canada)  
Tel.: 1 418 683-5498  
Fax: 1 418 683-9224  
support@exfo.com

### **EXFO Europe Service Center**

Winchester House, School Lane  
Chandlers Ford, Hampshire S053 4DG  
ENGLAND

Tel.: +44 2380 246800  
Fax: +44 2380 246801  
support.europe@exfo.com

### **EXFO Telecom Equipment (Shenzhen) Ltd.**

3rd Floor, Building C,  
FuNing Hi-Tech Industrial Park, No. 71-3,  
Xintian Avenue,  
Fuhai, Bao'An District,  
Shenzhen, China, 518103

Tel: +86 (755) 2955 3100  
Fax: +86 (755) 2955 3101  
support.asia@exfo.com

To view EXFO's network of partner-operated Certified Service Centers nearest you, please consult EXFO's corporate website for the complete list of service partners:

<http://www.exfo.com/support/services/instrument-services/exfo-service-centers>.



# Index

- A**
- absolute power ..... 61
  - AC requirements ..... 16, 17
  - accessing online help ..... 100
  - adapter ..... 15
  - adjusting
    - brightness ..... 28
    - date and time ..... 33
  - after-sales service ..... 101
  - applications, installing ..... 94
  - auto wavelength
    - detection ..... 50
    - selection ..... 44
  - auto-switching mode ..... 50
  - available
    - models ..... 4
    - wavelengths for measurement ..... 45
- B**
- backlight, setting ..... 28
  - battery
    - level ..... 81
    - maintenance recommendations ..... 81, 84
    - purchasing new ..... 85
    - recharging ..... 4, 7, 83
    - replacing or removing ..... 86, 87
    - status icons ..... 6, 81
    - status LED ..... 3, 5, 81
  - beep, enabling or disabling ..... 29, 30
  - blinking
    - LED ..... 5
    - VFL signal ..... 65
  - Bluetooth
    - frequency band data ..... xii, xiii
  - brightness
    - adjusting ..... 28
    - icon ..... 28
- C**
- button
    - on/off ..... 3, 5
    - Store ..... 3
  - calibrated wavelengths ..... 45
  - capacitors ..... 15
  - caution
    - of personal hazard ..... 9
    - of product hazard ..... 9
  - changing
    - battery ..... 86, 87
    - date and time ..... 33
    - measurement mode ..... 59
    - units ..... 35
  - charge
    - icon ..... 81
    - status of the battery ..... 81
  - charger ..... 15
  - charging battery ..... 4
  - cleaning
    - connectors ..... 80
    - fiber ends ..... 20
    - front panel ..... 79
    - touchscreen ..... 81
  - computer, transferring results ..... 77
  - configuring
    - brightness ..... 28
    - date and time ..... 33
    - delay before auto off ..... 26
    - min./max. mode ..... 63
    - pass/fail thresholds ..... 52
    - reference value ..... 55
    - sound notifications ..... 30
  - connector cleaner ..... 80
  - continuous VFL signal ..... 65
  - conventions, safety ..... 9

## Index

---

current, electrical ..... 17  
customer service..... 108

### D

date and time, adjusting ..... 33  
dBm, units..... 35  
default values..... 68  
deleting measurements..... 74  
detecting wavelength automatically ..... 50  
detector port, location ..... 3, 4  
disabling sounds ..... 29, 30  
disk space, freeing..... 74  
documentation ..... 100

### E

electrical offsets, nulling ..... 60  
enabling sounds..... 29, 30  
equipment returns ..... 108  
external power supply..... 15

### F

factory settings ..... 68  
fail status ..... 52  
favorite wavelengths..... 45  
fiber ends, cleaning..... 20  
files, transferring to a computer..... 77  
freeing disk space..... 74  
frequency, Bluetooth..... xii, xiii  
front panel, cleaning ..... 79

### H

help, online ..... 100  
high temperature ..... 8  
hour, setting ..... 33

### I

icon  
    battery status ..... 6, 81  
    brightness..... 28

identification label..... 101  
indoor use ..... 15  
input current ..... 17  
inserting battery..... 86, 87  
insertion loss ..... 61  
installing software..... 94  
internal temperature ..... 7

### L

label, identification..... 101  
language ..... 31  
LED  
    battery status..... 3, 81  
    indicators..... 5  
Li-ion/Li-Po battery ..... 7  
list of wavelengths ..... 43, 45  
loss, measuring..... 59, 61

### M

main  
    features..... 2  
    window..... 23  
maintenance  
    battery ..... 81, 84  
    front panel ..... 79  
    general information ..... 79  
    screen ..... 81  
manuals..... 100  
margin meter ..... 73  
maximum input current..... 17  
measurement  
    changing mode..... 59  
    deleting ..... 74  
    status ..... 52, 63  
    viewing ..... 71  
measuring power and insertion loss..... 61  
mechanical connector cleaning ..... 80  
min./max. mode ..... 63  
mode, changing ..... 59  
models available..... 4  
muting unit ..... 29, 30

- N**
- nulling electrical offsets ..... 60
- O**
- obtaining batteries ..... 85
  - off LED ..... 5
  - offset nulling ..... 60
  - on/off button ..... 3, 5
  - online help ..... 100
  - overwritten measurements ..... 71
- P**
- pass status ..... 52
  - pass/fail thresholds ..... 52
  - performing power and loss measurements . 61
  - port
    - detector ..... 3, 4
    - USB ..... 4
  - power
    - adapter ..... 7, 83
    - bank ..... 7, 83
    - button ..... 3, 5
    - changing units ..... 35
    - management ..... 26
    - measurement ..... 59, 61
    - see *also* battery
    - see *also* USB power adapter
    - sources ..... 17
    - supply ..... 15
  - product
    - identification label ..... 101
    - specifications ..... 8
  - purchasing new batteries ..... 85
- R**
- recharging the battery ..... 7, 81, 83
  - reference values ..... 55
  - regulatory information ..... vi, vii, x
- removing
  - battery ..... 86, 87
  - measurements ..... 74
- repairing unit ..... 15
- replacement batteries ..... 85
- replacing battery ..... 86, 87
- results, transferring to a computer ..... 77
- return merchandise authorization (RMA) .. 108
- S**
- safety
  - caution ..... 9
  - conventions ..... 9
  - warning ..... 9
- selecting
  - language ..... 31
  - wavelengths ..... 43
- service and repairs ..... 108
- service centers ..... 109
- setting
  - brightness ..... 28
  - date and time ..... 33
  - min./max. mode ..... 63
  - pass/fail thresholds ..... 52
  - reference value ..... 55
  - reset ..... 68
  - software update ..... 94
  - sound notifications ..... 30
- shipping to EXFO ..... 108
- shutting down ..... 22
- software, installing and upgrading ..... 94
- sound notifications ..... 29, 30
- specifications, product ..... 8
- storage requirements ..... 79
- storage space, managing ..... 74
- Store button ..... 3
- switching wavelengths ..... 50
- symbols, safety ..... 9

## Index

---

### T

taking a reference value .....	55
technical specifications .....	8
technical support .....	101
temperature for storage .....	79
temperature management .....	8
temperature, internal .....	7
thresholds, viewing .....	73
touchscreen	
cleaning .....	81
location .....	3
transferring results to computer .....	77
transportation requirements .....	79, 103
turning off	
sounds .....	29, 30
unit .....	19, 22
turning on	
sounds .....	29, 30
unit .....	19, 22
VFL .....	65

### U

understanding main window .....	23
unit	
repairing .....	15
unexpected shutdown .....	8
ventilation .....	16
units, changing .....	35
updating applications .....	94
USB	
port .....	4
power adapter .....	7, 83
power bank .....	7, 83
result transfer .....	77
upgrading application .....	94
user guides .....	100
user interface language .....	31

### V

ventilation .....	16
VFL	
location .....	3, 4
using .....	65
view, margin meter .....	73
viewing measurements .....	71

### W

warranty	
certification .....	107
exclusions .....	107
general .....	105
liability .....	107
null and void .....	105
watts, units .....	35
wavelengths	
automatic .....	44
changing .....	43
detecting automatically .....	50
favorites .....	45



CHINESE REGULATION ON RESTRICTION OF HAZARDOUS SUBSTANCES (RoHS)  
中国关于有害物质限制的规定

NAMES AND CONTENTS OF THE TOXIC OR HAZARDOUS SUBSTANCES OR ELEMENTS  
CONTAINED IN THIS EXFO PRODUCT  
包含在本 EXFO 产品中的有毒有害物质或元素的名称及含量

Part Name 部件名称	Lead 铅 (Pb)	Mercury 汞 (Hg)	Cadmium 镉 (Cd)	Hexavalent Chromium 六价铬 (Cr(VI))	Polybrominated biphenyls 多溴联苯 (PBB)	Polybrominated diphenyl ethers 多溴二苯醚 (PBDE)
Enclosure 外壳	O	O	O	O	O	O
Electronic and electrical sub-assembly 电子和电气组件	X	O	X	O	X	X
Optical sub-assembly <sup>a</sup> 光学组件 <sup>a</sup>	X	O	O	O	O	O
Mechanical sub-assembly <sup>a</sup> 机械组件 <sup>a</sup>	O	O	O	O	O	O

Note:

注:

This table is prepared in accordance with the provisions of SJ/T 11364.

本表依据 SJ/T 11364 的规定编制。

O: Indicates that said hazardous substance contained in all of the homogeneous materials for this part is below the limit requirement of GB/T 26572.

O: 表示该有害物质在该部件所有均质材料中的含量均在 GB/T 26572 标准规定的限量要求以下。

X: indicates that said hazardous substance contained in at least one of the homogeneous materials used for this part is above the limit requirement of GB/T 26572. Due to the limitations in current technologies, parts with the "X" mark cannot eliminate hazardous substances.

X: 表示该有害物质至少在该部件的某一均质材料中的含量超出 GB/T 26572 标准规定的限量要求。



标记 "X" 的部件, 皆因全球技术发展水平限制而无法实现有害物质的替代。

a. If applicable.

如果适用。

MARKING REQUIREMENTS

标注要求

Product 产品	Environmental protection use period (years) 环境保护使用期限 (年)	Logo 标志
This EXFO product 本 EXFO 产品	10	
Battery <sup>a</sup> 电池	5	

a. If applicable.  
如果适用。

P/N: 2.0.0.1

[www.EXFO.com](http://www.EXFO.com) · [info@EXFO.com](mailto:info@EXFO.com)

**CORPORATE HEADQUARTERS** 400 Godin Avenue

Quebec (Quebec) G1M 2K2 CANADA  
Tel.: 1 418 683-0211 · Fax: 1 418 683-2170

**TOLL-FREE** (USA and Canada)

1 800 663-3936

© 2022 EXFO Inc. All rights reserved.  
Printed in Canada (2022-11)

