

# IQS-12008

R&D AND MANUFACTURING – OPTICAL



## Ultra Fast IL, ORL and PDL Measurements as a Function of Wavelength

- Tunable laser covering 1260 nm to 1630 nm
- Innovative patented design permitting stitch-free continuous sweep\*
- Built for testing CWDM, PON (fiber-to-the-home) and broadband components
- Up to 32 channels
- High-speed autoranging detectors
- Three-year recommended calibration interval

\* US patent 7,382,810

# Component Characterization Over the Full Wavelength Range

## O, E, S, C, L and U—Spelling Out the Benefits

Low-water-peak fiber, CWDM, passive optical networks, FTTx and WDM are all key technologies in today's and, more importantly, tomorrow's metro and access fiber-optic networks. They all target low-cost solutions putting as much bandwidth potential as possible in the hands of service providers and their customers.

Such solutions exploit several or all of the singlemode wavelength bands available for transmission. Depending on the network architecture, components must be designed, qualified and manufactured to cover various combinations of O, E, S, C, L and U bands. In many cases, broadband components—for example switches, splitters and attenuators—are required to provide guaranteed performance across all the bands. Without an all-band test system, comprehensive characterization has been a painful exercise of integration, data stitching and measurement compromise.

## The Wait Is Over

EXFO's IQS-12008, an all-in-one component analyzer, uses a sweeping tunable laser source covering the 1260 to 1630 nm range to perform fast and accurate insertion loss (IL), optical return loss (ORL) and polarization-dependent loss (PDL) measurements as a function of wavelength.



EXFO's IQS-12008 All-Band Component Analyzer performs IL, ORL and PDL measurements over a wavelength range of nearly 400 nm, for up to 32 channels simultaneously.

## KEY FEATURES

- 1260 to 1630 nm wavelength coverage, ideal for testing PON, CWDM and other broadband components at any singlemode wavelength, as required by the new standards published by IEC, ITU and Telcordia organizations
- Measurement performance and modular flexibility suitable for research, qualification and manufacturing applications
- Fast scan (> 200 nm/sec) performed with autoranging multichannel detectors, significantly reducing measurement time
- Comprehensive analysis functions for assessing key parameters including bandwidth of CWDM passbands, central wavelength, ripple, isolation, polarization-dependent central wavelength (PDCW) and polarization-dependent bandwidth (PDBW)
- Compact: a complete IL, PDL and ORL system with 32 detectors, housed in a single IQS-510P mainframe
- Ideal for a wide range of passive devices and test applications, including:
  - CWDM multiplexers and demultiplexers
  - Broadband couplers
  - Isolators and circulators
  - FTTH/PON splitters
  - Fiber-optic switches and crossconnects
  - Hybrid components
  - WDM filters and triplexers
  - Raman components
  - Depolarizers
  - Spectral attenuation of fiber spans
  - Attenuators and attenuator arrays

## System overview

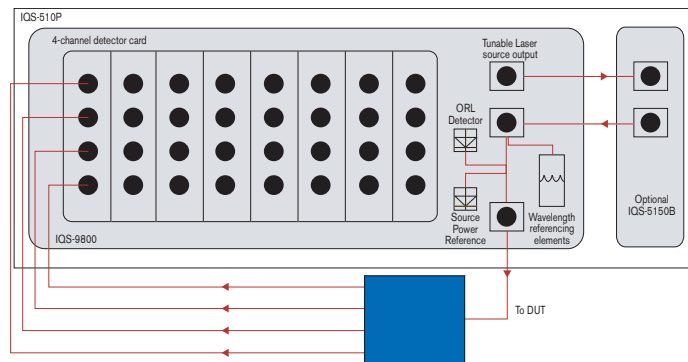

# IQS-12008: Standard and Optional System Elements

## IQS-510P Platform

As its controller platform, the IQS-12008 uses the IQS-510P mainframe, which houses a Pentium processor and 10 module slots—enough for a complete 32-channel IL, ORL and PDL test station. This very compact system can be operated as a benchtop unit or as part of a standard rackmount (4U, 19-inch).

IQS-500 platforms are based on standard industrial PC architecture, providing all the connectivity standards and tools required for easy integration into your test environment. This rugged hardware is readily adaptable to the most demanding optical T&M environments. An IQS-510E expansion unit can be connected to the main platform for applications requiring additional instruments (switches, DFB, attenuators, etc.).

## IQS-9800 All-Band Multichannel Loss Meter

Eight-slot module—the heart of the IQS-12008, incorporating the following subsystems:

- All-band tunable laser source (TUNABLE LASER)
- Wavelength and power reference
- Optical return loss measurement
- Source-detector synchronization
- Housing for detector cards



## DET-1800 Four-Detector Mini-Module

- Four high-speed (80 KHz) autoranging detectors
- Up to 32 channels (eight cards) can be simultaneously operated in the system
- Low polarization dependence (0.01 dB), for accurate PDL measurements
- Can be installed by user with a screwdriver

### Accessory

#### Bare-Fiber Testing Device

Use this very handy accessory for connecting bare-fiber components to the IQS-12008's detectors. Its unique gel-filled cartridge and multimode receiving fiber allow for low loss and repeatable connection on the detectors.

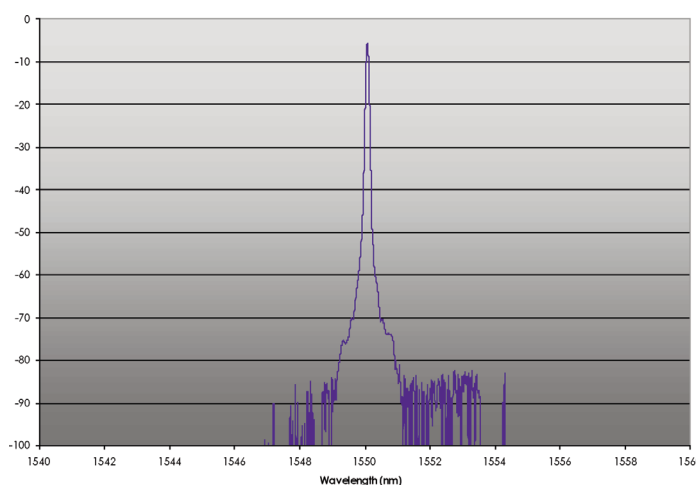

Tunable laser linewidth measured with an OSA at 1550 nm, demonstrating the very-low spontaneous source emission (SSE) level—key for accurately characterizing the isolation of wide passbands such as CWDMs.

## IQS-5150B All-Band Polarization State Adjuster (Optional)

- Two-slot module generating four orthogonal states of polarization
- Measures PDL using the Mueller Matrix method

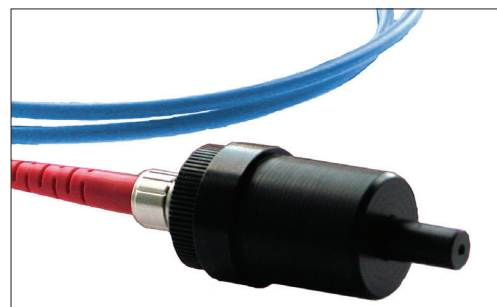

Bare-fiber components can easily be connected to the detectors, with low loss and excellent repeatability.

## Efficient, Trouble-Free Operation— the Key to Low Cost of Ownership

When selecting the most appropriate test solution, test engineers and managers need to justify both the technical and financial aspects of their recommendations. Their technical evaluation revolves around measurement specifications, ease of use, reliability, and how easy it is to integrate the solution into their everyday working environment. Other than the initial purchase, their financial evaluation should include other elements such as the number of systems needed, production throughput, testing time, number of operators required, setup time, training, as well as calibration and maintenance requirements.

EXFO's IQS-12008 All-Band Component Analyzer comes with built-in speed and performance, and, more importantly, numerous cost-saving features that ensure the lowest cost of ownership on the market—now and in the long term. This is achieved with a combination of efficient referencing and self-calibrating features.

**Wavelength self-calibration** ensures long-term wavelength accuracy of the tunable laser source, and consequently, of the entire system. Wavelength selection is performed by a tuning mechanism mounted on a precise, repeatable motor. Each time an IL or PDL reference is performed, the calibration offset is adjusted using a temperature-stabilized all-band Fabry-Perot interferometer and an acetylene gas cell.

**Calibration of all detectors wavelength responses** relative to the first channel allows the system to correct any variation in sensitivity and spectral response of the detectors. References then need only be performed on the first channel while they are calculated for the other channels, thus saving a considerable amount of time.

**Real-time source referencing** enables source power fluctuations to be compensated in real time. An internal detector, perfectly synchronized with the external detectors, measures the power from the source. This reference power is then used, along with the output coupler's calibrated coupling ratio, to perform accurate loss measurements.

**IL, ORL and PDL referencing** is managed within the system, ensuring the compensation of any loss or spectral non-uniformity of the launch fiber conditions. All reference measurements are performed quickly and accurately.

**Detector linearity calibration** ensures accurate IL, PDL and ORL measurements. No absolute power calibration is needed, because those measurements are relative. This minimizes initial costs and eliminates the often-redundant shipments to the factory for recalibration. EXFO recommends a three-year interval for linear calibration. The benefits of a 32-channel system can represent annual savings in the thousands of dollars, not including the cost associated to downtime.

**Fast sweep, multichannel approach.** When it comes to optimizing production efficiency, testing time is also critical. This is why EXFO chose the multichannel approach, which enables the simultaneous measurement of up to 32 channels, as well as a tunable laser cruising speed of > 200 nm/second, allowing an all-singlemode-band coverage in less than 2 seconds.

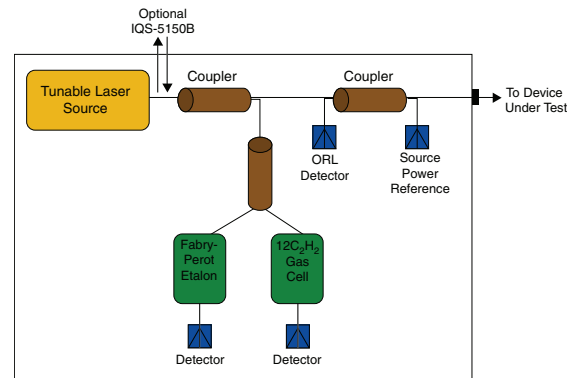

Diagram of the IQS-12008's power and wavelength-referencing elements. Real-time source referencing enables source power fluctuations to be compensated in real time.



Use the IQS-12008 compact system for efficient component characterization in your production environment.

# Component Characterization: Know Your Components Inside Out

## CWDM Testing

In one step, you can completely characterize a 4-, 8- or 16-channel CWDM over 360 nm. You can obtain IL and PDL traces, extract critical information on the device and even gather pass/fail results for:

- Central wavelength and central wavelength deviation from ITU grid
- User-defined “x-dB” bandwidth
- User-defined ITU passband
- Ripple in ITU passband
- IL and PDL in ITU passband
- Complete interchannel isolation table (crosstalk)
- Polarization-dependent central wavelength and bandwidth

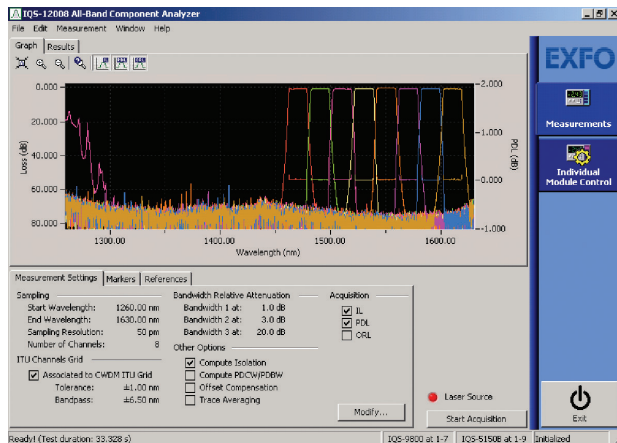

Performing frame analysis.

## FTTx Splitter Testing

Multichannel splitters are a challenge to test. With a 32-channel IQS-12008 All-Band Component Analyzer, you can test all 32 channels of a splitter simultaneously, and view a complete snapshot of the component's spectral response in all ranges used in FTTH networks.

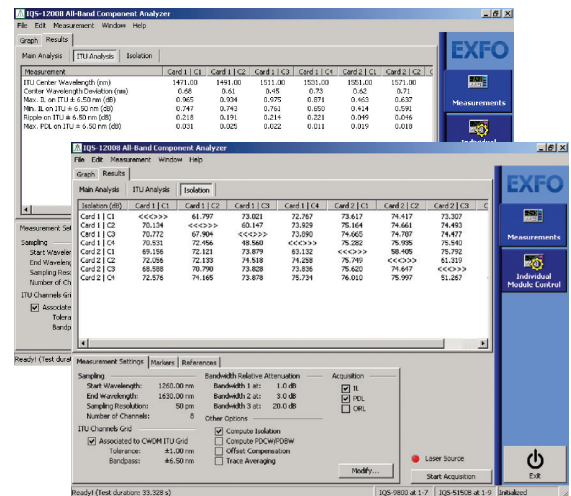

ITU analysis and isolation table complete the characterization of CWDMs.

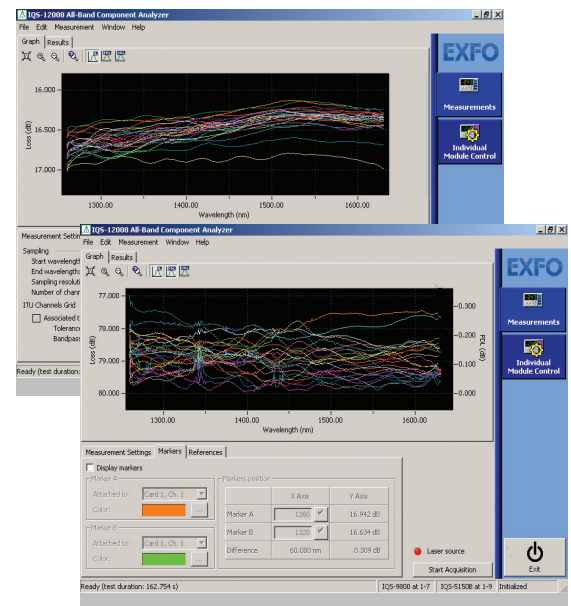

The IQS-12008 system can typically measure IL and PDL of a 1 x 32 splitter in 70 seconds. Top image shows IL traces; bottom image shows PDL.

# User-Friendly Software and Extensive Function Library, for Full Device Characterization

Performing fast and accurate IL, ORL and PDL measurements as a function of wavelength requires countless elements, including laser sweeping, synchronization, calibration and referencing, data acquisition and various calculations. The IQS-12008 user-friendly software interface performs all of these operations at the touch of a few buttons.

Results are available in both the tabular and graphical formats, and include basic loss data as well as advanced data analysis. They can be saved and exported into your data management system. The IQS-12008 comes with its own software called All-Band Sweep, an optimized program that provides efficient CWDM and FTTH component characterization.

## All-Band Sweep

In conjunction with the internal all-band tunable laser, the All-Band Sweep provides continuous per-channel loss data across the user-specified wavelength range. Automatic detection of device characteristics (passband, notch or other) and subsequent analysis (bandwidth, central wavelength, isolation, ripple, etc.) with pass/fail masks makes this application particularly well-suited for CWDM devices.

What's more, this software program is perfect for performing continuous spectral measurements on couplers, splitters and other devices for which assessing loss (IL, ORL, PDL) uniformity over a wide spectral range is important. It also lets you set the source at a specific wavelength and achieve instantaneous relative power readings on each detector—a key benefit for system troubleshooting or component alignment.

## Function Library

The system's application was developed using the IQS-12008 Function Library, a comprehensive set of DLL (COM) functions designed for rapid software development and test-system integration requirements. All IQS-12008 calibration, reference, measurement and calculation parameters are available through the fully documented methods, functions and properties of the library. These powerful, flexible, high-level functions will allow your programmers to be up and running with your customized all-band measurement software in a matter of days.

You can also quick-start your IL, ORL and PDL measurements using a LabVIEW demo program, provided with its source code.

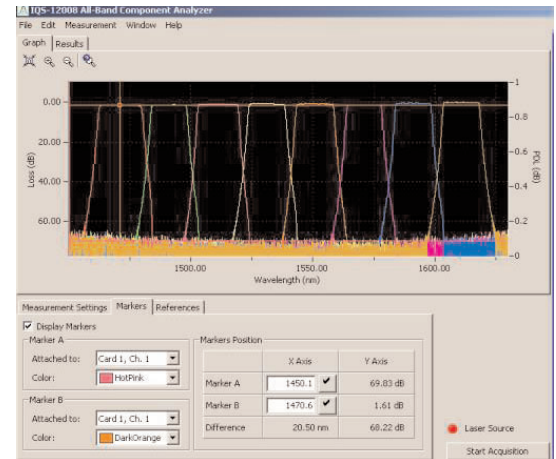

Spectral response for an eight-channel CWDM, showing better than 63 dB isolation (CWDM kindly provided by Finisar).

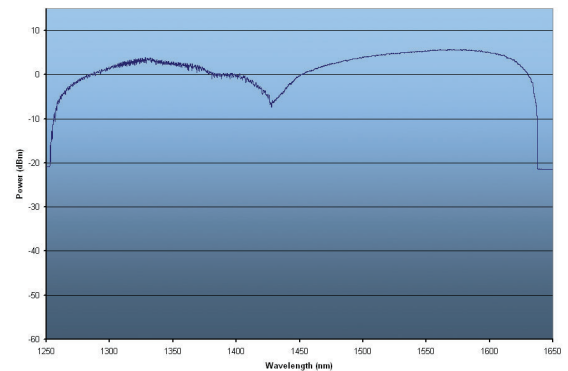

A typical all-band spectra for the tunable laser source, that is part of the IQS-12008.

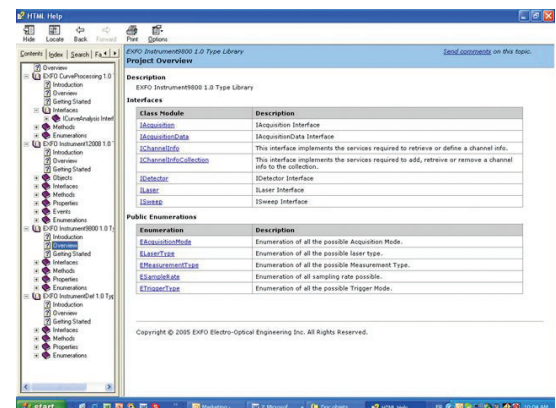

One of the menus provided in the on-line guide for programming with the IQS-12008.

## SPECIFICATIONS <sup>a</sup>

Source	Value
Wavelength range (nm) <sup>b</sup>	1260 – 1630
Wavelength uncertainty, sweep mode (pm) <sup>c</sup>	±22
Wavelength uncertainty static, typ. (pm) <sup>c</sup>	±22
Wavelength resolution, stepped mode (pm)	5
Wavelength repeatability, sweep mode, typ. (pm)	±6.5
Wavelength stability (pm/hour)	3
Linewidth FWHM, typ. (pm)	45
Output power (dBm)	At laser output connector: $0 < P_{max} < 9$ After referencing elements (before DUT): $-4 < P_{max} < 3$
Sweeping speed, typ. (nm/s)	220
<b>Detectors</b>	
Maximum input power (dBm)	3
<b>System</b>	
Insertion loss measurement range (dB), 1 scan	72 typ., 60 guaranteed
IL uncertainty (dB), typ. <sup>d</sup>	±0.02
IL uncertainty (dB) <sup>d</sup>	±0.05
IL repeatability (dB) <sup>d</sup>	±0.02
PDL uncertainty (dB), typ., for PDL < 0.5 dB; 1300 nm - 1630 nm <sup>e</sup>	±0.02
PDL uncertainty (dB), for PDL < 5 dB; 1300 nm - 1630 nm <sup>e</sup>	±(0.05 + 5 % of DUT's PDL)
PDL repeatability (dB), for PDL < 0.5 dB; 1300 nm - 1630 nm <sup>e</sup>	±0.009
ORL uncertainty (dB) <sup>f</sup>	±1
ORL range, typ. (dB)	63.5
Minimum wavelength sampling resolution (pm)	25
Measurement time, typ., IL only, 8 channels, 1260 - 1630 nm (s)	8
Measurement time, typ., IL & PDL, 8 channels, 1260 - 1630 nm (s)	40
Measurement time, typ., IL & PDL, 32 channels, 1260 - 1630 nm (s)	70
Maximum number of channels	32
Recommended calibration interval	3 years

## GENERAL SPECIFICATIONS

<b>IQS-9800 module</b>		
Size (H x W x D)	125 mm x 303 mm x 282 mm	4 15/16 in x 11 15/16 in x 11 1/8 in
Weight	4.7 kg	10.3 lb
<b>IQS-5150B module</b>		
Size (H x W x D)	125 mm x 74 mm x 282 mm	4 15/16 in x 2 15/16 in x 11 1/8 in
Weight	2.0 kg	4.4 lb
<b>DET-1843 mini-module</b>		
Size (H x W x D)	116 mm x 30 mm x 131 mm	4 9/16 in x 1 3/16 in x 5 3/16 in
Weight	0.12 kg	0.26 lb
<b>IQS-12008 system</b>		
Temperature		
operating	10 °C to 40 °C	50 °F to 104 °F
storage	-20 °C to 50 °C	-4 °F to 122 °F
Relative humidity (%)	80 % maximum (non-condensing) at 40 °C	

## STANDARD ACCESSORIES

User guide, interconnecting patchcords (one polarization maintaining patchcord, one ORL reference test jumper; when optional IQS-5150B module is selected, one rigid test jumper is provided).

## NOTES

- Specifications are valid at 23 °C ± 1 °C, for resolution set to 50 pm, after a warm-up time of 1 hour, and for a wavelength range of 1260 nm to 1630 nm, unless specifically noted otherwise.
- Some measurements may be possible on the 1250 nm to 1650 nm range.
- After wavelength self-calibration with atmospheric pressure entered by user in the measurement settings.  
For "02" option, which does not include acetylene gas cell, the wavelength uncertainty in sweep mode is ±42 pm; in static mode, wavelength uncertainty is typically ±22 pm.
- For IL < 20 dB, including repeatability of FOA, not including connector uncertainty.
- With four-scan averaging on detector response and reference trace.
- For ORL values between 10 dB and 48 dB.

## ORDERING INFORMATION

### IQS-12008-XX-XX-XX-XX-XX-XX

#### Model ■

IQS-12008-00 = IQS-12008 system, without internal tunable laser source, with one four-channel DET-1843  
 IQS-12008-02 = IQS-12008 system, with O- and E-band tunable laser source (1260 nm to 1430 nm), with one four-channel DET-1843  
 IQS-12008-03 = IQS-12008 system, with S-, C-, L- and U-band tunable laser source (1440 nm to 1630 nm), with one four-channel DET-1843  
 IQS-12008-23 = IQS-12008 system, with O-, E-, S-, C-, L- and U-band tunable laser source (1260 nm to 1630 nm), with one four-channel DET-1843

#### GPIB option ■

00 = Without GPIB card  
 I3 = With GPIB card

#### Polarization option ■

00 = Without polarization option  
 A = All-band polarization-state adjuster; includes one IQS-5150B-xx module, interconnecting rigid patchcord and calculation software (Mueller Matrix)

#### Channel count ■

04 = 4 channels; includes one DET-1843 Four-Detector Mini-Module  
 08 = 8 channels; includes two DET-1843 Four-Detector Mini-Modules  
 12 = 12 channels; include three DET-1843 Four-Detector Mini-Modules  
 16 = 16 channels; includes four DET-1843 Four-Detector Mini-Modules  
 20 = 20 channels; includes five DET-1843 Four-Detector Mini-Modules  
 24 = 24 channels; includes six DET-1843 Four-Detector Mini-Modules  
 28 = 28 channels; includes seven DET-1843 Four-Detector Mini-Modules  
 32 = 32 channels; includes eight DET-1843 Four-Detector Mini-Modules

#### Connector ■

EA-EUI-28 = APC/DIN 47256  
 EA-EUI-89 = APC/FC narrow key  
 EA-EUI-91 = APC/SC  
 EA-EUI-95 = APC/E-2000

#### Connector adaptor ■

FOA-316 = Ultra-low-reflection SMA 906  
 FOA-322 = Ultra-low-reflection NTT-FC  
 FOA-328 = Ultra-low-reflection DIN 2.5 (LSA)  
 FOA-332 = Ultra-low-reflection AT&T ST  
 FOA-340 = Ultra-low-reflection HMS-0, HFS-3  
 FOA-354 = Ultra-low-reflection SC  
 FOA-376 = Ultra-low-reflection HMS-10/AG  
 FOA-384 = Ultra-low-reflection Diamond HMS-10, HFS-13  
 FOA-396 = Ultra-low-reflection E2000  
 FOA-397 = Ultra-low-reflection LX.5  
 FOA-398 = Ultra-low-reflection LC  
 FOA-399 = Ultra-low-reflection MU

Example: IQS-12008-23-I3-A-08-EA-EUI-89-FOA-322

#### NOTES

- a. The GPIB card can be used to control other test instruments. The IQS-12008 cannot be controlled externally via GPIB.
- The IQS-9800 All-Band Multichannel Loss Meter can be purchased separately (if you already own an IQS-510P platform).
  - The DET-1843 Four-Detector Mini-Module can be purchased separately to add channels to an existing system.

## SAFETY

21 CFR 1040.10 and IEC 60825-1 A2 2001:  
 Class 1M LASER PRODUCT

EXFO Corporate Headquarters > 400 Godin Avenue, Quebec City (Quebec) G1M 2K2 CANADA | Tel.: 1 418 683-0211 | Fax: 1 418 683-2170 | info@EXFO.com

Toll-free: 1 800 663-3936 (USA and Canada) | www.EXFO.com

<b>EXFO America</b>	3701 Plano Parkway, Suite 160 Plano, TX 75075 USA	Tel.: 1 800 663-3936	Fax: 1 972 836-0164
<b>EXFO Europe</b>	Omega Enterprise Park, Electron Way Chandlers Ford, Hampshire S053 4SE ENGLAND	Tel.: +44 2380 246810	Fax: +44 2380 246801
<b>EXFO Asia</b>	151 Chin Swee Road, #03-29 Manhattan House SINGAPORE 169876	Tel.: +65 6333 8241	Fax: +65 6333 8242
<b>EXFO China</b>	No. 88 Fuhua, First Road, Central Tower, Room 801 Futian District Shenzhen 518048, CHINA	Tel.: +86 (755) 8203 2300	Fax: +86 (755) 8203 2306
	Beijing New Century Hotel Office Tower, Room 1754-1755 No. 6 Southern Capital Gym Road Beijing 100044 P. R. CHINA	Tel.: +86 (10) 6849 2738	Fax: +86 (10) 6849 2662

EXFO is certified ISO 9001 and attests to the quality of these products. This device complies with Part 15 of the FCC Rules. Operation is subject to the following two conditions: (1) this device may not cause harmful interference, and (2) this device must accept any interference received, including interference that may cause undesired operation. EXFO has made every effort to ensure that the information contained in this specification sheet is accurate. However, we accept no responsibility for any errors or omissions, and we reserve the right to modify design, characteristics and products at any time without obligation. Units of measurement in this document conform to SI standards and practices. In addition, all of EXFO's manufactured products are compliant with the European Union's WEEE directive. For more information, please visit [www.EXFO.com/recycle](http://www.EXFO.com/recycle). Contact EXFO for prices and availability or to obtain the phone number of your local EXFO distributor.

For the most recent version of this spec sheet, please go to the EXFO website at <http://www.EXFO.com/specs>  
 In case of discrepancy, the Web version takes precedence over any printed literature.