

AXS-200/635

Copper, VDSL2, ADSL2+, and IP
Triple-Play Test Set



Copyright © 2008–2009 EXFO Electro-Optical Engineering Inc. All rights reserved. No part of this publication may be reproduced, stored in a retrieval system or transmitted in any form, be it electronically, mechanically, or by any other means such as photocopying, recording or otherwise, without the prior written permission of EXFO Electro-Optical Engineering Inc. (EXFO).

Information provided by EXFO is believed to be accurate and reliable. However, no responsibility is assumed by EXFO for its use nor for any infringements of patents or other rights of third parties that may result from its use. No license is granted by implication or otherwise under any patent rights of EXFO.

EXFO's Commerce And Government Entities (CAGE) code under the North Atlantic Treaty Organization (NATO) is 0L8C3.

The information contained in this publication is subject to change without notice.

Trademarks

EXFO's trademarks have been identified as such. However, the presence or absence of such identification does not affect the legal status of any trademark.

Units of Measurement

Units of measurement in this publication conform to SI standards and practices.

Version number: 4.0.0

Contents

Certification Information	vi
1 Introducing the Copper, VDSL2, ADSL2+, and IP Triple-Play Test Set	1
Main Features	1
Cable Connections	3
LED Indicators	4
Electrical Safety Information	4
ADSL2+ Basic Principles	5
VDSL2	5
Navigating through the AXS-200/635	6
Conventions	7
2 Getting Started with Copper Qualification Tests	9
POTS Dialing	9
Regional Settings	12
Saving Results	19
Reading Saved Results	22
3 Auto CQ/Video-DSL Rate Prediction	25
CQ Auto Test	25
Configuring CQ Auto Tests	26
Running CQ Auto Tests and Viewing Results	37
Video-DSL Rate Prediction	45
Configuring Video-DSL Rate Prediction	45
Running Video-DSL Rate Prediction Tests and Viewing Results	51
4 POTS Auto Test	63
5 DMM Tests	65
DMM	65
In Service Pair Detection Test	74
Rectified Loop (Corrosion) Detection Test	75
Water Detection Test	75
Resistive Balance	76

Contents

6 VF Tests	79
Receive Tone (RX)	80
Send Tone (TX)	81
Tracing Tone	82
VF Noise	83
Impulse Noise	84
Power Influence	86
Longitudinal Balance	87
Load Coil Detection	87
7 Fault Location Tests	89
TDR Test	89
RFL Single Pair (2 wire) Test	92
RFL Separate Good Pair (4 wire) Test	95
Loop Mapper Test	98
8 Wideband Tests	103
Receive Tone (RX)	104
Send Tone (TX)	105
PSD Noise	106
Spectral Detective Test	110
Impulse Noise Test	113
Impulse Noise Histogram	115
Attenuation Test	118
Longitudinal Balance	120
Data Rate Prediction	122
9 Getting Started with DSL and Ethernet Testing	131
DSL/IP Tests	131
10 Connection Setup for DSL/IP Triple-Play Verification Tests	133
Setup Profile	133
Setup Line Connection	137
11 Configure Tests for DSL/IP Triple-Play Verification	149
Configure Profile	150
Configure DSL/IP Tests	151
12 Running CPE Tests	163
Reading Results	163
Saving Results	179

13 IPTV Analysis	181
Reading Results	181
Saving Results	203
14 Data Analysis	205
Reading Results	205
Saving Results	219
15 Running a VoIP Test	221
Reading Results	221
Saving Results	234
16 Maintenance	237
General Maintenance	237
Battery Charging and Replacing	237
Recycling and Disposal (Applies to European Union Only)	238
17 Troubleshooting	239
Solving Common Problems	239
Contacting the Technical Support Group	240
Transportation	241
18 Warranty	243
General Information	243
Liability	244
Exclusions	244
Certification	244
Service and Repairs	245
EXFO Service Centers Worldwide	246
A Technical Specifications	247
Index	253

Certification Information

F.C.C. Information

Electronic test equipment is exempt from Part 15 compliance (FCC) in the United States. However, compliance verification tests are systematically performed on most EXFO equipment.

CE Information

Electronic test equipment is subject to the EMC Directive in the European Union. The EN61326 standard prescribes both emission and immunity requirements for laboratory, measurement, and control equipment. This unit has undergone extensive testing according to the European Union Directive and Standards.

CSA Information

This unit is certified by the CSA (certificate number 162451) and was evaluated according to applicable CSA and UL standards (as confirmed by “C-US” mark) as well as applicable IEC standards for use in Canada, the United States, and other countries.

EXFO **CE** **DECLARATION OF CONFORMITY**

Application of Council Directive(s): 2006/95/EC - The Low Voltage Directive
2004/108/EC - The EMC Directive
And their amendments

Manufacturer's Name: EXFO Electro-Optical Engineering Inc.
Manufacturer's Address: 400 Godin Avenue
Quebec, Quebec
Canada, G1M 2K2
(418) 683-0211

Equipment Type/Environment: Test & Measurement / Industrial
Trade Name/Model No.: AXS-200/635
Copper, VDSL2, ADSL2+ and IP Triple-Play
Test Set

Standard(s) to which Conformity is Declared:

EN 61010-1:2001 Safety Requirements for Electrical Equipment for Measurement, Control, and Laboratory Use, Part 1: General Requirements.

EN 61326-1:2006 Electrical Equipment for Measurement, Control and Laboratory Use - EMC Requirements – Part 1: General requirements

EN 55022: 1998 +A2: 2003 Information technology equipment - Radio disturbance characteristics - Limits and methods of measurement

I, the undersigned, hereby declare that the equipment specified above conforms to the above Directive and Standards.

Manufacturer

Signature:



Full Name: Stephen Bull, E, Eng
Position: Vice-President Research and Development
Address: 400 Godin Avenue, Quebec (Quebec),
Canada, G1M 2K2
Date: November 04, 2008

1 ***Introducing the Copper, VDSL2, ADSL2+, and IP Triple-Play Test Set***

The AXS-200/635 Copper, VDSL2, ADSL2+, and IP Triple-Play Test Set is a handheld unit that integrates the functionalities of the AXS-200/610 30 MHz Copper Test Set and the AXS-200/630 VDSL2, ADSL2+ and IP Triple-Play Test Set. The AXS-200/635 allows you to qualify and troubleshoot the copper-loop plant and triple-play services from top to bottom by using pass/fail-driven automated functionalities with one consolidated test set.

In addition to validating connectivity to the DSLAM, the AXS-200/635 provides upstream and downstream parameters such as actual data rates, attenuation and noise margin. It delivers advanced IPTV measurements: packet jitter, packet loss, PCR jitter, MDI, PID viewer, and IGMP zap time; both in Terminate (stand-alone) and Through mode operation. The AXS-200/635 also monitors residential VoIP call flow and statistics, facilitating VoIP QoS assurance.

Main Features

- Clear Auto Test results with user-definable pass/fail criteria.
- VDSL2, ADSL2+ and 10/100 Ethernet tests in a single unit.
- Key IPTV qualification parameters with features such as set-top box (STB) emulation, join/leave requests, PCR jitter analysis and MDI reporting.
- Superior network testing such as ping and traceroute measurements as well as HTTP and FTP speed testing.
- 30-MHz spectrum analysis for single-ended VDSL2 pre qualification and deployments; backward-compatible to ADSL2+
- Verification of traditional voiceband circuits
- Spectral detective with auto identification of disturbers
- Single-ended testing – no remote device required

Introducing the Copper, VDSL2, ADSL2+, and IP Triple-Play Test Set

Main Features

- LoopMapper – graphical loop depiction
- Color display with graphical analysis
- POTS and VF measurements for complete ADSL2+ and VDSL2 loop qualification
- Data rate prediction
- Analog IPTV auto test
- In-service pair, rectified loop, and water detection tests

Typical Applications

The AXS-200/635 allows you to test outside the customer premises over VDSL2, ADSL1/2/2+ or inside over Ethernet. Both modes allow you to use the Copper, VDSL2, ADSL2+, and IP Triple-Play Test Set for several applications, such as:

- IPTV analysis
- Data analysis
- VoIP analysis
- CPE tests
- Auto tests

In addition, the unit can be configured to run a series of copper qualification tests to see if the cable is suitable for carrying digital subscriber line (DSL) technologies such as:

- POTS auto test
- DMM tests
- VF tests
- Fault location tests
- Wideband tests

Cable Connections

The graphic below shows the connectors on the AXS-200/635 device.

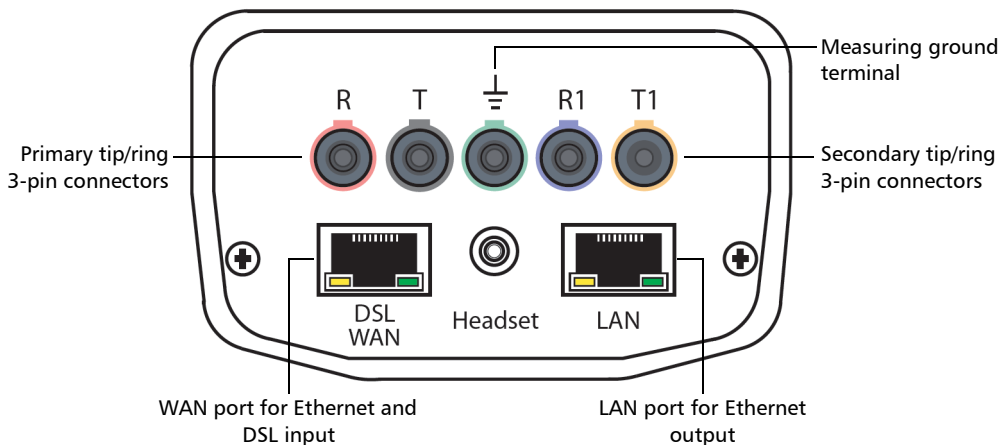

Note: When connecting a DSL cable to the WAN port, use the RJ-45 plug end of the 26AWG cable provided with the unit. There is a 1500V maximum transient voltage on telecom ports. Basic insulation is needed for external telecom circuits.

LED Indicators

The graphic below illustrates the LED indicators across the top front of the AXS-200/635 unit.

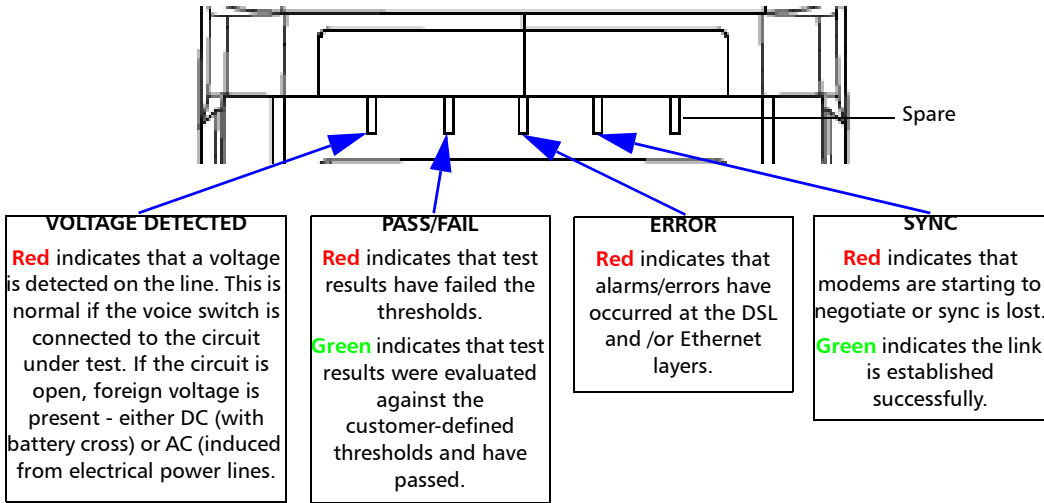

Electrical Safety Information

Do not use the unit outdoors in wet locations. For information about equipment rating for temperature, environment, and power supply, refer to the *Safety Information* chapter of the AXS-200 User Guide.

ADSL2+ Basic Principles

ADSL2+ based testing requires an ATU-C (ADSL Transceiver Unit - Central Office) that resides in a DSLAM (Digital Subscriber Line Access Multiplexer) in the Central Office/Local Exchange. At the customer premises, there is an ATU-R (ADSL Transceiver Unit - Remote) that interfaces with a user's PC.

The Copper, VDSL2, ADSL2+, and IP Triple-Play Test Set allows you to emulate the ATU-R (customer's ADSL modem). Once a connection is established with the ATU-C in the DSLAM at the service provider's central office or remote DLC, the AXS-200/635 displays the connection rates for the upstream and downstream directions of the ADSL2+ link.

VDSL2

Very high speed digital subscriber lines (VDSL) is a standard that allows extremely high speed internet access over existing copper cables. The VDSL2 standard increases the spectrum allocation up to 30 MHz for even higher performance than its predecessor VDSL1, and allows speeds up to 100 Mbps symmetrical (both up and downstream). VDSL2 also calls for support of applications such as multi-channel high definition TV (HDTV), video on demand, video-conferencing, and VoIP using the existing copper telephone line infrastructure. Along with that, it also calls for ATM, Ethernet, and IP compatibility, as well as multimode implementations to permit interoperability with existing ADSL equipment.

VDSL2 gives carriers the flexibility to start rapidly deploying VDSL2 networks and offer new broadband services including triple-play services - HDTV, VoD, high-speed data, VoIP, high-speed Internet access, video conferencing, virtual private networks (VPNs), PBX Extension, and video surveillance - to compete with cable companies. VDSL2's broader spectrum combined with features like Trellis coding and multi-pair bonding allows carriers to offer full triple-play services to a large portion of their customer base.

Navigating through the AXS-200/635



Use the following general instructions to navigate through the AXS-200/635 menus and panes:

- To navigate through the menu items use the arrow keys.
- To confirm a choice or open a menu item press .
- Most manual tests automatically run when they are selected from the menu.
- The rotating hour glass in the title bar indicates when a test is running.

Note: *The unit checks for an active circuit at the beginning of every manual and auto test.*

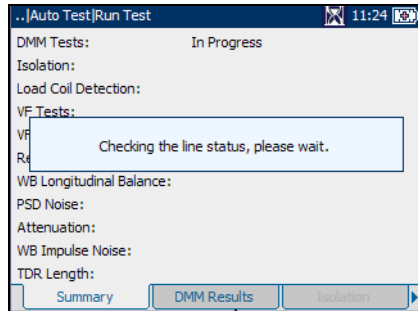
- To start/stop a test, press .
- To view the contents of the panes or tabs, use the F1, F2, and F3 keys. To view any available additional tabs use the function arrow keys on either side of the F1 and F3 keys.



- To cancel an action or return to the previous item or pane, press .
- To return to the home pane, press .

Conventions

Before using the product described in this manual, you should understand the following conventions:



WARNING

Indicates a potentially hazardous situation which, if not avoided, could result in *death or serious injury*. Do not proceed unless you understand and meet the required conditions.



CAUTION

Indicates a potentially hazardous situation which, if not avoided, may result in *minor or moderate injury*. Do not proceed unless you understand and meet the required conditions.



CAUTION

Indicates a potentially hazardous situation which, if not avoided, may result in *component damage*. Do not proceed unless you understand and meet the required conditions.



IMPORTANT

Refers to information about this product you should not overlook.

2 Getting Started with Copper Qualification Tests

The AXS-200/635 is designed to test basic twisted pair quality, identify and locate faults, perform advanced single-ended loop tests, and troubleshoot noise and signal issues all the way up to 30 MHz in support of the VDSL2 standard. These measurements offer a quick and thorough method to determine if the cable is capable of supporting xDSL technology. In addition, it utilizes noise measurements, longitudinal balance tests, and power spectral density tests to assist in the installation, maintenance, and troubleshooting of copper cables.

To access copper qualification tests:

1. From the **Home** pane use the up/down arrow keys to highlight **Copper Qualification Tests**, then press ✓.
2. From the **Copper Qualification Tests** pane highlight the desired menu item, and press ✓.

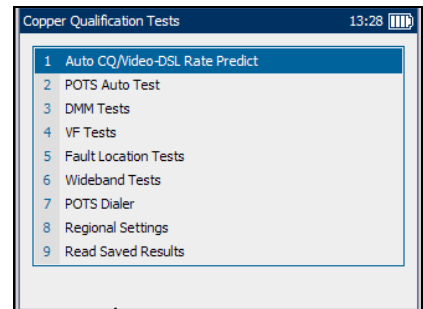

POTS Dialing

The **POTS Dialer** function provides a dial-up path from the AXS-200/635 to another tester (or quiet termination or silent switchman) through a switched circuit network. DTMF transmission is enabled via the AXS-200 keypad allowing you to place and receive POTS calls. The dialer can be accessed from the **Copper Qualification Tests** pane and is also integrated into individual test screens to give you quick access to the manual dialer function, speed dial and last dialed lists, without exiting the current test application.

Getting Started with Copper Qualification Tests

POTS Dialing

POTS Dialer

The **POTS Dialer** menu item/tab allows you to use the unit as a telephone (with a headset) and the AXS-200 keypad as a dialer keypad when the **POTS Dialer** is invoked, whether in the test results screens or through the separate dedicated **POTS Dialer** application.

Each parameter and button are described below:

- **NumbertoDial** edit box is the phone number you wish to dial. You can add this number to the **Phone Book** by pressing the **Add to Phone Book** button.
- **Dial** button is enabled whether or not there is a number present in the **NumbertoDial** edit box. If a number is present, it will be dialed.

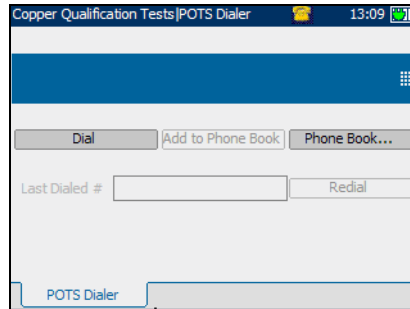

If not, pressing the **Dial** button will cause the unit to go off hook and a new *placing a call* pane appears where you can manually dial a number from the keypad.

- **Dial Status** displays the progress of dialing such as **Dial Tone Detected**, **No Dial Tone**, or **Busy Tone Detected**.
- **Volume** is used to set the headset volume to **LOW** or **HIGH**.
- **Hang Up** button terminates the call and you'll be returned to the **POTS Dialer** pane.

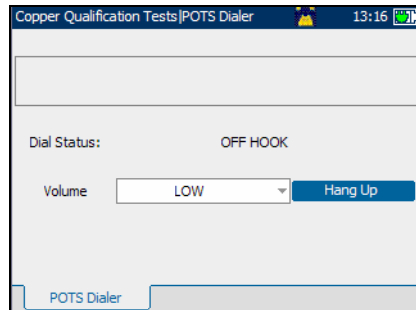

- **Add to Phone Book** button enters the number dialed into the **Phone Book** by bringing up the *edit screen* where you can add the **Name** for the **Number** dialed and save it. After pressing either the **Cancel** or **Update** buttons, you'll be returned to the **POTS Dialer** pane.

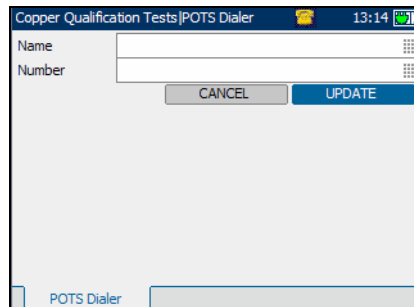

- **Phone Book** button invokes the list of numbers to dial and supports 15 commonly called names and numbers. Names can be up to 30 characters long and numbers up to 32 digits.
- **Last Dialed #** lists up to 30 last dialed numbers.
- **Redial** button dials a selected phone number from the **Last Dialed #** list.
- Icon on title bar gives a live on-screen, graphical indication of on-hook and off-hook status.

To select parameter values:

1. Press the up/down arrow keys to highlight the desired parameter.
2. Press ✓ to display the list or select the value.
3. Press the up/down arrow keys to highlight the desired value.
OR
4. Press the left arrow key to erase the existing value, and then use the alphanumeric keypad to enter a value. To cancel the entry, press ↩.
5. Press ✓ to accept the value.

Regional Settings

Before performing copper qualification tests, set up the software settings and values for the cables. The AXS-200/635 allows you to save standard parameter settings to different profiles and reuse them as needed.

Select Profile

The **Select Profile** tab allows you to configure the unit with specific measurement values.

Each parameter is described below:

- **Distance Units** are the units of measurement for distances in **FEET** or **METER**.
- **Cable Gauge** is the gauge system for measuring wire sizes in **AWG** (American Wire Gauge) units or **mm** (metric wire size).
- **Profile Name** is either **Default** or a list of all available profile file names stored in the current directory.
- **Clone Profile** allows you to copy an existing profile to a new one and switch to use the new profile.

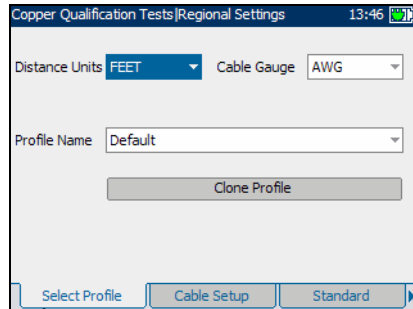

To select the parameter values:

1. Press the up/down arrow keys to highlight the desired parameter.
2. Press **✓** to display the list.
3. Use the up/down arrow keys to highlight the desired value, and press **✓** to accept the value.

When you change the selections and press  or , the following actions should be performed:

1. If **ProfileName** selection is not **Default** then save modifications (if any) into the current profile file and proceed with the selected action.
2. If **ProfileName** selection is **Default** and modification to the profile has been made then enter the new name of the profile.

At power up, all settings are read from the last current profile.

- **Enter Profile Name** is the new name of the profile.

To save modifications made to a CustomProfile:

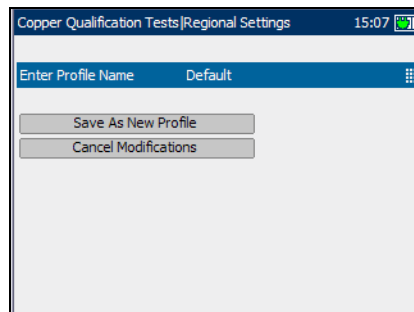

1. Select **Save as New Profile** and create and save a new **CustomProfile** name in the current directory.
2. If the file with **CustomProfile** name already exists in the current directory, you will be prompted to overwrite it.



IMPORTANT

Changes to test parameters will be lost if the unit is turned off without first saving them to a default or custom profile. The unit can also be left in suspend mode to avoid loss of test parameters.

To cancel modifications made to a CustomProfile:

1. Select **Cancel Modifications** and reload the current profile with the default profile.
2. Proceed with the previously selected action (, , ).

Cable Setup

The **Cable Setup** tab allows you to configure parameter values for the cable.

Each parameter and button is described below:

- **Cable Type** defines the gauge of the cable in use. If wire gauge is measured in American Wire Gauge (AWG) units, the available choices are: **AUTO**, **19 AWG**, **22 AWG**, **24 AWG**, or **26 AWG**. For mm gauge wire, the available choices are: **AUTO**, **0.32 mm**, **0.40 mm**, **0.50 mm**, **0.60 mm**, **0.65 mm**, **0.80 mm**, **0.90 mm**, or **1.20 mm**.
- **Cable Fill** allows you to select the type of material the cable can be filled with. Changing the selection to **AIRCORE**, **JELLY**, **PULP**, **5 PR**, or **2 PR** influences the cable capacitance per length, automatically updating the **Cap. T/R-GND** field.
- **Capacitance T-R (nF/km or nF/mi)** allows you to specify a value for the capacitance per length constant.
- **Cap. T/R-GND (nF/km or nF/mi)** allows you to specify a value for the capacitance per length to ground constant.
- **Resistance (Ohm/km or Ohm/mi)** allows you specify a value for the resistance constant of the cable.
- **Attenuation (dB/km or dB/mi)** allows you to specify a value for the reduction in signal strength or insertion loss of the cable.
- **VOP** allows you to set the velocity of propagation for the cable as a ratio of the speed of light. Enter a value between **0.400** and **0.999**.
- **Restore Defaults** allows you to reset cable parameters for the selected cable to the standard default values.

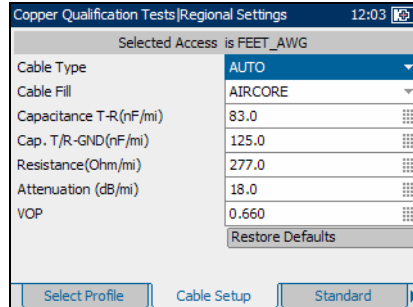

To select parameter values:

1. Press the up/down arrow keys to highlight the desired parameter.
2. Press ✓ to display the list or select the value.
3. Press the up/down arrow keys to highlight the desired value.

OR

4. Press the left arrow key to erase the existing value, and then use the alphanumeric keypad to enter a value. To cancel the entry, press ↵.
5. Press ✓ to accept the value.

To reset default cable values:

1. Press the up/down arrow keys to highlight **Cable Type**.
2. Press ✓ to display the list.
3. Press the up/down arrow keys to highlight the desired cable type, then press ✓ to accept the selection.
4. Use the up/down arrow keys to highlight the **Restore Defaults** button, then press ✓. The selected cable's default values are restored.

Getting Started with Copper Qualification Tests

Regional Settings

Standard

The **Standard** tab allows you to set unit parameter values for the selected profile composed of current **Distance Units** and **Cable Gauge**.

- **Standard** allows you to specify if the copper qualification tests should conform to the **ITU** (International Telecommunications) or **ANSI** (American National Standards Institute) standard.
- **Temperature** allows you to specify the units of measurement for temperature in **F** (Fahrenheit) or **C** (Celsius).
- **Connection** allows you to specify the default type of cable connections as **T-R-G** or **A-B-E**.

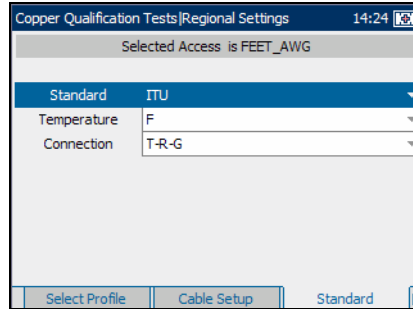

To select the parameter values:

1. Press the up/down arrow keys to highlight the desired parameter.
2. Press ✓ to display the list.
3. Use the up/down arrow keys to highlight the desired value, and press ✓ to accept the value.

Phone Book

The **Phone Book** tab provides you with a list of saved names and numbers that will be part of the **Profile**.

Each parameter and button is described below:

- **Name** displays the list box of names in a phone book list.
- **Number** displays the list box of phone numbers in a phone book list.
- List Box can display up to 15 names/numbers. Once the list box reaches 15 entries the **New** button will be disabled. The phone book has 3 predefined entries: **Milliwatt Line**, **Drop Battery** and **Quiet Line**. These entries can be edited but not removed.

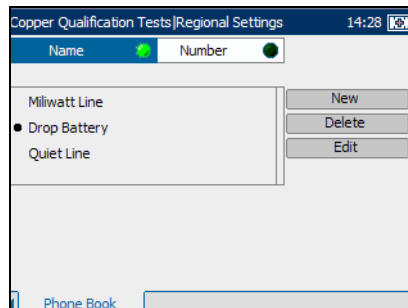

To select a name/number from the current list:

1. Press the up/down arrow keys to highlight the desired parameter.
2. Press  to select the item.

This selection can be edited or removed. Once you leave this screen, the selected name/number will be used to dial. All changes are automatically saved into phone book.

- **New** invokes the edit screen where a new name and number can be entered then saved to the phone book list.
- **Edit** invokes the edit screen where a name and number can be viewed or changed.
- **Delete** removes the selected entry from the phone book list.

Getting Started with Copper Qualification Tests

Regional Settings

On the *edit details* screen, the following controls are shown:

- **Name** is the name, maximum 30 characters, assigned to the phone number entered in the phone book.
- **Number** is the phone number, maximum 32 digits including #,* and comma.
- **Cancel** button returns you to the phone book screen without saving any changes.
- **Update** button stores the **Name** and **Number** entered, in the phone book.

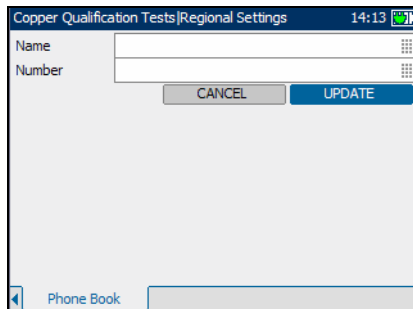

To select and edit the controls:

1. Press the up/down arrow keys to highlight the desired entry and press ✓.
2. Use the alphanumeric keypad to enter a value. To cancel the entry, press ↶.
3. Press ✓ to accept the value.

Saving Results

You can save any of your results after running and viewing a test performed with the AXS-200/635, in either text or graphical format. Each copper qualification test includes a **Save Results** tab to do so.

Press the F1, F2, or F3 key to view this tab, or use the function arrow keys on either side of the F1 and F3 keys to access it.

Save Results

The **Save Results** tab allows you to save your test results to a file or to an HTML report.

Each entry on the pane is described as follows:

- **Save as Type** lists the following formats to save your test results:
 - **AXS200 format** is a binary file format with ext *.dat. This format can be opened only on an AXS200 unit. The **Available Graphs** list box will be unavailable in this case.
 - ***.csv** saves only graphical results. Textual results must be formatted as a comma-separated values table for easy importation to Excel. Results are saved to a USB.
 - ***.gif** stands for graphics interchange format and is one of the most common file formats for graphic images on the World Wide Web. Results are saved to a USB.
 - ***.bmp** saves graphical results in a bitmap file format. Results are saved to a USB.
 - ***.xml** saves your data in a common language format to share on the Web.

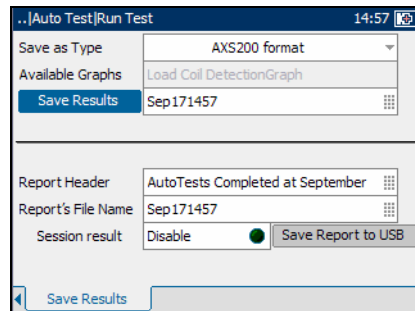

Getting Started with Copper Qualification Tests

Saving Results

- **Available Graphs** is enabled only if the selected format under **Save as Type** is ***.gif**, ***.csv**, or ***.bmp**. The selection of graphs available are: **Load Coil Detection**, **VF Power Influence**, **PSD Noise**, **WB Spectral Detective**, **WB Impulse Noise Histogram**, **Attenuation**, **WB Long. Balance**, **Loop Mapper**, **TDR**, and **Auto Test**. For a test that does not have a graph, this list box is unavailable.
- **Save Results** button saves the test results in internal or external memory (depending on the **Save as Type** format).
- **Filename** is the current date and time stamp plus you can enter any name. If it already exists, you will be prompted to overwrite the existing file.
- **Report Header** is where you can enter any comment. The initial value is the current test followed by the date and time stamp.
- **Report's File Name** is where you can enter any name for the HTML filename. If the name already exists, you will be prompted to overwrite the existing file. The default extension is **.html**.
The default name is generated from the current time.
- **Session result** creates and saves the report for single test results when disabled, or appends multiple results in one report when enabled.
- **Save Report to USB** button saves the results to an HTML report. If a USB memory stick is not inserted, the following warning dialogue box appears: **USB device is not detected**.
- **Append to Report** button appears only if **Session result** is **Enable**, and creates an HTML report for the current test in internal memory.

To set parameter values and save results:

1. Press the left/right and up/down arrow keys to highlight the desired parameter.
2. Press ✓ to display the list or select the value.
3. Press the up/down arrow key to highlight the desired value.

OR

4. Press the left arrow key to erase the existing value, and then use the alphanumeric keypad to enter a value. To cancel the entry, press ↩.
5. Press ✓ to accept the value.

Getting Started with Copper Qualification Tests

Reading Saved Results

Reading Saved Results

You can view any of your saved results with the Copper, VDSL2, ADSL2+, and IP Triple-Play Test Set, by highlighting the **Read Saved Results** menu item from the **Copper Qualification Tests** pane, and pressing ✓.

Read Saved Results

The **Read Saved Results** tab allows you to select a test type and view the results of all the files previously saved.

Select Test Type provides a list of all the copper qualification test types available for you to select for viewing.

- **Auto Test**
- **Video-DSL Rate Prediction**
- **POTS Auto Test**
- **DMM Tests**
- **VF Receive Tone**
- **VF Noise**
- **VF Impulse Noise**
- **VF Power Influence**
- **VF Long.Balance**
- **VF Load Coil**
- **TDR**
- **RFL-2 Wires**
- **RFL-4 Wires**
- **Loop Mapper**
- **WB Receive Tone**

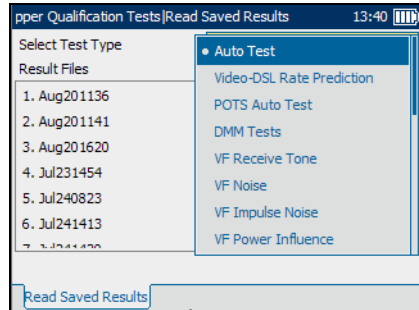

- **WB Impulse Noise**
- **WB Impulse Noise Histogram**
- **Spectral Detective**
- **PSD Noise**
- **Attenuation**
- **WB Longitudinal Balance**
- **WB Data Rate Prediction**
- **Rect. L Detection**
- **Resistive Balance**

To open previously saved test results:

1. Press ✓ to open the list.
2. In the list, press the up/down arrows to select the test type.
3. Press ✓ to confirm the selection.
4. Press the down arrow to activate the **Result Files** list box and press ✓ to display the list of available files.
5. Press the up/down arrows to select the desired result file.
6. Press ✓ to view the selection.

3 **Auto CQ/Video-DSL Rate Prediction**

CQ Auto Test

The cable qualification auto test function allows you to automatically run tests used in pre-qualification, installation, and maintenance of different circuit types from POTS to VDSL2. Auto tests include a range of different tests that compare measured results against stored threshold values to provide pass or fail results. The results are displayed in both text and graphical format.

The following tests can be included in the CQ auto test function:

- AC/DC voltage and current
- Resistance
- Capacitance
- Isolation
- Load coil detection
- Power influence
- Voice frequency (VF) longitudinal balance
- Voice frequency (VF) noise
- Voice frequency (VF) impulse noise
- Voice Frequency (VF) receive tone
- Wideband (WB) receive tone
- Wideband (WB) longitudinal balance
- Power spectral density (PSD) noise
- Attenuation
- Wideband (WB) impulse noise
- Time domain reflectometry (TDR)

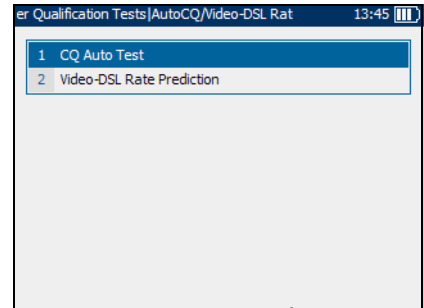

Configuring CQ Auto Tests

Parameters for auto test configuration are on the **CQ Auto Test** pane tabs.

To view auto test configuration tabs:

1. From the **CQ Auto Test** pane use the up/down arrow keys to highlight **Test Configuration**, and press **✓**.
2. Press the F1, F2, or F3 key to view the various tabs. To view any available additional tabs, use the function arrow keys on either side of the F1 and F3 keys.

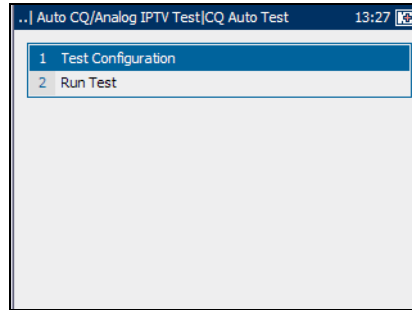

Test List 1

The **Test List 1** tab allows you to select the types of tests to include in the auto test function.

The following tests are available:

- **AC/DC Voltage** detects AC RMS and DC voltages in the line. Toggle between **Enable** and **Disable**.
- **AC/DC Current** checks for AC RMS and DC currents in the line. Toggle between **Enable** and **Disable**.
- **Resistance** measures isolation resistance between the wires and to ground. It is also used to identify possible faults, and to measure the resistance of the twisted pair cable for estimating loop length. Toggle between **Enable** and **Disable**.
- **Capacitance** measures the capacitance of the cable for estimating loop length. Toggle between **Enable** and **Disable**.

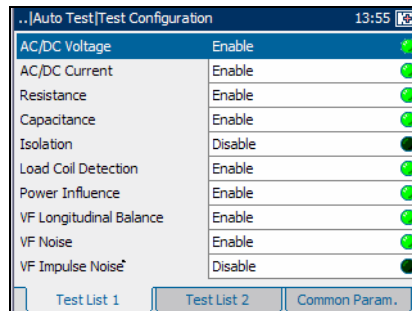

- **Isolation** measures the quality of insulation or sheathing for the copper pairs.
- **Load Coil Detection** detects the presence of load coils in the line. Toggle between **Enable** and **Disable**.
- **Power Influence** measures the effects that 50 Hz and 60 Hz powerline (AC Mains) interference has on the circuit under test. Toggle between **Enable** and **Disable**.
- **VF Longitudinal Balance** is very useful in identifying loops that will suffer from crosstalk. Toggle between **Enable** and **Disable**.
- **VF Noise** measures VF noise in the line. Toggle between **Enable** and **Disable**.
- **VF Impulse Noise** measures the random occurrences of energy spikes in the voice frequency range that have random amplitude and spectral content.

To select tests:

1. Press the up/down arrow keys to highlight a desired test.
2. Press  to toggle between **Enable** and **Disable**.
3. Select other tests as required.

Test List 2

The **Test List 2** tab allows you to select additional tests to include in the auto test function.

The following additional tests are available:

- **VF Receive Tone** measures the level and frequency of the incoming voice signal.
- **WB Receive Tone** measures the level and frequency of the incoming wideband signal.

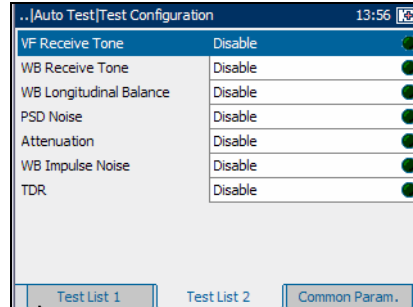

Note: *The VF and WB Receive Tone tests are mutually exclusive. When one test is enabled, the other is automatically disabled.*

- **WB Longitudinal Balance** verifies that the wideband longitudinal balance ratios comply with applicable standards.
- **PSD Noise** measures power spectral density noise.
- **Attenuation** measures the amount of reduction in signal strength.
- **WB Impulse Noise** measures the irregular occurrences of energy spikes in the wideband range that have random amplitude and spectral content.
- **TDR** test identifies and locates all types of faults as well as bridge taps (multiple appearances) and load coils.

To select tests:

1. Press the up/down arrow keys to highlight a desired test.
2. Press **✓** to toggle between **Enable** and **Disable**.
3. Select other tests as required.

Common Parameters

The **Common Param.** tab allows you to set up parameters common to all tests in the auto test function.

Each parameter is described below:

- **Cable Type** defines the gauge of the cable in use. If wire gauge is measured in AWG units, the available choices are: **AUTO**, **19 AWG**, **22 AWG**, **24 AWG**, or **26 AWG**. For mm gauge wire, the available choices are: **AUTO**, **0.32 mm**, **0.40 mm**, **0.50 mm**, **0.60 mm**, **0.80 mm**, **0.90 mm**, or **1.20 mm**.
- **Temperature** specifies the temperature of the cable under test in either **F** (Fahrenheit) or **C** (Celsius) units.
- **Isolation Test Time(sec)** specifies the duration of the isolation test.

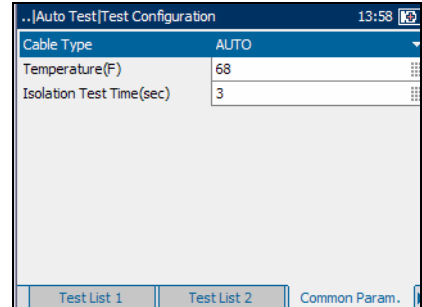

To set parameter values:

1. Press the up/down arrow keys to highlight the desired parameter.
2. Press **✓** to display the list or select the value.
3. Press the up/down arrow keys to highlight the desired value.
OR
4. Press the left arrow key to erase the existing value, and then use the alphanumeric keypad to enter a value. To cancel the entry, press **↶**.
5. Press **✓** to accept the value.

VF Test Parameters

The **VF Parameters** tab allows you to set up parameters used in the voice frequency tests.

Each parameter is described below:

- **VF Noise Filter** defines the level of voice frequency noise filtering. If the ANSI standard is used, the available choices are: **NONE**, **C-MESSAGE**, **C NOTCHED**, **3 kHz FLAT**, **D-FILTER** or **15 kHz**. If the ITU standard is used, the available choices are: **NONE**, **PSOPHOMETRIC**, **P-NOTCHED**, **3 kHz FLAT**, **D-FILTER** or **15 kHz**.
- **VF Termination** defines if the unit uses normal test impedance termination or high bridging impedance when the cable is active or terminated by other external equipment. For normal test termination select **TERMINATED**, otherwise select **BRIDGING**.
- **Imp. Noise Filter** defines the type of impulse noise filtering to use. If ANSI standard is used, the available choices are: **NONE**, **C-MESSAGE**, **C NOTCHED**, **3 kHz FLAT**, **D-FILTER** or **15 kHz**. For the ITU standard, the choices are: **NONE**, **PSOPHOMETRIC**, **P-NOTCHED**, **3 kHz FLAT**, **D-FILTER** or **15 kHz**.
- **Low Threshold(dBm)** defines the low threshold limits for impulse noise. Specify a value between **-40** and **0**.
- **Separation(dB)** defines the level difference (in dB) between the low, the mid and high thresholds. Specify a value between **1** and **6** dB.
- **Imp. Noise Measure. Time** defines the time duration to measure impulse noise. The available choices are: **1 minute**, **5 minutes**, **10 minutes**, **15 minutes**, **60 minutes**, or **24 hours**.

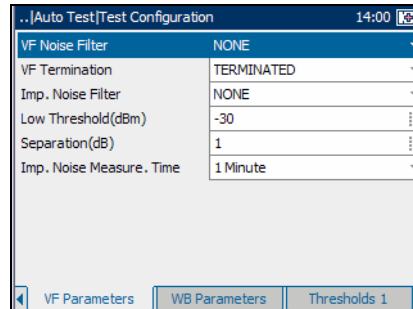

To set parameter values:

1. Press the up/down arrow keys to highlight the desired parameter.
2. Press ✓ to display the list or select the value.
3. Press the up/down arrow keys to highlight the desired value.

OR

4. Press the left arrow key to erase the existing value, and then use the alphanumeric keypad to enter a value. To cancel the entry, press ↩.
5. Press ✓ to accept the value.

Auto CQ/Video-DSL Rate Prediction

Configuring CQ Auto Tests

WB Test Parameters

The **WB Parameters** tab allows you to set up parameters used in the wideband tests.

Each parameter is described below:

- **WB Noise Filter** defines the level of wideband noise filtering. The available choices are: **NONE**, **50 kbit**, **ISDN-E**, **HDSL-F**, **ADSL-G**, **ADSL**, **ADSL2+**, **VDSL**, **VDSL2-8**, **VDSL2-12**, **VDSL2-17**, or **VDSL2-30**.

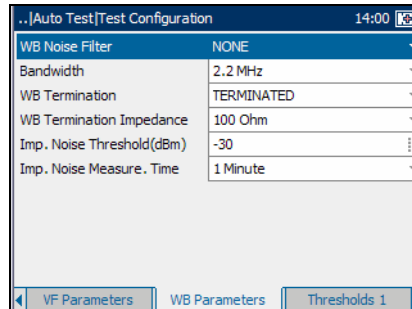

Note: *VDSL2-x filters are only available if VDSL2 is enabled in the software options.*

- **Bandwidth** specifies the frequency range for the test: **2.2 MHz**, **12 MHz**, **17 MHz**, or **30 MHz**.

Note: *Frequency bands in excess of 2.2 MHz are only displayed if VDSL2 is enabled in the software options.*

- **WB Termination** defines if the unit uses normal test impedance termination or high bridging impedance when the cable is active or terminated by other external equipment. For normal test termination select **TERMINATED**, otherwise select **BRIDGING**.
- **WB Termination Impedance** defines the impedance of the dummy load connected to the line. Select one of the following: **100 Ohm** or **135 Ohm**.
- **Imp. Noise Threshold (dBm)** is the maximum impulse noise level. Specify a value between **-50** and **0** (-40 and 0 if any filter applied).
- **Imp. Noise Measure. Time** defines the time duration to measure impulse noise. The available choices are: **1 minute**, **5 minutes**, **10 minutes**, **15 minutes**, **60 minutes**, or **24 hours**.

To set parameter values:

1. Press the up/down arrow keys to highlight the desired parameter.
2. Press ✓ to display the list or select the value.
3. Press the up/down arrow key to highlight the desired value.

OR

4. Press the left arrow key to erase the existing value, and then use the alphanumeric keypad to enter a value. To cancel the entry, press ↩.
5. Press ✓ to accept the value.

Thresholds 1

The **Thresholds 1** tab allows you to set threshold values for the auto tests.

Each parameter is described below:

- **Max. AC Voltage T-R (V)** defines the maximum AC threshold voltage for the T-R leg of the circuit. Specify a value between **1** and **30**.
- **Max. AC Voltage to GND (V)** defines the maximum AC threshold voltage to ground for the circuit. Specify a value between **1** and **30**.
- **Max. DC Voltage T-R (V)** defines the maximum DC threshold voltage for the T-R leg of the circuit. Specify a value between **1** and **400**.
- **Max. DC Voltage to GND (V)** defines the maximum DC threshold voltage to ground for the circuit. Specify a value between **1** and **400**.
- **Min. Resistance T-R(MOhm)**: defines the minimum threshold resistance for the T-R leg of the circuit. Specify a value between **0** and **999**.
- **Min. Resistance T-G(MOhm)** defines the minimum threshold resistance for the T-G leg of the circuit. Specify a value between **0** and **999**.
- **Min. Resistance R-G(MOhm)** defines the minimum threshold resistance for the R-G leg of the circuit. Specify a value between **0** and **999**.

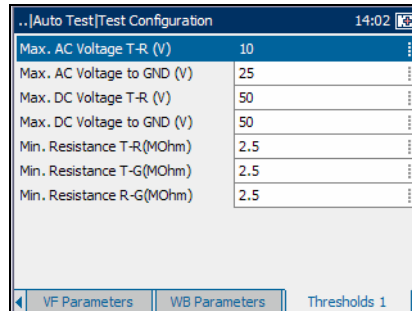

To set a threshold value:

1. Press the up/down arrow keys to highlight the desired parameter.
2. Press ✓ to select the value.
3. Press the left arrow key to erase the existing value, and then use the alphanumeric keypad to enter a value. To cancel the entry, press ↩.
4. Press ✓ to accept the value.

Thresholds 2

The **Thresholds 2** tab allows you to set additional threshold values.

Each parameter is described below:

- **Min. VF Long. Balance(dB)** defines the minimum voice frequency threshold longitudinal balance level. Specify a value between **10** and **80**.
- **Max. VF RMS Noise** defines the maximum threshold RMS noise energy level. Specify a value between **-90** and **10** dBm if the ITU standard is used. Specify a value between **0** and **100** dBm if the ANSI standard is used.
- **Max. VF Power Influence** defines the maximum threshold power influence level on the circuit. Specify a value between **-90** and **20** dBm if the ITU standard is used. Specify a value between **0** and **110** dBmC if the ANSI standard is used.
- **Min. WB Long. Balance(dB)** defines the minimum threshold wideband longitudinal balance level. Specify a value between **10** and **80**.
- **Attenuation(dB)** defines the threshold wideband attenuation level. Specify a value between **0** and **80**.

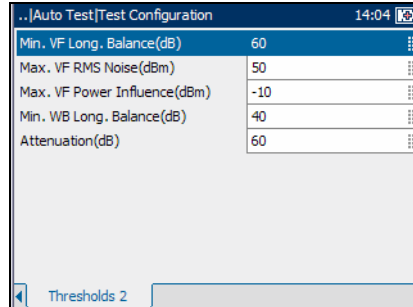

To set a threshold value:

1. Press the up/down arrow keys to highlight the desired parameter.
2. Press ✓ to select the value.
3. Press the left arrow key to erase the existing value, and then use the alphanumeric keypad to enter a value. To cancel the entry, press ↶.
4. Press ✓ to accept the value.

Running CQ Auto Tests and Viewing Results

Auto test results are located on the **CQ Auto Test** pane tabs.

To run auto tests and view results:

1. From the **CQ Auto Test** pane use the up/down arrow keys to highlight **Run Test**, and press **✓**.
2. Press the F1, F2, or F3 key to view the various tabs. To view any available additional tabs, use the function arrow keys on either side of the F1 and F3 keys.

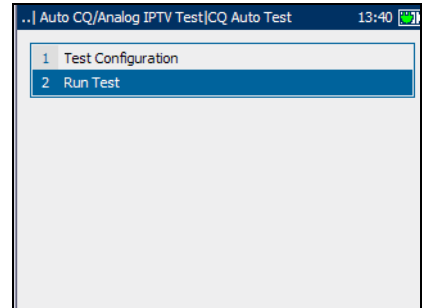

Summary

The **Summary** tab displays the overall **PASS** or **FAIL** status of all tests selected for auto testing.

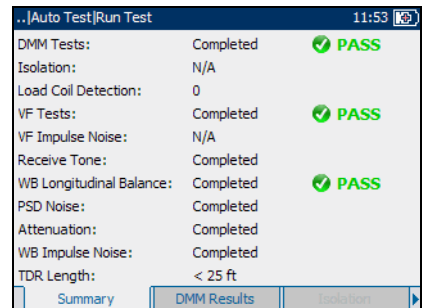

Auto CQ/Video-DSL Rate Prediction

Running CQ Auto Tests and Viewing Results

DMM Results

The **DMM Results** tab displays the measured values and pass or fail status of each digital multimeter (DMM) test.

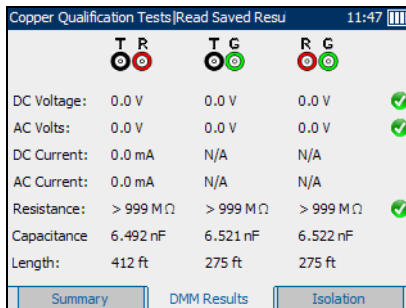

Isolation

The **Isolation** tab displays the measured **Resistance** values from the isolation test.

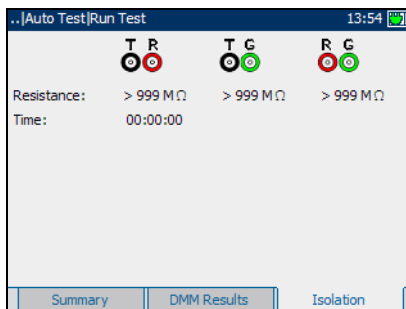

Load Coil

The **Load Coil** tab displays the number of load coils in the line, and measured values from the load coil detection test in graphical form.

To move the screen pointer:

Press the left/right arrow keys to move the screen pointer. The pointer value updates dynamically.

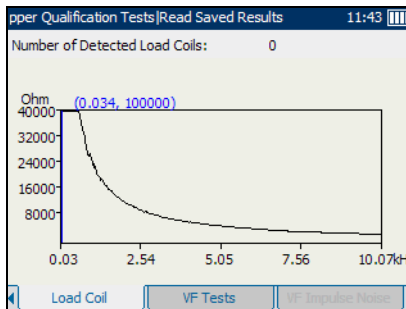

VF Tests

The **VF Tests** tab displays the measured values and **PASS** or **FAIL** status of the voice frequency tests.

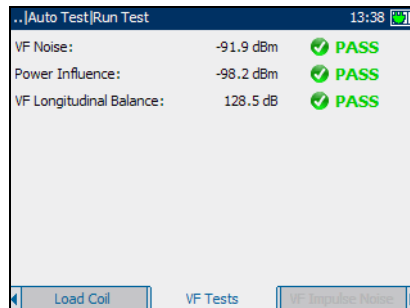

VF Impulse Noise

The **VF Impulse Noise** tab displays the measured values from the voice frequency impulse noise tests.

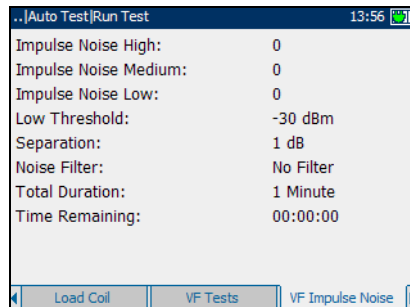

Receive Tone

The **Receive Tone** tab displays the current received frequency and level values of the received tone.

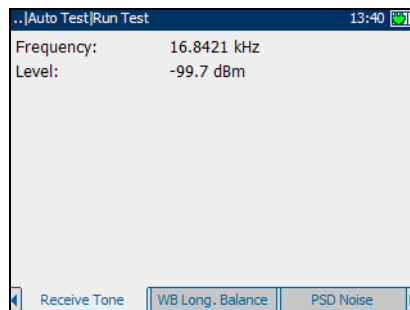

Auto CQ/Video-DSL Rate Prediction

Running CQ Auto Tests and Viewing Results

WB Longitudinal Balance

The **WB Long. Balance** tab displays in graphical form the measured values from the wideband longitudinal balance tests.

The list and buttons on the tab are described below:

- (Zoom function List) allows you to select the desired zoom function **Horizontal Zoom** or **Vertical Zoom**. The selected function is displayed in the box.
- **Zoom In** allows you to increase the level of zoom for the selected zoom function.
- **Zoom Out** allows you to reduce the level of zoom for the selected zoom function.

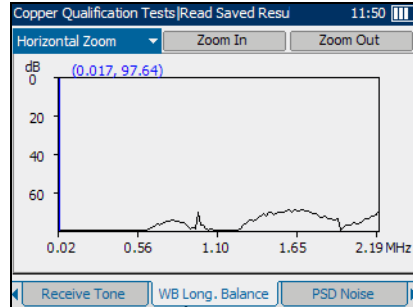

To zoom in or out:

1. Press ✓ to display a list of zoom functions.
2. Press the up/down arrow keys to highlight the desired zoom function.
3. Press ✓ to select the zoom function.
4. Use the left/right arrow keys to highlight the **Zoom In** or **Zoom Out** button as required, then press ✓.

The graphical display zooms in or out accordingly.

5. Press ✓ repeatedly to continue zooming.

To move the screen pointer:

Press the left/right arrow keys to move the screen pointer. The pointer value updates dynamically.

PSD Noise

The **PSD Noise** tab displays the **RMS Noise** value from the power spectral density (PSD) noise tests in text and graphical form.

The list and buttons on the tab are described below:

- (Zoom function List) allows you to select the desired zoom function: **Horizontal Zoom** or **Vertical Zoom**. The selected function is displayed in the box.
- **Zoom In** allows you to increase the level of zoom for the selected zoom function.
- **Zoom Out** allows you to reduce the level of zoom for the selected zoom function.

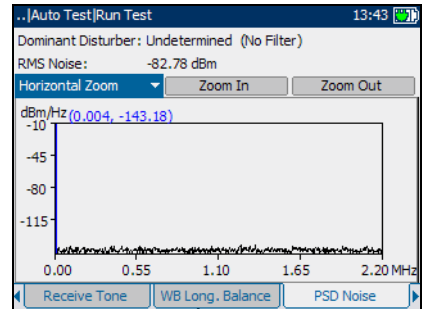

To zoom in or out:

1. Press ✓ to display a list of zoom functions.
2. Press the up/down arrow keys to highlight the desired zoom function.
3. Press ✓ to select the zoom function.
4. Use the left/right arrow keys to highlight the **Zoom In** or **Zoom Out** button as required, then press ✓.

The graphical display zooms in or out accordingly.

5. Press ✓ repeatedly to continue zooming.

To move the screen pointer:

Press the left/right arrow keys to move the screen pointer. The pointer value updates dynamically.

Auto CQ/Video-DSL Rate Prediction

Running CQ Auto Tests and Viewing Results

Attenuation

The **Attenuation** tab displays in graphical form the cable length value from attenuation tests.

The list and buttons on the tab are described below:

- (Zoom function List) allows you to select the desired zoom function: **Horizontal Zoom** or **Vertical Zoom**. The selected function is displayed in the box.
- **Zoom In** allows you to increase the level of zoom for the selected zoom function.
- **Zoom Out** allows you to reduce the level of zoom for the selected zoom function.

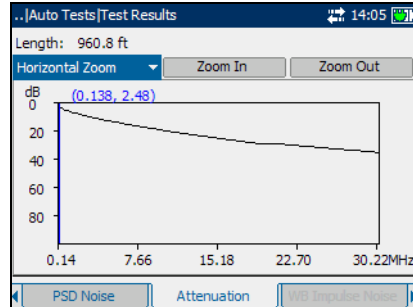

To zoom in or out:

1. Press ✓ to display a list of zoom functions.
2. Press the up/down arrow keys to highlight the desired zoom function.
3. Press ✓ to select the zoom function.
4. Use the left/right arrow keys to highlight the **Zoom In** or **Zoom Out** button as required, then press ✓.

The graphical display zooms in or out accordingly.

5. Press ✓ repeatedly to continue zooming.

To move the screen pointer:

Press the left/right arrow keys to move the screen pointer. The pointer value updates dynamically.

WB Impulse Noise

The **WB Impulse Noise** tab displays the measured values from the wideband impulse noise tests.

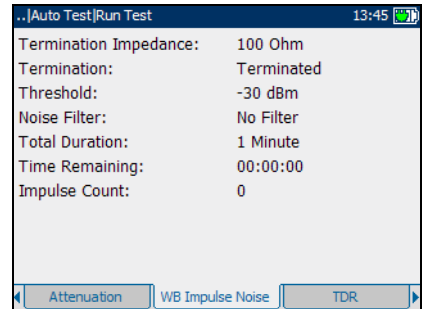

TDR

The **TDR** tab displays the time domain reflectometry which is on and ready to use upon completion of the **Auto Test**. **TDR** first attempts to find the length of the circuit and then searches all ranges from shortest to longest for significant events. Upon completion, the test selects the nearest major event, sets the range to match, and aligns the cursor with the event. It remains running (not in **Fault Location Tests**).

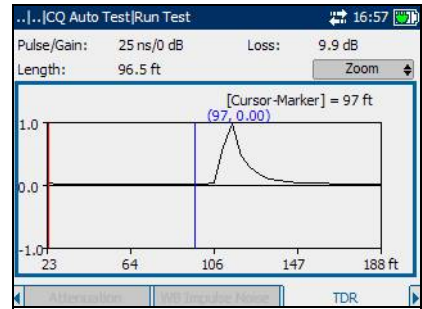

To make TDR adjustments via the keypad:

1. Press **✓** to change the mode button (top-right corner of the pane) and function of the up/down arrow keys.
2. Press **✓** repeatedly to cycle between:
 - Zoom
 - Gain
 - Pulse Gain (Pulse Width & Gain)
 - Range
 - Cursor and Marker Selection

Auto CQ/Video-DSL Rate Prediction

Running CQ Auto Tests and Viewing Results

To measure the distance/duration between reflections:

1. Press  to cycle the mode and change to **CursorMarker**.
2. Press the left/right arrow keys to position the blue cursor (indicated by the blue color of data above cursor).
3. Press the up arrow key to select the red marker.
4. Press the left/right arrow keys to position the marker.
5. The difference between the cursor and marker is continuously updated and is indicated with a triangle (delta symbol) above the graph.

To zoom in/out:

1. Press  to select the **Zoom** function. Default mode is **Zoom**.
2. Press the up/down arrow keys to increase/decrease **Zoom** function. The graphical display zooms in or out accordingly.

Video-DSL Rate Prediction

The video-DSL rate prediction test provides an innovative way to understand the otherwise complicated output of electrical and attenuation measurements, and noise tests as they relate to the capacity to transport IPTV video over ADSL2+ circuits. This test performs a series of loop-quality measurements before predicting the ADSL2+ data rate and Video-DSL rate.

Based on current loop conditions and user-defined technology, the video-DSL rate prediction test shows you how many streams of standard broadcast (SB) and high definition (HD) IPTV video streams the tested circuit could reliably carry.

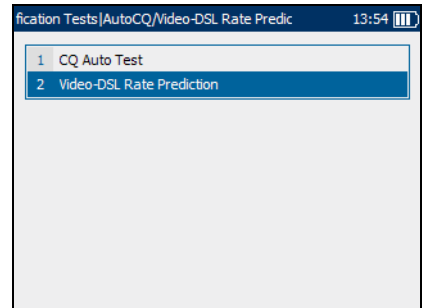

Configuring Video-DSL Rate Prediction

Parameters for auto test configuration are on the **Video-DSL Rate Prediction** pane tabs.

To view the test configuration tabs:

1. From the **Video-DSL Rate Prediction** pane use the up/down arrow keys to highlight **Test Configuration**, and press **✓**.
2. Press the F1, F2, or F3 key to view the various tabs. To view any available additional tabs, use the function arrow keys on either side of the F1 and F3 keys.

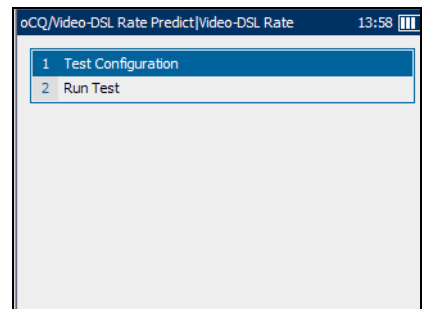

Auto CQ/Video-DSL Rate Prediction

Configuring Video-DSL Rate Prediction

Configuration

The **Configuration** tab allows you to define the desired number of streams and allocated bit rate per stream before running the test.

Each parameter is described below:

- **No Of Streams** is the number of **High Def.** (definition) streams, ranging from 0 to 4 and **Std.** (standard) **Def.** streams ranging from 0 to 10.
- **Stream Rate (Mbps)** is the **High Def.** (HD) and **Std. Def.** (SD) stream rate before running the test, ranging from 0 to 24 Mbps. Default values are 8 Mbps for HD and 1 Mbps for SD.
- **Non-Video Data Rate (Mbps)** is a data rate of non-video data typically used by high-speed internet and VoIP services. Rates range from 0 to 24 Mbps. Default value is 1 Mbps.
- **Annex** defines the modes of available ADSL Annexes from the ITU standards.
 - **A** is ADSL service functioning over POTS.
 - **B** activates the ADSL functionality over ISDN.
 - **L Mask 1** assumes an increase in ADSL2 range/distance.
 - **L Mask 2** also extends the signal reach but can show an improvement in the upstream data rate.
 - **M** allows increased upload speeds from 1 Mbps to 3.5 Mbps. Available only for ADSL2 and ADSL2+.

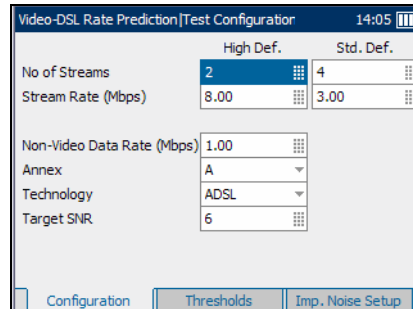

- **Technology** lists the following values: **ADSL2+**, **ADSL2**, or **ADSL**. If **Annex L** is previously selected, **ADSL2** is automatically set. If **Annex M**, **ADSL** is not available.
- **Target SNR** is the desired signal-to-noise ratio ranging from 0 to 31 dB. Default value is 6 dB.

To set parameter values:

1. Press the up/down or left/right arrow keys to highlight the desired parameter.
2. Press ✓ to display the list or select the value.
3. Press the up/down arrow keys to highlight the desired value.
OR
4. Press the left arrow key to erase the existing value, and then use the alphanumeric keypad to enter a value. To cancel the entry, press ↵.
5. Press ✓ to accept the value.

Auto CQ/Video-DSL Rate Prediction

Configuring Video-DSL Rate Prediction

Thresholds

The **Thresholds** tab allows you to set threshold values for the auto tests.

Each parameter is described below:

- **Max AC Voltage (V)** defines the maximum AC voltage, ranging from 1 to 20. Default value is 6.
- **Max DC Voltage (V)** defines the maximum DC voltage ranging from 1 to 20. Default value is 9.
- **Min Resistance (MOhm)** defines the minimum resistance ranging from 0.5 to 100. Default value is 3.6.
- **Max Cap. Balance (%)** defines the percentage maximum capacitance balance ranging from 0 to 20. Default value is 6.
- **Min Long Balance (dB)** defines the minimum longitudinal balance level ranging from 50 to 70. Default value is 59.

Parameter	Value
Max AC Voltage (V)	6
Max DC Voltage (V)	9
Min Resistance (MOhm)	3.6
Max Cap. Balance (%)	6
Min Long Balance (dB)	59

To set a threshold value:

1. Press the up/down arrow keys to highlight the desired parameter.
2. Press ✓ to select the value.
3. Press the left arrow key to erase the existing value, and then use the alphanumeric keypad to enter a value. To cancel the entry, press ↵.
4. Press ✓ to accept the value.

Impulse Noise Setup

The **Imp. Noise Setup** tab allows you to configure parameters to measure impulse noise on the circuit under test.

Each parameter on the pane is described below.

- **Termination** defines if the unit uses normal test impedance termination or high bridging impedance when the cable is active or terminated by other external equipment. For normal test termination select **TERMINATED**, otherwise select **BRIDGING**.
- **Termination Impedance** defines the impedance of the dummy load connected to the line. Select one of the following: **100** or **135 Ohm**.
- **Noise Filter** defines the level of wideband noise filtering. The available choices are: **NONE**, **50 kbit**, **ISDN-E**, **HDSL-F**, **ADSL-G**, **ADSL**, **ADSL2+**, **VDSL**, **VDSL2-8**, **VDSL2-12**, **VDSL2-17**, or **VDSL2-30**.

Note: *VDSL2-x filters are only available if VDSL2WB is enabled in the software options.*

- **Threshold(dBm)** is the maximum impulse noise level. Specify a value between **-50** and **0** (-40 and 0 if any filter applied). Default value is -30.
- **Measurement Time** defines the duration of the Impulse Noise test. The available choices are: **1**, **3**, **5**, **10**, **15**, or **60 Minutes**, or **24 Hours**.

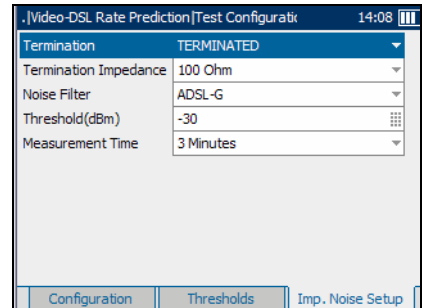

Auto CQ/Video-DSL Rate Prediction

Configuring Video-DSL Rate Prediction

To set parameter values:

1. Press the up/down arrow keys to highlight the desired parameter.
2. Press ✓ to display the list or select the value.
3. Press the up/down arrow keys to highlight the desired value.

OR

4. Press the left arrow key to erase the existing value, and then use the alphanumeric keypad to enter a value. To cancel the entry, press ↩.
5. Press ✓ to accept the value.

Running Video-DSL Rate Prediction Tests and Viewing Results

Details of the video-data rate prediction results are located on the **Video-DSL Rate Prediction** pane tabs.

To run the tests and view results:

1. From the **Video-DSL Rate Prediction** pane use the up/down arrow keys to highlight **Run Test**, and press **✓**.
2. Once the tests are completed, highlight the **Details** button from the **Test Summary** pane and press **✓** to view the results.
3. Press the F1, F2, or F3 key to view the various tabs. To view any available additional tabs, use the function arrow keys on either side of the F1 and F3 keys.

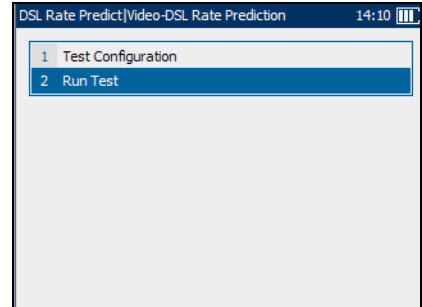

Test Summary

The **Test Summary** tab allows you to view the pass/fail status and **Details** of all tests configured for auto testing.

The available test results are the following:

- **DMM Tests** or digital multimeter tests detect AC/DC voltages, and measure frequency, resistance and capacitance for the copper wire connection.
- **Load Coils Detected** is the number load coils detected in the line.

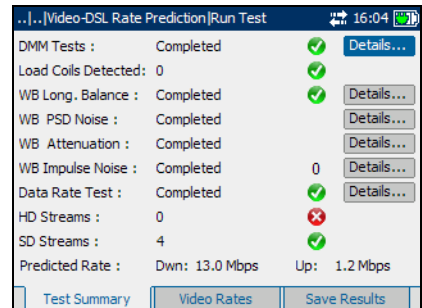



Auto CQ/Video-DSL Rate Prediction

Running Video-DSL Rate Prediction Tests and Viewing Results

- **WB Long. Balance** measures the wide band longitudinal balance of the broadband service.
- **WB PSD Noise** measures the wide band power spectral density noise on the line.
- **WB Attenuation** measures the cable length value from wide band attenuation tests.
- **WB Impulse Noise** measures values from the wideband impulse noise tests.
- **Data Rate Test** predicts the maximum bit rate achievable on the local loop based on **Annex**, **Technology**, and **Target SNR** selected.
- **HD Streams** is the number of high definition streams carried on the local loop. Again, the pass indicator is displayed only if the analyzed number of HD streams matches the number set on the **Configuration** tab. Otherwise the status is fail.
- **SD Streams** is the number of standard definition streams carried on the local loop. Here, the pass indicator is displayed only if the analyzed number of SD streams matches the number set on the **Configuration** tab. Otherwise the status is fail.
- **Predicted Rate** displays the downstream and upstream predicted data rates.
- The **Details** button navigates you to the applicable results tab which provides more information about a particular test.

To view more information about each available test result:

1. Press the up/down arrows to highlight the **Details** button alongside the desired test result.
2. Press  to select the desired **Details** button.
3. To return to the **Test Summary** pane, press .

Video Rates

The **Video Rates** tab allows you to view the pass/fail status, details and predicted data rate of the high and standard definition streams carried on the local loop.

Configurable parameters include:

- **No of Streams** is the number of **High Def.** (definition) streams, ranging from 0 to 4 and **Std. Def.** (standard) **Def.** streams ranging from 0 to 10.
- **Stream Rate (Mbps)** is the **High Def.** (HD) and **Std. Def.** (SD) stream rate before running the test, ranging from 0 to 24 Mbps. Default values are 8 Mbps for HD and 1 Mbps for SD.
- **Technology** lists the following values: **ADSL2+**, **ADSL2**, or **ADSL**. If **Annex L** is previously selected, **ADSL2** is automatically set. If **Annex M**, **ADSL** is not available.
- **Annex** defines the modes of available ADSL Annexes from the ITU standards.
 - **A** is ADSL service functioning over POTS.
 - **B** activates the ADSL functionality over ISDN.
 - **L Mask 1** assumes an increase in ADSL2 range/distance.
 - **L Mask 2** also extends the signal reach but can show an improvement in the upstream data rate.
 - **M** allows increased upload speeds from 1 Mbps to 3.5 Mbps. Available only for ADSL2 and ADSL2+.

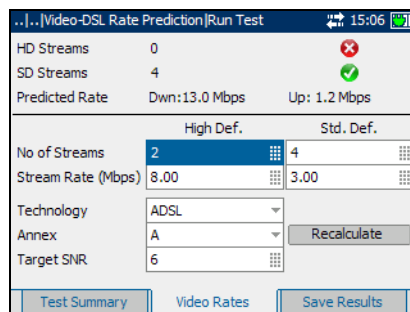

Auto CQ/Video-DSL Rate Prediction

Running Video-DSL Rate Prediction Tests and Viewing Results

- **Target SNR** is the desired signal-to-noise ratio ranging from 0 to 31 dB. Default value is 6 dB.
- **Recalculate** button allows you to change the setup and re-evaluate the rates.

To re-set parameters to view different results:

1. Press the up/down or left/right arrow keys to highlight the desired parameter.
2. Press ✓ to display the list or select the value.
3. Press the up/down arrow keys to highlight the desired value.
OR
4. Press the left arrow key to erase the existing value, and then use the alphanumeric keypad to enter a value. To cancel the entry, press ↩.
5. Press ✓ to accept the value.
6. Press the up/down arrow keys to highlight the **Recalculate** button.
7. Press ✓ to recalculate rates for the new setup.

DMM Tests

The DMM tests results pane displays the measured values on tip, ring, and ground, and the pass/fail status of each digital multimeter test.

Copper Qualification Tests Read Saved R				
	T R	T G	R G	
	⊖ ⊖	⊖ ⊕	⊖ ⊕	
DC Voltage:	0.0 V	0.0 V	0.0 V	✓
AC Voltage:	0.0 V	0.0 V	0.0 V	✓
Frequency:	0 Hz	65 Hz	57 Hz	
Resistance:	653 MΩ	> 999 MΩ	> 999 MΩ	✓
Cap. Balance:	15.15 nF	15.22 nF	15.22 nF	✓
Cap.Length:	1.242 kft	648 ft	648 ft	

WB Longitudinal Balance

The WB Long. Balance pane displays the results of the wideband longitudinal balance test in graphical form.

The buttons on the tab are described below:

- (Zoom function List) allows you to select the desired zoom function: **Horizontal Zoom** or **Vertical Zoom**. The selected function is displayed in the box.
- **Zoom In** allows you to increase the level of zoom for the selected zoom function.
- **Zoom Out** allows you to reduce the level of zoom for the selected zoom function.

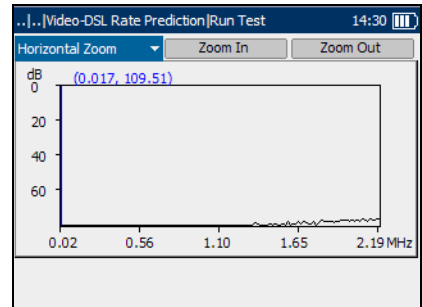

To zoom in/out:

1. Press ✓ to display a list of zoom functions.
2. Press the up/down arrow key to highlight the desired zoom function.
3. Press ✓ to select the zoom function.
4. Use the left/right arrow key to highlight the **Zoom In** or **Zoom Out** button as required, then press ✓.
5. The graphical display zooms in or out accordingly. Press ✓ repeatedly to continue zooming.

To move the screen pointer:

Press the left/right arrow key to move the screen pointer. The pointer value updates dynamically.

Auto CQ/Video-DSL Rate Prediction

Running Video-DSL Rate Prediction Tests and Viewing Results

WB PSD Noise

The WB PSD Noise pane displays the **RMS Noise** value from the power spectral density (PSD) noise tests in text and graphical form. RMS noise voltage measures the signal-to-noise ratio of the circuit.

The list and buttons on the tab are described below:

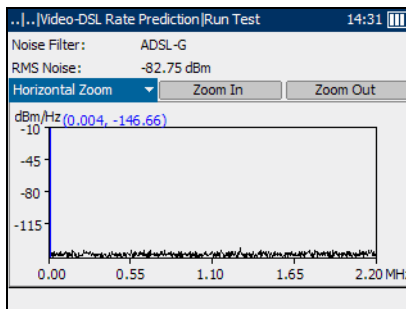

- (Zoom function List) allows you to select the desired zoom function: **Horizontal Zoom** or **Vertical Zoom**. The selected function is displayed in the box.
- **Zoom In** allows you to increase the level of zoom for the selected zoom function.
- **Zoom Out** allows you to reduce the level of zoom for the selected zoom function.

To zoom in or out:

1. Press ✓ to display a list of zoom functions.
2. Press the up/down arrow keys to highlight the desired zoom function.
3. Press ✓ to select the zoom function.
4. Use the left/right arrow keys to highlight the **Zoom In** or **Zoom Out** button as required, then press ✓.

The graphical display zooms in or out accordingly.

5. Press ✓ repeatedly to continue zooming.

To move the screen pointer:

Press the left/right arrow keys to move the screen pointer. The pointer value updates dynamically.

WB Attenuation

The WB Attenuation pane displays the wideband attenuation test results in graphical form.

The list and buttons on the tab are described below:

- (Zoom function List) allows you to select the desired zoom function: **Horizontal Zoom** or **Vertical Zoom**. The selected function is displayed in the box.
- **Zoom In** allows you to increase the level of zoom for the selected zoom function.
- **Zoom Out** allows you to reduce the level of zoom for the selected zoom function.

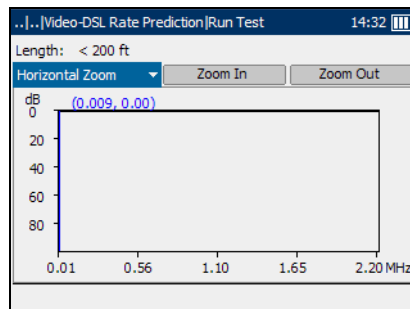

To zoom in/out:

1. Press ✓ to display a list of zoom functions.
2. Press the up/down arrow key to highlight the desired zoom function.
3. Press ✓ to select the zoom function.
4. Use the left/right arrow key to highlight the **Zoom In** or **Zoom Out** button as required, then press ✓.
5. The graphical display zooms in or out accordingly. Press ✓ repeatedly to continue zooming.

To move the screen pointer:

Press the left/right arrow key to move the screen pointer. The pointer value updates dynamically.

Auto CQ/Video-DSL Rate Prediction

Running Video-DSL Rate Prediction Tests and Viewing Results

WB Impulse Noise

The WB Impulse Noise pane displays the measured values from the wideband impulse noise tests.

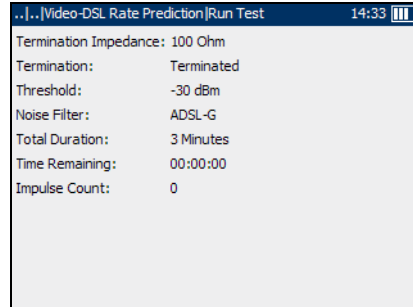

DSL Rate Tests

The **DSL Rate** tab allows you to view the down/up stream **Predicted Rate** based on measurements of PSD noise and attenuation.

Configurable parameters include:

- **Annex** lists the modes of available ADSL Annexes from the ITU standards.
 - **A** is ADSL service functioning over POTS.
 - **B** activates the ADSL functionality over ISDN.
 - **L Mask 1** assumes an increase in ADSL2 range/distance.
 - **L Mask 2** also extends the signal reach but can show an improvement in the upstream data rate.
 - **M** allows increased upload speeds from 1 Mbps to 3.5 Mbps. Available only for ADSL2 and ADSL2+.
- **Target SNR** is the desired signal-to-noise ratio ranging from 0 to 31 dB. Default value is 6 dB.

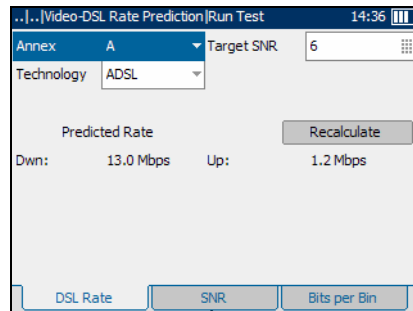

- **Technology** lists the following values: **ADSL2+**, **ADSL2**, or **ADSL**. If **Annex L** is previously selected, **ADSL2** is automatically set. If **Annex M**, **ADSL** is not available.
- **Recalculate** button allows you to change the setup and re-evaluate the rates.

To re-set parameters to view different results:

1. Press the up/down or left/right arrow keys to highlight the desired parameter.
2. Press ✓ to display the list or select the value.
3. Press the up/down arrow keys to highlight the desired value.
OR
4. Press the left arrow key to erase the existing value, and then use the alphanumeric keypad to enter a value. To cancel the entry, press ↵.
5. Press ✓ to accept the value.
6. Press the up/down arrow keys to highlight the **Recalculate** button.
7. Press ✓ to recalculate rates for the new setup.

Auto CQ/Video-DSL Rate Prediction

Running Video-DSL Rate Prediction Tests and Viewing Results

Signal-to-Noise Ratio

The **SNR** tab displays the signal-to-noise ratio per tone in graphical form.

The list and buttons on the tab are described below:

- (Zoom function List) allows you to select the desired zoom function: **Horizontal Zoom** or **Vertical Zoom**. The selected function is displayed in the box.
- **Zoom In** allows you to increase the level of zoom for the selected zoom function.
- **Zoom Out** allows you to reduce the level of zoom for the selected zoom function.

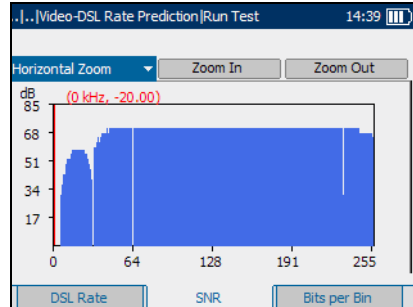

To zoom in or out:

1. Press ✓ to display a list of zoom functions.
2. Press the up/down arrow keys to highlight the desired zoom function.
3. Press ✓ to select the zoom function.
4. Use the left/right arrow keys to highlight the **Zoom In** or **Zoom Out** button as required, then press ✓.

The graphical display zooms in or out accordingly.

5. Press ✓ repeatedly to continue zooming.

To move the screen pointer:

Press the left/right arrow keys to move the screen pointer. The pointer value updates dynamically.

Bits per Bin

The **Bits per Bin** tab displays in graphical form the number of bits that can be transmitted on a particular bin representing a certain tone.

- **Zoom In** allows you to increase the level of zoom for the selected zoom function.
- **Zoom Out** allows you to reduce the level of zoom for the selected zoom function.

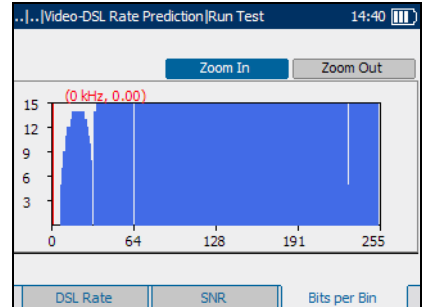

To zoom in or out:

1. Press the up or down arrow key to highlight the desired zoom function.
2. Press ✓ to select the zoom function.
3. Use the left or right arrow key to highlight the **Zoom In** or **Zoom Out** button as required, then press ✓.

The graphical display zooms in or out accordingly.

4. Press ✓ repeatedly to continue zooming.

To move the screen pointer:

Press the left/right arrow keys to move the screen pointer. The pointer value updates dynamically.

4 POTS Auto Test

The purpose of the POTS Auto Test function is to detect the DC current and measure the voice frequency in a copper telephone loop. This test allows you to compare measured results against stored threshold values to provide pass or fail status results of the POTS circuit type.

To view POTS Auto Test tabs:

From the **POTS Auto Test** pane use the F1, F2, or F3 key to view the various tabs.

Thresholds

The **Thresholds** tab allows you to set threshold values for the POTS auto test.

Each parameter is described below:

- **Min DC Current (mA)** is a value ranging from 10 to 100. Default is 23.
- **Max Loss (dB)** is a value ranging from 0 to 50. Default is 8.
- **Max VF Power Influence** is a value ranging from -90 to 10 dBm with a default of -10, if the ITU Standard is used. If ANSI Standard, the range is from 0 to 100 dBm with a default value of 80.
- **Max VF Noise** is a value ranging from -90 to 10 dBm with a default of -70, if the ITU Standard is used. If ANSI Standard, the range is from 0 to 100 dBm with a default value of 20.
- **Min Long Balance (dB)** is a value ranging from 0 to 100. Default is 60.

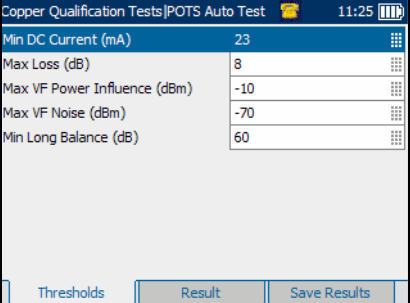

Copper Qualification Tests POTS Auto Test		11:25
Min DC Current (mA)	23	
Max Loss (dB)	8	
Max VF Power Influence (dBm)	-10	
Max VF Noise (dBm)	-70	
Min Long Balance (dB)	60	

Thresholds Result Save Results

To set a threshold value and start/stop the test:

1. Press the up/down arrow keys to highlight the desired parameter.
2. Press ✓ to select the value.
3. Press the left arrow key to erase the existing value, and then use the alphanumeric keypad to enter a value. To cancel the entry, press ↩.
4. Press ✓ to accept the value.
5. Select other parameters as required.
6. Press ↻ to start/stop the test.

Result

The **Result** tab allows you to view detailed results of the **DC Current**, voice frequency measurement values and Pass/Fail status of the POTS Auto Test.

Copper Qualification Tests POTS Auto Test		11:34
Dialer Status:	ON HOOK	
DC Current:	0.0 mA	< 23.0 mA ✘
Loss:	N/A	
VF Power Influence:	N/A	
VF Noise:	N/A	
VF Longitudinal Balance:	N/A	

Thresholds Result Save Results

5 DMM Tests

The purpose of the digital multimeter (DMM) tests function is to detect AC/DC voltages and currents, and measure resistance and capacitance in a loop. These tests allow you to make basic electrical safety checks (AC volts), check from “crossed” or coupled battery voltages, assess basic loop continuity and quality with resistance measurements, and measure total electrical length with capacitance.

The DMM Tests menu includes the following tests:

- DMM
- In-service pair, rectified loop, and water detection
- Resistive balance

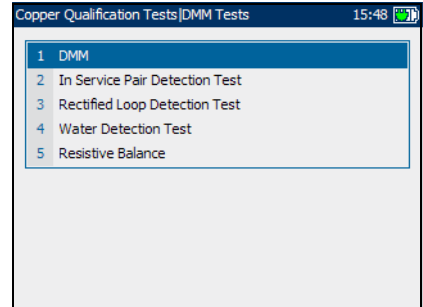

DMM

The DMM function allows you to perform the following tests:

- Voltage
- Resistance (also known as shorts meter)
- Isolation (also known as stress/leakage)
- Capacitance (also known as opens meter)
- Current
- VF Noise
- Longitudinal Balance
- POTS Dialer

To view DMM test tabs:

From the **DMM** pane use the F1, F2, or F3 key to view the various tabs. To view any available additional tabs, use the function arrow keys on either side of the F1 and F3 keys.

Voltage

The **Voltage** tab shows measured volts for each lead combination and allows you to measure AC/DC voltages and **Frequency** on tip, ring, and ground (A/B/Earth).

Each parameter is described below.

- **Input Imp.** displays the input impedance in the loop. The available choices are: **>1 MOhm**, **100 KOhm**.
- **Connection** defines the type of connection to be tested. The available choices are: **Tip-Ring**, **Tip-Gnd**, **Ring-Gnd**.

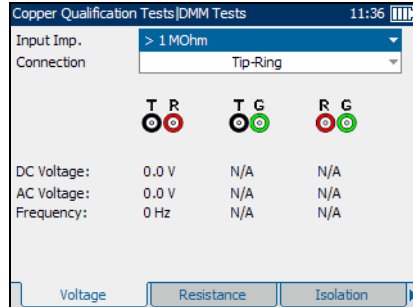

To start/stop the test:

1. Press the up/down arrow keys to highlight the desired test parameter.
2. Press ✓ to open the list.
3. Press the up/down arrow keys to highlight the desired value, then press ✓ to select it.
4. Select other parameters as required.
5. Press ↻ to start/stop the test.

Test results are displayed on the screen as they are completed.

Resistance

The **Resistance** tab allows you to measure the current resistance value and cable length for the cable connection.

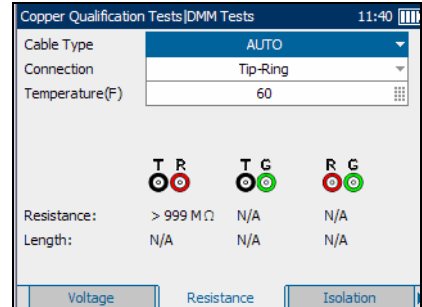



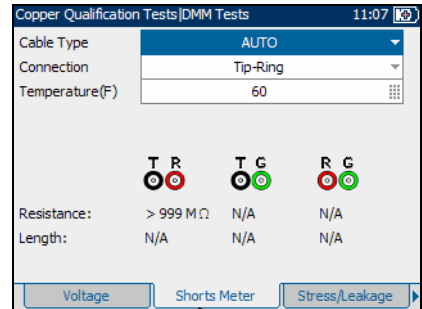

Note: *If the ANSI standard is used, the tab name **Resistance** changes to **Shorts Meter**.*

Each parameter is described below.

- **Cable Type** defines the gauge of the cable in use. If wire gauge is measured in AWG units, the available choices are: **AUTO**, **19 AWG**, **22 AWG**, **24 AWG**, or **26 AWG**. For mm gauge wire, the available choices are: **AUTO**, **0.32 mm**, **0.40 mm**, **0.50 mm**, **0.60 mm**, **0.65 mm**, **0.80 mm**, **0.90 mm**, or **1.20 mm**.
- **Connection** defines the type of connection to be tested. The available choices are: **Tip-Ring**, **Tip-Gnd**, **Ring-Gnd**, **All**.
- **Temperature(F)** is the temperature of the cable.



To start/stop the test:

1. Press the up/down arrow keys to highlight the desired test parameter.
2. Press  to open the list or specify a value.
3. Press the up/down arrow keys to highlight the desired value.
OR
4. Press the left/right arrow keys to erase the existing value, and then use the alphanumeric keypad to enter a value. To cancel the entry, press .
5. Press  to accept the value.
6. Select other parameters as required.
7. Press  to start/stop the test.

Test results are displayed on the screen as they are completed.

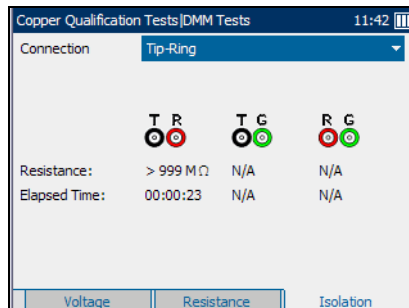

Isolation

The **Isolation** tab allows you to run a resistance test over a period of time to look for high-resistive faults. This method may also reveal poor wire insulation. Select the type of **Connection** to be tested. The available choices are: **Tip-Ring**, **Tip-Gnd**, **Ring-Gnd**.



Note: If the ANSI standard is used, the tab name **Isolation** changes to **Stress/Leakage**.

To start/stop the test:

1. Press the up/down arrow keys to highlight the desired test parameter.
2. Press  to open the list.
3. Press the up/down arrow keys to highlight the desired value, then press  to select it.
4. Press  to start/stop the test.

Test results are displayed on the screen as they are completed.

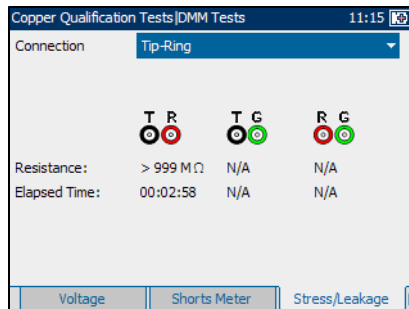

Capacitance

The **Capacitance** tab allows you to measure the capacitance of the loop and capacitance length.

If no contact fault, check the **Fault Location** test and trace for characteristic reflection of water.

Also check the **Long. Balance** tab for <55 dB which could indicate a split if no other faults detected.

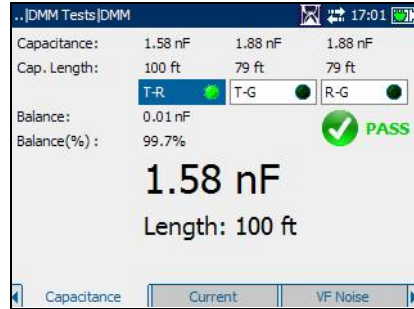

Note: If the ANSI standard is used, the tab name *Capacitance* changes to *Opens Meter*.

- **Cable Fill** allows you to select the type of material the cable can be filled with.
- **Connection** defines the type of connection to be tested.
- **Cap bal. thr. (nF)** is the capacitance balance threshold ranging from 0.1 to 20 nF. If the measured capacitive balance in nF is greater than this threshold, **FAIL** is displayed. Otherwise, **PASS** is displayed.
- **Cap bal. thr. (%)** is the capacitance balance threshold ranging from 50 to 100%. If the measured capacitance balance in percentage is greater than this threshold, **PASS** is displayed. Otherwise, **FAIL** is displayed.
- **Low cap value(nF)** defines which of the above thresholds will be used to determine pass or fail. The range is 0.1 to 500 nF. If the loop capacitance is less than the **Low cap value**, the threshold in **Cap bal. thr. (nF)** will be used. Otherwise, the threshold in **Cap bal. thr. (%)** is used.

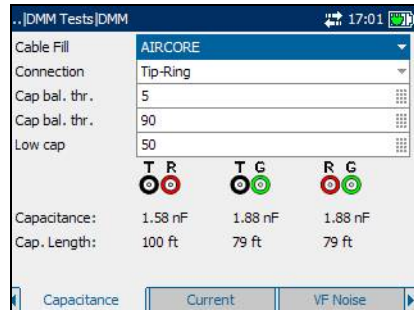

To start/stop the test:

1. Press the up/down arrow keys to highlight the desired test parameter.
2. Press ✓ to open the list.
3. Press the up/down arrow keys to highlight the desired value, then press ✓ to select it.
4. Select other parameters as required.
5. Press ↻ to start/stop the test.

Test results are displayed on the screen as they are completed.

Current

The **Current** tab allows you to measure the AC/DC currents and frequency in the loop.

To start/stop the test:

Press ↻ to start/stop the test.

Test results are displayed on the screen as they are completed.

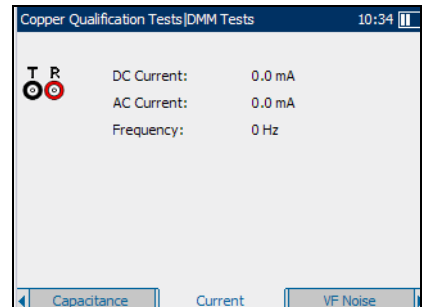

VF Noise



The **VF Noise** test allows you to measure the amount of unwanted or disturbing energy introduced into a loop from man-made and natural sources.

Each parameter is described below.

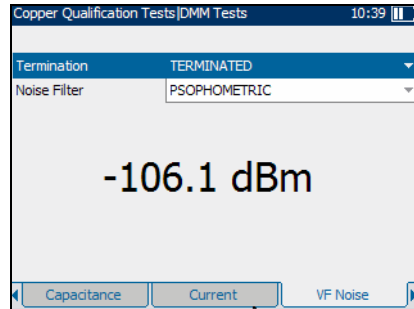
- **Termination** is either **BRIDGING** if the unit uses high bridging impedance when the cable is active or terminated by other external equipment, or **TERMINATED** if the unit uses normal test impedance termination.
- **Noise Filter** is either **PSOPHOMETRIC** for ITU standard or **C-MESSAGE** for ANSI standard.



To start/stop the test:

1. Press the up/down arrow keys to highlight the desired test parameter.
2. Press  to open the list.
3. Press the up/down arrow keys to highlight the desired value, then press  to select it.
4. Select other parameters as required.
5. Press  to start/stop the test.

Test results are displayed on the screen as they are completed.

Longitudinal Balance

The **Long. Balance** test allows you to check that the longitudinal balance ratio for the twisted pair complies with applicable standards so as to reduce the effects of common-mode voltage to ground. The better the longitudinal balance of the cable pair, the higher the dB reading.

To start/stop the test:

Press  to start/stop the test.

Test results are displayed on the screen as they are completed.

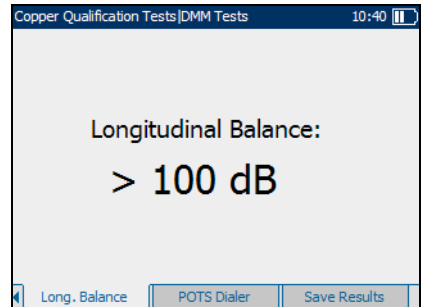

DMM Tests

In Service Pair Detection Test

In Service Pair Detection Test

At the start of the In Service Pair Detection test, the unit will check for the presence of dangerous voltage and an active circuit. If dangerous voltage is detected, a dialog box will be displayed to inform you and the test will stop. If an active circuit is detected, a dialog box will be displayed to ask the you whether or not to proceed with the test.

In Service

The **In Service Pair Detection Test** uses the black and green (ground) leads to quickly check if wire pairs are **in service** or available for usage. This test checks for the following:

- dangerous voltages
- high voltages
- POTS battery (>45 V)
- digital service signals
- a bad ground connection



Note: *Test beeps or warns when ground is NOT present or very poor.*

Rectified Loop (Corrosion) Detection Test

The **Rect. L Detection** tab displays a rectified loop state which often indicates the presence of corrosion on a circuit. Rectified loops can disrupt balance and make the circuit unsuitable for Broadband and other digital services.

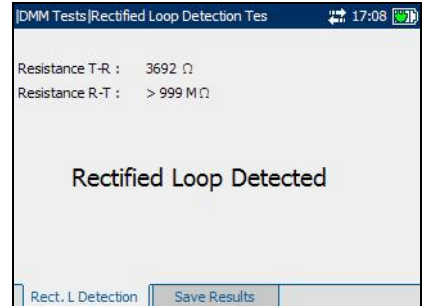

Water Detection Test

The **Water Detection Test** detects the presence of water in the circuit. Use the TDR to locate.

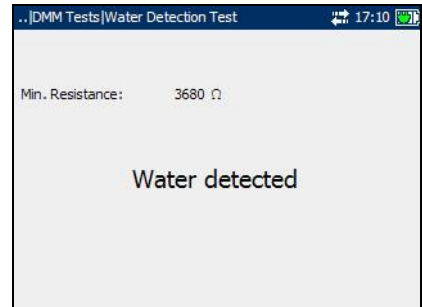

Resistive Balance

At the start of the Resistive Balance test, the unit will check for the presence of dangerous voltage and an active circuit. If dangerous voltage is detected, a dialog box will be displayed to inform you and the test will stop. If an active circuit is detected, a dialog box will be displayed to ask you whether or not to proceed with the test.

Test Setup

The Test Setup tab allows you to configure parameters for the resistive balance test.

Each parameter is described below:

- **Res. Bal. Thr. (ohm)** is the resistive balance threshold ranging from 0.1 to 20 ohms. If the measured resistive balance in ohms is greater than this threshold, the fail icon is displayed. Otherwise, the pass icon is displayed.
- **Res. Bal. Thr. (%)** is the resistive balance threshold ranging from 50 to 100%. If the measured resistive balance in percentage is greater than this threshold, the pass icon is displayed. Otherwise, the fail icon is displayed.
- **Low Resistance Value (ohm)** defines which of the above thresholds will be used to determine pass or fail. The range is 0.1 to 999.9 ohm. If the loop resistance is less than the **Low Resistance Value**, the threshold in **Res. Bal. Thr. (ohm)** will be used. Otherwise, the threshold in **Res. Bal. Thr. (%)** is used.

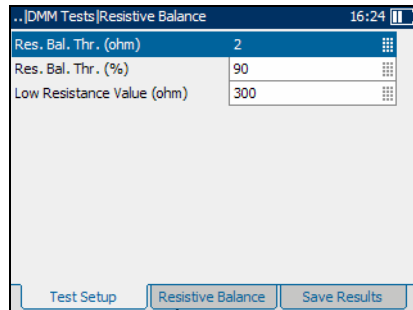

To set parameter values and start/stop the test:

1. Press the up/down arrow keys to highlight the desired parameter.
2. Press ✓ to select the value.
3. Press the left arrow key to erase the existing value, and then use the alphanumeric keypad to enter a value. To cancel the entry, press ↩.
4. Press ✓ to accept the value.
5. Select other parameters as required.
6. Press ↻ to start/stop the test.

Resistive Balance

The **Resistive Balance** test measures and compares the resistance of each leg. This test requires the Tip and Ring wires to be shorted to earth/ground at the far end of the circuit for a valid measurement.

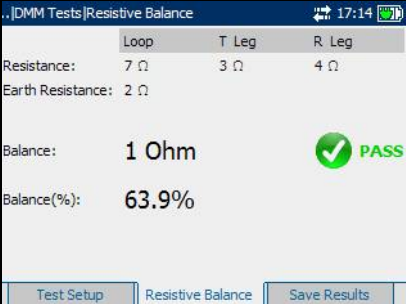

	Loop	T Leg	R Leg
Resistance:	7 Ω	3 Ω	4 Ω
Earth Resistance:	2 Ω		
Balance:	1 Ohm		✓ PASS
Balance(%):	63.9%		

Test Setup Resistive Balance Save Results

6 VF Tests

The purpose of the voice frequency (VF) tests is to perform VF band noise and level measurements, and count load coils. The AXS-200/635 uses the following types of VF tests:

- Receive tone (RX)
- Send tone (TX)
- Tracing tone
- VF noise
- Impulse noise
- Power influence
- Longitudinal balance
- Load coil detection

To view VF test panes or tabs:

1. From the **VF Tests** pane use the up or down arrow key to highlight the desired test, then press **✓**.
2. Press the F1, F2, or F3 key to view any available tabs. To view any available additional tabs, use the function arrow keys on either side of the F1 and F3 keys.

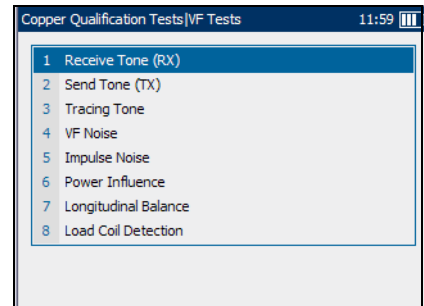

Receive Tone (RX)

The **Receive Tone (RX)** tab allows you to configure and run a receive tone test, which measures the frequency and level of incoming signals.

Select the type of **Termination**, either **BRIDGING** if the unit uses high bridging impedance when the cable is active or terminated by other external equipment, or **TERMINATED** if the unit uses normal test impedance termination.

To start/stop the test:

1. Press ✓ to open the list.
2. Press the up/down arrow keys to highlight the desired value, then press ✓ to select it.
3. Press ↻ to start/stop the test.

Test results are displayed on the screen as they are completed.

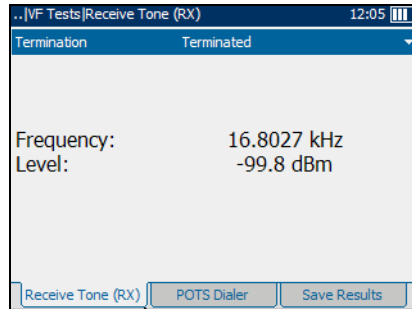

Send Tone (TX)

The VF **Send Tone (TX)** pane allows you to configure and transmit a tone to a downstream device in the loop.

Each parameter and button on the pane is described below.

- **Frequency (Hz)** is the frequency of the transmitting tone. Specify a value between **200** and **20000**. Default value is 1004 Hz.
- **Level (dBm)** is the tone level. Specify a value between **-20** and **10**.
- **Apply** is used to confirm any changes to parameter values which can be changed while the test is running.

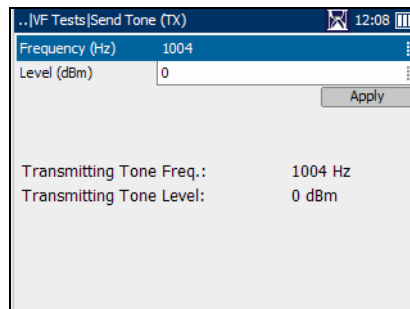

To start/stop the test:

1. Press the up/down arrow keys to highlight the desired test parameter.
2. Press ✓ to specify a value.
3. Press the left/right arrow keys to erase the existing value, and then use the alphanumeric keypad to enter a value. To cancel the entry, press ↵.
4. Press ✓ to accept the value.
5. Select other parameters as required.
6. Press ↻ to start/stop the test.

Test results are displayed on the screen as they are completed.

Tracing Tone

The **Tracing Tone** pane allows you to configure and place a pulsed tone on the line to trace a cable pair at the far end. When **Tracing Tone** is selected from the **VF Tests** menu, the tracer tone sends a 577 Hz signal for the first 80 ms, then the signal is turned off for 80 ms, turned on for another 80 ms, and off again for another 320 ms. The sequence of this tone is repeated continuously until you stop the test. Sinusoidal waveform is used to generate the 577 Hz signal.

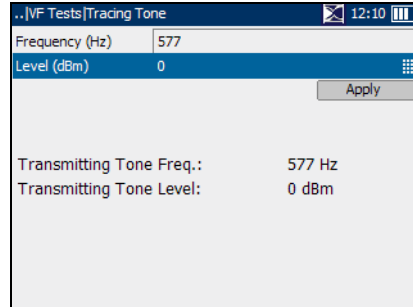

Each parameter and button on the pane is described below.

- **Frequency (Hz)** value is set to 577 Hz.
- **Level (dBm)** is the tone level. Specify a value between **-20** and **10**.
- **Apply** is used to confirm any changes to the parameter value.

To start/stop the test:

1. Press ✓ to specify a value.
2. Press the left/right arrow keys to erase the existing value, and then use the alphanumeric keypad to enter a value. To cancel the entry, press ↵.
3. Press ✓ to accept the value.
4. Press ↻ to start/stop the test.

Test results are displayed on the screen as they are completed.



VF Noise

The **VF Noise** pane allows you to configure and run a VF noise test. It measures the amount of unwanted or disturbing energy introduced into a loop from man-made and natural sources.

Each parameter is described below.

- **Termination** defines if the unit uses normal test impedance termination or high bridging impedance when the cable is active or terminated by other external equipment. For normal test termination select **TERMINATED**, otherwise select **BRIDGING**.
- **Noise Filter** defines the type of noise filtering to use. If ANSI standard is used, the available choices are: **NONE**, **C-MESSAGE**, **C-NOTCHED**, **3 kHz Flat**, **D-FILTER** or **15 kHz**. For the ITU standard, the choices are: **NONE**, **PSOPHOMETRIC**, **P-NOTCHED**, **3 kHz Flat**, **D-FILTER** or **15 kHz**.

To start/stop the test:

1. Press the up/down arrow keys to highlight the desired test parameter.
2. Press  to open the list.
3. Press the up/down arrow keys to highlight the desired value, then press  to select it.
4. Select other parameters as required.
5. Press  to start/stop the test.

Test results are displayed on the screen as they are completed.

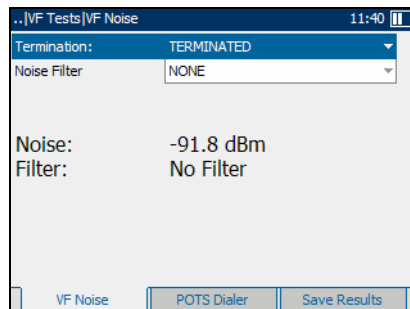

Impulse Noise

The impulse noise test allows you to measure impulse noise on the circuit under test.

Test Setup

The **Test Setup** tab allows you to configure parameters for the impulse noise test.

Each parameter on the pane is described below.

- **Termination** defines if the unit uses normal test impedance termination or high bridging impedance when the cable is active or terminated by other external equipment. For normal test termination select

TERMINATED, otherwise select **BRIDGING**.

- **Noise Filter** defines the type of noise filtering in use. If ANSI standard is used, the available choices are: **NONE**, **C-MESSAGE**, **C NOTCHED**, or **D-FILTER**. For the ITU standard, the choices are: **NONE**, **PSOPHOMETRIC**, **P-NOTCHED**, or **D-FILTER**
- **Low Threshold (dBm)** defines the low threshold limits for the impulse noise test. Specify a value between **-40** and **0**.
- **Separation (dB)** defines the level difference between the low, mid and high thresholds. Specify a value between **1** and **6** dB.
- **Imp. Noise Measure. Time** defines the duration of the impulse noise test. The available choices are: **1**, **5**, **10**, **15**, **60 Minutes**, or **24 Hours**.

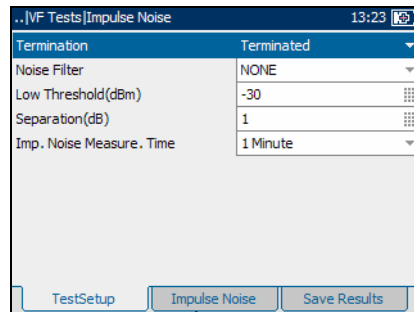

To set parameter values and start/stop the test:

1. Press the up/down arrow keys to highlight the desired parameter.
2. Press ✓ to display the list or specify the value.
3. Press the up/down arrow keys to highlight the desired value.

OR

4. Press the left arrow key to erase the existing value, and then use the alphanumeric keypad to enter a value. To cancel the entry, press ↩.
5. Press ✓ to accept the value.
6. Select other parameters as required.
7. Press ↻ to start/stop the test.

VF Tests

Power Influence

Impulse Noise

The **Impulse Noise** tab allows you to view results of the VF impulse noise test.

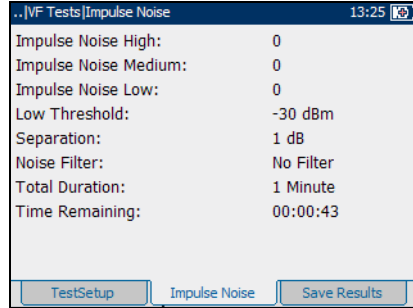

Power Influence

The **Power Influence** tab allows you to view the effects of interference from a 50 Hz or 60 Hz power line (AC mains) on the circuit under test. The results of the power influence test are in graphical form.

To move the screen pointer:

Press the left/right arrow keys to move the screen pointer. The pointer value updates dynamically.

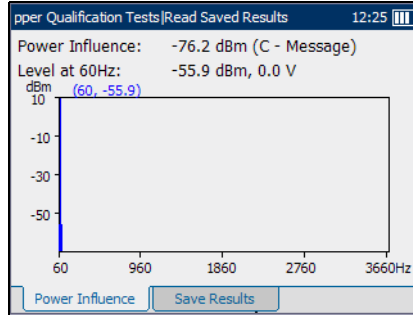

Longitudinal Balance

The **Long. Balance** test allows you to check that the VF longitudinal balance ratio for the twisted pair complies with applicable standards so as to reduce the effects of common-mode voltage to ground. The better the longitudinal balance of the cable pair, the higher the dB reading.

To start/stop the test:

Press  to start/stop the test.

Test results are displayed on the screen as they are completed.

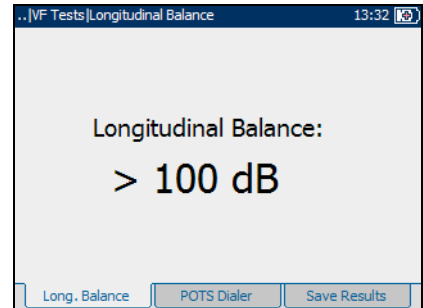

Load Coil Detection

The **Load Coil** detection test allows you to detect the presence of load coils, which are detrimental to the use of DSL technologies on the line. If a load coil is detected, use the time domain reflectometry (TDR) test to quickly locate and remove it from the cable. Test results are displayed in graphical form.

To move the screen pointer:

Press the left/right arrow key to move the screen pointer. The pointer value updates dynamically.

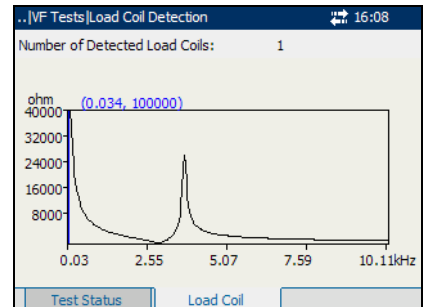

7 **Fault Location Tests**

Fault location tests are used to locate faults in the loop. The AXS-200/635 uses the following types of fault location tests:

- TDR
- RFL Single Pair (2 wire)
- RFL Separate Good Pair (4 wire)
- Loop Mapper

To view fault location test panes or tabs:

1. From the **Fault Location** pane use the up or down arrow key to highlight the desired test, then press **✓**.
2. Press the F1, F2, or F3 key to view available tabs. To view any available additional tabs, use the function arrow keys on either side of the F1 and F3 keys.



TDR Test

The time domain reflectometry (TDR) test allows you to easily locate bridge taps (multiple appearances), the end of the cable, open ends, shorted ends, splices, split pairs, and wet sections in a cable. It also allows you to estimate cable lengths.

A TDR test transmits a fast pulse along the cable, then measures the resulting reflected pulse as a function of time, and displays the results as a function of the cable length or time.

Fault Location Tests

TDR Test

Test Setup

The **Test Setup** tab allows you to configure parameters for the TDR test. **VOP** sets the velocity of propagation for the cable as a ratio of the speed of light.

Note: *The default VOP is good for most cables; only change it when you know the correct VOP for the cable you are measuring. An incorrect VOP will cause distance errors.*

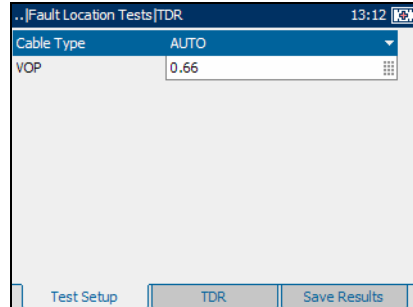

TDR

The **TDR** test first attempts to find the length of the circuit and then searches all ranges from shortest to longest for significant events. Upon completion, the test selects the nearest major event, sets the range to match, and aligns the cursor with the event.

Est is the estimated length of the circuit.

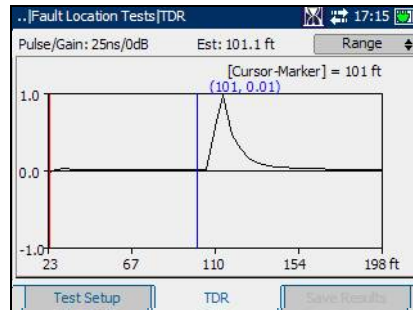

To make TDR adjustments via the keypad:

1. Press ✓ to change the mode and function of the up/down arrow keys.
2. Press ✓ repeatedly to cycle between:
 - Zoom
 - Gain
 - Pulse Gain (Pulse Width & Gain)
 - Range
 - Cursor and Marker Selection

To measure the distance/duration between reflections:

1. Press ✓ to cycle the mode and change to **CursorMarker**.
2. Press the left/right arrow keys to position the blue cursor (indicated by the blue color of data above cursor).
3. Press the up arrow key to select the red marker.
4. Press the left/right arrow keys to position the marker.
5. The difference between the cursor and marker is continuously updated and is indicated with a triangle (delta symbol) above the graph.

To zoom in/out:

1. Press ✓ to select the **Zoom** function. Default mode is **Zoom**.
2. Press the up/down arrow keys to increase/decrease **Zoom** function. The graphical display zooms in or out accordingly.

Fault Location Tests

RFL Single Pair (2 wire) Test

Resistance fault locator (RFL) testing is a powerful means to locate shorts between tip to ring, tip to ground, or ring to ground. The RFL-2 wire test, also known as RFL single pair test, allows you to locate resistive faults between tip to ring, tip or ring to ground, or the adjacent live pair.

Note: Before performing RFL tests install a strap at the other end of the cable.

Test Setup

The **Test Setup** tab allows you to configure parameters for the RFL test.

Each parameter on the pane is described below.

- **Sect.** denotes the section number in the cable. Select to enable or disable that section of the cable.
- **Cable Type** defines the gauge of the cable in use. If wire gauge is measured in AWG units, the available choices are: **AUTO**, **19 AWG**, **22 AWG**, **24 AWG**, or **26 AWG**. For mm gauge wire, the available choices are: **AUTO**, **0.32 mm**, **0.40 mm**, **0.50 mm**, **0.60 mm**, **0.65 mm**, **0.80 mm**, **0.90 mm**, or **1.20 mm**.
- **Ohm/mi** or **Ohm/km** is the resistance constant of the cable per unit length.
- **Len.** is the length of the cable under test. Specify a maximum of four characters.
- **Temp.** is the temperature of the cable under test. Specify a maximum of three characters. Default is 60F or 20C.
- **L.Coil** specifies the presence or absence of load coil in the cable section. Select **YES** or **NO**.

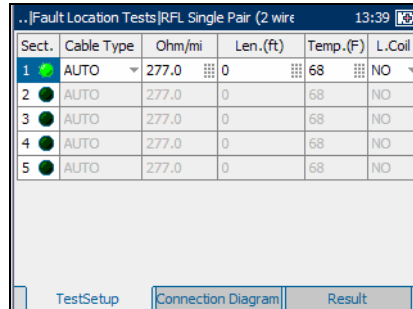

Sect.	Cable Type	Ohm/mi	Len.(ft)	Temp.(F)	L.Coil
1	AUTO	277.0	0	68	NO
2	AUTO	277.0	0	68	NO
3	AUTO	277.0	0	68	NO
4	AUTO	277.0	0	68	NO
5	AUTO	277.0	0	68	NO

To set parameter values:

- 1.** To configure a section of cable for the test, press the up/down arrow keys to highlight the section icon then press ✓ to enable the section.
To disable a section, highlight the section icon then press ✓.
- 2.** Use the left/right arrow keys to highlight each parameter and press ✓ to open the list or select the value.
- 3.** Press the up/down arrow key to highlight the desired value.

OR

Press the left arrow key to erase the existing value, and then use the alphanumeric keypad to enter a value. To cancel the entry, press ↩.

- 4.** Press ✓ to accept the value.
- 5.** Set other parameters as necessary.
- 6.** Configure other sections of the cable as required.
- 7.** Press ↻ to start/stop the test.

Fault Location Tests

RFL Single Pair (2 wire) Test

Connection Diagram

The **Connection Diagram** tab displays how to connect the cables to the unit.

The green lead is used as reference.

Continue button allows you to resume the test once the cables have been connected.

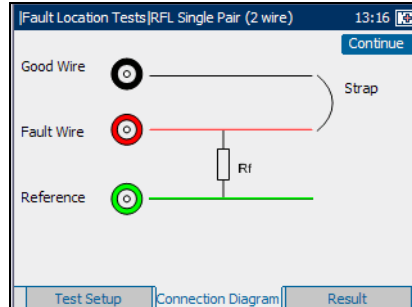

Result

The **Result** tab allows you to view detailed results of the RFL test.

The table displays the test results for an RFL-2 Wires test. The window title is '|RFL-2 Wires|Test Results' and the time is 16:34. The results are as follows:

Distance to fault:	18.174 kft	149.7 Ω
Distance from fault to end:	57.502 kft	473.7 Ω
Distance to end:	75.676 kft	623.5 Ω
Fault located in section:	1	
Resistance at fault:	21.39 M Ω	
Voltage at fault:	0.0 V	

At the bottom, there are tabs for 'Test Status', 'Connection Diagram', and 'Result'.

RFL Separate Good Pair (4 wire) Test

The RFL separate good pair test, allows you to determine the distance to a short, ground, or battery cross in a faulty cable pair using a separate good cable pair.

Note: Before performing RFL tests install a strap at the other end of the cable.

Test Setup

The **Test Setup** tab allows you to configure parameters for the RFL test.

Each parameter on the pane is described below.

- **Sect.** denotes the section number in the cable. Select to enable or disable that section of the cable.
- **Cable Type** defines the gauge of the cable in use. If wire gauge is measured in AWG units, the available choices are: **AUTO**, **19 AWG**, **22 AWG**, **24 AWG**, or **26 AWG**. For mm gauge wire, the available choices are: **AUTO**, **0.32 mm**, **0.40 mm**, **0.50 mm**, **0.60 mm**, **0.65 mm**, **0.80 mm**, **0.90 mm**, or **1.20 mm**.
- **Ohm/mi** or **Ohm/km** is the resistance constant of the cable per unit length. Specify maximum of five characters.
- **Len.** is the length of the cable under test. Specify a maximum of four characters.
- **Temp.** is a temperature of the cable under test. Specify a maximum of three characters. Default is 60F or 20C.
- **L.Coil** specifies the presence or absence of load coil in the cable section. The choices are **YES** or **NO**.

Sect.	Cable Type	Ohm/mi	Len.(ft)	Temp.(F)	L.Coil
1	AUTO	277.0	0	68	NO
2	AUTO	277.0	0	68	NO
3	AUTO	277.0	0	68	NO
4	AUTO	277.0	0	68	NO
5	AUTO	277.0	0	68	NO

Fault Location Tests

RFL Separate Good Pair (4 wire) Test

To set parameter values:

- 1.** To configure a section of cable for the test, press the up/down arrow keys to highlight the section icon then press ✓ to enable the section.
To disable a section, highlight the section icon then press ✓.
- 2.** Use the left/right arrow keys to highlight each parameter and press ✓ to open the list or select the value.
- 3.** Press the up/down arrow key to highlight the desired value.

OR

Press the left arrow key to erase the existing value, and then use the alphanumeric keypad to enter a value. To cancel the entry, press ↩.

- 4.** Press ✓ to accept the value.
- 5.** Set other parameters as necessary.
- 6.** Configure other sections of the cable as required.
- 7.** Press ↻ to start/stop the test.

Connection Diagram

The **Connection Diagram** tab displays how to connect the cables to the unit.

Continue button allows you to resume the test once the cables have been connected.

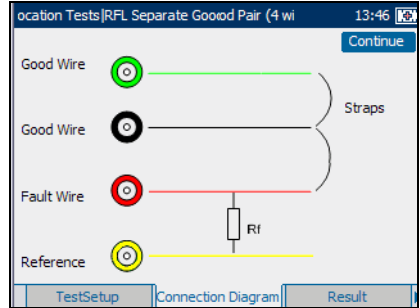

Result

The **Result** tab allows you to view detailed results of the RFL test.

[RFL-4 Wires] Test Results		
Distance to fault:	18.148 kft	149.5 Ω
Distance from fault to end:	12.116 kft	99.8 Ω
Distance to end:	30.264 kft	249.3 Ω
Fault located in section:	1	
Resistance at fault:	21.39 M Ω	
Voltage at fault:	-1.1 V	

Fault Location Tests

Loop Mapper Test

Loop Mapper Test

The LoopMapper test allows you to easily identify faults in the cable with increased resolution using time domain reflectometry (TDR) and frequency domain reflectometry (FDR). This test is extremely useful in locating bridge taps and the end of the cable. Faults such as open ends and shorted ends can be easily found using the enhanced resolution of the FDR test.

Note: This test is only available if LoopMapper is enabled in the software options.

Test Setup

The **Test Setup** tab allows you to configure parameters for the Loop Mapper test.

Define the **Cable Type** by selecting the gauge of the cable in use. If wire gauge is measured in AWG units, the available choices are: **AUTO, 19 AWG, 22 AWG, 24 AWG, or 26 AWG**. For mm gauge wire, the available choices are: **AUTO, 0.32 mm, 0.40 mm, 0.50 mm, 0.60 mm, 0.65 mm, 0.80 mm, 0.90 mm, or 1.20 mm**.

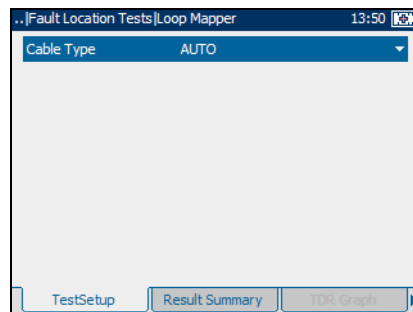

To set parameter values and start/stop the test:

1. Press ✓ to display the list.
2. Use the up/down arrow key to highlight the desired value, and press ✓ to accept the value.
3. Press ↻ to start/stop the test.

Result Summary

The **Result Summary** tab allows you to view results of the Loop Mapper test in graphical and text form.

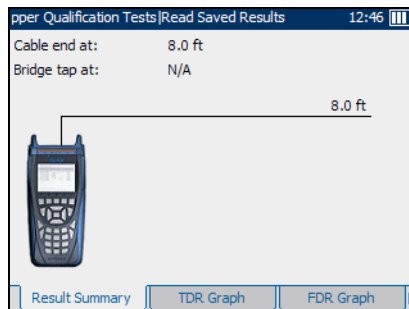

TDR Graph

The **TDR Graph** tab allows you to view results of the high resolution TDR test methodology used in the Loop Mapper test. **TDR** first attempts to find the length of the circuit and then searches all ranges from shortest to longest for significant events. Upon completion, the test selects the nearest major event, sets the range to match, and aligns the cursor with the event.

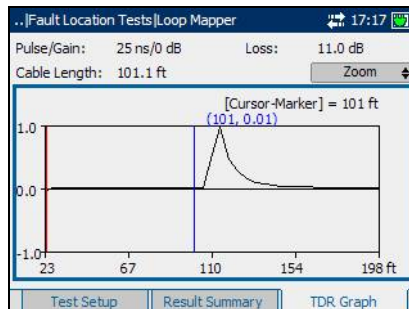

To make **TDR** adjustments via the keypad:

1. Press ✓ to change the mode button (top-right corner of the pane) and function of the up/down arrow keys.
2. Press ✓ repeatedly to cycle between:
 - Zoom
 - Gain
 - Pulse Gain (Pulse Width & Gain)
 - Range
 - Cursor and Marker Selection

Fault Location Tests

Loop Mapper Test

To measure the distance/duration between reflections:

1. Press  to cycle the mode and change to **CursorMarker**.
2. Press the left/right arrow keys to position the blue cursor (indicated by the blue color of data above cursor).
3. Press the up arrow key to select the red marker.
4. Press the left/right arrow keys to position the marker.
5. The difference between the cursor and marker is continuously updated and is indicated with a triangle (delta symbol) above the graph.

To zoom in/out:

1. Press  to select the **Zoom** function. Default mode is **Zoom**.
2. Press the up/down arrow keys to increase/decrease **Zoom** function. The graphical display zooms in or out accordingly.

FDR Graph

The **FDR Graph** tab allows you to view results of the high resolution FDR test methodology used in the Loop Mapper test.

The list and buttons on the tab are described below:

- (Zoom function List) allows you to select the desired zoom function: **Horizontal Zoom** or **Vertical Zoom**. The selected function is displayed in the box.
- **Zoom In** allows you to increase the level of zoom for the selected zoom function.
- **Zoom Out** allows you to reduce the level of zoom for the selected zoom function.

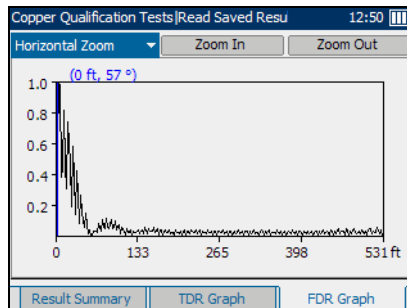

To zoom in/out:

1. Press ✓ to display a list of zoom functions.
2. Press the up/down arrow key to highlight the desired zoom function.
3. Press ✓ to select the zoom function.
4. Use the left/right arrow key to highlight the **Zoom In** or **Zoom Out** button as required, then press ✓.
5. The graphical display zooms in or out accordingly. Press ✓ repeatedly to continue zooming.

To move the screen pointer:

Press the left/right arrow key to move the screen pointer. The pointer value updates dynamically.

8 **Wideband Tests**

Wideband tests allow you to perform cable qualification checks on the circuit in the frequency range above 20 kHz. Wideband tests include the following:

- Receive tone (RX)
- Send tone (TX)
- PSD noise
- Spectral detective
- Impulse noise
- Impulse noise histogram
- Attenuation
- Longitudinal balance
- Data rate prediction

Note: Tests above 2.2 MHz are only available if VDSL2WB option is installed.

To view the wideband test tabs:

1. From the **Wideband Tests** pane use the up or down arrow key to highlight the desired test, then press ✓.
2. Press the F1, F2, or F3 key to view available tabs. To view any available additional tabs, use the function arrow keys on either side of the F1 and F3 keys.

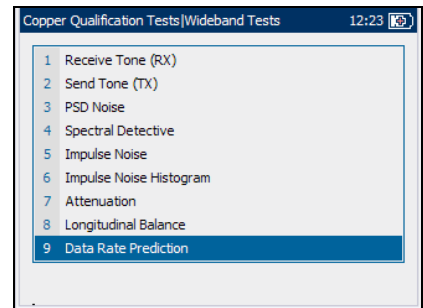

Wideband Tests

Receive Tone (RX)

Receive Tone (RX)

The wideband **Receive Tone (RX)** test allows you to configure and measure the level and frequency of incoming signals.

Each parameter is described below.

- **Termination** defines if the unit uses normal test impedance termination or high bridging impedance when the cable is active or terminated by other external equipment. For normal test termination select **TERMINATED**, otherwise select **BRIDGING**.
- **Termination Impedance** defines the impedance of the dummy load connected to the line. Select either **100 Ohms** or **135 Ohms**.

To start/stop the test:

1. Press the up/down arrow keys to highlight the desired test parameter.
2. Press ✓ to open the list.
3. Press the up/down arrow keys to highlight the desired value, then press ✓ to select it.
4. Select other parameters as required.
5. Press ↻ to start/stop the test.

Test results are displayed on the screen as they are completed.

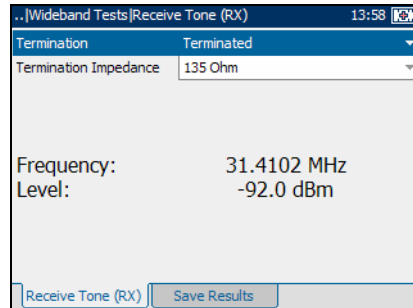

Send Tone (TX)

The wideband **Send Tone (TX)** test allows you to configure and transmit a tone to a downstream device in the loop.

Each parameter and button on the pane is described below.

- **Frequency (kHz)** is the frequency of the transmitting tone. Specify a value between **20** and **30000**.
- **Level (dBm)** is the tone level. Specify a value between **-10** and **10**.
- **Termination Impedance** defines the impedance of the dummy load connected to the line. Select either **100** or **135 Ohms**.
- **Apply** is used to confirm any changes to parameter values.

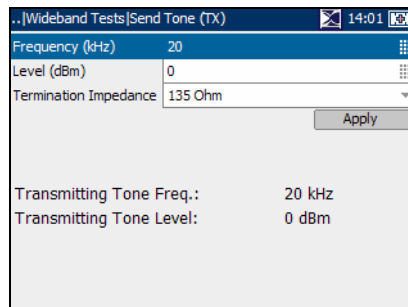

To start/stop test:

1. Press the up/down arrow keys to highlight the desired test parameter.
2. Press ✓ to select the value.
3. Press the left arrow key to erase the existing value, and then use the alphanumeric keypad to enter a value. To cancel the entry, press ↶.
4. Press ✓ to accept the value.
5. Change other parameter values as required.
6. Press the right arrow key, then use the up/down arrow key to highlight the **Apply** button. Press ✓ to confirm any changes.
7. Press ↻ to start/stop the test.

Test results are displayed on the screen as they are completed.

PSD Noise

The wideband power spectral density (PSD) noise test measures the noise energy at a point in a noise spectrum. It is expressed as power per hertz at a point in a noise spectrum.

Test Setup

The **Test Setup** tab allows you to configure the parameters for the wideband PSD noise test.

Each parameter on the pane is described below.

- **Bandwidth** specifies the frequency range for the test. Select **2.2 MHz**, **12 MHz**, **17 MHz**, or **30 MHz**.

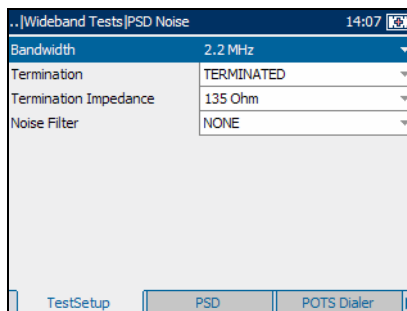

Note: *Frequency bands in excess of 2.2 MHz are only displayed if VDSL2WB is enabled in the software options.*



- **Termination** defines if the unit uses normal test impedance termination or high bridging impedance when the cable is active or terminated by other external equipment. For normal test termination select **TERMINATED**, otherwise select **BRIDGING**.
- **Termination Impedance** defines the impedance of the dummy load connected to the line. Select either **100** or **135 Ohm**.
- **Noise Filter** defines the level of wideband noise filtering. The available choices are: **NONE**, **50 kbit**, **ISDN-E**, **HDSL-F**, **ADSL-G**, **ADSL**, **ADSL2+**, **VDSL**, **VDSL2-8**, **VDSL2-12**, **VDSL2-17**, or **VDSL2-30**.

Note: *VDSL2-x filters are only available if VDSL2WB is enabled in the software options.*

To start/stop the test:

1. Press the up/down arrow keys to highlight the desired test parameter.
2. Press  to open the list.
3. Press the up/down arrow keys to highlight the desired value, then press  to select it.
4. Press  to start/stop the test.

PSD Noise

The **PSD Noise** tab allows you to view results of the wideband PSD noise test in graphical and text form.

The list and buttons on the pane are described below:

- (Zoom function List) allows you to select the desired zoom function: **Horizontal Zoom** or **Vertical Zoom**. The selected function is displayed in the box.
- **Zoom In** allows you to increase the level of zoom for the selected zoom function.
- **Zoom Out** allows you to reduce the level of zoom for the selected zoom function.
- **Peak** allows you to measure the peak PSD noise value, compare it against the previous value, and display the maximum value. This button is only available when the test is running. Toggle between **Peak** and **Normal**.

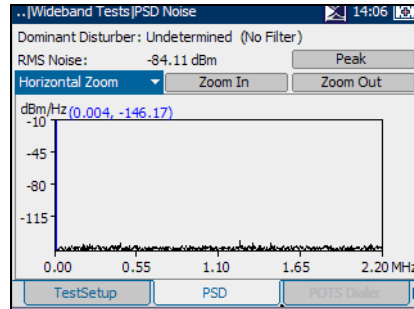

To zoom in/out:

1. Press ✓ to display a list of zoom functions.
2. Press the up/down arrow key to highlight the desired zoom function.
3. Press ✓ to select the zoom function.
4. Use the left/right arrow key to highlight the **Zoom In** or **Zoom Out** button as required, then press ✓.
5. The graphical display zooms in or out accordingly. Press ✓ repeatedly to continue zooming.

To move the screen pointer:

Press the left/right arrow key to move the screen pointer. The pointer value updates dynamically.

Spectral Detective Test

The wideband spectral detective test allows you to bridge onto a live circuit to measure the PSD noise of the line. The spectral detective test measures up to 2.2 MHz (optionally up to 30 MHz with VDSL2WB option) so you can determine the xDSL technology that is being transmitted over the line, and the power associated with the transmitted technology to ensure it is not disruptive to adjacent cables and technologies.

Test Setup

The **Test Setup** tab allows you to configure parameters for the wideband spectral detective test.

Each parameter on the pane is described below.

- **Bandwidth** specifies the frequency range for the test. Select **2.2 MHz**, **12 MHz**, **17 MHz**, or **30 MHz**.

Note: *Frequency bands in excess of 2.2 MHz are only displayed if VDSL2WB is enabled in the software options.*

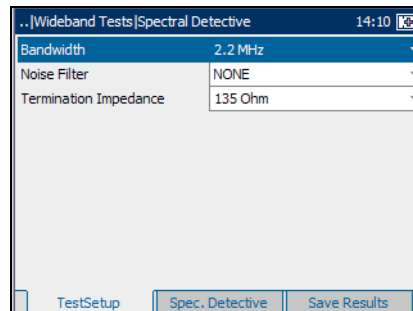



- **Noise Filter** defines the level of wideband noise filtering. The available choices are: **NONE**, **50 kbit**, **ISDN-E**, **HDSL-F**, **ADSL-G**, **ADSL**, **ADSL2+**, **VDSL**, **VDSL2-8**, **VDSL2-12**, **VDSL2-17**, or **VDSL2-30**.

Note: *VDSL2-x filters are only available if VDSL2WB is enabled in the software options.*

- **Termination Impedance** defines the resistive impedance of the dummy load connected to the line. Select one of the following: **100** or **135 Ohm**.

To start/stop the test:

1. Press the up/down arrow keys to highlight the desired test parameter.
2. Press  to open the list.
3. Press the up/down arrow keys to highlight the desired value, then press  to select it.
4. Press  to start/stop the test.

Wideband Tests

Spectral Detective Test

Spectral Detective

The **Spectral Detective** tab allows you to view results of the wideband spectral detective test in graphical and text form.

The list and buttons on the tab are described below:

- (Zoom function List) allows you to select the desired zoom function: **Horizontal Zoom** or **Vertical Zoom**. The selected function is displayed in the box.
- **Zoom In** allows you to increase the level of zoom for the selected zoom function.
- **Zoom Out** allows you to reduce the level of zoom for the selected zoom function.

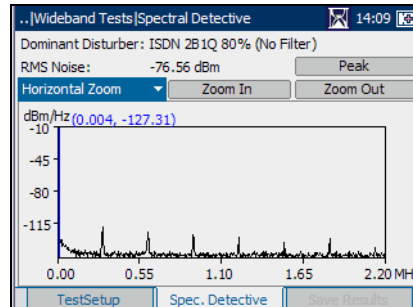

To zoom in/out:

1. Press ✓ to display a list of zoom functions.
2. Press the up/down arrow key to highlight the desired zoom function.
3. Press ✓ to select the zoom function.
4. Use the left/right arrow key to highlight the **Zoom In** or **Zoom Out** button as required, then press ✓.
5. The graphical display zooms in or out accordingly. Press ✓ repeatedly to continue zooming.

To move the screen pointer:

Press the left/right arrow key to move the screen pointer. The pointer value updates dynamically.

Impulse Noise Test

The wideband impulse noise test allows you to measure impulse noise on the circuit under test.

Test Setup

The **Test Setup** tab allows you to configure parameters for the wideband impulse noise test.

Each parameter on the pane is described below.

- **Termination** defines if the unit uses normal test impedance termination or high bridging impedance when the cable is active or terminated by other external equipment. For normal test termination select

TERMINATED, otherwise select **BRIDGING**.

- **Termination Impedance** defines the impedance of the dummy load connected to the line. Select one of the following: **100** or **135 Ohm**.
- **Noise Filter** defines the level of wideband noise filtering. The available choices are: **NONE**, **50 kbit**, **ISDN-E**, **HDSL-F**, **ADSL-G**, **ADSL**, **ADSL2+**, **VDSL**, **VDSL2-8**, **VDSL2-12**, **VDSL2-17**, or **VDSL2-30**.

Note: *VDSL2-x filters are only available if VDSL2WB is enabled in the software options.*



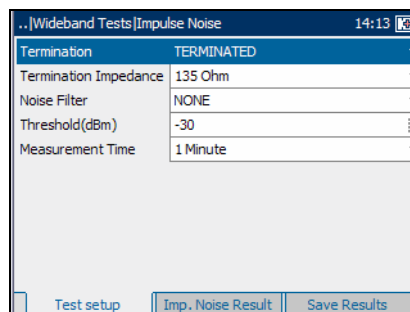

- **Threshold(dBm)** is the maximum impulse noise level. Specify a value between **-50** and **0** (-40 and 0 if any filter applied).
- **Measurement Time** defines the duration of the Impulse Noise test. The available choices are: **1**, **5**, **15**, or **60 Minutes**, or **24 Hours**.



Wideband Tests

Impulse Noise Test

To start/stop the test:

1. Press the up/down arrow keys to highlight the desired test parameter.
2. Press  to open the list or specify a value.
3. Press the up/down arrow keys to highlight the desired value.
OR
4. Press the left/right arrow keys to erase the existing value, and then use the alphanumeric keypad to enter a value. To cancel the entry, press .
5. Press  to accept the value.
6. Select other parameters as required.
7. Press  to start/stop the test.

Impulse Noise Result

The **Imp. Noise Result** tab allows you to view results of the wideband impulse noise test in text form.

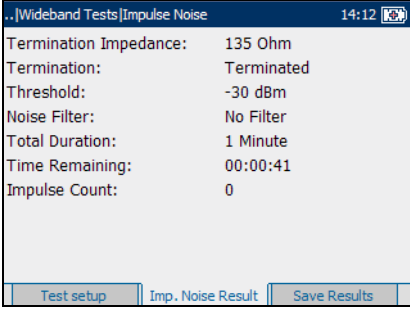

..[Wideband Tests]Impulse Noise		14:12
Termination Impedance:	135 Ohm	
Termination:	Terminated	
Threshold:	-30 dBm	
Noise Filter:	No Filter	
Total Duration:	1 Minute	
Time Remaining:	00:00:41	
Impulse Count:	0	

Test setup | Imp. Noise Result | Save Results

Impulse Noise Histogram

The wideband impulse noise histogram test displays a plot of the impulse noise spikes over a user-defined time period.

Test Setup

The **Test Setup** tab allows you to configure parameters for the wideband impulse noise histogram test.

Each parameter on the pane is described below.

- **Termination** defines if the unit uses normal test impedance termination or high bridging impedance when the cable is active or terminated by other external equipment. For normal test termination select

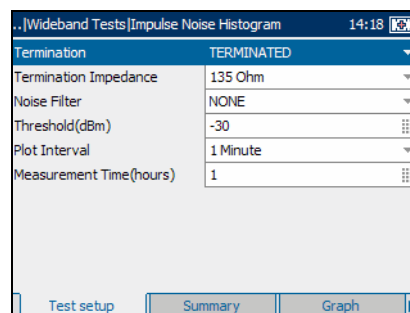

TERMINATED, otherwise select **BRIDGING**.

- **Termination Impedance** defines the impedance of the dummy load connected to the line. Select either **100** or **135 Ohm**.
- **Noise Filter** defines the level of wideband noise filtering. The available choices are: **NONE**, **15 kHz**, **50 kbit**, **ISDN-E**, **HDSL-F**, **ADSL-G**, **ADSL**, **ADSL2+**, **VDSL**, **VDSL2-8**, **VDSL2-12**, **VDSL2-17**, or **VDSL2-30**.

Note: *VDSL2-x filters are only available if VDSL2WB is enabled in the software options.*

- **Threshold(dBm)** is the maximum impulse noise level. Specify a value between **-50** and **0** (-40 and 0 if any filter applied).

Wideband Tests

Impulse Noise Histogram

- **Plot Interval** defines the baseline time duration for measuring impulse noise spikes, and represents the resolution of the plot. Select one of the following: **1, 5, 15, or 60 Minutes**.
- **Measurement Time (hours)** defines the duration of the Impulse Noise Histogram test. Specify a value between **1** and **360** hours.

To start/stop the test:

1. Press the up/down arrow keys to highlight the desired test parameter.
2. Press ✓ to open the list or specify a value.
3. Press the up/down arrow keys to highlight the desired value.

OR

4. Press the left/right arrow keys to erase the existing value, and then use the alphanumeric keypad to enter a value. To cancel the entry, press ↵.
5. Press ✓ to accept the value.
6. Select other parameters as required.
7. Press ↻ to start/stop the test.

Summary

The **Summary** tab allows you to view results of the wideband impulse noise histogram test in text form.

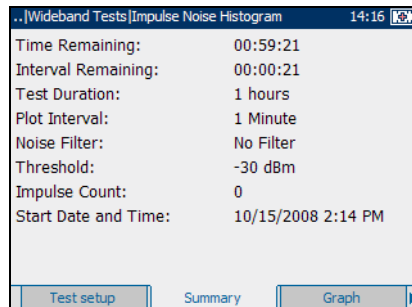

.. [Wideband Tests] Impulse Noise Histogram		14:16
Time Remaining:	00:59:21	
Interval Remaining:	00:00:21	
Test Duration:	1 hours	
Plot Interval:	1 Minute	
Noise Filter:	No Filter	
Threshold:	-30 dBm	
Impulse Count:	0	
Start Date and Time:	10/15/2008 2:14 PM	

Test setup Summary Graph

Graph

The **Graph** tab allows you to view results of the wideband impulse noise histogram test in graphical form.

The buttons on the pane are described below:

- **Zoom In** allows you to increase the level of zoom for the selected zoom function.
- **Zoom Out** allows you to reduce the level of zoom for the selected zoom function.

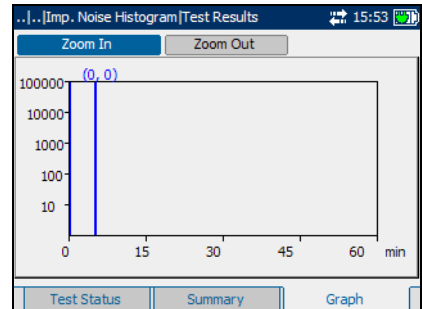

To zoom in or out:

1. Use the left or right arrow key to highlight the **Zoom In** or **Zoom Out** button as required, then press ✓.
2. The graphical display zooms in or out accordingly. Press ✓ repeatedly to continue zooming.

To move the screen pointer:

Press the left/right arrow key to move the screen pointer. The pointer value updates dynamically.

Wideband Tests

Attenuation Test

Attenuation Test

The wideband attenuation test allows you to measure the dissipation of power of a transmitted signal as it travels over the copper line.

Test Setup

The **Test Setup** tab allows you to configure parameters for the wideband attenuation test.

Select the **Bandwidth** of the frequency range for the test:

2.2, 12, 17, or 30 MHz.

Note: *Frequency bands in excess of 2.2 MHz are only displayed if VDSL2WB is enabled in the software options.*

To start/stop the test:

1. Press ✓ to open the list.
2. Press the up/down arrow keys to highlight the desired value, then press ✓ to select it.
3. Press ↻ to start/stop the test.

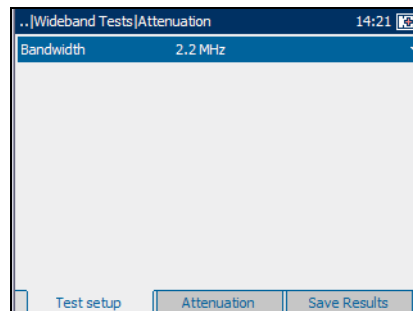

Attenuation

The **Attenuation** tab allows you to view results of the wideband attenuation test in graphical form.

The list and buttons on the tab are described below:

- (Zoom function List) allows you to select the desired zoom function: **Horizontal Zoom** or **Vertical Zoom**. The selected function is displayed in the box.
- **Zoom In** allows you to increase the level of zoom for the selected zoom function.
- **Zoom Out** allows you to reduce the level of zoom for the selected zoom function.

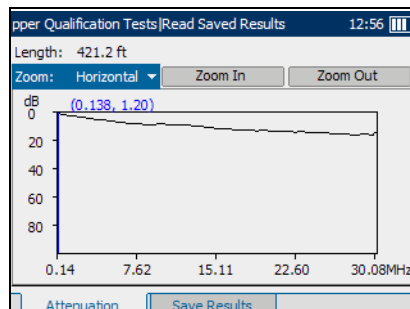

To zoom in/out:

1. Press ✓ to display a list of zoom functions.
2. Press the up/down arrow key to highlight the desired zoom function.
3. Press ✓ to select the zoom function.
4. Use the left/right arrow key to highlight the **Zoom In** or **Zoom Out** button as required, then press ✓.
5. The graphical display zooms in or out accordingly. Press ✓ repeatedly to continue zooming.

To move the screen pointer:

Press the left/right arrow key to move the screen pointer. The pointer value updates dynamically.

Longitudinal Balance

The wideband longitudinal balance test ensures that the longitudinal balance ratio for the twisted pair complies with applicable standards so as to reduce the effects of common-mode voltage to ground. The better the longitudinal balance of the cable pair, the higher the dB reading.

Test Setup

The **Test Setup** tab allows you to configure parameters for the wideband longitudinal balance test.

Each parameter on the pane is described below.

- **Bandwidth** specifies the frequency range for the test. Select **2.2 MHz**, **12 MHz**, **17 MHz**, or **30 MHz**.

Note: *Frequency bands in excess of 2.2 MHz are only displayed if VDSL2WB is enabled in the software options.*

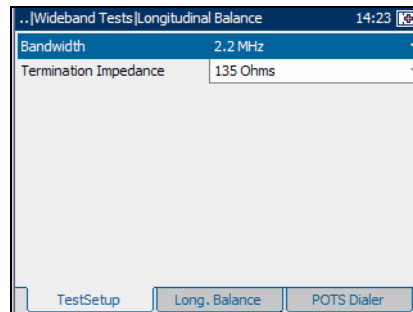

- **Termination Impedance** defines the impedance of the dummy load connected to the line. Select one of the following: **100 Ohms** or **135 Ohms**.

To start/stop the test:

1. Press the up/down arrow keys to highlight the desired test parameter.
2. Press ✓ to open the list.
3. Press the up/down arrow keys to highlight the desired value, then press ✓ to select it.
4. Press ↻ to start/stop the test.

Longitudinal Balance

The **Long. Balance** tab allows you to view results of the wideband longitudinal balance test in graphical form.

The buttons on the tab are described below:

- (Zoom function List) allows you to select the desired zoom function: **Horizontal Zoom** or **Vertical Zoom**. The selected function is displayed in the box.
- **Zoom In** allows you to increase the level of zoom for the selected zoom function.
- **Zoom Out** allows you to reduce the level of zoom for the selected zoom function.

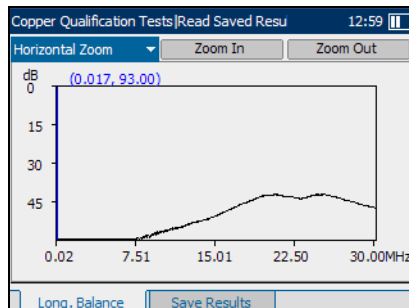

To zoom in/out:

1. Press ✓ to display a list of zoom functions.
2. Press the up/down arrow key to highlight the desired zoom function.
3. Press ✓ to select the zoom function.
4. Use the left/right arrow key to highlight the **Zoom In** or **Zoom Out** button as required, then press ✓.
5. The graphical display zooms in or out accordingly. Press ✓ repeatedly to continue zooming.

To move the screen pointer:

Press the left/right arrow key to move the screen pointer. The pointer value updates dynamically.

Data Rate Prediction

The data rate prediction test is based on measurements of PSD noise and attenuation. Considering the fact that all estimates are done from the single end of the loop, the created report will be presented as a prediction with reasonable probability.

DSL Rate

The **DSL Rate** tab allows you to configure parameters and view results for the current loop topology. The data rate prediction (DRP) test displays the calculated downstream and upstream rates.

Each parameter on the pane is described below.

- **Annex** defines the modes of available ADSL Annexes from the ITU standards.
 - **A** is ADSL service functioning over POTS.
 - **B** activates the ADSL functionality over ISDN.
 - **L Mask 1** assumes an increase in ADSL2 range/distance.
 - **L Mask 2** also extends the signal reach but can show an improvement in the upstream data rate.
 - **M** allows increased upload speeds from 1 Mbps to 3.5 Mbps. Available only for ADSL2 and ADSL2+.
- **Technology** lists the following values: **ADSL**, **ADSL2**, or **ADSL2+**. If **Annex L** is previously selected, **ADSL2** is automatically set. If **Annex M**, **ADSL** is not available.

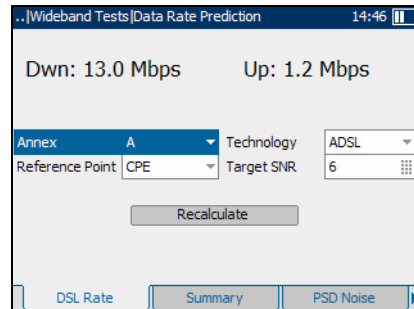

- **Reference Point** is either **CO** or **CPE**, allowing you to select from which end of the circuit you are running the DRP test. **CO** is located at the CO/Exchange side and you are testing towards the subscriber. **CPE** is the subscriber side and you are testing towards the CO/Exchange.
- **Target SNR** is the desired signal-to-noise ratio ranging from 0 to 31 dB. Default value is 6 dB.
- **Recalculate** button allows you to change the setup and re-evaluate the rates.

To re-set parameters to view different results:

1. Press the up/down or left/right arrow keys to highlight the desired parameter.
2. Press ✓ to display the list or select the value.
3. Press the up/down arrow keys to highlight the desired value.
OR
4. Press the left arrow key to erase the existing value, and then use the alphanumeric keypad to enter a value. To cancel the entry, press ↩.
5. Press ✓ to accept the value.
6. Press the up/down arrow keys to highlight the **Recalculate** button.
7. Press ✓ to recalculate rates for the new setup.

Summary

The **Summary** tab allows you to view results, change some of the variables and **Recalculate** the results.

Each parameter on the pane is described below.

- **Annex** defines the modes of available ADSL Annexes from the ITU standards.
 - **A** is ADSL service functioning over POTS.
 - **B** activates the ADSL functionality over ISDN.
 - **L Mask 1** assumes an increase in ADSL2 range/distance.
 - **L Mask 2** also extends the signal reach but can show an improvement in the upstream data rate.
 - **M** allows increased upload speeds from 1 Mbps to 3.5 Mbps. Available only for ADSL2 and ADSL2+.
- **Technology** lists the following values: **ADSL**, **ADSL2**, or **ADSL2+**. If **Annex L** is previously selected, **ADSL2** is automatically set. If **Annex M**, **ADSL** is not available.
- **Reference Point** is either **CO** or **CPE**, allowing you to select from which end of the circuit you are running the DRP test. **CO** is located at the CO/Exchange side and you are testing towards the subscriber. **CPE** is the subscriber side and you are testing towards the CO/Exchange.
- **Target SNR** is the desired signal-to-noise ratio ranging from 0 to 31 dB. Default value is 6 dB.
- **Recalculate** button allows you to change the setup and re-evaluate the rates.

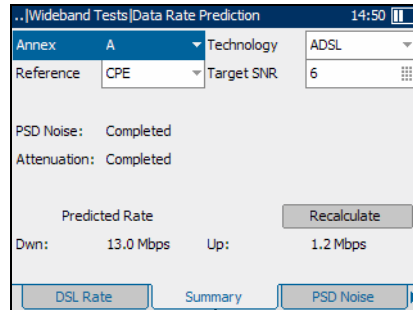

To re-set parameters to view different results:

1. Press the up/down or left/right arrow keys to highlight the desired parameter.
2. Press ✓ to display the list or select the value.
3. Press the up/down arrow keys to highlight the desired value.

OR

4. Press the left arrow key to erase the existing value, and then use the alphanumeric keypad to enter a value. To cancel the entry, press ↩.
5. Press ✓ to accept the value.
6. Press the up/down arrow keys to highlight the **Recalculate** button.
7. Press ✓ to recalculate rates for the new setup.

PSD Noise

The **PSD Noise** tab identifies the presence of disturber signals when no filter is selected as **Dominant Disturber** and the **RMS Noise** value from the power spectral density (PSD) noise tests in text and graphical form. RMS noise voltage measures the signal-to-noise ratio of the circuit.

The list and buttons on the tab are described below:

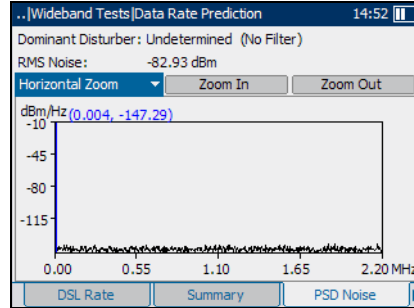

- (Zoom function List) allows you to select the desired zoom function: **Horizontal Zoom** or **Vertical Zoom**. The selected function is displayed in the box.
- **Zoom In** allows you to increase the level of zoom for the selected zoom function.
- **Zoom Out** allows you to reduce the level of zoom for the selected zoom function.

To zoom in or out:

1. Press ✓ to display a list of zoom functions.
2. Press the up/down arrow keys to highlight the desired zoom function.
3. Press ✓ to select the zoom function.
4. Use the left/right arrow keys to highlight the **Zoom In** or **Zoom Out** button as required, then press ✓.

The graphical display zooms in or out accordingly.

5. Press ✓ repeatedly to continue zooming.

To move the screen pointer:

Press the left/right arrow keys to move the screen pointer. The pointer value updates dynamically.

Attenuation

The **Attenuation** tab displays the wideband attenuation test results in graphical form.

The list and buttons on the tab are described below:

- (Zoom function List) allows you to select the desired zoom function: **Horizontal Zoom** or **Vertical Zoom**. The selected function is displayed in the box.

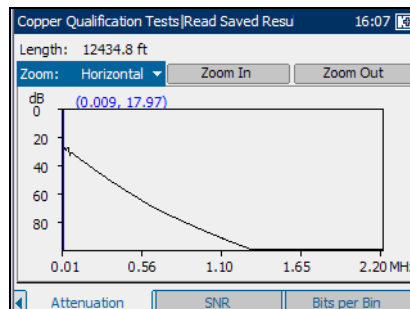

- **Zoom In** allows you to increase the level of zoom for the selected zoom function.
- **Zoom Out** allows you to reduce the level of zoom for the selected zoom function.

To zoom in/out:

1. Press ✓ to display a list of zoom functions.
2. Press the up/down arrow key to highlight the desired zoom function.
3. Press ✓ to select the zoom function.
4. Use the left/right arrow key to highlight the **Zoom In** or **Zoom Out** button as required, then press ✓.
5. The graphical display zooms in or out accordingly. Press ✓ repeatedly to continue zooming.

To move the screen pointer:

Press the left/right arrow key to move the screen pointer. The pointer value updates dynamically.

Signal-to-Noise Ratio

The **SNR** tab displays the signal-to-noise ratio per tone in graphical form.

The list and buttons on the tab are described below:

- (Zoom function List) allows you to select the desired zoom function: **Horizontal Zoom** or **Vertical Zoom**. The selected function is displayed in the box.

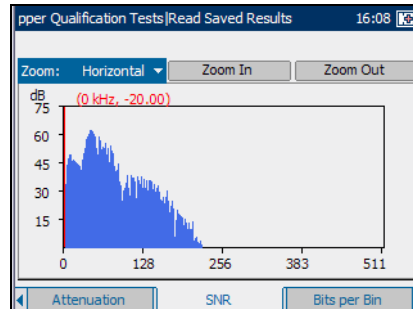

- **Zoom In** allows you to increase the level of zoom for the selected zoom function.
- **Zoom Out** allows you to reduce the level of zoom for the selected zoom function.

To zoom in or out:

1. Press **✓** to display a list of zoom functions.
2. Press the up/down arrow keys to highlight the desired zoom function.
3. Press **✓** to select the zoom function.
4. Use the left/right arrow keys to highlight the **Zoom In** or **Zoom Out** button as required, then press **✓**.

The graphical display zooms in or out accordingly.

5. Press **✓** repeatedly to continue zooming.

To move the screen pointer:

Press the left/right arrow keys to move the screen pointer. The pointer value updates dynamically.

Bits per Bin

The **Bits per Bin** tab displays in graphical form the number of bits that can be transmitted on a particular bin representing a certain tone.

- **Zoom In** allows you to increase the level of zoom for the selected zoom function.
- **Zoom Out** allows you to reduce the level of zoom for the selected zoom function.

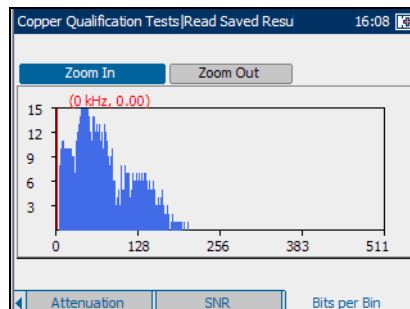

To zoom in or out:

1. Press the up or down arrow key to highlight the desired zoom function.
2. Press ✓ to select the zoom function.
3. Use the left or right arrow key to highlight the **Zoom In** or **Zoom Out** button as required, then press ✓.

The graphical display zooms in or out accordingly.

4. Press ✓ repeatedly to continue zooming.

To move the screen pointer:

Press the left/right arrow keys to move the screen pointer. The pointer value updates dynamically.

9

Getting Started with DSL and Ethernet Testing

The AXS-200/635 not only verifies service and connectivity to the DSLAM, but also executes upstream and downstream performance measurements such as actual data rates, attenuation, and noise margin. In addition, it provides advanced IPTV measurements such as packet jitter and loss, PCR jitter, MDI, PID viewer and IGMP zap time; and also supports higher layer testing such as ping, traceroute and Web download speed.

DSL/IP Tests

VDSL2, ADSL2+, and Ethernet tests include the Auto Test function, CPE tests and IPTV, data, and VoIP analyses.

DSL/IP Tests Menu

The **DSL/IP Tests** menu pane lists all the test capabilities of the unit.

To access the *DSL/IP tests*:

1. From the **Home** page, use the up or down arrow key to highlight **DSL/IP Tests**, then press ✓.
2. From the **DSL/IP Tests** pane, highlight the desired item and press ✓

OR

press the corresponding item number.

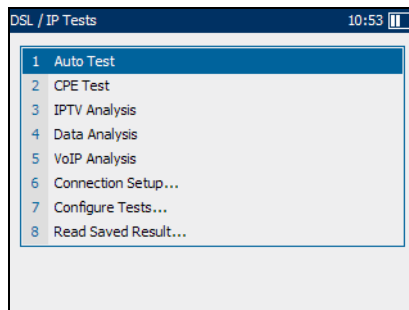

Getting Started with DSL and Ethernet Testing

DSL/IP Tests

When selected, each of the five tests starts, using the connection setup from the current profile.

- **Connection Setup** allows you to setup a series of connection parameters for Auto Test and CPE testing, IPTV, data, and VoIP analyses beginning with the **Selected Profile** tab.
- **Configure Tests** allows you to configure a series of test parameters to verify applications, beginning with **Auto Test**.
- **Read Saved Result** allows you to view the **Read Results** page.

Read Saved Results

The **Read Results** pane tab allows you to select a test type and view the results of all the files previously saved.

Types listed include the following **Ethernet** and **DSL** tests:

- **CPE Test**
- **IPTV Analysis**
- **Data Analysis**
- **VoIP Analysis**

To open previously saved test results:

1. Press ✓ to open the list.
2. In the list, press the up/down arrows to select the test type.
3. Press ✓ to confirm the selection.
4. Press the down arrow to activate the **Result Files** list box and press ✓ to display the list of available files.
5. Press the up/down arrows to select the desired result file.
6. Press ✓ to view the selection.

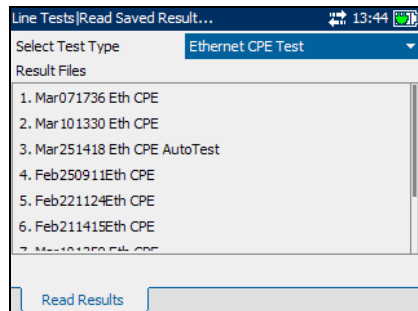

10 **Connection Setup for DSL/IP Triple-Play Verification Tests**

The purpose of the **Connection Setup** function is to configure the unit for a series of connection parameters for Auto Test and CPE testing, and IPTV, data, and VoIP analyses. These parameters are accessible through the different pane tabs.

To configure the connection parameters during DSL/IP tests:

1. From the **DSL/IP Tests** pane, use the up/down arrows to select the **Connection Setup** entry.
2. Press  to confirm the selection.

To view the available tabs:

Press the left/right function arrows on each side of the F1, F2, and F3 keys.

Setup Profile

Profiles can be created and stored in the internal memory for later use. They can also be stored externally or exported to another unit via a USB memory device or HyperTerminal. You can easily load an external profile through the USB port and a HyperTerminal.

Selected Profile

The **Selected Profile** tab allows you to configure and store multiple profiles containing specific setups for the unit. The default settings for current profile are: **Profile Name** is **Default**; **LineMode** is **Ethernet**; and **AccessMode** is **Bridged**.

- **Profile Name** is a list of all available profile files in the current directory with the first entry being **Default**. Once you open the selected profile, it remains active in the unit until a different or newer profile is selected. You can store over 100 profiles.
- **Line Mode** is **ADSL2+**, **VDSL2**, **HPNA-coax** or **Ethernet**. If you select the **HPNA-coax Line Mode**, verify that the ARU-100 HPNA test probe is connected to the WAN port of your AXS-600 series module.

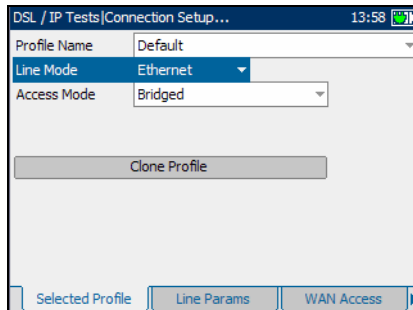

- **AccessMode** displays a list of values dependent on the **Line Mode** selection.
 - If **Line Mode** is set to **ADSL2+**, the listed values are:
 - Bridged**
 - Routed BrgdEthernet DHCP**
 - Routed BrgdEthernet Static**
 - Routed PPPoE**
 - Routed PPPoA**
 - Routed IPoA**
 - If **Line Mode** is set to **VDSL2**, the listed values are:
 - Bridged**
 - Routed BrgdEthernet DHCP**
 - Routed BrgdEthernet Static**
 - Routed PPPoE**
 - If **Line Mode** is set to **Ethernet** or **HPNA-coax**, the listed values are:
 - Bridged**
 - Routed Ethernet DHCP**
 - Routed Ethernet Static**
 - Routed PPPoE**
- **Clone Profile** allows you to copy an existing profile to a new profile and switch to use the new profile.

Connection Setup for DSL/IP Triple-Play Verification Tests

Setup Profile

When you change the selections, the following actions should be performed:

1. Fill the **ProfileName** list box with the list of files from the new directory \LineMode\AccessMode.
2. Change the **ProfileName** selection to **Default** if the profile file with the current **ProfileName** does not exist in the new directory.
3. Reload the current profile from the new profile file.

At power up, all settings are read from the last current profile.

- **Custom Profile** is the new name of the profile.

To save modifications made to a CustomProfile:

1. Select **Save as New Profile** and create and save a new **CustomProfile** name in the current directory \LineMode\AccessMode.
2. If the file with **CustomProfile** name already exists in the current directory, you will be prompted to overwrite it.

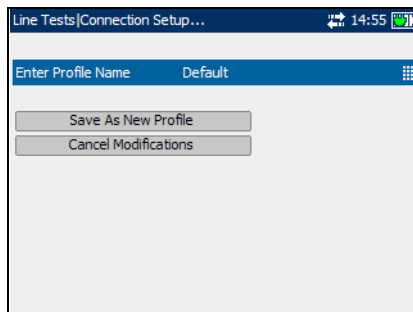

To cancel modifications made to a CustomProfile:

1. Select **Cancel Modifications** and reload the current profile with the default profile.
2. Proceed with the previously selected action (Back/Home/Start).

Setup Line Connection

Line Parameters

The **Line Params** tab allows you to set the basic DSL and Ethernet negotiation modes for a **Selected Profile** composed of the current **LineMode** and **AccessMode** selections.

When the **LineMode** selection is **ADSL2+**, the available parameters are the following:

- **Annex** defines the modes of available ADSL Annexes from the ITU standards.
 - **Annex A** is ADSL service functioning over POTS.
 - **Annex B** activates the ADSL functionality over *ISDN*.
 - **Annex M** allows increased upload speeds from 1 Mbps to 3.5 Mbps.
 - **Annex L** assumes an increase in ADSL range/distance.
- **VPI** is the virtual path identifier (VPI) ranging from 0 through 255 for the ATM connection.
- **VCI** is the virtual circuit identifier (VCI) ranging from 32 through 65535 for the ATM connection.

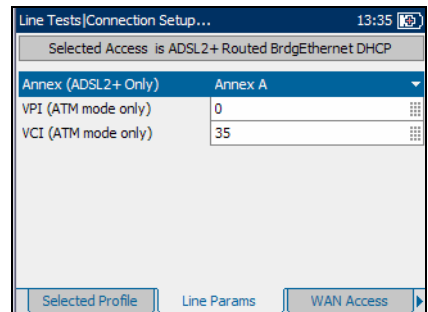

Connection Setup for DSL/IP Triple-Play Verification Tests

Setup Line Connection

When the **LineMode** selection is **Ethernet**, the available parameters are the following:

- **Link Speed** is a choice between **AUTO** (negotiated during the link establishment), **100** or **10 Mbps**.
- **Connect Mode** is **Full-duplex** or **Half-duplex**, when **Link Speed** is set to either **100** or **10 Mbps**.

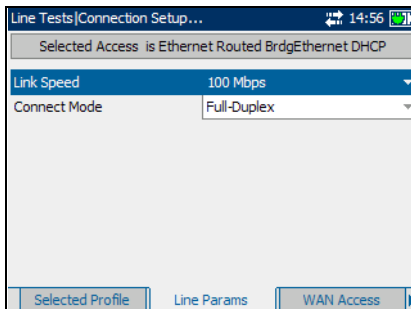

To select the line parameters to configure:

1. From the **Connection Setup** pane, press the left/right function arrows until the **Line Params** tab is displayed.
2. Press the F1, F2, or F3 key located just below the tab to select it.
3. Press the up/down arrows to select the desired parameter.
4. Press **✓** to open the list or modify the parameter.
5. In the list, press the up/down arrows to select the function or mode.
OR
Use the alphanumeric keypad to enter the value you want to specify.
6. Press **✓** to confirm the selection.

WAN Access

The **WAN Access** tab allows you to configure the physical line parameters required to connect to the ISP (internet service provider). The described **Selected Profile** is composed of the current **LineMode** and **AccessMode** selections.

The available parameters are the following:

- **Encapsulation Type** depends on the network configuration and sets the ATM to either **LLC** also known as LLC-SNAP (logical link control-sub network address control channel multiplex).
- **VLAN Support** enables the unit to analyze and pass WAN tagged ethernet frames through the virtual local area network (VLAN).
- **VLAN ID** is a virtual local area network (VLAN) tag ranging from 0 through 4094.
- **VLAN Priority** sets the priority of the virtual local area network (VLAN) with a value ranging from 0 through 7.
- **NAT** is the network address translation (NAT), which either enables the unit to use a public router address for all outgoing packets, or exposes the private LAN IP address to the WAN, if disabled.
- **IGMP** lists either **Version2** or **Version3** of the internet group management protocol (IGMP).

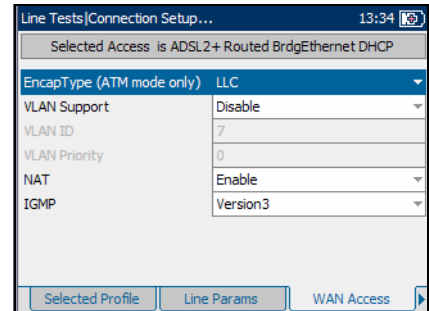

Connection Setup for DSL/IP Triple-Play Verification Tests

Setup Line Connection

To select the WAN access parameters to configure:

- 1.** From the **Connection Setup** pane, press the left/right function arrows until the **WAN Access** tab is displayed.
- 2.** Press the F1, F2, or F3 key located just below the tab to select it.
- 3.** Press the up/down arrows to select the desired parameter.
- 4.** Press ✓ to open the list or modify the parameter.
- 5.** In the list, press the up/down arrows to select the function or mode.

OR

Use the alphanumeric keypad to enter the value you want to specify.

- 6.** Press ✓ to confirm the selection.

WAN IP

The **WAN IP** tab allows you to configure the wide area network parameters required to connect to the ISP for a **Selected Profile** composed of the current **LineMode** and **AccessMode** selections.

When the **AccessMode** selection is set to **Routed BrgdEthernet DHCP**, the available parameters are the following:

- **Vendor ID** is the name of the unit, maximum 80 characters.
- **Local MAC Address** is the *internal MAC address* of the unit: either **AXS200** or **User Defined**.
- **MAC Address** is a specific **MAC address**, maximum 17 characters, if you select **User Defined** for the previous parameter.

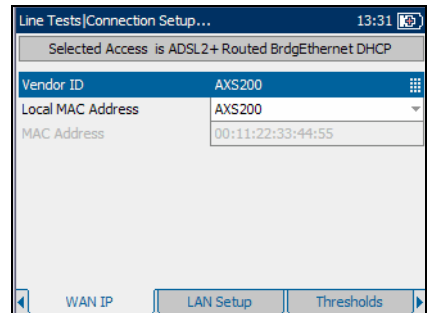

When the **AccessMode** selection is set to **Routed BrgdEthernet Static**, the available parameters are the following:

- **IP Address** is the address for the unit that is actively connected to your network or the internet at the time of login.
- **Gateway** is the IP address of the default gateway.
- **Subnet Mask** is the network address used to identify if the IP address is within the same wide area network.
- **DNS1** is the address of the *primary* domain name server to be used by the unit. If DNS is unavailable, enter 0.0.0.0.

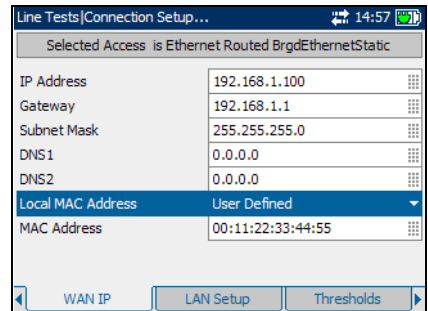

Connection Setup for DSL/IP Triple-Play Verification Tests

Setup Line Connection

- **DNS2** is the address of the *secondary* domain name server to be used by the unit. If DNS is unavailable, enter 0.0.0.0.
- **Local MAC Address** is the *internal* MAC address of the unit: either **AXS200** or **User Defined**.
- **MAC Address** is a specific MAC address, maximum 17 characters, if you select **User Defined** for the previous parameter.

When the **AccessMode** selection is set to **Routed PPPoE** or **Routed PPPoA**, the available parameters are the following:

- **Obtain IP** is either **Dynamic** where the access concentrator or broadband remote access server assigns a temporary IP address to the unit, or **Static** where you enter the IP address of the unit.
- **Static IP** is the address of the current location assigned by the service provider. This entry is unavailable if **Obtain IP** is set to **Dynamic**.
- **Login Name** is your user ID.
- **Password** is your user password.

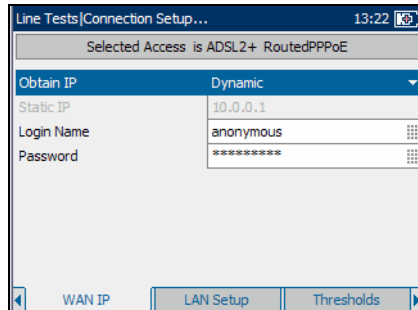

When the **AccessMode** selection is set to **Routed IPoA**, the available parameters are the following:

- **IP Address** is the address for the unit that is actively connected to your network or the internet at the time of login.
- **Gateway** is the IP address of the default gateway.

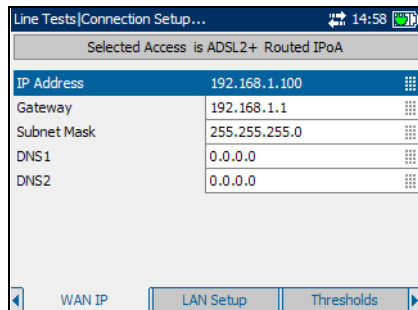

- **Subnet Mask** is the network address used to identify if the IP address is within the same wide area network.
- **DNS1** is the address of the *primary* domain name server to be used by the unit. If DNS is unavailable, enter 0.0.0.0.
- **DNS2** is the address of the *secondary* domain name server to be used by the unit. If DNS is unavailable, enter 0.0.0.0.

Note: *WAN IP setup is not required when Access Mode is set to Bridged. The line encapsulation setting defines the parameters required.*

To select the WAN IP parameters to configure:

1. From the **Connection Setup** pane, press the left/right function arrows until the **WAN IP** tab is displayed.
2. Press the F1, F2, or F3 key located just below the tab to select it.
3. Press the up/down arrows to select the desired parameter.
4. Press ✓ to open the list or modify the parameter.
5. In the list, press the up/down arrows to select the function or mode.

OR

Use the alphanumeric keypad to enter the value you want to specify.

6. Press ✓ to confirm the selection.

LAN Setup

The **LAN Setup** tab allows you to configure the parameters required when working in *Throughmode*, and the local area network (LAN) is connected to the ethernet interface. These parameters only apply when the WAN access mode is set to **Routed**. The described **Selected Profile** is composed of the current **LineMode** and **AccessMode** selections.

The available parameters are the following:

- **VLAN Tagging** enables the unit to recognize frames with a specified PVID. This entry is disabled if **VLAN Support** is set to **Disable** on the **WAN Access** pane.
- **LAN DHCP Server** enables the dynamic host configuration protocol (DHCP) mode for the LAN side of the connection.
- **LAN IP** is the local network IP address of the unit.
- **LAN Subnet Mask** is the network address mask used to identify if the IP address is within the same local area network.
- **ARU-100(HPNA)** enables you to be **Connected** or **Disconnected** from the HPNA test probe. **Connected** allows monitoring of **HPNA Info** in a triple-play application. The entry is only visible with the HPNA software option and if **Line Mode** selected is *not* **HPNA-coax**.

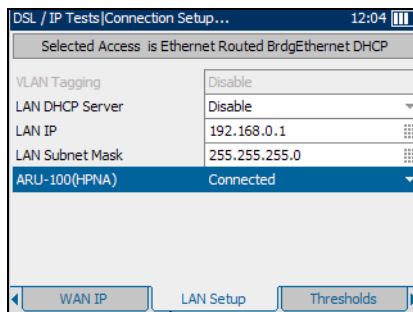

To select the LAN parameters to configure:

1. From the **Connection Setup** pane, press the left/right function arrows until the **LAN Setup** tab is displayed.
2. Press the F1, F2, or F3 key located just below the tab to select it.
3. Press the up/down arrows to select the desired parameter.
4. Press ✓ to open the list or modify the parameter.
5. In the list, press the up/down arrows to select the function or mode.

OR

Use the alphanumeric keypad to enter the value you want to specify.

6. Press ✓ to confirm the selection.

Thresholds

The **Thresholds** tab allows you to specify upper and lower thresholds against which the actual measured unit/DSLAM negotiated results will be evaluated. The described **Selected Profile** is composed of the current **LineMode** and **AccessMode** selections. If **LineMode** is set to **Ethernet**, this tab is unavailable.

The available parameters are the following:

- **Min. Actual Bit Rate(kbps)** is minimum actual bit rate, **DownStream** and **UpStream**. Measured values must be greater than these limits.

For **DownStream**:

- If **LineMode** is set to **ADSL2+**, valid values are 0 through 25000, with a default value of 100.
- If **LineMode** is set to **VDSL2**, valid values are 0 through 100000, with a default value of 12000.

For **UpStream**:

- If **LineMode** is set to **ADSL2+**, valid values are 0 through 1000, with a default value of 100.
- If **LineMode** is set to **VDSL2**, valid values are 0 through 80000, with a default value of 6000.
- **Min. SNR Margin(dB)** is minimum signal-to-noise ratio margin **DownStream** and **UpStream** where valid values range from 0 through 63.5, with a default value of 5.
- **Max. Attenuation(dB)** is maximum attenuation **DownStream** and **UpStream** where valid values range from 0 through 128.0, with a default value of 10.

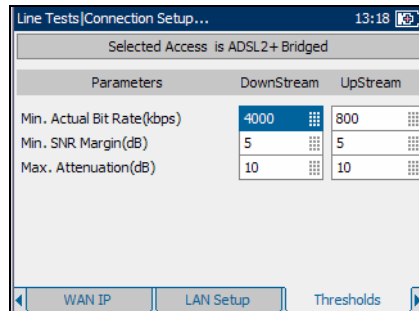

To select the thresholds parameters to configure:

- 1.** From the **Connection Setup** pane, press the left/right function arrows until the **Thresholds** tab is displayed.
- 2.** Press the F1, F2, or F3 key located just below the tab to select it.
- 3.** Press the up/down arrows to select the desired parameter.
- 4.** Press ✓ to modify the parameter.
- 5.** Use the alphanumeric keypad to enter the value you want to specify.
- 6.** Press ✓ to confirm the selection.

Connection Setup for DSL/IP Triple-Play Verification Tests

Setup Line Connection

Down Stream Channels

The **Dwn Stream Chns** tab allows you to enter values for **VPI** and **VCI** dependent on the number of enabled down stream channels. The described **Selected Profile** is composed of the current **LineMode** and **AccessMode** selections. If **LineMode** is set to **Ethernet** or **VDSL2**, this tab is unavailable.

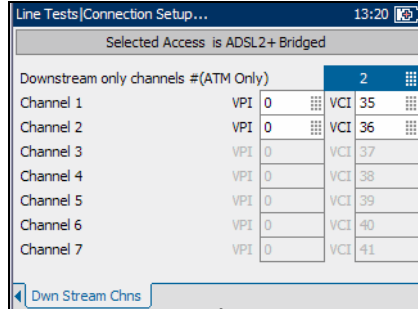

- **Downstream only channels #** is the number of downstream only channels ranging from 0 through 7, with a default value of 0. When this entry is set to 0, all **VPI** and **VCI** entries are unavailable.
- **VPI** is the virtual path identifier (VPI) ranging from 0 through 255 for the downstream channel.
- **VCI** is the virtual circuit identifier (VCI) ranging from 32 through 65535 for the downstream channel.

To select the downstream channel parameters to configure:

1. From the **Connection Setup** pane, press the left/right function arrows until the **DwnStreamChn** tab is displayed.
2. Press the F1, F2, or F3 key located just below the tab to select it.
3. Press the up/down, left/right arrows to select the desired parameter.
4. Press ✓ to modify the parameter.
5. Use the alphanumeric keypad to enter the value you want to specify.
6. Press ✓ to confirm the selection.

11 **Configure Tests for DSL/IP Triple-Play Verification**

The purpose of the **Configure Tests** function is to modify the unit to include and perform various tests for the applications to be verified. These tests are accessible through the different pane tabs.

To access the configure tests during a DSL/IP test:

1. From the **DSL/IP Tests** pane, use the up/down arrows to select the **Configure Tests** entry.
2. Press ✓ to confirm the selection.

To view the available tabs:

Press the left/right function arrows on each side of the F1, F2, and F3 keys.

Configure Profile

Before configuring all the line test parameters, you can refer to previously saved profiles.

Select Configuration

The **Select Config** tab allows you to setup and store multiple profiles containing specific configuration parameters for the unit. At power up, all test configuration parameters are read from the last current test configuration.

- **Read from File** allows you to view a list of previously saved profiles with the first entry being **Default**.
- **Save to File** allows you to save test parameters to a default profile or a new custom file name.

To select test configuration parameters to be used during DSL/IP tests:

1. From the **Select Config** tab pane, use the up/down arrows to highlight an old or new configuration file name.
2. Press ✓ to confirm the selection.
3. Press the left arrow to highlight the **Read from File** button.
4. Press ✓ to confirm the selection.
5. Press the up/down arrows to highlight the text edit box.
6. Use the alphanumeric keypad to enter a custom profile name.
7. Press the left arrow to highlight the **Save to File** button to save the configured profile.

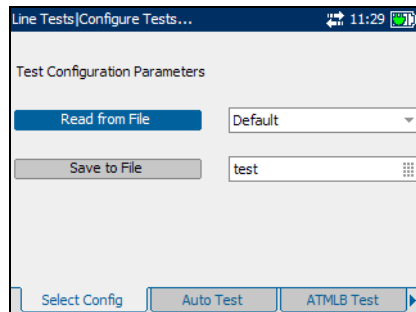

Configure DSL/IP Tests

Auto Test

The purpose of the Auto Test function is to:

- Establish a connection to the DSLAM
- Log into an ISP
- Perform a Ping test

The **Auto Test** tab allows you to select a series of tests to be configured in the Auto Test procedure.

Your choice of tests to **Enable** or **Disable** are the following:

- **IPTV Analysis** runs an auto test for video. When this entry is enabled, all other test-choice entries on the **Auto Test** pane are automatically disabled.
- **Data Analysis** runs an auto test for data by enabling the unit to act as a modem, allowing you to connect from your computer to the internet via the unit's Ethernet port. When this entry is enabled, all other test-choice entries on the **Auto Test** pane are automatically disabled.
- **VoIP Analysis** runs an auto test for voice. When this entry is enabled, all other test-choice entries on the **Auto Test** pane are automatically disabled.
- **CPE Ping Test** checks the ICMP echo request during the auto test. When this entry is enabled, **IPTV**, **Data** and **VoIP** analyses are automatically disabled.

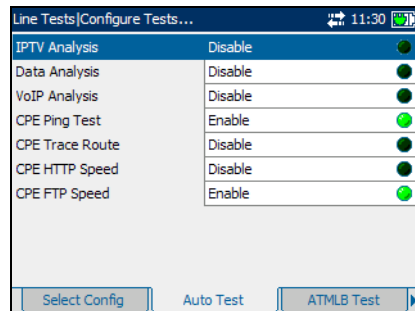

Configure Tests for DSL/IP Triple-Play Verification

Configure DSL/IP Tests

- **CPE Trace Route** reports the status of IP packets being sent to a specified IP destination, and the path and time taken to do so, in auto test. When this entry is enabled, **IPTV, Data** and **VoIP** analyses are automatically disabled.
- **CPE HTTP Speed** measures the speed of downloading Web pages, in auto test. When this entry is enabled, **IPTV, Data** and **VoIP** analyses are automatically disabled.
- **CPE FTP Speed** measures the speed of the file transfer protocol download, in auto test. When this entry is enabled, **IPTV, Data** and **VoIP** analyses are automatically disabled.

To select the tests to include:

1. Press the up/down arrows to highlight a desired test.
2. Press  to toggle between **Enable** or **Disable**.
3. Select other tests as required.

ATM LoopBack

The **ATMLB** tab allows you to configure the parameters to verify the connection between the DSLAM and the ATM core; that the customer is properly provisioned up to the point of the ATM switch based on ATM F5 OAM (operation, administration, and maintenance) loopback functionality.

The available parameters are the following:

- **VPI** is a value ranging from 0 through 255 for the virtual path identifier (**VPI**) of the ATM connection.
- **VCI** is a value ranging from 32 through 65535 for the virtual circuit identifier (**VCI**) of the ATM connection.
- **Cell Type** initiates either **End to End** or **Segment** loopbacks.
- **Mode** lists the levels of OAM testing dedicated to the ATM layer. The values are either **F4** for testing the virtual path level or **F5** for testing the virtual channel level.

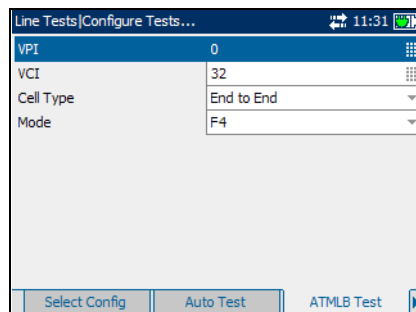

To select the ATM loopback parameters to configure:

1. Press the up/down arrows to select the desired parameter.
2. Press ✓ to open the list or modify the parameter.
3. In the list, press the up/down arrows to select the function or mode.

OR

Use the alphanumeric keypad to enter the value you want to specify.

4. Press ✓ to confirm the selection.

Configure Tests for DSL/IP Triple-Play Verification

Configure DSL/IP Tests

Ping Test

The **Ping Test** tab allows you to configure the parameters to perform a ping test, also known as an ICMP echo request, during the CPE test.

The available parameters are the following:

- **IP Address** lists either the **URL** or **IP Address** where the unit pings.
- **URL/IP Address** is the destination IP address of the device actively connected to the network.
- **Packet Size** is a value from 32 through 1200 of the number of bytes sent in one packet. The default value is 32.
- **Total Pings** is the total number of ping packets to send out from 1 through 99. The default value is 3.
- **Timeout** is the time in seconds from 1 through 15, that the unit will wait for a response back from the destination device. The default value is 1.
- **Max hops** is the number of hops from 1 through 99, that the unit will attempt to reach a destination IP address. The default value is 32.

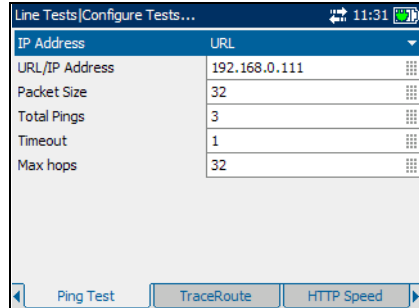

To select the ping parameters to configure:

1. Press the up/down arrows to select the desired parameter.
2. Press ✓ to open the list or modify the parameter.
3. In the list, press the up/down arrows to select the function or mode.

OR

Use the alphanumeric keypad to enter the value you want to specify.

4. Press ✓ to confirm the selection.

TraceRoute

The **TraceRoute** tab allows you to trace an IP packet from the unit (or a computer) to a specified IP destination and define how many hops the packet requires to reach the destination. This test is useful in determining where the longest delays are occurring along the network path.

The available parameters are the following:

- **Address Format** lists the address either as a **URL** or **IP Address**.
- **Destination Address** is the destination IP address.
- **Max hops** is a value from 1 through 99 specifying the maximum number of hops to be used in attempting to reach the destination IP address. The default value is 32.

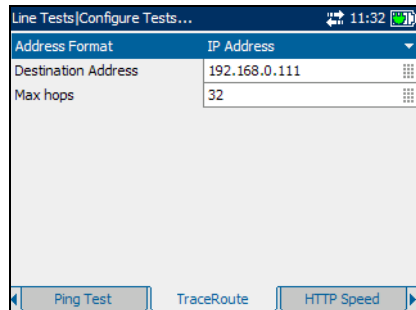

To select the traceroute parameters to configure:

1. Press the up/down arrows to select the desired parameter.
2. Press ✓ to open the list or modify the parameter.
3. In the list, press the up/down arrows to select the function or mode.

OR

Use the alphanumeric keypad to enter the value you want to specify.

4. Press ✓ to confirm the selection.

Configure Tests for DSL/IP Triple-Play Verification

Configure DSL/IP Tests

HTTP Speed

The **HTTP Speed** tab allows you to enter the **Download Address** which is the destination IP address or Web site URL to be downloaded (depending on the test selected) from the http server.

To select the download parameter to configure:

1. Press the up/down arrows to select the desired parameter.
2. Press ✓ to modify the parameter.
3. Use the alphanumeric keypad to enter the value you want to specify.
4. Press ✓ to confirm the selection.

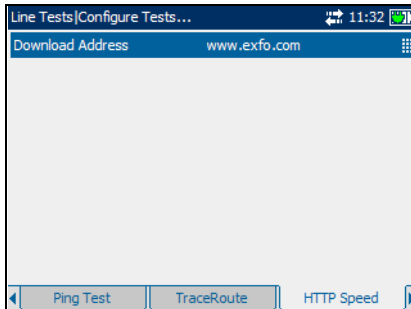

FTP Speed

The **FTP Speed** tab allows you to configure the file transfer protocol parameters for downloading and uploading files to the server.

The available parameters are the following:

- **Ftp Server Address** is the address of the file transfer protocol (FTP), maximum 72 characters.
- **Login ID** is your user name, maximum 72 characters. The default value is **anonymous**.
- **Password** is your user password, maximum 36 characters.
- **Download File Name** is the filename requested for downloading, maximum 128 characters; left blank if no download test is required.
- **Upload File Name** is the filename used for uploading, maximum 128 characters.
- **Upload File Size(Kbytes)** is the number of bytes or size of the file to be uploaded to the server. Valid values range from 1 through 65536.

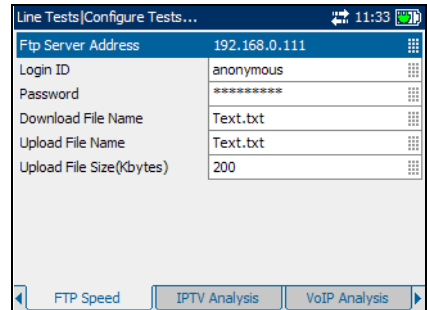

To select the FTP speed parameters to configure:

1. Press the up/down arrows to select the desired parameter.
2. Press ✓ to modify the parameter.
3. Use the alphanumeric keypad to enter the value you want to specify.
4. Press ✓ to confirm the selection.

Configure Tests for DSL/IP Triple-Play Verification

Configure DSL/IP Tests

IPTV Analysis

The **IPTV Analysis** tab allows you to configure the unit for video testing.

The parameters are the following:

- **Join Multicast Address** is the multicast address of the channel that is automatically requested to join when running the video analysis during the auto test.
- **Monitoring Interval** is a list of time interval values - **8, 16, 32, or 64 min** - to set the length of time for which data is plotted on a graph.
- **Test Thresholds** allow you to set critical quality of service (QoS) values for delivering IPTV over DSL.
 - **Max Packet Jitter (ms)** is a value in accordance with the network characteristics, ranging from 0 through 99 milliseconds, to be used as the pass or fail criteria for QoS.
 - **Max Lost Packet Ratio (%)** is a percentage of the total packet rate, ranging from 0 through 10.00, to use as pass/fail criteria for QoS.
 - **Max ZAP Time(ms)** is the time in milliseconds, ranging from 0 through 999, required for a channel change and to be considered when evaluating IPTV QoS.
 - **MAX PCR Jitter (ms)** is the short-term variation in milliseconds, ranging from 0 through 999, of the arrival of the PCR (program clock reference) information at the video decoder.
 - **Max MDI:DF (ms)** is the media delivery index (MDI) to delay factor (DF) in milliseconds, ranging from 0 through 999.
 - **Max MDI:MLR (packs/s)** is the media delivery index (MDI) to media loss rate (MLR) in packets lost per second, ranging from 0 through 999.

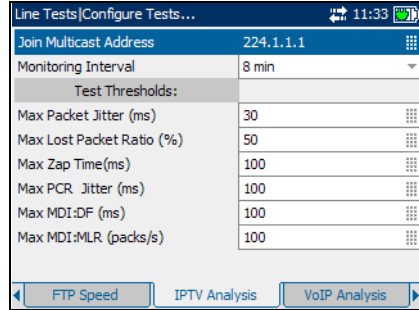

To select the IPTV analysis parameters to configure:

- 1.** Press the up/down arrows to select the desired parameter.
- 2.** Press ✓ to open the list or modify the parameter.
- 3.** In the list, press the up/down arrows to select the function or mode.

OR

Use the alphanumeric keypad to enter the value you want to specify.

- 4.** Press ✓ to confirm the selection.

Configure Tests for DSL/IP Triple-Play Verification

Configure DSL/IP Tests

VoIP Analysis

The **VoIP Analysis** tab allows you to configure the unit for voice over IP testing.

The parameters are the following:

- **Monitoring Interval** is a list of time interval values - **8, 16, 32, or 64 min** - to set the length of time for which data is plotted on a graph.
- **Test Thresholds** allow you to specify the thresholds against which the actual measured unit/DSLAM negotiated results will be evaluated.
 - **Max PCR Jitter (ms)** is a value in accordance with the characteristics of the network, ranging from 0 through 200 to be used as the pass or fail criteria for the quality of service (QoS).
 - **Max Lost Packet Ratio (%)** is a percentage of the total packet rate, to be used as the pass or fail criteria for the quality of service (QoS).

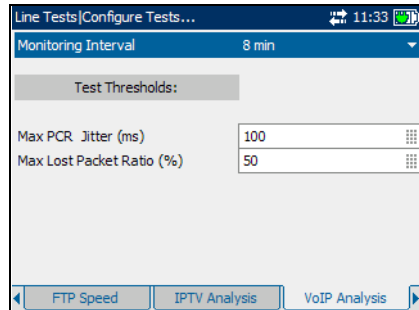

To select the VoIP analysis parameters to configure:

1. Press the up/down arrows to select the desired parameter.
2. Press **✓** to open the list or modify the parameter.
3. In the list, press the up/down arrows to select the function or mode.

OR

Use the alphanumeric keypad to enter the value you want to specify.

4. Press **✓** to confirm the selection.

Data Analysis

The **Data Analysis** tab allows you to select the **Monitoring Interval** which is a list of time interval values - **8**, **16**, **32**, or **64 min** - to set the length of time for which data is plotted on a graph.

To select the monitoring interval:

1. Press the up/down arrows to select the parameter.
2. Press ✓ to open the list.
3. In the list, press the up/down arrows to select the value.
4. Press ✓ to confirm the selection.

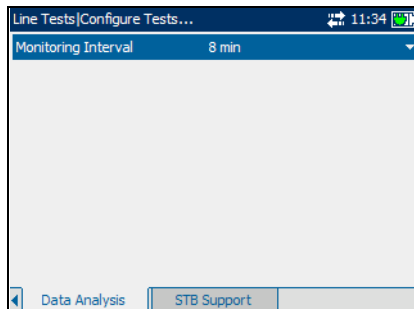

Configure Tests for DSL/IP Triple-Play Verification

Configure DSL/IP Tests

STB Support

The **STB Support** tab allows you to specify the network addresses for up to four set-top boxes to be emulated. This pane is active only for bridged access mode.

The available parameters are the following:

- **Number of STB** is the quantity of set top boxes (maximum 4) to be emulated by the unit at the testing location.
- **Obtain STB IP** is either **Dynamic** where the access concentrator or broadband remote access server assigns a temporary IP address to the set top box, or **Static** where you enter the IP address of the set top box.
- **STB Vendor ID** is the name of the set top box, maximum 80 characters. This entry is unavailable if **Obtain STB IP** is set to **Static**.
- **MAC1-4** is the MAC address for each specified set top box.
- **IP1-4** is the IP address for each set top box that has been specified.

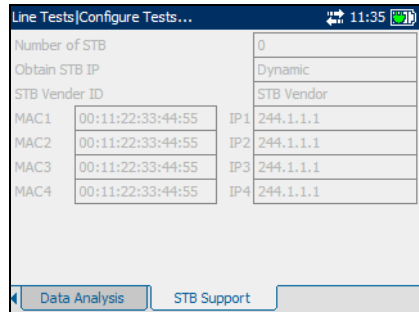

To select the STB support parameters to configure:

1. Press the up/down, left/right arrows to select the desired parameter.
2. Press ✓ to open the list or modify the parameter.
3. In the list, press the up/down arrows to select the function or mode.

OR

Use the alphanumeric keypad to enter the value you want to specify.

4. Press ✓ to confirm the selection.

12 Running CPE Tests

The purpose of the CPE Test function is to establish a connection to the DSLAM and confirm the status of the DSL line. You can then log on to an ISP to perform advanced tests, including Ping, TraceRoute, and download speed tests.

To view the available tabs:

Press the left/right function arrows on each side of the F1, F2, and F3 keys.

Reading Results

Test Summary

The **TestSummary** tab allows you to view the **PASS/FAIL** status and **Details** of a series of CPE test results.

The available test results are the following:

- **Line Status** displays either **Connected** or **Disconnected** for the particular line connection under test.
- **WAN Status** displays whether the unit is **Connected** to the wide area network, or in **idle mode**.
- **PingTest** is also known as ICMP echo request and determines network connectivity and accessibility.
- **TraceRoute** reports the path and the time of an IP packet to reach the destination IP address.
- **HTTP Speed** allows you to evaluate the speed at which a particular Web page or URL or Web object can be downloaded by the unit.
- **FTP Speed** displays the status of whether the file transfer protocol was completed or not.

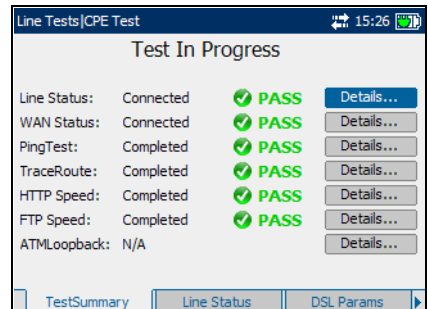

Running CPE Tests

Reading Results

- **ATMLoopback** verifies that the connection between the DSLAM and ATM core is configured correctly, and that the customer is properly provisioned up to the point of the ATM switch.
- **Details** button shortcuts to the applicable tab which provides more information about a particular test result.

To view more information about each available test result:

1. Press the up/down arrows to highlight the **Details** button alongside the desired test result.
2. Press  to select the desired **Details** button.

Line Status

The **Line Status** tab allows you to view the conditions of the line under test which was configured in the connection setup.

The available test results are the following:

- **Line Status** displays **Showtime** when the unit and the DSLAM have successfully connected and negotiated applicable data rates for the particular connection under test. During negotiation with the DSLAM, the value changes from **Booting/DecompressImage/StartProgram/LoadModules/Idle/Activate/Ready/Handshaking/Training** to **Showtime**.
- **Operational Mode** is the DSL mode of operation as negotiated between the unit and the DSLAM.
- **CO VendorID** is a unique 4-digit alphanumeric identifier of the DSL chipset manufacturer used on the central office (CO) side.
- **CO Version** is the version number of the unique alphanumeric identifier of the DSL chipset used on the CO side.

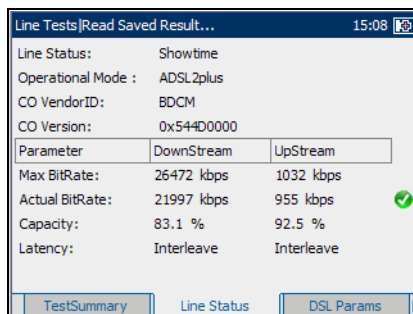

The screenshot shows a window titled "Line Tests|Read Saved Result..." with a timestamp of 15:08. The window displays the following information:

Line Status:	Showtime	
Operational Mode :	ADSL2plus	
CO VendorID:	BDCM	
CO Version:	0x544D0000	
Parameter	DownStream	UpStream
Max BitRate:	26472 kbps	1032 kbps
Actual BitRate:	21997 kbps	955 kbps
Capacity:	83.1 %	92.5 %
Latency:	Interleave	Interleave

At the bottom of the window, there are three tabs: "TestSummary", "Line Status" (which is selected), and "DSL Params". A green checkmark is visible next to the "Actual BitRate" values.

- **Parameter** lists the **DownStream** and **UpStream** results for the following parameters:
 - **Max BitRate** displays the maximum attainable bit rates that the circuit can handle as determined by the remote terminal and CO during the training phase. Values can be greater than the actual bit rate.
 - **Actual BitRate** displays the values at which the unit and CO are connected, as negotiated during the training phase. The values should represent what the CO was set to, unless the DSL link is being subjected to high levels of noise/crosstalk, and are typically what the DSLAM has been set to, whether interleaved or fast.
 - **Capacity** is the capacity of the line as a ratio of achieved bit rate over the maximum attainable bit rate (Max BitRate) presented as a percentage (%). A high value could mean that the link is nearing its maximum capabilities while a low value could mean the link is being under utilized (sometimes intentionally – verify your local DSLAM setup).
 - **Latency** is the path type, **Fast** or **Interleave**, set by the service provider at the CO. The use of the interleaved path means greater delay in the delivery of data but it is less susceptible to noise or crosstalk due to increased Reed-Solomon coding and forward error checking (FEC). The use of the fast path means little of no delay in the delivery of data but it is more susceptible to noise and crosstalk.

When set up over Ethernet, the available test results are the following:

- **Line Status** displays either **Connected** or **Disconnected** for the particular line connection under test.
- **LinkSpeed** is a choice between **AUTO** (negotiated during the link establishment), **100** or **10 Mbps**.
- **ConnectMode** is **FULL_DUP** or **HALF_DUP**, when **Link Speed** is set to either **100** or **10 Mbps**.

DSL Parameters

The **DSL Params** tab allows you to view the pass/fail status of the **DownStream** and **UpStream** parameters configured in the test setup.

The available test results are the following:

- **SNR Margin** is a value ranging from 0 through 63.5 for the minimum signal-to-noise ratio margin.
- **Attenuation** is a value ranging from 0 through 63.5 for the maximum attenuation.
- **Output Power** is the current transmit power level that is a measure of the absolute transmit power.
- **INP** is the level of impulse noise protection.
- **Interl.Depth** is interleave depth which defines the number of bits (or bytes) in each block of data.
- **Interl.Delay** is interleave delay which defines the mapping (relative spacing) between subsequent input bytes at the interleave input and their placement in the bit stream at the interleave output.
- **Trellis** or Trellis Coded Modulation (TCM) is a type of convolutional code which utilizes parity bits on each symbol within a continuous data stream. When the line is connected, Trellis displays either **ON** or **OFF**.
- **BITSwap** specifies the status of the bit swapping mechanism - **Active**, **Not Active** or **Unknown** - swapping bits from tone m to tone n to prevent modem retraining.

Parameter	DownStream	UpStream	Status
SNR Margin:	7.3 dB	0.0 dB	✗
Attenuation	0.0 dB	0.0 dB	✓
Output Power:	0.0 dBm	-34.6 dBm	
INP:	1.0	1.0	
Interl.Depth:	349	39	
Interl.Delay:	4.0 ms	4.0 ms	
TRELLIS:	ON	ON	
BITSwap:	Active	Active	

Statistics

The **Statistics** tab allows you to view transfer mode statistics and DSL counters.

The available test results are:

- **TransportType** options include packet transfer mode (**PTM**) and asynchronous transfer mode (**ATM**).
- **SyncLostCount** is the number of times the unit lost synchronization.
- **Received Bytes** is the number of active (non-idle) PTM/ATM cells or frames received on a channel.
- **Transmit Bytes** records the number of active (non-idle) PTM/ATM cells or frames transmitted on a channel.
- **PTMCRC** is the number of cyclical redundancy check (CRC) errors of the PTM.
- **PTMCV** is the number of constant velocity (CV) errors of the PTM.
- **DSL Counters** lists the **Local** and **Remote** results for the following counters:
 - **CRC** is the cyclical redundancy check (**CRC**) Interleaved/Fast counter.
 - **HEC** is the header error check (**HEC**) Interleaved/Fast counter.
 - **FEC** is the Reed Solomon forward error check (**FEC**) Interleaved/Fast counter.
 - **FEC Seconds** is the number of seconds when FEC is detected.
 - **Error Seconds** is the number of seconds when code violation is detected.
- **Reset Counters** button sets all counters to 0.

Line Tests Read Saved Result...		15:11
TransportType:	ATM	<input type="button" value="Reset Counters"/>
SyncLostCount:	0	
Received Bytes:	1920	
Transmit Bytes:	1152	
ADSL Counters	Local	Remote
CRC:	0	159440
HEC:	0	0
FEC:	0	0

Statistics | Bits per Bin | WAN Status

Running CPE Tests

Reading Results

VDSL Bands

The **VDSL Bands** tab allows you to view the VDSL parameters negotiated by the unit and central office, configured in the connection setup.

The available test results are the following:

- **SNR Margin** is the measured current signal-to-noise ratio (SNR) margin across all active sub-channels, as an amount of increased noise relative to the measured noise power that the system would be able to tolerate to maintain a bit error rate of 10⁻⁷.
- **LoopAttn** is the current reduction of the line.
- **SignalAttn** is the current reduction of the signal.
- **Tx Power** is the upstream/downstream transmitting power for the selected band.
- **DS0-4** button displays the downstream parameters for different VDSL bands 0 to 4.
- **US0-4** button displays the upstream parameters for different VDSL bands 0 to 4.

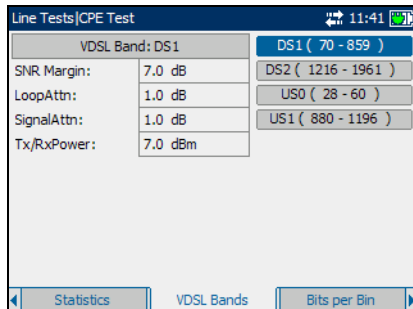

Bits per Bin

The **Bits per Bin** tab allows you to view the number of bits that can be transmitted on a particular bin representing a certain tone. The frequency of the tone equals the bin number multiplied by 4.325 kHz.

- **Zoom In** allows you to increase the level of zoom for the selected zoom function.
- **Zoom Out** allows you to reduce the level of zoom for the selected zoom function.

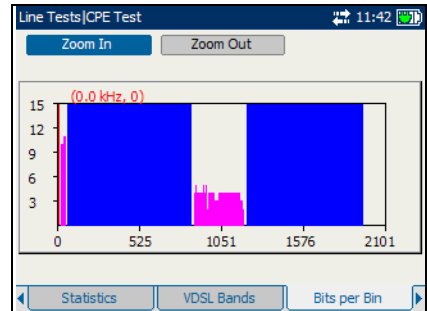

To zoom in or out:

1. Press the up or down arrow key to highlight the desired zoom function.
2. Press **✓** to select the zoom function.
3. Use the left or right arrow key to highlight the **Zoom In** or **Zoom Out** button as required, then press **✓**.

The graphical display zooms in or out accordingly.

4. Press **✓** repeatedly to continue zooming.

WAN Status

The **WAN Status** tab allows you to view the status of the connection between the wide area network and the ISP.

The available test results are the following:

- **WAN Access** specifies the type of wide area network access, either **Bridged** or **Routed** mode.
- **Status** displays either **Connected** or **Disconnected** for the particular line connection under test.
- **Encapsulat** is the encapsulation method used by the network and consists of the following types:
 - **PPPoE** is point-to-point protocol over Ethernet.
 - **PPPoA** is point-to-point protocol over ATM.
 - **Bridged Ether DHCP** is also known as multi-protocol encapsulation over ATM (MPoA).
 - **IPoA** stands for classical internet protocol over ATM.

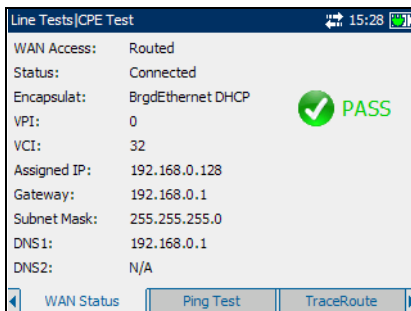

- **VPI** is the virtual path identifier (VPI) ranging from 0 through 255 for the ATM connection.
- **VCI** is the virtual circuit identifier (VCI) ranging from 32 through 65535 for the ATM connection.
- **Assigned IP** is the IP address information assigned to the unit that is actively connected to your network or the internet at the time of login.
- **Gateway** is the IP address of the default gateway.
- **Subnet Mask** is the network address used to identify if the IP address is within the same wide area network.
- **DNS1** is the address of the *primary* domain name server to be used by the unit.
- **DNS2** is the address of the *secondary* domain name server to be used by the unit.

Ping Test

The **Ping Test** tab allows you to view the **PASS/FAIL** summary status of either a **Ping Address** or **Ping Gateway**.

The available test results are the following:

- **Address Format** lists either the **URL** or **IP Address** where the unit pings.
- **URL/IP Address** is the IP address (a.b.c.d) or domain name (www.abcd.com) of the destination being pinged.
- **PckSize** is the number of bytes sent in one packet ranging from 32 through 1200 (default is 32 bytes).
- **Pings** display the total number of ping requests to be sent.
- **Ping Status** is the duration in milliseconds (ms) it took the data to come back from the destination device.
- **Summary:**
 - **Packetsize** displays the size of the Ping packet as selected.
 - **Sent/Received:** shows the number of packets sent versus the number of packets received.
 - **Average round trip time** is the duration in milliseconds (ms) it took the data to reach the destination device and come back.

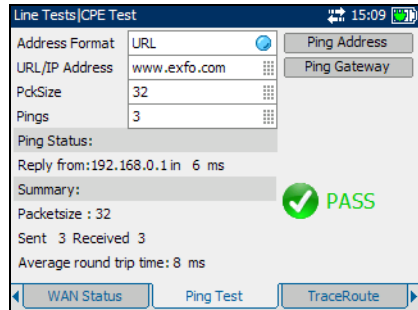

TraceRoute

The **TraceRoute** tab allows you to view the **PASS/FAIL** status of an IP packet being sent to a specified IP destination, and the path and time taken to do so.

The available test results are the following:

- **Dest.Addr.** is the destination IP or URL address.
- **Max hops** specifies the maximum number of hops used in attempting to reach the destination address.
- **Trace** button starts TraceRoute, displaying the test progress in the area below.

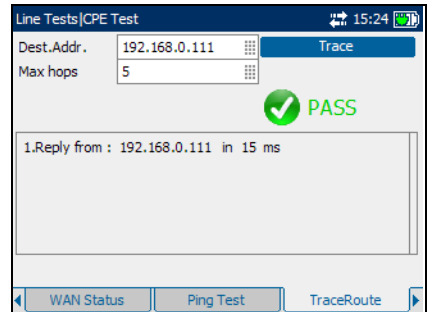

HTTP Speed

The **HTTP Speed** tab allows you to view the **PASS/FAIL** summary status of the download test configured in the CPE test setup.

The available test results are the following:

- **DwnAddress** is the destination IP address or Web site that was downloaded.
- **Download** button starts the HTTP speed test, displaying the progress below.
- **Resolving Address** is the address of the **DwnAddress**.
- **Download Bytes** displays the count of bytes received.
- **Download Time** is the amount of time it took to receive the download bytes.
- **Download Speed** is the speed at which the unit is capable of downloading a Web page or content.

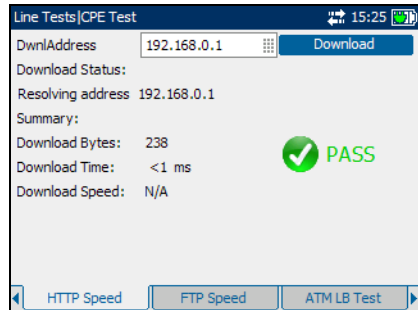

FTP Speed

The **FTP Speed** tab allows you to view the **PASS/FAIL** summary status of whether or not the file transfer protocol (FTP) which was configured in the CPE test setup was completed successfully or not.

The available test results are the following:

- **FTPServer** is the IP address of the connected FTP server.
- **Login Name** is your user ID.
- **Password** is your user password.
- **Download File** is the name of the file downloaded to the FTP server.

The screenshot shows a software interface for running CPE tests. It features a table for inputting test parameters and a summary of the results. The parameters are: FTPServer (192.168.0.111), Login Name (test), Password (****), Download File (m.bin), and Upload File (Text.txt). The results show 'FTP Status: Download Successful' with a green checkmark and the word 'PASS' in green. Below this, it displays 'Received Bytes: 196114', 'Elapsed Time: 359 ms', and 'Estimated speed: 4370 kbps'. At the bottom, there are three tabs: 'HTTP Speed', 'FTP Speed' (which is selected), and 'ATM LB Test'.

FTPServer	192.168.0.111
Login Name	test
Password	****
Download File	m.bin
Upload File	Text.txt
FTP Status:	Download Successful
FTPServer:	192.168.0.111
FileName:	m.bin
Received Bytes: 196114 Elapsed Time: 359 ms	
Estimated speed: 4370 kbps	

The **Download** button starts downloading the file entered here.

- **Upload File** is the name of the file uploaded to the FTP server. The file size is limited to a maximum of 64 Mb.

The **UpLoad** button starts uploading the file entered here.

- **File Name** is the name of the uploaded or downloaded file being summarized on the pane.
- **Received Bytes** displays the number of bytes that was downloaded from the FTP server.
- **Elapsed Time** is the duration in ms of downloading/uploading the file.
- **Estimated speed** is the calculated rate - number of received bytes divided by elapsed time - of downloading/uploading the file.

HPNA Info

The **HPNA Info** tab allows you to view the results of the HPNA devices detected on the network.

- **Device Detected** displays the total number of detected HPNA devices on the network.
- **Refresh** button allows you to rerun the DevInfo Test and update the page with new data.
- **Device MAC Address** lists all the MAC addresses for the detected HPNA devices.
- **Mode** displays **Master** or **Client** for the selected device.
- **Link State** is the **Up** to **Down** (or vice versa) routing protocol of the network link for the selected device.
- **Sync State** is the sync status of the selected device.
- **SW Version** is the software version number of the selected device.
- **Chipset Version** is the version number of the chipset for the selected device.
- **Frequency Band** displays the range of signal frequency for the selected device.

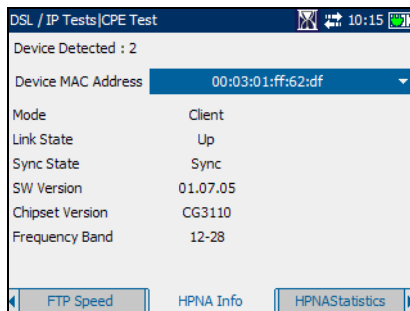

To select a detected device:

1. Press ✓ to open the list.
2. In the list, press the up/down arrows to select the MAC address of the desired device.
3. Press ✓ to confirm the selection and view the results.

HPNA Statistics

The **HPNA Statistics** tab allows you to view counter statistics of the selected HPNA device.

- **Select Device** lists all the MAC addresses of the detected HPNA devices on the network.
- **Tx Packets** is the number of packets sent.
- **Rx Packets** is the number of packets received.
- **Tx Bytes** is the count of bytes sent.
- **Rx Bytes** is the count of bytes received.
- **Rx CRC Packets** is a count of cyclical redundancy check (CRC) errors received.
- **Tx Packets Dropped** is the number of outgoing packets dropped.
- **Rx Packets Dropped** is the number of incoming packets dropped.

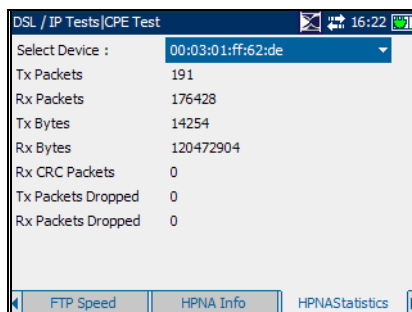

The screenshot shows a window titled "DSL / IP Tests | CPE Test" with a dropdown menu for "Select Device" set to "00:03:01:ff:62:de". Below the dropdown is a table of statistics:

Select Device :	00:03:01:ff:62:de
Tx Packets	191
Rx Packets	176428
Tx Bytes	14254
Rx Bytes	120472904
Rx CRC Packets	0
Tx Packets Dropped	0
Rx Packets Dropped	0

At the bottom of the window, there are three tabs: "FTP Speed", "HPNA Info", and "HPNAStatistics", with "HPNAStatistics" being the active tab.

To select a MAC address:

1. Press ✓ to open the list.
2. In the list, press the up/down arrows to select the MAC address of the desired device.
3. Press ✓ to confirm the selection and view the test results.

Running CPE Tests

Reading Results

ATM Loopback Test

The **ATMLB Test** tab allows you to view the ATM loopback connection value results of the **VPI** (virtual path identifier) and **VCI** (virtual circuit identifier), and the **PTI** (payload type identifier) which is either **End-To-End** or **Segment**.

If the unit is not connected to the network or the time-out setup value is low, you may see the **Timeout** message continuously.

Send button starts the ATM loopback test.

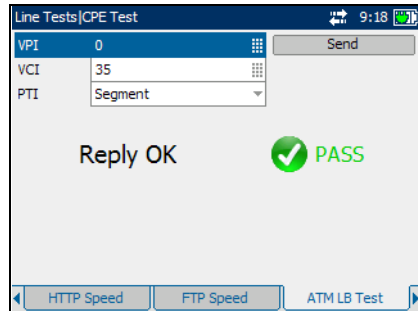

Saving Results

Save Result

The **Save Result** tab allows you to save your test results to a file or to an HTML report.

Each entry on the pane is described below:

- **Save as Type** lists the following formats to save your test results:
 - **AXS200 format** is a binary file format with ext *.dat. This format can be opened only on an AXS200 unit. The **Available Graphs** list box will be unavailable in this case.
 - ***.csv** saves only graphical results. Textual results must be formatted as a comma-separated values table for easy importation to Excel. Results are saved to a USB.
 - ***.gif** stands for graphics interchange format and is one of the most common file formats for graphic images on the World Wide Web. Results are saved to a USB.
 - ***.bmp** saves graphical results in a bitmap file format. Results are saved to a USB.
 - ***.xml** saves your data in a common language format to share on the Web.
- **Available Graphs** is enabled only if the selected format under **Save as Type** is ***.gif**, ***.csv**, or ***.bmp**. For a test that does not have a graph, this list box is unavailable.
- **Save Results** button saves the test results in internal or external memory (depending on the **Save as Type** format).

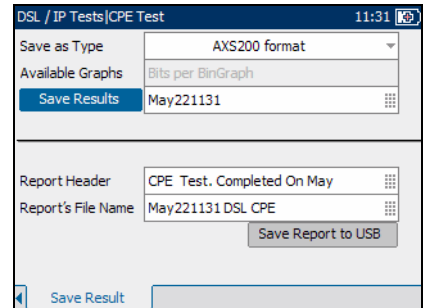

Running CPE Tests

Saving Results

- *Filename* is the current date and time stamp plus you can enter any name. If it already exists, you will be prompted to overwrite the existing file.
- **Report Header** is where you can enter any comment. The initial value is the current test followed by the date and time stamp.
- **Report's File Name** is where you can enter any name for the HTML filename. If the name already exists, you will be prompted to overwrite the existing file. The default extension is .html.

The default name is generated from the current time.

- **Save Report to USB** button saves the results to an HTML report. If a USB memory stick is not inserted, the following warning dialogue box appears: **USB device is not detected.**

To set parameter values and save results:

1. Press the left/right and up/down arrow keys to highlight the desired parameter.
2. Press ✓ to display the list or select the value.
3. Press the up/down arrow key to highlight the desired value.

OR

4. Press the left arrow key to erase the existing value, and then use the alphanumeric keypad to enter a value. To cancel the entry, press ↩.
5. Press ✓ to accept the value.

13 IPTV Analysis

The IPTV Analysis test functionality provides all the required information for the installation, maintenance, and/or troubleshooting of video services, including IPTV, delivered over DSL.

To view the available tabs:

Press the left/right function arrows on each side of the F1, F2, and F3 keys.

Reading Results

Test Summary

The **Test Summary** tab allows you to view the **PASS/FAIL** status and **Details** of all the tests configured for the DSL and Ethernet layers over which the IPTV service is being delivered. If a measured value is out of the threshold range configured for the IPTV analysis setup, the **Test Summary** screen displays a **FAIL** message.

The available test results are the following:

- **Line Status** displays either **Connected** or **Disconnected** for the particular line connection under test.
- **WAN Status** displays whether the unit is **Connected** to the wide area network, or in idle mode.
- **IP PacketLoss** is the total number of lost video packets within the threshold range.
- **IP PacketJitter** is the variance of the real-time transport protocol (RTP) data packet inter-arrival time.

Line Tests IPTV Analysis			
Test In Progress			
Line Status:	Connected	✓ PASS	Details...
WAN Status:	Connected	✓ PASS	Details...
IP PacketLoss:	< 50 %	✓ PASS	Details...
IP PacketJitter:	< 30 ms	✓ PASS	Details...
IGMP ZapTime:	> 100 ms	✗ FAIL	Details...
PCR Jitter:	< 100 ms	✓ PASS	Details...
MDI:DF:	< 100 ms	✓ PASS	Details...
MDI:MLR:	< 100 ms	✓ PASS	Details...

Test Summary | Line Status | DSL Params

IPTV Analysis

Reading Results

- **IGMP ZAPTime** is the time required for a channel change when traffic is being transferred between the central network and STB.
- **PCR Jitter** is the short-term variation in the arrival of program clock reference (PCR) information at the video decoder.
- **MDI:DF** is the media delivery index (MDI) delay factor (DF) which monitors the amount of time the video must be delayed in the virtual buffer due to cumulative IP packet jitter and IP packetization.
- **MDI:MLR** is the media delivery index (MDI) media loss rate (MLR), which monitors the amount of media packet loss experienced per second.
- **Details** button shortcuts to the applicable tab which provides more information about a particular test result.

To view more information about each available test result:

1. Press the up/down arrows to highlight the **Details** button alongside the desired test result.
2. Press  to select the desired **Details** button.

Line Status

The **Line Status** tab allows you to view the conditions of the line under test which was configured in the connection setup.

The available test results are the following:

- **Line Status** displays **Showtime** when the unit and the DSLAM have successfully connected and negotiated applicable data rates for the particular connection under test. During negotiation with the DSLAM, the value changes from **Booting/DecompressImage/StartProgram/LoadModules/Idle/Activate/Ready/Handshaking/Training** to **Showtime**.
- **Operational Mode** is the DSL mode of operation as negotiated between the unit and the DSLAM.
- **CO VendorID** is a unique 4-digit alphanumeric identifier of the DSL chipset manufacturer used on the central office (CO) side.
- **CO Version** is the version number of the unique alphanumeric identifier of the DSL chipset used on the CO side.

The screenshot shows a window titled "Line Tests|Read Saved Result..." with a timestamp of 15:15. The window displays the following information:

- Line Status: Showtime
- Operational Mode: ADSL2plus
- CO VendorID: BDCM
- CO Version: 0x910D0000

Parameter	DownStream	UpStream
Max BitRate:	27116 kbps	1272 kbps
Actual BitRate:	7135 kbps	1022 kbps
Capacity:	26.3 %	80.3 %
Latency:	Interleave	Interleave

At the bottom of the window, there are three tabs: "Test Summary", "Line Status" (which is selected), and "DSL Params". A green checkmark is visible next to the "Actual BitRate" row in the table.

- **Parameter** lists the **DownStream** and **UpStream** results for the following parameters:
 - **Max BitRate** displays the maximum attainable bit rates that the circuit can handle as determined by the remote terminal and CO during the training phase. Values can be greater than the actual bit rate.
 - **Actual BitRate** displays the values at which the unit and CO are connected, as negotiated during the training phase. The values should represent what the CO was set to, unless the DSL link is being subjected to high levels of noise/crosstalk, and are typically what the DSLAM has been set to, whether interleaved or fast.
 - **Capacity** is the capacity of the line as a ratio of achieved bit rate over the maximum attainable bit rate (Max BitRate) presented as a percentage (%). A high value could mean that the link is nearing its maximum capabilities while a low value could mean the link is being under utilized (sometimes intentionally – verify your local DSLAM setup).
 - **Latency** is the path type, **Fast** or **Interleave**, set by the service provider at the CO. The use of the interleaved path means greater delay in the delivery of data but it is less susceptible to noise or crosstalk due to increased Reed-Solomon coding and forward error checking (FEC). The use of the fast path means little of no delay in the delivery of data but it is more susceptible to noise and crosstalk.

When set up over Ethernet, the available test results are the following:

- **Line Status** displays either **Connected** or **Disconnected** for the particular line connection under test.
- **LinkSpeed** is a choice between **AUTO** (negotiated during the link establishment), **100** or **10 Mbps**.
- **ConnectMode** is **FULL_DUP** or **HALF_DUP**, when **Link Speed** is set to either **100** or **10 Mbps**.

DSL Parameters

The **DSL Params** tab allows you to view the pass/fail status of the **DownStream** and **UpStream** parameters configured in the test setup.

The available test results are the following:

- **SNR Margin** is a value ranging from 0 through 63.5 for the minimum signal-to-noise ratio margin.
- **Attenuation** is a value ranging from 0 through 63.5 for the maximum attenuation.
- **Output Power** is the current transmit power level that is a measure of the absolute transmit power.
- **INP** is the level of impulse noise protection.
- **Interl.Depth** is interleave depth which defines the number of bits (or bytes) in each block of data.
- **Interl.Delay** is interleave delay which defines the mapping (relative spacing) between subsequent input bytes at the interleave input and their placement in the bit stream at the interleave output.
- **Trellis** or Trellis Coded Modulation (TCM) is a type of convolutional code which utilizes parity bits on each symbol within a continuous data stream. When the line is connected, Trellis displays either **ON** or **OFF**.
- **BITSwap** specifies the status of the bit swapping mechanism - **Active**, **Not Active** or **Unknown** - swapping bits from tone *m* to tone *n* to prevent modem retraining.

Parameter	Down Stream	Up Stream
SNR Margin:	8.0 dB	0.0 dB
Attenuation:	0.0 dB	0.0 dB
Output Power:	0.0 dBm	1.0 dBm
INP:	1.0	1.0
Interl.Depth:	179	13
Interl.Delay:	4.0 ms	4.0 ms
TRELLIS:	ON	ON
BITSwap:	Not Active	Not Active

Statistics

The **Statistics** tab allows you to view transfer mode statistics and DSL counters.

The available test results are:

- **TransportType** options include packet transfer mode (**PTM**) and is the asynchronous transfer mode (**ATM**).
- **SyncLostCount** is the number of times the unit lost synchronization.
- **Received Bytes** is the number of active (non-idle) PTM/ATM cells or frames received on a channel.
- **Transmit Bytes** records the number of active (non-idle) PTM/ATM cells or frames transmitted on a channel.
- **PTMCRC** is the number of cyclical redundancy check (CRC) errors of the PTM.
- **PTMCV** is the number of constant velocity (CV) errors of the PTM.
- **DSL Counters** lists the **Local** and **Remote** results for the following counters:
 - **CRC** is the cyclical redundancy check (**CRC**) Interleaved/Fast counter.
 - **HEC** is the header error check (**HEC**) Interleaved/Fast counter.
 - **FEC** is the Reed Solomon forward error check (**FEC**) Interleaved/Fast counter.
 - **FEC Seconds** is the number of seconds when FEC is detected.
 - **Error Seconds** is the number of seconds when code violation is detected.
- **Reset Counters** button sets all counters to 0.

Line Tests Read Saved Result... 15:17		
TransportType:	ATM	<input type="button" value="Reset Counters"/>
SyncLostCount:	0	
Received Bytes:	52464384	
Transmit Bytes:	3408	
ADSL Counters	Local	Remote
CRC:	0	28
HEC:	0	1314
FEC:	0	1314

Navigation: Statistics | WAN Status | LAN Status

VDSL Bands

The **VDSL Bands** tab allows you to view the VDSL parameters negotiated by the unit and central office, configured in the connection setup.

The available test results are the following:

- **SNR Margin** is the measured current signal-to-noise ratio (SNR) margin across all active sub-channels, as an amount of increased noise relative to the measured noise power that the system would be able to tolerate to maintain a bit error rate of 10⁻⁷.
- **LoopAttn** is the current reduction of the line.
- **SignalAttn** is the current reduction of the signal.
- **Tx Power** is the upstream/downstream transmitting power for the selected band.
- **DS0-4** button displays the downstream parameters for different VDSL bands 0 to 4.
- **US0-4** button displays the upstream parameters for different VDSL bands 0 to 4.

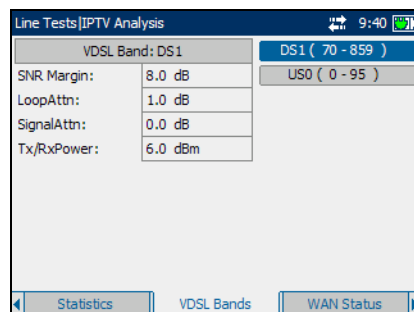

WAN Status

The **WAN Status** tab allows you to view the status of the connection between the wide area network and the ISP.

The available test results are the following:

- **WAN Access** specifies the type of wide area network access, either **Bridged** or **Routed** mode.
- **Status** displays either **Connected** or **Disconnected** for the particular line connection under test.
- **Encapsulat** is the encapsulation method used by the network and consists of the following types.
 - **PPPoE** is point-to-point protocol over Ethernet.
 - **PPPoA** is point-to-point protocol over ATM.
 - **Bridged Ether DHCP** is also known as multi-protocol encapsulation over ATM (MPoA).
 - **IPoA** stands for classical internet protocol over ATM.

Line Tests IPTV Analysis	
WAN Access:	Routed
Status:	Connected
Encapsulat:	BrgdEthernet DHCP
VPI:	0
VCI:	35
Assigned IP:	192.168.0.128
Gateway:	192.168.0.1
Subnet Mask:	255.255.255.0
DNS1:	N/A
DNS2:	N/A

- **VPI** is the virtual path identifier (VPI) ranging from **0** through **255** for the ATM connection.
- **VCI** is the virtual circuit identifier (VCI) ranging from **32** through **65535** for the ATM connection.
- **Assigned IP** is the IP address information assigned to the unit that is actively connected to your network or the internet at the time of login.
- **Gateway** is the IP address of the default gateway.
- **Subnet Mask** is the network address used to identify if the IP address is within the same wide area network.
- **DNS1** is the address of the *primary* domain name server to be used by the unit.
- **DNS2** is the address of the *secondary* domain name server to be used by the unit.

LAN Status

The **LAN Status** tab allows you to view the **Customer Info** configured for the local area network (LAN).

The available information is as follows:

- **STB IP address** is the IP address of the set-top box (STB) connected to the LAN port.
- **STB MAC address** is the MAC address of the STB connected to the LAN port.
- **Subnet Mask** is the network address used to identify if the IP address is within the same local area network.
- **Gateway** is the IP address of the default gateway.

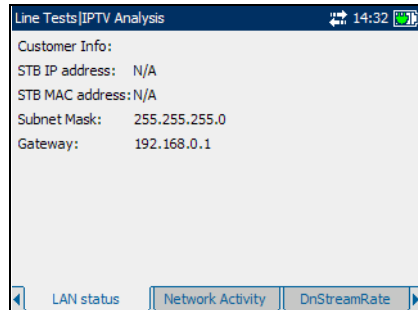

Network Activity

The **Network Activity** tab allows you to view the **PPPoE** (point-to-point protocol over Ethernet), **DHCP** (dynamic host configuration protocol) and **TFTP** (trivial file transfer protocol) mode sessions resulting from the video tests.

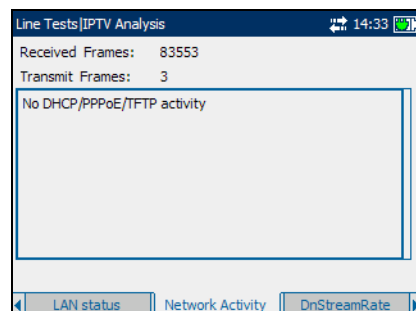

Down Stream Rate

The **DnStreamRate** tab allows you to view the bit rates of different layers related to the IPTV service.

The available test results are the following:

- **Line Rate** is the actual rate achieved by the circuit, in kbps.
- **Ave IP Bit Rate** is the average IP data rate for the IPTV service, including all channels detected.
- **Reset Statistics** button sets all monitoring values to 0.

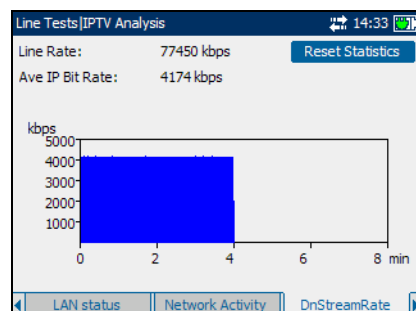

ERR Indicator

The **ERR Indicator** tab allows you to view the errors encountered at the different layers related to the IPTV service.

The available test results are the following:

- **DSL CRC errors/ADSL Errs** displays a count of frames lost at the DSL layer.
- **FEC frame counters/FEC Cnt** displays the number of forward error correction (**FEC**) frames that have been rectified by the Reed-Solomon error correction. When in the “fast” setting, the result will be 0. This parameter is useful for determining if a problem exists based on how many frames required correction.
- **PTM CRCError/PTM Errs** and **ATM HECError/ATM Errs** display a count of frames lost at the transfer mode layer.
- **IP Packet/Pck Loss** is the number of packets lost, with errors, or out of sequence, during the test period.
- **Loss Ratio** is the percentage of IP packet loss during a one second period.
- **Reset Statistics** button sets all monitoring values to 0.

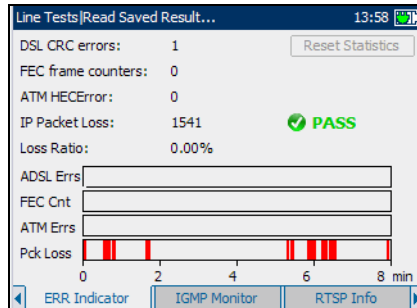

IGMP Monitor

The **IGMP Monitor** tab allows you to confirm that IGMP traffic is being transferred between the central network and STB, and view the statistics.

The available statistics are the following:

- **Queries** counts the number of IGMP queries issued by the network.
- **Join Request** is the number of unsolicited IGMP “joins” issued by the STB or the user.
- **Leave Request** is the number of IGMP “leaves” issued by the STB or the user.
- **Last Request** displays the multicast addresses for **Join/Leave** channels.
- **zap time(ms)** is the time required for a channel change or join, and is one of the key factors to be considered when evaluating the IPTV quality of service (QoS).

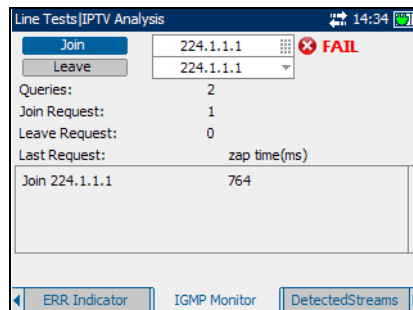

To start/stop reporting:

1. To have the STB send an IGMP report with the multicast IP address, press **Join**.
2. To inform the network to stop sending the current stream, press **Leave**.

RTSP Info

The **RTSP Info** tab allows you to view the media stream sessions established by the real time streaming protocol (RTSP).

The available test results are the following:

- **RTSP Stream** is the IP address of the last RTSP server port.
- **Status** displays a message for the condition of the last RTSP.
- **Res Time** is the response time in ms from video request to incoming video data.
- **StatCode** displays the RTSP status codes defined as follows:
 - 100 - Continue
 - 200 - OK
 - 201 - Created
 - 250 - Low on Storage Space
 - 300 - Multiple Choices
 - 301 - Moved Permanently
 - 302 - Moved Temporarily
 - 303 - See Other
 - 304 - Not Modified
 - 305 - Use Proxy
 - 400 - Bad Request
 - 401 - Unauthorized
 - 402 - Payment Required
 - 403 - Forbidden
 - 404 - Not Found
 - 405 - Method Not Allowed

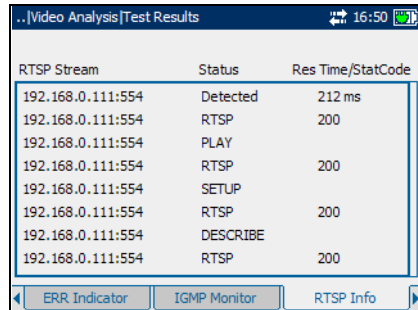

RTSP Stream	Status	Res Time/StatCode
192.168.0.111:554	Detected	212 ms
192.168.0.111:554	RTSP	200
192.168.0.111:554	PLAY	
192.168.0.111:554	RTSP	200
192.168.0.111:554	SETUP	
192.168.0.111:554	RTSP	200
192.168.0.111:554	DESCRIBE	
192.168.0.111:554	RTSP	200

- 406 - Not Acceptable
- 407 - Proxy Authentication Required
- 408 - Request Time-out
- 410 - Gone
- 411 - Length Required
- 412 - Precondition Failed
- 413 - Request Entity Too Large
- 414 - Request-URI Too Large
- 415 - Unsupported Media Type
- 451 - Parameter Not Understood
- 452 - Conference Not Found
- 453 - Not Enough Bandwidth
- 454 - Session Not Found
- 455 - Method Not Valid in This State
- 456 - Header Field Not Valid for Resource
- 457 - Invalid Range
- 458 - Parameter Is Read-Only
- 459 - Aggregate operation not allowed
- 460 - Only aggregate operation allowed
- 461 - Unsupported transport
- 462 - Destination unreachable
- 463 - Key management Failure
- 500 - Internal Server Error
- 501 - Not Implemented
- 502 - Bad Gateway
- 503 - Service Unavailable
- 504 - Gateway Time-out
- 505 - RTSP Version not supported
- 551 - Option not supported

Detected Streams

The **DetectedStreams** tab allows you to view the details of detected video streams.

The available test results are the following:

- **Show Details** button, when pressed, displays a detailed description of the stream including from and to IP addresses and port numbers.
- **Stream IP** is the multicast IP address assigned to a specific channel.
- **Type** describes the video stream as:
 - **RTSP**: video on demand (VOD) or live TV streaming over connection based on RTP/RTSP/TCP or RTSP/TCP.
 - **Unicast**: unicast streaming over connection based on UDP or RTP/UDP.
 - **Multicast**: multicast streaming based on UDP or RTP/UDP.
- **Rates** is the IP packet rate in Kbps for this video stream.
- **Usage** is the percentage of total bandwidth being used by this particular video stream.

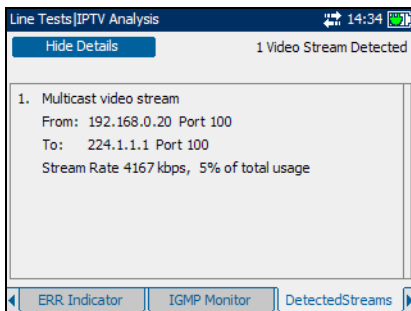

IP Arrival Jitter

The **IP Arrival Jitter** tab allows you to view the **PASS/FAIL** status of the registered **IP Packet Jitter** for the video stream with a selected multicast IP address assigned to the specific video channel or **Analyzed Stream**.

The available test results are the following:

- **Max Recorded Jitter** is the maximum jitter detected, in **ms**.
- **Average Jitter** is the continuous running average of the jitter detected, in **ms**.
- **Standard Deviation** is based on the continuous sample size.
- **Reset Statistics** button clears all monitoring values.

The default monitoring interval is 8 minutes.

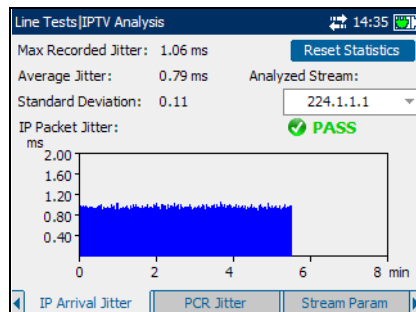

PCR Jitter

The **PCR Jitter** tab allows you to view the **PASS/FAIL** status of the **Peak to Peak PCR Jitter** for the short-term variation in the arrival of the program clock reference (PCR) information at the video decoder.

The available test results are the following:

- **PCR Packets Rate** is the number of received packets monitored over a one-second period.
- **Average Jitter** is the continuous running average of the jitter detected, measured in ms.
- **Analyzed Stream** is the multicast IP address assigned to the specific video channel.
- **Standard Deviation** is based on the continuous sample size.
- **Reset Statistics** button clears all monitoring values.

The default monitoring interval is 8 minutes.

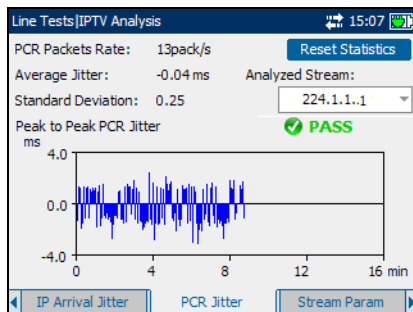

Stream Parameters

The **Stream Param** tab allows you to view the detected video **Stream Rates** and the **PASS/FAIL** status of the multicast IP address assigned to the specific video channel or **Analyzed Stream**.

The available test results are the following:

- **IP Packet** is the IP data rate for the IPTV service, for the selected channel.
- **Transport Rate** is the bit rate calculated based on the program clock reference (PCR).
- **Null Packet Rate** is the rate calculated for MPEG2-TS null packets. Null packets are defined as having no data.
- **MDI** is the media delivery index (MDI) or IP cumulative jitter and packet loss rate for the video stream.
- **DF(Ave)** is the average delay factor (DF) or the average amount of time the video must be delayed in the virtual buffer due to cumulative IP packet jitter and IP packetization.
- **DF(Min)** is the minimum delay factor (DF) or the minimum amount of time the video must be delayed in the virtual buffer due to cumulative IP packet jitter and IP packetization.
- **DF(Max)** is the maximum delay factor (DF) or the maximum amount of time the video must be delayed in the virtual buffer due to cumulative IP packet jitter and IP packetization.
- **VB(Min)** is the minimum virtual buffer (VB).
- **VB(Max)** is the maximum virtual buffer (VB).

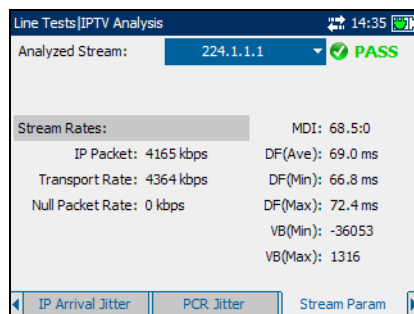

Stream Content

The **Stream Content** tab allows you to view statistical information about the **Video**, **Audio** and **Program Association/Map Table(s)** content for each MPEG video **Analyzed Stream**.

The available statistical results are the following:

- **PID** is a unique integer value or packet identifier (PID) that indicates the type of data that is stored in the packet payload of the video stream.
- **Rate(kbps)** is the rate calculated for a given stream.

Stream Content	PID	Rate(kbps)
Video	300	3797
Audio	301	189
Program Association Table	0	15
Program Map Table	48	15
Program Map Table	60	15
Program Association Table	256	15

HPNA Info

The **HPNA Info** tab allows you to view the results of the HPNA devices detected on the network.

- **Device Detected** displays the total number of detected HPNA devices on the network.

- **Refresh** button allows you to rerun the DevInfo Test and update the page with new data.

- **Device MAC Address** lists all the MAC addresses for the detected HPNA devices.

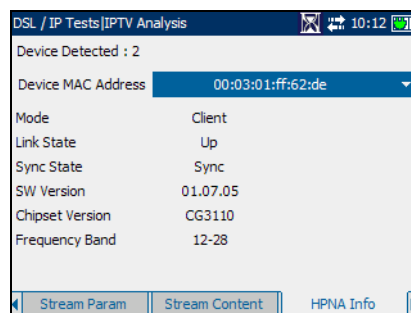

- **Mode** displays **Master** or **Client** for the selected device.
- **Link State** is the **Up** to **Down** (or vice versa) routing protocol of the network link for the selected device.
- **Sync State** is the sync status of the selected device.
- **SW Version** is the software version number of the selected device.
- **Chipset Version** is the version number of the chipset for the selected device.
- **Frequency Band** displays the range of signal frequency for the selected device.

To select a detected device:

1. Press ✓ to open the list.
2. In the list, press the up/down arrows to select the MAC address of the desired device.
3. Press ✓ to confirm the selection and view the results.

HPNA Statistics

The **HPNA Statistics** tab allows you to view counter statistics of the selected HPNA device.

- **Select Device** lists all the MAC addresses of the detected HPNA devices on the network.
- **Tx Packets** is the number of packets sent.
- **Rx Packets** is the number of packets received.
- **Tx Bytes** is the count of bytes sent.
- **Rx Bytes** is the count of bytes received.
- **Rx CRC Packets** is a count of cyclical redundancy check (CRC) errors received.
- **Tx Packets Dropped** is the number of outgoing packets dropped.
- **Rx Packets Dropped** is the number of incoming packets dropped.

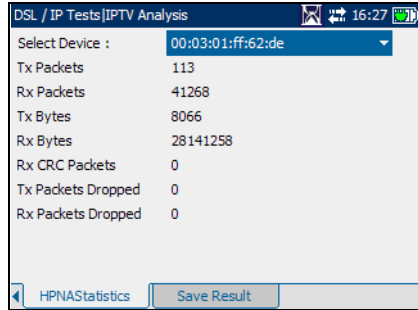

To select a MAC address:

1. Press ✓ to open the list.
2. In the list, press the up/down arrows to select the MAC address of the desired device.
3. Press ✓ to confirm the selection and view the results.

Saving Results

Save Result

The **Save Result** tab allows you to save your test results to a file or to an HTML report.

Each entry on the pane is described as follows:

- **Save as Type** lists the following formats to save your test results:
 - **AXS200 format** is a binary file format with ext *.dat. This format can be opened only on an AXS200 unit. The **Available Graphs** list box will be unavailable in this case.
 - ***.csv** saves only graphical results. Textual results must be formatted as a comma-separated values table for easy importation to Excel. Results are saved to a USB.
 - ***.gif** stands for graphics interchange format and is one of the most common file formats for graphic images on the World Wide Web. Results are saved to a USB.
 - ***.bmp** saves graphical results in a bitmap file format. Results are saved to a USB.
 - ***.xml** saves your data in a common language format to share on the Web.
- **Available Graphs** is enabled only if the selected format under **Save as Type** is ***.gif**, ***.csv**, or ***.bmp**. For a test that does not have a graph, this list box is unavailable.
- **Save Results** button saves the test results in internal or external memory (depending on the **Save as Type** format).

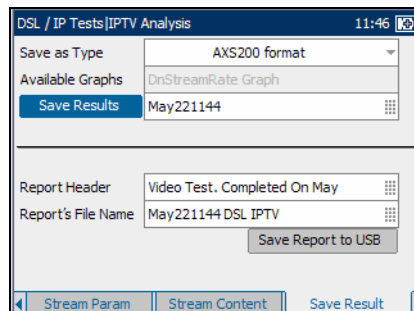

IPTV Analysis

Saving Results

- *Filename* is the current date and time stamp plus you can enter any name. If it already exists, you will be prompted to overwrite the existing file.
- **Report Header** is where you can enter any comment. The initial value is the current test followed by the date and time stamp.
- **Report's File Name** is where you can enter any name for the HTML filename. If the name already exists, you will be prompted to overwrite the existing file. The default extension is .html.

The default name is generated from the current time.

- **Save Report to USB** button saves the results to an HTML report. If a USB memory stick is not inserted, the following warning dialogue box appears: **USB device is not detected.**

To set parameter values and save results:

1. Press the left/right and up/down arrow keys to highlight the desired parameter.
2. Press ✓ to display the list or select the value.
3. Press the up/down arrow key to highlight the desired value.

OR

4. Press the left arrow key to erase the existing value, and then use the alphanumeric keypad to enter a value. To cancel the entry, press ↩.
5. Press ✓ to accept the value.

14 Data Analysis

The purpose of the Data Analysis test function is to have the unit act as a DSL modem allowing you to connect from your computer to the internet via the unit's Ethernet port. The unit will display the connected DSLAM parameters as well as bandwidth utilization, statistics for the IP traffic, and the different protocols detected as you send and receive information.

To view the available tabs:

Press the left/right function arrows on each side of the F1, F2, and F3 keys.

Reading Results

Test Summary

The **Test Summary** tab allows you to view the **PASS/FAIL** status and **Details** of the different tests. If a measured value is out the thresholds configured in the data analysis setup, or if the WAN/LAN connection was not completed successfully, the **Test Summary** pane will display a **FAIL** message.

The available test results are the following:

- **Line Status** displays either **Connected** or **Disconnected** for the particular line connection under test.
- **WAN Status** displays whether the unit is **Connected** to the wide area network, or in idle mode.
- **LAN Status** displays if the unit is **Connected** to the local area network.
- **IP Packets** provides a summary of the total amount of data received (being addressed to) and sent by a specific device on the local network.

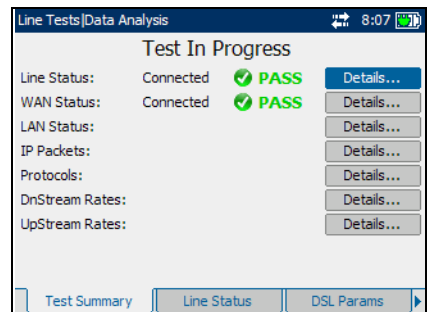

Data Analysis

Reading Results

- **Protocols** presents a summary of the different protocols used by the local network devices.
- **DnStream Rates** displays whether the maximum attainable downstream bit rate that the circuit can handle is within the threshold range.
- **UpStream Rates** displays whether the maximum attainable upstream bit rate that the circuit can handle is within the threshold range.
- **Details** button shortcuts to the applicable tab which provides more information about a particular test result.

To view more information about each available test result:

1. Press the up/down arrows to highlight the **Details** button alongside the desired test result.
2. Press  to select the desired **Details** button.

Line Status

The **Line Status** tab allows you to view the conditions of the line under test which was configured in the connection setup.

The available test results are the following:

- **Line Status** displays **Showtime** when the unit and the DSLAM have successfully connected and negotiated applicable data rates for the particular connection under test. During negotiation with the DSLAM, the value changes from **Booting/DecompressImage/StartProgram/LoadModules/Idle/Activate/Ready/Handshaking/Training** to **Showtime**.
- **Operational Mode** is the DSL mode of operation as negotiated between the unit and the DSLAM.
- **CO VendorID** is a unique 4-digit alphanumeric identifier of the DSL chipset manufacturer used on the central office (CO) side.
- **CO Version** is the version number of the unique alphanumeric identifier of the DSL chipset used on the CO side.

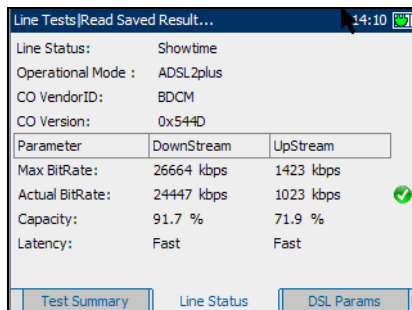

Parameter	DownStream	UpStream
Max BitRate:	26664 kbps	1423 kbps
Actual BitRate:	24447 kbps	1023 kbps
Capacity:	91.7 %	71.9 %
Latency:	Fast	Fast

Data Analysis

Reading Results

- **Parameter** lists the **DownStream** and **UpStream** results for the following parameters:
 - **Max BitRate** displays the maximum attainable bit rates that the circuit can handle as determined by the remote terminal and CO during the training phase. Values can be greater than the actual bit rate.
 - **Actual BitRate** displays the values at which the unit and CO are connected, as negotiated during the training phase. The values should represent what the CO was set to, unless the DSL link is being subjected to high levels of noise/crosstalk, and are typically what the DSLAM has been set to, whether interleaved or fast.
 - **Capacity** is the capacity of the line as a ratio of achieved bit rate over the maximum attainable bit rate (Max BitRate) presented as a percentage (%). A high value could mean that the link is nearing its maximum capabilities while a low value could mean the link is being under utilized (sometimes intentionally – verify your local DSLAM setup).
 - **Latency** is the path type, **Fast** or **Interleave**, set by the service provider at the CO. The use of the interleaved path means greater delay in the delivery of data but it is less susceptible to noise or crosstalk due to increased Reed-Solomon coding and forward error checking (FEC). The use of the fast path means little of no delay in the delivery of data but it is more susceptible to noise and crosstalk.

When set up over Ethernet, the available test results are the following:

- **Line Status** displays either **Connected** or **Disconnected** for the particular line connection under test.
- **LinkSpeed** is a choice between **AUTO** (negotiated during the link establishment), **100** or **10 Mbps**.
- **ConnectMode** is **FULL_DUP** or **HALF_DUP**, when **Link Speed** is set to either **100** or **10 Mbps**.

DSL Parameters

The **DSL Params** tab allows you to view the pass/fail status of the **DownStream** and **UpStream** parameters configured in the test setup.

The available test results are the following:

- **SNR Margin** is a value ranging from 0 through 63.5 for the minimum signal-to-noise ratio margin.
- **Attenuation** is a value ranging from 0 through 63.5 for the maximum attenuation.
- **Output Power** is the current transmit power level that is a measure of the absolute transmit power.
- **INP** is the level of impulse noise protection.
- **Interl.Depth** is interleave depth which defines the number of bits (or bytes) in each block of data.
- **Interl.Delay** is interleave delay which defines the mapping (relative spacing) between subsequent input bytes at the interleave input and their placement in the bit stream at the interleave output.
- **Trellis** or Trellis Coded Modulation (TCM) is a type of convolutional code which utilizes parity bits on each symbol within a continuous data stream. When the line is connected, Trellis displays either **ON** or **OFF**.
- **BITSwap** specifies the status of the bit swapping mechanism - **Active**, **Not Active** or **Unknown** - swapping bits from tone *m* to tone *n* to prevent modem retraining.

Parameter	DownStream	UpStream
SNR Margin:	8.0 dB	0.0 dB
Attenuation	0.0 dB	0.0 dB
Output Power:	0.0 dBm	-33.0 dBm
INP:	1.0	1.0
Interl.Depth:	349	41
Interl.Delay:	4.0 ms	4.0 ms
TRELLIS:	ON	ON
BITSwap:	Active	Active

Statistics

The **Statistics** tab allows you to view transfer mode statistics and DSL counters.

The available test results are:

- **TransportType** options include packet transfer mode (**PTM**) and is the asynchronous transfer mode (**ATM**).
- **SyncLostCount** is the number of times the unit lost synchronization.
- **Received Bytes** is the number of active (non-idle) PTM/ATM cells or frames received on a channel.
- **Transmit Bytes** records the number of active (non-idle) PTM/ATM cells or frames transmitted on a channel.
- **DSL Counters** lists the **Local** and **Remote** results for the following counters:
 - **CRC** is the cyclical redundancy check (**CRC**) Interleaved/Fast counter.
 - **HEC** is the header error check (**HEC**) Interleaved/Fast counter.
 - **FEC** is the Reed Solomon forward error check (**FEC**) Interleaved/Fast counter.
 - **FEC Seconds** is the number of seconds when FEC is detected.
 - **Error Seconds** is the number of seconds when code violation is detected.
- **Reset Counters** button sets all counters to 0.

ADSL Counters	Local	Remote
CRC:	0	0
HEC:	0	0
FEC:	0	0
Error Seconds:	0	3

VDSL Bands

The **VDSL Bands** tab allows you to view the VDSL parameters negotiated by the unit and central office, configured in the connection setup.

The available test results are the following:

- **SNR Margin** is the measured current signal-to-noise ratio (SNR) margin across all active sub-channels, as an amount of increased noise relative to the measured noise power that the system would be able to tolerate to maintain a bit error rate of 10⁻⁷.
- **LoopAttn** is the current reduction of the line.
- **SignalAttn** is the current reduction of the signal.
- **Tx Power** is the upstream/downstream transmitting power for the selected band.
- **DS0-4** button displays the downstream parameters for different VDSL bands 0 to 4.
- **US0-4** button displays the upstream parameters for different VDSL bands 0 to 4.

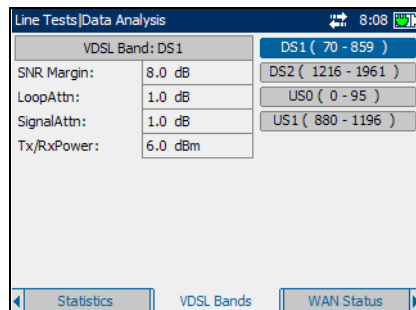

WAN Status

The **WAN Status** tab allows you to view the status of the connection between the wide area network and the ISP.

The available test results are the following:

- **WAN Access** specifies the type of wide area network access, either **Bridged** or **Routed** mode.
- **Status** displays either **Connected** or **Disconnected** for the particular line connection under test.
- **Encapsulat** is the encapsulation method used by the network and consists of the following types.
 - **PPPoE** is point-to-point protocol over Ethernet.
 - **PPPoA** is point-to-point protocol over ATM.
 - **Bridged Ether DHCP** is also known as multi-protocol encapsulation over ATM (MPoA).
 - **IPoA** stands for classical internet protocol over ATM.

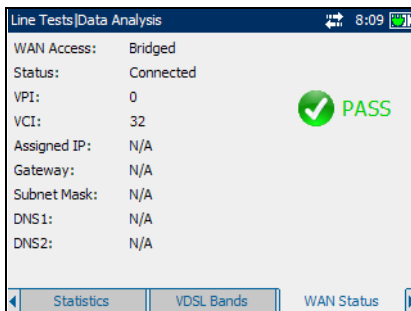

- **VPI** is the virtual path identifier (VPI) ranging from **0** through **255** for the ATM connection.
- **VCI** is the virtual circuit identifier (VCI) ranging from **32** through **65535** for the ATM connection.
- **Assigned IP** is the IP address information assigned to the unit that is actively connected to your network or the internet at the time of login.
- **Gateway** is the IP address of the default gateway.
- **Subnet Mask** is the network address used to identify if the IP address is within the same wide area network.
- **DNS1** is the address of the *primary* domain name server to be used by the unit.
- **DNS2** is the address of the *secondary* domain name server to be used by the unit.

LAN Status

The **LAN Status** tab allows you to view the customer information configured for the local area network (LAN).

The available information is as follows:

- **Client IP** is the IP address of the network device connected to the LAN port.
- **Client MAC Addr** is the MAC address of the network device connected to the LAN port.
- **LAN IP** is the local network IP address of the unit.
- **LAN SubMask** is the network address mask used to identify if the IP address is within the same local area network.

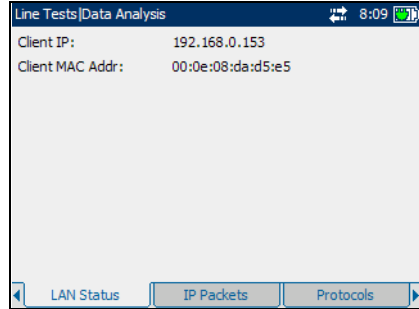

IP Packets

The **IP Packets** tab allows you to view the IP traffic statistics summary of the total amount of data **Received** (being addressed to) and sent (**Transmit**) for each **Client IP** address.

- **Client IP** the source IP address of the different requests.
- **Reset Statistics** button clears all monitoring information.

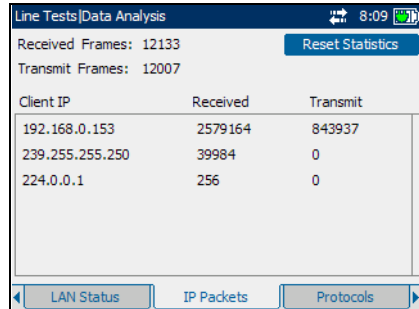

Protocols

The **Protocols** tab allows you to view a summary of the different protocols detected by the local network devices.

The screen identifies the source IP address (**Client IP Address**) of the different requests, as well as the amount of transmitted (**Download**) and received (**Upload**) information.

Protocols are displayed in reverse order with the most recent activity first.

Protocol Filter lists the different types of protocols that can be monitored such as: **RTP**, **SIP**, **MGCP**, **SCCP**, and **HTTP**.

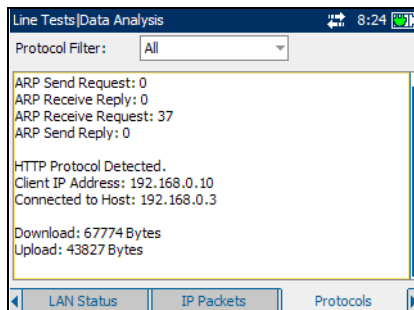

Down Stream Rates

The **DnStream Rates** tab allows you to view the maximum achieved downstream data rates for the data stream layers of the connection.

The available test results are the following:

- **DSL Rate (kbps)** is the actual downstream rate for the DSL layer.
- **Max DownStream Rate (kbps)** is the maximum downstream rate of the data stream for the connection.
- **Reset Statistics** button sets all monitoring values to 0.

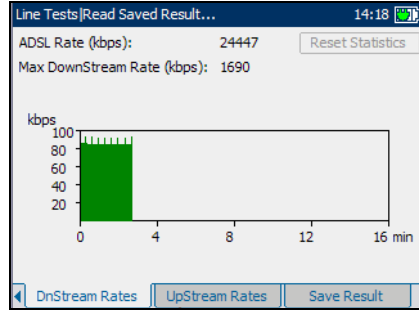

Up Stream Rates

The **UpStream Rates** tab allows you to view the maximum achieved upstream data rates for the data stream layers of the connection.

The available test results are the following:

- **DSL Rate (kbps)** is the actual upstream rate for the DSL layer.
- **Max UpStream Rate (kbps)** is the maximum upstream rate of the data stream for the connection.
- **Reset Statistics** button sets all monitoring values to 0.

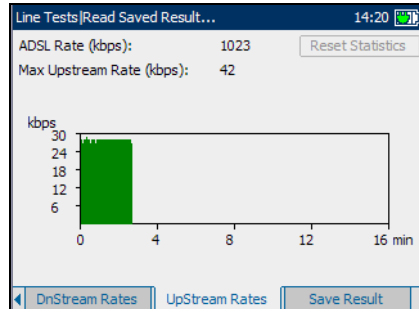

HPNA Info

The **HPNA Info** tab allows you to view the results of the HPNA devices detected on the network.

- **Device Detected** displays the total number of detected HPNA devices on the network.
- **Refresh** button allows you to rerun the DevInfo Test and update the page with new data.
- **Device MAC Address** lists all the MAC addresses for the detected HPNA devices.
- **Mode** displays **Master** or **Client** for the selected device.
- **Link State** is the **Up** to **Down** (or vice versa) routing protocol of the network link for the selected device.
- **Sync State** is the sync status of the selected device.
- **SW Version** is the software version number of the selected device.
- **Chipset Version** is the version number of the chipset for the selected device.
- **Frequency Band** displays the range of signal frequency for the selected device.

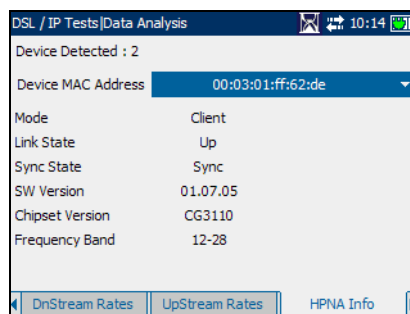

To select a detected device:

1. Press ✓ to open the list.
2. In the list, press the up/down arrows to select the MAC address of the desired device.
3. Press ✓ to confirm the selection and view the results.

HPNA Statistics

The **HPNA Statistics** tab allows you to view counter statistics of the selected HPNA device.

- **Select Device** lists all the MAC addresses of the detected HPNA devices on the network.
- **Tx Packets** is the number of packets sent.
- **Rx Packets** is the number of packets received.
- **Tx Bytes** is the count of bytes sent.
- **Rx Bytes** is the count of bytes received.
- **Rx CRC Packets** is a count of cyclical redundancy check (CRC) errors received.
- **Tx Packets Dropped** is the number of outgoing packets dropped.
- **Rx Packets Dropped** is the number of incoming packets dropped.

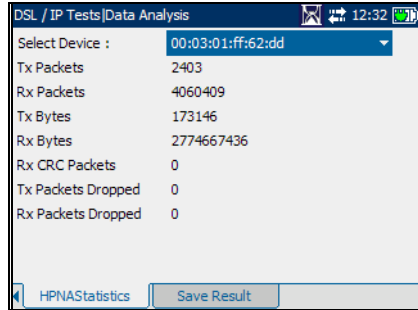

To select a MAC address:

1. Press ✓ to open the list.
2. In the list, press the up/down arrows to select the MAC address of the desired device.
3. Press ✓ to confirm the selection and view the results.

Saving Results

Save Result

The **Save Result** tab allows you to save your test results to a file or to an HTML report.

The available entries are the following:

- **Save as Type** lists the following formats to save your test results:
 - **AXS200 format** is a binary file format with ext *.dat. This format can be opened only on an AXS200 unit. The **Available Graphs** list box will be unavailable in this case.
 - ***.csv** saves only graphical results. Textual results must be formatted as a comma-separated values table for easy importation to Excel. Results are saved to a USB.
 - ***.gif** stands for graphics interchange format and is one of the most common file formats for graphic images on the World Wide Web. Results are saved to a USB.
 - ***.bmp** saves graphical results in a bitmap file format. Results are saved to a USB.
 - ***.xml** saves your data in a common language format to share on the Web.
- **Available Graphs** is enabled only if the selected format under **Save as Type** is ***.gif**, ***.csv**, or ***.bmp**. For a test that does not have a graph, this list box is unavailable.
- **Save Results** button saves the test results in internal or external memory (depending on the **Save as Type** format).

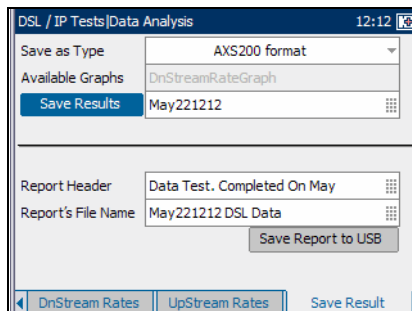

Data Analysis

Saving Results

- *Filename* is the current date and time stamp plus you can enter any name. If it already exists, you will be prompted to overwrite the existing file.
- **Report Header** is where you can enter any comment. The initial value is the current test followed by the date and time stamp.
- **Report's File Name** is where you can enter any name for the HTML filename. If the name already exists, you will be prompted to overwrite the existing file. The default extension is .html.

The default name is generated from the current time.

- **Save Report to USB** button saves the results to an HTML report. If a USB memory stick is not inserted, the following warning dialogue box appears: **USB device is not detected.**

To set parameter values and save results:

1. Press the left/right and up/down arrow keys to highlight the desired parameter.
2. Press ✓ to display the list or select the value.
3. Press the up/down arrow key to highlight the desired value.

OR

4. Press the left arrow key to erase the existing value, and then use the alphanumeric keypad to enter a value. To cancel the entry, press ↩.
5. Press ✓ to accept the value.

15 Running a VoIP Test

The purpose of the VoIP analysis test function is to allow you to configure the unit for VoIP testing. During the analysis, the unit determines the DSL and IP packet rate, and calculates jitter, packet loss, and packet delay. Results are displayed on the following tabs.

To view the available tabs:

Press the left/right function arrows on each side of the F1, F2, and F3 keys.

Reading Results

Summary

The **Summary** tab allows you to view the **PASS/FAIL** status and **Details** of the different tests. If a measured value is out the thresholds configured in the VoIP analysis setup, or if the WAN/LAN connection was not completed successfully, the **Summary** pane will display a **FAIL** message.

The available test results are the following:

- **Line Status** displays either **Connected** or **Disconnected** for the particular line connection under test.
- **WAN Status** displays whether the unit is **Connected** to the wide area network, or in idle mode.
- **LAN Status** displays if the unit is **Connected** to the local area network.
- **Network Activity** displays whether or not voice protocol registration activity is detected.
- **Call History** specifies the signaling protocol being used and determines the state of the call along with the call flow.
- **Pcks Analysis** displays the status of the percentage of packets of varying inter-arrival rates that are within 10 milliseconds of each other.

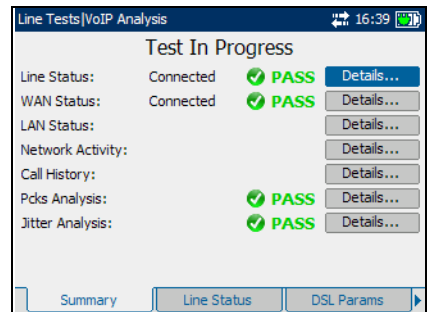

Running a VoIP Test

Reading Results

- **Jitter Analysis** is the status of the quality of the call by displaying an estimate of the variance of the real-time transport protocol (RTP) data packet inter-arrival time.
- **Details** button shortcuts to the applicable tab which provides more information about a particular test result.

To view more information about each available test result:

1. Press the up/down arrows to highlight the **Details** button alongside the desired test result.
2. Press  to select the desired **Details** button.

Line Status

The **Line Status** tab allows you to view the conditions of the line under test which was configured in the connection setup.

The available test results are the following:

- **Line Status** displays **Showtime** when the unit and the DSLAM have successfully connected and negotiated applicable data rates for the particular connection under test. During negotiation with the DSLAM, the value changes from **Booting/DecompressImage/StartProgram/LoadModules/Idle/Activate/Ready/Handshaking/Training** to **Showtime**.

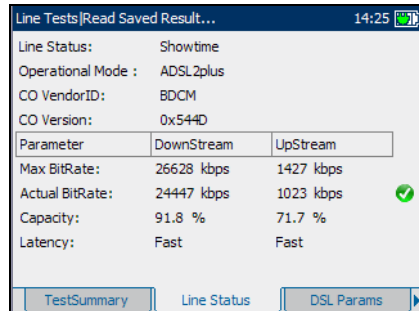

The screenshot shows a window titled "Line Tests|Read Saved Result..." with a timestamp of 14:25. The window displays the following information:

Line Status:	Showtime	
Operational Mode :	ADSL2plus	
CO VendorID :	BDCM	
CO Version :	0x544D	
Parameter	DownStream	UpStream
Max BitRate:	26628 kbps	1427 kbps
Actual BitRate:	24447 kbps	1023 kbps
Capacity:	91.8 %	71.7 %
Latency:	Fast	Fast

At the bottom of the window, there are three tabs: "TestSummary", "Line Status" (which is selected), and "DSL Params". A green checkmark is visible next to the "Actual BitRate" row.

- **Operational Mode** is the DSL mode of operation as negotiated between the unit and the DSLAM.
- **CO VendorID** is a unique 4-digit alphanumeric identifier of the DSL chipset manufacturer used on the central office (CO) side.
- **CO Version** is the version number of the unique alphanumeric identifier of the DSL chipset used on the CO side.

- **Parameter** lists the **DownStream** and **UpStream** results for the following parameters:
 - **Max BitRate** displays the maximum attainable bit rates that the circuit can handle as determined by the remote terminal and CO during the training phase. Values can be greater than the actual bit rate.
 - **Actual BitRate** displays the values at which the unit and CO are connected, as negotiated during the training phase. The values should represent what the CO was set to, unless the DSL link is being subjected to high levels of noise/crosstalk, and are typically what the DSLAM has been set to, whether interleaved or fast.
 - **Capacity** is the capacity of the line as a ratio of achieved bit rate over the maximum attainable bit rate (Max BitRate) presented as a percentage (%). A high value could mean that the link is nearing its maximum capabilities while a low value could mean the link is being under utilized (sometimes intentionally – verify your local DSLAM setup).
 - **Latency** is the path type, **Fast** or **Interleave**, set by the service provider at the CO. The use of the interleaved path means greater delay in the delivery of data but it is less susceptible to noise or crosstalk due to increased Reed-Solomon coding and forward error checking (FEC). The use of the fast path means little of no delay in the delivery of data but it is more susceptible to noise and crosstalk.

When set up over Ethernet, the available test results are the following:

- **Line Status** displays either **Connected** or **Disconnected** for the particular line connection under test.
- **LinkSpeed** is a choice between **AUTO** (negotiated during the link establishment), **100** or **10 Mbps**.
- **ConnectMode** is **FULL_DUP** or **HALF_DUP**, when **Link Speed** is set to either **100** or **10 Mbps**.

DSL Parameters

The **DSL Params** tab allows you to view the pass/fail status of the **DownStream** and **UpStream** parameters configured in the test setup.

The available test results are the following:

- **SNR Margin** is a value ranging from 0 through 63.5 for the minimum signal-to-noise ratio margin.
- **Attenuation** is a value ranging from 0 through 63.5 for the maximum attenuation.
- **Output Power** is the current transmit power level that is a measure of the absolute transmit power.
- **INP** is the level of impulse noise protection.
- **Interl.Depth** is interleave depth which defines the number of bits (or bytes) in each block of data.
- **Interl.Delay** is interleave delay which defines the mapping (relative spacing) between subsequent input bytes at the interleave input and their placement in the bit stream at the interleave output.
- **Trellis** or Trellis Coded Modulation (TCM) is a type of convolutional code which utilizes parity bits on each symbol within a continuous data stream. When the line is connected, Trellis displays either **ON** or **OFF**.
- **BITSwap** specifies the status of the bit swapping mechanism - **Active**, **Not Active** or **Unknown** - swapping bits from tone *m* to tone *n* to prevent modem retraining.

Parameter	DownStream	UpStream	
SNR Margin:	7.0 dB	0.0 dB	✘
Attenuation	0.0 dB	0.0 dB	✔
Output Power:	0.0 dBm	-33.0 dBm	
INP:	1.0	1.0	
Interl.Depth:	349	33	
Interl.Delay:	4.0 ms	4.0 ms	
TRELLIS:	ON	ON	
BITSwap:	Active	Active	

Summary | Line Status | DSL Params

Statistics

The **Statistics** tab allows you to view transfer mode statistics and DSL counters.

The available test results are:

- **TransportType** options include packet transfer mode (**PTM**) and is the asynchronous transfer mode (**ATM**).
- **SyncLostCount** is the number of times the unit lost synchronization.
- **Received Bytes** is the number of active (non-idle) PTM/ATM cells or frames received on a channel.
- **Transmit Bytes** records the number of active (non-idle) PTM/ATM cells or frames transmitted on a channel.
- **DSL Counters** lists the **Local** and **Remote** results for the following counters:
 - **CRC** is the cyclical redundancy check (**CRC**) Interleaved/Fast counter.
 - **HEC** is the header error check (**HEC**) Interleaved/Fast counter.
 - **FEC** is the Reed Solomon forward error check (**FEC**) Interleaved/Fast counter.
 - **FEC Seconds** is the number of seconds when FEC is detected.
 - **Error Seconds** is the number of seconds when code violation is detected.
- **Reset Counters** button sets all counters to 0.

Line Tests Read Saved Result... 14:27		
TransportType:	ATM	<input type="button" value="Reset Counters"/>
SyncLostCount:	0	
Received Bytes:	1433424	
Transmit Bytes:	1342320	
ADSL Counters	Local	Remote
CRC:	0	0
HEC:	0	0
FEC:	0	0
Error Seconds:	0	3

Running a VoIP Test

Reading Results

VDSL Bands

The **VDSL Bands** tab allows you to view the VDSL parameters negotiated by the unit and central office, configured in the connection setup.

The available test results are the following:

- **SNR Margin** is the measured current signal-to-noise ratio (SNR) margin across all active sub-channels, as an amount of increased noise relative to the measured noise power that the system would be able to tolerate to maintain a bit error rate of 10⁻⁷.
- **LoopAttn** is the current reduction of the line.
- **SignalAttn** is the current reduction of the signal.
- **Tx Power** is the upstream/downstream transmitting power for the selected band.
- **DS0-4** button displays the downstream parameters for different VDSL bands 0 to 4.
- **US0-4** button displays the upstream parameters for different VDSL bands 0 to 4.

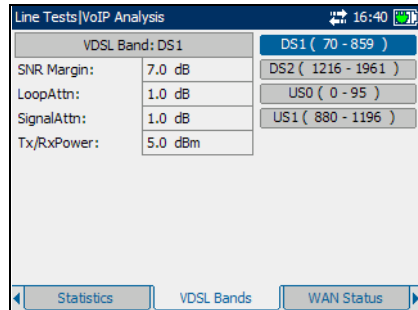

WAN Status

The **WAN Status** tab allows you to view the status of the connection between the wide area network and the ISP.

The available test results are the following:

- **WAN Access** specifies the type of WAN access, either **Bridged** or **Routed** mode.
- **Status** displays either **Connected** or **Disconnected** for the particular line connection under test.
- **Encapsulat** is the encapsulation method used by the network and consists of four types.
 - **PPPoE** is point-to-point protocol over Ethernet.
 - **PPPoA** is point-to-point protocol over ATM.
 - **Bridged Ether DHCP** is also known as multi-protocol encapsulation over ATM (MPoA).
 - **IPoA** stands for classical internet protocol over ATM.
- **VPI** is the virtual path identifier (VPI) ranging from **0** through **255** for the ATM connection.
- **VCI** is the virtual circuit identifier (VCI) ranging from **32** through **65535** for the ATM connection.
- **Assigned IP** is the IP address information assigned to the unit that is actively connected to your network or the internet at the time of login.
- **Gateway** is the IP address of the default gateway.
- **Subnet Mask** is the network address used to identify if the IP address is within the same wide area network.

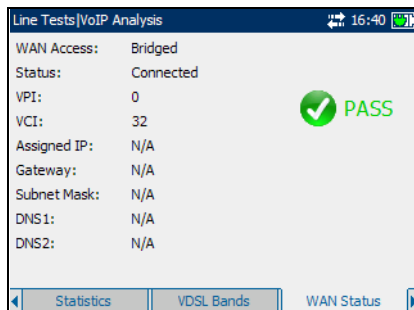

Running a VoIP Test

Reading Results

- **DNS1** is the address of the *primary* domain name server to be used by the unit.
- **DNS2** is the address of the *secondary* domain name server to be used by the unit.

LAN Status

The **LAN Status** tab allows you to view the customer information configured for the local area network (LAN).

The available information is as follows:

- **Client IP** is the IP address of the network device connected to the LAN port.
- **Client MAC Addr** is the MAC address of the network device connected to the LAN port.
- **LAN IP** is the local network IP address of the unit.
- **LAN SubMask** is the network address mask used to identify if the IP address is within the same local area network.

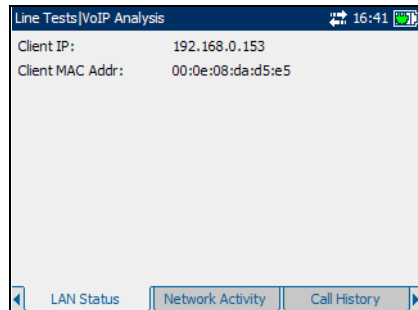

Network Activity

The **Network Activity** tab allows you to view the **PPoE** (Point-to-Point Protocol over Ethernet), **DHCP** (Dynamic Host Configuration Protocol) and **TFTP** (Trivial File Transfer Protocol) mode sessions resulting from the voice tests. It displays whether or not registration activity for the voice protocol is detected.

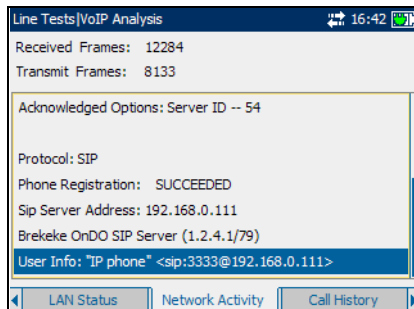

SIP (Session Initiation Protocol) is a signalling protocol used for establishing sessions in an IP network.

Call History

The **Call History** tab allows you to view the detailed call flow of the detected voice protocol. **SIP** (Session Initiation Protocol) is a signalling protocol used for establishing sessions in an IP network.

The **Clear History** button clears all information displayed.

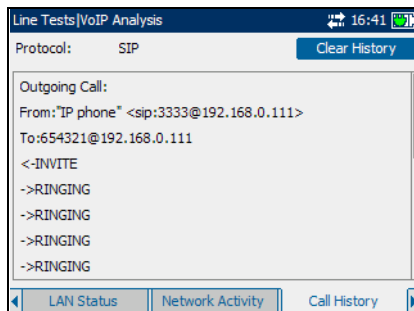

Running a VoIP Test

Reading Results

Packets Analysis

The **Pcks Analysis** tab allows you to view the **PASS/FAIL** status of the percentage of packets of varying inter-arrival rates that are within 10 milliseconds of each other.

The available test results are the following:

- **Codec** is the VoIP coder/decoder in use as detected by the unit.
- **Received Packets** display the total number of received VoIP packets.
- **Lost Packet** is the total number of lost VoIP packets that were never received during the conversation.
- **Dupl/OOS Packet** is the total number of duplicated (Dupl) or out of sequence (OOS) packets.
- **Invalid Packet(%)** represents a QoS reference factor of lost packets detected during the VoIP conversation.
- **Reset Statistics** button sets all monitoring values to 0.

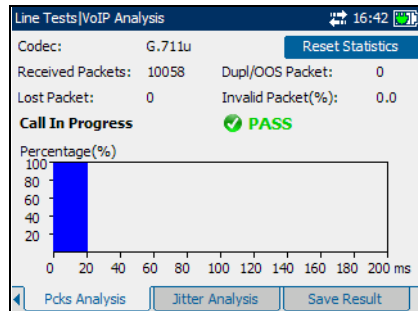

Jitter Analysis

The **Jitter Analysis** tab allows you to view the **PASS/FAIL** status of the quality of the call by displaying an estimate of the variance of the real-time transport protocol (RTP) data packet inter-arrival time.

The available test results are:

- **Jitter Average** is the continuous running average jitter.
- **Jitter Maximum** is the maximum jitter detected.
- **Std. Deviation** is the standard deviation based on the continuous sample size.
- **Reset Statistics** button sets all monitoring values to 0.

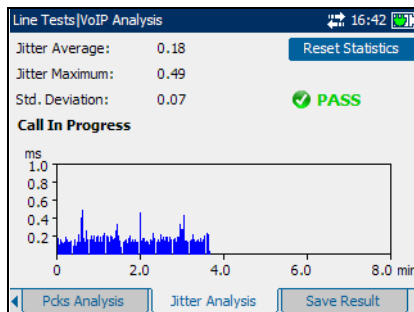

HPNA Info

The **HPNA Info** tab allows you to view the results of the HPNA devices detected on the network.

- **Device Detected** displays the total number of detected HPNA devices on the network.
- **Refresh** button allows you to rerun the DevInfo Test and update the page with new data.
- **Device MAC Address** lists all the MAC addresses for the detected HPNA devices.
- **Mode** displays **Master** or **Client** for the selected device.
- **Link State** is the **Up** to **Down** (or vice versa) routing protocol of the network link for the selected device.
- **Sync State** is the sync status of the selected device.
- **SW Version** is the software version number of the selected device.
- **Chipset Version** is the version number of the chipset for the selected device.
- **Frequency Band** displays the range of signal frequency for the selected device.

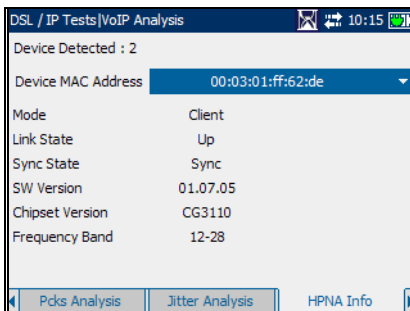

To select a detected device:

1. Press ✓ to open the list.
2. In the list, press the up/down arrows to select the MAC address of the desired device.
3. Press ✓ to confirm the selection and view the results.

HPNA Statistics

The **HPNA Statistics** tab allows you to view counter statistics of the selected HPNA device.

- **Select Device** lists all the MAC addresses of the detected HPNA devices on the network.
- **Tx Packets** is the number of packets sent.
- **Rx Packets** is the number of packets received.
- **Tx Bytes** is the count of bytes sent.
- **Rx Bytes** is the count of bytes received.
- **Rx CRC Packets** is a count of cyclical redundancy check (CRC) errors received.
- **Tx Packets Dropped** is the number of outgoing packets dropped.
- **Rx Packets Dropped** is the number of incoming packets dropped.

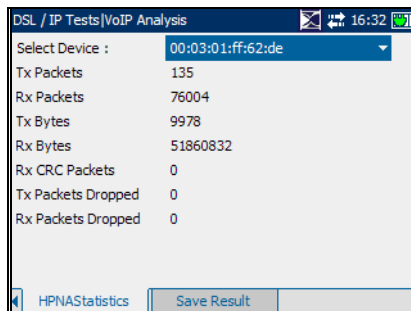

The screenshot shows a window titled "DSL / IP Tests | VoIP Analysis" with a clock showing 16:32. The window displays the following statistics for a selected device with MAC address 00:03:01:ff:62:de:

Select Device :	00:03:01:ff:62:de
Tx Packets	135
Rx Packets	76004
Tx Bytes	9978
Rx Bytes	51860832
Rx CRC Packets	0
Tx Packets Dropped	0
Rx Packets Dropped	0

At the bottom of the window, there are two buttons: "HPNAStatistics" and "Save Result".

To select a MAC address:

1. Press ✓ to open the list.
2. In the list, press the up/down arrows to select the MAC address of the desired device.
3. Press ✓ to confirm the selection and view the results.

Saving Results

Save Result

The **Save Result** tab allows you to save your test results to a file or to an HTML report.

The available entries are the following:

- **Save as Type** lists the following formats to save your test results:
 - **AXS200 format** is a binary file format with ext *.dat. This format can be opened only on an AXS200 unit. The **Available Graphs** list box will be unavailable in this case.
 - ***.csv** saves only graphical results. Textual results must be formatted as a comma-separated values table for easy importation to Excel. Results are saved to a USB.
 - ***.gif** stands for graphics interchange format and is one of the most common file formats for graphic images on the World Wide Web. Results are saved to a USB.
 - ***.bmp** saves graphical results in a bitmap file format. Results are saved to a USB.
 - ***.xml** saves your data in a common language format to share on the Web.
- **Available Graphs** is enabled only if the selected format under **Save as Type** is ***.gif**, ***.csv**, or ***.bmp**. For a test that does not have a graph, this list box is unavailable.
- **Save Results** button saves the test results in internal or external memory (depending on the **Save as Type** format).

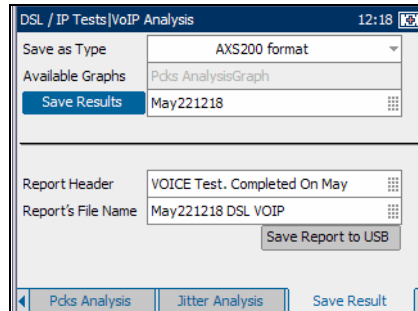

- *Filename* is the current date and time stamp plus you can enter any name. If it already exists, you will be prompted to overwrite the existing file.
- **Report Header** is where you can enter any comment. The initial value is the current test followed by the date and time stamp.
- **Report's File Name** is where you can enter any name for the HTML filename. If the name already exists, you will be prompted to overwrite the existing file. The default extension is .html.

The default name is generated from the current time.

- **Save Report to USB** button saves the results to an HTML report. If a USB memory stick is not inserted, the following warning dialogue box appears: **USB device is not detected.**

To set parameter values and save results:

1. Press the left/right and up/down arrow keys to highlight the desired parameter.
2. Press ✓ to display the list or select the value.
3. Press the up/down arrow key to highlight the desired value.

OR

4. Press the left arrow key to erase the existing value, and then use the alphanumeric keypad to enter a value. To cancel the entry, press ↩.
5. Press ✓ to accept the value.

16 *Maintenance*

General Maintenance

To help ensure long, trouble-free operation:

- Keep the unit free of dust.
- Clean the unit casing and front panel with a cloth slightly dampened with water.
- Store unit at room temperature in a clean and dry area. Keep the unit out of direct sunlight.
- Avoid high humidity or significant temperature fluctuations.
- Avoid unnecessary shocks and vibrations.
- If any liquids are spilled on or into the unit, turn off the power immediately and let the unit dry completely.



WARNING

Use of controls, adjustments, and procedures for operation and maintenance other than those specified herein may result in hazardous radiation exposure.

Battery Charging and Replacing

Charging the AXS-200/635 battery can take up to 1.5 hours. This battery was custom made for your unit; replacement batteries must be ordered from EXFO.

For more information about the battery, refer to the *Maintenance* chapter of the AXS-200 User Guide.

Maintenance

Recycling and Disposal (Applies to European Union Only)

Recycling and Disposal (Applies to European Union Only)



Recycle or dispose of your product (including electric and electronic accessories) properly, in accordance with local regulations. Do not dispose of it in ordinary garbage receptacles.

This equipment was sold after August 13, 2005 (as identified by the black rectangle).





- Unless otherwise noted in a separate agreement between EXFO and a customer, distributor, or commercial partner, EXFO will cover costs related to the collection, treatment, recovery, and disposal of end-of-lifecycle waste generated by electronic equipment introduced after August 13, 2005 to an European Union member state with legislation regarding Directive 2002/96/EC.
- Except for reasons of safety or environmental benefit, equipment manufactured by EXFO, under its brand name, is generally designed to facilitate dismantling and reclamation.

For complete recycling/disposal procedures and contact information, visit the EXFO Web site at www.exfo.com/recycle.

17 Troubleshooting

Solving Common Problems

The table below presents common problems and their solution.

Problem	Possible Cause	Solution
Impossible to turn on unit.	<ul style="list-style-type: none">▶ You did not press  long enough.▶ Main batteries discharged.▶ Battery compartment door is open.▶ One of the two batteries is missing.▶ Weather too cold.	<ul style="list-style-type: none">▶ Press  for 2 seconds.▶ Charge batteries by connecting the AC adapter/charger.▶ Close battery compartment door.▶ Insert 2 batteries and replace battery compartment door.
The display is almost blank when you turn on the unit.	Brightness may need some adjustment.	Press  to adjust brightness properly.
Batteries do not charge as expected.	<ul style="list-style-type: none">▶ Temperature is too high.▶ Battery is incorrectly connected.	<ul style="list-style-type: none">▶ Ensure temperature is within specifications.▶ Ensure battery is connected properly.
A battery status LED is yellow.	Battery is defective.	Contact EXFO or replace the battery.
The unit is not responding.		Shut down the unit by pressing  and holding it down. You will hear a first beep; release the key after you hear a second beep. Turn the unit on again to reset it.

Troubleshooting

Contacting the Technical Support Group

Contacting the Technical Support Group

To obtain after-sales service or technical support for this product, contact EXFO at one of the following numbers. The Technical Support Group is available to take your calls from Monday to Friday, 8:00 a.m. to 7:00 p.m. (Eastern Time in North America).

For detailed information about technical support, visit the EXFO Web site at www.exfo.com.

Technical Support Group

400 Godin Avenue
Quebec (Quebec) G1M 2K2
CANADA

1 866 683-0155 (USA and Canada)
Tel.: 1 418 683-5498
Fax: 1 418 683-9224
support@exfo.com

To accelerate the process, please have information such as the name and the serial number (see the product identification label—an example is shown below), as well as a description of your problem, close at hand.

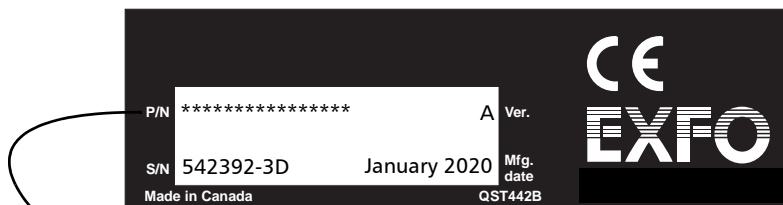

AXS-635-XX-XX-XX

DSL modules
DSL software options
Copper software options

Transportation

Maintain a temperature range within specifications when transporting the unit. Transportation damage can occur from improper handling. The following steps are recommended to minimize the possibility of damage:

- Pack the unit in its original packing material when shipping.
- Avoid high humidity or large temperature fluctuations.
- Keep the unit out of direct sunlight.
- Avoid unnecessary shocks and vibrations.

18 *Warranty*

General Information

EXFO Electro-Optical Engineering Inc. (EXFO) warrants this equipment against defects in material and workmanship for a period of one year from the date of original shipment. EXFO also warrants that this equipment will meet applicable specifications under normal use.

During the warranty period, EXFO will, at its discretion, repair, replace, or issue credit for any defective product, as well as verify and adjust the product free of charge should the equipment need to be repaired or if the original calibration is erroneous. If the equipment is sent back for verification of calibration during the warranty period and found to meet all published specifications, EXFO will charge standard calibration fees.



IMPORTANT

The warranty can become null and void if:

- unit has been tampered with, repaired, or worked upon by unauthorized individuals or non-EXFO personnel.
- warranty sticker has been removed.
- case screws, other than those specified in this guide, have been removed.
- case has been opened, other than as explained in this guide.
- unit serial number has been altered, erased, or removed.
- unit has been misused, neglected, or damaged by accident.

THIS WARRANTY IS IN LIEU OF ALL OTHER WARRANTIES EXPRESSED, IMPLIED, OR STATUTORY, INCLUDING, BUT NOT LIMITED TO, THE IMPLIED WARRANTIES OF MERCHANTABILITY AND FITNESS FOR A PARTICULAR PURPOSE. IN NO EVENT SHALL EXFO BE LIABLE FOR SPECIAL, INCIDENTAL, OR CONSEQUENTIAL DAMAGES.

Warranty

Liability

Liability

EXFO shall not be liable for damages resulting from the use of the product, nor shall be responsible for any failure in the performance of other items to which the product is connected or the operation of any system of which the product may be a part.

EXFO shall not be liable for damages resulting from improper usage or unauthorized modification of the product, its accompanying accessories and software.

Exclusions

EXFO reserves the right to make changes in the design or construction of any of its products at any time without incurring obligation to make any changes whatsoever on units purchased. Accessories, including but not limited to fuses, pilot lamps, batteries and universal interfaces (EUI) used with EXFO products are not covered by this warranty.

This warranty excludes failure resulting from: improper use or installation, normal wear and tear, accident, abuse, neglect, fire, water, lightning or other acts of nature, causes external to the product or other factors beyond the control of EXFO.



IMPORTANT

EXFO will charge a fee for replacing optical connectors that were damaged due to misuse or bad cleaning.

Certification

EXFO certifies that this equipment met its published specifications at the time of shipment from the factory.

Service and Repairs

EXFO commits to providing product service and repair for five years following the date of purchase.

To send any equipment for service or repair:

- 1.** Call one of EXFO's authorized service centers (see *EXFO Service Centers Worldwide* on page 246). Support personnel will determine if the equipment requires service, repair, or calibration.
- 2.** If equipment must be returned to EXFO or an authorized service center, support personnel will issue a Return Merchandise Authorization (RMA) number and provide an address for return.
- 3.** If possible, back up your data before sending the unit for repair.
- 4.** Pack the equipment in its original shipping material. Be sure to include a statement or report fully detailing the defect and the conditions under which it was observed.
- 5.** Return the equipment, prepaid, to the address given to you by support personnel. Be sure to write the RMA number on the shipping slip. *EXFO will refuse and return any package that does not bear an RMA number.*

Note: *A test setup fee will apply to any returned unit that, after test, is found to meet the applicable specifications.*

After repair, the equipment will be returned with a repair report. If the equipment is not under warranty, you will be invoiced for the cost appearing on this report. EXFO will pay return-to-customer shipping costs for equipment under warranty. Shipping insurance is at your expense.

Routine recalibration is not included in any of the warranty plans. Since calibrations/verifications are not covered by the basic or extended warranties, you may elect to purchase FlexCare Calibration/Verification Packages for a definite period of time. Contact an authorized service center (see *EXFO Service Centers Worldwide* on page 246).

Warranty

EXFO Service Centers Worldwide

EXFO Service Centers Worldwide

If your product requires servicing, contact your nearest authorized service center.

EXFO Headquarters Service Center

400 Godin Avenue
Quebec (Quebec) G1M 2K2
CANADA

1 866 683-0155 (USA and Canada)
Tel.: 1 418 683-5498
Fax: 1 418 683-9224
quebec.service@exfo.com

EXFO Europe Service Center

Omega Enterprise Park, Electron Way
Chandlers Ford, Hampshire S053 4SE
ENGLAND

Tel.: +44 2380 246810
Fax: +44 2380 246801
europe.service@exfo.com

EXFO China Service Center/ Beijing OSIC

Beijing New Century Hotel
Office Tower, Room 1754-1755
No. 6 Southern Capital Gym Road
Beijing 100044
P. R. CHINA

Tel.: +86 (10) 6849 2738
Fax: +86 (10) 6849 2662
beijing.service@exfo.com

A Technical Specifications



IMPORTANT

The following technical specifications can change without notice. The information presented in this section is provided as a reference only. To obtain this product's most recent technical specifications, visit the EXFO Web site at www.exfo.com.

VDSL2 VTU-R-MODULE

Chipset	Broadcom
Standard Compliance VDSL2 ADSL1/2/2+	ITU-T G.993.2 Annex A option (over POTS): ITU-T G.992.5 (ADSL2+), ITU-T G.992.3 (ADSL2), ITU-T G.992.1 (G.DMT) and ANSI T1.413 Issue 2 Annex L (RE-ADSL) and Annex M are also supported
DSL measurements (upstream and downstream)	Maximum attainable bit rates Actual achieved bit rates Latency mode: fast, interleaved Capacity Signal-to-noise ratio (SNR) margin Output power Attenuation Carrier load (bits/bin) Interleave depth Interleave delay Trellis coding Bit swapping
Miscellaneous functions/measurements	PhyR™ and INP support ATM F4 and F5 OAM loopback (ADSL1/2/2+ modes only) Link errors FEC, CRC, HEC Loss of sync counter VDSL2 per band information

IPTV-OVER-DSL/ETHERNET TESTING

Physical-layer support	VDSL2 ADSL1/2/2+ Ethernet 10/100
Supported video compression/standards	MPEG2, MPEG4 part 2 and 10 (H.264/AVC), WM9
Operation	Terminate and Pass Through
IPTV parameters/functionality	Video streaming (channels) detection IGMP join/leave requests with STB emulation Bandwidth usage per channel IGMP packets information Set-top box (STB) traffic/setup information Key IP video QoS parameters: packet loss, packet jitter, zap time, PCR jitter, PID statistics Media delivery index (MDI) showing delay factor, media loss rate and virtual buffer QoS pass/fail indicators Graphic results: bandwidth usage and multilayer fault analysis histogram IP packet and PCR jitter histograms Multicast/unicast RTP/UDP IP stream support TCP/RTSP VOD support Multiple downstream PVC in ATM mode for IPTV
IP connectivity support	DNS, DHCP client/server, NAT, VLAN

VoIP-OVER-DSL/ETHERNET TESTING

Physical-layer support	VDSL2 ADSL1/2/2+ Ethernet 10/100
Recognized signalling protocol	Session initiation protocol (SIP) v2 (RFC 3261)
Operation	Pass Through
Recognized codecs	G.711, G.729, G.726, G.723
VoIP parameters/functionality	Call monitoring/analysis/statistics Call flow Key VoIP QoS parameters: packet loss, packet jitter QoS pass/fail indicators Graphic results: delay distribution, jitter histogram
IP connectivity support	DNS, DHCP client/server, NAT, VLAN

Technical Specifications

DATA ANALYSIS MODE	
Physical-layer support	VDSL2 ADSL1/2/2+ Ethernet 10/100
Encapsulation methods	PPPoE (RFC 2516), RFC 2684 supporting bridged Ethernet (IPoE), IPoA (RFC 1577), PPPoA/LLC and PPPoA/VC-MUX (RFC 2364)
Operation	Terminate and Pass Through
Login format	Username and password using PAP or CHAP
IP connectivity support	DNS, DHCP client/server, NAT, VLAN
Ping	Pings another device on the network Ping device: Gateway, destination IP address or URL Number of pings: 1 to 99 Packet size: 32 to 1500 bytes (32 is default) Results: Indicate packet size, packets sent/received, minimum/average/maximum round-trip times in milliseconds (ms)
Traceroute	Determines the path used to reach device on the network Timeout: In seconds Time to live (TTL): Default is 100 ms, maximum is 5 s Packet size: 32 bytes Number of hops: 1 to 30 (default is 30) Results: Indicate IP address of hop and round-trip time in milliseconds (ms)
HTTP speed test	Downloads a Web page and indicates speed of download Address: IP or URL Protocol: HTTP Results: Time, speed in kbit/s
FTP speed test	Displays speed to upload and/or download a file Address: IP or URL Protocol: FTP Results: Time, speed in kbit/s

RECEIVER CHARACTERISTICS ^a	
Receive frequency	200 Hz to 10 kHz, resolution 1 Hz
Receive frequency	10 kHz to 20 kHz, resolution 10 Hz
Receive frequency	20 kHz to 30 MHz, resolution 1 kHz
Frequency uncertainty (accuracy)	±0.1 %
Receive level (dBm)	-90 to +10 at 100 Ω or 135 Ω, resolution 0.1 dB
	-100 to +10 at 600 Ω, resolution 0.1 dB
Level uncertainty (accuracy)	±1.0 dB for 200 Hz to 20 kHz at 0 dBm
	±1.0 dB for 20 kHz to 30 MHz at 0 dBm
Impedance (Ω)	100, 135, 600 and bridging (100 kΩ)
TRANSMITTER CHARACTERISTICS	
Transmit frequency	200 Hz to 20 kHz, resolution 1 Hz steps
Transmit frequency	20 kHz to 30 MHz, resolution 1 kHz steps
Transmit level (dBm)	-10 to +10 at 100 or 135
	-20 to +10 at 600
Frequency uncertainty (accuracy)	The better of ±50 ppm or ±0.5 Hz
Level uncertainty (accuracy)	±0.6 dB 200 Hz to 1 MHz
	±1 dB 1 MHz to 2.2 MHz
	±2 dB 2.2 MHz to 17 MHz
	±3 dB 17 MHz to 30 MHz
Impedance (Ω)	100, 135 and 600
VF NOISE MEASUREMENT	
Range (dBm)	0 to -90, subject to instrument noise floor
Uncertainty (accuracy) (dB)	±1
Filters	None, 3 kHz flat, C-message, psophometric, notched and D filter (IEEE 743-1995)
Graphic results	Delay distribution and jitter histogram
VF IMPULSE NOISE	
Low threshold (dBm)	0 to -40, in 1 dB steps
Mid threshold	Low threshold plus separation
High threshold	Mid threshold plus separation
Separation (dB)	1 to 6, in 1 dB steps
Dead time (ms)	125
Filters	None, 3 kHz flat, C-message, psophometric, notched and D filter (IEEE 743-1995)
Counter	Maximum 999 for each threshold
Timer	1 minute to 24 hours, default is 15 minutes
POWER INFLUENCE (NOISE TO GROUND)	
Noise range (dBm)	-60 to +10
Uncertainty (accuracy) (dB)	±1.0
Level uncertainty (accuracy) (dB)	±1.0 at -60 dBm
VF LONGITUDINAL BALANCE	
Frequency (Hz)	1004
Frequency uncertainty (accuracy)	±50 ppm
Level range (dB)	0 to 80
Level uncertainty (accuracy) (dB)	±1
TIME-DOMAIN REFLECTOMETRY (TDR)	
Mode	One shot, continuous (auto-repeat) with cursor and zoom
Distance range (m)	8 to 6000 (25 ft up to 20 000 ft)
Pulse width	15 ns to 20 μs (auto-selected in auto TDR test)
Test signals	Sine wave, compensated sine wave, half-sine wave and square wave
Amplitude	7.5 V p-p on cable, 9 V p-p open circuit
Velocity of propagation (VOP)	0.400 to 0.999 or 120 m/μs to 299 m/μs
Distance uncertainty ^c (accuracy) (m)	±(1.4 m + 2 % x distance) or ±(4.5 ft + 2 % x distance)
Units	Feet and meters
Horizontal scale (m)	Automatic or 30 (100 ft), 300 (1000 ft), 600 (2000 ft), 1500 (5000 ft), 3000 (10 000 ft), 6000 (20 000 ft), 13 500 (45 000 ft) and 15 000 (50 000 ft)
FREQUENCY-DOMAIN REFLECTOMETRY (FDR)	
Distance range (m)	1.5 to 5000 (5 ft to 18 000 ft)
Velocity of propagation (VOP)	0.400 to 0.999 or 120 m/μs to 299 m/μs
Distance uncertainty (accuracy) (m)	±(3, 3 to 1000) ±(15, 1000 to 1500) ±(30, 1500 to 5000)
Units	Feet and meters
LOAD COIL DETECTION	
Count	Five
Plot (kHz)	Up to 10
Distance range (m)	Up to 8000 (up to 27 000 ft)
SINGLE-END FREQUENCY RESPONSE (ATTENUATION)	
Distance range (m)	12 to 5000 (40 ft to 16 000 ft)
Frequency range	4.3 kHz to 30 MHz
Frequency uncertainty (accuracy)	±50 ppm
Level uncertainty (accuracy) (dB)	2 dB, 4 dB at 30 MHz
Resolution (dB)	0.1
Horizontal scale (MHz)	ADSL2+ = 2.208, VDSL2-12 = 12, VDSL2-17 = 17.66, VDSL2-30 = 30
Vertical scale (dB)	0 to +100

NOTE ^a. At 23 °C ± 1 °C on batteries, unless otherwise specified.

^b. Characteristics are subject to instrument noise floor (approx. -70 dBm). Levels below -70 dBm can be measured using the PSD noise test.

^c. Does not include the uncertainty due to VOP.

Technical Specifications

POWER SPECTRAL DENSITY (PSD) NOISE MEASUREMENT			
Test type	Continuous or peak-hold		
Vertical scale	-10 dBm/Hz to -145 dBm/Hz or +20 dBm to -110 dBm		
Horizontal scale	4.3125 kHz to 17 MHz, in 4.3125 kHz steps or 8.625 kHz to 30 MHz, in 8.625 kHz steps		
Noise filters	None or E, F, G, VDLSL2-8, VDLSL2-12, VDLSL2-17 and VDLSL2-30		
DSL IMPULSE NOISE MEASUREMENT			
Threshold	-50 dBm (40 dBm) to 0 dBm (90 dBm) in 1 dB steps		
Counter	Maximum 65 000		
Test duration	1, 5, 10, 15 and 60 min, 24 h or continuous (up to 360 h)		
Histogram plot interval	1, 5, 10, 15 or 60 min		
Uncertainty (accuracy) (dB)	±2		
SWEPT LONGITUDINAL BALANCE TEST			
Frequency uncertainty (accuracy) (ppm)	±50		
Level uncertainty (accuracy)(dB)	±2.0		
Vertical scale (dB)	0 to 80.0 up to 2.2 MHz 0 to 60.0 up to 30 MHz		
Horizontal scale	ADSL/2+: 26 kHz to 2.2 MHz SHDSL: 26 kHz to 1 MHz VDSL/VDSL2-12: 26 kHz to 12 MHz VDSL2-17: 26 kHz to 17.66 MHz VDSL2-30: 26 kHz to 30 MHz		
DIGITAL MULTIMETER (DMM)			
Measurement	Range	Resolution	Uncertainty (accuracy)
DC voltage	0 to 200 V	1 V	the better of ±2 % or ±1 V
AC voltage	0 to 140 Vrms	1 V	the better of ±2 % or ±1 V
Resistance	0 to 999 MΩ	3 digits	
	0 to 999 Ω		the better of ±2 % or ±5 Ω
	1 kΩ to 99 MΩ		±(2 % + 1 digit)
	100 MΩ to 999 MΩ		±(5 % + 1 digit)
	Distance up to 30 000 m (100 000 ft)		
Capacitance	1 nF to 10 μF	3 digits	±(2 % + 1 digit)
	Distance up to 30 000 m (100 000 ft)		
DC current	0 to 110 mA	1 mA	±(2 % + 1 digit)
AC current	0 to 77 mA	1 mA	±(2 % + 1 digit)
SPECTRAL DETECTIVE			
Allows the AXS-200/635 to bridge (high-impedance) onto a live circuit to display a plot of transmitted levels and spectrum (PSD). The Spectral Detective test can be referenced to any user-selected impedance. The impedance reference setting is required to display proper readings in dBm/Hz or dBm.			
Test type	Continuous or peak-hold		
Bridging impedance	15 kΩ		
Vertical scale	-10 to -145 dBm/Hz or +20 to -110 dBm		
Horizontal scale	4.3125 kHz to 17 MHz, in 4.3125 kHz steps or 8.625 kHz to 30 MHz, in 8.625 kHz steps		
Noise filters	None or E, F, G, VDLSL2-8, VDLSL2-12, VDLSL2-17 and VDLSL2-30		
STRESS/LEAKAGE (ISOLATION RESISTANCE)			
Source	100 VDC, current safely limited to < 1.0 mA		
Range (MΩ)	0 to 999 auto-ranging		
Resolution	3 significant digits		
Uncertainty (accuracy)	0 to 999 Ω, the better of ± 1 % or ±5 Ω 1 kΩ to 99 MΩ, ±(1 % + 1 digit) 100 MΩ to 999 MΩ, ±(5 % + 1 digit)		
Soak timer (s)	1 to 99		
RESISTIVE FAULT LOCATION (RFL)			
Test type	Single pair and separate good pair		
Fault detection (MΩ)	0 to 20		
Resolution	3 digits		
Loop resistance (kΩ)	7 maximum		
Multiple cable sections	Five (includes gauge and temperature setting)		
Fault location	*Total resistance, near-end to fault resistance, fault to strap resistance (four significant digits) *Total length, distance to fault, distance from fault to strap (3 ft/1 m resolution)		
Uncertainty (accuracy)	The better of 0.2 Ω or ± 2 %		

GENERAL SPECIFICATIONS

Module size (H x W x D)	283 mm x 125 mm x 92 mm	(11 1/8 in x 4 7/8 in x 3 7/8 in)
Module weight (with battery)	1.3 kg	(2.8 lb)
Temperature		
operating	0 °C to 50 °C	(32 °F to 122 °F)
storage	-20 °C to 70 °C	(-4 °F to 158 °F)
Humidity	5 % to 95 % relative, non-condensing	
Power supply		
input	100-240 VAC at 1.8 A, 50 Hz to 60 Hz	
output	18-24 VDC at 3.33 A to 2.50 A, 60 W	
Battery	Internal rechargeable Li-Ion battery, with battery state indication	
Test connections	Five-color banana connector for T, R, G, T1, R1 RJ-45 for ADSL2+ and Ethernet 10/100 WAN RJ-45 for Ethernet 10/100 LAN	
Differential voltage protection	125 VRMS or 400 VDC max	
Common mode voltage protection	1000 VRMS	
Self-test	Routine on power-up	
Voltage detection	> 20 V will trigger alarm message	
Results storage	128 MB	
Languages	English, French, German, Spanish, Chinese (Simplified)	

Specifications based on 24 AWG (0.5 PE mm) cabling and subject to change without notice.

STANDARD ACCESSORIES

Hand strap, Certificate of Compliance
 ACC-RJTC: Test Cable: RJ-45 to telco clip
 ACC-RJRJ: RJ-45 Ethernet cable
 ACC-SCOLR: Five-color 4 mm banana connector
 ACC-STRP: RFL strap

Index

A	
ADSL2+	5
after-sales service	240
applications	
Auto test	2
CPE tests	2
data analysis	2
IPTV analysis	2
VoIP analysis	2
attenuation test	118
C	
cable connections	3
capacitance test	70
caution	
of personal hazard	7
of product hazard	7
certification information	vi
cleaning	
front panel	237
configure tests	
ATM loopback	153
data	161
FTP speed parameters	157
HTTP speed parameters	156
IPTV	158
ping parameters	154
STB support	162
traceroute	155
VoIP	160
configuring CQ auto tests	
common parameters	29
test list 1	26
test list 2	28
thresholds 1	34
thresholds 2	36
VF test parameters	30
WB test parameters	32
configuring video-DSL rate prediction	
configuration	46
impulse noise	49
thresholds	48
connection setup	
downstream channel parameters	148
DSL thresholds	146
LAN	144
line	137
selected profile	134
WAN access	139
WAN IP	141
conventions, safety	7
CPE test results	
ATM loopback	178
bits per bin	169
DSL Params	166
FTP speed	175
HPNA info	176
HPNA statistics	177
HTTP speed	174
line status	164
ping	172
save result	179
statistics	167
summary	163
TraceRoute	173
VDSL Bands	168
WAN status	170
CQ auto tests	25
current test	71
customer service	245
D	
data analysis results	
downstream rates	216
DSL parameters	209
HPNA info	217

Index

HPNA statistics.....	218
IP packets	214
LAN status	214
line status	207
protocols	215
save result.....	219
statistics.....	210
summary.....	205
upstream rates.....	216
VDSL bands	211
WAN status.....	212
data rate prediction	122
summary.....	124
DMM tests.....	65
DSL/IP auto tests	151

E

equipment returns	245
EXFO worldwide service centers	246

F

fault location	
loop mapper test.....	98
RFL-2 wire test.....	92
RFL-4 wire test.....	95
TDR test.....	89
fault location tests	89
front panel, cleaning.....	237

H

HPNA	
LAN setup	144
line mode	134

I

identification label	240
impulse noise histogram test	115
impulse noise test	113
configuration.....	84
results.....	86

in service pair detection test.....	74
IPTV analysis results	
detected streams	196
downstream rates.....	191
DSL Params	185
errors	192
HPNA info	201
HPNA statistics.....	202
IGMP.....	193
IP arrival jitter.....	197
LAN status.....	190
line status	183
network activity	191
PCR jitter.....	198
RTSP info.....	194
save result.....	203
statistics.....	186
stream content	200
stream params	199
summary.....	181
VDSL Bands.....	187
WAN status.....	188
isolation test	
isolation.....	69

L

label, identification.....	240
line status	
showtime.....	164
load coil detection test	
results	87
longitudinal balance.....	120
longitudinal balance test	73, 87
loop mapper test	
configuration.....	98
FDR graph	101
summary.....	99
TDR graph.....	99

M	
main menu	6
maintenance	237
front panel	237
general information	237
N	
navigation	6
O	
opens meter	70
P	
POTS Dialer	10
power influence test	
results	86
product	
identification label	240
specifications	247
PSD noise test	106
R	
receive tone test (RX)	80
rectified loop detection test	75
recycling and disposal	238
regional settings	
cable setup	14
phone book	17
select profile	12
standard	16
resistance test	67
resistive balance	
resistive balance results	77
test setup	76
resistive balance test	76
results	
CPE tests	163
data analysis	205
IPTV test	181
read saved	22, 132
save	19
VoIP tests	221
return merchandise authorization (RMA) ..	245
RFL-2 wire test	
configuration	92
connection diagram	94
result	94
RFL-4 wire test	
configuration	95
connection diagram	97
result	97
S	
safety	
caution	7
conventions	7
warning	7
send tone test (TX)	81
service and repairs	245
service centers	246
shipping to EXFO	245
shorts meter	67
solving common problems	239
specifications, product	247
spectral detective test	110
storage requirements	237
stress/leakage	69
symbols, safety	7
T	
TDR test	
results	90
setup	90
technical specifications	247
technical support	240
temperature for storage	237
tracing tone test	82
transportation requirements	237, 241
troubleshooting	239
typical applications	2

Index

V

VDSL2.....	5
VF noise test.....	72, 83
VF tests	79
video-DSL rate prediction	
bits per bin graph.....	61
DMM results.....	54
DSL rate results.....	58
SNR graph	60
summary.....	51
video rates.....	53
WB attenuation	57
WB impulse noise	58
WB longitudinal balance.....	55
WB PSD noise	56
viewing CQ auto tests results	
attenuation.....	42
DMM results.....	38
isolation.....	38
load coil.....	38
PSD noise.....	41
receive tone.....	39
summary.....	37
TDR.....	43
VF impulse noise.....	39
VF tests.....	39
WB impulse noise	43
WB longitudinal balance.....	40
VoIP analysis results	
call history	229
DSL parameters	224
HPNA info.....	232
HPNA statistics.....	233
jitter analysis.....	231
LAN status	228
line status	222
network activity.....	229
packets analysis	230
save result.....	234
statistics.....	225
summary.....	221

VDSL bands.....	226
WAN status.....	227
voltage test	66

W

warranty	
certification.....	244
exclusions	244
general.....	243
liability.....	244
null and void.....	243
water detection test	75
wideband attenuation test	
configuration	118
results	119
wideband data rate prediction	
attenuation	127
bits per bin	129
DSL rate	122
PSD noise	126
SNR.....	128
wideband impulse noise histogram test	
configuration	115
graph	117
summary.....	116
wideband impulse noise test	
configuration	113
results	114
wideband longitudinal balance test	
configuration	120
results	121
wideband PSD noise test	
configuration	106
results	108
wideband receive tone test (RX).....	104
wideband send tone test (TX).....	105
wideband spectral detective test	
configuration	110
results	112
wideband tests.....	103

NOTICE

通告

CHINESE REGULATION ON RESTRICTION OF HAZARDOUS SUBSTANCES

中国关于有害物质限制的规定

NAMES AND CONTENTS OF THE TOXIC OR HAZARDOUS SUBSTANCES OR ELEMENTS CONTAINED IN THIS EXFO PRODUCT



包含在本 EXFO 产品中的有毒有害物质或元素的名称和含量

O	Indicates that this toxic or hazardous substance contained in all of the homogeneous materials for this part is below the limit requirement in SJ/T11363-2006 表示该有毒有害物质在该部件所有均质材料中的含量均在 SJ/T11363-2006 标准规定的限量要求以下。
X	Indicates that this toxic or hazardous substance contained in at least one of the homogeneous materials used for this part is above the limit requirement in SJ/T11363-2006 表示该有毒有害物质至少在该部件的某一均质材料中的含量超出 SJ/T11363-2006 标准规定的限量要求。

Part Name 部件名称	Toxic or hazardous Substances and Elements 有毒有害物质和元素					
	Lead 铅 (Pb)	Mercury 汞 (Hg)	Cadmium 镉 (Cd)	Hexavalent Chromium 六价铬 (Cr VI)	Polybrominated biphenyls 多溴联苯 (PBB)	Polybrominated diphenyl ethers 多溴二苯醚 (PBDE)
Enclosure 外壳	O	O	O	O	O	O
Electronic and electrical sub-assembly 电子和电子组件	X	O	X	O	X	X
Optical sub-assembly ^a 光学组件 ^a	X	O	O	O	O	O
Mechanical sub-assembly ^a 机械组件 ^a	O	O	O	O	O	O

- a. If applicable.
聞種矽杉羽塞粒粒。

MARKING REQUIREMENTS
标注要求

Product 产品	Environmental protection use period (years) 环境保护使用期限 (年)	Logo 标志
This Exfo product 本 EXFO 产品	10	
Battery ^a 电池 ^a	5	

- a. If applicable.
閩種胎衫襖塞粒。

P/N: 1056397

www.EXFO.com · info@exfo.com

CORPORATE HEADQUARTERS	400 Godin Avenue	Quebec (Quebec) G1M 2K2 CANADA Tel.: 1 418 683-0211 · Fax: 1 418 683-2170
EXFO AMERICA	3701 Plano Parkway, Suite 160	Plano TX, 75075 USA Tel.: 1 972 907-1505 · Fax: 1 972 836-0164
EXFO EUROPE	Omega Enterprise Park, Electron Way	Chandlers Ford, Hampshire S053 4SE ENGLAND Tel.: +44 2380 246810 · Fax: +44 2380 246801
EXFO ASIA-PACIFIC	151 Chin Swee Road #03-29, Manhattan House	SINGAPORE 169876 Tel.: +65 6333 8241 · Fax: +65 6333 8242
EXFO CHINA	No. 88 Fuhua First Road, Central Tower, Room 801, Futian District	Shenzhen 518048 P. R. CHINA Tel.: +86 (755) 8203 2300 · Fax: +86 (755) 8203 2306
	Beijing New Century Hotel Office Tower, Room 1754-1755, No. 6 Southern Capital Gym Road	Beijing 100044 P. R. CHINA Tel.: +86 (10) 6849 2738 · Fax: +86 (10) 6849 2662
EXFO SERVICE ASSURANCE	285 Mill Road	Chelmsford MA, 01824 USA Tel.: 1 978 367-5600 · Fax: 1 978 367-5700
TOLL-FREE	(USA and Canada)	1 800 663-3936

© 2009 EXFO Electro-Optical Engineering Inc. All rights reserved.
Printed in Canada (2009-07)

