

---

# EXpert IPTV Test Tools



# Copyright Information

Copyright © 2014–2017 EXFO Inc. All rights reserved. No part of this publication may be reproduced, stored in a retrieval system or transmitted in any form, be it electronically, mechanically, or by any other means such as photocopying, recording or otherwise, without the prior written permission of EXFO Inc. (EXFO).

Information provided by EXFO is believed to be accurate and reliable. However, no responsibility is assumed by EXFO for its use nor for any infringements of patents or other rights of third parties that may result from its use. No license is granted by implication or otherwise under any patent rights of EXFO.

EXFO's Commerce And Government Entities (CAGE) code under the North Atlantic Treaty Organization (NATO) is 0L8C3.

The information contained in this publication is subject to change without notice.

### ***Trademarks***

EXFO's trademarks have been identified as such. However, the presence or absence of such identification does not affect the legal status of any trademark.

### ***Units of Measurement***

Units of measurement in this publication conform to SI standards and practices.

March 24, 2017

Version number: 4.0.0.1

## Licence Agreement and Warranty

IMPORTANT: CAREFULLY READ THE FOLLOWING LICENSE AGREEMENT BEFORE OPENING THIS INSTALLATION PACKAGE. BY OPENING THIS PACKAGE AND USING THE SOFTWARE WHETHER INCORPORATED OR NOT IN AN EXFO INC. ("EXFO") PRODUCT, YOU INDICATE YOUR ACCEPTANCE TO BE BOUND BY THE TERMS AND CONDITIONS OF THIS AGREEMENT. IF YOU DO NOT ACCEPT THE TERMS AND CONDITIONS OF THIS LICENSE AGREEMENT, DO NOT OPEN THIS PACKAGE AND PROMPTLY RETURN THE PRODUCT OR SOFTWARE WITH YOUR PROOF OF PAYMENT, WHEREUPON YOUR MONEY WILL BE REFUNDED.

THE PRODUCT OR SOFTWARE YOU ORDERED MIGHT INCLUDE SOURCE CODE AND/OR SOFTWARE COMPONENTS, IT IS PROVIDED FOR YOUR CONVENIENCE IN MODIFYING THE PRODUCT OR SOFTWARE TO SUIT YOUR SPECIFIC NEEDS, OR TO CREATE DERIVATIVE WORKS INCLUDING SOURCE AND LIBRARY FILES IF APPLICABLE.

THE PRODUCT AND THE SOFTWARE MUST BE USED ONLY FOR YOUR INTERNAL BUSINESS OPERATION AND ITS INTENDED APPLICATION. YOU MAY NOT COPY OR USE THE SOURCE CODE OR THE SOFTWARE COMPONENTS TO PRODUCE OTHER SOFTWARE DEVELOPMENT TOOLS FOR DISTRIBUTION AND RESALE WITHOUT EXPRESS WRITTEN PERMISSION FROM EXFO. EXFO RETAINS ALL RIGHTS TO THE SOURCE CODE, THE SOFTWARE COMPONENTS AND ALL MODIFICATIONS THEREOF. YOU SHALL RESPECT AND COMPLY WITH ANY OF THE PROVISIONS LISTED BELOW WHICH MAY ALSO BENEFIT ANY GIVEN THIRD PARTY BENEFICIARY AS DEFINED HEREIN.

**1. DEFINITIONS:** The following definitions apply to the terms in the Agreement.

**"Documentation"** means the user's manual and other printed materials accompanying the Software.

**"Product"** means the EXFO instrument designed for use with the Software, as the case may be.

**"Software"** means the computer programs, source code and software components contained therein and all updates and upgrades thereto. The term also includes all copies of any part of the computer program, source code or software components.

**2. GRANT OF LICENSE:** EXFO grants to you, the purchaser of the enclosed Software, a limited, restricted, non-exclusive license. You shall use the Software only in conjunction with its purpose or in conjunction with the Product, subject to the limitations on use and disclosure contained herein and in the Documentation. You may:

- Use the Software on a network, file service or virtual disk; provided that access is limited to one user at a time and that you have the original copy of the Documentation and Software media.
- Make one (1) copy of the Software for backup or modification purposes in support of the use of the Software on a single computer.
- Merge the Software or incorporate the same into another program provided that such a program will, for so long as the Software is included therein, be subject to all of the terms and conditions of this Agreement.

You may not:

- Make copies of the Documentation.
- Assign, give or transfer the Software, any services or interests in the Software, to another individual or entity. Sublicense, lease, time-share, service bureau, lend, use for subscription service or rental use any portion of the Product, the Software, or your rights under this Agreement.
- Reverse engineering, disassemble or decompile in whole or in part the Software or the Product.
- Publish any result of benchmark tests run on the Software or the Product.

YOU RECOGNIZE THAT THE SOURCE CODE AND THE SOFTWARE COMPONENTS COMPRISING THE SOFTWARE ARE HIGHLY VALUABLE TRADE SECRETS OF EXFO OR ANY GIVEN THIRD PARTY BENEFICIARY AND THAT EXFO WISHES TO PREVENT THEIR DISCLOSURE TO YOU, OR ANY THIRD PARTY.

**3. SOFTWARE OWNERSHIP:** The Software is licensed, not sold. Title to the Software shall not be passed to you or to any other party. All applicable rights to patents, copyrights, trademarks and trade secrets in the Software, or any modifications made at your request, are and shall remain the property of EXFO.

**4. AUDITS:** EXFO reserves its right to audit, at its convenience, your use of the Software.

**5. TERMS OF TERMINATION:** This Agreement shall remain in full force and effect until you discontinue use of the Software or the Product, until the end of the life of the Product or Software or until this Agreement is terminated, whichever occurs earlier. Without prejudice to its other rights, EXFO may terminate this Agreement if you fail to comply with the terms thereof. In such event, you must destroy or return all copies of the Software and Documentation as requested in writing by EXFO. You shall be liable for all damages to EXFO as a result of the breach whether or not you were notified of the likelihood of such damages.

EXFO retains all rights to the Software not expressly granted hereunder. Nothing in this Agreement constitutes a waiver of the rights of EXFO or any Third Party Beneficiary.

## Copyright Information

---

6. LIMITED WARRANTY: EXFO warrants the media on which the Software is distributed to be free from defects in material and workmanship and that the Software will perform substantially in accordance with the Documentation. EXFO will replace defective media or Documentation at no charge, provided you return the item with dated proof of payment to EXFO within (60) days of the date of delivery. THESE ARE YOUR SOLE REMEDIES FOR BREACH OF WARRANTY. EXCEPT AS SPECIFICALLY PROVIDED ABOVE, EXFO MAKES NO WARRANTY OR REPRESENTATION, EITHER EXPRESS OR IMPLIED WITH RESPECT TO THE SOFTWARE OR DOCUMENTATION INCLUDING THEIR QUALITY, PERFORMANCE, MERCHANTABILITY, OR FITNESS FOR A PARTICULAR PURPOSE.

7. LIMITATIONS OF LIABILITY: Because software is inherently complex and may not be completely free of errors, you are advised to verify your work. IN NO EVENT WILL EXFO, ITS DEALERS, DISTRIBUTORS, RESELLERS, OR THIRD PARTY BENEFICIARY, BE LIABLE FOR DIRECT, INDIRECT, SPECIAL, INCIDENTAL, OR CONSEQUENTIAL DAMAGES, INCLUDING LOST PROFITS, DOWNTIME OR DAMAGES TO PROPERTY ARISING OUT OF THE USE OF OR INABILITY TO USE THE SOFTWARE OR DOCUMENTATION, even if advised of the possibility of such damages. THE WARRANTY AND REMEDIES SET FORTH ABOVE ARE EXCLUSIVE AND IN LIEU OF ALL OTHERS, ORAL OR WRITTEN, EXPRESS OR IMPLIED. No dealer, distributor, agent or employee is authorized to make any modification or addition to this warranty. Some US States or applicable local legislation do not allow the exclusion or limitation of implied warranties or limitation of liability for incidental or consequential damages, so the above limitation or exclusion may not apply to you.

8. U.S. GOVERNMENT RESTRICTED RIGHTS: The Software and Documentation are provided with RESTRICTED RIGHTS. Use, duplication, or disclosure by the Government is subject to restrictions as set forth in subparagraph (c) (1) (ii) of The Rights in Technical Data and Computer Software clause at 52.227-7013. EXFO headquarters are located at 400 Godin Avenue, Quebec, Quebec, G1M 2K2, Canada.

9. EXPORT AND IMPORT LAWS: You must comply fully with all applicable export and import laws including, but not limited to, export laws and regulations of the United States of America. No Programs, Products or Software shall be exported, directly or indirectly, in violation of laws.

10. THIRD PARTY BENEFICIARY: EXFO may designate, from time to time, any Third Party Beneficiary, with respect to any Product or Software, which has duly executed a prior writing agreement with EXFO. Third Party Beneficiaries may include, but are not limited to, namely ORACLE, Business Objects, Advance Fiber Optics, and MapInfo. The terms of this Agreement also governs any source code that may be provided in some programs by Third Party Beneficiary, such as the one mentioned above. This Agreement is not intended to be for the benefit of and shall not be enforceable by any given Third Party Beneficiary without a prior written agreement duly executed with EXFO.

11. GENERAL: This Agreement constitutes the entire agreement between you and EXFO as concerns the subject matter hereof and supersedes any prior agreement as to such subject matter. If any provision of this Agreement shall be deemed to be invalid, illegal or unenforceable, the validity, legality and enforceability of the remaining portions of this Agreement shall not be affected or impaired thereby. This Agreement shall be governed by and construed in accordance with the laws applicable in the province of Quebec, Canada without regards to its conflict of laws provisions.

BY USING THE SOFTWARE, YOU ACKNOWLEDGE THAT YOU HAVE READ THIS AGREEMENT, THAT YOU UNDERSTAND IT, AND YOU AGREE TO BE BOUND BY ITS TERMS AND CONDITIONS.

If you have any questions regarding this Agreement, you may contact the Legal Department at EXFO at (418) 683-0211.

---

# Contents

Copyright Information .....	ii
<b>1 Introducing the EXpert IPTV Test Tools .....</b>	<b>1</b>
Conventions .....	2
<b>2 Getting Started .....</b>	<b>3</b>
Signal Connection .....	3
Laser Safety Information .....	3
Starting EXpert IPTV Test Tools .....	3
<b>3 Using the Graphical User Interface .....</b>	<b>5</b>
Main Application Window .....	5
Keyboard Usage .....	7
<b>4 Configuring and Starting an IPTV Test .....</b>	<b>9</b>
Passive Test .....	9
Set Top Box Emulation Test .....	11
<b>5 Test Setup .....</b>	<b>13</b>
Interface .....	14
Thresholds Configuration .....	16
STB Channels .....	18
<b>6 Getting IPTV Metrics and Results .....</b>	<b>21</b>
Ethernet Interface .....	22
Test Log .....	23
Summary .....	24
Video .....	28
Packets .....	31
TR101290 .....	34
Audio .....	36
Video Frames .....	38
Video Bandwidth .....	40
Charts .....	42
Test Results .....	43
Search Filter .....	43
Measurements .....	44
Remove Selected .....	44
Generate Reports .....	45

---

<b>7 Troubleshooting</b> .....	<b>49</b>
Contacting the Technical Support Group .....	49
<b>A Specifications</b> .....	<b>51</b>
<b>B Glossary</b> .....	<b>57</b>
Acronym List .....	57
Metrics .....	61
IPTV .....	66
<b>Index</b> .....	<b>99</b>

# 1 **Introducing the EXpert IPTV Test Tools**

The EXpert IPTV Test Tools is an IPTV quality analyzer including the following components:

- Test Logger with multistream detection and synchronizer via the platform 10/100/1000 Ethernet interface
- Set Top Box (STB) emulator for multicast and unicast streams
- Video Previewer
- Video Metrics
- Packet statistics
- TR 101290 Metrics
- Audio Metrics
- Video Frame Metrics
- Video Bandwidth Metrics
- Charts

The EXpert IPTV Test Tools application runs on the following EXFO's platforms: FTB-1, FTB-1v2, FTB-1v2 Pro, FTB-2, FTB-2 Pro, and FTB-4 Pro.

## Conventions

Before using the product described in this guide, you should understand the following conventions:



### WARNING

Indicates a potentially hazardous situation which, if not avoided, could result in *death or serious injury*. Do not proceed unless you understand and meet the required conditions.



### CAUTION

Indicates a potentially hazardous situation which, if not avoided, may result in *minor or moderate injury*. Do not proceed unless you understand and meet the required conditions.



### CAUTION

Indicates a potentially hazardous situation which, if not avoided, may result in *component damage*. Do not proceed unless you understand and meet the required conditions.



### IMPORTANT

Refers to information about this product you should not overlook.



## 2 Getting Started

### Signal Connection

The EXpert IPTV Test Tools uses the 10/100/1000 Mbit/s Ethernet RJ45 port of the platform. Connect the 10/100/1000 Mbit/s electrical signal to be tested to the RJ45 port of the platform.

**Note:** Refer to the platform user guide for more information.

### Laser Safety Information

The EXpert IPTV Test Tools software is not provided with any hardware components. However, it may be used with your platform or modules which may contain laser components. Refer to the user guides of your platform or modules for further laser safety details and instructions.

### Starting EXpert IPTV Test Tools

The EXpert IPTV Test Tools application is pre-installed on the platform. If the EXpert IPTV Test Tools is not already installed, refer to the platform user guide for more information on how to install the application.

**Note:** The application can be used in trial mode if you do not have a valid license. You can follow the on-screen instructions to activate the trial. If you wish to renew the trial period or purchase a valid license, then refer to EXFO.com. For information on how to install and activate software options, refer to the platform user guide.

#### **To start EXpert IPTV Test Tools:**

- 1. FTB-1:** From **Mini ToolBox**, tap on the **Test Tools** tab.  
**FTB-1v2, and FTB-1v2 Pro:** From **Mini ToolBox X**, tap on the **Test Tools** button.  
**FTB-2, FTB-2 Pro, and FTB-4 Pro:** From **ToolBox X**, tap the **Test Tools** button.
- 2.** Select the **EXpert IPTV Test Tools** then tap on **Start**.



# 3 Using the Graphical User Interface

This chapter describes the graphical user interface of the EXpert IPTV Test Tools application.

## Main Application Window

The following main application window is displayed when the EXpert IPTV Test Tools application is started.

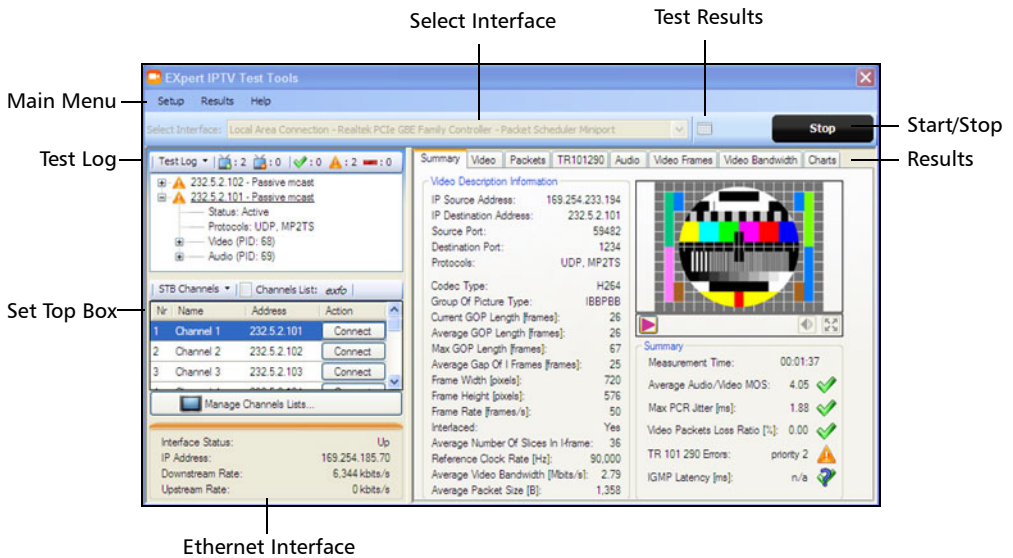

### Main Menu

- **Setup**
  - **Interface** and **Thresholds** allow respectively to configure the interface and test thresholds. Refer to *Test Setup* on page 13 for more information.
  - **Exit** closes the EXpert IPTV Test Tools application.
- **Results** gives access to the test results and report generation. Refer to *Test Results* on page 43 for more information.
- **Help**
  - **User's Manual** loads the EXpert IPTV Test Tools user guide.
  - **About** mainly displays the product version details and technical support information.

### Test Log

Lists all active and inactive IPTV channels (refer to *Test Log* on page 23).

### Set Top Box

Allows to select the type of channel, connect channel, and play stream (refer to *STB Channels* on page 18).

### Ethernet Interface

Displays the Ethernet interface status, IP address, and rates (refer to *Ethernet Interface* on page 22).

### Select Interface

Allows the selection of the test interface. Refer to *Interface* on page 14.

### **Start/Stop Button**

Allows to start and stop de test. Refer to *Configuring and Starting an IPTV Test* on page 9.

### **Test Results**

Gives access to the test results and report generation. Refer to *Test Results* on page 43 for more information.

### **Results**

Gives test result summary and metrics. Refer to *Test Results* on page 43.

## **Keyboard Usage**

For certain text fields, the GUI pops up or uses the platform's on-screen keyboard. Refer to the platform user guide for more information on how to use it.



## 4 **Configuring and Starting an IPTV Test**

The IPTV test can be performed in passive and Set Top Box (STB) connection modes. Video and audio quality assessment is provided by VQmon algorithm.

Once the streams are detected and synchronized, the test metrics start and live video preview is available on non-encrypted streams.

Up to 10 channels can be tested simultaneously. An error message is displayed when exceeding this number.

### **Passive Test**

The Passive Test allows monitoring IPTV streams present at the interface, for quality of service and video preview. When used as a passive monitoring device, the EXpert IPTV Test Tools is connected via a manageable switch or aggregating tap to monitor bidirectionally the IGMP, RTSP, and other protocols, and IPTV streams from the video server.:

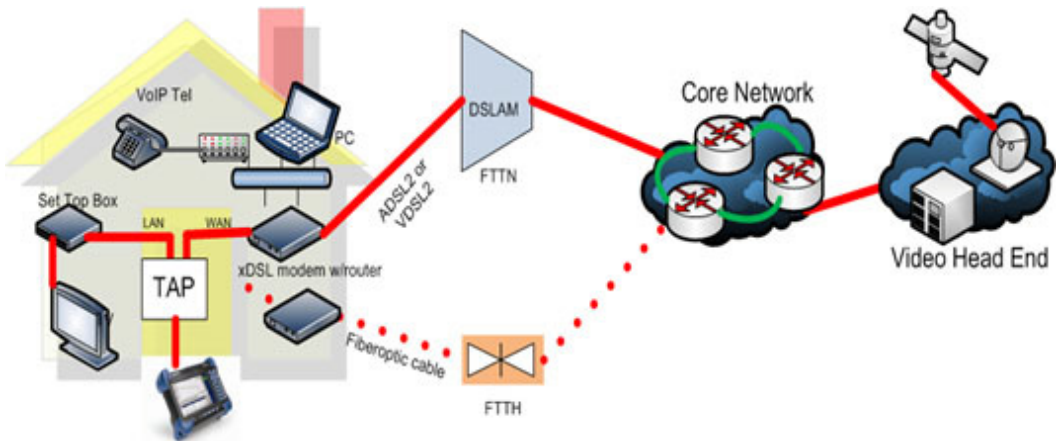

## Configuring and Starting an IPTV Test

### *Passive Test*

---

#### **To configure and start a passive test:**

1. If required configure the interface, refer to *Interface* on page 14.
2. If required configure the thresholds, refer to *Thresholds Configuration* on page 16.
3. Tap the **Start** button and the test starts upon detection of a valid IPTV stream. All detected valid streams will be displayed in **Test Log** and marked as **Passive** (refer to *Test Log* on page 23).
4. Getting results (refer to *Test Results* on page 43).
5. Tap the **Stop** button to end the test on all channels. The test automatically stops when either disconnecting the cable carrying the stream or when the streams expire.



### Set Top Box Emulation Test

The Set Top Box (STB) emulation test allows IGMP or RTSP join & leave requests to one or multiple IPTV streams. When used as a Set Top Box (STB) emulator, the EXpert IPTV Test Tools is terminating the customer modem or GPON adapter as follows:

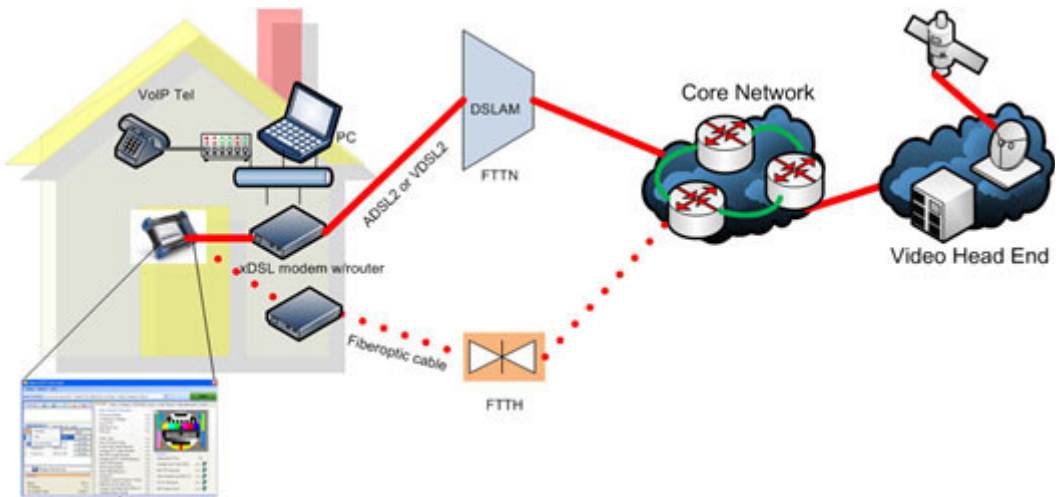

#### **To configure and start a Set Top Box emulation test:**

1. If required configure the interface, refer to *Interface* on page 14.
2. If required configure the thresholds, refer to *Thresholds Configuration* on page 16.
3. Configure the channels list, refer to *Manage Channels Lists* on page 18.
4. Tap the **Start** button and the test starts upon detection of a valid IPTV stream(s) or when tapping a stream's **Connect** or **Play** button as defined in the following sub-steps. All detected valid streams will be displayed in the **Test Log** box (refer to *Test Log* on page 23).
5. From the STB Channels menu, select either **Multicast** or **VoD**.

For Multicast streams:

## Configuring and Starting an IPTV Test

### *Set Top Box Emulation Test*

---

- 5a.** Choose the channel to be tested from the **STB Channel** list.
- 5b.** Tap the **Connect** button of the chosen channel. This initiates IGMP request for this multicast channel. Once detected the stream is displayed in **Test Log** as active. Repeat this process for all channels to be tested.

For VoD streams (URI's):

- 5c.** Choose the VoD to be tested from the **STB Channel** list.
  - 5d.** Tap the **Play** button of the chosen channel. This initiates RTSP join request for this unicast channel. Once detected the stream is displayed in the **Test Log box** as active. Repeat this process for all channels to be tested.
- 6.** Getting results (refer to *Test Results* on page 43).
  - 7.** Tap the main **Stop** button to end the test on all channels; tap the stream's **Disconnect** button to stop the corresponding Multicast stream; tap the stream's **Stop** button to stop the corresponding stream. The test automatically stops when disconnecting the cable carrying the stream.

## 5 **Test Setup**

The test setup menu allows to configure the interface and test thresholds. The main application window allows the selection of the interface and the configuration of the STB multicast and VoD channels.

To change the interface settings, see *Interface* on page 14.

To change the thresholds, see *Thresholds Configuration* on page 16.

To manage the channel list, see *Manage Channels Lists* on page 18.

## Test Setup

### Interface

---

## Interface

From the main menu, tap on **Setup** and select **Interface**.

**Note:** *Interface configuration is only possible when the Ethernet link is up.*

### Interface

Allows the selection of the platform network adapter.

The settings and status of selected interface are also displayed (**DHCP, IP Address, Netmask, Default Gateway, DNS, MAC Address, and Operational status**).

### MAC Address Clone

**MAC Address Clone** check box when selected, allows to change the default and unique MAC address given to the Ethernet port.

### IGMP Version Change

Allows the selection of the IGMP version: **IGMPv2** (default) or **Automatic (IGMPv3 or IGMPv2)**.

### DHCP Client

**DHCP Client** option when selected (default) allows to dynamically obtain an IP address from a DHCP (Dynamic Host Configuration Protocol) server for the Ethernet port. The **Vendor Class ID** and **User Class Information** can also be configured.

## Static IP Address

**Static IP Address** option when selected (cleared by default) allows to configure the following parameters:

- **IP Address** allows to enter the IP address for the Ethernet port: **0.0.0.1** to **223.255.255.255**.
- **Netmask** allows to enter the Subnet Mask for the Ethernet port: **0.0.0.1** to **255.255.255.255**.
- **Default Gateway** check box when selected (cleared by default) allows to enter a default Gateway address: **0.0.0.01** to **255.255.255.255**.
- **DNS** check box when selected (cleared by default) allows to enter the DNS Server address: **0.0.0.0** to **223.255.255.255**.

## Thresholds Configuration

From the main menu, tap on **Setup** and select **Thresholds**.

**Failed**, **Warned**, and **Passed** threshold parameters are preset as follows:

- **Average Audio/Video MOS:** Range is from 1 to 5. Defaults are:



- **Max PCR Jitter:** Defaults are:



- **Video Packet Loss Ratio:** Range is from 0% to 100%. Defaults are:

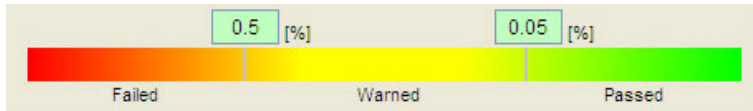

- **IGMP Latency:** Defaults are:

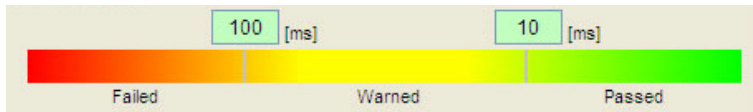

- **TR101290:** Default is **Use Default Settings** which corresponds to the following defaults:

The screenshot displays two configuration panels, Priority 1 and Priority 2, each with a color-coded threshold scale (Failed: Red, Warned: Yellow, Passed: Green). The Priority 1 panel lists error counts for TS Sync Loss, Sync Byte, PAT, PAT2, Continuity, PMT, and PID. The Priority 2 panel lists error counts for Transport, CRC, PCR, PCR Repetition, PCR Discontinuity, PCR Accuracy, PTS, and CAT.

Priority	Parameter	Failed	Warned	Passed
Priority 1	TS Sync Loss Count	100	0	0
	Sync Byte Error Count	100	0	0
	PAT Error Count	100	0	0
	PAT2 Error Count	100	0	0
	Continuity Error Count	100	0	0
	PMT Error Count	100	0	0
	PMT2 Error Count	100	0	0
PID Error Count	100	0	0	
Priority 2	Transport Error Count	1000	10	10
	CRC Error Count	1000	10	10
	PCR Error Count	1000	10	10
	PCR Repetition Error Count	1000	10	10
	PCR Discontinuity Error Count	1000	10	10
	PCR Accuracy Error Count	1000	10	10
	PTS Error Count	1000	10	10
	CAT Error Count	1000	10	10

The TR101290 allows configuration of Priority 1 and 2 parameters from a separate menu; select the **Use Advanced Settings** option and tap the **Configure Advanced Settings** button to access the menu.

These color coded thresholds will then trigger the corresponding flags in the Summary page. Clearing any parameter check box removes it from the active metrics.

## STB Channels

Allows to select the type of channel, connect channel, and play stream.

### STB Channels Selection

From the left pane of the main window, tap on **STB Channels** to select the type of channel: **Multicast** channel or **VoD** stream. The list of channels or VoD is displayed for the selected channel group and allows the following actions once the test is started:

- **Connect**, available with multicast, allows the connection to the channel.
- **Play**, available with VoD, allows to play the video.

### Channels List

The selected Channels List is displayed next to the STB Channels selection. To change the selected channel list, tap on **Manage Channels Lists** and select the **Channels Group**.

### Manage Channels Lists

From the left pane of the main window, tap on **Manage Channels Lists** button.

- **Channels Group** allows the selection of the channel group to be managed and used for test.
- **Multicast Channel** and **VoD Streams** allows the selection of the type of channel: **Multicast Channels** or **VoD streams**.
- **New Group** creates a new group. Tap on the **New Group** button, enter the new group name as a channel list and tap **OK**.
- **Delete Group** deletes a group. Select the channel group to be deleted from the Channel Group selection and tap on the **Delete Group** button.



- **Export all Groups** allows to save all channel groups on disk. Tap the **Export All Groups** button, type a file name, and tap **Save**. The file is saved with the **.IptvChannels** extension.
- **Import all Groups** allows to load all channel groups from disk. Tap the **Import All Groups** button, select the file, and tap **Open**. Only files with **.IptvChannels** extension are listed.
- **Add Channel** adds a new channel. Tap the **Add Channel** button, and:
  - For **Multicast Channels**: enter the new channel **Number**, **Name**, **Multicast address** (or Port) and tap **OK**.  
Multicast address range is 224.0.0.0 to 224.0.0.255.
  - For **VoD Streams**: enter the new channel **Number**, **Name**, **RTSP URI** and tap **OK**.  
RTSP URI address starts as follows: **rtsp://**
- **Delete Channel** removes a channel from the list. Select the channel to be deleted and tap on the **Delete Channel** button.



## 6 Getting IPTV Metrics and Results

The following figure shows the EXpert IPTV Test Tools during analysis of four IPTV streams with individual preview screens. Test results are displayed for one stream at a time but other streams are still being tested and their test results are being saved and can be viewed anytime by clicking on the stream of interest.

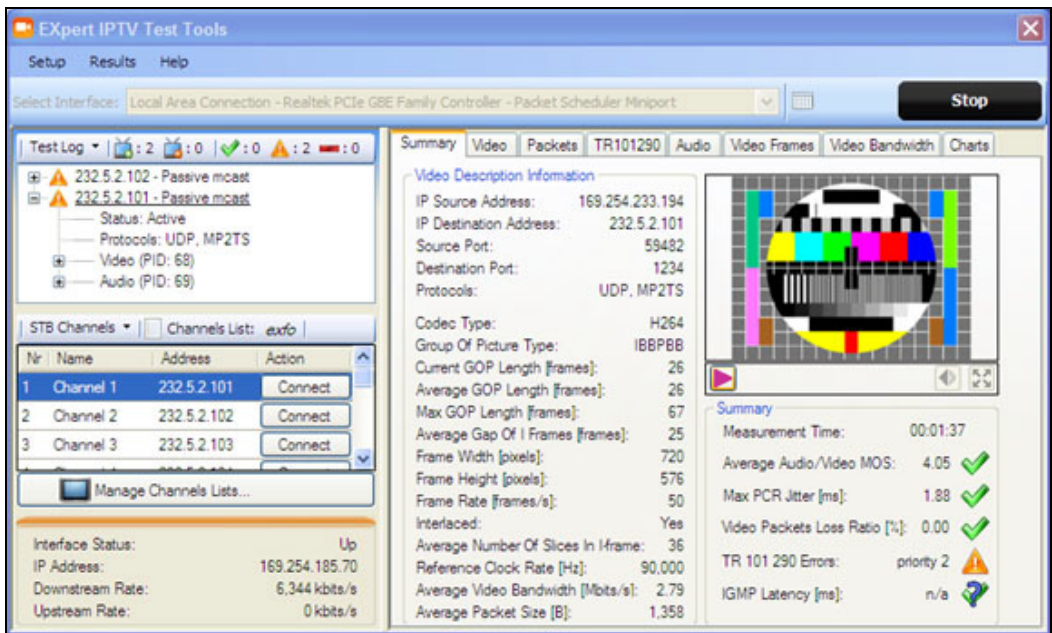

To view metrics and preview of another channel click on it in the **Test Log** box. The channel whose metrics and preview are currently displayed is underlined.

To view metrics of a previously saved test results, from the main menu, tap on **Results** (see *Test Results* on page 43).

## Ethernet Interface

The Ethernet Interface information is available on the bottom-left pane of the main window.

- **Interface Status** indicated that the Ethernet link is up or down.
- **IP Address** indicates the IP Address of the Ethernet port.
- **Downstream Rate** gives the received Kbits/s for the all the streams present in the link.
- Upstream Rate gives the transmitted Kbits/s.

## Test Log

Displays all active and inactive IPTV channels.

The test log is available on the top-left pane of the main window.

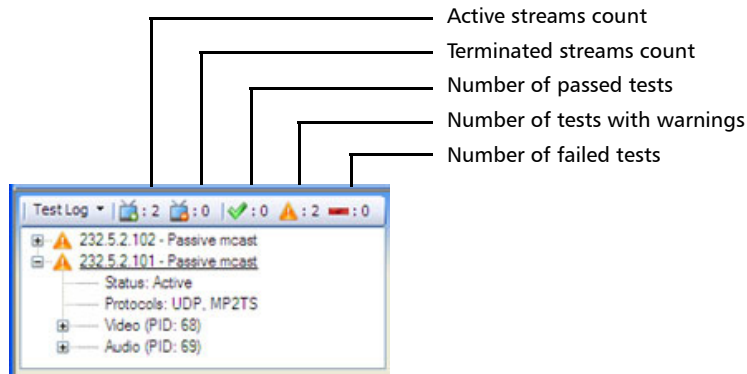

The channel whose metrics are currently displayed, in the main window left-pane, is underlined in the **Test Log**.

## Test Log

Tap on **Test Log** and select:

- **Streams** allows to select the streams to be displayed: **Active**, **Terminated**, **Connecting/Aborted**, **Passed**, **Warned**, **Failed**, or **Show All**.
- **Clear Terminated** allows to remove the streams that are terminated from the list.

## Getting IPTV Metrics and Results

### Summary

---

## Summary

The Summary tab is available on the right pane of the main window and displays the basic IPTV metrics.

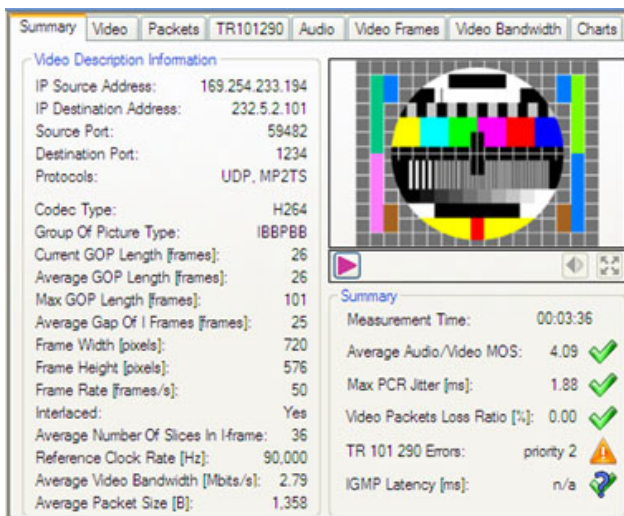

Video Description Information	
IP Source Address:	169.254.233.194
IP Destination Address:	232.5.2.101
Source Port:	59482
Destination Port:	1234
Protocols:	UDP, MP2TS
Codec Type:	H264
Group Of Picture Type:	IBBPBB
Current GOP Length [frames]:	26
Average GOP Length [frames]:	26
Max GOP Length [frames]:	101
Average Gap Of I Frames [frames]:	25
Frame Width [pixels]:	720
Frame Height [pixels]:	576
Frame Rate [frames/s]:	50
Interlaced:	Yes
Average Number Of Slices In I-frame:	36
Reference Clock Rate [Hz]:	90,000
Average Video Bandwidth [Mbits/s]:	2.79
Average Packet Size [B]:	1,358

Summary	
Measurement Time:	00:03:36
Average Audio/Video MOS:	4.09 ✓
Max PCR Jitter [ms]:	1.88 ✓
Video Packets Loss Ratio [%]:	0.00 ✓
TR 101 290 Errors:	priority 2 ⚠
IGMP Latency [ms]:	n/a ?

## Video Description Information

Displays the stream characteristic and reference data extracted from the MPEG frame headers such as: IP Address, Encapsulation, Protocols, Code Type, GOP Details, Frame Details, Reference Clock, Bandwidth, and Packet Size.

Metric	Range	Typical	Description
Endpoint Description	N/A	N/A	The video stream network network description information, including endpoint identification and transport protocol information.
Codec type	MPEG-2, H.264, etc.	N/A	The video codec type for the video stream (autodetected *).
GoP Structure	N/A	N/A	Group of Pictures structure (e.g., IBBPBBPBBPBB) (autodetected *).
GoP Length (Current, Average, Max)	N/A	12	Number of frames in Group of Pictures (autodetected *).
Frame Width	N/A	N/A	Image width in pixels (autodetected*).
Frame Height	N/A	N/A	Image height in pixels (autodetected*).
Frame Rate	N/A	N/A	The video frame rate in frames per 1000 seconds (e.g., 29,970 equals 29.7 frames per second).
Interlaced	Interlaced Non-Interlaced	N/A	A boolean value indicating whether the stream is interlaced (TRUE) or progressive (FALSE)
Average Inter-I Frame Gap	N/A	N/A	The average gap, in frames, between I frames (excluding the I frames).
Slices per I Frame	N/A	N/A	The average number of slices contained in each I frame.
Reference Clock Rate	N/A	N/A	The reference clock rate (PCR/PTS or RTP timestamp) in Hz.

\* Autodetection capabilities may be limited if video payloads are encrypted.

## Getting IPTV Metrics and Results

### Summary

---

### Live Stream Preview

Video and audio preview of the channel whose metrics are currently displayed can be enabled at anytime in the left-top pane of the main window. The preview can be toggled to full screen size or stopped all together and audio can be turned on or muted.

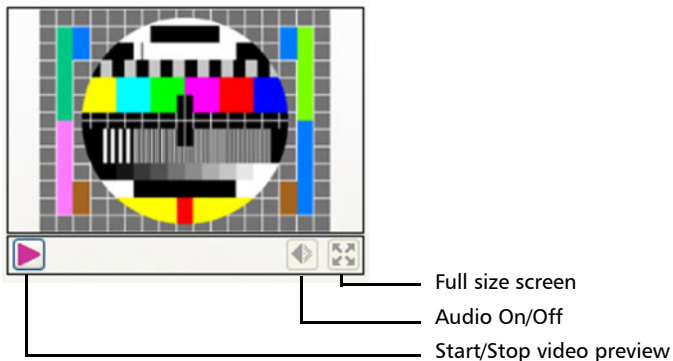







### Summary

Summary provides a list of industry most used parameters for quick evaluation of IPTV service quality such as MOS Score, PCR Jitter, Video Packet Loss, TR 101290, and IGMP Latency (zap time).

The verdict for each parameters is displayed as follows:

Icon	Verdict	Description
	Pass	The value is part of the defined passed threshold.
	Warning	The value is part of the defined warned threshold.
	Fail	The value is part of the defined failed threshold.
	Not available	The value is not available. For TR101290, this icon may also indicates that all threshold check boxes are cleared.

## Getting IPTV Metrics and Results

### Video

## Video

The **Video** tab is available on the right pane of the main window.

The Perceptual Quality Metrics are calculated on the selected video stream to provide Mean Opinion Score (MOS) and related parameters.

Summary	Video	Packets	TR101290	Audio	Video frames	Video bandwidth	Charts
Video perceptual quality metrics							
Instantaneous absolute MOS:	0.00	Video jitter					
Minimal absolute MOS:	0.00	Frame inter arrival jitter 0.00					
Average absolute MOS:	0.00	I-frame inter arrival jitter 0.00					
Maximum absolute MOS:	0.00	Average frame arrival delay 0					
MOS below threshold [%]:	0.0	Peak frame arrival delay 0					
Transmission quality:	50.0	Video scene analysis metrics					
EPSNR:	0.0	Instantaneous detail level: 0					
EPSNR (ATIS):	0.0	Instantaneous motion level: 0					
Degradation factors		Instantaneous panning level: 0					
Loss:	0	Static image proportion: 0.0					
Discard:	0	High detail proportion: 0.0					
Codec quantization level:	0	Low detail proportion: 0.0					
Codec bandwidth restrictions:	0	High panning proportion: 0.0					
Frame resolution:	0	Low panning proportion: 0.0					
Frame rate:	0	High motion proportion: 0.0					
GOP length:	0	Low motion proportion: 0.0					
Available network bandwidth:	0						
Audio/video synchronization:	0						
Recency:	0						

## Video Perceptual Quality

Provides the most essential QoE scoring metrics such a Video MOS scores that results from computation of a complex formula.

**Degradation Factors** provide insight into the nature of MOS score degradation by listing 10 contributing factors with their weight score.

Metric	Range	Typical	Description
Absolute MOS-V*	1.0-5.0	N/A	Video Mean Opinion Score, a 1-5 score that measures the impact of the video codec, image size, frame rate, packet loss distribution, GoP structure, content, and frame loss concealment on viewing quality.
Relative MOS-V*	1.0-5.0	N/A	Relative Video MOS, a 1-5 score that measures the impact of the video codec, frame rate, packet loss, GoP structure, content, and frame loss concealment on viewing quality, but does <i>not</i> consider image size.
MOS-AV*	1.0-5.0	N/A	Audio-Video MOS, a 1-5 score that considers the effect of picture and audio quality and audio-video synchronization on overall user experience.
Proportion Below Threshold Absolute MOS-V	N/A	N/A	The proportion of the stream duration where the Absolute MOS-V fell below the configured analysis threshold.
Proportion Below Threshold Relative MOS-V	N/A	N/A	The proportion of the stream duration where the Relative MOS-V fell below the configured analysis threshold.
Proportion Below Threshold MOS-AV	N/A	N/A	The proportion of the stream duration where the MOS-AV fell below the configured analysis threshold.
VSTQ	0-50	N/A	Video Service Transmission quality, a codec-independent score measuring the ability of the IP network to reliably transmit video content.
Estimated PSNR	N/A	N/A	Estimated Peak Signal to Noise Ratio (PSNR) expressed in dB. This is an estimate of the distortion that has occurred between the source video stream and the output video stream.
Estimated PSNR ATIS	N/A	N/A	Estimated Peak Signal to Noise Ratio (PSNR) calculated according to ATIS specifications.
Degradation Factors**	0-10	Ideal: 0	Severity of perceptual quality degradation caused by (each of) the following factors: packet loss, packet discard (jitter), codec quantization, codec bandwidth restrictions, frame resolution, frame rate, GoP length, available network bandwidth, delay, audio-video synchronization, and the recency of burst packet loss.

\* Separate Instantaneous, Average, Minimum, and Maximum values are reported.

\*\* These metrics may not be available in all cases, or during the early stages of a video session, as the raw data needed to compute these factors may not be available.

## Getting IPTV Metrics and Results

### Video

---

## Video Jitter Metrics

Provides amount of:

- Average Frame and I-frame Inter Arrival Jitter
- Average and Peak Frame Arrival Delay in milliseconds

Metric	Range	Typical	Description
Frame Inter-arrival Jitter	N/A	N/A	Average frame inter-arrival jitter in milliseconds. The inter-arrival jitter is computed relative to the expected arrival time based on the frame rate.
I Frame Inter-arrival Jitter	N/A	N/A	Average I frame inter-arrival jitter in milliseconds. The inter-arrival jitter is computed relative to the expected arrival time based on the frame rate.
Average Frame Arrival Delay	N/A	N/A	Average frame arrival delay, in milliseconds.
Peak Frame Arrival Delay	N/A	N/A	Peak frame arrival delay, in milliseconds. The peak maintains a hold time of approximately 10 seconds.

## Video Scene Analysis Metrics

Provides proportions of the stream with Detail, Panning, Motion, and Static Image. These factors weight on the overall Video MOS score.

Metric	Range	Typical	Description
Detail Level	0-100	N/A	The instantaneous detail level.
Motion Level	0-100	N/A	The instantaneous motion level.
Panning Level	0-100	N/A	The instantaneous panning level.
Proportion with High Detail	0-100%	N/A	The proportion of the video stream that contains high detail.
Proportion with Low Detail	0-100%	N/A	The proportion of the video stream that contains low detail.
Proportion with High Motion	0-100%	N/A	The proportion of the video stream that contains high motion.
Proportion with Low Motion	0-100%	N/A	The proportion of the video stream that contains low motion.
Proportion with High Panning	0-100%	N/A	The proportion of the video stream that contains a high degree of panning.
Proportion with Low Panning	0-100%	N/A	The proportion of the video stream that contains a low degree of panning.
Proportion with Static Image	0-100%	N/A	The proportion of the video stream that contains static image[s].
Proportion with Frozen Image	0-100%	N/A	The proportion of the video stream that contains frozen image[s].
Proportion with No Content	0-100%	N/A	The proportion of the video stream that contains blank image[s].

## Packets

The **Packets** tab is available on the right pane of the main window.

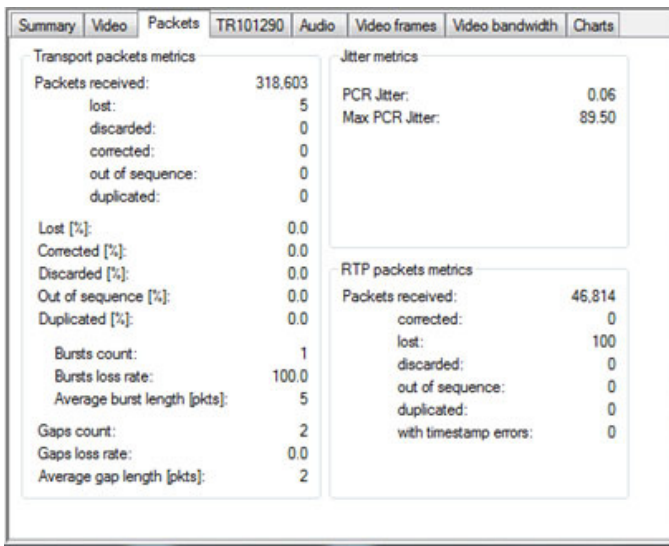

The screenshot shows a software interface with a tabbed menu at the top. The 'Packets' tab is selected. The interface is divided into three main sections: 'Transport packets metrics', 'Jitter metrics', and 'RTP packets metrics'. Each section contains a list of metrics and their corresponding values.

Transport packets metrics	
Packets received:	318,603
lost:	5
discarded:	0
corrected:	0
out of sequence:	0
duplicated:	0
Lost [%]:	0.0
Corrected [%]:	0.0
Discarded [%]:	0.0
Out of sequence [%]:	0.0
Duplicated [%]:	0.0
Bursts count:	1
Bursts loss rate:	100.0
Average burst length [pkts]:	5
Gaps count:	2
Gaps loss rate:	0.0
Average gap length [pkts]:	2

Jitter metrics	
PCR Jitter:	0.06
Max PCR Jitter:	89.50

RTP packets metrics	
Packets received:	46,814
corrected:	0
lost:	100
discarded:	0
out of sequence:	0
duplicated:	0
with timestamp errors:	0

## Transport Packets Metrics

Transport Packets are MPEG-TS packets that carry Packet Elementary Stream (PES).

Statistics of these MPEG-TS Packets such as lost, discarded, corrected, out-of-sequence and duplicated packets allow detection of this major source of video picture degradation.

## Getting IPTV Metrics and Results

### Packets

---

#### Stream Packet Transport Metrics

Metric	Range	Typical	Description
Packets Received	N/A	N/A	Number of packets received by the end system or observed at the monitoring point, excluding any duplicate packets.
Packets Corrected	N/A	0	Number of packets received with errors, but corrected by error correction algorithms, e.g. FEC or Reliable UDP.
Packets Lost	N/A	0	Number of packets identified as lost at the endpoint or monitoring point.
Packets Discarded	N/A	0	Number of packets discarded by the receiving jitter buffer or an estimate of this value made at the monitoring point.
Packets Out of Sequence	N/A	0	Number of packets identified as arriving out of sequence, possibly due to high jitter levels or the use of load-sharing devices.
Packets Duplicated	N/A	0	Number of packets identified as duplicates of previously received packets.
Proportion of Uncorrected Packets Lost	0-100%	0-1%	Proportion of uncorrected packets identified as lost in the transport network.
Proportion of Corrected Packets Lost	0-100%	0-1%	Proportion of corrected packets identified as lost in the transport network after error correction algorithms (e.g. FEC, Reliable UDP) have been applied.
Proportion of Packets Discarded	0-100%	0-20%	Proportion of packets discarded by the receiving jitter buffer or an estimate of this value made at the monitoring point.
Proportion of Out-of-Sequence Packets*	0-100%	0-20%	Proportion of packets arriving out of sequence.
Proportion of Duplicate Packets*	0-100%	0%	Proportion of packets identified as duplicates of previously received packets.
Burst Count	N/A	Ideal: 0	Number of packet loss/discard bursts occurring over the duration of the stream. A burst is defined as a period during which packet loss/discard rate is above 5%.
Burst Length	N/A	N/A	Average length of a burst, in number of transport packets. A burst is defined as a period during which packet loss/discard rate is above 5%.
Burst Loss Rate	5-100%	20%	Proportion of packets lost (before application of error correction algorithms) during burst periods.
Gap Count	N/A	N/A	Number of packet loss/discard gaps between bursts. A gap is defined as a period during which only occasional isolated lost packets occur.
Gap Length	N/A	N/A	Average length of a gap, in number of transport packets.
Gap Loss Rate	0-5%	0%	Proportion of packets lost (before application of error correction algorithms) during gap periods.

## Jitter Metrics

Jitter Metrics focus on the PCR Jitter which is defined as Time Stamp arrival time jitter.

PCR Jitter is a major contributor to loss of frames due to router or STB buffer overflow.

## RTP Packet Metrics

RTP Packet Metrics (if available) are statistics of RTP protocol encapsulation. RTP encapsulation is optional and is used to provide independent time stamping to video and audio. But it also adds overhead to the transmission.

Tracking RTP statistics allows problem isolation to the RTP encapsulating device.

### Stream RTP Transport Metrics for MPEG-2 Transport over RTP

Metric	Range	Typical	Description
Packets Received	N/A	N/A	Number of stream RTP Transport packets received by the end system or observed at the monitoring point, excluding any duplicate packets.
Packets Corrected	N/A	N/A	Number of stream RTP Transport packets received with errors, but corrected by error correction algorithms, e.g. FEC or Reliable UDP.
Packets Lost	N/A	0	Number of stream RTP Transport packets identified as lost at the endpoint or monitoring point.
Packets Discarded	N/A	0	Number of stream RTP Transport packets discarded by the receiving jitter buffer or an estimate of this value made at the monitoring point.
Packets Out of Sequence	N/A	0	Number of stream RTP Transport packets identified as arriving out of sequence, possibly due to high jitter levels or the use of load-sharing devices.
Packets Duplicated	N/A	0	Number of stream RTP Transport packets identified as duplicates of previously received packets.
Timestamp Errors	N/A	0	Number of stream RTP Transport packets received with a timestamp error.

# Getting IPTV Metrics and Results

TR101290

## TR101290

The **TR101290** tab is available on the right pane of the main window.

Summary	Video	Packets	TR101290	Audio	Video frames	Video bandwidth	Charts
MPEG2-TS TR101290 priority 1				MPEG2-TS TR101290 priority 2			
Last errors				Last errors			
TS sync loss count: 0				Transport error count: 0			
Sync byte error count: 0				CRC error count: 0			
PAT error count: 0				PCR error count: 1			
PAT2 error count: 0				PCR repetition error count: 1			
Continuity error count: 0				PCR discontinuity error count: 0			
PMT error count: 0				PCR accuracy error count: 0			
PMT2 error count: 0				PTS error count: 0			
PID error count: 0				CAT error count: 0			

## MPEG2-TS TR101292 Priority 1

Lists Loss and Error counters that are essential for video de-codability.

Metric	Range	Typical	Description
Transport Stream Error Indicators	N/A	0	Indicators of the MP2TS errors that have occurred since this metrics block was last retrieved.
Transport Stream Sync Loss Count	N/A	0	Number of occurrences of transport stream sync loss, i.e., two or more consecutive sync bytes.
Sync Byte Error Count	N/A	0	Number of occurrences of sync byte error.
PAT Error Count	N/A	0	Number of occurrences of Program Association Table (PAT) error.
PAT 2 Error Count	N/A	0	Number of occurrences of PAT 2 error.
Continuity Error Count	N/A	0	Number of occurrences of continuity counter error, i.e., incorrect packet order, duplicate packet, or lost packet.
PMT Error Count	N/A	0	Number of occurrences of Program Map Table (PMT) error.
PMT 2 Error Count	N/A	0	Number of occurrences of PMT 2 error.
PID Error Count	N/A	0	Number of occurrences of Process Identifier (PID) error.



## MPEG2-TS TR101292 Priority 2

Lists Error Counters recommended for continuous or periodic monitoring.

Metric	Range	Typical	Description
Transport Stream Error Indicators	N/A	0	Indicators of the MP2TS errors that have occurred since this metrics block was last retrieved.
Transport Error Count	N/A	0	Number of occurrences of packet with transport error bit set.
CRC Error Count	N/A	0	Number of occurrences of PAT and/or PMT cyclic redundancy check (CRC) error.
PCR Error Count	N/A	0	Number of occurrences of Program Clock Reference (PCR) error.
PCR Repetition Error Count	N/A	0	Number of times the interval between two consecutive PCR values is greater than 40 milliseconds.
PCR Discontinuity Error Count	N/A	0	Number of times the difference between two consecutive PCR values is outside the range of 0 to 100 milliseconds.
PCR Accuracy Error Count	N/A	0	Number of occurrences of PCR accuracy error.
PTS Error Count	N/A	0	Number of times the presentation timestamp (PTS) repetition period is greater than 700 milliseconds.
CAT Error Count	N/A	0	The number of occurrences of Conditional Access Table (CAT) error.

## Audio

The **Audio** tab is available on the right pane of the main window.

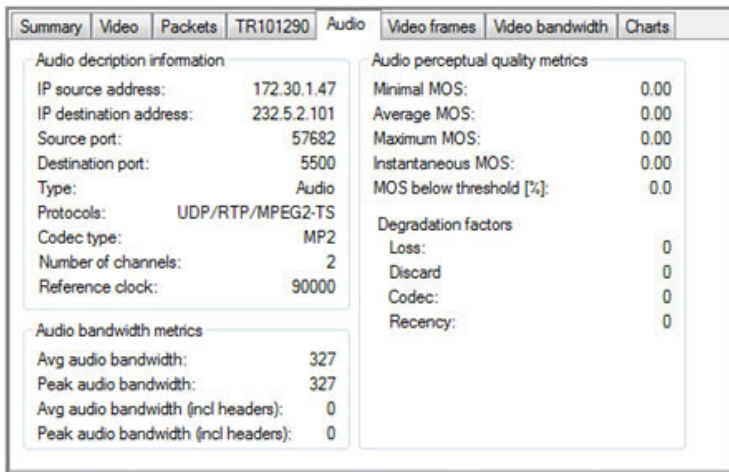

## Audio Description Information

Similar to Video Description Information providing essential reference information about the stream.

Metric	Range	Typical	Description
Endpoint Description	N/A	N/A	The audio stream network network description information, including endpoint identification and transport protocol information.
Codec type	MPEG-4 AAC, AC-3, etc.	N/A	The audio codec type for the audio stream (autodetected*).
Number of Channels	N/A	N/A	The number of audio channels encoded in the audio stream. (A negative value indicates the number of channels is unknown.)
Reference Clock Rate	N/A	N/A	The reference clock rate (RTP timestamp or MP2TS PCR/PTS), in Hz.

\* Autodetection capabilities may be limited if audio payloads are encrypted.

## Audio Bandwidth Metrics

Provides bandwidth average and peak rate with and without headers.

Metric	Range	Typical	Description
Average Audio Bandwidth	N/A	N/A	Average audio bandwidth in bits/second, excluding transport packet overhead, FEC, and retransmissions.
Peak Audio Bandwidth	N/A	N/A	Peak audio bandwidth in bits/second, excluding transport packet overhead, FEC, and retransmissions.
Average Receive Bandwidth	N/A	N/A	Average bandwidth of transport packets received, in bits/second.
Peak Receive Bandwidth	N/A	N/A	Peak bandwidth of transport packets received, in bits/second.

## Audio Perceptual Quality Metrics

Audio Perceptual Quality Metrics are MOS scores with subjective test content calculated with a specialized VQMON audio algorithm.

Degradation Factors provide severity of degradation due to Packet Loss, Packet Discard, Codec, a Recency of burst packet loss

Metric	Range	Typical	Description
MOS-A*	1.0-5.0	N/A	Audio Mean Opinion Score, a 1-5 score that measures the impact of the audio codec, bit rate, sample rate, and packet loss on audio quality.
Proportion Below Threshold MOS-A	N/A	N/A	The proportion of the stream duration where the MOS-A value falls below the configured analysis threshold.
Degradation Factors**	0-10	Ideal: 0	Severity of perceptual quality degradation caused by (each of) the following factors: packet loss, packet discard (jitter), codec distortion, and the recency of burst packet loss.

\* Instantaneous, Average, Minimum, and Maximum values are reported.

\*\* These metrics may not be available in all cases, or during the early stages of a video session, as the raw data needed to compute these factors may not be available.

## Getting IPTV Metrics and Results

### Video Frames

---

## Video Frames

The **Video Frames** tab is available on the right pane of the main window.

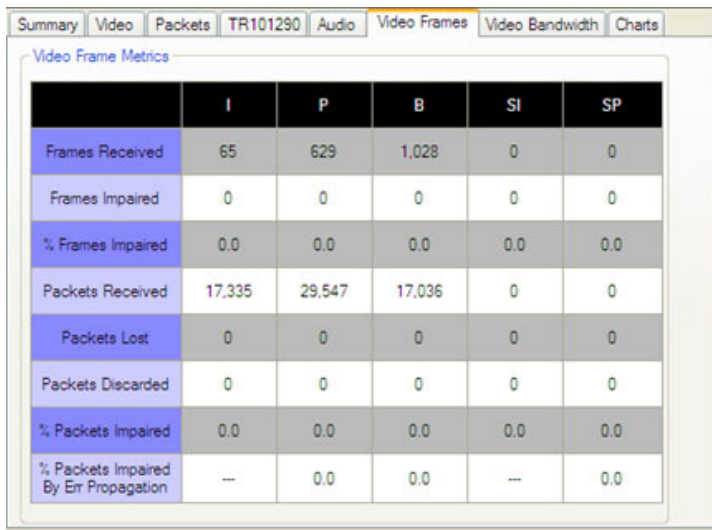

	I	P	B	SI	SP
Frames Received	65	629	1,028	0	0
Frames Impaired	0	0	0	0	0
% Frames Impaired	0.0	0.0	0.0	0.0	0.0
Packets Received	17,335	29,547	17,036	0	0
Packets Lost	0	0	0	0	0
Packets Discarded	0	0	0	0	0
% Packets Impaired	0.0	0.0	0.0	0.0	0.0
% Packets Impaired By Err Propagation	--	0.0	0.0	--	0.0

## Video Frame Metrics

Video Frames (MPEG-TS) statistics provide the total number of Received and Impaired frames I, P, B and optional SI and SP. This breakdown allows better diagnostics of the distorted video.

Packet statistics such as Packet Lost, Packets Discarded and Packets Impaired correspond to the MPTEG-TS frame statistics and they allow more detail breakdown of the diagnostics.

Metric	Range	Typical	Description
I Frames Received	N/A	N/A	Number of I Frames received.
I Frames Impaired	N/A	N/A	Number of I Frames impaired by packet loss/discard.
Proportion of I Frames Impaired	0-100%	N/A	Proportion of I Frames impaired by packet loss/discard.
P Frames Received	N/A	N/A	Number of P Frames received.
P Frames Impaired	N/A	N/A	Number of P Frames impaired by packet loss/discard.
Proportion of P Frames Impaired	0-100%	N/A	Proportion of P Frames impaired by packet loss/discard.
B Frames Received	N/A	N/A	Number of B Frames received.
B Frames Impaired	N/A	N/A	Number of B Frames impaired by packet loss/discard.
Proportion of B Frames Impaired	0-100%	N/A	Proportion of B Frames impaired by packet loss/discard.
SI Frames Received	N/A	N/A	Number of SI Frames received.
SI Frames Impaired	N/A	N/A	Number of SI Frames impaired by packet loss/discard.
Proportion of SI Frames Impaired	0-100%	N/A	Proportion of SI Frames impaired by packet loss/discard.
SP Frames Received	N/A	N/A	Number of SP Frames received.
SP Frames Impaired	N/A	N/A	Number of SP Frames impaired by packet loss/discard.
Proportion of SP Frames Impaired	0-100%	N/A	Proportion of SP Frames impaired by packet loss/discard.
I Frame Packets Received	N/A	N/A	Number of transport packets received containing video I frame information.
I Frame Packets Lost	N/A	N/A	Number of transport packets lost containing video I frame information.
I Frame Packets Discarded	N/A	N/A	Number of transport packets discarded by the playout (jitter) buffer containing video I frame information.
Proportion of I Frame Packets Impaired	0-100%	N/A	Proportion of transport packets impaired by loss/discard containing video I frame information.
P Frame Packets Received	N/A	N/A	Number of transport packets received containing video P frame information.
P Frame Packets Lost	N/A	N/A	Number of transport packets lost containing video P frame information.

## Video Bandwidth

The **Video Bandwidth** tab is available on the right pane of the main window.

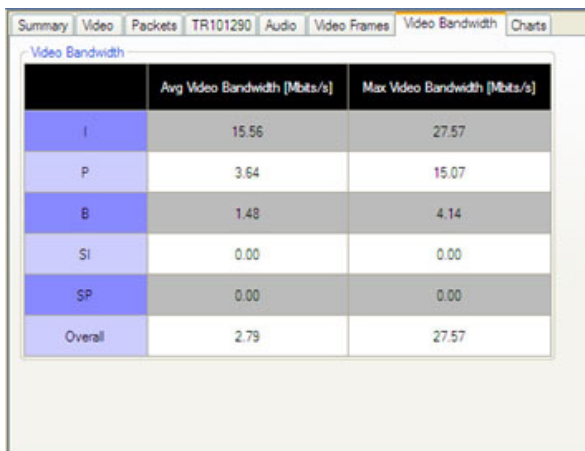

	Avg Video Bandwidth [Mbps/s]	Max Video Bandwidth [Mbps/s]
I	15.56	27.57
P	3.64	15.07
B	1.48	4.14
SI	0.00	0.00
SP	0.00	0.00
Overall	2.79	27.57

Video Bandwidth of I, P, B, SI and SP frames provides useful traffic information. MOS and other metrics can be used to determine how much less or more bandwidth to add or reduce to maintain the quality goal and bandwidth utilizations at the same time.

Metric	Range	Typical	Description
Average Video Bandwidth	N/A	N/A	Average bandwidth of transmitted video content in bits/second, excluding IP overhead, FEC, and retransmissions.
Peak Video Bandwidth	N/A	N/A	Peak bandwidth of transmitted video content in bits/second, excluding IP overhead, FEC, and retransmissions.
Average Receive Bandwidth	N/A	N/A	Average bandwidth of video transport packets in bits/second, excluding IP overhead, FEC, and retransmissions.
Peak Receive Bandwidth	N/A	N/A	Peak bandwidth of video transport packets in bits/second, excluding IP overhead, FEC, and retransmissions.
Average I Frame Video Bandwidth	N/A	N/A	Average bandwidth for I frame video content in bits/second, excluding IP overhead, FEC, and retransmissions.
Peak I Frame Video Bandwidth	N/A	N/A	Peak bandwidth for I frame video content in bits/second, excluding IP overhead, FEC, and retransmissions.
Average I Frame Receive Bandwidth	N/A	N/A	Average bandwidth for I frame transport packets in bits/second, excluding IP overhead, FEC, and retransmissions.
Peak I Frame Receive Bandwidth	N/A	N/A	Peak bandwidth for I frame transport packets in bits/second, excluding IP overhead, FEC, and retransmissions.
Average P Frame Video Bandwidth	N/A	N/A	Average bandwidth for P frame video content in bits/second, excluding IP overhead, FEC, and retransmissions.
Peak P Frame Video Bandwidth	N/A	N/A	Peak bandwidth for P frame video content in bits/second, excluding IP overhead, FEC, and retransmissions.

## Getting IPTV Metrics and Results

### Charts

## Charts

The **Charts** tab is available on the right pane of the main window.

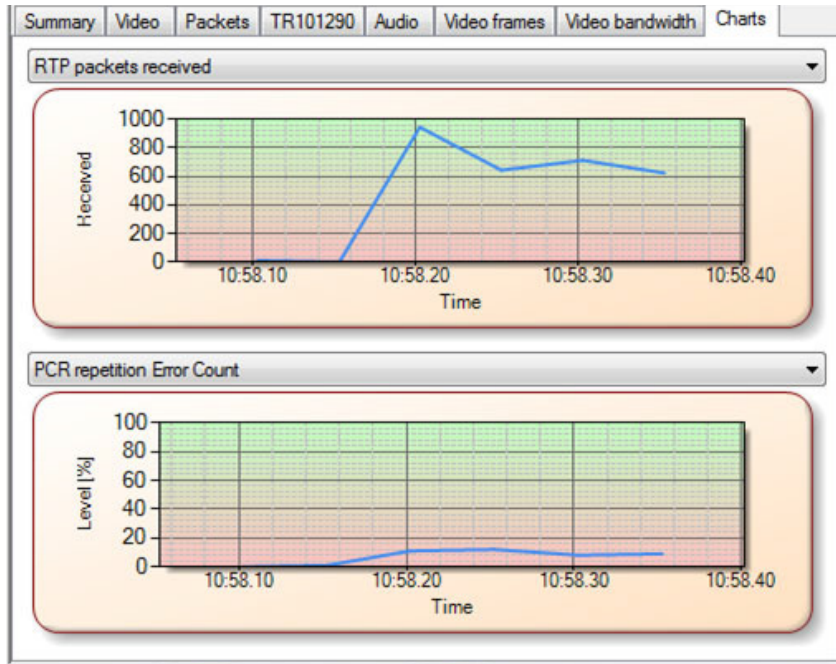

Any two metrics can be displayed as histograms allowing correlation of events for diagnostics.



## Test Results

The test results allows generating and viewing test results.

From the main menu, tap on **Results**. Alternatively type on the report icon located next to the **Select Interface** field.

EXpert IPTV Test Tools - Test Results

Search Filter

From Date: Mon, October 24, 2011 To Date: Mon, October 24, 2011

Measurements

Destination Address	Start Date	Duration	MOS	PCR Jitter [ms]	Packet Loss Ratio [%]	IGMP Latency [ms]	TR101290 Errors	Result
239.1.6.1	10/24/2011 7:4...	00:00:02	0.00	1.38	0.0	n/a	priority 1 and 2	❌
239.1.4.1	10/24/2011 7:4...	00:00:02	0.00	1.38	0.0	n/a	priority 1 and 2	❌
239.1.3.1	10/24/2011 7:4...	00:00:02	0.00	1.38	0.0	n/a	priority 1 and 2	❌
239.1.2.1	10/24/2011 7:4...	00:00:02	0.00	1.38	0.0	n/a	priority 1 and 2	❌
239.1.1.1	10/24/2011 7:4...	00:00:02	0.00	1.38	0.0	n/a	priority 1 and 2	❌
239.1.5.1	10/24/2011 7:4...	00:01:36	3.68	2.06	0.0	n/a	priority 2	⚠️
239.1.1.1	10/24/2011 8:0...	00:02:08	3.62	1.06	0.0	n/a	priority 1	⚠️
239.1.1.1	10/24/2011 8:0...	00:06:23	3.93	0.31	0.0	n/a	priority 1	⚠️

Remove Selected... Generate Reports Exit

## Search Filter

Search filter is used to defines which tests will be listed in the **Measurement** table based on test's dates. Select the **From Date** and **To Date** and the list of test is automatically updated.

## Getting IPTV Metrics and Results

### Measurements

## Measurements

Double-clicking on a test record produces the metrics screen where all test metrics are accessible from the tabs:

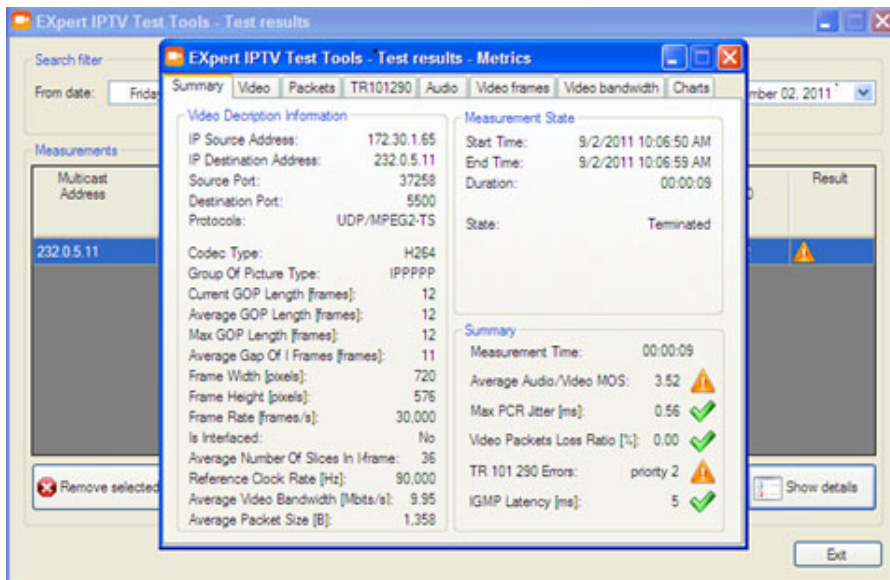

## Remove Selected

Allows to permanently delete test results from the list. Select the test(s) to be deleted and tap the **Remove Selected** button.

## Generate Reports

Allows the generation of a test report in PDF format. Report files are saved under **My Documents/EXpert IPTV Test Tools Reports**.

### To generate a test report:

1. Select the test results to be included in the report using the **Search Filter**.
2. Tap the **Generate Reports** button to generate the report for all tests listed in the **Measurements** table. The report contains a summary page and four metrics pages per test record as follows:

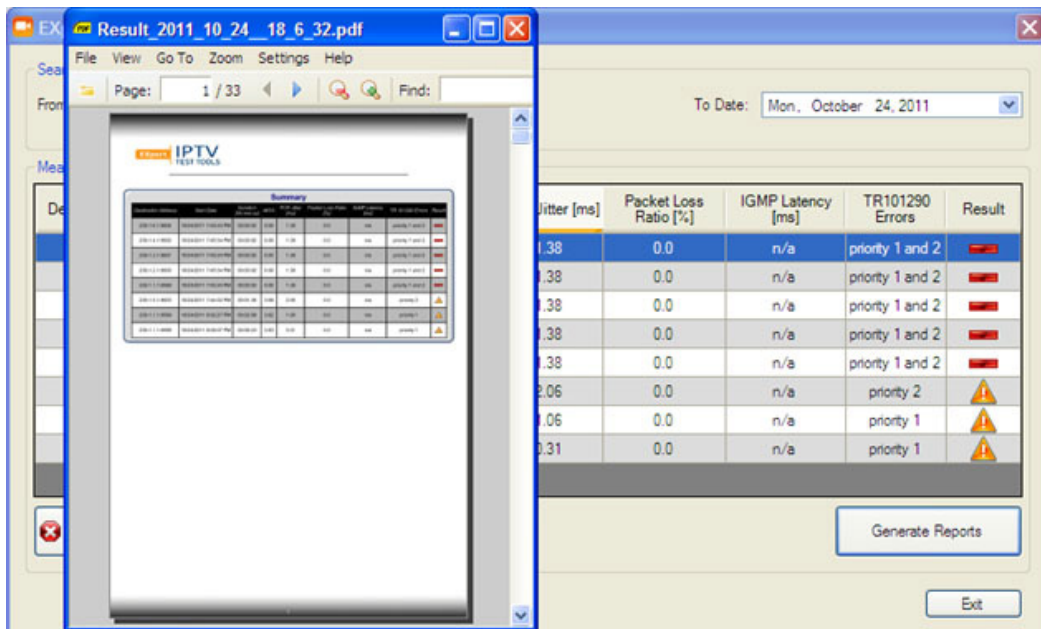

# Getting IPTV Metrics and Results

## Generate Reports

### General Results

Measurement Start Date: 9/17/2011  
Measurement Start Time: 2:28 PM

**Summary**

Measurement Time	09:10:30
Average Audio/Video MOS	4.02
Max PCR Jitter (ms)	2.09
Video Packet Loss Ratio (%)	0.00
RTT/CSO Priority Errors	priority 1 and 2
QoS Latency (ms)	na

**Summary Result**

**Failed**

**Details of test**

#### Video Description Information

IP Source Address: 192.204.110.02  
IP Destination Address: 202.53.2.91  
Source Port: 34930  
Destination Port: 3000  
Transport Protocol: UDP(192.168.0.0/16) FT

Codec Type: H264  
Stream ID Profile (GOP) Type: 009F00  
Current GOP Length (Frames): 30  
Average GOP Length (Frames): 30  
Max GOP Length (Frames): 30  
Average Gap (I-Frames) (Frames): 30  
Frame Rate (Frames/s): 750  
Frame Width (Pixels): 675  
Frame Height (Pixels): 600.00  
V-Interleave: Yes  
Average Number of Slides in I-Frames: 30  
Reference Clock Rate (Hz): 80.000  
Average Video Bandwidth (Mbps): 2.70  
Average Packet Size (B): 1.970

#### Audio Description Information

IP Source Address: 192.204.110.02  
IP Destination Address: 202.53.2.91  
Source Port: 34930  
Destination Port: 3000  
Transport Protocol: UDP(192.168.0.0/16) FT

Codec Type: MP3  
Stream Type: Audio  
Number of Channels: 2  
Reference Clock Rate (Hz): 80.000

**Relative Instantaneous MOS**

### Video metrics

#### Video Perceptual Quality Metrics

Instantaneous Absolute MOS: 4.02  
Minimum Relative MOS: 2.10  
Average Absolute MOS: 4.02  
Maximum Absolute MOS: 4.02  
Below Faked Threshold Absolute MOS (%) 0.1 %  
Instantaneous Relative MOS: 4.01  
Minimum Relative MOS: 2.02  
Average Relative MOS: 4.02  
Maximum Relative MOS: 4.02  
Below Faked Threshold Relative MOS (%) 0.1 %  
Instantaneous Audio/Video MOS: 4.02  
Minimum Audio/Video MOS: 1.94  
Average Audio/Video MOS: 4.02  
Maximum Audio/Video MOS: 4.02  
Below Faked Threshold Audio/Video MOS (%) 0.1 %  
Transmission Quality: 90.0  
EPDAP (dB): 44.0  
EPDAP (kTTS) (dB): 42.0

#### Video Degradation Factors

Loss: 0  
Discard: 0  
Codec Quantization Level: 0  
Codec Bandwidth Restrictions: 0  
Frame Resolutions: 0  
Frame Rate: 0  
GOP Length: 0  
Available Network Bandwidth: 0  
Audio/Video Synchronization: 0  
Recovery: 0

#### Video Jitter Metrics

Frame Inter-Arrival Jitter (ms): 0.11  
I-Frame Inter-Arrival Jitter (ms): 0.00  
Average Frame Arrival Delay (ms): 4.780  
Peak Frame Arrival Delay (ms): 25.800

#### Video Frames Metrics

	Frames Received	Frames Requested	Frames Squashed (%)
I-Frames	1.000	0	0.0
P-Frames	16.710	0	0.0
B-Frames	24.280	0	0.0
S-Frames	0	0	0.0
SP-Frames	0	0	0.0

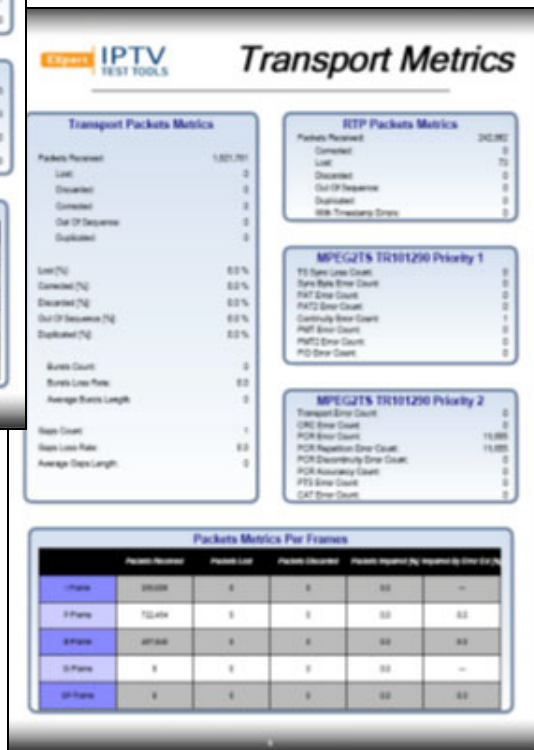
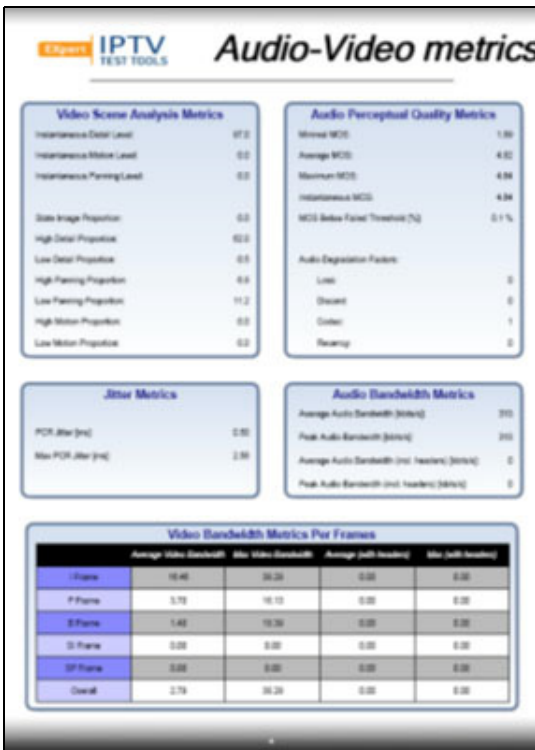

L



# 7 **Troubleshooting**

## **Contacting the Technical Support Group**

To obtain after-sales service or technical support for this product, contact EXFO at one of the following numbers. The Technical Support Group is available to take your calls from Monday to Friday, 8:00 a.m. to 7:00 p.m. (Eastern Time in North America).

### **Technical Support Group**

400 Godin Avenue  
Quebec (Quebec) G1M 2K2  
CANADA

1 866 683-0155 (USA and Canada)  
Tel.: 1 418 683-5498  
Fax: 1 418 683-9224  
support@exfo.com

For detailed information about technical support, and for a list of other worldwide locations, visit the EXFO Web site at [www.exfo.com](http://www.exfo.com).

If you have comments or suggestions about this user documentation, you can send them to [customer.feedback.manual@exfo.com](mailto:customer.feedback.manual@exfo.com).

To accelerate the process, please have information such as the name and the serial number (see the product identification label), as well as a description of your problem, close at hand.





# A Specifications

Physical Layers Supported	10/100/1000 Ethernet, Wi-Fi 802.11 b/g/n.
Recognized Video Compression Standards Codecs	unknown video motion JPEG video MPEG-1 video MPEG-2 video ITU-T H.261 video ITU-T 1996 version of H.263 video ITU-T 1998 version of H.263+ video ITU-T H.264 video MPEG-4 video Microsoft VC1 video MPEG2, MPEG4 part 2&10 (H.264)
Recognized Audio Compression Standards Codecs	unknown audio MPEG-1 Layer 1 audio MPEG-1 Layer 2 audio MPEG-1 Layer 3 audio MPEG-2 Advanced Audio Coding AC-3 audio MPEG-4 Advanced Audio Coding MPEG-4 Low Delay Advanced Audio Coding MPEG-4 High Efficiency Advanced Audio Coding
Signaling Protocols	IGMP versions 2 & 3, RTSP
STB Emulation	IGMP Join and Leave request IGMP latency VoD RTSP Play and Stop Connects up to 10 channels (streams) Monitors up to 10 channels Video preview ( live full frame SD and HD)

## Specifications

---

Summary - Video Description Information	IP source address IP destination address Source port Destination port Protocols Codec type Group of picture type Current GOP length Average GOP length Max GOP length Average gap of I frame Frame width Frame height Frame rate interlaced Average number of slices in I frame Reference clock rate Average video bandwidth Average packet size
Summary - Metrics	Measurement time Average audio/video MOS Max PCR Jitter Video packet loss rate TR 101290 errors priority 1 and 2 IGMP Latency

Video Perceptual Quality Metrics	<p>Instantaneous absolute MOS            Minimal absolute MOS            Average absolute MOS            Maximum absolute MOS            Instantaneous relative MOS            Minimal relative MOS            Average relative MOS            Maximum relative MOS            Instantaneous audio/video MOS            Minimal audio/video MOS            Average audio/video MOS            Maximum audio/video MOS            Transmission quality:            - EPSNR            - EPSNR(ATIS)            Degradation Factors:            - Lost            - Discarded            - Codec quantization level            - Codec bandwidth restrictions            - Frame resolution            - Frame rate            - GOP length            - Available network bandwidth            - Audio/video synchronization            - Recency</p>
Video Jitter	<p>Frame inter arrival jitter            I frame inter arrival jitter            Average frame arrival delay            Peak frame arrival delay</p>
Video Scene Analysis Metrics	<p>Instantaneous detail level            Instantaneous motion level            Instantaneous panning level            Static image proportion            High detail proportion            Low detail proportion            High panning proportion            Low panning proportion            High motion proportion            Low motion proportion</p>

## Specifications

Packets - Transport Packets Metrics	Packets received Lost Discarded Corrected Out of sequence Duplicated Lost % Corrected % Discarded % Out of sequence % Duplicated % - Burst count - Burst loss rate - Average burst length [pkts] Gap count Gaps loss rate Average gap length [pkts]
Jitter Metrics (RFC3550)	Packet to packet delay variation Max packet to packet delay variation
RTP Packets Metrics (Carrying MPEG2-TS)-	Packets - Received - Corrected - Lost - Discarded - Out of sequence -Duplicated -With timestamp errors
MPEG2-TS TR101290 - Priority 1 last errors	TS sync loss count Sync byte error count PAT error count PAT2 error count Continuity error count PMT error count PMT2 error count PID error count
MPEG2-TS TR101290 - Priority 2 last errors	Transport error count CRC error count PCR error count PCR repetition error count PCR discontinuity error count PCR accuracy error count

Audio Description Information	<ul style="list-style-type: none"> <li>IP source address</li> <li>IP destination address</li> <li>Source port</li> <li>Destination port</li> <li>Type</li> <li>Transport protocol</li> <li>Codec Type</li> <li>Number of channels</li> <li>Reference clock</li> </ul>
Audio Perceptual Quality Metrics	<ul style="list-style-type: none"> <li>Minimal MOS</li> <li>Average MOS</li> <li>Maximum MOS</li> <li>Instantaneous MOS</li> <li>Degradation factors</li> <li>Lost</li> <li>Discarded</li> <li>Codec</li> <li>Recency</li> </ul>
Audio bandwidth metrics	<ul style="list-style-type: none"> <li>Avg audio bandwidth</li> <li>Peak audio bandwidth</li> <li>Avg audio bandwidth( incl headers)</li> <li>Peak audio bandwidth( incl headers)</li> </ul>
Video Frames I,P,B,SI,SP	<ul style="list-style-type: none"> <li>Frames received</li> <li>Frames impaired</li> <li>% frames impaired</li> <li>Packets received</li> <li>Packet lost</li> <li>Packet discarded</li> <li>% packets impaired</li> <li>%packets impaired by error propagation</li> <li>- Except for I and SI</li> </ul>
Video bandwidth of I,P,B, SI and SP frames	<ul style="list-style-type: none"> <li>Average video bandwidth</li> <li>Max video bandwidth</li> </ul>
Histograms (charts)	Up to two charts from any metrics
LAN Port	<ul style="list-style-type: none"> <li>IP address</li> <li>Downstream rate</li> <li>Upstream rate</li> </ul>



# **B** *Glossary*

## **Acronym List**

?	Help
---	------

### **A**

AAC	Advanced Audio Coding
ASP	Advanced Simple Profile
AVC	Advanced Video Coding

### **B**

B-frame	Bi-directional-frame
---------	----------------------

### **C**

CAGE	Commerce And Government Entities
CC	Continuity Counter
CE	European Conformity
CHC	Conversational High Compression

### **D**

DCT	Discrete Cosine Transform
DHCP	Dynamic Host Configuration Protocol
CIF	Common Intermediate Format
DVB	Digital Video Broadcasting

## Glossary

### Acronym List

---

#### E

SPSNR	Estimated Peak Signal to Noise Ratio
ESD	Electrostatic Discharge

#### F

FCC	Federal Communications Commission
FEC	Forward Error Correction

#### G

GoP	Group of Pictures
GPON	Gigabit Passive Optical Network
GUI	Graphical User Interface

#### H

HD	High Definition
----	-----------------

#### I

I-frame	Intra-coded-frame
ID	Identification
IGMP	Internet Group Multicast Protocol
IP	Internet Protocol
IPTV	Internet Protocol Television
ISO	International Organization for Standardization



L

LAN	Local Area Network
LED	Light-Emitting Diode

M

MAC	Media Access Control
Mbit/s	Megabit Per Second
MOS	Mean Opinion Score
MPEG	Motion Picture Experts Group
MSE	Mean Square Error

N

NATO	North Atlantic Treaty Organization
------	------------------------------------

P

P-frame	Predictive-frame
PCR	Program Clock Reference
PES	Packet Elementary Stream
PID	Program Identifier
PPDV	Packet-to-Packet Delay Variation
PSNR	Peak Signal-to-Noise Ratio

## Glossary

### Acronym List

---

#### Q

QCIF	Quarter Common Intermediate Format
QoE	Quality of Experience

#### R

RMA	Return Merchandise Authorization
RTP	Real Time Protocol
RTSP	Real Time Streaming Protocol

#### S

SD	Standard Definition
SI	Switching I
SP	Switching P
STB	Set Top Box

#### U

UDP	User Data Protocol
URI	Universal Resource Identifier

#### V

VMM	VQmon Markov Model
VoD	Video on demand
VQmon	Voice Quality monitoring
VSTQ	Video Service Transmission Quality

## Metrics

### Perceptual Quality Metrics

Metric	Description
MOS-V	Video MOS, a 1-5 score that considers the effect of the video codec, frame rate, packet loss distribution and GoP structure on viewing quality
MOS-A1 and MOS-A2 for 2 codecs that are present in some streams	Audio MOS, a 1-5 score that considers the effect of the audio codec, bit rate, sample rate and packet loss on viewing quality
MOS-A1V	Audio-Video MOS - a 1-5 score that considers the effect of picture & audio quality and audio-video synchronization on overall user experience
Video Service Transmission Quality (VSTQ)	Transmission quality, a 0-50 codec independent score measuring the ability of the IPTV network to carry reliable video
Video Service Picture Quality (VSPQ)	Picture quality, a 0-50 score that considers the effect of the video codec, frame rate, packet loss distribution and GoP structure
Gap VSPQ	Picture quality during "good" periods when little or no degradation is occurring
Burst VSPQ	Picture quality during "bad" periods when significant degradation is occurring
Video Service Audio Quality for 2 codecs (VSA1Q and VSA2Q)	Audio quality, a 0-50 score that considers the effect of the audio codec, bit rate, sample rate and packet loss on viewing quality

## Glossary

### Metrics

---

Metric	Description
Video Service Multimedia Quality (VSMQ)	Multimedia (Audio-Video) quality, a 0-50 score that considers the effect of picture & audio quality and audio-video synchronization on overall user experience
Estimated PSNR (EPSNR)	Estimated Peak Signal to Noise Ratio (PSNR) expressed in dB. This is an estimate of the distortion that has occurred between the source video stream and the output video stream.
Degradation Factors	Percentage degradation in quality due to (each of) Loss, Discard, Codec type, Audio-Video Sync, Delay and Recency.

## Video Stream Metrics

The Video Stream Description provides information on the type of codec being used, Group of Pictures structure and length, image size and other key factors.

### Video Stream Description

Metric	Description
Codec type	Type of codec (e.g. MPEG4)
GoP type	Group of Pictures type (e.g. IBBP...)
GoP length	Number of frames in Group of Pictures
Image size	Image size in pixels (X x Y) (autodetected *) and number of frames per second

Video Stream Metrics provide insight into the proportion of different type of video frame that are impacted by packet loss and discard, and to the overall video bandwidth.

#### Video Stream Metrics

<b>Metric</b>	<b>Description</b>
I, P, B frame packets received	Counts of the numbers of I, P and B frame packets received
I, P, B frame packets lost	Counts of the numbers of I, P and B frame packets
I, P, B frame packets discarded	Counts of the numbers of I, P and B frame packets

## Transport Metrics

Packet Loss Metrics provide essential data on IPTV packet loss before and after the effects of error correction (such as FEC or Reliable UDP). Burst and gap statistics provide valuable insight into the time distribution of lost and discarded packets.

### MPEG-TS Packet Loss Metrics

Metric	Description
Packet Loss Rate	Percentage of MPEG-TS packets lost in the network
Packet Discard Rate	Percentage of packets discarded due to late arrival
Out of Sequence Packet Rate	Percentage of packets arriving out of sequence
Duplicate Packet Rate	Percentage of duplicate packets
Burst Loss Rate	Percentage of packets lost within burst periods
Burst Length	Average length of burst periods
Gap Loss Rate	Percentage of packets lost within gap periods
Gap Length	Average length of gaps between bursts

### PCR (Program Clock Reference) Jitter Metrics

Metric	Description
PCR Jitter	Program Clock Reference Jitter

## MDI (Media Delivery Index) Metrics

<b>Metric</b>	<b>Description</b>
MDI Delay Factor	Media Delivery Index Delay Factor is the maximum difference, observed at the end of each media stream packet, between the arrival of media data and the drain of media data
MDI Media Loss Rate	Media Delivery Index Loss Rate is the count of lost or out-of-order packets carrying streaming application information over a selected time interval

TR101 290 metrics provide green LED ON/OFF information on certain key error types that occur with MPEG Transport protocols, and are useful in identifying and resulting these error conditions.

## TR 101 290 MPEG Metrics

<b>Metric</b>	<b>Description</b>
TS_sync_loss	Loss of synchronization at MPEG transport layer
Sync_byte_error	Invalid MPEG transport sync byte
Continuity_count_error	Incorrect packet order, duplicate packet or lost packet
Transport_error	Transport error indicator in MPEG transport header set
PCR_repetition_error	Time interval between two successive PCR values more than 40ms
PCR_discontinuity_indicator_error	Difference between two consecutive PCR values is over 100ms without discontinuity bit set
PTS_error	Interval between presentation time stamps more than 700ms

## IPTV

### IPTV Video Stream

The IPTV Video Stream is subjected to multilevel analysis as shown here:

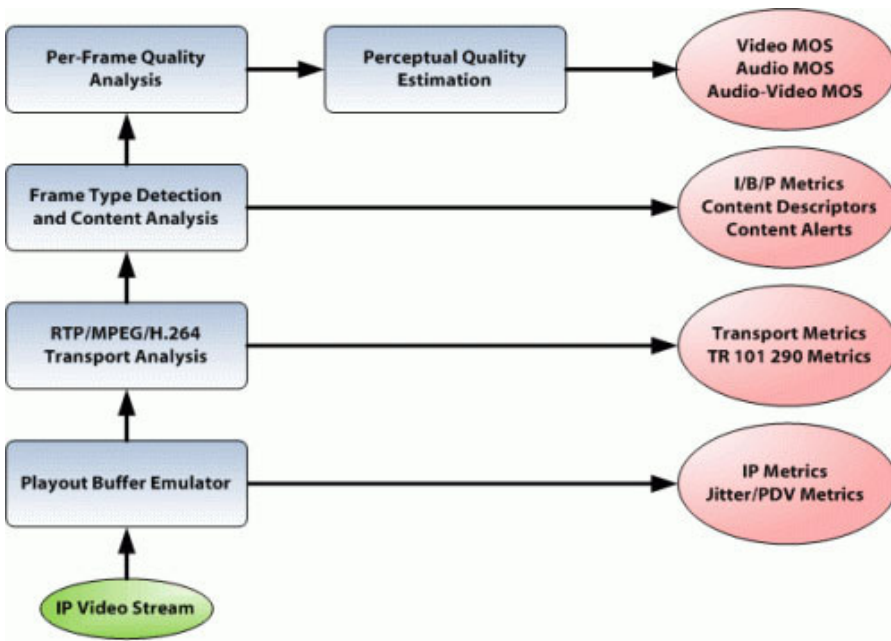

VQmon/HD Components and Reported Metrics



## Understanding IPTV Video Perceptual Quality<sup>1</sup>

The perceptual quality of video transmitted across IPTV networks is susceptible to degradation from a number of transmission network sources including, frame errors caused by packet loss, discard of packets due to excessive delay/jitter, and discard of packets due to arrival sequencing errors. Simply relying on packet loss statistics, however, is not an accurate way to measure video quality as perceived by viewers. The same degree of packet loss may cause obvious distortion or may not even be noticed by the end user, depending on which video frame types are impaired.

In addition, impairments can be introduced during the encoding/decoding process, by the codec itself or an inappropriately low bit rates. The video content (e.g., level of detail and motion on-screen) can also have a significant impact on the visibility of problems. Furthermore, perceptual quality is affected by subjective factors including human reaction time and the 'recency effect'. Coupled with the type of content, e.g., fast motion, high detail, or frequent scene changes, the quality of experience for the viewer will vary even under the same impairment conditions.

Each of these objective and subjective factors must be taken into consideration in order to accurately estimate IPTV video perceptual quality.

---

1. The following information is proprietary to Telchemy, Incorporated and was published with its permission.

➤ **Transmission-Related Impairments**

Packet-based video can be very sensitive to network impairments. Packet loss can cause sections of frames or complete frames to be corrupted or deleted. For example, the MPEG compression algorithm uses block-based motion compensation for the reduction of temporal redundancy and Discrete Cosine Transform (DCT)-based compression for the reduction of spatial redundancy. An MPEG encoder may generate three types of frame: Intra-coded (I), Predictive (P), and Bi-directional (B) frames.

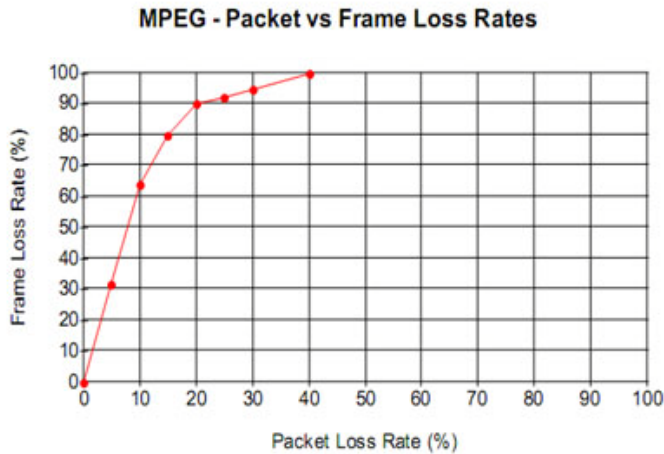

As a frame often spans multiple packets, and a typical video stream includes interpolated frames (P-frames and B-frames), a given packet loss rate can result in a frame loss rate six times higher; see figure above.

In order to accommodate IPTV transmission network delay and low levels of delay variation, a playout buffer is used to temporarily store incoming frames. For streaming video, such as DVB or IPTV, it is permissible to apply arbitrary delays, and hence the playout buffer can be quite large. Interactive video conferencing requires a relatively low

delay, since a participant needs to respond immediately to questions or opinions of the other participants. Packets arriving too late may be discarded and will appear as lost packets.

Traditionally, video quality is measured by comparing the video sequence that has been processed by a video system to the original reference video sequence. It is not feasible to implement a mid-stream real-time monitoring system using this approach. This is because it needs to directly access the video source and decode video content, and has high computational complexity.

To overcome these disadvantages, it is therefore desirable to monitor transmission impairments in order to ensure good video quality. VQmon/HD is a non-intrusive monitoring technology that can passively measure the characteristics of live packet-based video streams and report quality scores in real-time. VQmon/HD models the way that time-varying impairments, most notably burst packet loss and possible playout buffer discards, affect perceived video quality.

➤ **Impact of Packet Loss and Jitter on Video Quality**

Common video codecs, such as MPEG and H.263 implementations, use a combination of intra- and inter-frame coding methods. For intra-frame encoding (I frame) the image frame is divided into blocks, a Discrete Cosine Transform is used to convert each block to a set of coefficients and then variable length coding is applied. A group of blocks are combined into a single entity (slice), which can be carried within a single packet. If a transmission error occurs then the whole group may be lost, creating a "stripe" within the decoded image. For example, because the DC coefficients within each block are encoded from the first block in the slice, an error makes this information unusable for the remainder of the slice. Some errors may damage the frame structure and render the whole frame unusable.

For inter-frame or motion-based coding (P and B frames), motion vectors are determined for each block and encoded. As for intra-frame coding, errors can render a whole slice or frame

# Glossary

## IPTV

---

unusable. In simple inter-frame coding systems, the loss of one I or P frame can make all subsequent frames unusable until the next I frame is received-resulting in a significant period of degraded, frozen, or blank video.

**Note:** *The H.264 (MPEG-4 AVC) codec standard introduces two new frame types, "Switching I" (SI) and "Switching P" (SP), which are designed to enable the decoder to more easily switch between video streams with different bitrates. VQmon/HD reports SI and SP frame metrics when H.264 is used.*

The following figure shows the impact of encoding errors on various frame types (I, B, and P) in a typical Group of Pictures (GOP).

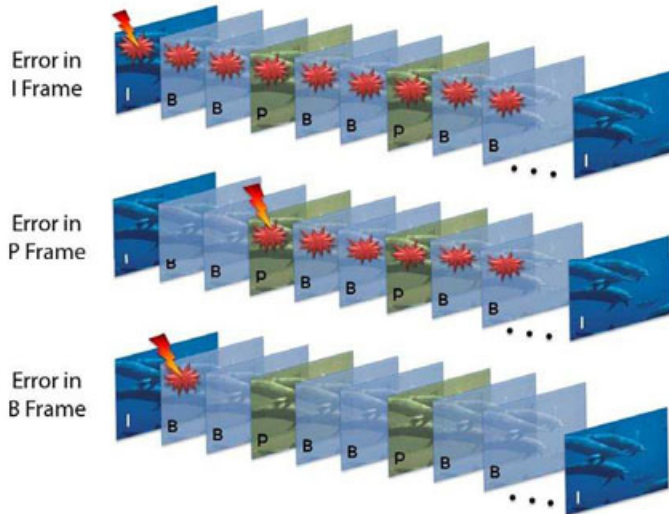

**Error propagation through frames in a typical GOP**

In most cases, the standards for video coding provide considerable flexibility to both the encoder and decoder, allowing a range of cost/performance tradeoffs to be made. This can make it difficult to precisely assess the impact of network impairments without knowledge of the exact implementation.

➤ Impact of Packet Loss on Specific Video Codecs

As shown in the following figure, a simple non-robust video stream can be severely degraded with even low levels of packet loss due to the error propagation effects described above. Peak Signal-to-Noise Ratio (PSNR) is an objective measurement of video service quality comparing the maximum power of the video signal to the power of corrupting noise affecting the signal. Generally, a PSNR of under 20dB is regarded as unwatchable, and this level is reached for MPEG video with a loss rate under 1 percent.

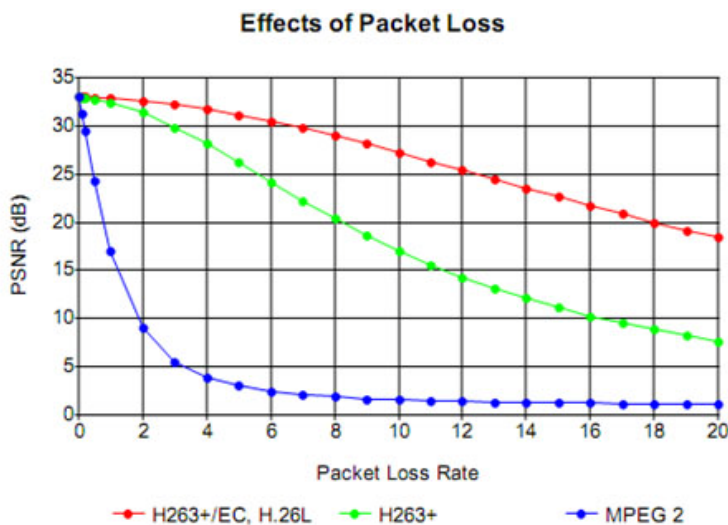

**Estimated PSNR for Three Common Codecs**

Error mitigation algorithms are being increasingly applied to help to compensate for packet loss. Methods include:

Forward Error Correction (FEC) - redundancy is applied to the data stream to allow some proportion of lost or errored packets to be replaced.

Interleaving - in which the video stream is split into alternate frames and each encoded separately.

Macro-block error concealment - spatially corresponding macro-blocks are copied from the previous frame.

These approaches can help considerably with tolerance to packet loss.

➤ **Playout Buffer Configuration**

It is assumed that both videoconferencing and streaming video systems provide a playout buffer; however, the configuration of these is quite different. It is highly desirable to determine whether an application is streaming or interactive, since the playout buffer configuration is typically very different for these two applications.

Following are examples for the playout buffer settings:

Videoconferencing - nominal 100ms (0.1 seconds), adaptive

Streaming Video - nominal 3,000ms (3 seconds), fixed

➤ **Encoding/Decoding Impairments**

While transmission impairments such as packet loss are a common source of video quality degradation, quality can also be affected by the encoding/decoding process itself; i.e., some distortion can be introduced by the bitrate and codec used.

➤ **Impact of Coding Bitrate on Video Quality**

For a typical MPEG-2 encoded video stream with standard resolution 720x486, GOP sequence IBBPBBPBBPBBPBB, at 30 frames per second, the mean square error (MSE) due to bitrate can be approximated by:

$$\text{MSE}_{br} = 0.00001 + 1.5 / (B + B^2 / 30000).$$

Where B is the bit rate in kilobits per second. The corresponding peak signal-to-noise ratio (PSNR) value for the frame can be computed by:

$$\text{PSNR}_{br} = -10 \log_{10} \text{MSE}_{br}$$

The following figure shows the estimated PSNR value on coding bit rate for MPEG-2 encoded video.

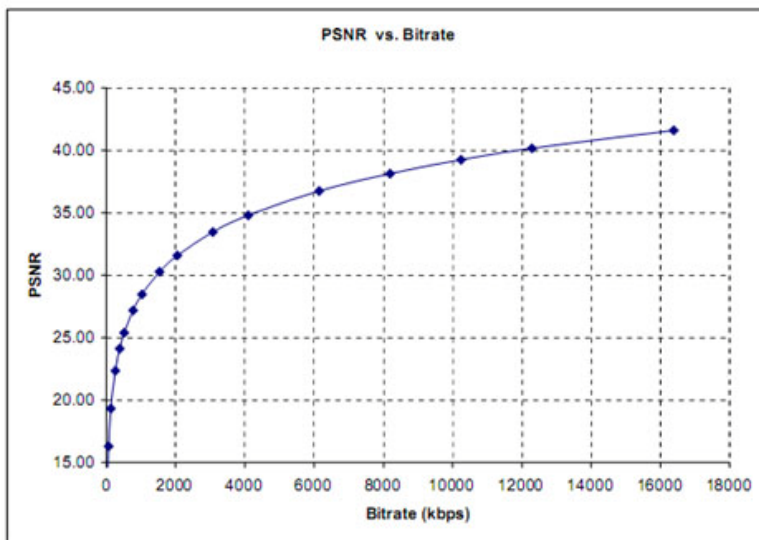

**Estimated PSNR on Coding Bitrate for Standard Definition MPEG-2 Video at 30 Frames per Second**

## Glossary

### *IPTV*

---

The following examples illustrate the impact of the coding bit rate on video quality. Both images show the same frame from a video sequence encoded with MPEG-2 at a resolution of 720x480, at 30 frames per second.

In the following figure the sequence was encoded at a bit rate of 5000 Kbps (610KB/s).



Still frame from  
MPEG-2 video  
sequence  
encoded at  
5000Kbit/s

In following figure, the sequence was encoded at a bitrate of 1127Kbps (138KB/s). The use of coarser quantization conserves bandwidth, but creates distortion that impairs overall image quality throughout the entire video sequence.

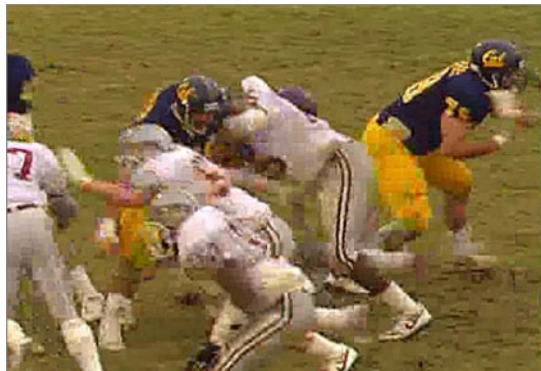

Still frame from  
MPEG-2 video  
sequence encoded  
at 1127Kbit/s



► Performance of Video Coders

There are many standardized video coding algorithms, such as ITU-T H.261, H.263, H.264, ISO/IEC MPEG-1, MPEG-2 and MPEG-4, AVS, VC-1, etc. These standards do not explicitly define codecs; they only define the syntax of an encoded video bitstream together with the methods of decoding the bitstream. The consequence is that there might be significant quality differences between codecs conforming to the same standard. The Windows Media 9 (VC-1) of Microsoft and RealVideo of RealNetworks are widely used proprietary video coding algorithms for video streaming applications.

As a rule of thumb, ITU-T H.263 reduces the coding bitrate by about 50% against H.261 for comparable video quality. ITU-T H.264/AVC significantly outperforms all other listed standards. Average bit-savings of more than 60% relative to MPEG-2 are reported. H.264/AVC Main Profile provides more than 1/3 bitrate saving relative to its competitors, MPEG-4 Advanced Simple Profile (ASP) and H.263 Conversational High Compression (CHC) Profiles.

Reports show that WMV 9 (VC-1) achieved similar quality to MPEG-2 and MPEG-4 with only 1/3

and 1/2 of the bitrate, respectively. A paper by Bennet and Bock concludes that comparing H.264/AVC and VC-1, there is very little performance difference between them.

➤ Effective Coding Bitrate

The bitrate used in estimating the mean squared error as referenced in *Video Stream Analysis* on page 79 can be adjusted to an effective bitrate based on performance of a video codec described above. The effective bitrate also needs to be adjusted based on the frame resolution and frame rate of the video signal. Videoconferencing applications generally support low to medium bitrates and frame resolution. The most commonly used resolutions are QCIF (176x144) and CIF (352x288) at 10 to 30 frames per second. Entertainment-quality IPTV applications generally support video encoded with SD resolutions of 720x486 (30 Hz) or 720x576 (25 Hz), or HD resolutions of 1280x720 (720p) or 1920x1080 (1080i) at an average bitrate of 3 Mbits/sec or higher.

Typically, the number of bits spent on coding a P-frame is about 20% of the number required for an I-frame, whereas a B-frame takes about 5% of the bitrate consumption of the I-frame. This implies that group of pictures (GOP) structure has a big impact on quality of encoded video at a given bitrate under no loss condition, as well as under loss conditions as described below. VQmon/HD automatically adjusts the video stream effective bitrate based on the GOP structure of the encoded video stream.

➤ **Impact of Subjective Factors on Perceptual Quality**

The degree to which viewers find video impairments annoying-or notice them at all- depends in part on the severity and duration of the impairment events, but also on certain inherent characteristics of human perception. The same type of impairment may be extremely irritating or barely noticed, depending on factors such as the scene content when the error takes place, and whether it occurs alone or simultaneously with other impairments.

➤ **Video Content**

The visibility of video problems depends partially on the scene content; for example, frame freezes tend to be much more noticeable in sequences containing high levels of motion than in relatively static scenes, such as footage of a television news anchor. VQmon/HD performs content and scene analysis, detecting levels of detail, motion, and panning, and can detect and provide alerts for content problems such as noise/snow and frame freezes. Scene analysis data is leveraged to increase the accuracy of VQmon/HD's estimated perceptual quality scores.

► **Temporal Phenomena: Reaction Time, Masking and Recency Effects**

Perceptual quality is affected somewhat by a natural delay in human reaction time when impairments occur, or when quality improves after a period of degradation; i.e., the viewer's reaction to either event is not immediate. As with audio, when two or more impairments occur simultaneously (or in rapid succession), there can be a "masking" effect that affects the way viewers perceive the severity of quality degradation. In addition, a "recency" phenomenon exists, wherein viewers tend to perceive impairments as more severe when they occurred recently, but are willing to "forgive" them to some extent as time passes.

VQmon/HD's quality analysis algorithm considers these temporal phenomena in order to calculate perceptual quality scores that correlate as accurately as possible to scores obtained from subjective tests of live viewers.

## VQmon/HD Quality Analysis Algorithm<sup>1</sup>

This section describes VQmon/HD's video and audio quality analysis algorithms and lists some of the key metrics reported by VQmon/HD as part of the Telchemy Video Quality Metrics (TVQM) data set.

► Video Stream Analysis

VQmon/HD's video quality analysis algorithm analyzes RTP or MPEG-2 Transport video streams and generates real-time perceptual quality scores and other diagnostic metrics.

Video codecs supported by VQmon/HD include:

- Motion JPEG
- MPEG-1
- MPEG-2
- H.261
- H.263/263+
- H.264
- MPEG-4
- VC-1

---

1. The following information is proprietary to Telchemy, Incorporated and was published with its permission.

## Glossary

### IPTV

The following figure depicts the various components of the VQmon/HD video stream quality analysis algorithm and the metrics produced by each component.

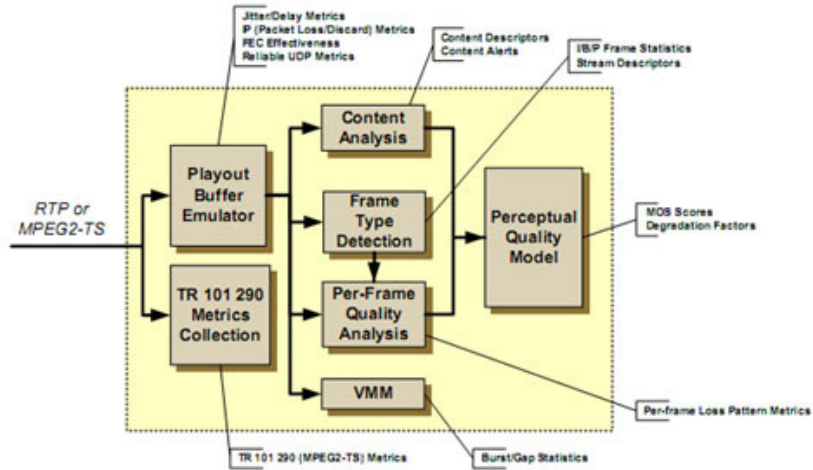

#### ➤ TR 101 290 Metrics Collection

VQmon/HD collects and reports the full set of Priority 1 and 2 metrics described in TR 101 290 for the measurement and analysis of MPEG-2 Transport streams.

#### ➤ Playout Buffer Emulator

VQmon/HD's playout buffer emulator component detects lost, duplicate, and out-of-sequence packets and measures packet-to-packet delay (jitter) levels, reporting PPDV (RFC3550) and MAPDV (ITU-T G.1020). Detailed IPTV packet loss/discard statistics are provided, along with metrics evaluating the effectiveness of Forward Error Correction (FEC), if used. If Reliable UDP is in use, VQmon/HD reports the proportion of retransmitted packets and the impact on bandwidth due to retransmission.

➤ Content Analysis

VQmon/HD performs high-level content analysis to detect levels of detail, motion, and panning, and can also detect some scene changes. VQmon/HD also recognizes abnormal content conditions (including no content, noise/snow, and frozen image) and can generate alerts if they are detected.

➤ Frame Type Detection

VQmon/HD identifies individual I, P, and B frames in the GoP and measures the packet loss rate and loss distribution occurring in each frame type. For unencrypted video streams, VQmon/HD performs picture header decoding to identify individual frames, GoP size, and frame rate. For encrypted/scrambled streams, heuristic algorithms are applied in order to detect frame boundaries and measure frame size.

As mentioned in *Impact of Packet Loss and Jitter on Video Quality* on page 69, the GoP structure has impact on both the efficiency of video encoding and the robustness of encoded video. VQmon/HD takes the different I, P, and B frame packet loss/discard rates into account when calculating perceptual video quality metrics.

➤ Per-frame Quality Analysis

VQmon/HD performs per-frame quality calculation using the frame type, frame size, codec type, video bandwidth, and packet loss data. The proportion of each frame type impaired by loss/discard is reported, along with the proportion of B and P frames impaired due to the propagation of errors from earlier reference (I or P) frames in the GoP.

➤ Perceptual Quality Model

VQmon/HD's perceptual quality model calculates estimated perceptual quality (MOS) scores using the per-frame quality metrics and content analysis as inputs. The calculation model considers the sensitivity of the content to quality degradation (e.g., that frame freezes occurring during a high-motion scene will be more visible and annoying than those occurring during a static scene) and other subjective factors such as viewer reaction time, recency, and temporal masking (see *Temporal Phenomena* on page 78).

➤ VQmon Markov Model (VMM)

VQmon/HD uses a four-state Markov Model to gather and report packet loss statistics for "burst" periods (where quality is significantly degraded) and "gap" periods (periods between each burst interval when quality is relatively unimpaired).

VQmon/HD calculates quality metrics in these burst and gap states, and then combines them to generate the overall quality score on user experience. These calculations are based on the results of numerous subjective voice/video quality analysis tests that indicate there is not an instantaneous change in perceived quality when a transition between the gap and burst states occurs, but rather that the perceived quality exponentially "decays" from one level to another. For example, a 100-millisecond burst of "noise" is much less annoying than a 10 second burst of "noise".



The following figure illustrates the VQmon 4-state Markov model.

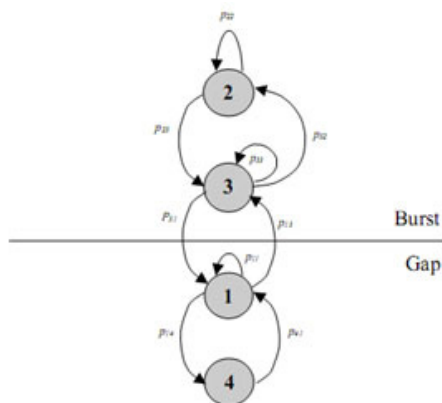

The VQmon 4-state Markov model is defined as having the following states and associated transitions:

State Name	Description	Transitions
State 1 – Gap/no loss	Occurs when packets are being received properly under normal operating conditions	$p_{11}$ – packet received $p_{13}$ – packet lost (start of burst) $p_{14}$ – isolated packet lost
State 2 – Burst/no loss	Occurs when a packet is successfully received while in a burst loss state	$p_{22}$ – packet received within burst $p_{23}$ – packet lost within burst
State 3 – Burst/packet lost	Occurs when a packet is lost during a burst loss condition	$p_{31}$ – packet received (end of burst) $p_{32}$ – packet received within burst $p_{33}$ – packet lost
State 4 – Gap/packet lost	Occurs when a packet is lost during a gap state	$p_{41}$ – packet received

➤ **Audio Stream Analysis**

VQmon/HD's audio quality analysis algorithm performs real-time analysis of audio stream packets and generates perceptual quality scores (MOS-A) and other metrics corresponding to those produced by the video quality analysis algorithm. Like the video stream analysis algorithm, the audio quality analysis algorithm calculates the impact of time-varying impairments (i.e., burst packet loss and jitter) and recency on perceptual quality.

VQmon/HD calculates overall multimedia quality (MOS-AV) by measuring both audio and video perceptual quality and the accuracy of the audio-video synchronization.

High-fidelity audio codecs supported by VQmon/HD include:

- MPEG-1 Layer 1, 2, and 3
- MPEG-2 Advanced Audio Coding (AAC)
- AC-3
- MPEG-4 AAC, Low Delay AAC, and High Efficiency AAC

➤ **Telchemy Video Quality Metrics**

VQmon/HD provides real-time perceptual quality scores, performance statistics, and extensive diagnostic data for monitored video streams in the form of the TVQM™ (Telchemy Video Quality Metrics) data set.

TVQM metrics reported by VQmon/HD fall into three main categories:

- **Perceptual Quality Metrics** - including Mean Opinion Scores (MOS) for picture quality (MOS-V), audio quality (MOS-A), and combined audio-video quality (MOSAV), expressed in a range of 1 to 5, with 5 being best. For picture quality, both "Relative" MOS (which does not consider the resolution of the display, frame rate, or progressive vs. interlaced scanning) and "Absolute" MOS (which includes consideration of these factors) are reported.

TVQM perceptual quality metrics also include an Estimated Peak Signal-to-Noise Ratio (ESPR) in dB, and a set of metrics indicating the severity level (on scale of 010) of several degradation factors including packet loss, jitter, codec type, etc.

- Video Stream Metrics - including video stream description (image size, codec type, frame rate, etc.); content and scene analysis (detail and motion level) metrics; frame statistics indicating the number and proportion of each frame type (I, B, P, SI, and SP) received/impaired/lost/discarded; average and maximum bandwidth for each frame type and for the stream overall; video stream jitter and delay metrics; and interval metrics.
- Transport Metrics -including VSTQ (Video Service Transmission Quality), a 0-50 codec-independent score that measures the ability of the IPTV network to carry reliable video; packet transport metrics (packets received/discarded/duplicate/out-of-sequence, along with burst and gap statistics); packet jitter metrics including PPDV (Packet-to-Packet Delay Variation); FEC (Forward Error Correction) and Reliable UDP metrics; and MPEG-2 Transport Stream (ETSI TR 101 290) metrics.

## Glossary

### IPTV

---

The following table lists some of the perceptual quality metrics reported by VQmon/HD, including acceptable ranges for each.

Abbr. Name	Permitted Range	VQmon Scaled Range	Meaning
MOS-AV	1 .. 5	1 .. 5	VQmon Multimedia Quality. A VQmon Mean Opinion Score representing video service multimedia quality. It takes video picture quality, audio quality and audio/video synchronization into account to generate the overall multimedia quality.
VSTQ	0 .. 50.0	0 .. 100	VQmon Video Service Transmission Quality as defined in [14]. This is a codec-independent measure related to the ability of the bearer channel to support reliable video.
EPSNR	0 .. 60 dB	0 .. 60 dB	VQmon/HD Estimated Peak Signal to Noise Ratio. A measurement of the quality of a video signal. This corresponding to the maximum possible signal energy versus the energy of the noise.

➤ Mean Opinion Scores (MOS)

VQmon/HD reports estimated Mean Opinion Scores (MOS) for picture quality (MOS-V), audio quality (MOS-A), and multimedia quality (MOS-AV) for each monitored video stream. MOS scores range from 1 to 5, with 1 considered "Unacceptable" and 5 "Excellent." MOS scores are reported as instantaneous (per-frame), minimum, maximum, and average values. Interval MOS scores are also reported as instantaneous and average values.

For picture quality, VQmon/HD reports both Relative MOS-V and Absolute MOS-V scores:

- Relative MOS-V is an estimated perceptual quality score that considers the effects of codec/quantization level, the impact of IPTV impairments (e.g., packet loss) on the GoP structure and video content, and the effectiveness of loss concealment methods-but does not consider the image size/resolution, frame rate, or scanning method (interlaced vs. progressive).

- Absolute MOS-V is an estimated perceptual quality score that considers all the above mentioned factors as well as image resolution, frame rate, and the use of progressive vs. interlaced scanning.

Some video formats offer inherently higher perceptual quality than others—for example, in unimpaired conditions, the quality of an HD broadcast will be higher than that of SD; 1080p better than 1080i or 720p; 60 frames per second better than 30 fps, etc. VQmon/HD's Absolute MOS-V score takes these factors into consideration, and thus provides an accurate estimate of "overall" perceptual quality.

Because it is independent of image resolution/frame rate, the Relative MOS-V score helps provide an indication of video quality relative to the ideal for a given video format.

Example: An IPTV service provider offers 480i SD, 720p HD, and 1080p HD broadcasts.

Assuming unimpaired conditions, the services might receive the following scores (values provided for example only):

Absolute MOS-V: 480i = 4.0 720p = 4.3 1080p = 4.7

Relative MOS-V: 480i = 4.5 720p = 4.5 1080p = 4.5

Relative MOS-V can be used to simplify alert thresholding in cases where multiple video formats are in use.

➤ VQmon/HD Video Service Transmission Quality Metric - VSTQ

VQmon/HD produces a video services quality metric, VSTQ (Video Service Transmission Quality), which is a codec-independent measure of the ability of the bearer channel to support reliable video. This video service quality metric is expressed in the range of 0.0 to 50.0, as defined in.

VSTQ can be calculated by a mapping function from Peak Signal-to-Noise Ratio PSNR values as follows:

$$\text{VSTQ} = \max(0, \min(50, (\text{PSNR} - 12) * 1.8))$$

Of course, VQmon/HD uses a more sophisticated algorithm to calculate the resulting VSTQ score, which takes time-varying distributions of network impairments and recency into account.

Note: The VSTQ score that VQmon/HD's API function produces actually ranges from 0 to 100. This value is scaled by 2 to get half-point accuracy for the score.

➤ Degradation Factors

To facilitate troubleshooting, VQmon/HD has the ability to obtain a breakdown of factors contributing to quality degradation.

VQmon/HD reports the severity of quality degradation (on a scale of 0-10, with 0 indicating no degradation and 10 indicating the most severe level of degradation) attributable to each of the following factors:

- Packet loss
- Audio-video sync
- Codec quantization
- GOP length
- Codec bandwidth restriction
- Frame resolution
- Packet discards due to jitter
- Frame rate
- (One-way) delay
- Recency

## IPTV Protocols

- IPTV uses a multilayer protocol stack to deliver the media contents.
- The first 3 layers are typical for IPTV transmission.
- The UDP/RTP session layer is responsible for transferring packets between the sender and the receiver.
- The MPEG-TS transport stream layer combines multiple media streams ( video, audio, data) into a single program transport stream.
- The PES layer assigns video and audio to specific packet streams.
- The application layer performs encoding and decoding of the video and audio using MPEG-2, MPEG-4, VC-1, or other formats.

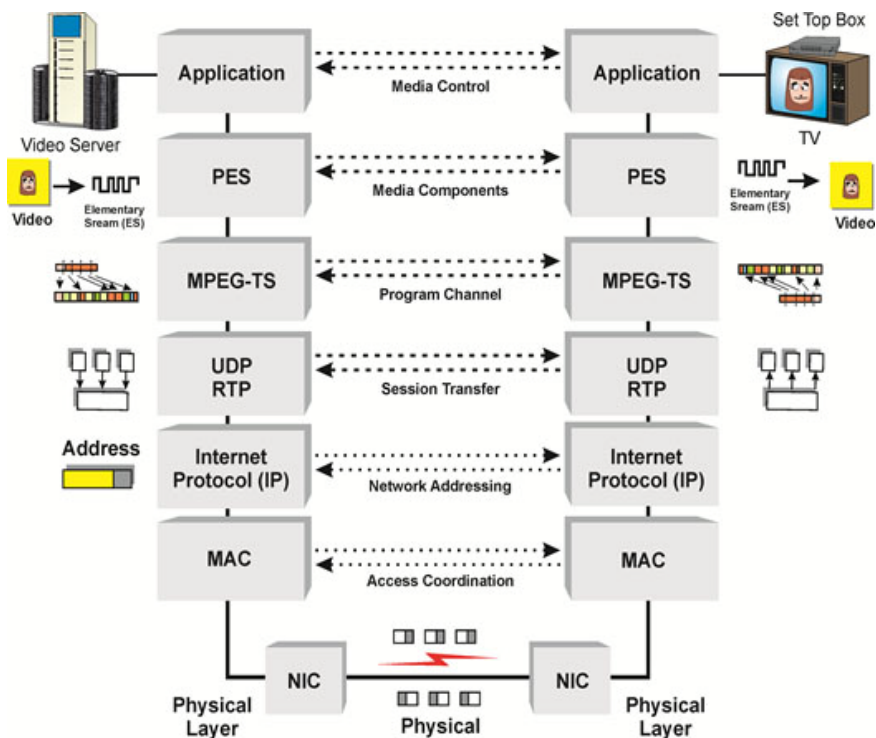

## Glossary

### IPTV

MPEG frame is fixed at 188 byte, with 184 Data Payload and 4 Byte Header. The 13-bit PID identifies Packet Elementary Stream (PES).

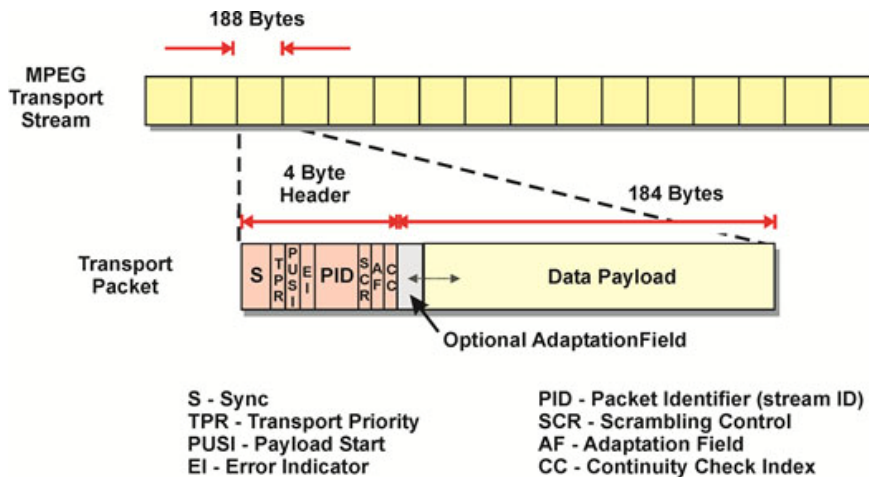

The PES is much longer than the MPEG frame so it is divided into segments over multiple MPEG frames.

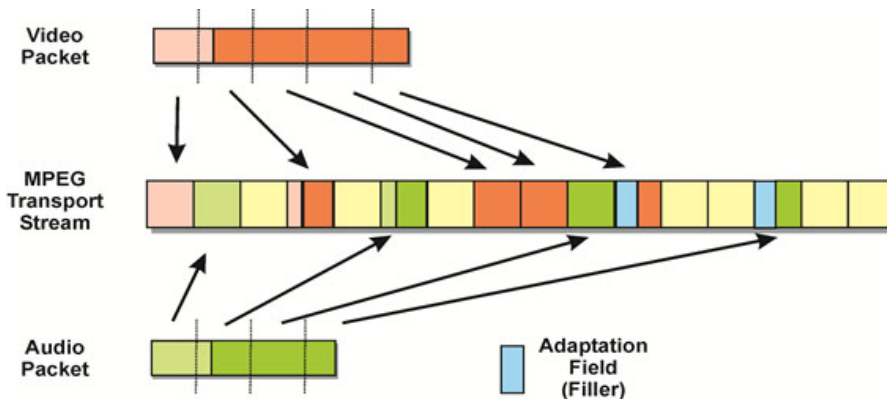



The Packetized Elementary Stream is converted into the Video Elementary Stream ( MPEG-2 transport stream)

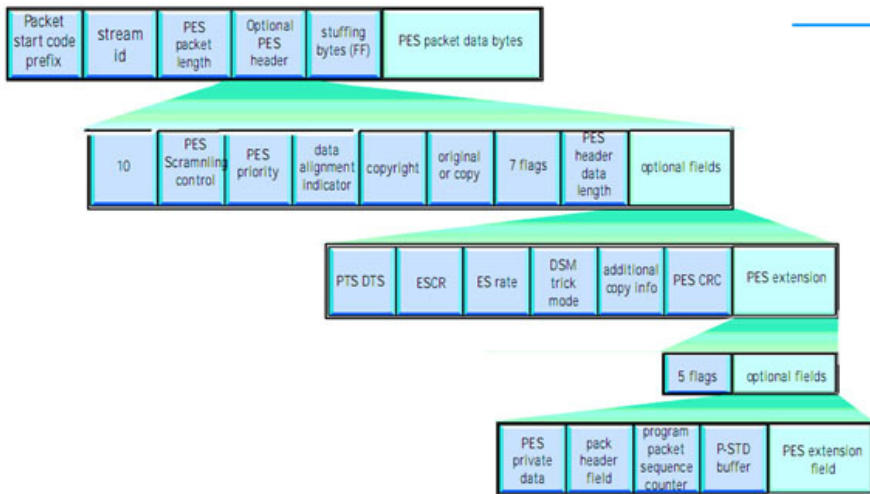
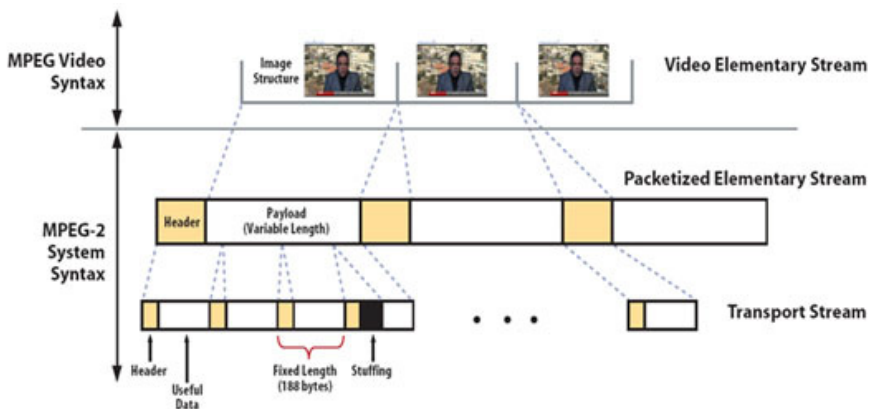

## Glossary

### IPTV

---

- PES header contain information about the contents of the PES packet.
- Variable length packets typically up to 64 Kbyte but may be longer
- PTS and DTS allow a decoder to reconstruct the video from I, Band P frames sent by encoder.
- If header information is corrupted, entire PES packet will be lost.
- Fixed Length packets, multiplexes many PES packets.
- Program Identifier (PID) contains information to find, identify and reconstruct program contents
- Continuity Counter (CC) - 4 bit counter to detect loss or out of sequence packets
- Program Clock Reference (PCR) - clock reference to time sync the video and audio
- Sync byte set the start of a TS packet and allows synchronization
- Transport Error Indicator indicates a TS packet error

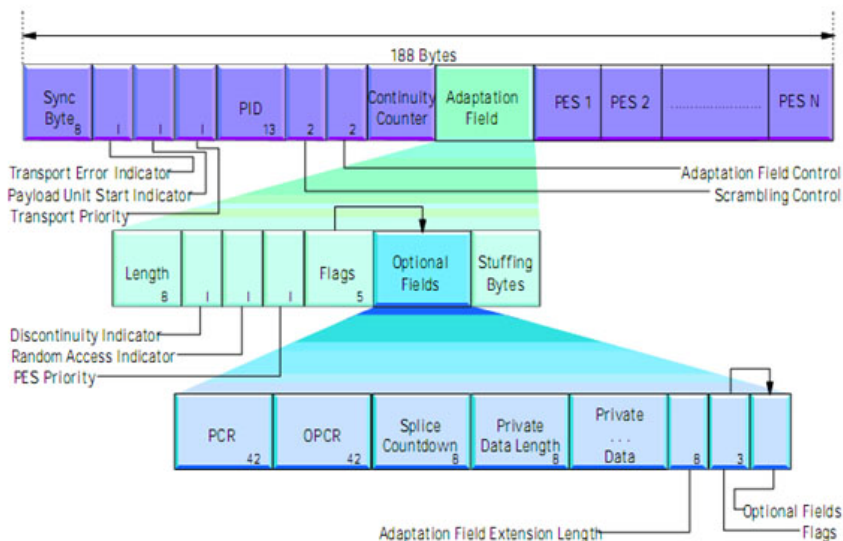

- PAT lists all programs available in the transport stream with their program ID (PID).
- Each program has a PMT that lists the elementary streams for that program.
- Errors in PMT, PAT, PID/PSI (Packet Identifier/ Program Specific Information) Errors will cause the set top box lose contact with the stream. These errors may originate at any of the MPEG transport multiplexers when new streams are inserted.

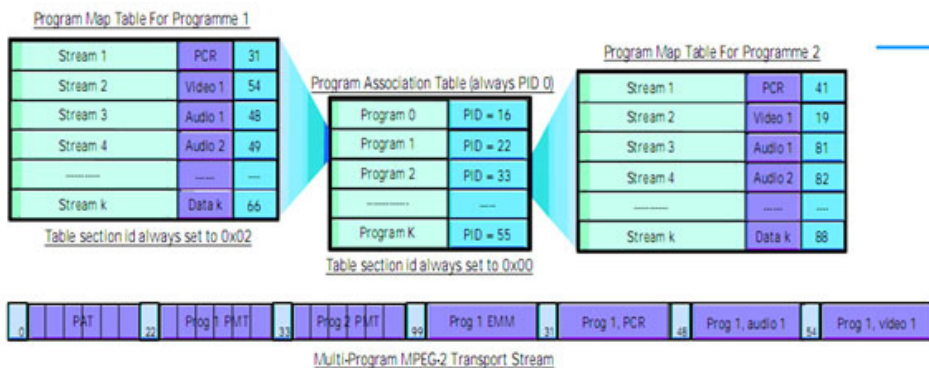

## PCR Jitter

PCR (program counter reference) timestamps is generated by the MPEG-2 encoder and received throughout the subsequent links in the network at least 100 milliseconds apart. The decoder uses the PCR to lock its own 27 MHz clock to the encoder system time clock (STC). This 27MHz clock is very sensitive to variations caused primarily by packet transmissions delays. Therefore, measurement of the PCR timestamp arrival time variation called commonly "PCR jitter" is essential. The 27 MHz oscillator itself may not exceed 500nsec of internal jitter per TR 101290.

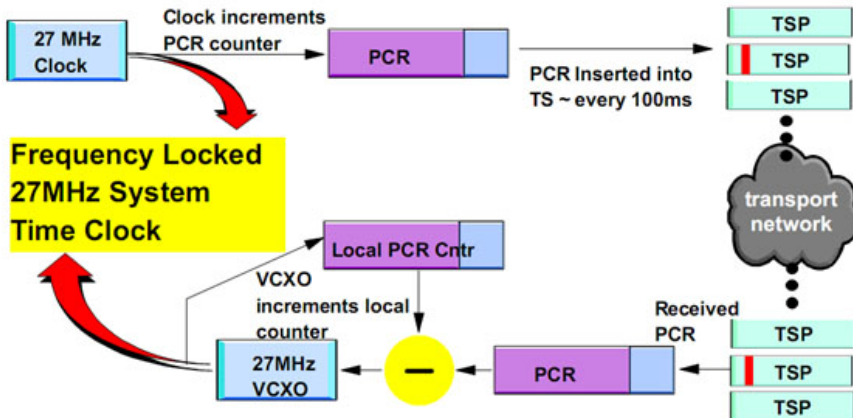

## IGMP Latency vs. Zap time

The zap time is the total duration from the time viewer presses the channel change button, to the point the picture of the new channel is displayed, along with corresponding audio. These kind of delays exist in all [television](#) systems, but they are greater in [digital television](#) and systems that use the [Internet](#) like [IPTV](#). Human interaction with the system is completely ignored in these measurements, so zap time is not the same as [channel surfing](#).

Key Factors affecting Zap Time

- Encoding
- Network
- Set top Box (leave and joins)

Examples:

In this section some typical values of zap time are shown. Actually, in IPTV television these delays are greater than in other technologies:

- Analog ([Cable](#)) ~ 1s
- Analog ([off-air](#)) ~ 1 - 3s
- MPEG2 over [QAM](#) ~ 1.2 - 3s
- MPEG2 over [QPSK](#) ~ 2 - 4s
- MPEG2 over IPTV Multicast ~ 1.5 - 3.5s
- H.264 over IPTV Multicast ~ 1.7 - 4s

## Glossary

### *IPTV*

---

	Channel Change Latency Factor	Device/Location	Typical Latency	Cumulative Latency
1	Send IGMP Leave for channel X	STB	< 10 ms	
2	Send IGMP Join for channel Y	STB	< 10 ms	
3	DSLAM gets Leave for channel X	DSLAM/Network	< 10 ms	
4	DSLAM gets Join for channel Y	DSLAM/Network	< 10 ms	~ 20 - 40 ms
5	DSLAM stops channel X, and sends Channel Y	DSLAM/Network	~ 30 – 50 ms	~ 50 – 90 ms
6	DSL Latency (FEC/Interleave)	DSLAM/Network	~ 10 ms	~ 60 - 100 ms
7	Core/Agg Network Latency	Router/Network	~ 20 – 60ms	~ 80 – 160ms
8	De-jitter buffer	STB	~ 300 ms	~ 380 - 460 ms
9	Wait for PAT/PMT	STB MPEG buffer	~ 125 ms	~ 500 - 580 ms
10	Wait for ECM/CA	STB MPEG buffer	~ 125 ms	~ 620 - 700 ms
11	Wait for I-frame	STB MPEG buffer	~ 250 ms to 2s	~ 870 ms – 2.7s
12	MPEG buffer	STB MPEG buffer	~ 1s to 2s	~ 1.8s – 4.7s
13	Decode	STB	~ 50ms	~ 1.9s – 4.8s

IGMP is the signaling protocol used to access broadcast video services that use a multicast network design to efficiently manage network bandwidth. In this implementation, a join message is sent from the STB to the network.

The join message asks the network to send the requested program or channel to the STB by joining a multicast group carrying the desired broadcast channel.

IGMP latency, then, is the time between when the join message is sent and the first video packet is received by the STB.

This parameter measures network performance, but not the end user's experience with regard to channel changing time.

The IGMP latency plus the time it takes to fill the decode buffer and to decode and display the content is the total user experience time. However, the buffer fill time and the decode time are functions of the network architecture and are not variables. This total time is called Zap Time.





# Index

<b>A</b>	
About .....	6
Acronym List .....	57
Active .....	23
Active stream count .....	23
Add Channel .....	19
after-sales service .....	49
Audio Bandwidth Metrics .....	37
Audio Description Information .....	36
Audio On/Off .....	26
Audio Perceptual Quality Metrics .....	37
Audio tab .....	36
Average Audio/Video MOS .....	16
<b>C</b>	
caution	
of personal hazard .....	2
of product hazard .....	2
Channels Group .....	18
Channels List .....	18
Charts tab .....	42
Clear Terminated .....	23
Connect .....	18
Connecting/Aborted .....	23
conventions, safety .....	2
<b>D</b>	
Default Gateway .....	14, 15
Delete Channel .....	19
Delete Group .....	18
DHCP .....	14
DHCP Client .....	14
DNS .....	14, 15
Downstream Rate .....	22
<b>E</b>	
Ethernet Interface .....	6, 22
Exit .....	6
Export all Groups .....	19
<b>F</b>	
Failed .....	16, 23
FTB-1 .....	1, 3
FTB-1v2 Pro .....	1, 3
FTB-2 .....	1, 3
FTB-2 Pro .....	1, 3
FTB-4 Pro .....	1, 3
Full size screen .....	26
<b>G</b>	
Generate Reports .....	45
<b>H</b>	
Help .....	6
<b>I</b>	
identification label .....	49
IGMP Latency .....	16, 27
IGMP Latency vs. Zap time .....	95
IGMP Version Change .....	14
Import all Groups .....	19
Interface .....	6, 14
Interface Status .....	22
IP Address .....	14, 15, 22
IPTV .....	66
IPTV Protocols .....	89
IPTV Video Stream .....	66
<b>J</b>	
Jitter Metrics .....	32
<b>K</b>	
Keyboard usage .....	7

# Index

---

<b>L</b>	
label, identification .....	49
Laser Safety Information .....	3
license agreement .....	iii
Live Stream Preview .....	26
<b>M</b>	
MAC Address .....	14
MAC Address Clone .....	14
Manage Channels Lists .....	18
Max PCR Jitter .....	16
Measurements .....	44
Metrics .....	61
MOS Score .....	27
MPEG2-TS TR101290 Priority 1 .....	34
MPEG2-TS TR101290 Priority 2 .....	35
Multicast address .....	19
Multicast Channel .....	18
<b>N</b>	
Name .....	19
Netmask .....	14, 15
New Group .....	18
Number .....	19
Number of failed tests .....	23
Number of passed tests .....	23
Number of tests with warning .....	23
<b>O</b>	
Operational status .....	14
<b>P</b>	
Packets .....	38
Packets tab .....	31
Passed .....	16, 23
Passive Test .....	9
PCR Jitter .....	27, 94
Perceptual Quality Metrics .....	61
Play .....	18
product identification label .....	49
<b>R</b>	
Remove Selected .....	44
Results .....	6
RTP Packet Metrics .....	33
RTSP URI .....	19
<b>S</b>	
safety caution .....	2
conventions .....	2
warning .....	2
Search Filter .....	43
Select Interface .....	6, 7
Set Top Box .....	6
Set Top Box Emulation Test .....	11
Setup .....	6
Show All .....	23
Signal Connection .....	3
Specifications .....	51
Start/Stop button .....	7
Start/Stop video preview .....	26
Startint EXpert IPTV Test Tools .....	3
Static IP Address .....	15
STB Channels .....	18
Stream .....	23
Summary .....	27
Summary tab .....	24
symbols, safety .....	2
<b>T</b>	
technical support .....	49
Terminated .....	23
Terminated streams count .....	23
Test Log .....	6, 23
Test Results .....	43
Thresholds .....	6, 16
TR 101290 .....	27

---

TR101290 .....	17
TR101290 tab.....	34
Transport Metrics .....	64
troubleshooting .....	49

## U

Understanding IPTV Video Perceptual Quality .	
67	
Upstream Rate.....	22
User Class Information .....	14
User's Manual .....	6

## V

Vendor Class ID .....	14
Verdict .....	27
Video Bandwidth.....	40
Video Description Information .....	25
Video Frame.....	38
Video Frame Metrics.....	38
Video Frames tab .....	38
Video Jitter Metrics .....	30
Video Packet Loss.....	27
Video Packet Loss Ratio.....	16
Video Perceptual Quality .....	29
Video Scene Analysis Metrics.....	30
Video Stream Metrics .....	62
Video tab .....	28
Video Transport Packets Metrics.....	31
VoD Streams .....	18
VQmon/HD Quality Analysis Algorithm .....	79

## W

Warned .....	16, 23
warranty.....	iii

P/N:1071426

[www.EXFO.com](http://www.EXFO.com) · [info@exfo.com](mailto:info@exfo.com)

<b>CORPORATE HEADQUARTERS</b>	400 Godin Avenue	Quebec (Quebec) G1M 2K2 CANADA Tel.: 1 418 683-0211 · Fax: 1 418 683-2170
<b>EXFO AMERICA</b>	3400 Waterview Parkway Suite 100	Richardson, TX 75080 USA Tel.: 1 972-761-9271 · Fax: 1 972-761-9067
<b>EXFO EUROPE</b>	Winchester House, School Lane	Chandlers Ford, Hampshire S053 4DG ENGLAND Tel.: +44 2380 246 800 · Fax: +44 2380 246 801
<b>EXFO ASIA-PACIFIC</b>	62 Ubi Road 1, #09-01/02 Oxley Bizhub 2	SINGAPORE 408734 Tel.: +65 6333 8241 · Fax: +65 6333 8242
<b>EXFO CHINA</b>	Beijing Global Trade Center, Tower C, Room 1207, 36 North Third Ring Road East, Dongcheng District	Beijing 100013 P. R. CHINA Tel.: +86 (10) 5825 7755 · Fax: +86 (10) 5825 7722
<b>EXFO SERVICE ASSURANCE</b>	270 Billerica Road	Chelmsford MA, 01824 USA Tel.: 1 978 367-5600 · Fax: 1 978 367-5700
<b>EXFO FINLAND</b>	Elektroniikkatie 2	FI-90590 Oulu, FINLAND Tel.: +358 (0) 403 010 300 · Fax: +358 (0) 8 564 5203
<b>TOLL-FREE</b>	(USA and Canada)	1 800 663-3936

© 2017 EXFO Inc. All rights reserved.  
Printed in Canada (2017-03)

