

FOT-930

Multifunction Loss Tester



Copyright © 2004–2013 EXFO Inc. All rights reserved. No part of this publication may be reproduced, stored in a retrieval system or transmitted in any form, be it electronically, mechanically, or by any other means such as photocopying, recording or otherwise, without the prior written permission of EXFO Inc. (EXFO).

Information provided by EXFO is believed to be accurate and reliable. However, no responsibility is assumed by EXFO for its use nor for any infringements of patents or other rights of third parties that may result from its use. No license is granted by implication or otherwise under any patent rights of EXFO.

EXFO's Commerce And Government Entities (CAGE) code under the North Atlantic Treaty Organization (NATO) is 0L8C3.

The information contained in this publication is subject to change without notice.

Trademarks

EXFO's trademarks have been identified as such. However, the presence or absence of such identification does not affect the legal status of any trademark.

Units of Measurement

Units of measurement in this publication conform to SI standards and practices.

Version number: 8.0.0

Contents

Certification Information	vi
1 Introducing the FOT-930 Multifunction Loss Tester	1
Main Features	1
Power Sources	4
Typical Applications	4
Conventions	5
2 Safety Information	7
Other Safety Symbols on Your Unit	8
Laser Safety Information (Units without VFL)	9
Laser Safety Information (Units with VFL)	9
Electrical Safety Information	10
3 Getting Started with Your Multifunction Loss Tester	13
Turning the Unit On and Off	13
Using Menus and Keypad	14
4 Customizing Your Multifunction Loss Tester	17
Selecting the Language of Operation	17
Setting the Date and Time	18
Adjusting the Brightness and Contrast	19
Activating and Setting Screen Saver and Auto-Off	20
5 Setting Up Your Multifunction Loss Tester	21
Installing the EXFO Universal Interface (EUI)	21
Cleaning and Connecting Optical Fibers	22
Setting Autonoming Scheme	24
Setting Pass/Fail Thresholds	26
6 Measuring Power or Loss	29
Defining the List of Favorite Wavelengths	30
Nulling Electrical Offsets	32
Referencing Your Power Meter to a Source	33
Measuring Power or Loss	36
Automatically Detecting Wavelength	39
7 Measuring Optical Return Loss	41
Performing ORL Reference and Setting ORL Zero Value	42
Performing and Saving ORL Measurements	43

Contents

8 Performing Automated IL/ORL/Length Measurements (FASTEST)	47
Setting Up the <i>FASTEST</i>	48
Referencing Units for <i>FASTEST</i>	49
Performing the <i>FASTEST</i>	52
9 Managing Test Results	55
Viewing and Deleting Results	55
Checking Available Memory	56
Transferring Test Results to a Computer	56
10 Using a Light Source	59
11 Identifying Fiber Faults Visually	61
12 Inspecting Fibers with the FIP	63
13 Communicating with Other Users	65
Sending and Receiving Text Messages	65
Communicating by Voice	68
14 Maintenance	71
Cleaning EUI Connectors	71
Cleaning Detector Ports	74
Cleaning VFL-Type Connectors	75
Recharging Main Batteries	76
Replacing Batteries	77
Battery Safety Information	78
Recalibrating the Unit	79
Upgrading the Embedded Software	80
Recycling and Disposal (Applies to European Union Only)	80
15 Troubleshooting	81
Solving Common Problems	81
Obtaining Online Help	85
Contacting the Technical Support Group	86
Transportation	87
16 Warranty	89
General Information	89
Liability	90
Exclusions	90
Certification	90
Service and Repairs	91
EXFO Service Centers Worldwide	92

A Technical Specifications 93
Index 95

Certification Information

North America Regulatory Statement

This unit was certified by an agency approved in both Canada and the United States of America. It has been evaluated according to applicable North American approved standards for product safety for use in Canada and the United States.

Electronic test and measurement equipment is exempt from FCC part 15, subpart B compliance in the United States of America and from ICES-003 compliance in Canada. However, EXFO Inc. makes reasonable efforts to ensure compliance to the applicable standards.

The limits set by these standards are designed to provide reasonable protection against harmful interference when the equipment is operated in a commercial environment. This equipment generates, uses, and can radiate radio frequency energy and, if not installed and used in accordance with the user guide, may cause harmful interference to radio communications. Operation of this equipment in a residential area is likely to cause harmful interference in which case the user will be required to correct the interference at his own expense.

Modifications not expressly approved by the manufacturer could void the user's authority to operate the equipment.



DECLARATION OF CONFORMITY

Application of Council Directive(s): 1999/5/EC – The R&TTE Directive
2011/65/UE – Restriction of the use of certain hazardous substances (RoHS)
And their amendments

Manufacturer's Name and Address:

EXFO Inc. 400 Godin Avenue Quebec City, Quebec G1M 2K2, CANADA Tel.: +1 418 683-0211	EXFO Europe Ltd. Winchester House School Lane, Chandlers Ford SO53 4DG, UK Tel.: +44 2380 246 800
---	--

Equipment Type/Environment: Test & Measurement / Industrial
Trade Name/Model No.: Multifunction Loss Tester—FOT-930 MaxTester

Standard(s) to which Conformity is declared:

EN 61010-1:2010 Edition 3.0	Safety requirements for electrical equipment for measurement, control, and laboratory use – Part 1: General requirements
EN 61326-1:2006	Electrical equipment for measurement, control and laboratory use – EMC requirements – Part 1: General requirements
EN 60825-1:2007 Edition 2.0	Safety of laser products – Part 1: Equipment classification and requirements

I, the undersigned, hereby declare that the equipment specified above conforms to the above Directive and Standards.

Manufacturer:



Stephen Bull, E. Eng
Vice-President Research and Development

400 Godin Avenue,
Quebec City, Quebec
G1M 2K2 CANADA
January 31, 2013

1 Introducing the FOT-930 Multifunction Loss Tester

The FOT-930 Multifunction Loss Tester integrates a power meter and light sources with an optical return loss meter, optional talk set and visual fault locator.

Main Features

The unit features **FASTEST™**, EXFO's one-touch automated measurement. In 10 seconds, you can simultaneously test IL and ORL at up to four wavelengths, in both directions. During the same test, the unit also determines fiber length.

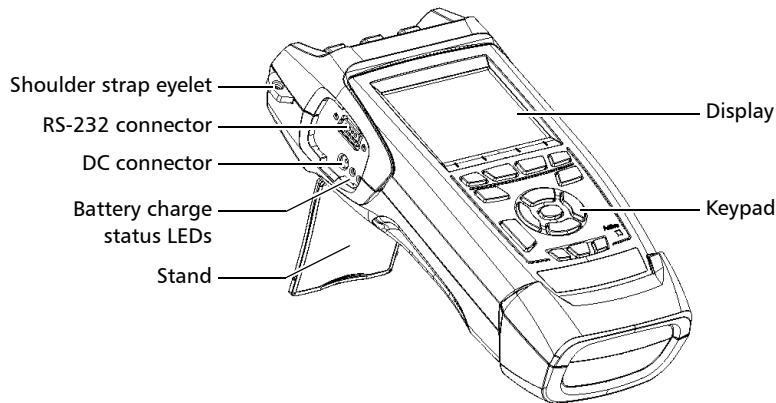

The power meter has the following characteristics:

- Ge, GeX or InGaAs detector with 40 calibrated wavelengths to measure absolute power or link loss
- Editable list of favorite wavelengths for easy access
- Modulated signal detection
- Automatic wavelength detection from compatible sources
- No offset nulling required in normal operation

Introducing the FOT-930 Multifunction Loss Tester

Main Features

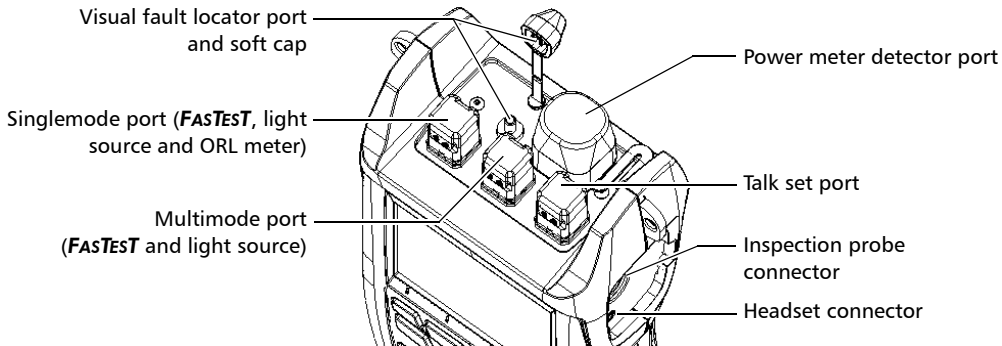

Note: *Optical ports and connectors may differ from the illustration.*

The light source has the following characteristics:

- Singlemode port (two or three wavelengths), also used for **FASTEST** and ORL.
AND/OR
Multimode port (two wavelengths), also used for **FASTEST** only.
- Modulated or high-power signal compatible with other EXFO units

Other test utilities:

- Text messaging
- Full-duplex digital talk set (optional)
- Visual fault locator to inspect or identify fibers (optional)
- Video fiber inspection probe (optional)

Result processing and analysis features (also available in the Optical Report Viewer application):

- Customizable test thresholds with visual pass/fail analysis
- Memory for 1024 results and possible data transfer to a computer for analysis with the Optical Report Viewer software
- **FASTEST** results displayed according to FTTx usage and terminology

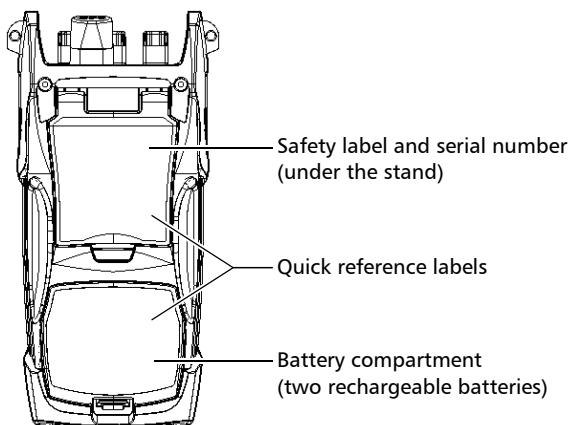

Other useful characteristics:

- Energy-saving features: automatic backlight or unit shutdown
- Multilingual graphical user interface
- Comprehensive online help available from each function and Quick Reference labels affixed to back of unit

Power Sources

The unit operates with the following power sources:

- AC adapter/charger (connected to standard power outlet—indoor use only). Compatible car outlet adapter available upon request
- One or two Lithium-Ion rechargeable batteries (automatically take over if you unplug the AC adapter/charger)
 - Field-changeable without affecting operation
 - Automatic recharge when AC adapter/charger connected
- CR2032-type Lithium cell battery (for clock only, used when Lithium-Ion batteries and DC power are both unavailable)



IMPORTANT

Batteries are not charged at the factory. Fully charge them (about 4 hours) before using the unit for the first time.

Typical Applications

You can use the Multifunction Loss Tester for several applications, such as:

- Fiber installation and maintenance applications
- FTTx: testing of passive optical networks (PONs)
- Absolute power or link loss measurements
- Bidirectional loss and ORL testing
- Length measurement
- All-in-one tool for contractors

Conventions

Before using the product described in this manual, you should understand the following conventions:



WARNING

Indicates a potentially hazardous situation which, if not avoided, could result in *death or serious injury*. Do not proceed unless you understand and meet the required conditions.



CAUTION

Indicates a potentially hazardous situation which, if not avoided, may result in *minor or moderate injury*. Do not proceed unless you understand and meet the required conditions.



CAUTION

Indicates a potentially hazardous situation which, if not avoided, may result in *component damage*. Do not proceed unless you understand and meet the required conditions.



IMPORTANT

Refers to information about this product you should not overlook.

2 **Safety Information**



WARNING

Do not install or terminate fibers while a light source is active. Never look directly into a live fiber and ensure that your eyes are protected at all times.



WARNING

The use of controls, adjustments and procedures other than those specified herein may result in exposure to hazardous situations or impair the protection provided by this unit.



IMPORTANT

When you see the following symbol on your unit , make sure that you refer to the instructions provided in your user documentation. Ensure that you understand and meet the required conditions before using your product.



IMPORTANT









Other safety instructions relevant for your product are located throughout this documentation, depending on the action to perform. Make sure to read them carefully when they apply to your situation.

Safety Information

Other Safety Symbols on Your Unit

Other Safety Symbols on Your Unit

One or more of the following symbols may also appear on your unit.

Symbol	Meaning
	Direct current
	Alternating current
	Both direct and alternating current
	The unit is equipped with an earth (ground) terminal.
	The unit is equipped with a protective conductor terminal.
	The unit is equipped with a frame or chassis terminal.
	On (Power)
	Off (Power)

Laser Safety Information (Units without VFL)

Your instrument is a Class 1 laser product in compliance with standards IEC 60825-1: 2007 and 21 CFR 1040.10, except for deviations pursuant to Laser Notice No. 50, dated June 24, 2007. Invisible laser radiation may be encountered at the output port.

The following label indicates that a product contains a Class 1 source:



Laser Safety Information (Units with VFL)

Your instrument is a Class 3R laser product in compliance with standards IEC 60825-1: 2007 and 21 CFR 1040.10, except for deviations pursuant to Laser Notice No. 50, dated June 24, 2007. Laser radiation is emitted at the output port. It is potentially harmful in direct intrabeam viewing.

The following label(s) indicate that the product contains a Class 3R source:



Affixed to back
(under the stand)

VFL
Laser
Aperture

Indicated on
connector panel

Safety Information

Electrical Safety Information

Electrical Safety Information

The AC adapter/charger provided with this unit is specifically designed to work with your product.



WARNING

Use only accessories that meet EXFO specifications.



CAUTION

EXFO guarantees the specifications and viability of the products **ONLY** if they are used with chargers and batteries provided by EXFO.



WARNING

- Use the external power supply indoors only.
- Operation of any electrical instrument around flammable gases or fumes constitutes a major safety hazard.
- To avoid electrical shock, do not operate the unit if any part of the outer surface (covers, panels, etc.) is damaged.
- Use only the AC adapter/charger provided by EXFO with your unit.
- Use only the car outlet adapter designed for your unit and approved by EXFO. The car outlet adapter contains a replaceable fuse. Replace the damaged fuse **ONLY** with a fuse of the same type: 3AG certified, 16 VDC, 3 A, with an I²t between 40 A²sec and 80 A²sec.
- When you use the unit outdoors, ensure that it is protected from liquids, dust, direct sunlight, precipitation, and full wind pressure.

Equipment Ratings	
Temperature	
➤ Operation	-0 °C to 40 °C (32 °F to 104 °F)
➤ Storage	-40 °C to 70 °C (-40 °F to 158 °F)
Relative humidity ^a	
➤ unit	≤ 95 % non-condensing
➤ AC adapter	0 % to 80 % non-condensing
Maximum operation altitude	5000 m (6562 ft)
Pollution degree	2 (connected to AC mains) ^b 3 (powered by batteries) ^c
Overvoltage category	
➤ unit	I
➤ AC adapter	II
Input power ^d	
➤ unit	⎓ 9 - 16 V; 12 W
➤ AC adapter	~ 120 V, 14.4 W, 60 Hz ~ 230 V, 17 W, 50 Hz

a. Measured in 0 °C to 31 °C (32 °F to 87.8 °F) range, decreasing linearly to 50 % at 40 °C (104 °F)

b. For indoor use only.

c. Equipment is normally protected against exposure to direct sunlight, precipitations and full wind pressure.

d. Not exceeding ± 10 % of the nominal voltage

3 Getting Started with Your Multifunction Loss Tester



CAUTION

To avoid damaging your unit, use it only with modules approved by EXFO.

Turning the Unit On and Off

When you turn the unit on, you may use it immediately under normal conditions (while the source offers good startup performance, you should allow a 5-minute warmup).

When the unit is turned off, it keeps the following parameters in its internal memory:

- **FASTEST** parameters
- Current power meter wavelength and list of favorite wavelengths
- User-defined thresholds
- Autonaming settings
- Regional, LCD and energy-saving settings
- Saved values and test results



IMPORTANT

If you remove batteries (and the AC adapter/charger is unplugged), the unit will turn off *without saving the above elements*.

The date and time will be lost only if you remove the clock battery.

Note: *To ensure that the power is completely turned off, disconnect the AC adapter/charger and remove the batteries.*

Getting Started with Your Multifunction Loss Tester

Using Menus and Keypad

To turn the unit on:

Press . The unit initializes for a few seconds and displays the **Power Meter** pane.

To turn the unit off:

Hold down the  button for two seconds.

Using Menus and Keypad

You can access optical tools from the keypad or menu. Menu options may differ depending on your unit configuration.

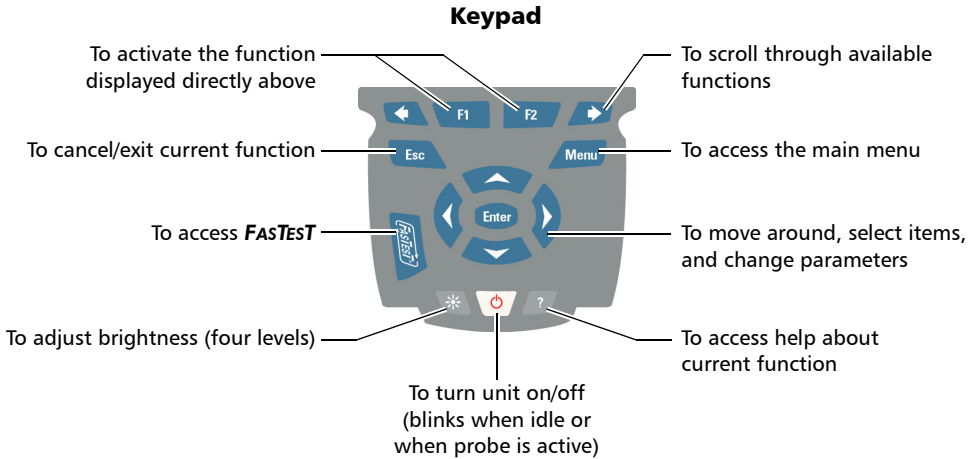

Status Bar

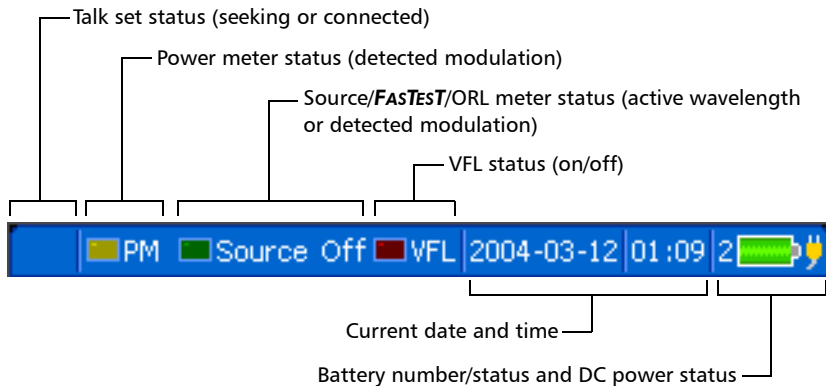

To access main features:

1. Press the **Menu** key.
2. Use the arrows to select feature and press **Enter**.

To activate F1/F2 functions:

1. Use the left/right function arrows (beside F1/F2 keys) to make the desired function or parameter visible.
2. Press the F1 or F2 key located just below.

To access and modify on-screen parameters:

1. Use the arrows to select an on-screen item (drop-down list, keyboard, check box, etc.).
2. Press **Enter** to activate or open it.

To enter text or numbers with an on-screen keyboard:

- Use the left/right function arrows (beside F1/F2 keys) to move the cursor in the text.
- Use the up/down and left/right arrows to select a character, then press **Enter** to add it.
- Press **OK** (F1/F2 key) to accept the element and hide the keyboard.

4 Customizing Your Multifunction Loss Tester

Selecting the Language of Operation

You may display the user interface in one of six languages (default is English). If other languages become available in the future, you could access them by replacing the unit software (see *Upgrading the Embedded Software* on page 80). Values are kept in memory when you turn the unit off. You may also [revert to factory settings](#) at any time.

To select a new interface language:

1. Press **Menu**, then select **Setup > Unit**.
2. Press **Next Tab** (F1/F2 key) until you get to the **Regional** tab.
3. Use the arrows to select the **Language** list, then press **Enter** to open it.
4. With the current language highlighted, use the up/down arrows to select the desired language, then press **Enter** to activate it.

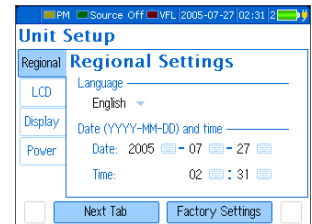

To revert unit to factory-default settings:

1. Press **Menu**, then select **Setup > Unit**.
2. Press **Factory Settings** (F1/F2 key). Values on all tabs of the **Unit Setup** pane are returned to factory settings.

Setting the Date and Time

The current date and time are displayed on the status bar. When saving results, the unit also saves the corresponding date and time.

You must enter the date according to the year-month-day format and the time according to the 24-hour format.

Note: A dedicated clock battery keeps the date and time accurate. For details, see Replacing Batteries on page 77.

To set the date and time:

1. Press **Menu**, then select **Setup > Unit**.
2. Press **Next Tab** (F1/F2 key) until you get to the **Regional** tab.
3. Use the arrows to select any of the date or time settings, then press **Enter** to display the **on-screen keyboard** (for details about using keyboards, see *Using Menus and Keypad* on page 14).
4. Set the new value and press **OK** (F1/F2 key).

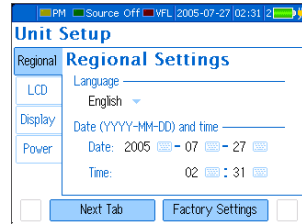

Adjusting the Brightness and Contrast

To fit your work environment, you may adjust the LCD brightness and contrast. Values are kept in memory when you turn the unit off. You may also [revert to factory settings](#) at any time.

Note: *These settings do not apply to the [Fiber Inspection Probe](#) display. For details, see [Inspecting Fibers with the FIP on page 63](#).*

To adjust the display brightness and contrast:

Press the  key repeatedly to switch between brightness levels (0-4-7-10).

OR

1. Press **Menu**, then select **Setup > Unit**.
2. Press **Next Tab** (F1/F2 key) until you get to the **LCD** tab.
3. Use the up/down arrows to select the **Brightness** or **Contrast** slider.
4. Use the left/right arrows to adjust the brightness or contrast level.

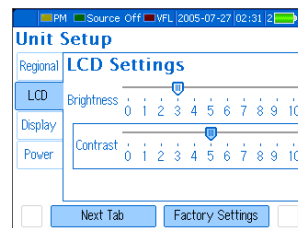

To revert unit to factory-default settings:

1. Press **Menu**, then select **Setup > Unit**.
2. Press **Factory Settings** (F1/F2 key). Values on all tabs of the **Unit Setup** pane are returned to factory settings.

Activating and Setting Screen Saver and Auto-Off

When you do not use the unit for a while, the display may be dimmed to save power. Your unit may also turn itself off completely.

You can set idle durations for DC and battery operation. Values are kept in memory when you turn the unit off. You may also [revert to factory settings](#) at any time.

Note: *The ON/OFF button blinks to indicate screen saver activation, but unit operation is not interrupted. Press any key to deactivate the screen saver.*

To activate/deactivate the screen saver or auto-off:

1. Press **Menu**, then select **Setup > Unit**.
2. Press **Next Tab** (F1/F2 key) until you get to the **Power** tab (for auto-off) or **Display** tab (for screen saver).
3. Use the up/down arrows to select the battery or AC adapter duration list, then press **Enter** to open the list.
4. With the current duration highlighted, use the up/down arrows to select the desired duration (or **Never**), then press **Enter** to confirm.

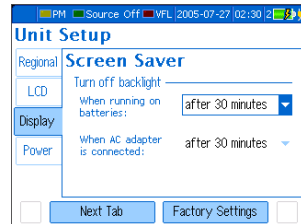

To revert unit to factory-default settings:

1. Press **Menu**, then select **Setup > Unit**.
2. Press **Factory Settings** (F1/F2 key). Values on all tabs of the **Unit Setup** pane are returned to factory settings.

5 **Setting Up Your Multifunction Loss Tester**

Installing the EXFO Universal Interface (EUI)

The EUI fixed baseplate is available for connectors with angled (APC) or non-angled (UPC) polishing. A green border around the baseplate indicates that it is for APC-type connectors.

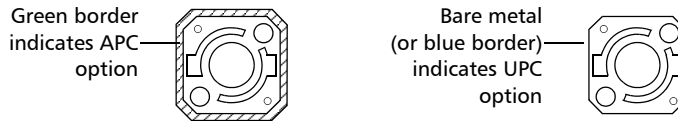

To install an EUI connector adapter onto the EUI baseplate:

1. Hold the EUI connector adapter so the dust cap opens downwards.

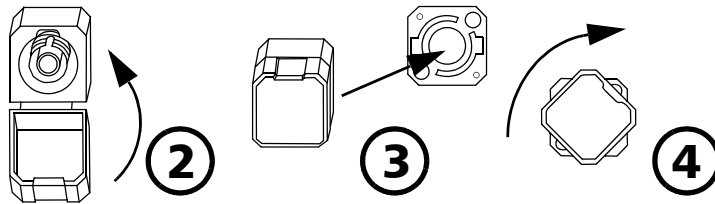

2. Close the dust cap in order to hold the connector adapter more firmly.
3. Insert the connector adapter into the baseplate.
4. While pushing firmly, turn the connector adapter clockwise on the baseplate to lock it in place.

Cleaning and Connecting Optical Fibers



IMPORTANT

To ensure maximum power and to avoid erroneous readings:

- Always inspect fiber ends and make sure that they are clean as explained below before inserting them into the port. EXFO is not responsible for damage or errors caused by bad fiber cleaning or handling.
- Ensure that your patchcord has appropriate connectors. Joining mismatched connectors will damage the ferrules.

To connect the fiber-optic cable to the port:

- 1.** Inspect the fiber using a fiber inspection microscope. If the fiber is clean, proceed to connecting it to the port. If the fiber is dirty, clean it as explained below.
- 2.** Clean the fiber ends as follows:
 - 2a.** Gently wipe the fiber end with a lint-free swab dipped in isopropyl alcohol.
 - 2b.** Use compressed air to dry completely.
 - 2c.** Visually inspect the fiber end to ensure its cleanliness.

Setting Up Your Multifunction Loss Tester

Cleaning and Connecting Optical Fibers

3. Carefully align the connector and port to prevent the fiber end from touching the outside of the port or rubbing against other surfaces.

If your connector features a key, ensure that it is fully fitted into the port's corresponding notch.

4. Push the connector in so that the fiber-optic cable is firmly in place, thus ensuring adequate contact.

If your connector features a screwsleeve, tighten the connector enough to firmly maintain the fiber in place. Do not overtighten, as this will damage the fiber and the port.

Note: *If your fiber-optic cable is not properly aligned and/or connected, you will notice heavy loss and reflection.*

EXFO uses good quality connectors in compliance with EIA-455-21A standards.

To keep connectors clean and in good condition, EXFO strongly recommends inspecting them with a fiber inspection probe before connecting them. Failure to do so will result in permanent damage to the connectors and degradation in measurements.

Setting Autonaming Scheme

Initially, the unit suggests cable and fiber names based on autonaming settings. After saving a result, the unit prepares the next fiber name by incrementing the suffix (or by adding “001” to a name with no suffix).

When you manually change the name for the first time (in **Power Meter**, **ORL Meter** or **FASTeST**), the unit then ignores autonaming settings.



IMPORTANT

To start using new autonaming settings, you must **delete all cables** from memory.

- Cable names: maximum 21 characters for prefix, 3 digits for number (or 24 characters when name is manually set)
- Fiber names: maximum 12 characters for prefix, plus 3-digit suffix (duplicate names allowed when name is manually set)

Note: *If you manually change a fiber name, then turn the unit off without saving at least one result, this name will be discarded.*

To set the autonaming scheme:

1. Press **Menu**, then select **Setup > Data Autonaming**.
2. Use the arrows to select the cable prefix, cable number or fiber prefix.
3. Press **Enter** to display the **on-screen keyboard** (for details about using keyboards, see *Using Menus and Keypad* on page 14).
4. Set the name/value, then press **OK** (F1/F2 key) to hide the keyboard.

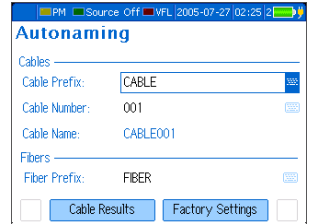
**To revert to the factory-default autonaming scheme:**

1. Press **Menu**, then select **Setup > Data Autonaming**.
2. Press **Factory Settings** (F1/F2 key).

Setting Pass/Fail Thresholds

You can define five groups of thresholds to specify acceptable loss (in dB and dB per distance unit) and ORL values (in dB) for each wavelength, for both singlemode and multimode fibers.

Thresholds are supplied by system manufacturers and depend on the system deployed.

Each time a measurement exceeds a threshold, the result is shown with a red background and an exclamation mark in the table.



IMPORTANT

Thresholds are not saved with measurements. Results are compared to the threshold group currently *active* on the unit where results are viewed (for *FASTeST* results, not necessarily the master unit).

Note: *When transferring results from handheld unit to computer, thresholds are not transferred along with results. However, you can define thresholds in the Optical Report Viewer application.*

To set loss or ORL thresholds:

1. Press **Menu**, then select **Setup > Thresholds**.
2. Use the arrows to select a threshold group in the **Current** list. Select **None** to deactivate all thresholds.
3. Use the arrows to select:
 - a fiber mode (singlemode or multimode)
 - loss units (dB or dB/distance; distance units are selected in **FASTest** setup)

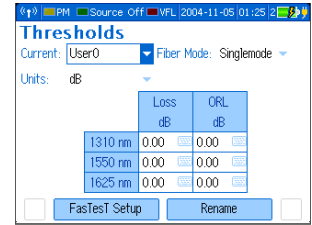

Note: When feet is the current distance unit, you must set thresholds in dB/kft to obtain meaningful values.

4. Use the arrows to select a value in the table (under the **Loss** or **ORL** columns), then press **Enter** to display the **on-screen keyboard** (for details about keyboards, see *Using Menus and Keypad* on page 14).
5. Set the threshold, then press **OK** (F1/F2 key) to hide the keyboard. The value must be within your unit's loss/ORL range.

Thresholds are saved only when you turn the unit off.

To rename a threshold group:

1. From the **Thresholds** pane, use the arrows to select the **Current** list, then press **Enter** to open it.
2. With the current group highlighted, use the up/down arrows to select the desired group, then press **Enter** to activate it.
3. Press **Rename** (F1/F2 key) to display the **on-screen keyboard** (for details about keyboards, see *Using Menus and Keypad* on page 14).
4. Set the new group name (maximum 10 characters), then press **OK** (F1/F2 key).

6 *Measuring Power or Loss*

The FOT-930 Multifunction Loss Tester is equipped with an optical power meter to measure absolute power (in dBm or W) or insertion loss (in dB). The power meter port is independent of the **FASTEST** port.

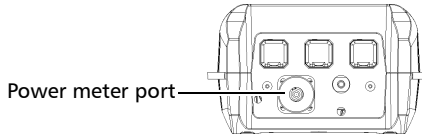

The following functions are available on your power meter:

The screenshot shows the 'Power Meter' interface. At the top, it displays 'PM', 'Source Off', and the date '2004-03-12 01:12'. The main display shows '28.98 dB'. Below this, it shows '1550 nm' and 'Ref. Power: -36.87 dBm'. At the bottom, there are two buttons: 'Wavelength' and 'W/dBm/dB'. Annotations with lines point to various parts of the screen:

- Modulation detected (PM if no modulation)**: Points to the 'PM' indicator.
- Measured power/loss**: Points to the '28.98 dB' display.
- Open list or press **Wavelength** to switch between favorite wavelengths. Press **Setup** to modify the list of favorite wavelengths or activate auto-detection.**: Points to the 'Wavelength' button.
- Open lists to change cable/fiber name of next saved data. Press **Store** to save current value under displayed name.**: Points to the 'BCFiber015' dropdown menu.
- Open list or press **W/dBm/dB** to display power (W or dBm) or loss (dB). Press **Reference** to set new reference for loss measurement.**: Points to the 'W/dBm/dB' button.

Measuring Power or Loss

Defining the List of Favorite Wavelengths

Defining the List of Favorite Wavelengths

You must put the wavelengths you want to use on a list of favorite wavelengths. Only wavelengths selected from this list are available for measurements.

By default, the list contains 22 of the 40 calibrated wavelengths. It can contain a maximum of 30 wavelengths.

Specifications are guaranteed for calibrated wavelengths only. For other wavelengths, the unit will determine values based on the calibrated wavelengths (3-point interpolation).

Detector Type	Calibrated Wavelengths (nm)	Default Favorite Wavelengths (nm)
► InGaAs	800, 820, 830, 840, 850, 860, 870,	800, 840, 850,
► Ge	880, 910, 980, 1270, 1280, 1290, 1300, 1310, 1320, 1330, 1340, 1390, 1450, 1460, 1470, 1480, 1490, 1500, 1510, 1520, 1530, 1540, 1550, 1560, 1570, 1580, 1590, 1600, 1610, 1620, 1630, 1640, 1650.	860, 910, 980, 1280, 1300, 1310, 1320, 1450, 1470, 1480, 1490, 1510, 1520, 1530, 1540, 1550, 1560, 1570, 1625.
► GeX	All the above, plus 1370 and 1060.	Same as above.

Note: *The list must always contain at least one selected wavelength.*

To customize the list of favorite and selected wavelengths:

1. Press **Menu**, then select **Setup > Power Meter**.

OR

From the **Power Meter** pane, press **Setup** (F1/F2 key).

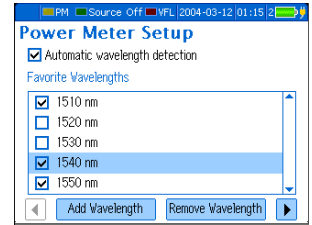

2. Using the up/down arrows, scroll through the list.
3. Press **Enter** to select/deselect the highlighted wavelength. An X appears beside selected wavelengths.
4. If a wavelength does not appear on the list, you can add it by pressing **Add Wavelength** (F1/F2 key). You can also remove a wavelength from the list by pressing **Remove Wavelength** (F1/F2 key).
5. Repeat these steps for other wavelengths as necessary.

To revert to the factory-default list:

1. Press **Menu**, then select **Setup > Power Meter**.

OR

From the **Power Meter** pane, press **Setup** (F1/F2 key).

2. Press **Factory Settings** (F1/F2 key).

Nulling Electrical Offsets

Temperature and humidity variations affect the performance of electronic circuits and optical detectors. Nulling the electrical offsets eliminate these effects.

Your unit has been designed not to require offset nulling under normal operation, but you should perform it whenever environmental conditions change significantly or when measuring very low power values.



IMPORTANT

Light must not reach detectors when nulling offsets. Always use an EUI or protective screw cap. Do not use a soft rubber cover.

Note: Starting a nulling automatically deactivates all light sources on the unit.

To perform an offset nulling:

1. Press **Menu**, then select **Setup > Power Meter**.

OR

From the **Power Meter** pane, press **Setup** (F1/F2 key).

2. Press **Nulling** (F1/F2 key).
3. Tighten the protective caps on the power meter and **FASTEST** ports, then press **OK**.

The nulling process takes approximately 10 seconds. Check marks appear next to nulled detectors. If light is still detected, you will need to place the caps properly and restart.

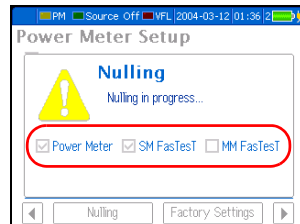

Referencing Your Power Meter to a Source

In reference mode, your unit displays the loss created by the fiber under test only, since it subtracts a reference value from the measured power.

In the illustration, the reference value (-36.87 dBm) is subtracted from the actual power measured (-7.89 dBm).

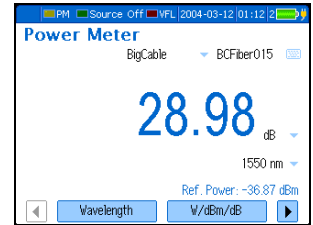

Note: *The reference value you set for each wavelength remains in memory until a new one is set for the same wavelength, even when you turn the unit off.*

Compatible sources (such as FOT-300 and FLS-300) can transmit a reference value to your power meter, avoiding the need for manual referencing. This value is not the source's actual power. It is a user-defined value that may not take the link loss into account.

Measuring Power or Loss

Referencing Your Power Meter to a Source

To reference the power meter to a source:

1. Press **Menu**, then select **Power Meter**.
2. Check your fibers and clean them properly for optimum performance (see *Cleaning and Connecting Optical Fibers* on page 22).
3. Using one of the following methods, connect a light source to the power meter port of your unit.

- One single reference patchcord

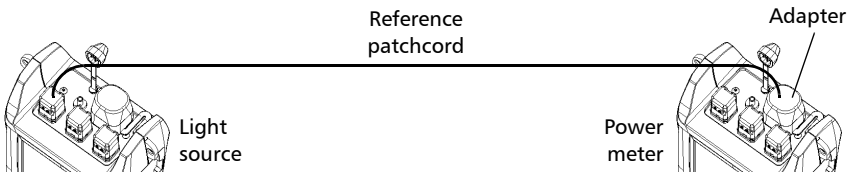

- Two reference patchcords and a bulkhead adapter

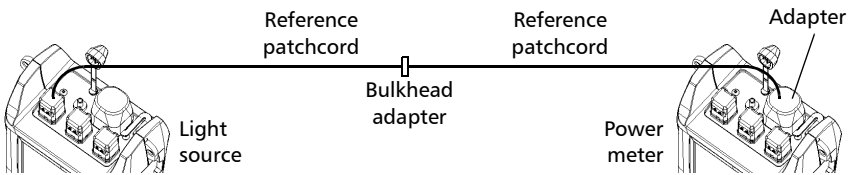

4. Activate the source at the desired wavelength.
5. Match the power meter wavelength with the source wavelength as follows:

- Press **Wavelength** (F1/F2 key) to switch between **favorite wavelengths** of your power meter (see *Defining the List of Favorite Wavelengths* on page 30).

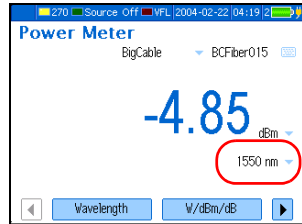

OR

- If the source emits an auto-wavelength signal and **auto-detection** is enabled (see *Automatically Detecting Wavelength* on page 39), the power meter automatically matches the source wavelength.

Measuring Power or Loss

Referencing Your Power Meter to a Source

6. Press **W/dBm/dB** (F1/F2 key) until you get **dB** units to retrieve the last saved reference.

OR

Press **Reference** (F1/F2 key) to save the current power as the new reference.

Reference power appears (in dBm) and current loss is automatically switched to dB.

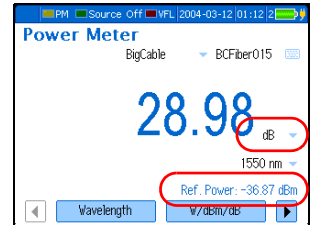

7. Repeat the procedure for each wavelength you want to reference.

To receive the reference value from a compatible source:

1. Connect the source to your power meter (with or without a fiber under test).
2. Use the source to emit the special signal that contains its power value. For more information, refer to the source's user guide.
 - When it detects the special signal, the power meter beeps. The new reference power is displayed (in dBm) and current loss reading is automatically switched to dB.
 - You cannot change the power meter wavelength, units or reference power manually.

Measuring Power or Loss

Measuring absolute power or link loss is done the same way, except for the referencing step. You can take power or loss measurements and save them for further analysis.



CAUTION

Connect high-power live fiber to the power meter port only.

To perform power or loss measurements:

1. If necessary, perform an [offset nulling](#) (see *Nulling Electrical Offsets* on page 32).
2. Press **Menu**, then select **Power Meter**.
3. Check your fibers and clean them properly (see *Cleaning and Connecting Optical Fibers* on page 22).
4. For loss measurements, [reference your power meter](#) to a light source (see *Referencing Your Power Meter to a Source* on page 33), then deactivate the light source.
5. If you have used a single reference patchcord, disconnect it *from the power meter port only*, then attach a second reference patchcord to the power meter.

OR

If you have used two reference patchcords, disconnect both of them at the bulkhead.

- Using bulkhead adapters or the system patch panels, connect a fiber under test to reference patchcords attached to the light source and power meter.

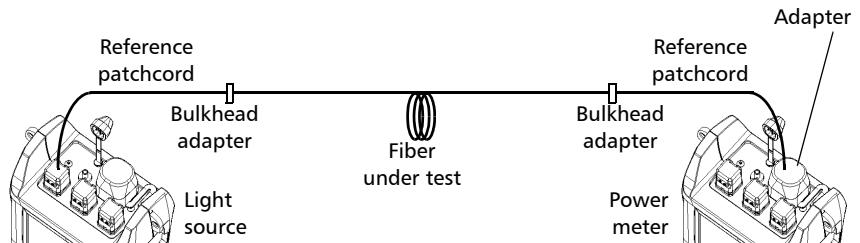

- Activate the source at the desired wavelength.
- Match the power meter wavelength with the source wavelength as follows:
 - Press **Wavelength** (F1/F2 key) to switch between **favorite wavelengths** of your power meter (see *Defining the List of Favorite Wavelengths* on page 30).

OR

- If the source emits an auto-wavelength signal and **auto-detection** is enabled (see *Automatically Detecting Wavelength* on page 39), the power meter automatically matches the source wavelength.

If the unit detects a modulated signal, it beeps and the signal frequency is indicated in the status bar, next to a yellow LED: **2k** indicates a 2-kHz signal, **1k** a 1-kHz signal, and **270** a 270-Hz signal.

- Press **W/dBm/dB** (F1/F2 key) to select the desired power (W or dBm) or loss (dB) unit.

Measuring Power or Loss

Measuring Power or Loss

10. Save the displayed values, if desired.

10a. Change the displayed cable and fiber names as needed.

10b. Press **Store** (F1/F2 key) to save the value along with wavelength, reference power, date and time. The fiber name will increment automatically, ready to save the next value.

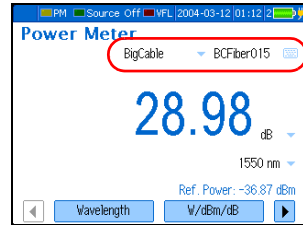

For details about viewing results, see *Managing Test Results* on page 55.

11. Repeat the procedure for other wavelengths.

Automatically Detecting Wavelength

Compatible sources (such as FOT-930, FOT-300 and FLS-300) can transmit their wavelength values through the fiber, avoiding the need to manually match the source and power meter wavelengths.

Note: *When receiving an auto-wavelength (or Auto-ID) signal, you cannot manually change the power meter wavelength.*

To receive an auto-wavelength signal from a source:

1. Press **Menu**, then select **Setup > Power Meter**.

OR

From the **Power Meter** pane, press **Setup** (F1/F2 key).

2. Use the arrows to select **Automatic wavelength detection**, then press **Enter**.
3. Connect a compatible source to your unit's power meter port.
4. Activate the source in Auto-ID mode (FOT-930: see *Using a Light Source* on page 59).

Your power meter automatically matches the source wavelength.

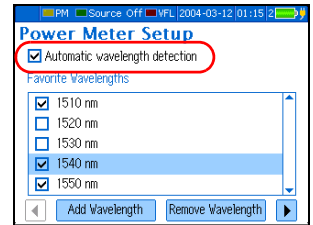

7 *Measuring Optical Return Loss*

Optical return loss (ORL) is the total effect of multiple reflections and scattering events within a fiber-optic system.

The FOT-930 Multifunction Loss Tester is equipped with an ORL meter to measure ORL for singlemode fibers. The ORL meter uses the **FASTEST SM** (singlemode) port only.

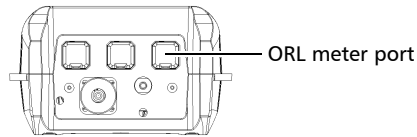

The following functions are available on your ORL meter:

The screenshot shows the ORL Meter interface. At the top, it displays '270 nm' and '1310 nm' with colored indicators. Below that, it shows 'ORL Meter' and 'BigCable' with a dropdown arrow. The main display shows '25.71 dB'. Below the display, it shows 'Sensitivity: 60.00 dB' and two buttons: 'Wavelength' and 'ORL Zero'. Callouts point to various parts of the screen and provide instructions.

Current ORL wavelength

Measured ORL (positive value)

Press **ORL Reference** to set reference using ORL calibrated patchcord (best).
Press **Loopback Ref.** to use any other patchcord.

Open lists to change cable/fiber name of *next* saved data.
Press **Store** to save current ORL value under displayed name.

Open list or press **Wavelength** to switch between singlemode wavelengths.

Press **ORL Zero** to calibrate the ORL meter sensitivity.
Press **Default ORL Zero** to revert to factory-default sensitivity.

Measuring Optical Return Loss

Performing ORL Reference and Setting ORL Zero Value

The ORL measurement procedure is outlined below:

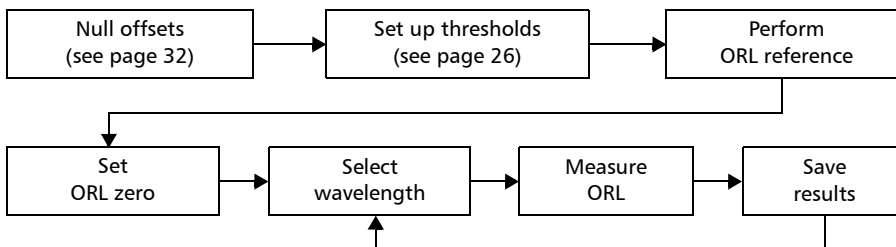

Performing ORL Reference and Setting ORL Zero Value

The ORL zero measurement eliminates the effects of backreflection on the link *before* the component under test, so your unit displays only the backreflection of this component.

You should set a new ORL zero:

- when you change the measurement patchcord (the one connected to the DUT, not the reference patchcord)
- when you remove a connection between the unit and mandrel

To set the ORL zero value (all wavelengths at once):

1. Press **Menu**, then select **ORL Meter**.
2. Press **ORL Zero** (F1/F2 key).
3. Connect a patchcord to the **FASTEST** SM port.



4. Terminate the fiber as close as possible *before* the component under test. Wrap it at least 10 turns around a mandrel or small diameter tool, adding turns until the reading stabilizes.
5. Press **OK** to save the ORL zero value, then remove the termination.

To revert to the factory-default ORL zero value:

1. Press **Menu**, then select **ORL Meter**.
2. Press **Default ORL Zero** (F1/F2 key).

Performing and Saving ORL Measurements

You can define **ORL thresholds** (see *Setting Pass/Fail Thresholds* on page 26) before or after measuring ORL. ORL values below thresholds are displayed in red.

To measure ORL:

1. If necessary, perform an **offset nulling** (see *Nulling Electrical Offsets* on page 32).
2. Press **Menu**, then select **ORL Meter**.
3. Press **Wavelength** (F1/F2 key) to select a singlemode wavelength.
4. Verify your patchcords and clean them properly (see *Cleaning and Connecting Optical Fibers* on page 22).

Note: *If the FASTEST SM port of your unit is equipped with an APC connector, use EXFO's optional ORL calibrated patchcord.*

Measuring Optical Return Loss

Performing and Saving ORL Measurements

5. Connect one end of a patchcord to the **FASTEST** SM port of your unit leaving the other end unconnected.
6. Perform an ORL reference as follows:

Note: *During the reference, the patchcord end should remain in the air; reflections occurring at a fiber-to-air interface correspond to a constant of 14.7 dB.*

Use the left/right function arrows to display **ORL Reference** and press the F1 or F2 key to select it.

In the ORL Reference message box, press **OK** (Enter).

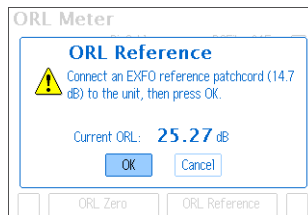

Measuring Optical Return Loss

Performing and Saving ORL Measurements

7. Perform an **ORL zero measurement** (see *Performing ORL Reference and Setting ORL Zero Value* on page 42).
8. Terminate the fiber as close as possible *after* the component under test. Wrap it at least 10 turns around a mandrel or small diameter tool, adding turns until the reading stabilizes.

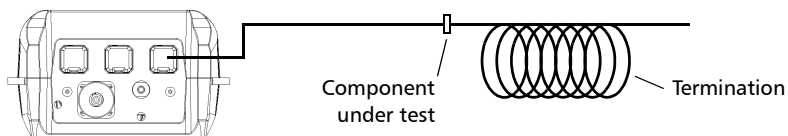

Note: Avoid bending the fiber between the unit and the termination point.

The displayed value represents the ORL of the component under test.

9. Save the displayed values, if desired.
 - 9a. Change the displayed cable and fiber names as needed.
 - 9b. Press **Store** (F1/F2 key) to save the value along with wavelength, date and time. The fiber name will increment automatically, ready to save the next value.

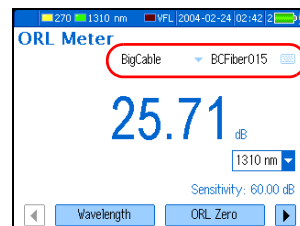

For details about viewing results, see *Managing Test Results* on page 55.

10. Repeat procedure for other wavelengths if necessary.

8 Performing Automated IL/ORL/Length Measurements (FASTEST)

FASTEST allows you to perform 2- or 3-wavelength bidirectional loss and ORL tests for singlemode fibers, or 2-wavelength loss tests for multimode fibers, in 10 seconds (including fiber length measurement).

FASTEST is useful in high-fiber-count installations. Activated at the touch of a button, **FASTEST** cuts down on training time and provides error-free results.

To use **FASTEST**, you need a compatible unit (such as FTB-3930, FOT-930, FOT-920 or FTB-3920, but not the FOT-910). The unit at the remote end is only used to establish references. It then waits for commands from the unit initiating **FASTEST** (master).

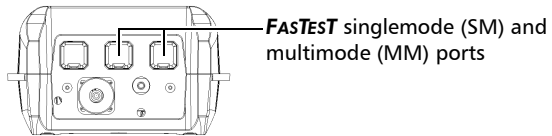

The **FASTEST** procedure is outlined below:

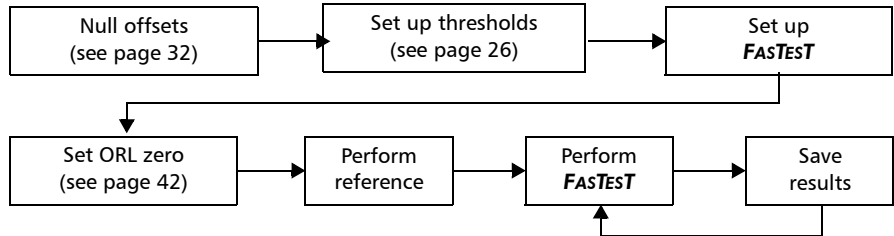

Performing Automated IL/ORL/Length Measurements (FASTEST)

Setting Up the FASTEST

You can configure the **FASTEST** on the master unit only. The remote unit will automatically adapt to these parameters (**FASTEST** parameters on remote unit are ignored).

Setup includes the following elements:

- Port and DUT (fiber) type: multimode
FASTEST will not include ORL.
- Compatibility: select **FOT-930** for fast, two- or three-wavelength testing including ORL (it requires two FOT-930/FTB-3930). Use **FOT-920** when other unit is an FOT-920 or FTB-3920.
- Length units: affects **thresholds** and fiber length only.
- Mode/wavelengths: select one or more wavelengths for the **FASTEST**. Depending on your choice, the **FASTEST** will include loss and/or ORL measurements. Selecting **FTTx Custom** or **FTTx All** allows you to define upstream and downstream wavelengths.
- Automatic saving of results: select where results are automatically stored (remote saving not available with FOT-920). Fiber name automatically increments after each **FASTEST**.
- Unit location: in FTTx mode, you specify if the master unit is closer to the CO (or to the premises) than the remote unit.

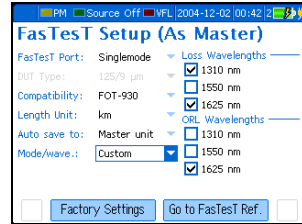

(standard wavelengths)

To set up the FASTEST:

1. Press **Menu**, then select **Setup > FasTest**.
2. Select the **FASTEST** parameters.

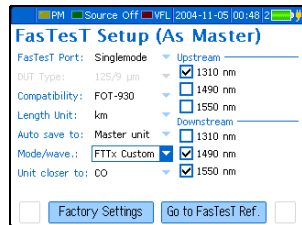

(FTTx wavelengths)

Referencing Units for FASTeST

Referencing subtracts the loss caused by the test setup components from the overall loss measured during FASTeST. The final result represents the loss inserted by the system under test alone.

Two referencing methods are available:

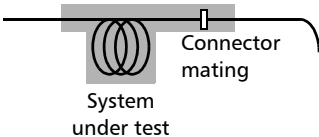
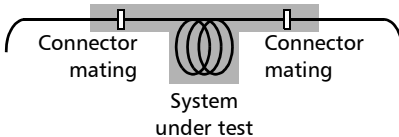
	Side-by-Side Method (Best)	Loopback Method
Description	Reference taken with both units together using their FASTeST ports. <i>Slightly more accurate</i> value than loopback method.	Reference taken separately on each unit (FASTeST port connected to power meter port).
Location of units	Must be at same location.	Can be at different locations.
Loss included in FASTeST result	Loss due to system under test and one connector mating. <div style="text-align: center;">  </div>	Loss due to system under test and the two connector matings. <div style="text-align: center;">  </div>
Elements to consider	Includes neither an ORL reference nor an ORL zero measurement . To obtain them, use the ORL Meter pane (see Performing ORL Reference and Setting ORL Zero Value <i>on page 42</i>). With multiple referencing, you may coordinate an FTB-3930 with up to 10 FOT-930 units.	When measuring ORL (FASTeST or ORL meter), accounts for connector loss and adjusts ORL calibration accordingly. Not recommended for short links.

Performing Automated IL/ORL/Length Measurements (FASTEST)

Referencing Units for FASTEST

To perform a side-by-side reference:

1. On the master unit (the one initiating the test), press **FASTEST**.
2. In the **Ref. Type** list, select the **Side-by-side** reference type, then press **Enter**. An illustration of the connection is shown with previous reference values (if any).
3. Connect both units through their **FASTEST** ports, using two reference patchcords and a bulkhead adapter.

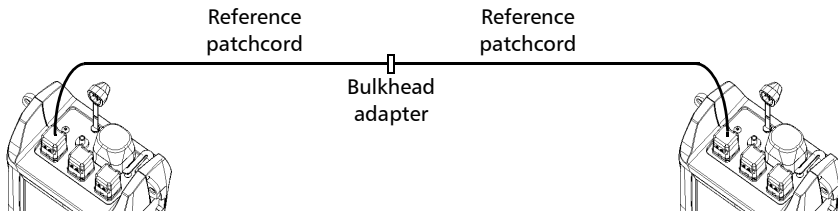
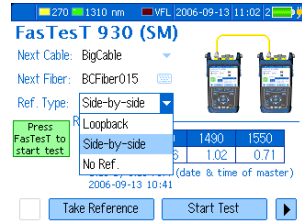

4. Press **Take Reference** (F1/F2 key). After a few seconds, the unit displays new reference values for each wavelength on both units. If values are not acceptable, try to clean connectors and repeat this step.
5. Disconnect the two patchcords *from the bulkhead only* and connect them to the fiber under test (using bulkhead adapters or the system patch panels).



IMPORTANT

- You can turn off the unit without losing the reference.
- If you disconnect the patchcords from the **FASTEST** ports, you must take a new reference.

To perform a loopback reference:

1. Press **FASTeST**.
2. In the **Ref. Type** list, select the **Loopback** reference type, then press **Enter**. An illustration of the connection is shown with previous reference values (if any).

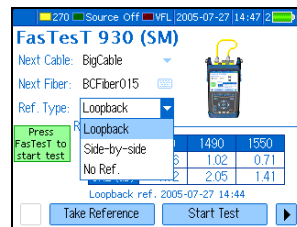

3. Connect a reference patchcord from the **FASTeST** port to the power meter adapter.
4. Press **Take Reference** (F1/F2 key). After a few seconds, the unit displays new reference values for each wavelength. If values are not acceptable, try to clean connectors and repeat this step.
5. Disconnect the reference patchcord *from the power meter adapter only* and connect it to the fiber under test.

Reference patchcord

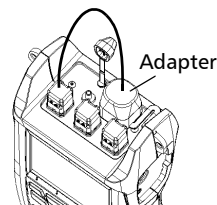

IMPORTANT

- You can turn off the unit without losing the reference.
- If you disconnect the patchcord from the **FASTeST** port, you must take a new reference.

6. Repeat the procedure with the second unit.

Performing Automated IL/ORL/Length Measurements (FASTEST)

Performing the *FASTEST*

Performing the *FASTEST*

Although *FASTEST* requires two units (one at each end of the fiber under test), you initiate it from only one (the master). Both units use *FASTEST* settings from the master unit.

To perform a *FASTEST*:

Unit A (Master)

1. If necessary, null the offsets (see *Nulling Electrical Offsets* on page 32).
2. Clean your fibers properly (see *Cleaning and Connecting Optical Fibers* on page 22).
3. Set up the *FASTEST* (see *Setting Up the FasTest* on page 48).
4. If you are testing ORL, perform an ORL zero measurement from the **ORL Meter** pane (see *Performing ORL Reference and Setting ORL Zero Value* on page 42).
5. Reference your unit (see *Referencing Units for FasTest* on page 49).
6. Connect reference patchcord to fiber under test (as shown):

Unit B

1. If necessary, null the offsets.
2. Clean your fibers properly.
3. If you are testing ORL, perform an ORL zero measurement from the **ORL Meter** pane.
4. Reference your unit.
5. Connect reference patchcord to fiber under test (as shown):

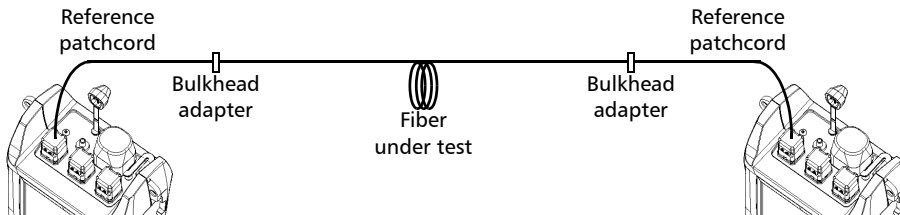

Performing Automated IL/ORL/Length Measurements (FASTest)

Performing the **FASTest**

Unit A (Master)

Unit B

7. From the **FASTest** pane, set the next cable/fiber names as needed (used for automatic save).
8. Press the **FASTest** key or press **Start Test** (F1/F2 key).

The units establish communication and automated tests begin. Measurements appear on both units as they are taken.

Disk icon would indicate unsaved results.

Open lists to select cable/fiber name for data to be saved.

Press **Store** to save results under displayed name.

Red/exclamation mark indicates result that exceeds threshold.

Press **Next Tab** to switch to next result type. (FTTx view)

Press **Setup** to modify **FASTest** parameters.

9. Save the displayed values if you want. If **Auto save** was activated for one or both units, results are already saved.
 - 9a. Change the displayed cable and fiber names as needed.
 - 9b. Press **Store** (F1/F2 key) to save the values. The fiber name increments automatically, ready to save the next value.

If you are not satisfied with the results, press **FASTest** and redo the test.

For details about viewing **FASTest** results, see *Managing Test Results* on page 55.

9 Managing Test Results

Viewing and Deleting Results

You can save up to 1024 results (**FASTEST**, power/loss and ORL) in your unit, along with references and date/time of tests. You will save and recall this data according to cable and fiber names.



IMPORTANT

The date and time of **FASTEST** references are not saved. They are displayed with the results *immediately after the test* only.

To view and process test results:

Press **Menu**, then select **Results/Information > Cable Results**. The following functions are available when viewing results:

Open lists to select cable/fiber name of data to recall.

Press **Next Fiber** or **Next Cable** to switch between available results.

Red/exclamation mark indicates result that exceeds threshold.

Press **Delete Fiber** or **Delete Cable** to remove data from list.

Press **Delete All Cables** to free memory.

Press **Next Tab** to switch to next result type. (standard view)

Loss	Loss (dB)		
ORL	A->B	B->A	AVG
ID	1310	9.72	10.11
	1490	12.55	15.44
	1550	15.56	18.57

Fiber Length: 12.011 km



IMPORTANT

- ▶ You cannot recover deleted results. Ensure that you **transfer your data to a computer** if you intend to use it later.
- ▶ Deleting a single cable/fiber does not free memory. To free memory, you must delete all cables at once.

Note: For more accuracy, the average is always calculated from loss values in W and then converted to dB.

Managing Test Results

Checking Available Memory

Checking Available Memory

You can save up to 1024 results in the unit memory.

To view the available memory on your unit:

Press **Menu**, then select **Results/Information > Unit Info**.

Transferring Test Results to a Computer

Using an appropriate serial cable and the Handheld Data Transfer software, you can transfer results from your handheld unit to a computer or FTB-500. This way, you can increase storage capacity, perform better analyses on test results and create reports.



IMPORTANT

Transferred files are not automatically deleted from your unit.

To transfer test results to a computer:

1. Using the serial cable, connect your unit to an available COM port of the computer.

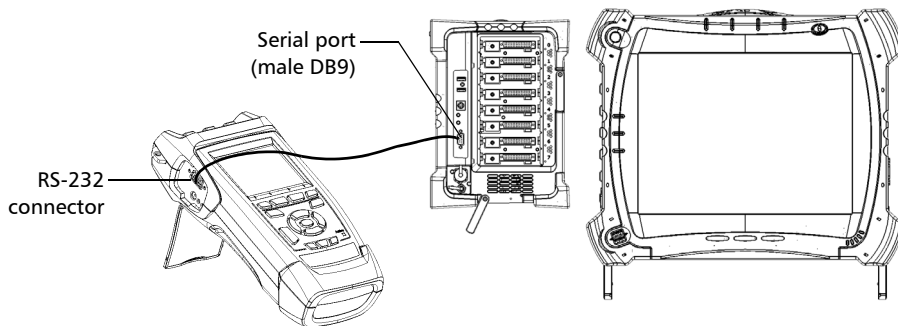

Note: *If your computer is not equipped with an RS-232 port, you can use a USB adapter. After installing the proper drivers, your computer should associate the adapter to an available COM port.*

2. Turn on both the computer and your handheld unit. Ensure that your unit will remain on during the transfer (connect it to a power outlet and deactivate auto-off).
3. On the computer, launch the Handheld Data Transfer application and start the operation.

Note: *For details about setting up the software and transferring data, refer to the Handheld Data Transfer online help.*

10 Using a Light Source

Your unit may contain two source ports: a 2- or 3-wavelength singlemode port and a 2-wavelength multimode port, depending on the configuration (see *Technical Specifications* on page 93).

The source signal can be continuous (CW or high-power) or modulated (270 Hz, 1 kHz or 2 kHz) and uses the **FASTEST** ports.

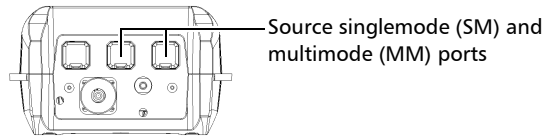

- CW signal (the default): constant power over the temperature range, but about 3 dB lower than maximum.
- High-power signal: reaches maximum power, but its power slightly varies over the temperature range.

A special *Auto ID* signal can transmit its wavelength value, to facilitate [wavelength detection](#) by a compatible unit.



WARNING

When a source is active, its port emits invisible laser radiation. Avoid exposure and do not stare directly into the beam. Ensure that any unused port is properly protected with a cap.

- The **Power Meter** pane remains displayed when you use the source.
- If you switch to power meter or VFL while a source is active, the **Source** pane remains displayed.
- When you switch sources, the modulation remains the same. It is indicated in the **Source** pane.

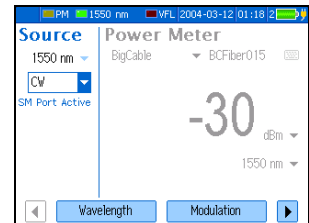

Using a Light Source

- Only one source/wavelength may be active at a time. The active port (SM or MM) is indicated in the **Source** pane.
- The source status is indicated with a LED in the status bar and with the **Active** indicator under the keypad.

Note: The **Active** indicator always shows the source, VFL, ORL meter or talk set port status (even in FIP or idle mode).

To activate a light source:

1. Connect the fiber under test to the source port (see *Cleaning and Connecting Optical Fibers* on page 22).
2. Press **Menu**, then select **Source/VFL > Source** (units with a VFL) or **Source** (units with no VFL).
3. Press **Wavelength** (F1/F2 key) to activate each available source in turn.

OR

Use the arrows to open the wavelength/status list and select the desired wavelength.

To deactivate a light source:

Press **Wavelength** (F1/F2 key) until you get past the last source. The list displays **Off**.

OR

Use the arrows to open the wavelength list and select **Off**.

To change the signal modulation:

1. Activate the source if you want.
 2. Press **Modulation** (F1/F2 key) to switch between available modulations.
- OR
3. Use the arrows to open the list and select the desired modulation.

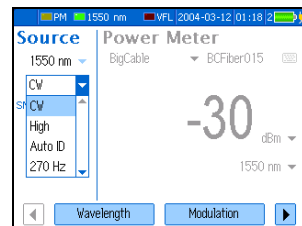

11 Identifying Fiber Faults Visually

The visual fault locator (VFL) helps you identify bends, faulty connectors, splices and other causes of signal loss.

From its dedicated port, the VFL emits a red signal which becomes visible at the location of a fault on the fiber. This signal can be continuous (CW, the default) or blinking (1 Hz).



WARNING

When the VFL is active, the VFL port emits visible laser radiation. Avoid exposure and do not stare directly into the beam. Ensure that any unused port is properly protected with a cap.

- The **Power Meter** pane remains displayed when you use the VFL.
- If you switch to source or power meter while the VFL is active, the **VFL** pane remains displayed.
- The VFL status is indicated with a LED in the status bar and with the **Active** indicator under the keypad.

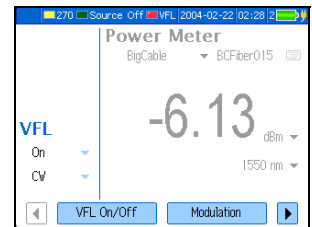

Note: The **Active** indicator always shows the source, VFL, ORL meter or talk set port status (even in FIP or idle mode).

Identifying Fiber Faults Visually

To activate the VFL and inspect a fiber:

1. Connect the fiber under test to the VFL port (see *Cleaning and Connecting Optical Fibers* on page 22).
2. Press **Menu**, then select **Source/VFL > VFL**.
3. Press **VFL On/Off** (F1/F2 key) to activate the VFL (list displays **On**).

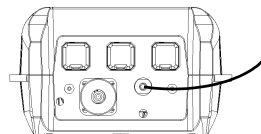

OR

Use the arrows to open the VFL status list and select **On**.

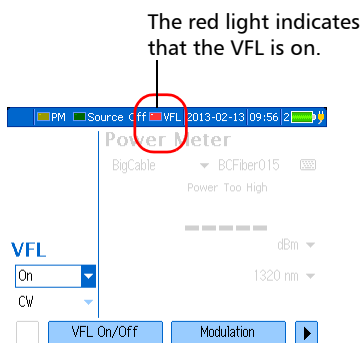

4. To switch between blinking (1 Hz) and continuous (CW) signals, press **Modulation** (F1/F2 key).

OR

Use the arrows to open the list and select the desired modulation.

5. Without looking directly into the beam, examine the fiber. If light is coming out of the rubber jacket or on the side of the ferrule, the fiber is defective.
6. Deactivate the VFL by pressing **VFL On/Off** (F1/F2 key).

12 *Inspecting Fibers with the FIP*

The fiber inspection probe allows you to find dirty or damaged connectors by displaying an enlarged view of the connector surface.

The following common features of video fiber inspection probes are compatible with your unit:

- Magnification control: supports 200x, 400x or other zoom factors.
- Focus control: allows you to fine-tune the display quality.
- Image capture: freezes the image on the FOT-930 display by pressing a button.

For more information, refer to the user guide that came with your probe.



IMPORTANT

- When another unit requests a *FASTEST* with your unit, the *FASTEST* takes over and Probe mode is interrupted.
- You cannot receive text messages or talk set calls while using Probe mode.

To access Probe mode on your unit:

1. Connect the probe to the right side of the unit, using an adapter if necessary.
2. Activate the probe display using one of the following:
 - Press **Menu**, then select **Probe**.
 - Press the button on the probe (some models only).

To adjust brightness or contrast:

- Brightness: use up/down arrows.
- Contrast: use left/right arrows.

To exit Probe mode and return to the regular display:

Press **Esc** or **Menu**.

13 **Communicating with Other Users**

Your Multifunction Loss Tester offers two ways to communicate:

- text messages
- voice (via the optional talk set)

Sending and Receiving Text Messages

To facilitate communication between opposite ends of a fiber (especially on models with no talk set), you may send text messages to compatible units (such as FOT-930, FTB-3930, FOT-920 or FTB-3920) through their **FASTEST** ports.

It is possible to send a predefined message or to write one of your own (maximum 30 characters). However, custom messages are deleted when you turn the unit off.



IMPORTANT

- The messaging feature does not work with the talk set port.
- The messaging feature will not work if both units try to send a message at the same time.
- You cannot use other features while sending or receiving a message.
- You cannot cancel the operation.

Communicating with Other Users

Sending and Receiving Text Messages

To add a custom text message to the list:

1. Press **Menu**, then select **Talk Set/Messages > Messages** (units with a talk set) or **Messages** (units with no talk set).
2. Using the up/down arrows, scroll through the list and select a message to use as a basis.
3. Press **New Message** (F1/F2 key).
4. Enter or change the message text using the **on-screen keyboard** and press **OK** (F1/F2 key). The message is added to the list.

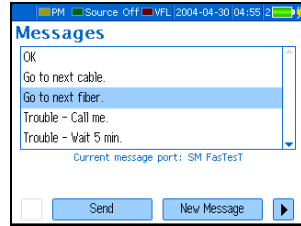

To send a text message:

1. Connect the units at each end of the same fiber via their **FASTEST** ports.

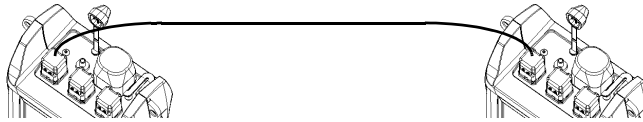

2. On the sending unit, press **Menu**, then select **Talk Set/Messages > Messages** (units with a talk set) or **Messages** (units with no talk set).

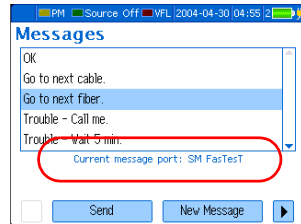

3. Ensure that the port indicated (SM or MM) is the one you use. Otherwise, press **Port Setup** (F1/F2 key) and change it, then return to the **Messages** pane.
4. Using the up/down arrows, scroll through the list and select the message.
5. Press **Send** (F1/F2 key).

After a few seconds, your message will automatically appear on the receiving unit. If an incompatible unit (or no unit) is detected at the other end, or if the **FASTEST** port of the receiving unit is in use, an error message will appear.

When you receive a message:

Your unit emits a short beep and displays the received message.

- Press **OK** to clear the display and return to your previous function.
- Press **Reply** to access the **Messages** pane and reply to the message. You will then need to use the menu to return to your previous function. *However, your last readings will be lost.*

Note: *If the message was written with a language not supported by your unit, you will see unreadable characters only.*

Communicating with Other Users

Communicating by Voice

Communicating by Voice

With the optional talk set, you can establish full-duplex digital voice communication over a dedicated fiber, even while other functions are in use.

The talk set provides adjustable headset volume and uses a dedicated port. It is not compatible with the FOT-920 or FTB-3920 talk sets.

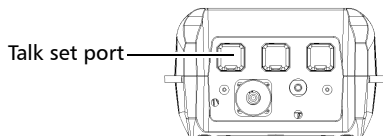

Note: *You may use any commercially available headset equipped with a microphone.*

While communication is established, the actions and displays of each unit may differ as follows:

- You can send or receive a call at any time, except during a **FASTEST**.
- Once communication is established, it will be maintained even if you use the unit's other test tools (including **FASTEST**).
- If communication is lost, calling unit will automatically try to reestablish communication.

To communicate between units:

Calling Unit

- 1.** Connect the calling unit to one end of the fiber via its talk set port, and plug in your headset.

Receiving Unit

- 1.** Connect the receiving unit to the other end of the fiber via its talk set port, and plug in your headset.

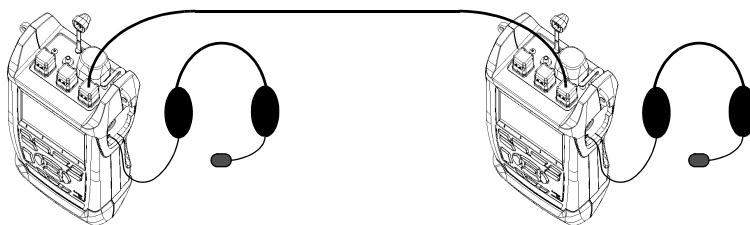

- 2.** Press **Menu**, then select **Talk Set/Messages > Talk Set**.

Communicating with Other Users

Communicating by Voice

Calling Unit

3. Press **Talk**. Your unit establishes communication with receiving unit.

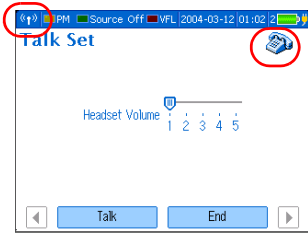

If no compatible unit is detected at the other end, a message appears.

4. Talk to the receiving unit.
5. To end the communication, press **End** from the **Talk set** pane.
2. Simply answer (no need to press a key).
3. To end the communication, press **End** from the **Talk set** pane.

To adjust the headset volume (calling or receiving unit):

1. Press **Menu**, then select **Talk Set/Message > Talk Set**.
2. Using the left/right arrows, adjust the volume level.

You cannot adjust or mute the ring sound.

Receiving Unit

When receiving the call, the unit rings 3 times. A phone icon appears to indicate that communication is established.

14 Maintenance

To help ensure long, trouble-free operation:

- Always inspect fiber-optic connectors before using them and clean them if necessary.
- Keep the unit free of dust.
- Clean the unit casing and front panel with a cloth slightly dampened with water.
- Store unit at room temperature in a clean and dry area. Keep the unit out of direct sunlight.
- Avoid high humidity or significant temperature fluctuations.
- Avoid unnecessary shocks and vibrations.
- If any liquids are spilled on or into the unit, turn off the power immediately, disconnect from any external power source, remove the batteries and let the unit dry completely.



WARNING

The use of controls, adjustments and procedures other than those specified herein may result in exposure to hazardous situations or impair the protection provided by this unit.

Cleaning EUI Connectors

Regular cleaning of EUI connectors will help maintain optimum performance. There is no need to disassemble the unit.



IMPORTANT

If any damage occurs to internal connectors, the module casing will have to be opened and a new calibration will be required.

Maintenance

Cleaning EUI Connectors



WARNING

Looking into the optical connector while the light source is active **WILL** result in permanent eye damage. EXFO strongly recommends to **TURN OFF** the unit before proceeding with the cleaning procedure.

To clean EUI connectors:

1. Remove the EUI from the instrument to expose the connector baseplate and ferrule.

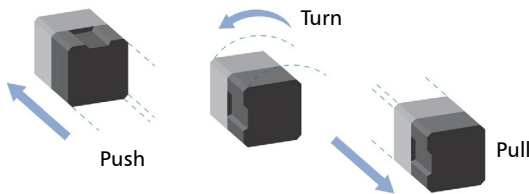

2. Moisten a 2.5 mm cleaning tip with *one drop* of isopropyl alcohol (alcohol may leave traces if used abundantly).
3. Slowly insert the cleaning tip into the EUI adapter until it comes out on the other side (a slow clockwise rotating movement may help).

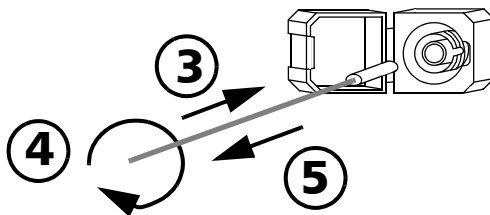

4. Gently turn the cleaning tip one full turn, then continue to turn as you withdraw it.
5. Repeat steps 3 to 4 with a dry cleaning tip.

Note: Make sure you don't touch the soft end of the cleaning tip.

6. Clean the ferrule in the connector port as follows:
 - 6a. Deposit *one drop* of isopropyl alcohol on a lint-free wiping cloth.



IMPORTANT

Isopropyl alcohol may leave residues if used abundantly or left to evaporate (about 10 seconds).

Avoid contact between the tip of the bottle and the wiping cloth, and dry the surface quickly.

- 6b. Gently wipe the connector and ferrule.
 - 6c. With a dry lint-free wiping cloth, gently wipe the same surfaces to ensure that the connector and ferrule are perfectly dry.
 - 6d. Verify connector surface with a portable fiber-optic microscope (for example, EXFO's FOMS) or fiber inspection probe (for example, EXFO's FIP).
7. Put the EUI back onto the instrument (push and turn clockwise).
8. Throw out cleaning tips and wiping cloths after one use.

Cleaning Detector Ports

Regular cleaning of detectors will help maintain measurement accuracy.



IMPORTANT

Always cover detectors with protective caps when unit is not in use.

To clean detector ports:

1. Remove the protective cap and adapter (FOA) from the detector.
2. If the detector is dusty, blow dry with compressed air.
3. Being careful not to touch the soft end of the swab, moisten a cleaning tip with *only one drop* of isopropyl alcohol.



IMPORTANT

Alcohol may leave traces if used abundantly. Do not use bottles that distribute too much alcohol at a time.

4. While applying light pressure (to avoid breaking the detector window), gently rotate the cleaning tip on the detector window.
5. Repeat step 4 with a dry cleaning tip or blow dry with compressed air.
6. Discard the cleaning tips after one use.

Cleaning VFL-Type Connectors

VFL-type connectors are fixed on your unit and can be cleaned using a mechanical cleaner.



WARNING

Verifying the surface of the connector with a fiber-optic microscope WHILE THE UNIT IS ACTIVE WILL result in permanent eye damage.

To clean a connector using a mechanical cleaner:

1. Insert the mechanical into the optical adapter, and push the outer shell into the cleaner.

Note: *The cleaner makes a clicking sound to indicate that the cleaning is done.*

2. Verify connector surface with a portable fiber-optic microscope (for example, EXFO's FOMS) or fiber inspection probe (for example, EXFO's FIP).

Recharging Main Batteries

The main Lithium-Ion batteries will last about 9 hours in normal operation.

- The combined charge status is shown on the status bar.
- The charge status of each battery is shown on the **Unit Info** pane (press **Menu**, then select **Results/Information > Unit Info**).
- The unit also indicates the charge status with LEDs on its left side:

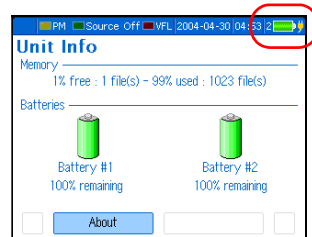

Status LED	Battery Charge Status
Green	Fully charged
Red	Charging
Yellow	Error



IMPORTANT

- Batteries are not charged at the factory. Fully charge them (about 4 hours) before using the unit for the first time.
- Batteries function and charge properly between 0 °C and 45 °C (32 °F and 113 °F). Batteries will not charge if the temperature is below -10 °C (14 °F) or above 45 °C (113 °F).
- Never store at temperatures above 60 °C (140 °F).
- Charge only with specified charger.

To recharge the main batteries:

Connect the unit to a power outlet (or car outlet) using the AC adapter/charger. The charge cycle will start and end automatically.

Replacing Batteries

You may replace main batteries or the clock battery at any time without affecting operation.

The two main Lithium-Ion batteries are independent, so you can replace one while the other is in use. If the unit is plugged in, you can replace *both* batteries while the unit is on.

Battery Safety Information



WARNING

Only use an EXFO battery. Batteries from other suppliers could result in serious damage to your unit, or personal injuries. Contact EXFO for more information.



WARNING

Do not throw batteries into fire or water and do not short-circuit the batteries' electrical contacts. Do not disassemble.

To replace main batteries:

1. Open the battery compartment door located at the back of the unit.
2. Replace one or both batteries, respecting the polarity.
3. Close the battery compartment door.

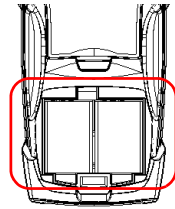

To replace the clock battery:

1. Open the battery compartment door located at the back of the unit.
2. Remove main batteries to reveal the clock battery door.

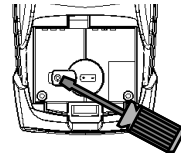

CAUTION

To reduce the risk of damage due to electrostatic discharge, touch grounded unpainted metal before handling the clock battery.

3. Open the clock battery compartment door with a screwdriver.
4. Replace the battery, respecting the polarity as shown.
5. Close the battery compartment doors.

Recalibrating the Unit

EXFO manufacturing and service center calibrations are based on the ISO/IEC 17025 standard (*General Requirements for the Competence of Testing and Calibration Laboratories*). This standard states that calibration documents must not contain a calibration interval and that the user is responsible for determining the re-calibration date according to the actual use of the instrument.

The validity of specifications depends on operating conditions. For example, the calibration validity period can be longer or shorter depending on the intensity of use, environmental conditions and unit maintenance, as well as the specific requirements for your application. All of these elements must be taken into consideration when determining the appropriate calibration interval of this particular EXFO unit.

Under normal use, the recommended interval for your FOT-930 Multifunction Loss Tester is: one year.

For newly delivered units, EXFO has determined that the storage of this product for up to six months between calibration and shipment does not affect its performance (EXFO Policy PL-03).

To help you with calibration follow-up, EXFO provides a special calibration label that complies with the ISO/IEC 17025 standard and indicates the unit calibration date and provides space to indicate the due date. Unless you have already established a specific calibration interval based on your own empirical data and requirements, EXFO would recommend that the next calibration date be established according to the following equation:

Next calibration date = Date of first usage (if less than six months after the calibration date) + Recommended calibration period (one year)

To ensure that your unit conforms to the published specifications, calibration may be carried out at an EXFO Service Center or, depending on the product, at one of EXFO's Certified Service Centers. Calibrations at EXFO are performed using standards traceable to national metrology institutes.

Maintenance

Upgrading the Embedded Software

Note: *The FlexCare warranty program includes Calibration/Verification packages (see Service and Repairs on page 91).*

Upgrading the Embedded Software

To upgrade the unit's embedded software, you will need to obtain the upgrade files from EXFO's Technical Support Group. You will also need an RS-232 cable and the Firmware Update application.



IMPORTANT



During software upgrades, you should connect your unit to a power outlet. If problems occur, contact EXFO.

Recycling and Disposal (Applies to European Union Only)

For complete recycling/disposal information as per European Directive WEEE 2012/19/UE, visit the EXFO Web site at www.exfo.com/recycle.

15 Troubleshooting

Solving Common Problems

Problem	Possible Cause	Solution
The unit does not turn on.	<ul style="list-style-type: none"> ➤ You did not press  long enough. ➤ AC adapter/charger not connected. ➤ Main batteries discharged. ➤ Weather too cold. 	<ul style="list-style-type: none"> ➤ Press  for 2 seconds. ➤ Connect the AC adapter/charger. ➤ Charge batteries by connecting the AC adapter/charger.
The display is almost blank at power-up.	Brightness may need some adjustment.	Press  to adjust brightness properly.
The date returns to 1900-01-01 .	Clock battery is dead.	Replace the clock battery (see <i>Replacing Batteries</i> on page 77).
Batteries do not charge as expected.	<ul style="list-style-type: none"> ➤ Temperature is too high. ➤ Battery is incorrectly connected. 	<ul style="list-style-type: none"> ➤ Ensure temperature is within specifications. ➤ Ensure battery is connected properly.
A battery status LED is yellow.	Battery is defective.	Contact EXFO or replace the battery.
During offset nulling, you get the following message: “Light detected during nulling.”	Light reaches at least one detector (power meter or FASTEST).	<p>Ensure protective caps are tightly screwed on FASTEST and power meter ports and perform the nulling again.</p> <p>Do not use rubber cover.</p>
When using the power meter, you get Power Too Low or Power Too High .	Power of the signal received at the power meter port is outside its measurement range.	<p>Check the connections.</p> <p>Ensure you use the proper fiber and connector type and that you use your power meter within specifications.</p>

Troubleshooting

Solving Common Problems

Problem	Possible Cause	Solution
Unable to change wavelength in Power Meter pane.	Power meter receives auto-wavelength (Auto-ID) signal.	<ul style="list-style-type: none">➤ Change source's emitting mode.➤ Deactivate wavelength detection.
Unable to change dB unit or reference power in Power Meter pane. OR Unit or reference value you changed are replaced by other values after a while.	Power meter receives reference power value from compatible source.	Wait a few seconds until power value is received, then retry.
When measuring ORL, you get Too Much Power .	Measured reflected power is higher than emitted power. The ORL reference is incorrect.	Always perform ORL reference before each ORL measurement.
When measuring ORL, you get ORL exceeds .	Reflection is below sensitivity (Max ORL) of ORL meter.	Perform an ORL zero measurement to increase the sensitivity of the detector. Ensure mandrel is correct and that patchcord and connectors are in good condition.

Problem	Possible Cause	Solution
Unable to establish FASTeST communication.	<ul style="list-style-type: none"> ➤ Remote unit's FASTeST port is in use. ➤ Remote unit is not compatible. ➤ Selected port on master unit differs from actual port to which fiber is connected. ➤ Compatibility set to FOT-930 but remote unit is not an FOT-930 or FTB-3930. 	<ul style="list-style-type: none"> ➤ Wait until FASTeST completes, turn source and ORL meter off or exit Probe mode. ➤ Make sure remote unit is an FOT-930, FTB-3930, FOT-920 or FTB-3920. ➤ Set the port (SM or MM) correctly in FASTeST Setup on master unit. ➤ Set the compatibility to FOT-920 in FASTeST Setup on master unit.
During FASTeST , you get a message saying that loopback reference was not performed.	Loopback reference was selected, but not performed (or reference is outdated).	Perform a loopback reference before FASTeST measurement.
ORL values are inaccurate for short fibers at 1310 nm during a FASTeST .	—	Measure ORL manually.
Unable to communicate with an FOT-920 using the talk set.	Talk sets of the FOT-920 and FOT-930/FTB-3930 are not compatible.	Use text messaging instead.
Unable to establish connection with compatible talk set.	Probe mode is activated on remote unit (FOT-930 only).	Deactivate Probe mode.

Troubleshooting

Solving Common Problems

Problem	Possible Cause	Solution
Unable to send a text message.	<ul style="list-style-type: none">➤ Selected port differs from actual port to which fiber is connected.➤ Receiving unit's port is in use.➤ Remote unit is not compatible.	<ul style="list-style-type: none">➤ On the sending unit, set the correct port (SM or MM) in FASTeST Setup.➤ Wait until FASTeST completes, turn source and ORL meter off or exit Probe mode.➤ Make sure remote unit is an FOT-930, FTB-3930, FOT-920 or FTB-3920.

Obtaining Online Help

Context-sensitive help is conveniently available at all times to guide you through the use of your unit.

Most test operations pause while you view help, but will resume automatically when you exit help.



To obtain online help about current function:

Press the ? button from any pane or message box.

To navigate in the online help:

- Use up/down arrows to scroll through help page.
- Use left/right arrows to switch between hyperlinks (underlined items), then press **Enter** to link to selected help page.
- Press **Next Page** to switch between available topics in sequence.
- Press **Help Menu** to display the main menu of help topics.
- Press **Esc** to return to your test pane.

Troubleshooting

Contacting the Technical Support Group

Contacting the Technical Support Group

To obtain after-sales service or technical support for this product, contact EXFO at one of the following numbers. The Technical Support Group is available to take your calls from Monday to Friday, 8:00 a.m. to 7:00 p.m. (Eastern Time in North America).

Technical Support Group

400 Godin Avenue
Quebec (Quebec) G1M 2K2
CANADA

1 866 683-0155 (USA and Canada)
Tel.: 1 418 683-5498
Fax: 1 418 683-9224
support@exfo.com

For detailed information about technical support, and for a list of other worldwide locations, visit the EXFO Web site at www.exfo.com.

To accelerate the process, please have information such as the name and the serial number (see the product identification label), as well as a description of your problem, close at hand.

You may also be requested to provide the firmware version number.

To find out the firmware version number:

- 1.** Press **Menu**, then select **Results/Information > Unit Info**.
- 2.** Press **About** (F1/F2 key).

Transportation

Maintain a temperature range within specifications when transporting the unit. Transportation damage can occur from improper handling. The following steps are recommended to minimize the possibility of damage:

- Pack the unit in its original packing material when shipping.
- Avoid high humidity or large temperature fluctuations.
- Keep the unit out of direct sunlight.
- Avoid unnecessary shocks and vibrations.

16 Warranty

General Information

EXFO Inc. (EXFO) warrants this equipment against defects in material and workmanship for a period of three years from the date of original shipment. EXFO also warrants that this equipment will meet applicable specifications under normal use.

During the warranty period, EXFO will, at its discretion, repair, replace, or issue credit for any defective product, as well as verify and adjust the product free of charge should the equipment need to be repaired or if the original calibration is erroneous. If the equipment is sent back for verification of calibration during the warranty period and found to meet all published specifications, EXFO will charge standard calibration fees.



IMPORTANT

The warranty can become null and void if:

- unit has been tampered with, repaired, or worked upon by unauthorized individuals or non-EXFO personnel.
- warranty sticker has been removed.
- case screws, other than those specified in this guide, have been removed.
- case has been opened, other than as explained in this guide.
- unit serial number has been altered, erased, or removed.
- unit has been misused, neglected, or damaged by accident.

THIS WARRANTY IS IN LIEU OF ALL OTHER WARRANTIES EXPRESSED, IMPLIED, OR STATUTORY, INCLUDING, BUT NOT LIMITED TO, THE IMPLIED WARRANTIES OF MERCHANTABILITY AND FITNESS FOR A PARTICULAR PURPOSE. IN NO EVENT SHALL EXFO BE LIABLE FOR SPECIAL, INCIDENTAL, OR CONSEQUENTIAL DAMAGES.

Warranty

Liability

Liability

EXFO shall not be liable for damages resulting from the use of the product, nor shall be responsible for any failure in the performance of other items to which the product is connected or the operation of any system of which the product may be a part.

EXFO shall not be liable for damages resulting from improper usage or unauthorized modification of the product, its accompanying accessories and software.

Exclusions

EXFO reserves the right to make changes in the design or construction of any of its products at any time without incurring obligation to make any changes whatsoever on units purchased. Accessories, including but not limited to fuses, pilot lamps, batteries and universal interfaces (EUI) used with EXFO products are not covered by this warranty.

This warranty excludes failure resulting from: improper use or installation, normal wear and tear, accident, abuse, neglect, fire, water, lightning or other acts of nature, causes external to the product or other factors beyond the control of EXFO.



IMPORTANT

In the case of products equipped with optical connectors, EXFO will charge a fee for replacing connectors that were damaged due to misuse or bad cleaning.

Certification

EXFO certifies that this equipment met its published specifications at the time of shipment from the factory.

Service and Repairs

EXFO commits to providing product service and repair for five years following the date of purchase.

To send any equipment for service or repair:

- 1.** Call one of EXFO's authorized service centers (see *EXFO Service Centers Worldwide* on page 92). Support personnel will determine if the equipment requires service, repair, or calibration.
- 2.** If equipment must be returned to EXFO or an authorized service center, support personnel will issue a Return Merchandise Authorization (RMA) number and provide an address for return.
- 3.** If possible, back up your data before sending the unit for repair.
- 4.** Pack the equipment in its original shipping material. Be sure to include a statement or report fully detailing the defect and the conditions under which it was observed.
- 5.** Return the equipment, prepaid, to the address given to you by support personnel. Be sure to write the RMA number on the shipping slip. *EXFO will refuse and return any package that does not bear an RMA number.*

Note: *A test setup fee will apply to any returned unit that, after test, is found to meet the applicable specifications.*

After repair, the equipment will be returned with a repair report. If the equipment is not under warranty, you will be invoiced for the cost appearing on this report. EXFO will pay return-to-customer shipping costs for equipment under warranty. Shipping insurance is at your expense.

Routine recalibration is not included in any of the warranty plans. Since calibrations/verifications are not covered by the basic or extended warranties, you may elect to purchase FlexCare Calibration/Verification Packages for a definite period of time. Contact an authorized service center (see *EXFO Service Centers Worldwide* on page 92).

Warranty

EXFO Service Centers Worldwide

EXFO Service Centers Worldwide

If your product requires servicing, contact your nearest authorized service center.

EXFO Headquarters Service Center

400 Godin Avenue
Quebec (Quebec) G1M 2K2
CANADA

1 866 683-0155 (USA and Canada)
Tel.: 1 418 683-5498
Fax: 1 418 683-9224
support@exfo.com

EXFO Europe Service Center

Winchester House, School Lane
Chandlers Ford, Hampshire S053 4DG
ENGLAND

Tel.: +44 2380 246800
Fax: +44 2380 246801
support.europe@exfo.com

EXFO Telecom Equipment (Shenzhen) Ltd.

3rd Floor, Building 10,
Yu Sheng Industrial Park (Gu Shu
Crossing), No. 467,
National Highway 107,
Xixiang, Bao An District,
Shenzhen, China, 518126

Tel: +86 (755) 2955 3100
Fax: +86 (755) 2955 3101
support.asia@exfo.com

A Technical Specifications



IMPORTANT

The following technical specifications can change without notice. The information presented in this section is provided as a reference only. To obtain this product's most recent technical specifications, visit the EXFO Web site at www.exfo.com.

Specifications ^a

EXTERNAL POWER METER

	FOT-932	FOT-932X	FOT-933
Detector type	Ge	GeX	InGaAs
Measurement range (dBm)	10 to -70	26 to -55	6 to -73
Range displayed (dBm)	Down to -77	Down to -65	Down to -80
Uncertainty ^{b, c}	± 5 % ± 0.1 nW	± 5 % ± 3 nW	± 5 % ± 0.05 nW
Wavelength range (nm)	800 to 1650	800 to 1650	800 to 1650
Display resolution (dB) ^b	0.01	0.01	0.01
Calibrated wavelengths	40	42	40
Recommended recalibration period (years)	3	3	3
Automatic offset nulling ^d	Yes	Yes	Yes
Measurement-distance units	kilometers, meters, kilofeet, feet, miles		

SOURCES

	Standard	-4	-5	-12C (second port)	-12D (second port)
Wavelengths (nm) ^e	1310 ± 20 1550 ± 20	1310 ± 20 1550 ± 20 1625 ± 10	1310 ± 20 1490 ± 10 1550 ± 20	850 ± 25 1300 +50/-10	850 ± 25 1300 +50/-10
Emitter type	Laser	Laser	Laser	LED	LED
Minimum output power (dBm) ^e	-1/-1	-1/-4/-7	-1/-7/-4	-27/-27 (50/125 μm) ^l	-21/-21 (82.5/125 μm) ^l
Spectral width (nm) ^f	≤ 5/± 5	≤ 5/± 5/± 5	≤ 5/± 5/± 5	50/135	50/135
Stability (8 hours) (dB) ^g	± 0.05	± 0.05	± 0.05	± 0.05	± 0.05

FASTEST

	Standard	-4	-5	-12C (second port)	-12D (second port)
Wavelengths (nm)	1310 1550	1310 1550 1625	1310 1490 1550	850 1300	850 1300
Loss range (dB) ^h	60	56	56	40	46
Loss precision (repeatability) (dB) ⁱ					
side-by-side	0.15	0.15	0.15	0.15	0.15
loopback	0.25	0.25	0.25	0.25	0.25
Length measurement range (km)	200	200	200	5	5
Length measurement uncertainty ^j	±(10 m + 1 % x length)				

DEDICATED ORL

	All SM Wavelengths
ORL range (APC / UPC) (dB)	65/55
ORL uncertainty (dB) ^k	± 0.5
Resolution (dB) ^b	0.01

TALK SET

	Laser
Emitter type	Laser
Wavelength (nm)	1550 ± 20
Dynamic range at 1550 nm (dB)	45
Dynamic range MM (dB) ^l	40

VFL ⁱ

	Laser
Emitter type	Laser
Wavelength (nm)	650
Output power (dBm)	3

Technical Specifications

GENERAL SPECIFICATIONS

Size (H x W x D)	250 mm x 125 mm x 75 mm	(9 7/8 in x 4 15/16 in x 3 in)
Weight	1 kg	(2.2 lb)
Temperature	operating	-10 °C to 50 °C
	storage ^m	-40 °C to 70 °C
Storage	Capacity of 1024 complete tests	
Relative humidity	0 % to 95 % non-condensing	
Power ^l	Li-Ion battery (9 hours)	
	3 hours to fully recharge when unit is off	
Warranty (years)	3	

STANDARD ACCESSORIES

User guide, AC adapter/charger, 2 Li-Ion batteries, shoulder strap, Certificate of Calibration.

Notes

- a. At 23 °C ± 1 °C and 1550 nm with FC connector and on batteries, unless otherwise specified.
- b. Resolution, uncertainty and linearity are functions of input power; uncertainty is valid at calibration conditions.
- c. Up to 20 dBm for GeX.
- d. Power of > -45 dBm for Ge, > -30 dBm for GeX and > -47 dBm for InGaAs.
- e. In High source mode.
- f. As defined by Telcordia TR-TSY-000887, rms for lasers and at -3 dB for LEDs; typical values for LEDs.
- g. After a warm-up time of 6 minutes, in CW source mode.
- h. Typical value, at 1550 nm for SM and 850 nm for MM.
- i. Typical value.
- j. For fiber length ≤ 120 km.
- k. Typical value.
- l. For graded-index MM fibers, typical.
- m. Without batteries.

Index

!	26
A	
AC adapter/charger	4
AC requirements	11
after-sales service	86
analyzing results	3
applications, typical	4
automatic shutdown	20
automatic wavelength detection	1
autonaming	13, 24
auto-off function	20
available memory	56
B	
backlight. <i>see</i> brightness	
backreflection measurement	43
battery	
charge status	1, 15, 76
clock	4, 18
compartment	3
description	4
maintenance recommendations	76
recharging	76
replacing or removing	13, 77
safety	78
blinking button	20
brightness, setting	14, 19
C	
cable and fiber names	24
calibrated wavelengths	1
cancel function	14
cancelling dark current effects	32
car outlet charging batteries with	76
caution	
of personal hazard	5
of product hazard	5
certification information	vi
changing	
batteries	77
date and time	18
charge status, battery	1
circuit performance	32
cleaning	
detector ports	74
EUI connectors	71
fiber ends	22
front panel	71
VFL connectors	75
clock battery. <i>see</i> battery	
clock display	15
communication	
talk set	68
text messages	65
component under test. <i>see</i> DUT	
configuring application	17–27
connecting handheld unit	56
connector cleaner	75
connectors, cleaning	71
connectors, illustration of	1–3
contrast, setting	19
conventions, safety	5
CR2032-type battery. <i>see</i> battery	
current	
date and time	15, 18
wavelength	13
current, electrical	11
customer service	91

Index

D	
dark current effects, eliminating	32
data	
deleting	55
recalling	53, 55
data, transferring	3
date and time	
display	15
setting	18
DC connector	1
deleting data	55
description	
ORL meter	41
power meter	29
detection	
modulation	1
wavelength	1
detection, modulation	1
detector	
<i>see also</i> power meter	
detector port, cleaning	74
detector types	1
device under test. <i>see</i> DUT	
display	1
brightness and contrast	19
saved settings	13
disposable battery. <i>see</i> battery	
DUT	33, 36, 42, 48
E	
electronic offsets, eliminating	32
ending talk set communication	70
energy, saving	20
equipment returns	91
establishing talk set communication	68
EUI	
baseplate	21
connector adapter	21
dust cap	21
EUI connectors, cleaning	71
exclamation mark	26
EXFO universal interface. <i>see</i> EUI	
exit function	14
F	
FasTest	
accessing	14
description	1
parameters	13
port	2
status	15
thresholds	26
wavelengths, selecting	48
favorite wavelengths	1, 13
features	1
fiber and cable names	24
fiber ends, cleaning	22
fiber inspection probe. <i>see</i> probe	
fiber length measurement	1, 47
fiber under test. <i>see</i> DUT	
firmware version, module	86
front panel, cleaning	71
FTTx mode/wavelengths	48
FTTx results	3, 53
H	
handheld unit, connecting	56
hazard, laser radiation	9
headset	
connector	2
using	69
help. <i>see</i> online help	
high-power source	2
I	
identification label	86
input current	11
insertion loss (IL). <i>see</i> loss	
inspection probe. <i>see</i> probe	
intensity. <i>see</i> contrast	
interface language	17

- intermittent signal..... 62
internal memory. *see* memory
- K**
- keypad 1, 14
- L**
- label, identification 86
labels
 quick reference 3
 safety..... 3
language, selecting 17
laser safety information 9
laser source. *see* source
LCD settings 13
LED, battery charge status..... 1
length, fiber 1, 47
light source. *see* source
lighting display..... 19
list of favorite wavelengths 1, 30
Lithium-Ion battery. *see* battery
loopback referencing method 49
loss measurement
 description..... 1
 performing 36
 reference 33, 49
 saving results..... 38
 thresholds..... 26
 see also power meter
- M**
- mail feature. *see* text messages
main menu..... 15
maintenance
 battery..... 76
 detector ports..... 74
 EUI connectors..... 71
 front panel..... 71
 general information..... 71
maximum input current 11
- measuring
 loss 36
 ORL 41
 power 36
mechanical connector cleaning 75
memory
 available..... 56
 parameters saved in 13
menus 14
message feature. *see* text messages
modulation
 detection of 1, 37
 source 2, 59
 VFL..... 61
module information
 firmware version number..... 86
 module identification number 86
 serial number 86
mounting EUI connector adapter 21
multimode port 2, 47, 59
multiple referencing 49
- N**
- naming results automatically..... 13, 24
nulling offsets. *see* offset nulling
- O**
- offset nulling 1, 32
on and off, turning unit 13
online help 14, 85
optical detector performance 32
optical return loss. *see* ORL measurement
ORL measurement
 description 1, 41
 performing..... 43
 thresholds 26
ORL meter
 port..... 2
 status 15
 wavelength setting 41
ORL zero measurement, performing 42

Index

P

parameters saved	13
pass/fail thresholds. <i>see</i> thresholds	
PDF. <i>see</i> online help	
performing	
null measurement.....	32
ORL measurement	43
ORL zero measurement.....	42
power or loss measurement	36
PON testing.....	4
ports, illustration of	1–3
power measurement. <i>see</i> loss	
power meter	
description.....	1, 29
detector types.....	1
display	29
modulated signal detection.....	37
port	2
setting the wavelength.....	29
status.....	15
wavelength list	30
power on/off.....	13
power reference, setting	33
power source, AC.....	11
power sources	
description.....	4
status.....	15
<i>see also</i> AC adapter/charger	
<i>see also</i> battery	
prefix, naming.....	24
probe	
brightness and contrast.....	19
connector	2
using	63
product	
features	1
identification label.....	86
specifications.....	93
protective cap	74

Q

quick reference labels.....	3
-----------------------------	---

R

radiation hazard, laser.....	9
recalling saved data.....	53, 55
receiving text message	67
rechargeable battery. <i>see</i> battery	
red, value in.....	26
reference measurement	
loopback method.....	49
multiple	49
power meter.....	33
side-by-side method	49
reference, zero power.....	32
regional settings.....	13, 17
replacing or removing batteries.....	13, 77
results	
autonaming	24
ORL measurement.....	45
processing features.....	3
return loss. <i>see</i> ORL measurement	
return merchandise authorization (RMA)	91
ring volume	70
RS-232	
connector	1
software upgrade	80

S

safety	
battery.....	78
caution	5
conventions	5
information.....	9
label.....	3
warning	5
saved data	
deleting	55
recalling	53, 55
saving power/loss results.....	38

screen saver.....	20
sending text message.....	66
serial number, module.....	86
serial port. see RS-232	
service and repairs.....	91
service centers.....	92
setting	
brightness and contrast.....	19
date and time.....	18
language.....	17
ORL meter wavelength.....	41
power meter wavelength.....	29
power reference.....	33
source wavelength.....	60
thresholds.....	26
shipping to EXFO.....	91
shoulder strap.....	1
shutdown, automatic.....	20
side-by-side referencing method.....	49
signal, modulating.....	59, 60, 61, 62
singlemode port.....	2, 47, 59
software upgrade.....	80
source	
activating.....	60
high-power.....	2
modulating signal.....	2, 59, 60
multimode.....	2
operation and display.....	60
port.....	2
setting wavelength.....	60
singlemode.....	2
status.....	15, 60
warmup time.....	13
specifications, product.....	93
stand.....	1
status bar.....	15
status, battery charge.....	1
storage requirements.....	71
strap, shoulder.....	1
suffix, naming.....	24
symbols, safety.....	5
system under test. see DUT	

T

talk set	
compatibility.....	68
description.....	68
ending communication.....	70
establishing communication.....	68
placing a call.....	69
port.....	2, 68
receiving a call.....	70
status.....	15
voice and ring volumes.....	70
technical specifications.....	93
technical support.....	86
temperature for storage.....	71
test tools	
light source.....	59
ORL meter.....	41
power meter.....	29
text messages	
compatibility.....	65
description.....	3, 65
modifying.....	66
receiving.....	67
sending.....	66
thresholds.....	3, 13, 26
time and date	
display.....	15
setting.....	18
tools	
talk set.....	68
visual fault locator.....	61
see <i>also</i> test tools	
transferring data.....	3
transportation requirements.....	71, 87
turning unit on and off.....	13
typical applications.....	4

U

upgrading the software.....	80
user guide. see online help	

Index

V

VFL	
modulating signal.....	61, 62
operation and display.....	62
performing a test.....	62
port	2
status.....	15, 61
VFL, cleaning.....	75
viewing saved data.....	53, 55
visual fault locator. see VFL	
voice volume	70
volumes (ring and voice)	70

W

warmup time, source	13
warranty	
certification	90
exclusions	90
general	89
liability.....	90
null and void.....	89
wavelengths	
automatic detection of.....	1
calibrated	1
FasTesT	48
list of favorite	1, 13, 30
ORL meter.....	41
power meter.....	29
source.....	60

Z

zero measurement, ORL	42
zero-power reference	32

NOTICE

通告

CHINESE REGULATION ON RESTRICTION OF HAZARDOUS SUBSTANCES

中国关于有害物质限制的规定

NAMES AND CONTENTS OF THE TOXIC OR HAZARDOUS SUBSTANCES OR ELEMENTS CONTAINED IN THIS EXFO PRODUCT



包含在本 **EXFO** 产品中的有毒有害物质或元素的名称和含量

O	Indicates that this toxic or hazardous substance contained in all of the homogeneous materials for this part is below the limit requirement in SJ/T11363-2006 表示该有毒有害物质在该部件所有均质材料中的含量均在 SJ/T11363-2006 标准规定的限量要求以下。
X	Indicates that this toxic or hazardous substance contained in at least one of the homogeneous materials used for this part is above the limit requirement in SJ/T11363-2006 表示该有毒有害物质至少在该部件的某一均质材料中的含量超出 SJ/T11363-2006 标准规定的限量要求。

Part Name 部件名称	Toxic or hazardous Substances and Elements 有毒有害物质和元素					
	Lead 铅 (Pb)	Mercury 汞 (Hg)	Cadmium 镉 (Cd)	Hexavalent Chromium 六价铬 (Cr VI)	Polybrominated biphenyls 多溴联苯 (PBB)	Polybrominated diphenyl ethers 多溴二苯醚 (PBDE)
Enclosure 外壳	O	O	O	O	O	O
Electronic and electrical sub-assembly 电子和电子组件	X	O	X	O	X	X
Optical sub-assembly ^a 光学组件 ^a	X	O	O	O	O	O
Mechanical sub-assembly ^a 机械组件 ^a	O	O	O	O	O	O

a. If applicable.
如果适用。

MARKING REQUIREMENTS
标注要求

Product 产品	Environmental protection use period (years) 环境保护使用期限 (年)	Logo 标志
This Exfo product 本 EXFO 产品	10	
Battery ^a 电池 ^a	5	

- a. If applicable.
如果适用。

P/N: 1064527

www.EXFO.com · info@exfo.com

CORPORATE HEADQUARTERS	400 Godin Avenue	Quebec (Quebec) G1M 2K2 CANADA Tel.: 1 418 683-0211 · Fax: 1 418 683-2170
EXFO AMERICA	3400 Waterview Parkway Suite 100	Richardson, TX 75080 USA Tel.: 1 972-761-927 · Fax: 1 972-761-9067
EXFO EUROPE	Winchester House, School Lane	Chandlers Ford, Hampshire S053 4DG ENGLAND Tel.: +44 2380 246 800 · Fax: +44 2380 246 801
EXFO ASIA-PACIFIC	100 Beach Road, #25-01/03 Shaw Tower	SINGAPORE 189702 Tel.: +65 6333 8241 · Fax: +65 6333 8242
EXFO CHINA	Beijing Global Trade Center, Tower C, Room 1207, 36 North Third Ring Road East, Dongcheng District	Beijing 100013 P. R. CHINA Tel.: +86 (10) 5825 7755 · Fax: +86 (10) 5825 7722
EXFO SERVICE ASSURANCE	270 Billerica Road	Chelmsford MA, 01824 USA Tel.: 1 978 367-5600 · Fax: 1 978 367-5700
EXFO FINLAND	Elektroniikkatie 2	FI-90590 Oulu, FINLAND Tel.: +358 (0) 403 010 300 · Fax: +358 (0) 8 564 5203
TOLL-FREE	(USA and Canada)	1 800 663-3936

© 2013 EXFO Inc. All rights reserved.
Printed in Canada (2013-07)



EXFO
EXPERTISE REACHING OUT