

iOLM

intelligent Optical Link Mapper

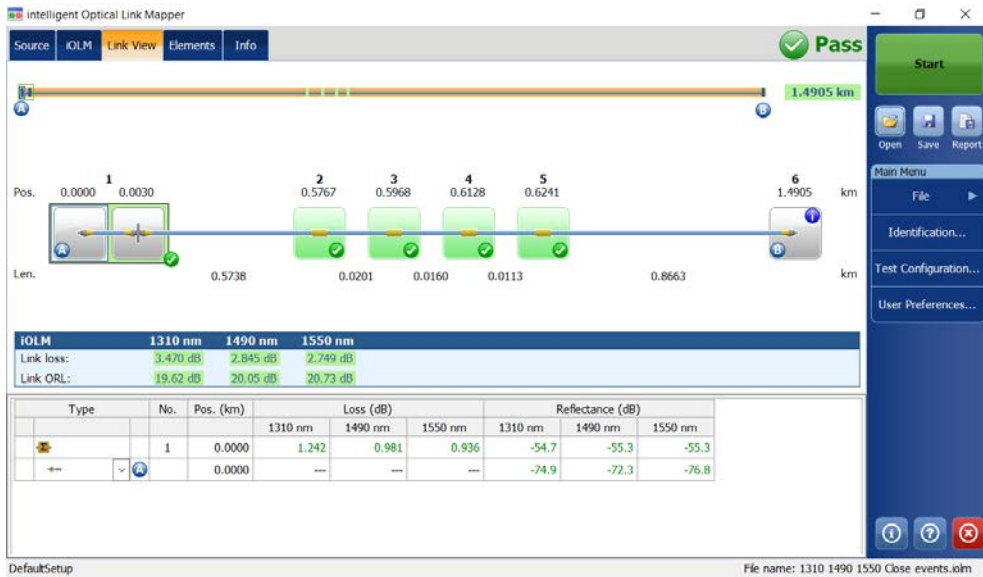

Copyright © 2011–2023 EXFO Inc. All rights reserved. No part of this publication may be reproduced, stored in a retrieval system or transmitted in any form, be it electronically, mechanically, or by any other means such as photocopying, recording or otherwise, without the prior written permission of EXFO Inc. (EXFO).

Information provided by EXFO is believed to be accurate and reliable. However, no responsibility is assumed by EXFO for its use nor for any infringements of patents or other rights of third parties that may result from its use. No license is granted by implication or otherwise under any patent rights of EXFO.

EXFO's Commerce And Government Entities (CAGE) code under the North Atlantic Treaty Organization (NATO) is 0L8C3.

The information contained in this publication is subject to change without notice.

Trademarks

EXFO's trademarks have been identified as such. However, the presence or absence of such identification does not affect the legal status of any trademark.

Where applicable, the Bluetooth[®] word mark and logos are registered trademarks owned by Bluetooth SIG, Inc. and any use of such marks by EXFO Inc. is under license. Where applicable, the MTP[®] mark is a registered trademark of US Conec Ltd. Other third party trademarks and trade names are those of their respective owners.

Units of Measurement

Units of measurement in this publication conform to SI standards and practices.

Patents

The exhaustive list of patents is available at EXFO.com/patent.

Version number: 32.0.1.1

Contents

Regulatory Information	vii
1 Introducing the intelligent Optical Link Mapper	1
Principles of Operation	7
Testing Modes	8
Exporting Data to Other Formats	8
Performing Multimode Measurements	9
Launch, Receive, and Loop Fibers	10
Software Options	14
Using Your Unit with TestFlow	15
Technical Specifications	15
Conventions	16
2 Safety Information	17
General Safety Information	17
Laser Safety Information for FTB-7000/FTB-700Gv2 Series (Units without VFL)	19
Laser Safety Information for FTBx-/MAX-700C/D Series (Units without VFL)	21
Laser Safety Information for FTBx-740C DWOCC and MAX-740C DWOCC Modules (Units without VFL)	23
Laser Safety Information for FTB-7000 Series (Units with VFL)	24
Laser Safety Information for MAX-700C and MAX-700D Series (Units with VFL)	25
Laser Safety Information for FTBx-740C DWOCC and MAX-740C DWOCC Modules (Units with VFL)	26
Laser Safety Information for MAX-700B Series	27
Electrical Safety Information	28
3 Getting Started With Your iOLM	29
Main Window	29
Status Bar	30
Connecting an Optical Switch to the iOLM	31
4 Preparing Your iOLM for a Test	33
Cleaning and Connecting Optical Fibers	33
Installing the EXFO Universal Interface (EUI)	35
Naming Trace Files Automatically	36
Reverting to Factory Settings	41
Configuring Your iOLM	42
Enabling or Disabling the Cumulative Loss	58
Enabling or Disabling the Automated Acquisition Sequence	59

Contents

- 5 Working With the DWDM Module 63**
 - Main Features 63
 - Selecting a Channel Filter 64
 - Selecting a Channel 65
 - Managing Favorite Channels 66
 - Testing Channels Sequentially 69
 - Performing Live-Fiber Testing 71

- 6 Working With the CWDM Module 73**
 - Main Features 73
 - Selecting a Channel Filter 74
 - Selecting a Channel 75
 - Managing Favorite Channels 76
 - Testing Channels Sequentially 79
 - Detecting Macrobends on Fiber Links 81
 - Performing Live-Fiber Testing 84
 - Understanding Fiber Water Peak 84

- 7 Managing Test Configurations 85**
 - Impacts of Test Configurations 86
 - Selecting a Test Configuration 87
 - Creating a Test Configuration 89
 - Setting the Test Configuration Properties 91
 - Defining the Link for Your Test 98
 - Selecting Certification Standards 119
 - Setting Custom Power Meter Thresholds 128
 - Modifying a Test Configuration 129
 - Importing a Test Configuration 130
 - Exporting a Test Configuration 132
 - Deleting a Test Configuration 134

- 8 Performing Acquisitions 137**
 - Performing a Standard or Loopback Acquisition 137
 - Performing a Bidirectional Loopback Acquisition 139
 - Stopping an Acquisition 143
 - Monitoring Fibers in Real-Time Mode 144

9 Customizing Your iOLM	147
Setting the Default Storage Folder	147
Saving Files in Bellcore Format	148
Customizing Reports	150
Activating the Automated Report Creation	151
Enabling or Disabling Sound Notifications	153
Displaying or Hiding Fiber Sections	154
Selecting the Distance Units	155
Enabling or Disabling the Automatic Storage of the Files	156
10 Understanding Diagnostics	159
11 Using the Inline Power Meter (Optional on Some Models)	161
Understanding the Inline Power Meter	161
Setting Custom Power Meter Thresholds	163
Selecting the Measurement Mode	165
Measuring Power Levels	167
Performing an iOLM Acquisition with a Power Meter	169
12 Using Your Module as a Source	171
13 Analyzing and Managing Results	175
Viewing Results in the Link View	175
Viewing Results of Elements and Fiber Section Details	195
Editing Element Types	197
Managing Elements and Analyzing Links	199
Viewing .SOR Traces in the OTDR Viewer	206
Viewing Measurement Information	207
Viewing Multifiber Results	208
14 Managing Files	211
Opening Files	211
Saving Files	212
Exporting Files to the Bellcore Format	214
Generating a Report	215
15 Maintenance	217
Cleaning EUI Connectors	218
Cleaning Optical Connectors Using a Mechanical Cleaner	220
Verifying the Optical Output of Your Unit	221
Determining the Condition of the Click-Out Optical Connector	226
Replacing the Click-Out Optical Connector	228
Recalibrating the Unit	232
Recycling and Disposal	233

Contents

16 Troubleshooting	235
Viewing Online Documentation	235
Contacting the Technical Support Group	235
Viewing Information About Your iOLM	236
Transportation	236
17 Warranty	237
General Information	237
Gray Market and Gray Market Products	238
Liability	239
Exclusions	239
Certification	239
Service and Repairs	240
EXFO Service Centers Worldwide	241
A Automating Bidirectional Acquisitions	243
Index	263

Regulatory Information

USA Electromagnetic Interference Regulatory Statement

Electronic test and measurement equipment is exempt from FCC part 15, subpart B compliance in the United States of America. However, EXFO Inc. makes reasonable efforts to ensure compliance to the applicable standards.

The limits set by these standards are designed to provide reasonable protection against harmful interference when the equipment is operated in a commercial environment. This equipment generates, uses, and can radiate radio frequency energy and, if not installed and used in accordance with the user documentation, may cause harmful interference to radio communications. Operation of this equipment in a residential area is likely to cause harmful interference in which case the user will be required to correct the interference at his own expense.

Modifications not expressly approved by the manufacturer could void the user's authority to operate the equipment.

Canada Electromagnetic Interference Regulatory Statement

This equipment generates, uses, and can radiate radio frequency energy and, if not installed and used in accordance with the instruction manual, may cause harmful interference to radio communications. Operation of this equipment in a residential area is likely to cause harmful interference.

Cet équipement génère, utilise et peut émettre de l'énergie radio-fréquence et, s'il n'est pas installé et utilisé conformément à la documentation de l'utilisateur, il peut occasionner une interférence néfaste aux communications radio. L'utilisation de cet équipement dans une zone résidentielle est susceptible d'occasionner une interférence néfaste.

Regulatory Information

Caution: This equipment is not intended for use in residential environments and may not provide adequate protection to radio reception in such environments.

Attention : Cet appareil n'est pas destiné à être utilisé dans des environnements résidentiels et peut ne pas assurer la protection adéquate à la réception radioélectrique dans ce type d'environnements.

This is a class A, group 1 product.

Ceci est un produit de classe A, groupe 1.

- **Class A equipment:** Equipment that is, by virtue of its characteristics, highly unlikely to be used in a residential environment, including a home business shall be classified as class A and shall comply with the class A limits specified in the applicable ICES standard. Characteristics considered in this assessment include price, marketing and advertising methodology, the degree to which the functional design inhibits applications suitable to residential environments, or any combination of features that would effectively preclude the use of such equipment in a residential environment.

Classe A : Matériel qui, en raison de ses caractéristiques, ne sera fort probablement pas utilisé dans un milieu domiciliaire ni par des entreprises établies à domicile. Parmi les caractéristiques considérées dans cette évaluation, il y a le prix, les méthodes de commercialisation et de publicité, la mesure dans laquelle les fonctions de l'appareil font qu'il ne se prête pas à des applications convenant au milieu domiciliaire ou toute combinaison de ces caractéristiques qui aurait pour conséquence d'en prévenir effectivement l'utilisation à domicile. Utilisé également pour indiquer les limites d'émission correspondantes qui s'appliquent à un tel matériel.

- **Class B equipment:** Equipment that cannot be classified as Class A shall comply with the Class B limits specified in the applicable ICES standard.

Classe B : Matériel qui ne peut pas être inclus dans la classe A. Utilisé également pour indiquer les limites d'émission correspondantes qui s'appliquent à un tel matériel.

- Group 1 equipment: group 1 contains all equipment which is not classified as group 2 equipment, and includes equipment such as laboratory and scientific equipment, industrial process, measurement and control equipment.

Group 2 equipment: group 2 contains all ISM RF equipment in which radio-frequency energy in the frequency range 9 kHz to 400 GHz is intentionally generated and used or only used locally, in the form of electromagnetic radiation, inductive and/or capacitive coupling, for the treatment of material for inspection/analysis purposes, or for transfer of electromagnetic energy.

Appareils du groupe 1 : le groupe 1 réunit tous les appareils compris dans le domaine d'application de la présente Norme, qui ne sont pas classés comme étant des appareils du groupe 2. Le groupe 1 inclut les appareils scientifiques et de laboratoire, les processus industriels, appareils de mesure ou de contrôle.

Appareils du groupe 2 : le groupe 2 réunit tous les appareils ISM à fréquences radioélectriques dans lesquels de l'énergie à fréquences radioélectriques dans la plage de fréquences comprises entre 9 kHz et 400 GHz est produite et utilisée volontairement ou uniquement utilisée localement sous forme de rayonnement électromagnétique, de couplage inductif et/ou capacitif, pour le traitement de la matière, à des fins d'examen ou d'analyse ou pour le transfert d'énergie électromagnétique.

Supplier's Declaration of Conformity (SDoC)

The SDoC for your product is as follows:

CAN ICES-001 (A) / NMB-001 (A)

EU and UK Electromagnetic Compatibility Regulatory Statement

Warning: This is a class A product. In a domestic environment, this product may cause radio interference in which case the user may be required to take adequate measures. Your product is suitable for use in industrial electromagnetic environments.

Simplified EU and UK Declaration of Conformity

The full text of the declaration of conformity is available at the following Internet address: *www.exfo.com/en/resources/legal-documentation*.

EU Economic Operator

EXFO Solutions SAS
2, rue Jacqueline Auriol,
Saint-Jacques-de-la-Lande,
35091 Rennes Cedex 9
FRANCE

1 **Introducing the intelligent Optical Link Mapper**

The intelligent Optical Link Mapper (iOLM) is an optimized application for access/FTTx network characterization. This OTDR-based application uses multipulse acquisitions and advanced algorithms to deliver detailed information on every element on the link.

Depending on the type of acquisition you want to perform and the environment you are working in, different modules are available for your tests:

- The standard iOLM uses advanced algorithms that dynamically define the testing parameters, as well as the number of acquisitions that best fit the network under test. As soon as the trace is analyzed, all results are combined into a single link view. Specific diagnostics are also provided to help you with the troubleshooting process.
- The MAX/FTBx-740C-DWx module allows you to perform specific acquisitions using the DWDM (dense wavelength-division multiplexing) technology in the C-band and is designed to test through field mux/demux channels. This high-resolution particular type of module provides complete end-to-end link characterization and helps troubleshooting metro Ethernet links as well as commercial services. See *Working With the DWDM Module* on page 63 for details.
- The MAX/FTBx-740C-CW module covers up to 18 CWDM ITU channels, from 1270 nm to 1610 nm (with a channel spacing of 20 nm), and is designed to test through field mux/demux channels. This high-resolution particular type of CWDM (coarse wavelength-division multiplexing) module provides complete end-to-end link characterization and helps troubleshooting commercial, C-RAN networks as well as metro Ethernet links deployments. See *Working With the CWDM Module* on page 73 for details.

Introducing the intelligent Optical Link Mapper

The iOLM module can be equipped optionally with an inline power meter. The power meter is called inline because the acquisition is done using the SM live port used for iOLM measurements. Optionally, you can measure the power levels for two wavelengths in a single acquisition if two wavelengths are used for testing. See *Using the Inline Power Meter (Optional on Some Models)* on page 161 for details.

Note: *Depending on the model and options you have purchased, some features may not be available.*

Note: *In this documentation, the words “tap” and “double-tap” (related to the use of a touchscreen) replace the words “click” and “double-click”.*

FTB-7000 Series for FTB-2/FTB-2 Pro and FTB-4 Pro

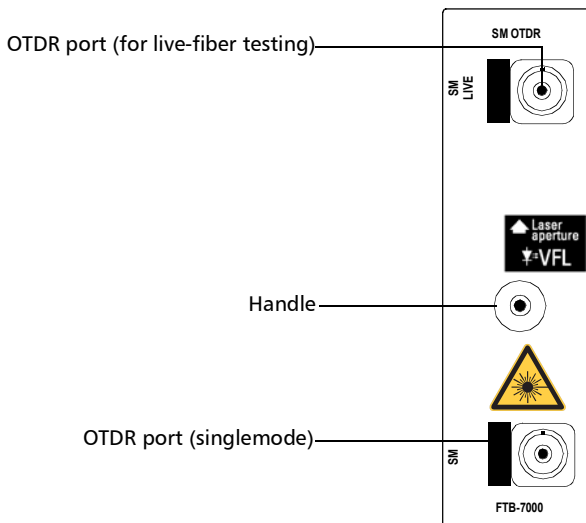

Singlemode and singlemode live models

Introducing the intelligent Optical Link Mapper

MAX-700B Series

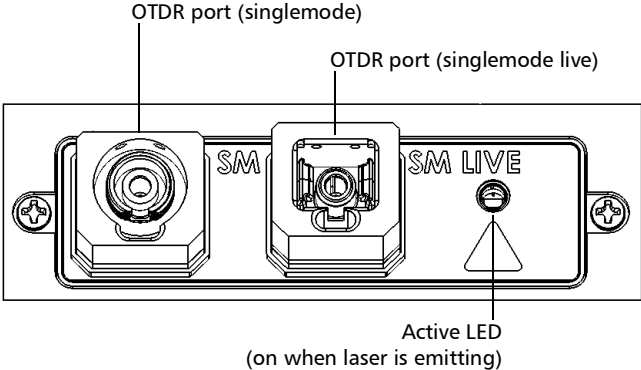

FTB-700C Series, MAX-700C Series, FTB-700Gv2 Series, and FTBx-700C Series

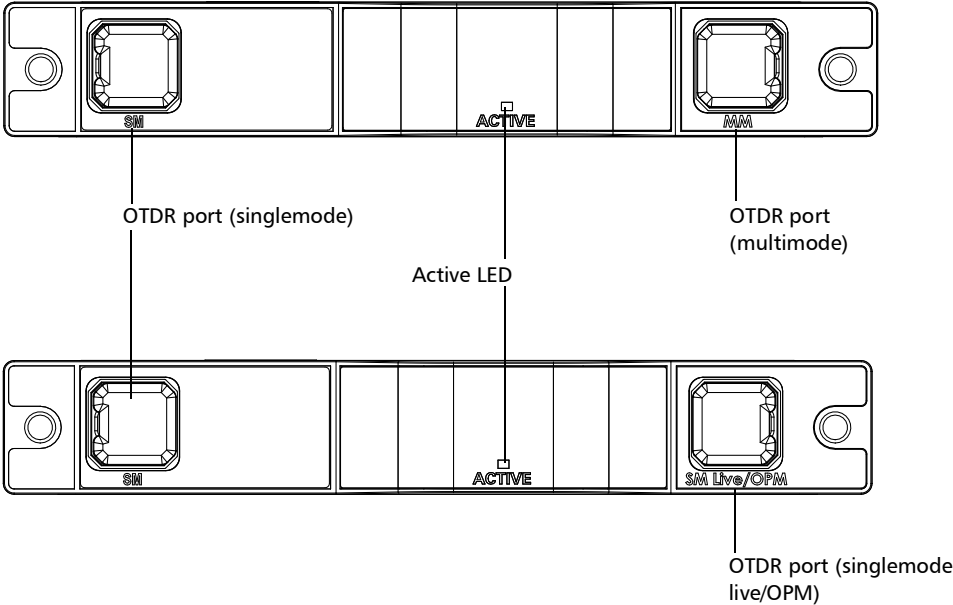

Introducing the intelligent Optical Link Mapper

FTBx-740C

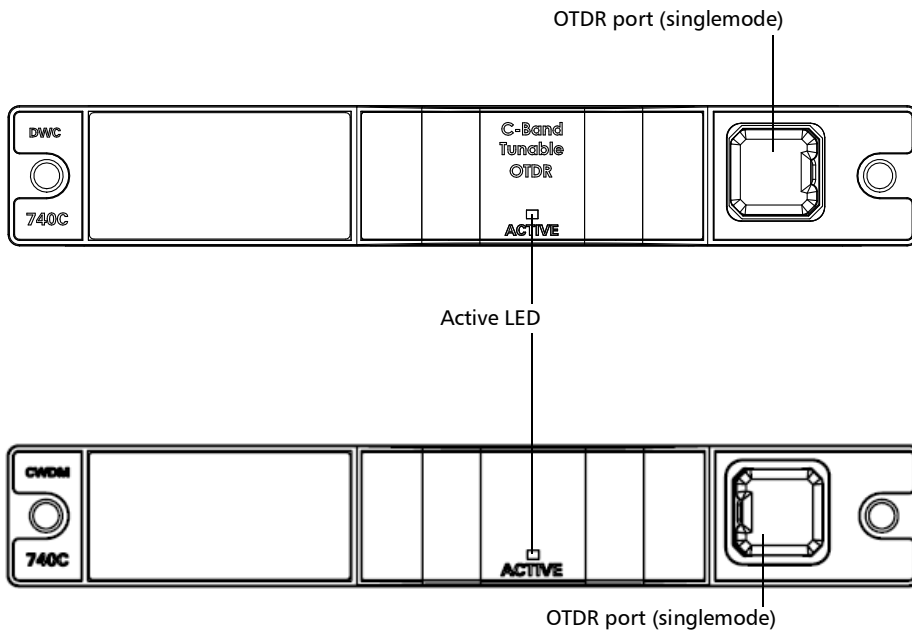

Introducing the intelligent Optical Link Mapper

MAX/FTBx-740C DWOCC

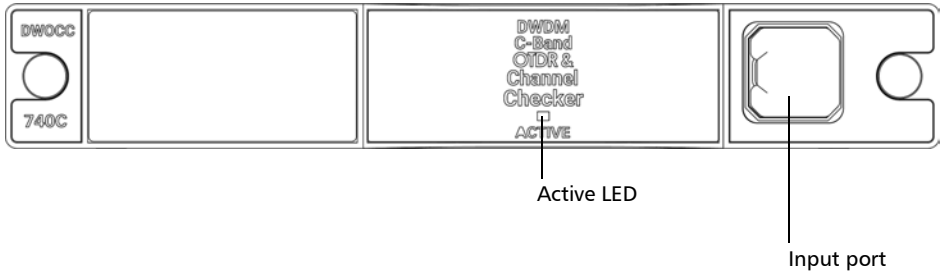

FTBx-730C-SM7-TAM

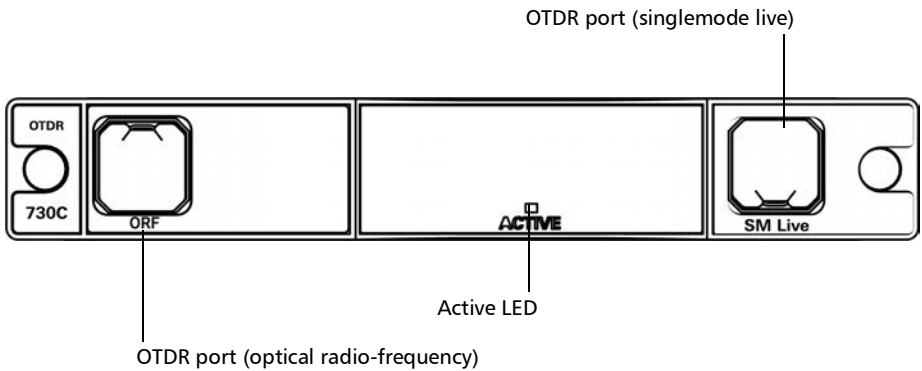

Introducing the intelligent Optical Link Mapper

FTB-700D Series, MAX-700D Series, FTB-700Gv2 Series, and FTBx-700D Series

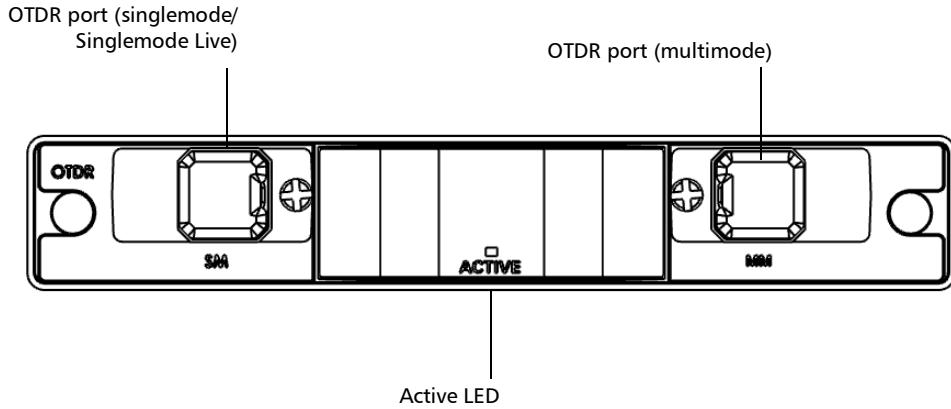

FTB/FTBx-750D Series

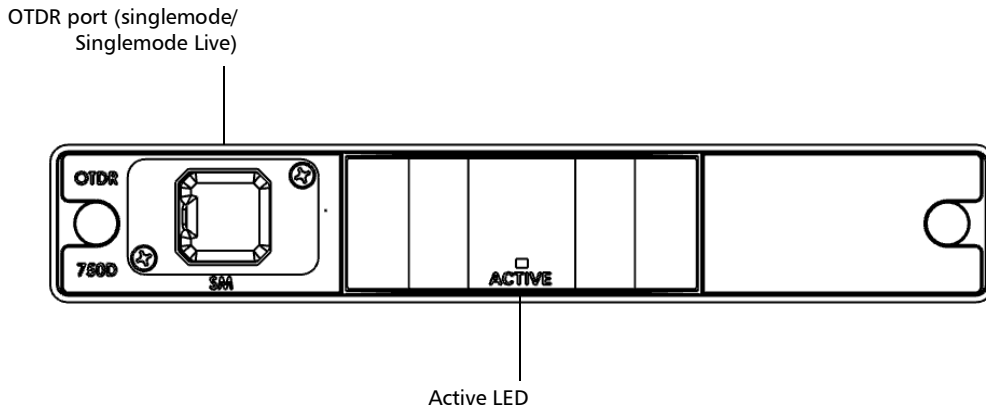

Principles of Operation

The iOLM application uses the hardware of an EXFO OTDR to perform acquisitions and characterize the various elements detected on the probed link. However, while a regular OTDR takes one averaged trace at a time with one given set of test parameters, the iOLM takes a series of measurements and integrates them into a simple and intuitive link view.

The test parameters for each sub-measurement are determined by smart algorithms during the measurement. Just as each link is different, each iOLM measurement is different, with its own set of test parameters according to the link length, loss, and ORL. Test time varies depending on the link tested, but is mostly influenced by total link loss. The application uses information from all sub-measurements to enhance the characterization of each element found on the link, yielding accurate and complete results. Depending on the module configuration, you can perform a single or multiple-wavelength acquisition. In the latter case, results will be provided for each wavelength, and a global pass/fail status for each element is displayed.

The application summarizes the results in a linear representation of the link, displaying each element with its associated position, loss and reflectance, as well as the element type.

Testing Modes

There are basically two ways to use the iOLM:

- **Standard:** The acquisitions and analysis processes are designed for general fiber testing such as short links, long haul or PONs.
- **Optimode:** Depending on the module you are using, different Optimode test configurations are available. The IADV software option gives you access to different Optimodes.

Optimode is a test configuration using an algorithm intended for specific use cases, which overpass the iOLM standard mode performances in given testing topologies. It is designed to meet performance and certification requirements of specific applications. Trace acquisitions and analyses are optimized for speed, accuracy, detection sensitivity with specific test parameters such as link length, link loss, splitters, and so on. Refer to the iOLM technical specifications for the Optimodes available and their corresponding specifications. You can also contact EXFO to ensure the Optimode is designed for your use cases. See *Selecting a Test Configuration* on page 87 for details.

Exporting Data to Other Formats

The iOLM application can generate reports in PDF format and allow batch post-processing of the measurements. The test configuration files can be created from EXFO's FastReporter and imported into each test unit.

Performing Multimode Measurements

If your module supports multimode measurements, it can test both 62.5 μm and 50 μm fibers. The internal multimode fiber for an EXFO OTDR is 62.5 μm .

- When a 62.5 μm fiber is connected, the loss at the connector can be correctly characterized just as it is the case for a singlemode fiber. It is then simple to evaluate a pass/fail criterion in this case.
- When a 50 μm fiber is connected, the loss at the connector depends on many factors:
 - the connector loss itself
 - the 62.5 μm to 50 μm core fiber difference
 - the RBS difference between 50 μm and 62.5 μm fibers

The measured loss between the OTDR connector and the fiber is typically around 3.3 dB.

With 50 μm fibers, since the connector loss measurement at the OTDR is imprecise because of major other factors, the iOLM excludes the first connector from the link to avoid providing inaccurate information.

When characterizing a multimode link or a singlemode fiber, launch fibers are recommended. In multimode, the launch and receive fibers must have the same core size as the link under test. Using an unfitting launch or receive fiber would lead to inaccurate results.

The use of an external EF-compliant device such as the SPSB-EF-C30 will ensure a fast and easy way to get accurate loss measurements. For more information about encircled flux compliance, refer to the encircled flux test solution specification sheet.

Launch, Receive, and Loop Fibers

In addition to the fiber under test, there is a launch and receive fiber. Sometimes, a loop fiber can be used to test two fibers at a time.

You can have the iOLM application measure the launch and receive cable lengths automatically or you can enter the values manually. Regardless of the method you use, you have to set the length of the loop fiber manually. See *Configuring Your iOLM* on page 42 for details.

After the values are set, the application will perform a calibration during which it does a fast measurement and evaluates the length of the fiber. For this reason, you must connect only the cable under test to the module at this point.

If link elements are found on the fiber under calibration or if the OTDR connector is defective, the calibration will fail and a warning is displayed to explain the reason for the failure. A short patchcord (<5 m) is accepted between the instrument and the fiber under calibration and will be included in the calibrated length.

When performing a measurement, the iOLM will try to match the defined launch and receive fibers with elements found on the link to set the A and B connector positions. If no events are found at specified distances because of a “perfect” connection between the link and launch or receive fibers, the iOLM will insert an element at a specified position (with zero loss and ORL).

Launch Fibers

Unlike a traditional OTDR, the iOLM requires only a short launch fiber (>50 m) to benefit from all the advantages of this referencing method, regardless of the link length and loss. A launch fiber longer than 200 m is not recommended when testing PON links. Because the output port of an OTDR may degrade its loss and ORL performances after multiple connections, the use of a launch cable is always recommended.

The first element of the tested link is tagged with the letter (A) into the link view. A launch cable allows you to properly characterize the first connector of the fiber link under test (A) and exclude the OTDR connector's wear from the link evaluation. A reasonable amount of degradation of the OTDR connector is acceptable when using an APC interface; the ORL remains low due to the angle polish, preventing poor near-end resolution. By using a launch fiber, the OTDR connector loss is excluded from the measurement. The iOLM evaluates the OTDR connector loss each time a measurement is performed to inform you about the condition of the connector. It is important to understand that excessive loss at this connector will eventually degrade the measurement capabilities of the instrument. In addition, using a launch cable will help protect your OTDR connector by limiting the number of connections performed directly on that connector. It is easier to repair or replace a launch cable than to replace the OTDR connector.

Introducing the intelligent Optical Link Mapper

Launch, Receive, and Loop Fibers

Receive Fibers

The last element of the tested link is tagged with the letter (B) into the link view. A receive fiber cable can be used at the end of the link opposite the test module in order to characterize the last connector of the link (B) and increase the precision of the total insertion loss result by comparing differential level of two known fibers (to avoid errors due to different backscatter coefficients of the fiber used in the link). If no receive cable is used, the iOLM application will be able to measure the position and ORL of this connector in unmatched condition, but not its loss. No pass/fail status will be displayed for that connector. The required length of the receive fiber will depend on the loss of the link under test. A higher loss requires a longer pulse to reach the receive fiber level. Unlike the launch fiber, the receive fiber has the same limitations than that of a traditional OTDR. Testing a 1 km fiber span with less than 2 dB of loss will require only 100 m of receive fiber. Testing a 23 dB PON link will require a receive fiber of 500 m to 2 km, depending on the fiber length after each splitter.

Loop Fibers

The loopback measurement modes are designed to test duplex cables and save test time by measuring two fibers at a time.

In the loopback measurement modes, one end of the first fiber is connected to the iOLM through a launch fiber, while the other end is connected to the second fiber using a fiber called a loop. Usually, a receive fiber is used on the proximal end of the second fiber. The loop fiber can be viewed as a receive fiber for the first fiber (the one the iOLM is connected to) and a launch fiber for the second fiber.

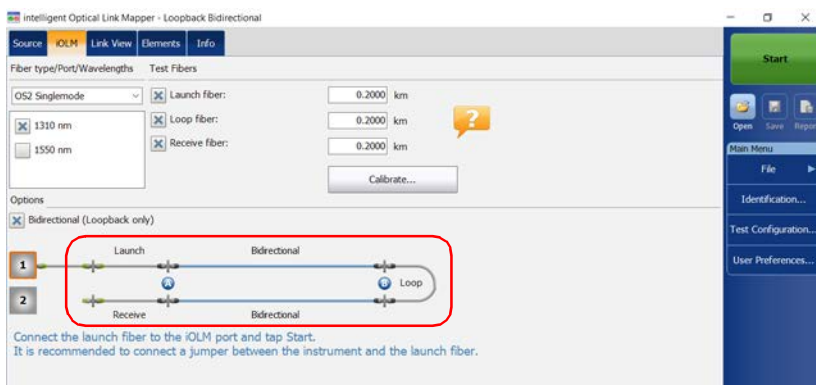

The automatic split of the initial measurement can only be performed if the length of the launch, loop and receive fibers are properly specified in the application. See *Configuring Your iOLM* on page 42 for details.

Software Options

Software options are offered with your unit.

- IOLM: gives you access to the iOLM application.
- QUAD: activates singlemode wavelengths on units.
- IADV: offers many features designed for advanced users.
- ILOOP: allows you to perform unidirectional and bidirectional iOLM loopback measurements, which consist in looping two fibers together at one end to test both of them at once.
Unidirectional loopback measurements test both fibers at once and evaluate them separately, whereas bidirectional loopback measurements pair two measurements automatically (A -> B, B-> A) and then generates the bidirectional measurement for the two fibers.
- IPRO: includes the IADV option. It offers all of the iOLM features.
- ICERT: gives you access to a list of certification standards you can apply to different test configurations; these will give you a pass/fail status based on industry standards. Since the thresholds cannot be edited, you are ensured of reliable pass/fail results each time.
- The CWDM-10W option enables 10 wavelengths in the 1430 nm - 1610 nm range.
- The CWDM-18W option enables the 18 wavelengths available.
- The CWDM-8W option enables 8 wavelengths in the 1470 nm - 1610 nm range.
- The M-1310W option enables the 1310 nm wavelength.

Using Your Unit with TestFlow

You can use this product for your test jobs in the TestFlow application. For more information about using TestFlow or other instruments as part of your tests, refer to the corresponding user documentation.

Note: *Some of the features for your product are not available while in TestFlow mode.*

Technical Specifications

To obtain this product's technical specifications, visit the EXFO Web site at www.exfo.com.

Conventions

Before using the product described in this guide, you should understand the following conventions:



WARNING

Indicates a potentially hazardous situation which, if not avoided, could result in *death or serious injury*. Do not proceed unless you understand and meet the required conditions.



CAUTION

Indicates a potentially hazardous situation which, if not avoided, may result in *minor or moderate injury*. Do not proceed unless you understand and meet the required conditions.



CAUTION

Indicates a potentially hazardous situation which, if not avoided, may result in *component damage*. Do not proceed unless you understand and meet the required conditions.



IMPORTANT

Refers to information about this product you should not overlook.

2 **Safety Information**

General Safety Information



WARNING

Do not install or terminate fibers while a light source is active. Never look directly into a live fiber and ensure that your eyes are protected at all times.



WARNING

The use of controls, adjustments and procedures, namely for operation and maintenance, other than those specified herein may result in hazardous radiation exposure or impair the protection provided by this unit.



WARNING

If the equipment is used in a manner not specified by the manufacturer, the protection provided by the equipment may be impaired.



WARNING

Use only accessories designed for your unit and approved by EXFO. For a complete list of accessories available for your unit, refer to its technical specifications or contact EXFO.



IMPORTANT

Refer to the documentation provided by the manufacturers of any accessories used with your EXFO product. It may contain environmental and/or operating conditions limiting their use.

Safety Information

General Safety Information



IMPORTANT

When you see the following symbol on your unit , make sure that you refer to the instructions provided in your user documentation. Ensure that you understand and meet the required conditions before using your product.



IMPORTANT

When you see the following symbol on your unit , it indicates that the unit is equipped with a laser source, or that it can be used with instruments equipped with a laser source. These instruments include, but are not limited to, modules and external optical units.



IMPORTANT

Other safety instructions relevant for your product are located throughout this documentation, depending on the action to perform. Make sure to read them carefully when they apply to your situation.

Laser Safety Information for FTB-7000/FTB-700Gv2 Series (Units without VFL)

Your instrument is in compliance with standards IEC 60825-1: 2007 and 2014.



WARNING

(IEC 60825-1: 2007) Viewing the laser output with certain optical instruments designed for use at a distance (for example, telescopes and binoculars) may pose an eye hazard.



WARNING

(IEC 60825-1: 2014) Viewing the laser output with telescopic optical instruments (for example, telescopes and binoculars) may pose an eye hazard and thus the user should not direct the beam into an area where such instruments are likely to be used.

Laser radiation may be encountered at the optical output port.

The following labels indicate that the product contains a Class 1M source:

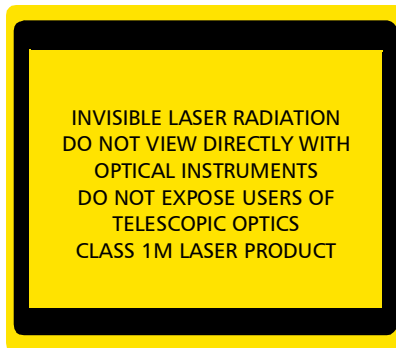

Safety Information

Laser Safety Information for FTB-7000/FTB-700Gv2 Series (Units without VFL)

Wavelength: / Longueur d'onde : 800-1300 nm

Pulse width: / Largeur de l'impulsion : $\tau \leq 1 \mu\text{s}$

Max. peak power: / Puissance crête maximum : $P \leq 500 \text{ mW}$

Wavelength: / Longueur d'onde : 1250-1400 nm

Pulse width: / Largeur de l'impulsion : $\tau \leq 20 \mu\text{s}$

Max. peak power: / Puissance crête maximum : $P \leq 260 \text{ mW}$

Wavelength: / Longueur d'onde : 1400-1700 nm

Pulse width: / Largeur de l'impulsion : $\tau \leq 20 \mu\text{s}$

Max. peak power: / Puissance crête maximum : $P \leq 600 \text{ mW}$

Complies with standards 21 CFR 1040.10, except for deviations pursuant to Laser Notice No. 50, dated June 24, 2007.

Laser Safety Information for FTBx-/MAX-700C/D Series (Units without VFL)

Your instrument is in compliance with standard IEC 60825-1: 2014.



WARNING

Viewing the laser output with telescopic optical instruments (for example, telescopes and binoculars) may pose an eye hazard and thus the user should not direct the beam into an area where such instruments are likely to be used.

Laser radiation may be encountered at the optical output port.

The following label indicates that the product contains a Class 1M source:



INVISIBLE LASER RADIATION
DO NOT VIEW DIRECTLY WITH OPTICAL INSTRUMENTS
DO NOT EXPOSE USERS OF TELESCOPIC OPTICS
CLASS 1M LASER PRODUCT

RAYONNEMENT LASER INVISIBLE
NE PAS OBSERVER DIRECTEMENT À L'AIDE D'INSTRUMENTS D'OPTIQUE
NE PAS EXPOSER LES UTILISATEURS DE DISPOSITIF OPTIQUE
TÉLESCOPIQUE
APPAREIL À LASER DE CLASSE 1M

Safety Information

Laser Safety Information for FTBx-/MAX-700C/D Series (Units without VFL)

Wavelength: / Longueur d'onde : 800-1300 nm

Pulse width: / Largeur de l'impulsion : $\tau \leq 1 \mu\text{s}$

Max. peak power: / Puissance crête maximum : $P \leq 200 \text{ mW}$

Duty cycle: / Cycle de service : $\leq 1 \%$

Fiber type: / Type de fibre : Multimode/Multimode

Fiber core: / Cœur de la fibre : $62.5 \mu\text{m}$

Fiber numerical aperture: / Ouverture numérique de la fibre : 0.275

Wavelength: / Longueur d'onde : 1250-1700 nm

Pulse width: / Largeur de l'impulsion : $\tau \leq 20 \mu\text{s}$

Max. peak power: / Puissance crête maximum : $P \leq 275 \text{ mW}$

Duty cycle: / Cycle de service : $\leq 1 \%$

Fiber type: / Type de fibre : Single-mode / Monomode

Fiber core: / Cœur de la fibre : $9 \mu\text{m}$

Fiber numerical aperture: / Ouverture numérique de la fibre : 0.14

Complies with FDA performance standards for laser products except for conformance with IEC 60825-1 Ed. 3, as described in Laser Notice No. 56, dated May 8, 2019.

Laser Safety Information for FTBx-740C DWOCC and MAX-740C DWOCC Modules (Units without VFL)

Your instrument is in compliance with standard IEC 60825-1: 2014.



WARNING

Viewing the laser output with telescopic optical instruments (for example, telescopes and binoculars) may pose an eye hazard and thus the user should not direct the beam into an area where such instruments are likely to be used.

Laser radiation may be encountered at the optical output port.

The following label indicates that the product contains a Class 1M source:



INVISIBLE LASER RADIATION
DO NOT VIEW DIRECTLY WITH OPTICAL INSTRUMENTS
DO NOT EXPOSE USERS OF TELESCOPIC OPTICS
CLASS 1M LASER PRODUCT

RAYONNEMENT LASER INVISIBLE
NE PAS OBSERVER DIRECTEMENT À L'AIDE D'INSTRUMENTS D'OPTIQUE
NE PAS EXPOSER LES UTILISATEURS DE DISPOSITIF OPTIQUE
TÉLESCOPIQUE
APPAREIL À LASER DE CLASSE 1M

Safety Information

Laser Safety Information for FTB-7000 Series (Units with VFL)

Wavelengths: / Longueurs d'onde : 1525-1570 nm

Pulse width: / Largeur de l'impulsion : $\tau \leq 20 \mu s$

Max. peak power: / Puissance crête maximum : $P \leq 600 \text{ mW}$

Complies with FDA performance standards for laser products except for conformance with IEC 60825-1 Ed. 3, as described in Laser Notice No. 56, dated May 8, 2019.

Laser Safety Information for FTB-7000 Series (Units with VFL)

Your instrument is in compliance with standards IEC 60825-1: 2007 and 2014.

Laser radiation may be encountered at the output port. It is potentially harmful in direct intrabeam viewing.

The following label(s) indicate that the product contains a Class 3R source:



— Affixed to module's side panel

Complies with standards 21 CFR 1040.10, except for deviations pursuant to Laser Notice No. 50, dated June 24, 2007.

Laser Safety Information for MAX-700C and MAX-700D Series (Units with VFL)

Your instrument is in compliance with standard IEC 60825-1: 2014.

Laser radiation may be encountered at the optical output port.

The following label(s) indicate that the product contains a Class 2 source:

The following symbol means
"DO NOT STARE INTO THE BEAM".

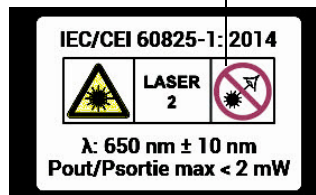

Affixed to the back of the unit.

Complies with FDA performance standards for laser products except for conformance with IEC 60825-1 Ed. 3, as described in Laser Notice No. 56, dated May 8, 2019.

Safety Information

Laser Safety Information for FTBx-740C DWOCC and MAX-740C DWOCC Modules (Units with VFL)

Laser Safety Information for FTBx-740C DWOCC and MAX-740C DWOCC Modules (Units with VFL)

Your instrument is in compliance with standard IEC 60825-1: 2014.

Laser radiation may be encountered at the optical output port.

The following label(s) indicate that the product contains a Class 2 source:

The following symbol means
"DO NOT STARE INTO THE BEAM".

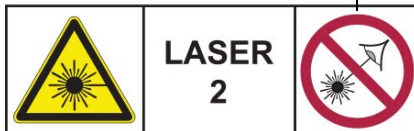

Affixed to module's
back panel

Complies with FDA performance standards for laser products except for conformance with IEC 60825-1 Ed. 3, as described in Laser Notice No. 56, dated May 8, 2019.

Laser Safety Information for MAX-700B Series

Your instrument is in compliance with standards IEC 60825-1: 2007 and 2014.



WARNING

(IEC 60825-1: 2007) Viewing the laser output with certain optical instruments designed for use at a distance (for example, telescopes and binoculars) may pose an eye hazard.



WARNING

(IEC 60825-1: 2014) Viewing the laser output with telescopic optical instruments (for example, telescopes and binoculars) may pose an eye hazard and thus the user should not direct the beam into an area where such instruments are likely to be used.

Laser radiation may be encountered at the optical output port.

The following labels indicate that the product contains a Class 1M source:

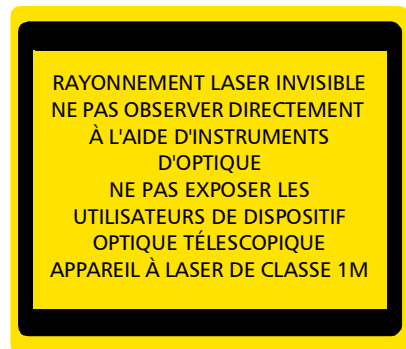
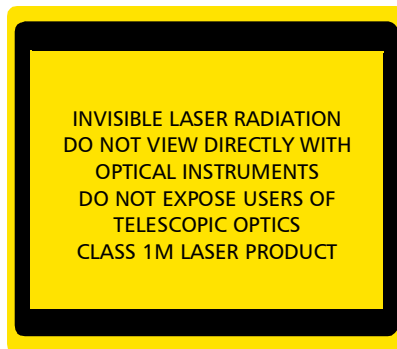

Safety Information

Electrical Safety Information

Wavelength: / Longueur d'onde : 1300-1400 nm

Pulse width: / Largeur de l'impulsion :  $\leq 20 \mu s$

Max. peak power: / Puissance crête maximum :  $\leq 260 \text{ mW}$

Wavelength: / Longueur d'onde : 1400-1700 nm

Pulse width: / Largeur de l'impulsion :  $\leq 20 \mu s$

Max. peak power: / Puissance crête maximum :  $\leq 600 \text{ mW}$

Complies with standards 21 CFR 1040.10, except for deviations pursuant to Laser Notice No. 50, dated June 24, 2007.

Electrical Safety Information

For more information on product safety and equipment ratings, refer to the user documentation of your platform.

The power consumption for all intelligent Optical Link Mapper modules is below 10 W.

3 Getting Started With Your iOLM

Note: Please refer to your platform's or unit's user guide for detailed information regarding inserting and removing test modules, and starting applications.

Note: Some features for this application are enabled when you purchase the corresponding options. For more information on the software options available for your unit, see Software Options on page 14. For details on how to activate an option, refer to your platform's or unit's user guide.

Main Window

The main window allows you to start the acquisition and view measurement results and values.

Function tabs

View pane

Button bar, including shortcuts to access the **Open, Save and Report** menus

Status bar

iOLM		1310 nm	1490 nm	1550 nm
Link loss:		3.470 dB	2.985 dB	2.749 dB
Link ORL:		19.62 dB	20.05 dB	20.73 dB

Type	No.	Pos. (km)	Loss (dB)			Reflectance (dB)		
			1310 nm	1490 nm	1550 nm	1310 nm	1490 nm	1550 nm
+	1	0.0000	1.242	0.981	0.936	-54.7	-55.3	-55.3
		0.0000	---	---	---	-74.9	-72.3	-76.8

Note: Your screen display may differ slightly from the illustrations presented in this user guide depending on the platform you are using.

Status Bar

The status bar, located at the bottom of the main window, identifies the selected configuration file name in the application, acquisition wavelength (when an acquisition is in progress), and the acquisition progress bar of the iOLM. It also displays the next file name according to the autonaming scheme. For more information, see *Naming Trace Files Automatically* on page 36.

Note: *When an acquisition is not in progress, the file name of the file currently present in memory is displayed.*



Name of the current configuration file.

Name of the currently loaded iOLM file. The loaded file name and the next file name turns into a progress bar during the acquisition.

Connecting an Optical Switch to the iOLM

The IPRO software option enables you to perform multifiber iOLM test measurements in singlemode, using an externally controlled MPO optical switch.

With this software option, the MPO optical switch can be used for measurement automation. Since the MPO automation is designed for short MPO links, which are typically found in data centers, Short Link Close Events and Fast Short Link Optimodes are specifically designed for that kind of measurement. However, both Optimodes are limited in range. Refer to the iOLM technical specifications for more details.

The optical switch is used automatically. A USB cable provides the connection between the platform and the optical switch. For more information, see *Configuring Your iOLM* on page 42.

Note: *To allow the iOLM to detect the optical switch, you should use a patchcord shorter than 20 meters to connect the iOLM to the optical port of the switch.*

Getting Started With Your iOLM

Connecting an Optical Switch to the iOLM



IMPORTANT

Handle MPO connectors carefully and always clean them before each connection.

To avoid excessive loss and reflectance, the input and output connectors of the MPO switch must remain in perfect condition.

With these type of connectors, keep the number of connections to a minimum.

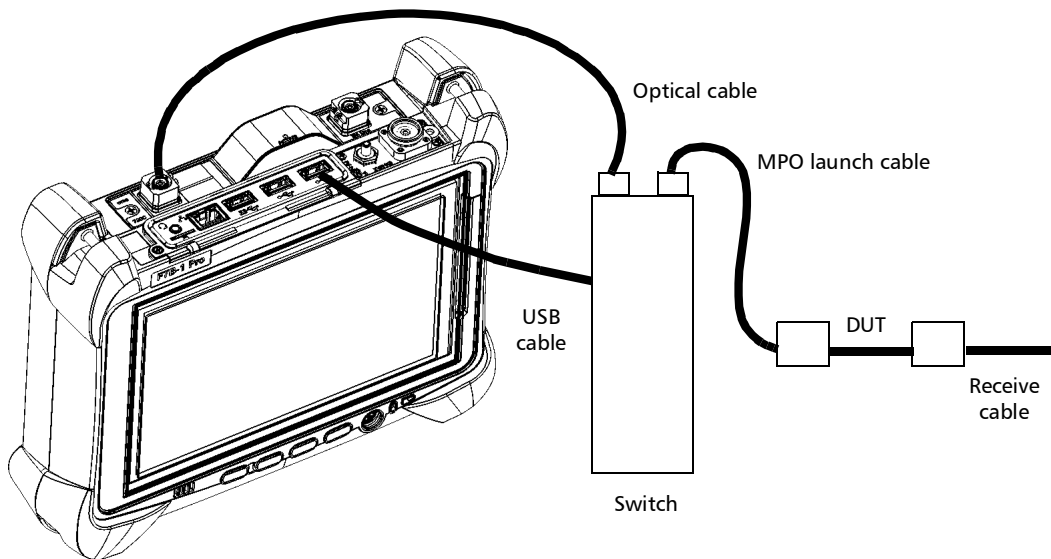

Note: Refer to the user documentation that came with your external switch for more information.

4 **Preparing Your iOLM for a Test**

Cleaning and Connecting Optical Fibers



CAUTION

To ensure maximum power and to avoid erroneous readings:

- Always inspect fiber ends and make sure that they are clean as explained below before inserting them into the port. EXFO is not responsible for damage or errors caused by bad fiber cleaning or handling.
- Ensure that your patchcord has appropriate connectors. Joining mismatched connectors will damage the ferrules.

To connect the fiber-optic cable to the port:

1. Inspect the fiber using a fiber inspection scope (or probe). If the fiber is clean, proceed to connecting it to the port. If the fiber is dirty, clean it as explained below.
2. Clean the fiber ends as follows:
 - 2a. Gently wipe the fiber end with a lint-free swab dipped in optical-grade liquid cleaner.
 - 2b. Use a dry swab to dry the connector completely.
 - 2c. Visually inspect the fiber end to ensure its cleanliness.

Preparing Your iOLM for a Test

Cleaning and Connecting Optical Fibers

3. Carefully align the connector and port to prevent the fiber end from touching the outside of the port or rubbing against other surfaces.

If your connector features a key, ensure that it is fully fitted into the port's corresponding notch.

4. Push the connector in so that the fiber-optic cable is firmly in place, thus ensuring adequate contact.

If your connector features a screw sleeve, tighten the connector enough to firmly maintain the fiber in place. Do not overtighten, as this will damage the fiber and the port.

Note: *If your fiber-optic cable is not properly aligned and/or connected, you will notice heavy loss and reflection.*

EXFO uses good quality connectors in compliance with EIA-455-21A standards.

To keep connectors clean and in good condition, EXFO strongly recommends inspecting them with a fiber inspection scope (or probe) before connecting them. Failure to do so may result in permanent damage to the connectors and degradation in measurements.

Installing the EXFO Universal Interface (EUI)

The EUI fixed baseplate is available for connectors with angled (APC) polishing. A green border around the baseplate indicates that it is for APC-type connectors.

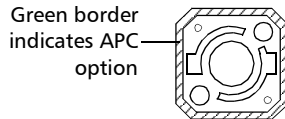

IMPORTANT

EXFO strongly recommends to only use APC module connectors.

To install an EUI connector adapter onto the EUI baseplate:

1. Hold the EUI connector adapter so the dust cap opens downwards.

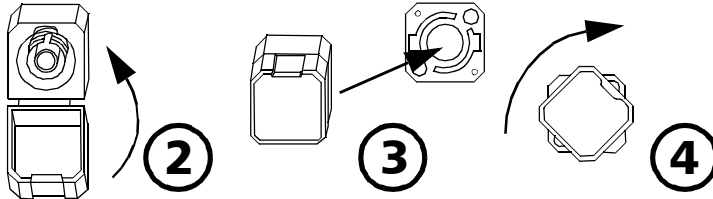

2. Close the dust cap in order to hold the connector adapter more firmly.
3. Insert the connector adapter into the baseplate.
4. While pushing firmly, turn the connector adapter clockwise on the baseplate to lock it in place.

Preparing Your iOLM for a Test

Naming Trace Files Automatically

Naming Trace Files Automatically

The autonaming feature is useful to make a relevant naming scheme for your tests. This also ensures that you do not overwrite measurements by mistake. You can select which item goes in the measurement name, as well as the type of separator you want to use in between.

Note: *The file name has a limit of 260 characters, including the folder name.*

A preview is available to show you the final output of the name.

The measurement name is made of one or more static parts (alphanumeric) and one or more variable parts (numeric) that will be incremented or decremented, as follows:

If you choose incrementation...	If you choose decrementation...
Variable part increases until it reaches the <i>highest possible value</i> with the selected number of digits, then restarts at the indicated start value.	Variable part decreases until it reaches the stop value, then restarts at the <i>highest possible value</i> with the selected number of digits.

Note: *To decrement values, the start number must be higher than the stop number.*

After saving a result, the unit prepares the next file name by incrementing (or decrementing) the suffix.

A measurement can contain more than one files. You can use preset, or custom identifiers to help differentiate the measurements within the file.

Note: *Custom identifiers will be added to the measurement name if a corresponding value is set for them.*

The measurement names can be incremented using one or more identifiers. Selecting a single identifier will follow the incrementation (or decrementation) value you have set.

You can select the number of digits displayed for the incremented or decremented values.

Select "#" if you want to keep the value exactly in the same format as defined in the start and stop values. If a value is to be incremented from 1 to 10, it becomes 1, 2, 3, ... 9, 10. One "#" is the default format.

Select two, three, or four "#" if you want all values to be expressed with the same number of digits. The application fills the empty spaces with zeros before the increment or decrement to ensure the appropriate format is displayed. For example, if you select two "#" and the value is to be incremented from 1 to 10, it becomes 01, 02, 03, ... 09, 10.

The file name can be incremented using one or more identifiers. Selecting a single identifier will follow the incrementation (or decrementation) value you have set.

When selecting more than one identifier, the latter appear sequentially in the order that you have set, and the incrementation will start with the last item in the list (the one with the farthest indentation). For example, if you have a file name with the Location, Cable and Fiber identifiers, in that order, the first item to be incremented is the Fiber identifier, then Cable, then Location:

Location 1, Cable 1, Fiber 1

Location 1, Cable 2, Fiber 1

Location 1, Cable 2, Fiber 2

and so forth.

Note: *If you choose not to save a particular trace file, the suggested file name remains available for the next trace you acquire.*

Preparing Your iOLM for a Test

Naming Trace Files Automatically

This function is particularly useful when testing multiple-fiber cables.

If you deactivate the automatic file naming function, you will need to specify a file name each time you save a result.

The autonaming parameters can be set for current measurements that have not been saved yet.

It is also possible to revert the settings to their default values. See *Reverting to Factory Settings* on page 41 for details.

To configure the automatic file naming:

1. From the **Main Menu**, tap **Identification**.
2. From the **Apply to** list, ensure that **Next acquisition** is selected.

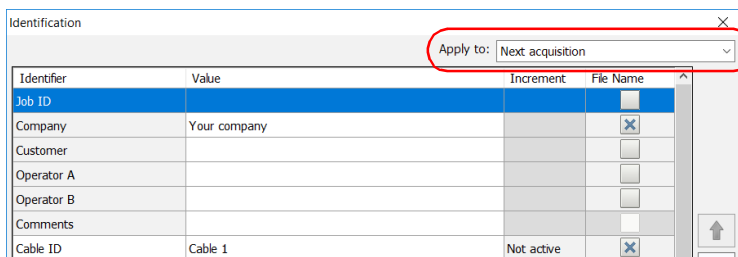

3. Select the desired identifiers to include in the file name. You can change the order of appearance of the highlighted component with the up and down arrow buttons.

Note: You can change the name of some identifiers according to your needs.

Note: When an identifier is set to **None**, its value is cleared and it cannot be edited unless you set it back to another value.

Preparing Your iOLM for a Test

Naming Trace Files Automatically

- Current acquisition: If you are working with standard loopback or bidirectional loopback measurements files, there are two **Value** columns, one for each fiber.
- Next acquisition: only one **Value** column is displayed.

Items that can be included in the file name.

This preview is updated automatically as you make your selections.

To modify the order of appearance of the selected identifiers in the file name.

To select the separator in the automatic numbering section.

To revert to factory settings (not available for the Current acquisition).

Identifier	Value	Increment	File Name
Job ID			<input type="checkbox"/>
Company	Your company		<input type="checkbox"/>
Customer			<input type="checkbox"/>
Operator A			<input type="checkbox"/>
Operator B			<input type="checkbox"/>
Comments			<input type="checkbox"/>
Cable ID	Cable 1	Not active	<input type="checkbox"/>
Fiber ID	Fiber 2	2	<input type="checkbox"/>
Location A		Not active	<input type="checkbox"/>
Location B		Not active	<input type="checkbox"/>
None			<input type="checkbox"/>
Direction	A->B		<input type="checkbox"/>
Custom file name			<input type="checkbox"/>
Wavelength(s)	850 nm		<input type="checkbox"/>

Apply to: Next acquisition

Separator: Underscore (_)

File name preview :
Your company_Cable 1_A-B.iolm

Buttons: Increment..., Clear Values, Revert to Factory Settings, OK, Cancel

Note: When working in unidirectional loopback, the direction is disabled because it will be set automatically by the loopback process. In a bidirectional loopback measurement, the direction is automatically set to Bidirectional.

Preparing Your iOLM for a Test

Naming Trace Files Automatically

4. If you want to increment automatically the cable ID, the fiber ID or any other custom identifier, proceed as follows:

- 4a. Tap the **Increment** button.

The screenshot shows a configuration window for an iOLM. The 'File name preview' section displays 'Your company_Cable 1_A-B.iolm'. Below this, there are two buttons: 'Increment...' and 'Clear Values'. The 'Increment...' button is circled in red. To the right of the 'Increment...' button is a 'Separator' dropdown menu set to 'Underscore (_)' and a 'Revert to Factory Settings' button. At the bottom right are 'OK' and 'Cancel' buttons.

- 4b. In the **Increment** window, select the **Auto Increment** check box corresponding to the identifier you want to increment.

- 4c. Enter the start, stop and step values as desired.

The 'Increment' dialog box contains a table with the following data:

Identifier	Auto Increment	Start	Stop	Step	Format
Cable ID	<input checked="" type="checkbox"/>	1	999	1	#
Fiber ID	<input checked="" type="checkbox"/>	01	99	1	##
Location A	<input checked="" type="checkbox"/>	01	999	1	##
Location B	<input type="checkbox"/>	1	999	1	#

Below the table, a yellow warning box contains the text: 'Location A' must reach stop value before 'Fiber ID' is incremented. 'Fiber ID' must reach stop value before 'Cable ID' is incremented.

At the bottom right are 'OK' and 'Cancel' buttons.

Note: The identifiers are processed in order, from the one with the largest indentation to the one with the smallest. For a given identifier, when the increment value reaches the stop value, the incrementation automatically switches to the next identifier. The order of the identifiers in the increment window (and thereby the order of increment) follows the order of the identification window.

Note: An identifier set to **None** will not appear in the increment window.

Note: To decrement values, the start number must be higher than the stop number.

4d. Select the format for the incrementation value. This will determine how many digits are used and the information will be displayed accordingly in the **Identification** window.

4e. Tap **OK** to return to the **Identification** window.

5. Tap **OK** to confirm your new settings and to return to the main window.

The new settings will apply the next time you perform an acquisition.

To clear the values:

1. From the **Main Menu**, tap **Identification**.

2. In the **Apply to** list, select **Next acquisition**.

3. Tap the **Clear Values** button.

The screenshot shows the 'Identification' window in the iOLM software. It features a table with the following rows: 'Fiber ID' (Fiber 2), 'Location A' (Not active), 'Location B' (Not active), 'None', 'Direction' (A->B), 'Custom file name', and 'Wavelength(s)' (850 nm). Below the table is a 'File name preview' section showing 'Your company_Cable_1_A-B.iolm'. At the bottom, there are three buttons: 'Increment...', 'Clear Values' (highlighted with a red circle), and 'Revert to Factory Settings'. The 'Separator' is set to 'Underscore (-)'.

4. Tap **OK** to return to the main window.

All values in the **Value** column are erased from the white boxes.

Reverting to Factory Settings



As long as the file was not already saved, you can revert to factory settings in your menus. However, the **Revert to Factory Settings** button is valid only for the window or tab where you use it.

Configuring Your iOLM

Depending on the type of unit you have purchased, you can configure your iOLM according to your testing needs. All the settings you can adjust in your configuration are conveniently located in a single tab. You can select the port and wavelengths to use; the values are preserved for the next acquisition.

If you include launch, receive and loop fiber lengths in your configuration, you can let the application determine the most appropriate launch and receive fiber values, or you can set them yourself.

When you specify a launch and receive fiber length manually, two different icons may appear when the fiber length is out of the recommended range. If you tap on the icons, the application then suggests the appropriate values.

- The  icon appears if the provided values are required but not selected and if the values entered are not within the appropriate range.
- The  icon is displayed if the values are not within the appropriate range.

The help icon  opens a window suggesting the appropriate fiber length for an expected link loss. The icon is not available when a non-supported configuration is selected.

Configuring Your iOLM in Standard Mode

The standard mode allows you to test simple fibers with or without launch and receive fibers.

To configure the iOLM in standard mode:

1. From the main window, select the iOLM tab.

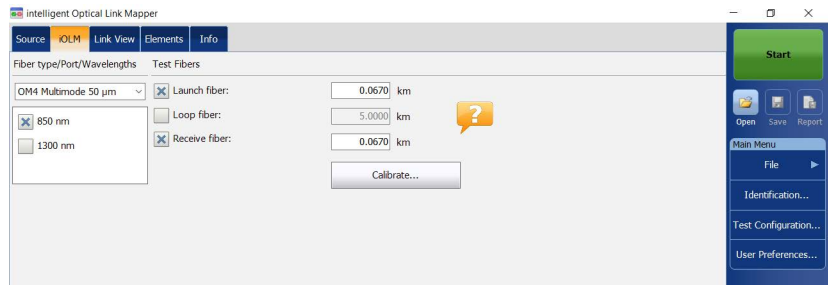

2. If the ICERT software option is activated, select the port to use for your test. The fiber core is also selected at this point; for C fibers, select 50 μm, and for D fibers, select 62.5 μm.

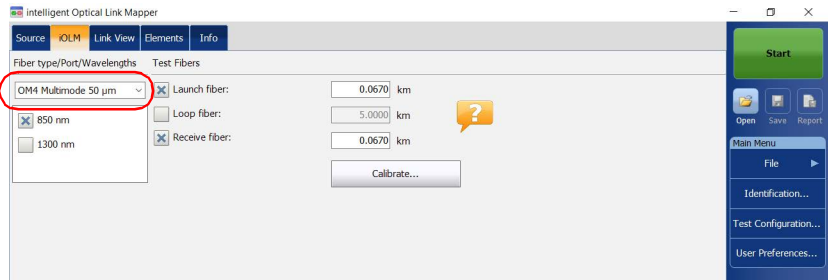

Note: When the ICERT software option is not activated, you cannot select a fiber type in the list of available choices.

Note: Even if the ICERT software option is activated, when the fiber type and port are defined in a specific test configuration, you cannot modify them in the iOLM tab. You need to edit the test configuration to modify them.

Preparing Your iOLM for a Test

Configuring Your iOLM

3. If you have a standard iOLM, select the wavelengths for the next acquisition. The available wavelengths depend on the iOLM module.

OR

If you have a DWDM or a CWDM module, select a channel filter and a specific channel. See *Working With the DWDM Module* on page 63 or *Working With the CWDM Module* on page 73 for details.

Standard iOLM

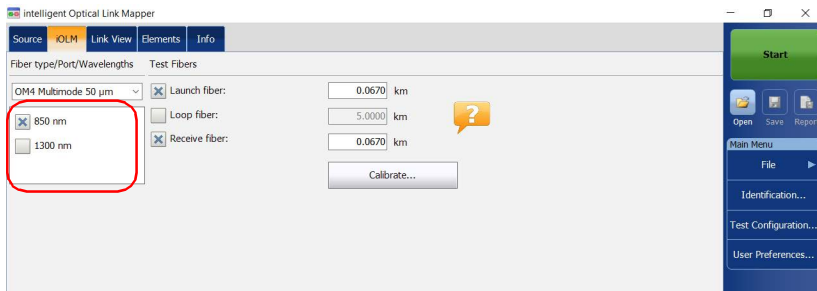

DWDM and CWDM modules

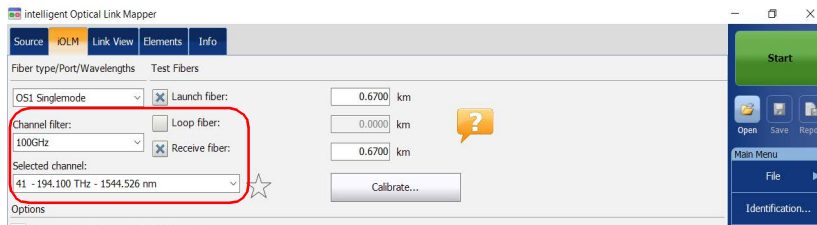

4. Specify if launch and receive fibers are connected to the link under test. See *Launch, Receive, and Loop Fibers* on page 10 for details.

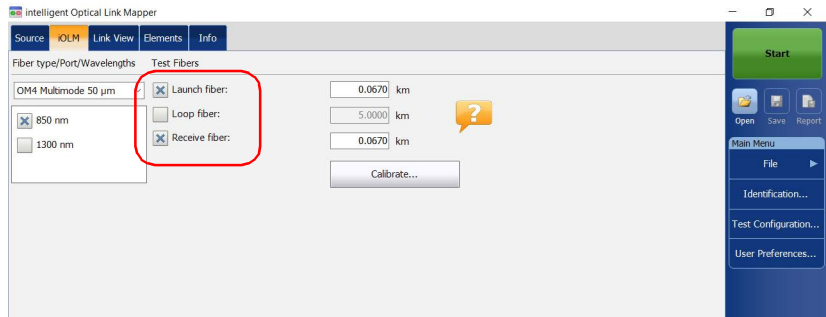

If you want to let the application measure the launch and receive fiber lengths values automatically, go to step 5. You can also specify the launch and receive fiber lengths manually. To do so, go to step 6.

5. If you want to specify the launch and receive fiber lengths automatically, proceed as follows:
 - 5a. Tap **Calibrate** to access the measurement assistant.

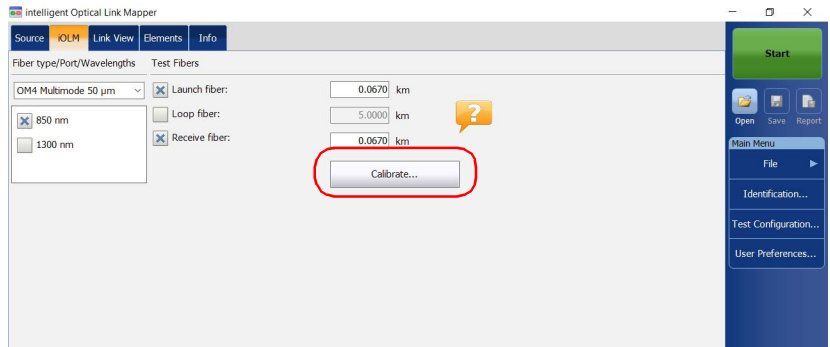

Preparing Your iOLM for a Test

Configuring Your iOLM

- 5b.** Select the test fibers to measure and follow the instructions on-screen.



- 6.** If you want to specify the launch and receive fiber lengths manually, enter the values in the corresponding boxes.

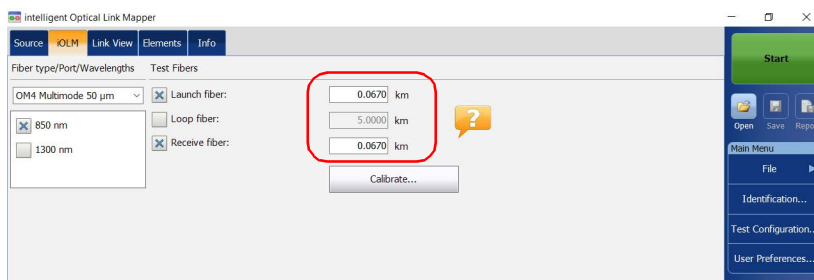

All values and settings you have selected, such as the port and wavelengths, are preserved for the next acquisition.

Configuring Your iOLM in Loopback Mode

The IPRO or ILOOP software options allow you to test in loopback mode. This mode is especially designed for testing cables formed of a pair of identical fibers of an equivalent length. The measuring time is optimized because two fibers are checked in a single measurement. If you have activated the option for your application, it is ready to use when needed. The loopback mode will give the best results if you follow the three rules below:

- Both fibers under test, that are connected to the loop, must have the same length.
- The launch and receive lengths must be specified correctly.
- The length of the loop must be specified correctly.

Note: *You cannot use the files created using the loopback mode to perform a second loopback operation.*

To configure the iOLM in loopback mode:

1. From the main window, select the iOLM tab.

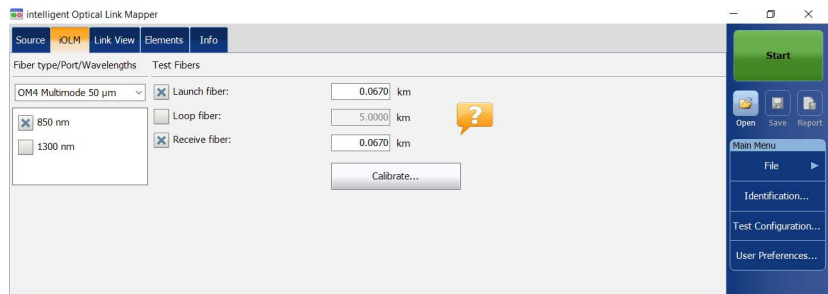

Preparing Your iOLM for a Test

Configuring Your iOLM

2. If the ICERT software option is activated, select the port to use for your test. The fiber core is also selected at this point; for C fibers, select 50 μm , and for D fibers, select 62.5 μm .

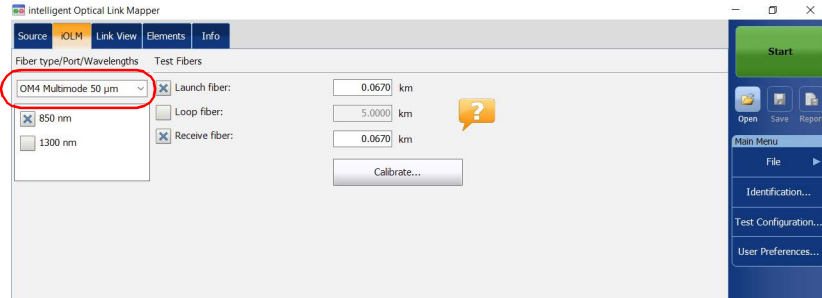

Note: When the ICERT software option is not activated, you cannot select a fiber type in the list of available choices.

Note: Even if the ICERT software option is activated, when the fiber type and port are defined in a specific test configuration, you cannot modify them in the iOLM tab. You need to edit the test configuration to modify them.

3. If you have a standard iOLM, select the wavelengths for the next acquisition. The available wavelengths depend on the iOLM module.

OR

If you have a DWDM or a CWDM module, select a channel filter and a specific channel. See *Working With the DWDM Module* on page 63 or *Working With the CWDM Module* on page 73 for details.

Standard iOLM

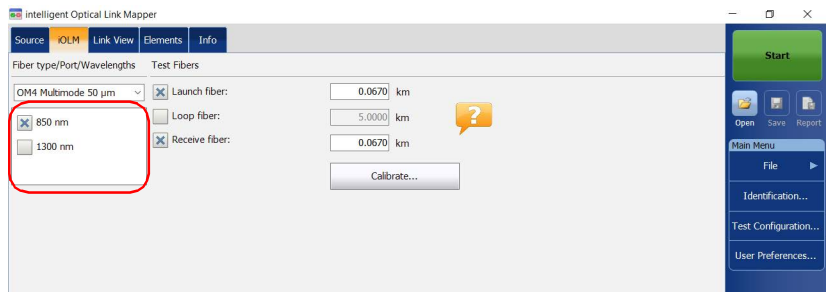

DWDM and CWDM modules

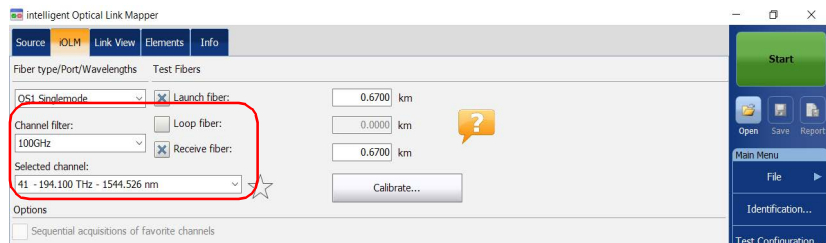

Preparing Your iOLM for a Test

Configuring Your iOLM

- Specify if launch, receive, and loop fibers are connected to the link under test. See *Launch, Receive, and Loop Fibers* on page 10 for details.

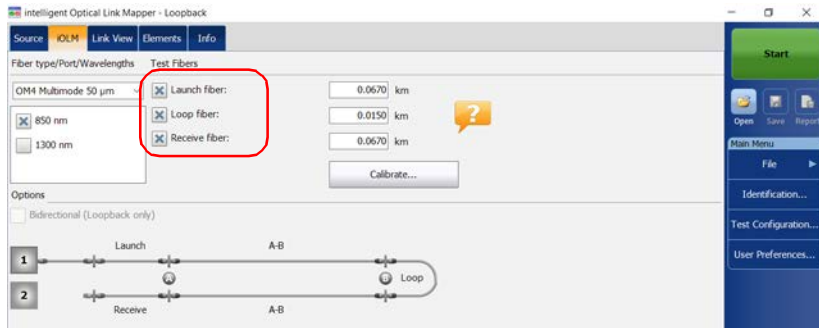

If you want to let the application measure the launch and receive fiber lengths values automatically, go to step 5. You can also specify the launch, receive and loop fiber lengths manually. To do so, go to step 6.

Note: *The application cannot measure the loop fiber length automatically. You must specify the value manually.*

5. If you want to specify the launch and receive fiber lengths automatically, proceed as follows:

5a. Tap **Calibrate** to access the measurement assistant.

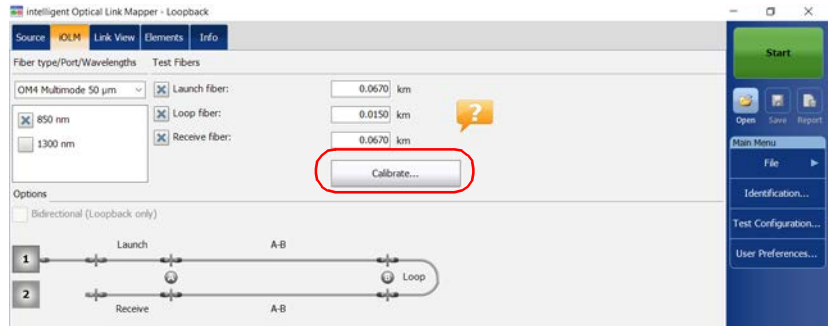

- 5b.** Select the test fibers to measure and follow the instructions on-screen.



- 5c.** Proceed to step 7.

Preparing Your iOLM for a Test

Configuring Your iOLM

6. If you want to specify the launch, receive and loop fiber lengths manually, enter the values in the corresponding boxes.

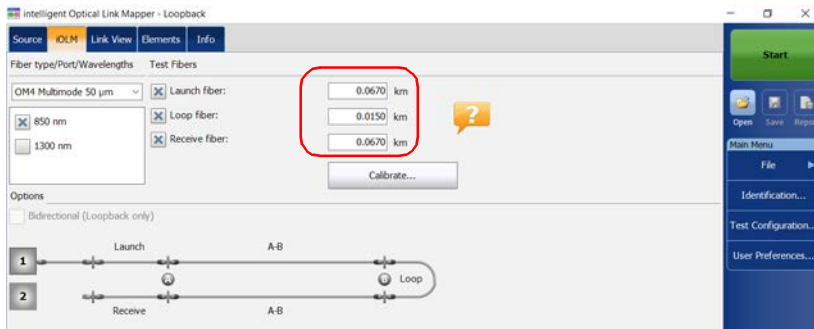

7. When the **Loop fiber** checkbox is selected, you can choose to work with the **Bidirectional (Loopback only)** option or not.

Note: *Bidirectional measurements are only available in singlemode.*

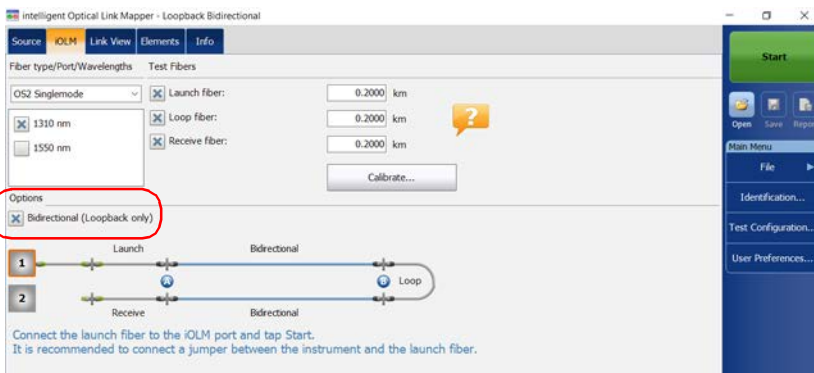

All values and settings you have selected, such as the port and wavelengths, are preserved for the next acquisition.

Configuring Your iOLM to Work With the Optical Switch

Note: You cannot use the optical switch with the MAX/FTBx-740C-DWx and FTBx-740C-CW modules.

The IPRO software option also allows you to perform multifiber iOLM test measurements in singlemode, using an externally controlled MPO optical switch. See *Connecting an Optical Switch to the iOLM* on page 31 for details.

Note: The optical switch does not support the loopback mode.

To configure the iOLM to work with the optical switch:

1. From the main window, select the **iOLM** tab.



Preparing Your iOLM for a Test

Configuring Your iOLM

2. If the ICERT software option is activated, select the port to use for your test.



Note: When the ICERT software option is not activated, you cannot select a fiber type in the list of available choices.

Note: Even if the ICERT software option is activated, when the fiber type and port are defined in a specific test configuration, you cannot modify them in the iOLM tab. You need to edit the test configuration to modify them.

3. Select the wavelengths for the next acquisition. The available wavelengths depend on the iOLM module.

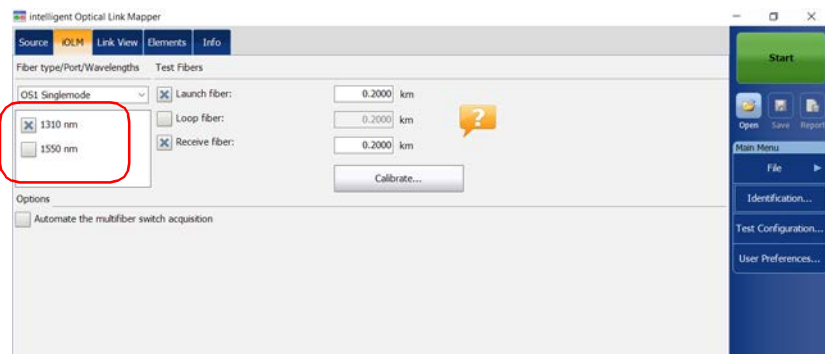

- Specify if launch and receive fibers are connected to the link under test. See *Launch, Receive, and Loop Fibers* on page 10 for details.

Note: You must calibrate the launch and receive fibers with the measurement assistant to perform acquisitions.



- Select the **Automate the multifiber switch acquisition** checkbox.



Preparing Your iOLM for a Test

Configuring Your iOLM

- The application calibrates the launch and receive fiber length values automatically with the measurement assistant. The values cannot be set manually. To do so, proceed as follows:

6a. Tap **Calibrate** to access the measurement assistant.

Indicates that the value has been calculated by the measurement assistant.

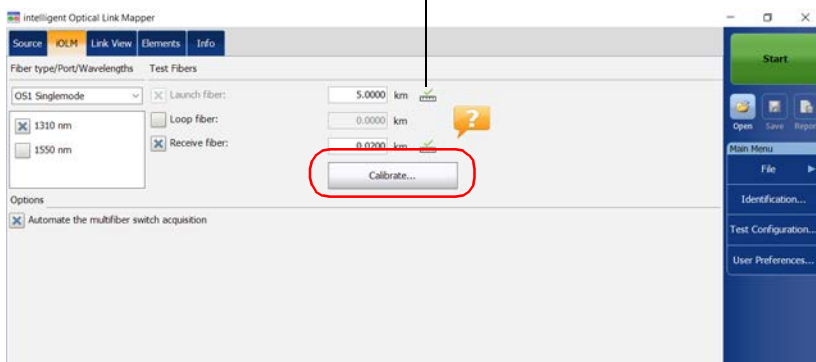

- 6b.** Select the test fibers to measure and follow the instructions on-screen.

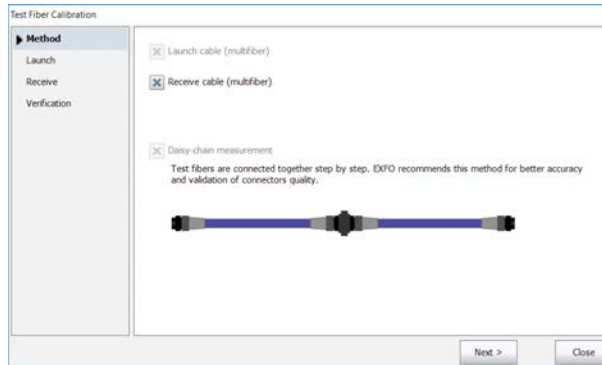

Note: *When the MPO optical switch is connected and you are using the measurement assistant, the loss and reflectance thresholds are defined by the application and cannot be changed. These thresholds represent the recommended values for optimal performance. Sometimes, the loss and reflectance values may not be within the optimal thresholds. The link measurement can still be performed, but the dynamic range and the resolution performance will be altered.*



IMPORTANT

EXFO strongly recommends to scan all fibers during the calibration process to fully validate the test cable.

All values and settings you have selected, such as the port and wavelengths, are preserved for the next acquisition.

Preparing Your iOLM for a Test

Enabling or Disabling the Cumulative Loss

Enabling or Disabling the Cumulative Loss

The cumulative loss value is calculated for each wavelength, from the beginning of the link to a specific element or fiber section. This feature can be useful to locate the deterioration on a link by comparing new values with values taken previously on the same link. This option is not activated by default.

When comparing the values of the cumulated loss on the last event and the one displayed for the link loss, you may notice they can be different. This difference may be caused by the accumulation of uncertainties when the sum of the values is calculated.

The cumulative loss is not calculated for the elements before the link start and after the link end. See *Launch, Receive, and Loop Fibers* on page 10 for details.

Only the element representing a group of elements displays the cumulative loss value. See *Viewing Results in the Link View* on page 175 for details.

To enable or disable the cumulative loss:

1. From the **Main Menu**, tap the **User Preferences** button, then select the **General** tab.
2. Under **Functionalities**, select the **Cumulative loss** check box.

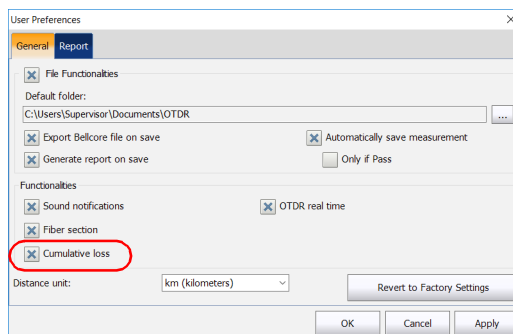

3. Tap **OK** to return to the main window.

Enabling or Disabling the Automated Acquisition Sequence

If your module is equipped with both an SM and an SM live ports, you can perform automated acquisition sequences. The acquisition is always performed on the SM port first, and then on the SM live port. If your module supports more than one wavelength, you need to select at least one wavelength to perform the acquisition on the SM port and one wavelength on the SM live port.

When the feature is enabled, the application does not prompt you to connect the fiber on the SM live port after the acquisition has been completed on the SM port.

When the feature is disabled, the application displays a message to indicate the moment you need to connect the fiber to the SM live port. However, if you use a coupler between the fibers connected to the SM and SM live ports, the application will perform the acquisitions one after another, and it will not prompt you.

The application allows you to generate a trace in Bellcore (.sor) format for both SM and SM live wavelengths when the acquisition has been completed properly.

The acquisition stops automatically after it is complete but you can also stop it at any time while it is in progress.

Whether the feature is enabled or not, only one report is generated after the acquisition sequence is complete.

Preparing Your iOLM for a Test

Enabling or Disabling the Automated Acquisition Sequence

To enable or disable the automated acquisition sequence:

1. From the main window, select the **iOLM** tab.

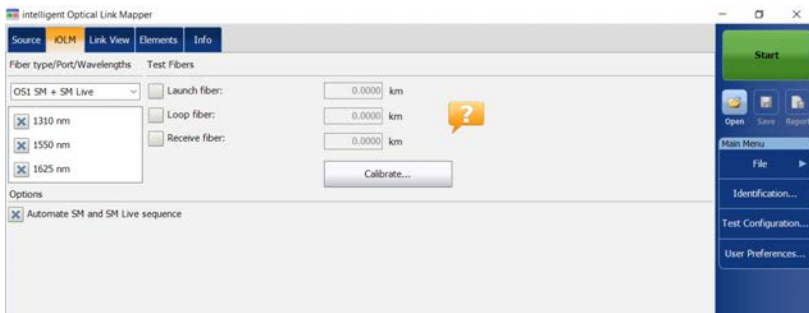

2. Select an **SM + SM Live** port to use for your test.



Preparing Your iOLM for a Test

Enabling or Disabling the Automated Acquisition Sequence

3. Select the wavelengths to use for your test.



4. To enable the automated acquisition sequence, select the **Automate SM and SM Live sequence** check box.



5 Working With the DWDM Module

The MAX/FTBx-740C-DWx module allows you to perform specific acquisitions using the DWDM (dense wavelength-division multiplexing) technology in the C-band and is designed to test through field mux/demux channels. This high-resolution particular type of module provides complete end-to-end link characterization and helps troubleshooting metro Ethernet links as well as commercial services.

Based on the ITU-T standard grid, the MAX/FTBx-740C-DWx module covers a channel spacing of 50/100/200 GHz. The channel width used is always 50 GHz, regardless of the selected channel spacing.

Main Features

The MAX/FTBx-740C-DWx module offers the following:

- C-band ITU grid channel selection to test through DWDM ports
- Mux/demux and add/drop testing
- In-service testing of active networks
- High-resolution and short dead zones
- Selection in a customized favorite channels list
- Testing coupler elements defined as custom elements to determine their pass/fail thresholds (available with the CWDM-DWDM test configuration)
- Creation of MUX/DEMUX element type with custom threshold values for complete link certification and reporting

Selecting a Channel Filter

DWDM increases the bandwidth of an optical fiber by multiplexing several wavelengths onto it. Using the different channel spacings, the module can place several dozens of wavelengths on a single fiber. The channel filter selected by default is 100 GHz.

When you choose a channel filter, the list of available wavelengths is updated accordingly. If the channel that was selected before the change of filter is still available, it will remain selected by default. However, if the channel is no longer available after the change of channel spacing, the one nearest to your previous selection will be selected by default.

To select a specific channel filter:

1. From the main window, go to the **iOLM** tab.
2. From the **Channel filter** list, select a channel spacing width to use for your tests.

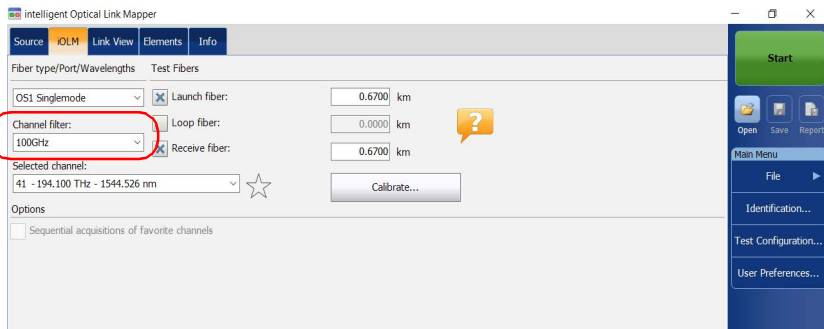

Note: The channels marked as favorites in the **Selected channel** list can be retrieved in the **Channel filter** list. See *Managing Favorite Channels* on page 66 for details.

Selecting a Channel

Based on the ITU-T DWDM frequency grid, the MAX/FTBx-740C-DWx module offers many wavelengths you can choose from.

Note: *Changing the channel filter does not affect the selected channel unless it is not available with the new channel filter.*

To select a specific channel:

1. From the main window, go to the **iOLM** tab.
2. From the **Selected channel** list, select a wavelength to use for your tests.

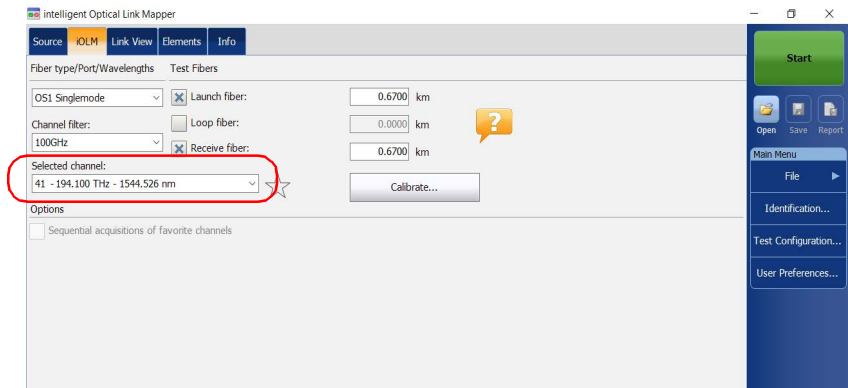

Managing Favorite Channels

You can add the channels you use the most often in a list of favorite channels and recall them for future acquisitions. You can also remove them from the list if they are not relevant anymore.

If you want to display the list of favorite channels only, you can do so.

To add favorite channels:

1. From the main window, go to the **iOLM** tab.
2. From the **Selected channel** list, select the wavelength you want to add to the list.
3. When the wavelength is highlighted in blue, tap .

When the star becomes yellow, it indicates the wavelength has been added to the list.

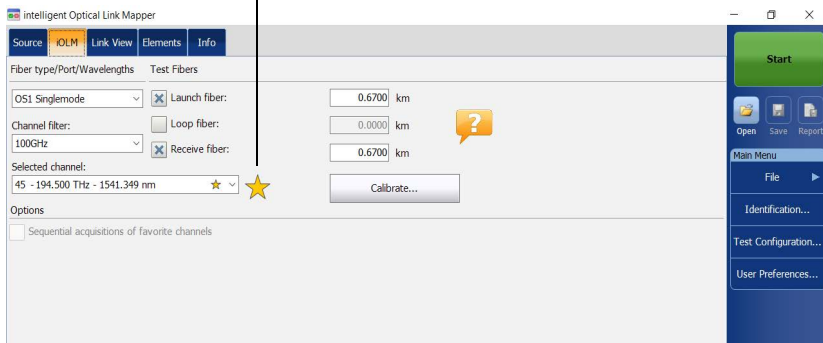

To remove favorite channels from the list:

1. From the main window, go to the **iOLM** tab.
2. From the **Selected channel** list, select a wavelength with a  next to it.

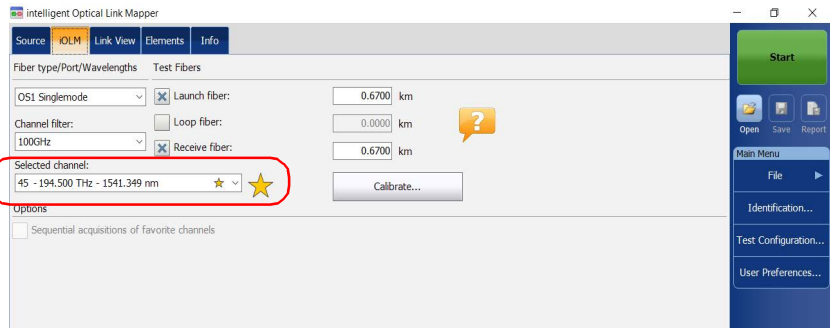

3. When the wavelength is highlighted in blue, tap .

Note: When the star is no longer yellow, it indicates the wavelength has been removed from the list.

Working With the DWDM Module

Managing Favorite Channels

To display the list of favorite channels only:

1. From the main window, go to the **iOLM** tab.
2. From the **Channel filter** list, select **Favorite channels**.

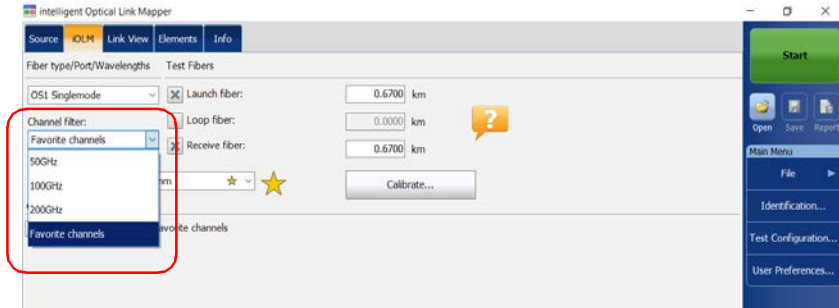

The list of favorite channels is displayed in the drop-down menu under **Selected channel**.

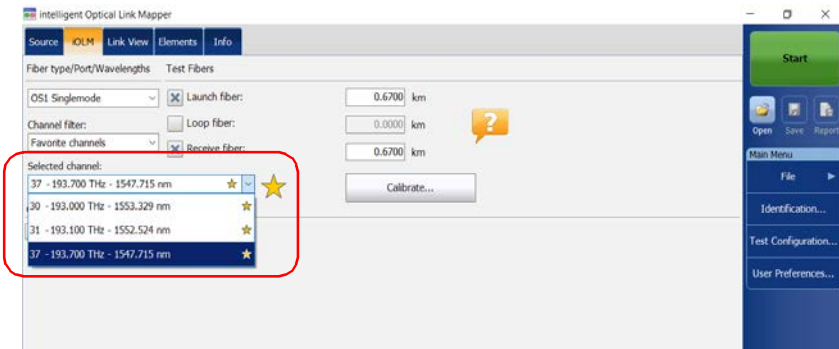

Testing Channels Sequentially

You can acquire traces sequentially for channels tagged as favorite channels.

The acquisitions are performed sequentially in the same order as the channels appear in the list of favorite channels as soon as you start an acquisition.

You can stop the acquisition at any time while it is in progress. The application stores the traces already acquired in the default folder you have defined. See *Setting the Default Storage Folder* on page 147 for details.

Note: *Since the measurements are always saved, the settings for the automatic storage of the files are not taken into account when testing channels sequentially. See Enabling or Disabling the Automatic Storage of the Files on page 156 for details.*

To test channels sequentially:

1. From the main window, go to the **iOLM** tab.
2. From the **Channel filter** list, select **Favorite channels**.

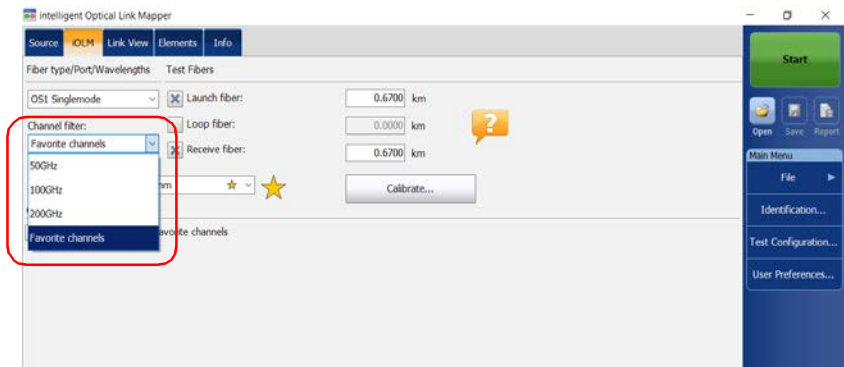

Working With the DWDM Module

Testing Channels Sequentially

3. Select the **Sequential acquisitions of favorite channels** box.

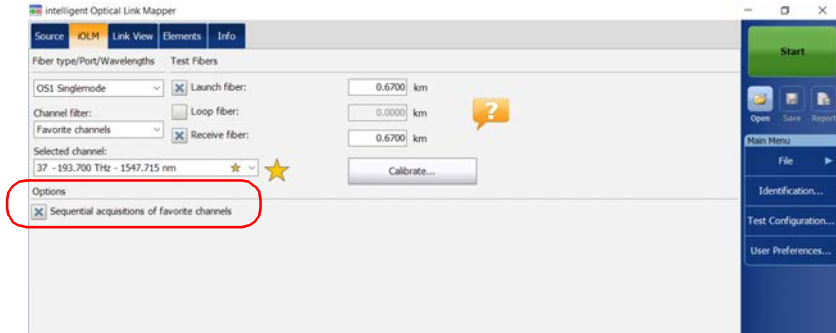

The list of favorite channels is displayed in the drop-down menu under **Selected channel**.

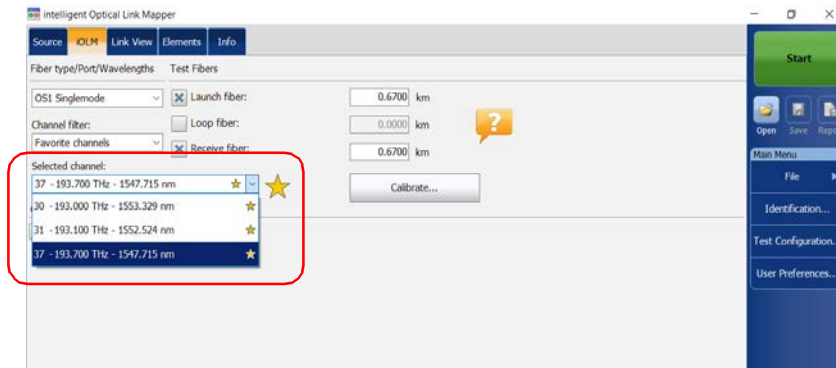

The acquisitions are performed sequentially as soon as you tap the **Start** button.

Performing Live-Fiber Testing

During live-fiber testing, the light signals transmitted in other channels than the channel under test will be largely rejected by the mux/demux as well as the internal iOLM filters, but some residual light that reaches the light detector of the iOLM will increase the electronic noise. This residual light reduces the dynamic range, especially when larger pulse widths are used. The MAX/FTBx-740C module can test a channel while other channels are live but the channel under test must be dark.

Before performing a test on a specific channel, you have to disconnect the end of the link from the far-end transmitter/receiver device. Consequently, to test a transport fiber with active channels, you must connect the iOLM to a mux/demux port that contains no active channels or devices.

6 Working With the CWDM Module

The MAX/FTBx-740C-CW module covers up to 18 CWDM ITU channels, from 1270 nm to 1610 nm, with a channel spacing of 20 nm, and is designed to test through field mux/demux channels. This high-resolution particular type of CWDM (coarse wavelength-division multiplexing) module provides a complete end-to-end link characterization and helps troubleshooting commercial, C-RAN networks as well as metro Ethernet links deployments.

Note: *The official channel values have been shifted by 1 nm (from 1271 nm to 1611 nm). Your iOLM was defined with the values of 1270 nm to 1610 nm for simplicity purposes, but is fully compatible with previous and present channel center wavelengths.*

Main Features

The MAX/FTBx-740C-CW module offers the following:

- CWDM ITU grid channel selection to test through CWDM ports
- Up to 18 CWDM channels covered into a single port, depending on the type of OTDR model and available options
- In-service testing of active networks
- High-resolution and short dead zones
- Selection in a customized favorite channels list
- Testing coupler elements defined as custom elements to determine their pass/fail thresholds (available with the CWDM-DWDM test configuration)

Working With the CWDM Module

Selecting a Channel Filter

Selecting a Channel Filter

The MAX/FTBx-740C-CW module offers two different channel filters. You can choose to work with all the wavelengths available on your unit or with your favorite channels. See *Managing Favorite Channels* on page 76 for details.

To select a specific channel filter:

1. From the main window, go to the **iOLM** tab.
2. Select a channel filter to use for your test.

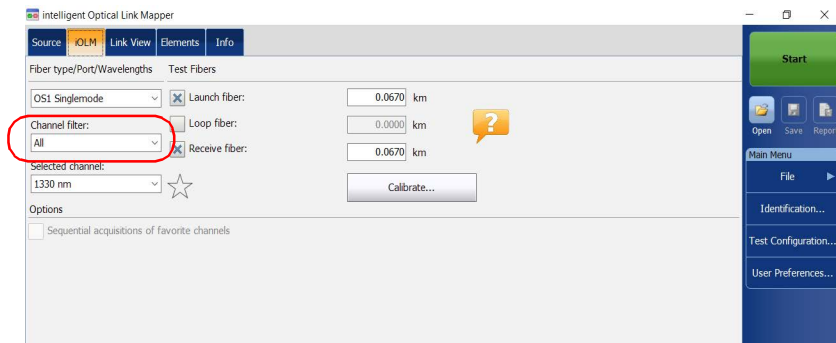

Note: If no channel has been added to the **Favorite channels** list, the application selects **All** by default.

Selecting a Channel

Based on the ITU-T CWDM wavelength grid, the iOLM offers 18 wavelengths (from 1270 nm to 1610 nm) you can choose from.

To select a specific channel:

1. From the main window, go to the **iOLM** tab.
2. From the **Selected channel** list, select a wavelength to use for your tests.

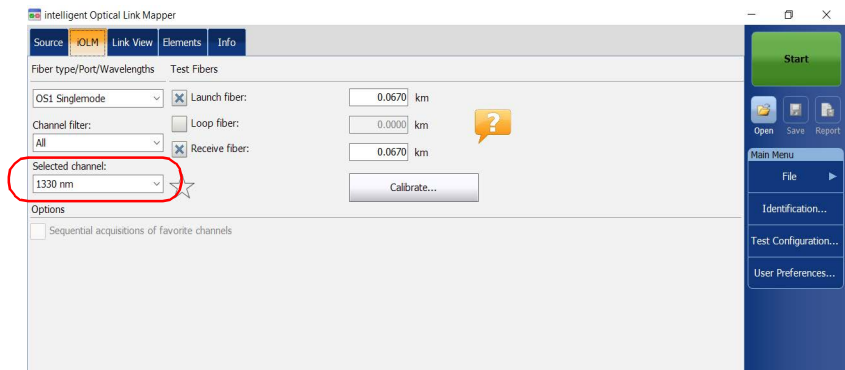

Managing Favorite Channels

You can add the channels you use most often in a list of favorite channels and recall them for future acquisitions. You can also remove them from the list if they are not relevant anymore.

If you want to display the list of favorite channels only, you can do so.

To add favorite channels:

1. From the main window, go to the **iOLM** tab.
2. From the **Selected channel** list, select the wavelength you want to add to the list.
3. When the wavelength is highlighted in blue, tap .

When the star becomes yellow, it indicates the wavelength has been added to the list.

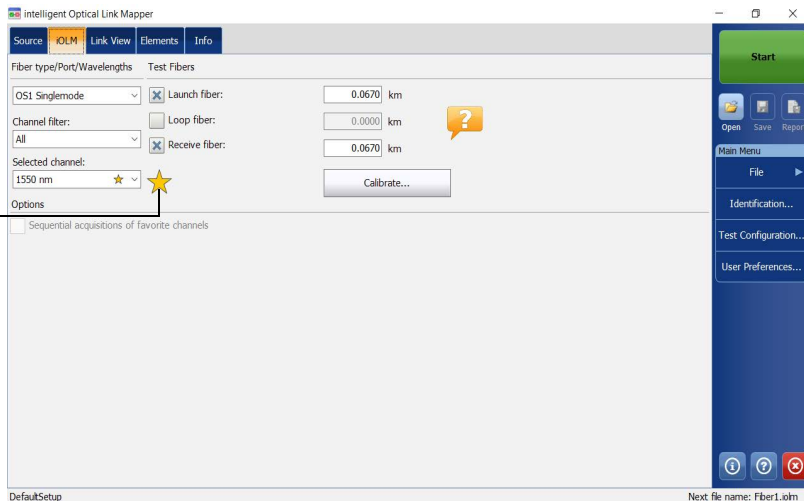

To remove favorite channels from the list:

1. From the main window, go to the **iOLM** tab.
2. From the **Selected channel** list, select a wavelength with a  next to it.

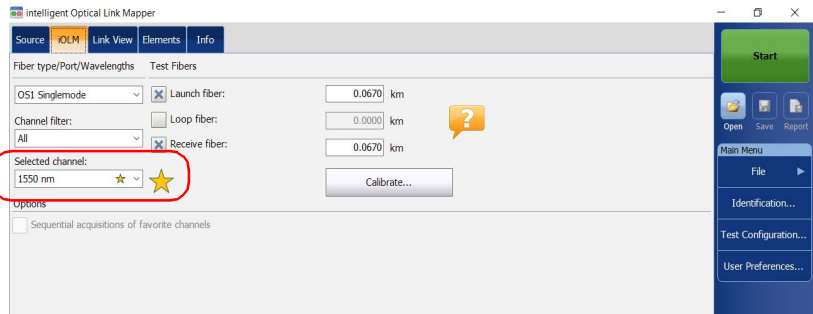

3. When the wavelength is highlighted in blue, tap .

Note: When the star is no longer yellow, it indicates the wavelength has been removed from the list.

Working With the CWDM Module

Managing Favorite Channels

To display the list of favorite channels only:

1. From the main window, go to the **iOLM** tab.
2. From the **Channel filter** list, select **Favorite channels**.

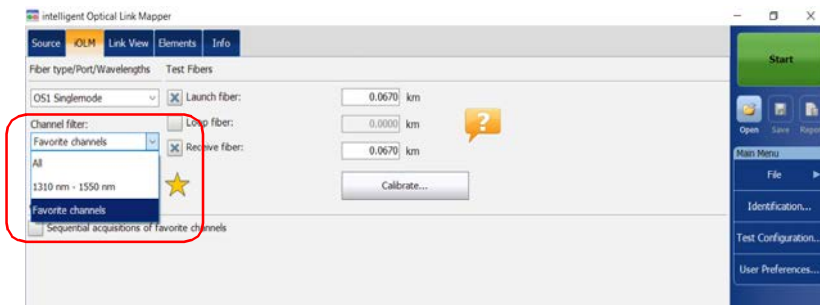

The list of favorite channels is displayed in the drop-down menu under **Selected channel**.

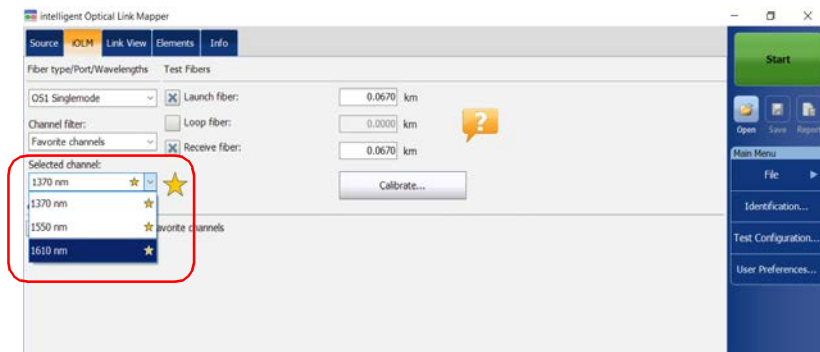

Testing Channels Sequentially

You can acquire traces sequentially for channels tagged as favorite channels.

The acquisitions are performed sequentially in the same order as the channels appear in the list of favorite channels as soon as you start an acquisition.

You can stop the acquisition at any time while it is in progress. The application stores the traces already acquired in the default folder you have defined. See *Setting the Default Storage Folder* on page 147 for details.

Note: *Since the measurements are always saved, the settings for the automatic storage of the files are not taken into account when testing channels sequentially. See Enabling or Disabling the Automatic Storage of the Files on page 156 for details.*

To test channels sequentially:

1. From the main window, go to the **iOLM** tab.
2. From the **Channel filter** list, select **Favorite channels**.

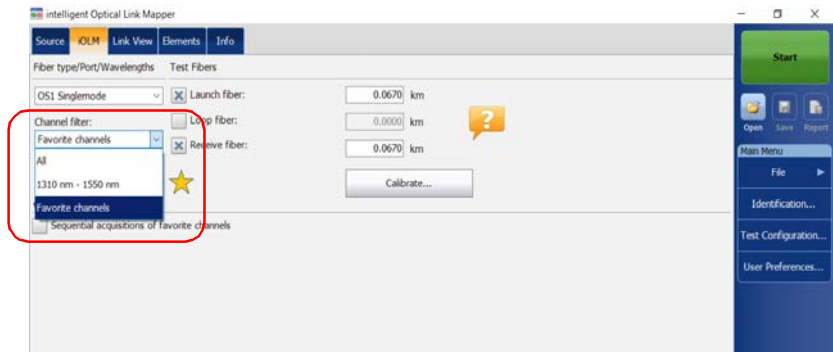

Working With the CWDM Module

Testing Channels Sequentially

3. Select the **Sequential acquisitions of favorite channels** box.



The list of favorite channels is displayed in the drop-down menu under **Selected channel**.

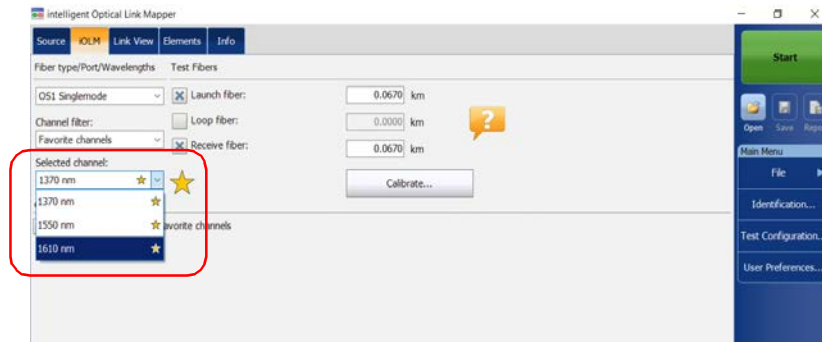

The acquisitions are performed sequentially as soon as you tap the **Start** button.

Detecting Macrobends on Fiber Links

The CWDM module allows you to detect macrobends on fiber links only when you select the 1310 nm - 1550 nm wavelength combination in the channel filter list.

Note: You need to activate the CWDM-18W option to detect macrobends on fiber links. See Software Options on page 14 for details.

You can edit the macrobend detection threshold value. If you do not define one, the application will apply the default value of 0.5 dB automatically when you load a test configuration.

Note: The application cannot detect couplers on the fiber link when the 1310 nm-1550 nm wavelength combination is selected.

To detect macrobends on fiber links:

1. From the main window, go to the **iOLM** tab.
2. From the **Channel filter** list, select **1310 nm - 1550 nm**.



Working With the CWDM Module

Detecting Macrobends on Fiber Links

3. From the **Main Menu**, tap **Test Configuration**.



4. Select the configuration you want to edit and tap **Modify**.
5. Select the **Link Definition** tab.

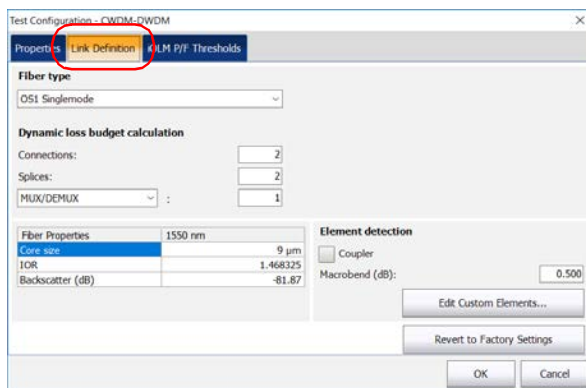

- Under **Element detection**, specify a macrobend detection value.

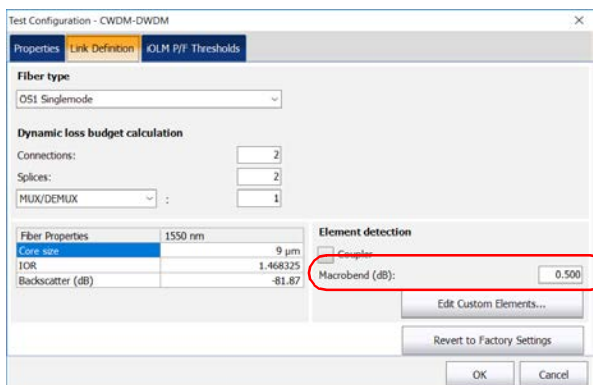

- Tap **OK** to confirm your changes and close the window. Tap **Cancel** to ignore your changes and close the window.

Performing Live-Fiber Testing

During live-fiber testing, the light signals transmitted in other channels than the channel under test will be largely rejected by the mux/demux, but some residual light that reaches the connectors will increase the electronic noise. This residual light reduces the dynamic range, especially when larger pulse widths are used. The MAX/FTBx-740C-CW module can test a channel while other channels are live but the channel under test must be dark.

Before performing a test on a specific channel, you have to disconnect the end of the link from the far-end transmitter/receiver device. Consequently, to test a transport fiber with active channels, you must connect the iOLM to a mux/demux port that contains no active channels or devices.

Understanding Fiber Water Peak

When water molecules are trapped within the glass core structure of the fiber, the light absorbed, as well as the fiber attenuation, will increase around 1383 nm. This is known as a fiber water peak and is more pronounced on older fibers. When working with a CWDM module, you will notice that wavelengths 1370 nm and 1390 nm are more likely to be affected by this phenomenon. The accuracy of an iOLM measurement performed at one of these two wavelengths may be affected if there are high fiber water peak on specific fiber sections on the link. When this situation is detected, the iOLM will display a diagnosis on the link elements affected. See *Understanding Diagnostics* on page 159 for details.

7 **Managing Test Configurations**

A predefined default setup configuration is available when you purchase your unit. You can also create your own test configurations by duplicating an existing one and modifying the settings that will meet your specific needs.



IMPORTANT

Some threshold values may be different when a test configuration file is imported. If the thresholds differ for a given wavelength, the application uses the most restrictive threshold values.

Creating custom test configurations is done through duplicating an existing configuration, and then modifying the desired criteria. If you create configurations on one unit and want to transfer them to another unit, you can do so.

Impacts of Test Configurations

Before performing an acquisition, you can select or edit a test configuration that fits the link under test. This configuration contains specific pass/fail thresholds and the definition of any expected PON splitter. Once selected, the configuration will be used for all following measurements.

The configuration data is structured in the same way than an iOLM result file. Each result file contains the entire configuration data used for the measurement.

Using a test configuration may influence the minimum reach of the measurement in terms of loss. For instance, the expected loss budget of a link that includes splitters will force the acquisition to cover at least this loss budget. Because of this, using an accurate test configuration can improve the accuracy of the measurements. If an inaccurate configuration file is used, some link element types might be wrongly defined. For instance, if no splitter stage is defined, actual splitters will be described as splices or connectors. This will not affect the reflectance and loss values associated with the link elements, only their type. After a measurement is completed, a link element type can be changed in order to apply the correct pass/fail threshold. See *Editing Element Types* on page 197 for details.

The pass/fail thresholds defined in the configuration file will have no impact on the capacity of the iOLM application to perform measurements. Only the pass/fail status of the link or link elements will be determined by the user-defined thresholds.

Selecting a Test Configuration

The test configuration is selected to apply the configuration settings (thresholds, link definition parameters, etc.) in the iOLM application for the next acquisition.

The IADV software option enables you to perform a characterization of the fiber. With a singlemode module, the option detects the presence of splitters (1:N and 2:N) to ensure the fiber is connected to a splitter via a distribution fiber.

Depending on the module you are using, different Optimode test configurations are available. A software option is available to give you access to different Optimodes. Optimodes use an algorithm intended for specific use cases, which overpasses the iOLM standard mode performances in given testing topologies.

Note: *The Optimode has been designed and optimized to work in specific use cases. If it is used in situations other than what it was designed for, it may cause your unit to display odd results.*

Refer to the iOLM technical specifications for the Optimode available and the appropriate specifications. You can also contact EXFO to ensure the Optimode is designed for your use cases. See *Testing Modes* on page 8 for details.

Managing Test Configurations

Selecting a Test Configuration

To select a test configuration:

1. From the **Main Menu**, tap **Test Configuration**.

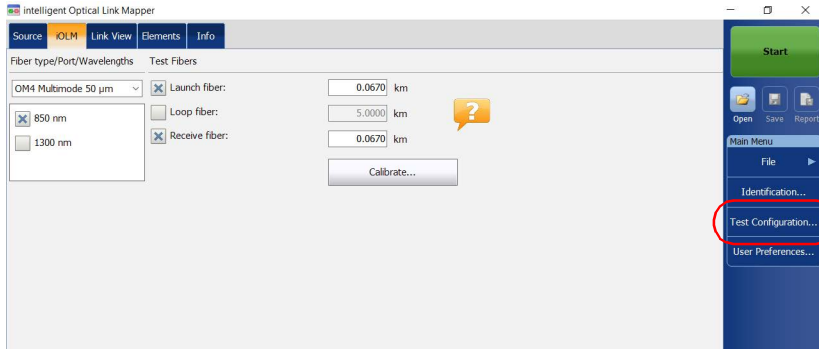

2. In the list of available test configurations, select the configuration you want to use and tap **Close**.

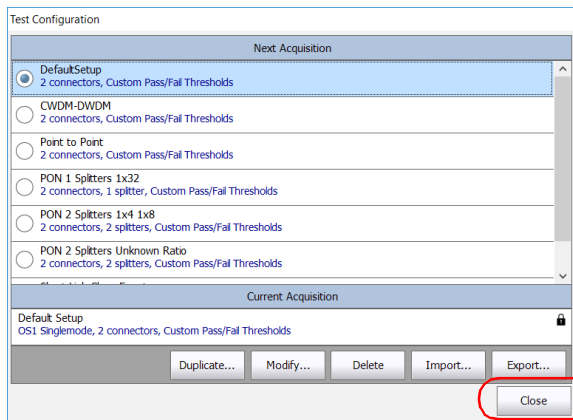

Creating a Test Configuration

You can create your own test configurations by duplicating an existing one and modifying the settings to fit your needs.

To create a test configuration:

1. From the **Main Menu**, tap **Test Configuration**.

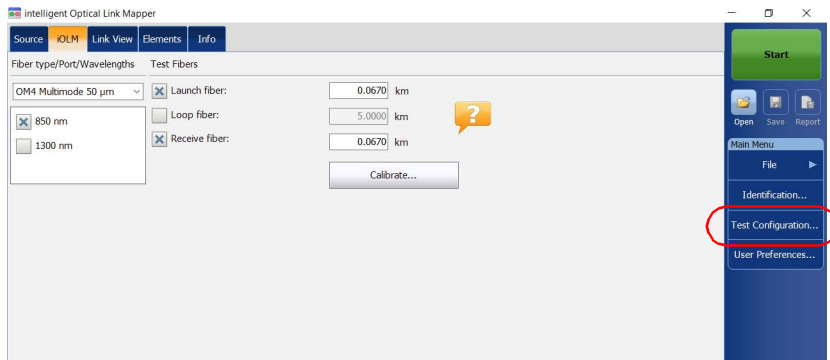

2. Select the row corresponding to the configuration that is the closest to the one you want to create, then tap **Duplicate**.

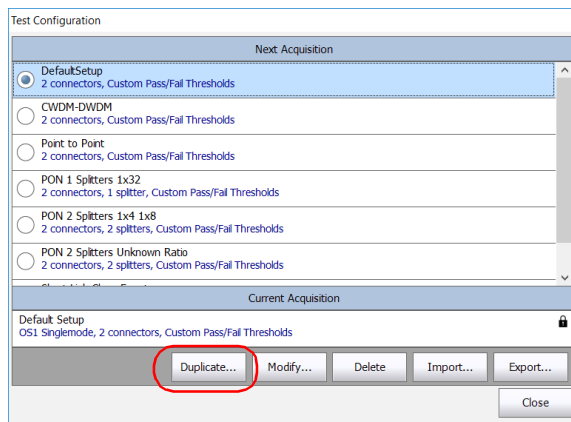

Managing Test Configurations

Creating a Test Configuration

3. A default name is suggested for the new configuration. Change the name as needed, then tap **Save**.

Note: *You cannot have two configurations with the same name.*

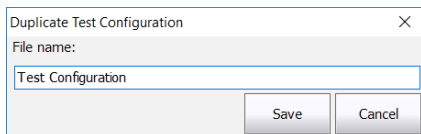

4. Tap the **Modify** button to change the settings according to your needs:
 - ▶ **Properties:** This is where you can change the name of the configuration, select the port (singlemode, multimode or unspecified) as well as the Optimode you will use. See *Setting the Test Configuration Properties* on page 91 for details.
 - ▶ **Link Definition:** This is where you can select the fiber type for your test configuration and the number of connections and splices. See *Defining the Link for Your Test* on page 98 for details.
 - ▶ **iOLM P/F Thresholds:** This is where you can select the certification standards for your test configuration and edit the pass/fail thresholds. See *Selecting Certification Standards* on page 119 for details.
 - ▶ **OPM P/F Thresholds:** This is where you can set the thresholds for your power meter. See *Setting Custom Power Meter Thresholds* on page 163 for details.
5. Tap **OK** to confirm your changes and close the window. Tap **Cancel** to ignore your changes and close the window.

Setting the Test Configuration Properties

The properties for your test configuration include its name, as well as the Optimode you will use.

With the IADV software option you can specify an acquisition time and a pulse width in your iOLM configurations. This pulse width will be applied when generating an .sor file.

A longer pulse allows you to probe further along the fiber, but results in less resolution. A shorter pulse width provides higher resolution but less distance range. The available distance ranges and pulse widths depend on your iOLM model.

Note: *Not all pulse widths are compatible with all distance ranges.*

You can choose to set the pulse width to auto and let the application use the most appropriate pulse on the link.

To change the test configuration properties:

1. From the **Main Menu**, tap **Test Configuration**.

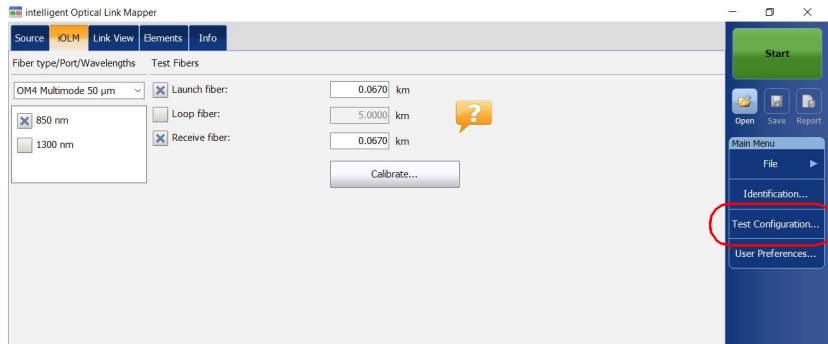

2. Select the configuration you want to edit and tap **Modify**.

Managing Test Configurations

Setting the Test Configuration Properties

3. Select the **Properties** tab.

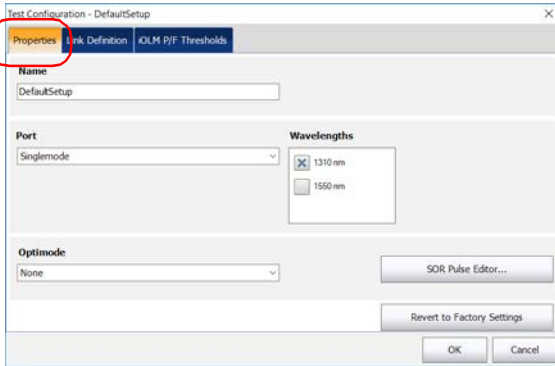

4. If desired, change the configuration name by tapping in the corresponding field and entering your information.

Note: You cannot have two test configurations with the same name.

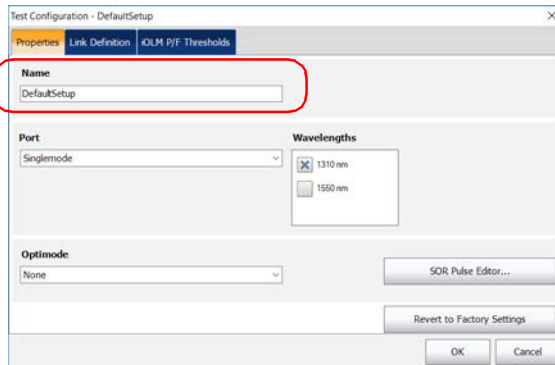

5. Select the port you want to use and if you have a standard iOLM, select the wavelengths as well.

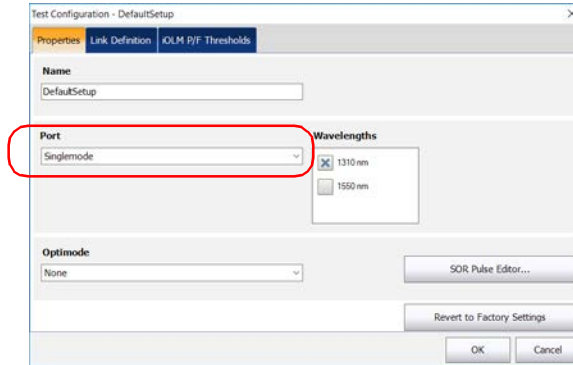

Note: You should select **Unspecified** when a test configuration has no defined ports or wavelengths.

6. If you have a DWDM or a CWDM module, select a channel filter and a specific channel. See *Working With the DWDM Module* on page 63 or *Working With the CWDM Module* on page 73 for details.

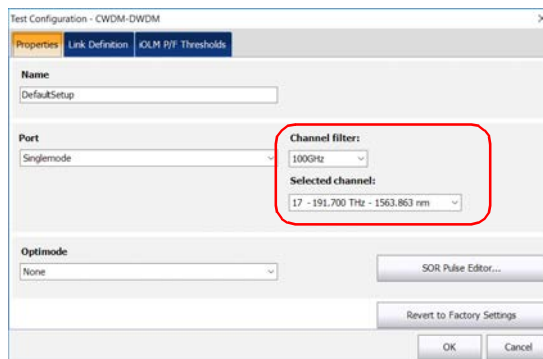

Managing Test Configurations

Setting the Test Configuration Properties

- 7. Select the Optimode you will use for your test.

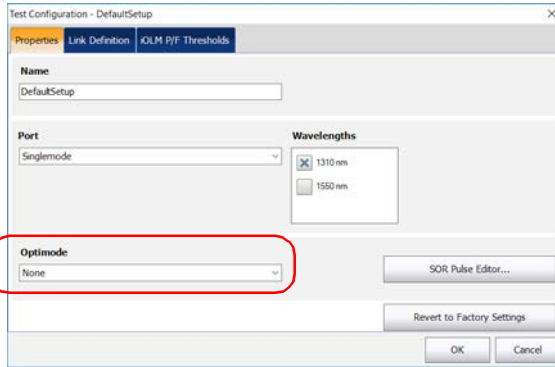

- 8. If you want to select the wavelengths that will be used when generating files in the .sor Bellcore format and you want to specify the pulse width and acquisition time, proceed as follows:

- 8a. Tap the **SOR Pulse Editor** button.

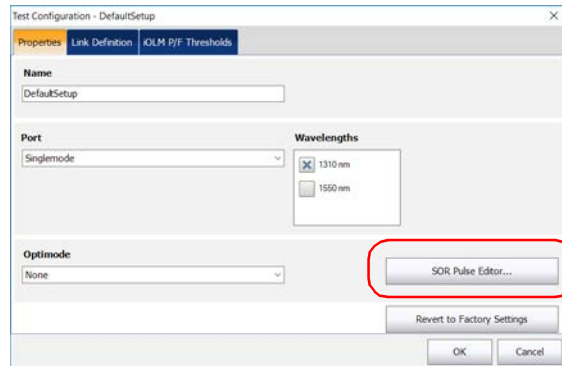

- 8b.** Select the new pulse width and acquisition time values to use. You can let the acquisition use the most appropriate pulse value using the auto mode, or you can select values manually. The acquisition can generate up to three traces with different pulse values.

SOR Custom Pulse Editor

1st Trace 2nd Trace 3rd Trace

Pulse: 3 ns 5 ns 10 ns

Acquisition time: 5 s

Wavelength: SM 1310 nm 1550 nm

Note: This function allows you to specify a pulse width in your iOLM configuration. This pulse width will be applied when exporting files to the OTDR Bellcore (.sor) format in the iOLM application.

OK Cancel

Managing Test Configurations

Setting the Test Configuration Properties

- 8c.** Select the duration of the acquisition in the list of available choices.

SOR Custom Pulse Editor

1st Trace 2nd Trace 3rd Trace

Pulse: 3 ns 5 ns 10 ns

Acquisition time: 5 s

Wavelength: SM 1310 nm 1550 nm

Note: This function allows you to specify a pulse width in your iOLM configuration. This pulse width will be applied when exporting files to the OTDR Bellcore (.sor) format in the iOLM application.

OK Cancel

- 8d.** If needed, select the wavelengths to use. The Auto setting will use all wavelengths selected for the acquisition to create the .sor files. If you select SM or MM, you can specify the specific wavelengths for which you want to create the files.

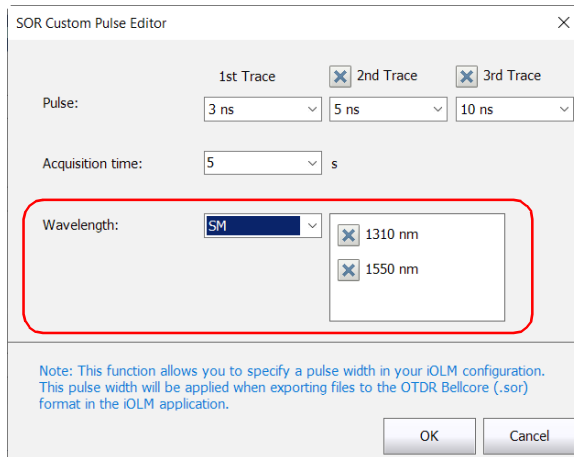

- 8e.** Tap **OK** to exit the **SOR Custom Pulse Editor** window.
- 9.** Tap **OK** to confirm your changes and close the window. Tap **Cancel** to ignore your changes and close the window.

Managing Test Configurations

Defining the Link for Your Test

Defining the Link for Your Test

You can set many criteria to define the link related to a specific test configuration.

You can specify a fiber type for the link in your configuration. The available fiber types will differ depending on if you have a singlemode or a multimode module.

Note: *You can only change the fiber type if the ICERT software option is enabled on the unit.*

Available Ports	Fiber Type	Fiber Core	Comments
Singlemode or Singlemode Live	Unspecified	Various	<ul style="list-style-type: none">▶ You will have to chose the fiber type in the iOLM tab.▶ All of the possible standards are listed in the iOLM P/F Thresholds tab.
	OS1	Singlemode 9 μ m	Fiber jacket is yellow.
	OS2		Low water peak fiber designed for CWDM operation. Fiber jacket is yellow.

Available Ports	Fiber Type	Fiber Core	Comments
Multimode	Unspecified	Various	<ul style="list-style-type: none"> ➤ You will have to choose the fiber type in the iOLM tab. ➤ All of the possible standards are listed in the iOLM P/F Thresholds tab.
	OM1	Multimode 62.5 μm	Modal bandwidth: 200-500 MHz·km. Fiber channel designation: M6. Fiber jacket is orange or slate.
	OM2	Multimode 50 μm	Modal bandwidth: 500 MHz·km. Fiber channel designation: M5. Fiber jacket is orange.
	OM3		Modal bandwidth: 1500-2000 MHz·km. Laser optimized (VCSEL) at 850 nm. Fiber channel designation: M5E. Fiber jacket is aqua.
	OM4		Modal bandwidth: 3500-4700 MHz·km. Laser optimized (VCSEL) at 850 nm. Fiber channel designation: M5F. Fiber jacket is aqua or violet.

Managing Test Configurations

Defining the Link for Your Test

Available Ports	Fiber Type	Fiber Core	Comments
Singlemode and Multimode	Unspecified	Various	<ul style="list-style-type: none"> ➤ You will have to choose the fiber type in the iOLM tab. ➤ All of the possible standards are listed in the iOLM P/F Thresholds tab.
	OS1	Singlemode 9 μm	Fiber jacket is yellow.
	OS2		Low water peak fiber designed for CWDM operation. Fiber jacket is yellow.
	OM1	Multimode 62.5 μm	Modal bandwidth: 200-500 MHz·km. Fiber channel designation: M6. Fiber jacket is orange or slate.
	OM2	Multimode 50 μm	Modal bandwidth: 500 MHz·km. Fiber channel designation: M5. Fiber jacket is orange.
	OM3		Modal bandwidth: 1500-2000 MHz·km. Laser optimized (VCSEL) at 850 nm. Fiber channel designation: M5E. Fiber jacket is aqua.
	OM4		Modal bandwidth: 3500-4700 MHz·km. Laser optimized (VCSEL) at 850 nm. Fiber channel designation: M5F. Fiber jacket is aqua or violet.

The list of certification standards in the **iOLM P/F Thresholds** tab will be filtered according to the type of fiber selected. To see the complete list of standards, select the unspecified fiber type.

When you select a fiber type (other than unspecified) in the test configuration, the application performs a consistency check relative to the previously selected standards and lets you know if there are problems.

The number of custom elements and splitters is used to calculate the dynamic loss budget of the custom thresholds. However, these elements are not used for cabling certification.

To better suit your needs, you can modify the IOR and backscatter (dB) values according to the core size you have selected. However, you cannot select the core size for the 1550 nm wavelengths.

Another criterion that you can edit is called custom elements. They allow you to apply specific thresholds to components of your link under test so that you can obtain a pass or fail status.

You can select between basic element types: splice, connector, coupler, or splitter. Each element type is represented by a specific default icon. You can also use your own images to represent the basic element types as long as the images are 54 x 54 pixels and in .png format. This can be useful to indicate a specific event on a link. You can retrieve images from the default folder (Public Documents/Custom Elements) or from another folder of your choice. Once they are created, the custom elements can be modified at any time or removed, according to your testing needs.

Reverting to factory settings resets the icons of the basic element types and recreates the Public Documents/Custom Elements folder if it is missing. It does not erase the images you have already created.

Note: *You can edit the custom elements you have created only if the IADV software option is enabled on the unit.*

If needed, you can edit the macrobend detection threshold value. If you do not define one, the application will apply the default value of 0.5 dB automatically when you load a test configuration.

Managing Test Configurations

Defining the Link for Your Test

To create a custom element using the default icon:

1. From the Public Documents/Custom Elements folder, make a copy of an existing image.

Note: It is easier to use the Default.png icon and to customize it.

2. Change the name of the image.
3. Modify the image according to your needs.

Note: The image must be 54 x 54 pixels and in .png format.

4. Save the image.

To define the link for your test configuration:

1. From the Main Menu, tap Test Configuration.

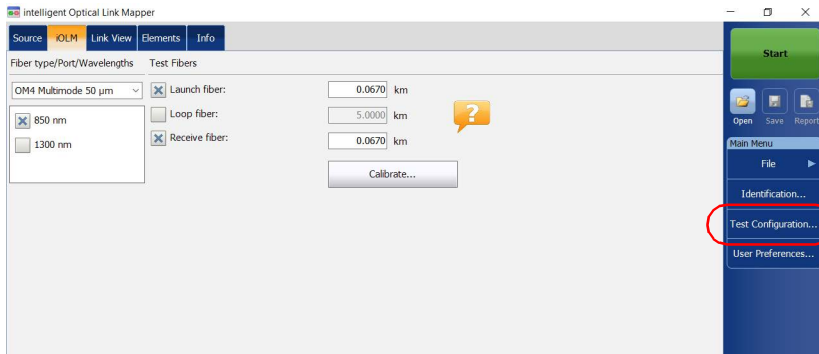

2. Select the configuration you want to edit and tap **Modify**.

3. Select the **Link Definition** tab.

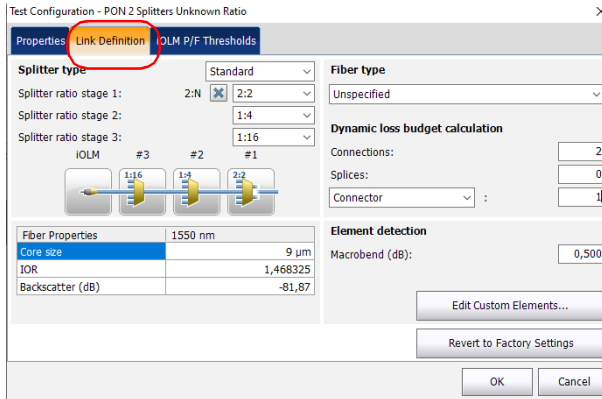

4. If you do not want to use splitters for your tests, go to step 5. To work with splitters on PONs, see *Working on PONs* on page 109. OR

See *Working on Unbalanced PONs (MAX-730/FTBx-730/735/ MAX-740C and D and FTBx-730D/740C and D Units Only)* on page 113 to define values for all splitters on a link.

5. If the ICERT software option is activated, select the fiber type in the list of available choices.

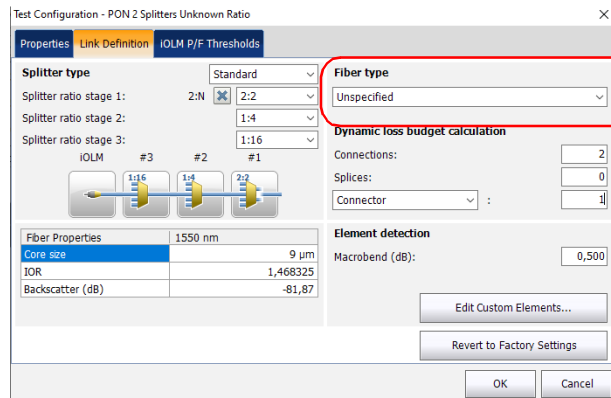

Managing Test Configurations

Defining the Link for Your Test

- 6. If the ICERT software option is activated, specify the number of connections on your link.

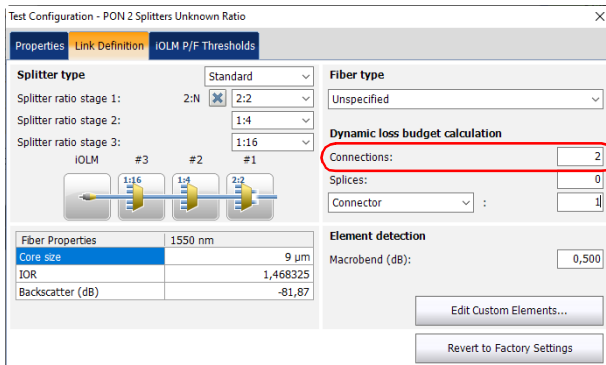

- 7. If the ICERT software option is activated, specify the number of splices on your link.

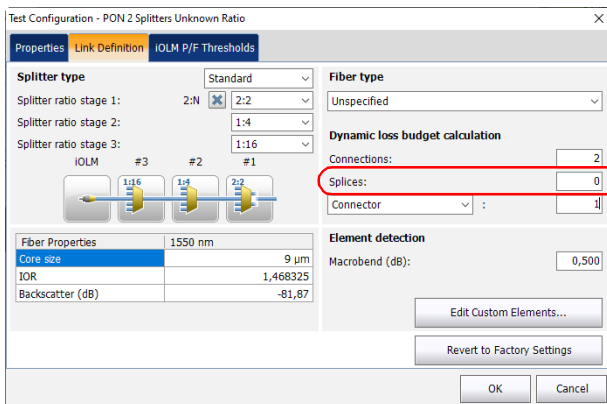

8. If the IADV software option is activated and you want to edit the custom elements, proceed as follows:

8a. Tap the **Edit Custom Elements** button.

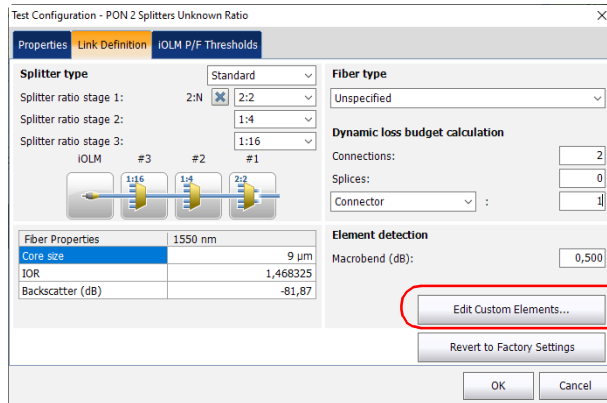

- 8b.** In the **Custom Elements** dialog box, if you want to add a custom element or modify the name of an existing element, enter the new name in the **Name** column.

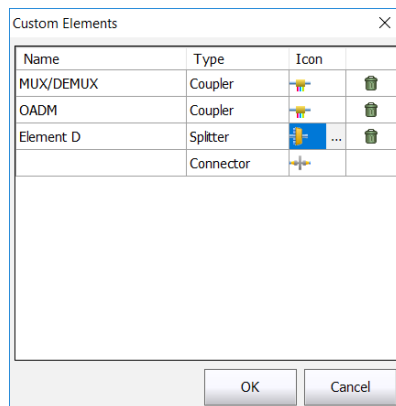

Note: The name of the custom element can contain a maximum of 12 characters.

Managing Test Configurations

Defining the Link for Your Test

- 8c. Select the custom element type under the **Type** column.
- 8d. If desired, under the **Icon** column, tap the icon that you want to modify. The  button appears to allow you to select your image.

Note: The custom icons are located in the default folder unless you have changed the path. The icons must be 54 x 54 pixels.

Note: Tap the  icon beside the custom element which you want to delete.

- 8e. Tap **OK** to save the changes and close the dialog box, or tap **Cancel** to exit without saving.

Note: The **Revert to Factory Settings** button does not change the modifications made in the **Custom Elements** dialog box. It only resets the icons of the basic element types and recreates the Public Documents/Custom Elements folder if it is missing.

- 9. If the ICERT software option is activated and you want to use the custom elements that you have previously created in the calculation of the dynamic loss budget, proceed as follows:

- 9a. Select a custom element in the list of available choices.

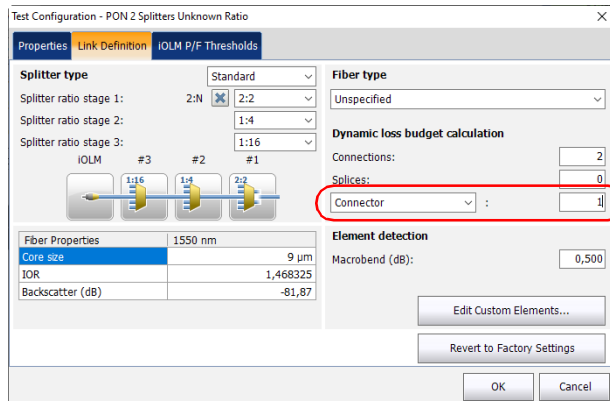

- 9b. Specify the number of elements you want to add on the link.

10. Under Fiber Properties, you can modify the Core size, IOR and Backscatter (dB) values.

When a multimode port is selected, the default fiber core size is 50 μm .

Refraction index of the measurement, also known as *group index*.

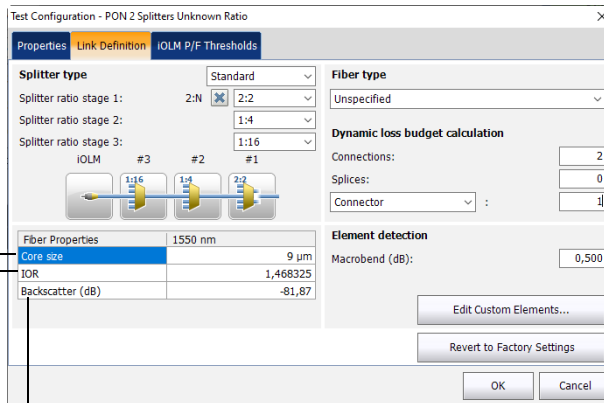

Represents the Rayleigh backscatter coefficient setting of the measurement.

Note: The core size cannot be modified for the 1550 nm wavelength.

Note: For the multimode wavelengths, the values are defined at 850 nm while the values are defined at 1550 nm for the singlemode wavelengths. The iOLM application automatically calculates the IOR and backscatter values for other wavelengths.

Managing Test Configurations

Defining the Link for Your Test

11. If necessary, specify a macrobend detection value.

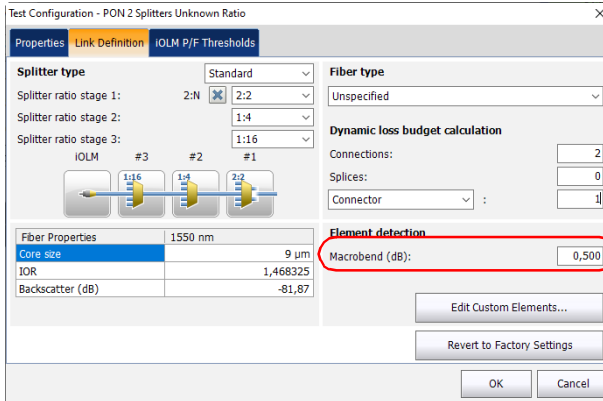

12. Tap **OK** to confirm your changes and close the window. Tap **Cancel** to ignore your changes and close the window.

Working on PONs

Working on PONs allow you to define splitter ratios for a specific link. The PON can have multiple splitters. The iOLM application supports testing a PON having a maximum of three splitters.

When setting splitter ratio stage 1, the 2:N splitter can be used to create network redundancy. If a network break occurs, the operator can connect through the other network branch. This ensures active communication while the repair of the broken network is in progress.

To work on PONs:

1. From the **Main Menu**, tap **Test Configuration**.

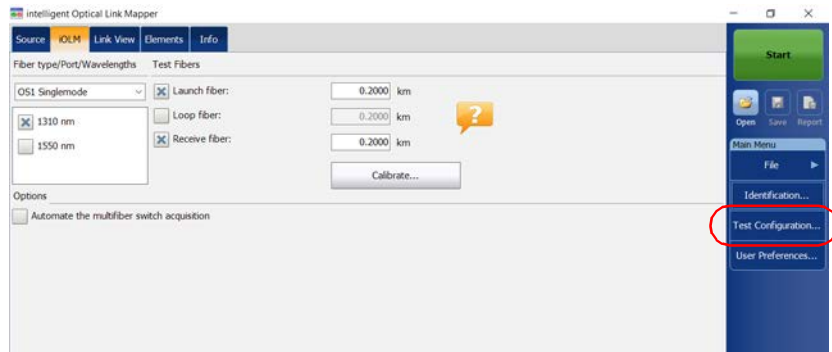

2. Select the configuration you want to edit and tap **Modify**.

Managing Test Configurations

Defining the Link for Your Test

3. Select the **Link Definition** tab.

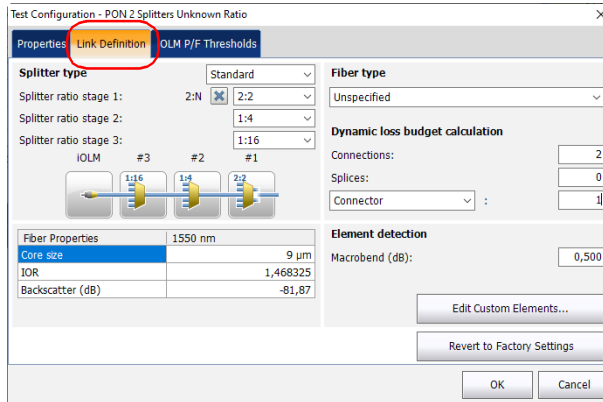

4. If you have a standard iOLM, select **Standard** to work with splitters on PONs.

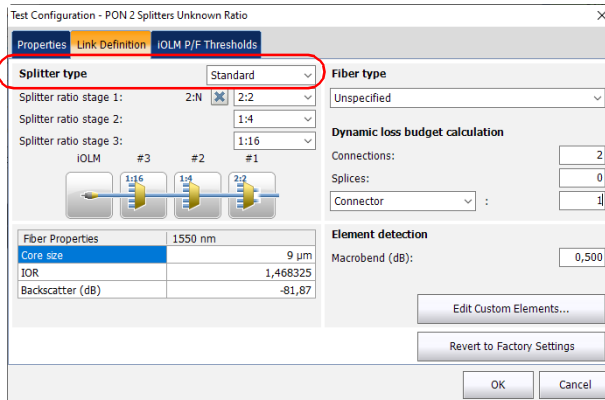

5. If you have a DWDM or a CWDM module, go directly to step 7.

OR

If you have a standard iOLM, select the split ratio of a splitter at a given stage.

- Select **1:?** if the splitter ratio is unknown. The iOLM finds the splitter ratio automatically and the element is not tested for pass/fail.
- If **None** is selected, the iOLM will not try to find or apply a split ratio at the given stage.

Note: The splitter ratios are defined at different stages, depending on how they are defined in the network.

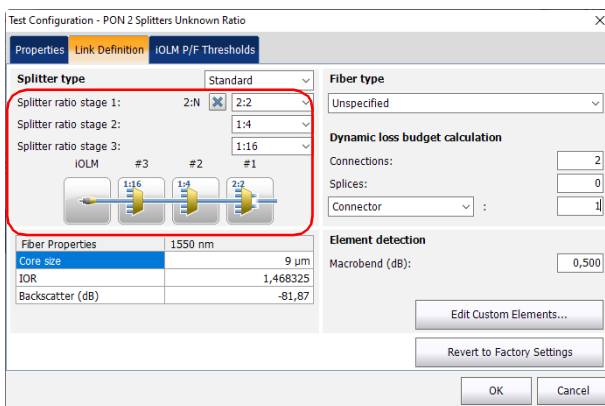

Note: The 1:N splitter and 2:2 splitter elements do not support the bidirectional loopback measurements.

Managing Test Configurations

Defining the Link for Your Test

6. If the IADV software option is activated, you can enable the **2:N splitter** for the **Splitter ratio stage 1** field by selecting the check box.

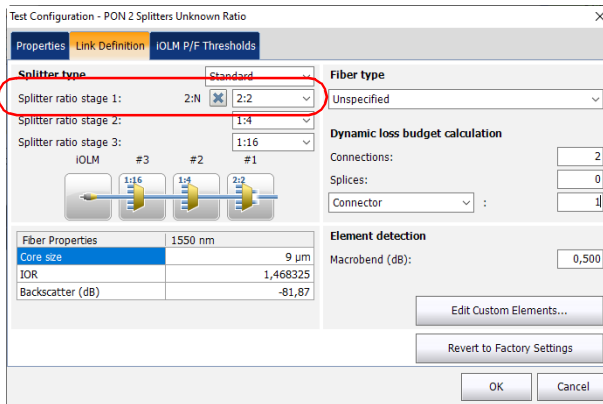

Note: The 1:N splitter and 2:2 splitter elements do not support the bidirectional loopback measurements.

Note: When 1:? or None is selected and you have enabled the 2:N splitter option, the 1:? and None are replaced by a splitter value of 2:2.

7. To set other parameters for your link, see *Defining the Link for Your Test* on page 98.

Working on Unbalanced PONs (MAX-730/FTBx-730/735/ MAX-740C and D and FTBx-730D/740C and D Units Only)

Note: *Optimodes are not supported if you are working on unbalanced PONs.*

The splitters used to work on unbalanced PONs divide the light signal unevenly between two splitter ports. By default, the first splitter in a sequence has a 1:8 ratio and is represented by 90/10.

This means that 90% of the light is going through the cable and continues to the next splitter in the cascade of splitters along the cable.

The other 10% is used for either one or several customers under this specific splitter port.

The ratio of all splitters in the cascade can change (for example 80/20, 85/15) depending on the amount of light necessary for each customers.

You can have a sequence of 12 unbalanced splitters representing the network you want to test, but it is also possible to use a standard splitter at the beginning and at the end of the sequence of cascaded splitters.

All sequences of unbalanced splitters start from the CO/OLT (Central Office/Optical Line Terminal).

Managing Test Configurations

Defining the Link for Your Test

To work on unbalanced PONs:

1. From the Main Menu, tap Test Configuration.

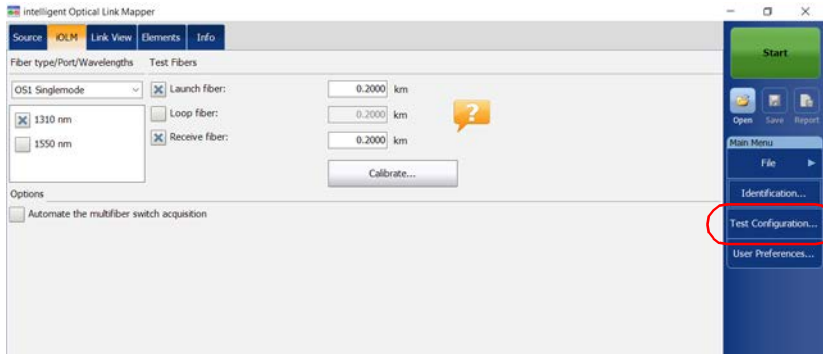

2. Select a configuration with at least one unbalanced splitter and tap **Modify**.
3. Select the **Link Definition** tab.

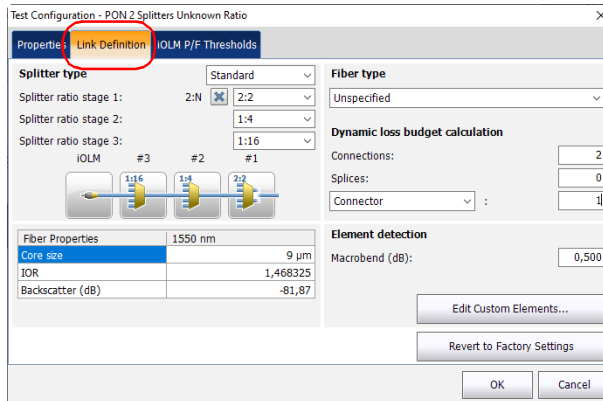

4. If you have a standard iOLM, select **Unbalanced**.

Test Configuration - PON 2 Splitters Unknown Ratio

Properties | Link Definition | iOLM P/F Thresholds

Splitter type Unbalanced

Summary:
Stand.-2 | 80-8 | 70-8 | 70-8 | 70-8 | 70-8 | 70-8 | 70-8 | 70-8 | 70-8 | Stand.-8

Unbalanced Splitter Settings

Fiber Properties	1550 nm
Core size	9 μm
IDR	1,468325
Backscatter (dB)	-81,87

Fiber type Unspecified

Dynamic loss budget calculation

Connections: 2
Splices: 0

Element detection

Macroband (dB): 0,500

Edit Custom Elements...
Revert to Factory Settings

OK Cancel

5. Select **Unbalanced Splitter Settings** to define values for all splitters on a cable.

Test Configuration - PON 2 Splitters Unknown Ratio

Properties | Link Definition | iOLM P/F Thresholds

Splitter type Unbalanced

Summary:
Stand.-2 | 80-8 | 70-8 | 70-8 | 70-8 | 70-8 | 70-8 | 70-8 | 70-8 | 70-8 | Stand.-8

Unbalanced Splitter Settings

Fiber Properties	1550 nm
Core size	9 μm
IDR	1,468325
Backscatter (dB)	-81,87

Fiber type Unspecified

Dynamic loss budget calculation

Connections: 2
Splices: 0

Element detection

Macroband (dB): 0,500

Edit Custom Elements...
Revert to Factory Settings

OK Cancel

Managing Test Configurations

Defining the Link for Your Test

6. To represent the network you want to test, proceed as follows:
 - 6a. In the **Unbalanced Splitter Settings** window, select a splitter and its associated ratio using the values in the box.

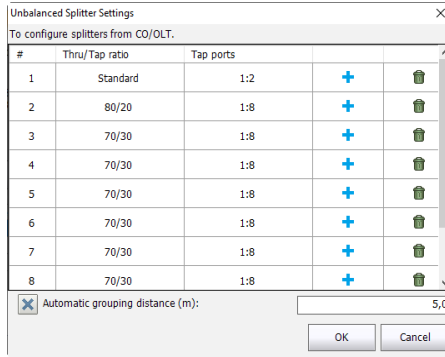

Note: You can remove a splitter from the list by using the 🗑️.

- 6b. If you want the application to group the splitters automatically to a connector if they are within a set distance, select the corresponding option, then enter the desired value.

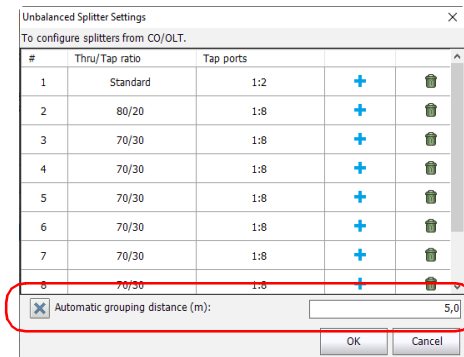

- 6c. Tap **OK** when the network you want to test is correctly defined.
7. Tap **OK** in the **Link Definition** tab.

8. Tap **Close** in the **Test Configuration** window.
9. In the **iOLM** tab, the network you have defined is represented graphically. Tap the box corresponding to the element you want to test.

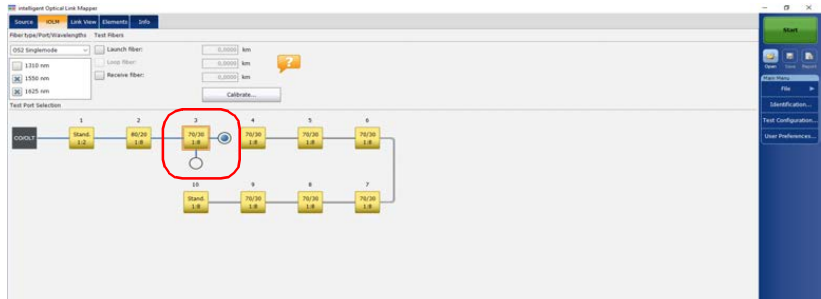

Managing Test Configurations

Defining the Link for Your Test

- 10. Tap the blue dot corresponding to what you want to test: light going through the cable or all customers under a specific splitter.

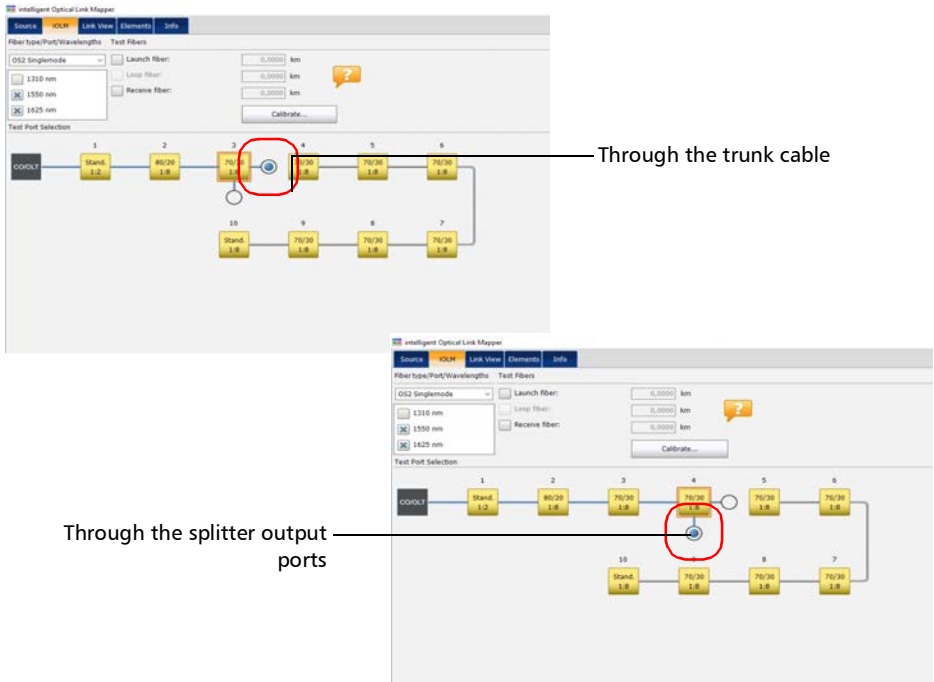

- 11. To set other parameters for your link, see *Defining the Link for Your Test* on page 98.

You are now ready to start the acquisition. The test will be performed from the selected test point.

Selecting Certification Standards

Note: *This function is available with the ICERT software option only.*

The committees and standards configurations you can choose from are grouped by categories. You can select more than one standard and you can select standards from different categories at the same time; the most restrictive values of the selected standards are then used to determine if the test results in a pass or fail status.

Standards are divided into two main categories:

- *Cabling:* Ensures that the connections and splices are made properly and cumulate fewer losses than the normally expected maximum values. The thresholds are adjusted according to the number of connections and splices, and the thresholds also take into account the normal attenuation of the fiber. They can vary from one type of fiber to another and according to the length of the link. These thresholds do not take into account the limitations of specific communication protocols. There are international standards, but also versions that are more regional, such as for Europe, or specific countries. These standards can evolve with time according to technological progresses. It is therefore important to know which standard to refer to, because the thresholds can be different. Some examples of cabling standards include TIA-568, ISO/IEC 14763 and ISO/IEC 11801.
- *Application:* These standards are used to validate that a given link can allow a flow according to a communication protocol. They rest on fixed thresholds, which are maximum link loss and length values. These thresholds do not take into account the link topology (number of connections and splices). A short link could, for instance, allow more connections than a longer link. The important factor is to remain within the specified fixed thresholds. Examples of application standards include Ethernet and Fibre Channel.

Managing Test Configurations

Selecting Certification Standards

When a cabling standard is selected, you will need to manually provide the number of connections and splices to correctly calculate the link loss budget (see *Defining the Link for Your Test* on page 98 for details). The more there are connections and splices, the greater the link loss budget is. Predefined standards are available for you to select, or you can create a custom setting.

To select predefined certification standards:

1. From the **Main Menu**, tap **Test Configuration**.

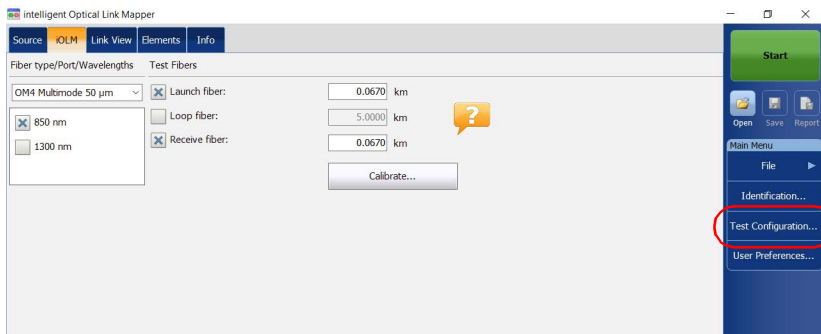

2. Select the configuration you want to edit and tap **Modify**.
3. Select the **iOLM P/F Thresholds** tab.



4. In the available items of the configuration, select the certification committee you want and tap the  button at the end of the row.

Note: Depending on the category you select, you may have to tap  again to access the list of available certification types.

5. Select which items of this certification type you want to include.

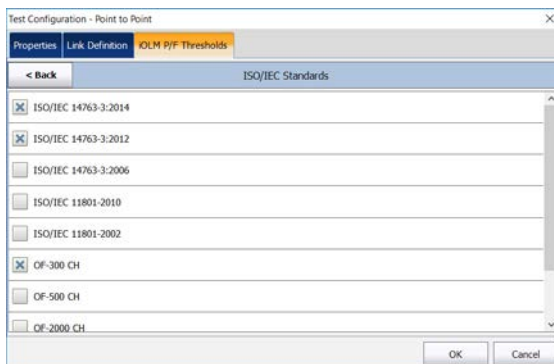

6. Tap **Back** to go to the previous level and select other standards as needed.
7. Tap **OK** to confirm your changes and close the window. Tap **Cancel** to ignore your changes and close the window.

Managing Test Configurations

Selecting Certification Standards

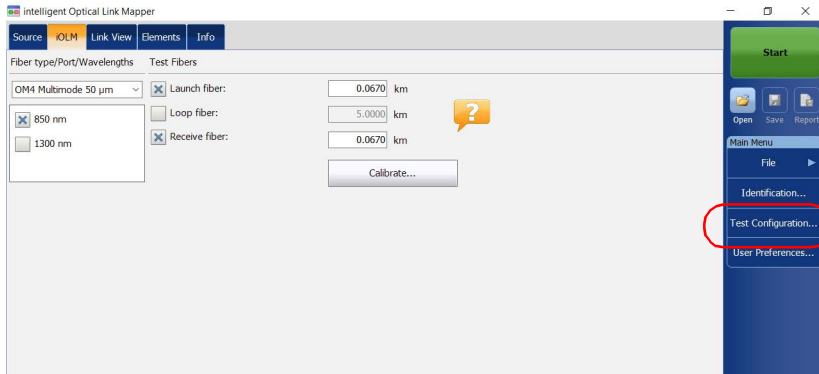

To create custom pass/fail thresholds for fixed or dynamic loss budget:

1. From the **Main Menu**, tap **Test Configuration**.

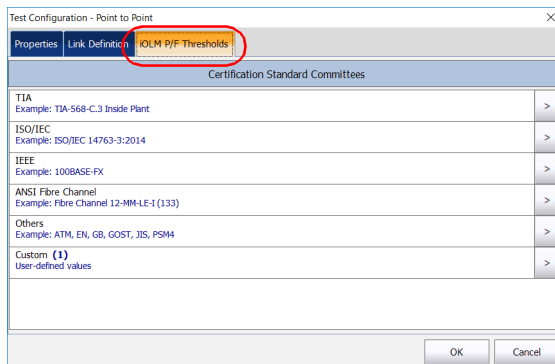

2. Select the configuration you want to edit and tap **Modify**.
3. Select the **iOLM P/F Thresholds** tab.



4. In the available items of the configuration, select **Custom** and tap the  button at the end of the row.
5. Tap the  button at the end of the row again to access the custom threshold window.
6. When the ICERT software option is activated, select the dynamic loss budget that fits your needs according to the chosen fiber type:
 - Fixed: You can specify threshold values for the fiber section attenuation, as well as the minimum and maximum link loss values, for each wavelength. You can also set values for the maximum link ORL (Optical Return Loss), and the minimum and maximum link length.

Note: *The attenuation threshold value is measured only if the analysis allows the calculation of the attenuation on the fiber section.*

The ORL represents the total effect of multiple reflections and scattering events within a fiber-optic system.

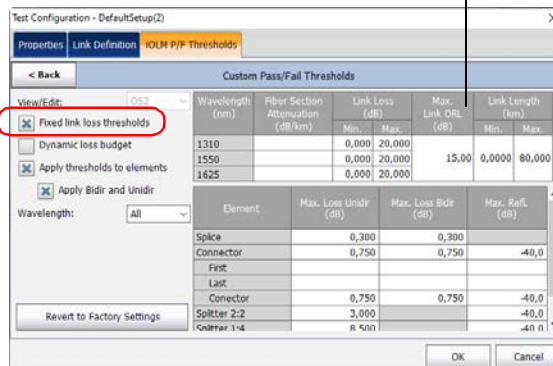

Managing Test Configurations

Selecting Certification Standards

- **Dynamic:** The dynamic loss budget is calculated according to the fiber length and the elements included in the link definition (such as the number of splices, connections, custom elements, as well as splitters).

Note: The dynamic loss budget feature is not available for unbalanced splitters.

Note: You can only use one custom element type in the dynamic loss budget calculation.

The link attenuation, as well as the loss values for the splices, connections, and the first and last connections will all be used to calculate the loss budget.

If there is no specific value for the first or last connector, the application will use the value specified for connectors in general.

The screenshot shows the 'Custom Pass/Fail Thresholds' dialog box. The 'Dynamic loss budget' checkbox is checked and highlighted with a red circle. Below it, there are checkboxes for 'Apply thresholds to elements' and 'Apply Bidir and Unidir'. The 'Wavelength' dropdown is set to 'All'. The dialog contains two tables of threshold values.

Wavelength (nm)	Link Attenuation (dB/km)	Max. Link ORL (dB)	Link Length (km)	
			Min.	Max.
1310	1,000			
1550	1,000	15,00	0,0000	80,000
1625	1,000			

Element	Max. Loss Unidir Budget (dB)	Max. Loss Bidir Budget (dB)	Max. Refl. (dB)
Splice	0,300	0,300	
Connector	0,750	0,750	-40,0
First			
Last			
Connector	0,750	0,750	-40,0
Splitter 2:2	3,000		-40,0
Splitter 1:4	3,000		-40,0

- You can also activate both options at the same time. The more restrictive thresholds of the two type will be considered when testing.

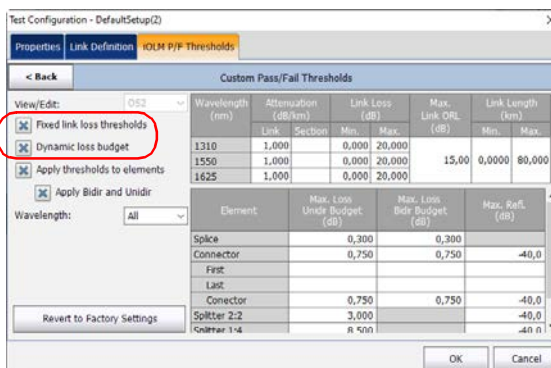

When the fiber type is specified in the link definition (see *Defining the Link for Your Test* on page 98 for details), you can edit thresholds for this fiber type only. If you have selected unspecified as the fiber type, you can specify threshold values for each available fiber type.

Enter the values you want to use as thresholds in the corresponding cell tables.

Note: *The minimum link length and link loss cannot be greater than the maximum link length and link loss.*

Managing Test Configurations

Selecting Certification Standards

7. Select the **Apply thresholds to elements** check box to edit the maximum loss (dB) and maximum reflectance (dB) for the splice and connector.



IMPORTANT

An empty cell in the link threshold table means **NO THRESHOLD** is applied on the acquisition. If you want to set zero as a threshold value, enter 0 in the corresponding cell.

Test Configuration - DefaultSetup(2)

Properties | Link Definition | **IOLM P/F Thresholds**

< Back Custom Pass/Fail Thresholds

View/Edit: 052

Fixed link loss thresholds

Dynamic loss budget

Apply thresholds to elements

Apply Bidir and Unidir

Wavelength: All

Revert to Factory Settings

Wavelength (nm)	Attenuation (dB/km)		Link Loss (dB)		Max. Link ORL (dB)	Link Length (km)	
	Link	Section	Min.	Max.		Min.	Max.
1310	1,000		0,000	20,000			
1550	1,000		0,000	20,000	15,00	0,....	Bl,....
1625	1,000		0,000	20,000			

Element	Max. Loss Under Budget (dB)	Max. Loss Bidir Budget (dB)	Max. Refl. (dB)
Splice	0,300	0,300	
Connector	0,750	0,750	-40,0
First			
Last			
Connector	0,750	0,750	-40,0
Splitter 2:2	3,000		-40,0
Splitter 1:4	8,500		-40,0

OK Cancel

No threshold is applied when the corresponding cell is empty.

Value used for first and last connectors when corresponding cells are empty.

- If you want to apply the bidir and unidir thresholds, select the corresponding option.

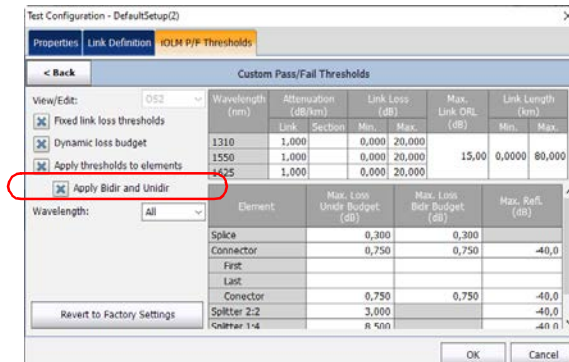

Note: When you select this option, the **Max. Loss** column on the right side of the window will split into two columns to show the unidir and bidir values instead. You can thus set different values for both types of tests.

Note: This feature is not available for multimode wavelengths.

Managing Test Configurations

Setting Custom Power Meter Thresholds

9. Select the wavelength on which you want to apply the customized pass/fail thresholds.

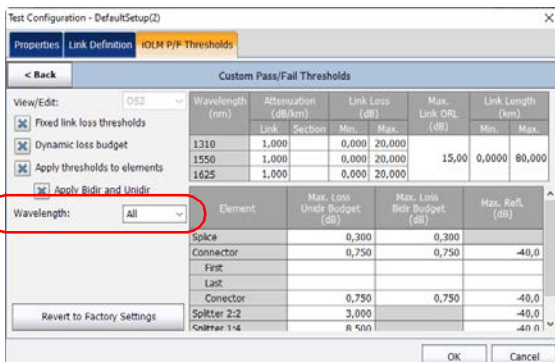

10. Tap **Back** to return to the previous menu and set other configuration items. Tap **OK** to confirm your changes and close the window. Tap **Cancel** to ignore your changes and close the window.

Setting Custom Power Meter Thresholds

You can set thresholds for the maximum and minimum power, as well as the loss value for each wavelength you have set in the user preferences. See *Setting Custom Power Meter Thresholds* on page 163 for details.

Note: The *OPM P/F Thresholds* tab will only be available if an inline power meter is present in the module.

Modifying a Test Configuration

The test configurations you have created or imported can be modified to better fit your requirements.

Note: Depending on the type of unit or measurement, some configuration items may be unavailable.

To edit a test configuration:

1. From the Main Menu, tap **Test Configuration**.

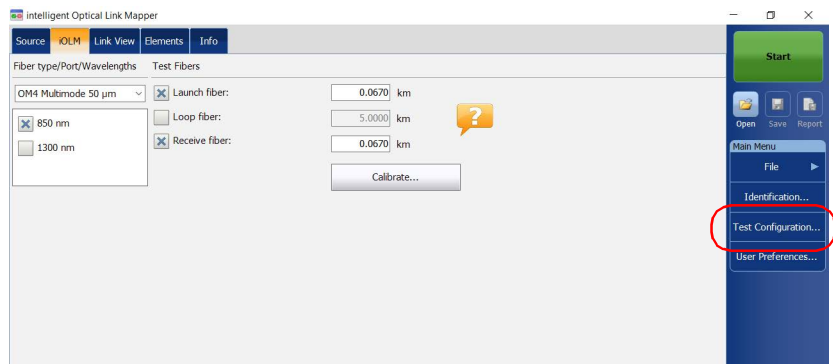

2. Select the configuration you want to edit and tap **Modify**.
3. Change the criteria as required. See *Creating a Test Configuration* on page 89 for details.

Importing a Test Configuration

You can import test configurations from an external storage device.



IMPORTANT

Some threshold values may be different when a test configuration file is imported. If the thresholds differ for a given wavelength, the application uses the most restrictive threshold values.

Note: *To be successfully imported, the test configurations and their duplicates need to be compatible with the hardware and software options available on the unit.*

Note: *If a USB device is connected to the module, the default path for import will be the USB device.*

Note: *You can only import one test configuration at a time.*

To import a test configuration:

1. From the **Main Menu**, tap **Test Configuration**.

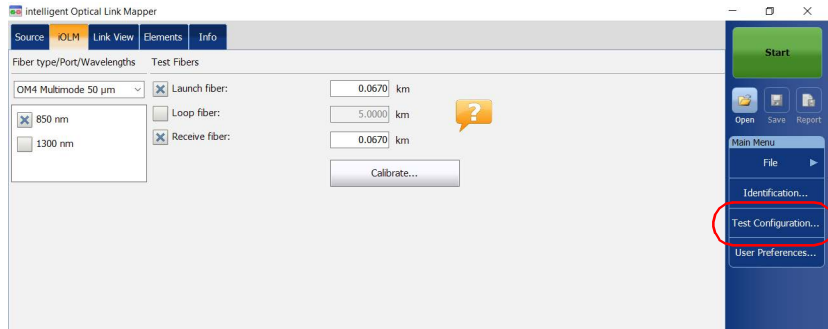

2. From the **Test Configuration** window, tap **Import**.

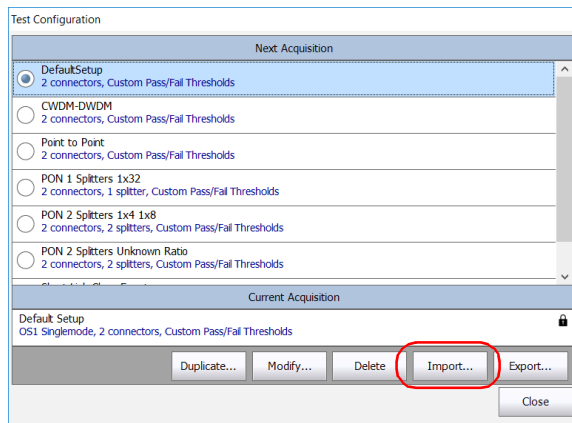

3. Select the file you want to import.
4. Tap **Open** to close the window. The imported configuration is added to the list automatically.

Managing Test Configurations

Exporting a Test Configuration

You can export test configurations to an external storage device.

Note: If a USB device is connected to the module, the default path for export will be the USB device.

Note: You can only export one test configuration at a time.

To export a test configuration:

1. From the Main Menu, tap **Test Configuration**.

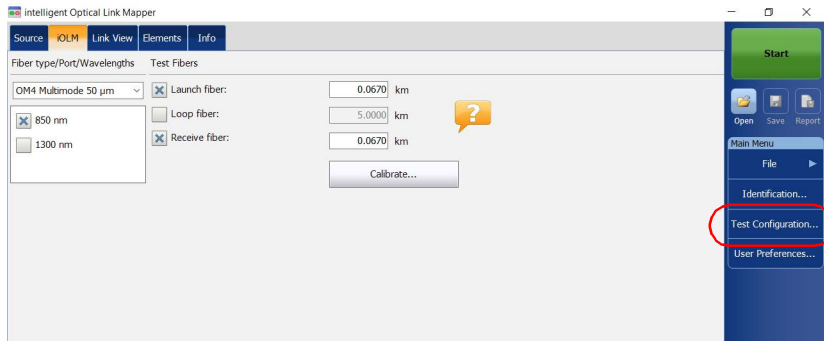

2. From the **Test Configuration** window, select the test configuration you want to export.

3. Tap **Export**.

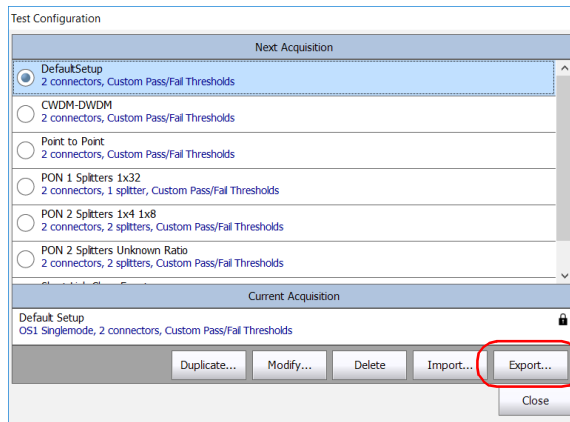

4. Select the folder where you want to export your file.

5. If desired, modify the file name.

6. Tap **Save** to close the window.

Managing Test Configurations

Deleting a Test Configuration

Deleting a Test Configuration

You can remove test configurations from your unit to keep only those relevant for your work.

Note: *You must always have at least one configuration in the test configuration window.*

To delete a test configuration:

1. From the Main Menu, tap **Test Configuration**.

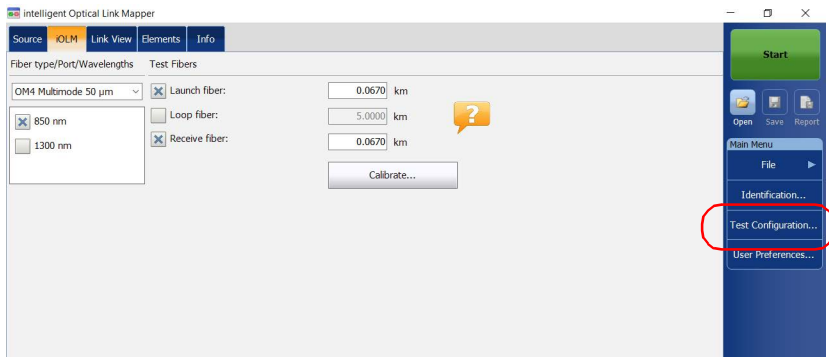

2. Select the row corresponding to the configuration you want to remove, then tap **Delete**.

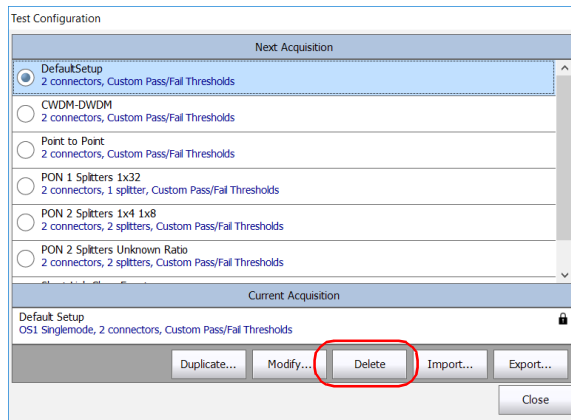

3. Confirm your choice.

8 **Performing Acquisitions**

The iOLM allows you to characterize a fiber-optic span, usually optical fiber sections joined by splices and connectors. The iOLM provides an inside view of the fiber, and can calculate fiber length, breaks, total return loss, as well as splice, connector, and total losses.

Performing a Standard or Loopback Acquisition

When an iOLM acquisition starts, the **Link View** tab is displayed by default.

The progress of the overall acquisition for all wavelengths is displayed in the status bar. For example, if two wavelengths have to be processed, at the end of the first wavelength acquisition, the overall progress will be 50 %.

The current wavelength is displayed in front of the acquisition progress.

You can perform standard and loopback acquisitions with the iOLM. For more information on how to perform a loopback measurement, see *Configuring Your iOLM* on page 42. To perform bidirectional loopback acquisitions, see *Performing a Bidirectional Loopback Acquisition* on page 139.

Performing Acquisitions

Performing a Standard or Loopback Acquisition

To perform an iOLM acquisition:

1. Ensure that the settings for the acquisition are already set. See *Configuring Your iOLM* on page 42 for details.
2. Tap **Start** (for standard and loopback measurements). If you are working with Optimode test configurations, the button will indicate **Start Optimode**.

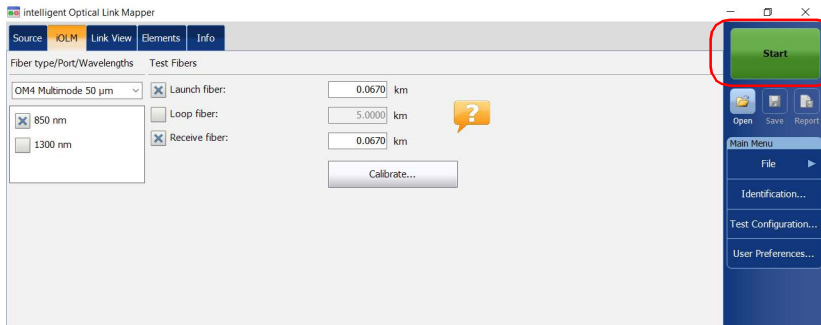

The application will prompt you to save unsaved data (if any) before starting a new acquisition.

Performing a Bidirectional Loopback Acquisition

With the iOLM, you can perform bidirectional loopback acquisitions. The acquisition process is done in two main steps. The first acquisition can be repeated until the results are suitable for your needs. Then, you perform the second acquisition, which can be done only once.

To perform a bidirectional acquisition:

1. Ensure that the settings for the acquisition are already set. See *Configuring Your iOLM* on page 42 for details.
2. Select the **Bidirectional (Loopback only)** checkbox.

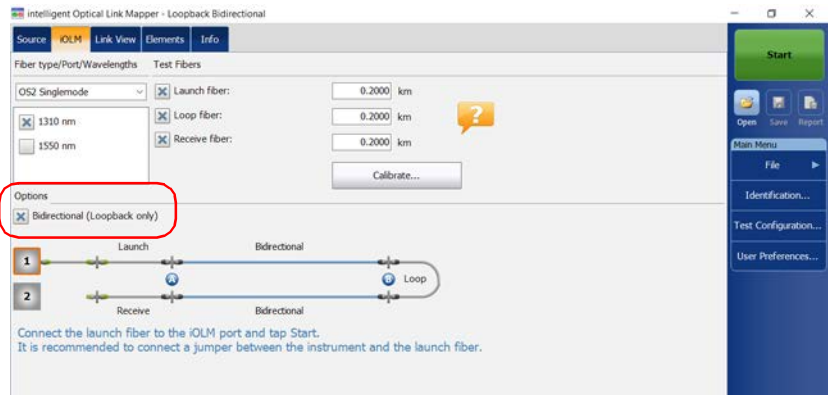

Performing Acquisitions

Performing a Bidirectional Loopback Acquisition

3. Select number **One** or **Two** depending on which direction you want to use to test the link first.

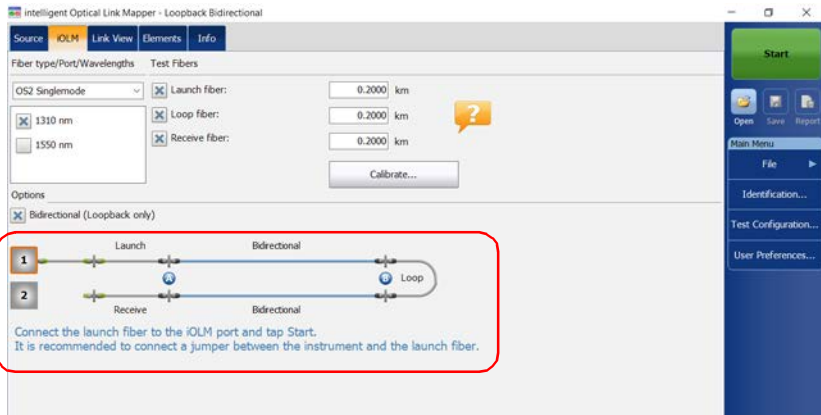

4. Tap **Start**.

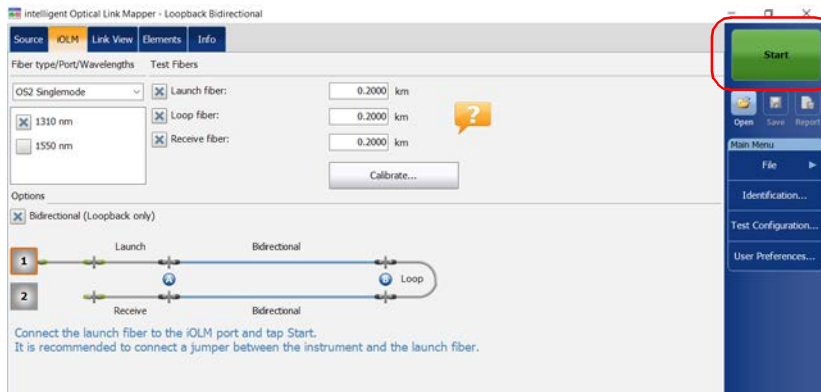

Note: Depending on the number you have selected first, number One or Two turns blue to indicate that the acquisition was made.

Performing Acquisitions

Performing a Bidirectional Loopback Acquisition

5. If you are not satisfied with the result of the first acquisition, or if the application does not split the link, check the acquisition parameters and the fiber that is connected, then tap **Test Again**.

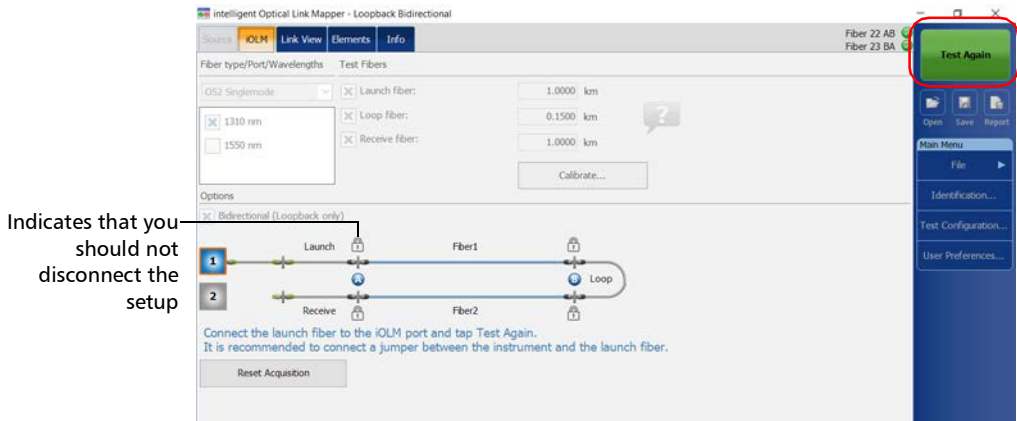

OR

Tap the **Reset Acquisition** button to clear the measurement.

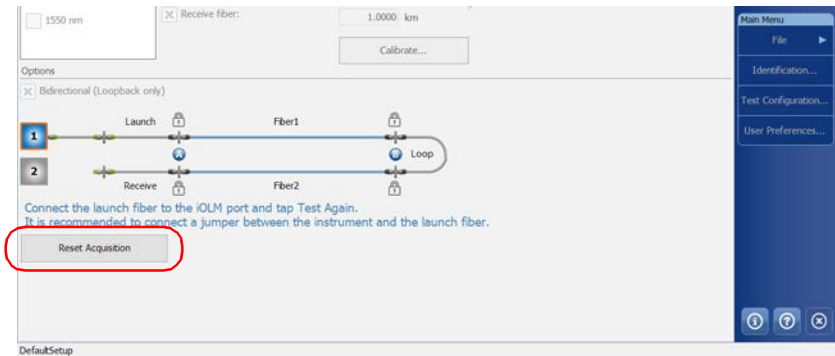

Performing Acquisitions

Performing a Bidirectional Loopback Acquisition

The results of the first acquisition are available in the **Link View** tab.

Pass/Fail results for Link 1 and Link 2

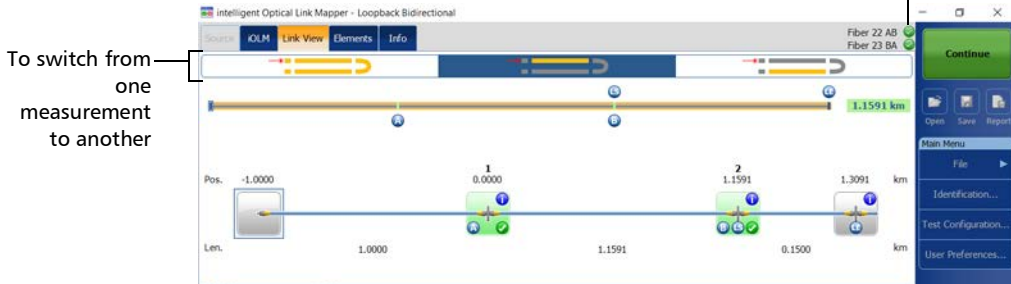

6. Tap **Continue** to perform the second acquisition.

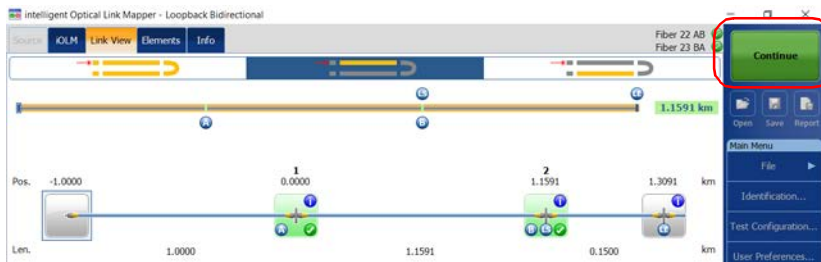

Note: The second acquisition can only be performed once.

When both measurements are split properly, the application generates the bidirectional measurement for the two fibers.

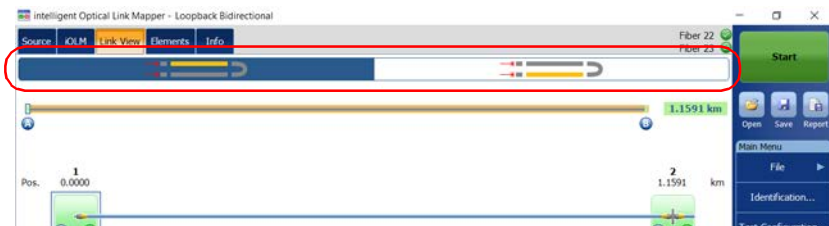

Stopping an Acquisition

The acquisition stops automatically after it is complete. You can also stop the acquisition at any time while it is in progress.

Note: *The unprocessed wavelengths will not be processed when a multiple wavelength acquisition is stopped manually.*

To stop the acquisition:

Tap **Stop** from the main window.

The numbers indicate the port of the switch on which the acquisition is underway.

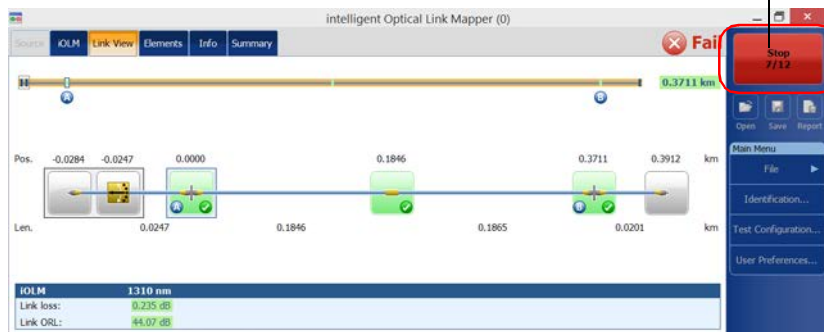

The stopped acquisition status will be saved in the measurement file. It is also displayed in the **Info** tab. See *Viewing Measurement Information* on page 207 for details.

The global pass/fail status will show unknown or fail when the acquisition is stopped manually. See *Global Pass/Fail Status* on page 192 for details.

Note: *A manually stopped acquisition should not be considered as a reliable link measurement. To fully characterize a link, a complete acquisition should be performed.*

Performing Acquisitions

Monitoring Fibers in Real-Time Mode

Monitoring Fibers in Real-Time Mode

The IADV software option enables you to view sudden changes in the fiber link by performing an OTDR acquisition in real-time mode. In this mode, the trace is refreshed until you stop the acquisition.

The OTDR will use the same distance units as the ones used in the iOLM application.

Note: You can only use one wavelength at a time to monitor your fiber.

To activate the real-time mode:

1. From the **Main Menu**, tap the **User Preferences** button, then select the **General** tab.
2. Select the **OTDR real time** check box.

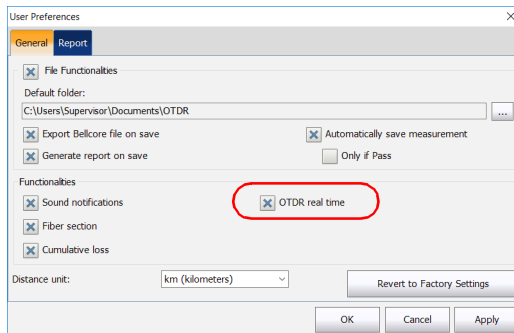

3. Tap **OK** to close the window.

You are now ready to monitor fibers in real-time mode.

To monitor fibers in real-time mode:

1. From the **iOLM** tab, select the desired port (for live-fiber testing, select SM live; for C fiber, select 50 μm and for D fiber, select 62.5 μm).

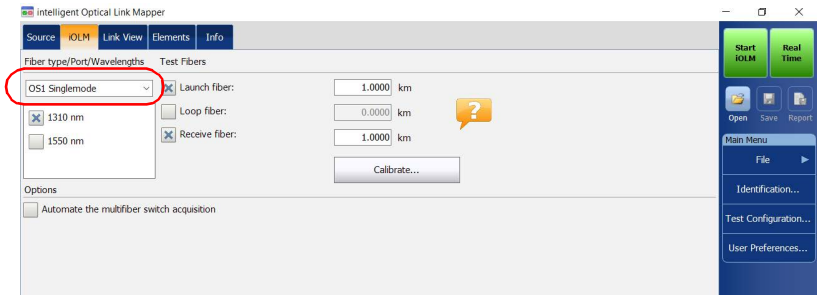

2. Tap **Real Time**.

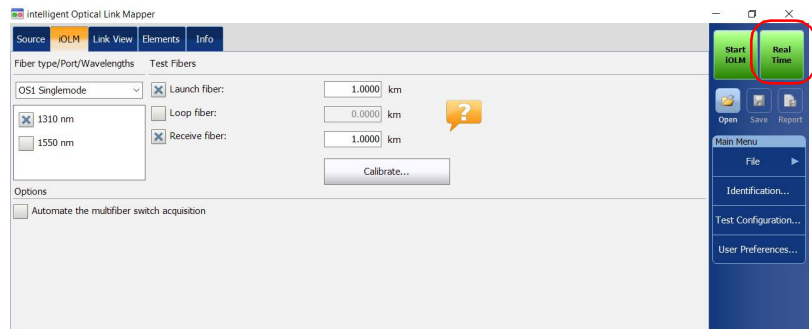

Note: *The timer is not displayed during real-time acquisition.*

3. In the OTDR, from the wavelength list, tap the wavelength value (not the checkbox) corresponding to the wavelength that you want to monitor.

Note: *You can change the range and pulse values during the real-time acquisition.*

Performing Acquisitions

Monitoring Fibers in Real-Time Mode

To exit the real-time mode:

- If you want to stop monitoring and remain in the OTDR, tap **Stop RT**.
- If you want to stop monitoring and start an iOLM acquisition, tap **Start iOLM**.

OR

Tap  to return to the iOLM application without starting an iOLM acquisition.

The iOLM application starts an acquisition with the parameters already set. The parameters set in the OTDR have no impact on the iOLM acquisition.

9 Customizing Your iOLM

You can customize the appearance and behavior of your iOLM application.

Setting the Default Storage Folder

You can change the default storage folder to better suit your needs. You can also work with a USB key. If the USB key is not connected to the device upon saving, the acquisitions are saved in the default storage folder. This path is used to save the iOLM files and OTDR Bellcore (.sor) files after an acquisition.

Note: *The **Save As** button allows you to save your files to a folder different from the default storage folder. If you change the storage folder from the **Save As** dialog box, it will be used the next time you use the **Save As** feature again. The default storage folder will not be modified.*

To set the default storage folder:

1. From the **Main Menu**, tap the **User Preferences** button, then select the **General** tab.
2. If you want to modify the default storage folder, select the **File Functionalities** check box.

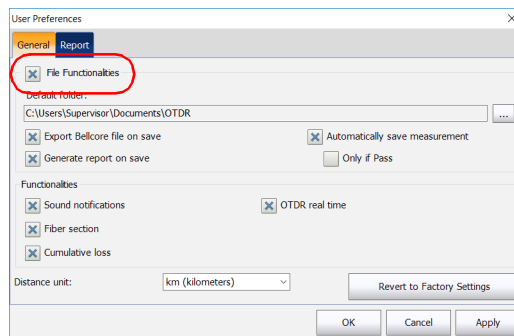

Customizing Your iOLM

Saving Files in Bellcore Format

3. Tap the  button next to **Default folder**.
4. In the **Browse For Folder** window, select the location where you want to save the file.
5. Tap **OK** to exit the **Browse For Folder** window.
6. Tap **OK** to return to the main window.

Saving Files in Bellcore Format

If this feature is selected, whenever an iOLM bidirectional measurement is saved, three OTDR Bellcore (.sor) files are generated for each wavelength selected:

- one SOR file for A-B direction
- one SOR file for B-A direction
- one SOR file with the averaged loss of the elements

The wavelength value and the direction are appended to the file name and are separated with an underscore.

Upon saving, the files are sent to the default folder you have defined. See *Setting the Default Storage Folder* on page 147 for details.

To save files in Bellcore format:

1. From the **Main Menu**, tap the **User Preferences** button, then select the **General** tab.
2. If you want to save files in Bellcore format, select the **File Functionalities** check box.

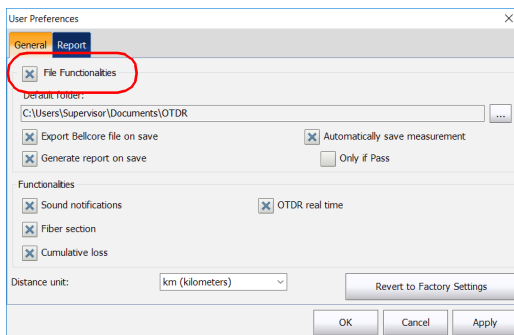

3. Select the **Export Bellcore file on save** check box.

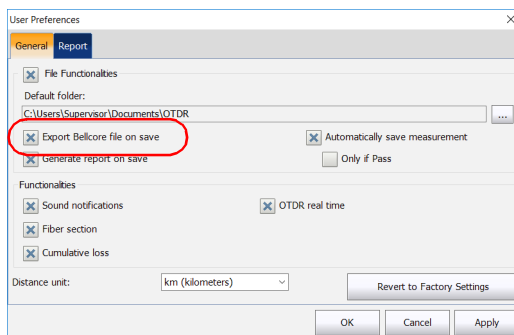

4. Tap **OK** to return to the main window.

Customizing Reports

You can generate reports directly from your unit in PDF format. Various items can appear on the report. When the IPRO or ILOOP software option are activated, you can generate a loopback measurement report that combines all links into one report as opposed to separate ones.

If you want to generate a report automatically each time a measurement is saved, see *Activating the Automated Report Creation* on page 151 for details. You can also generate a report manually. See *Generating a Report* on page 215 for details.

Note: *You can only generate PDF reports for loopback measurements.*

To customize reports:

1. From the **Main Menu**, tap the **User Preferences** button, then select the **Report** tab.
2. Select the check boxes according to your needs.

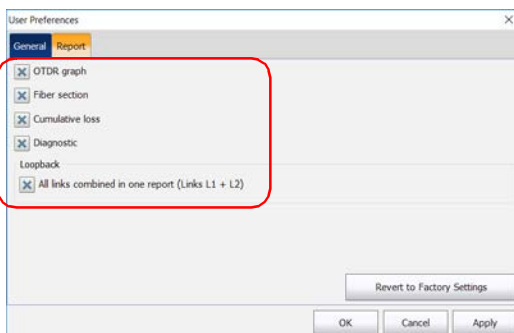

Note: *The OTDR graph generation fails if the iOLM measurement does not contain the necessary intermediate OTDR data, if the iOLM acquisition process is interrupted by the user, or it is self interrupted because a live fiber is detected.*

3. Tap **OK** to return to the main window.

Activating the Automated Report Creation

You can create a report based on the acquisitions results. When you activate the automated report creation feature, a report is automatically sent in the default folder you have defined each time a measurement is saved. See *Setting the Default Storage Folder* on page 147 for details.

If you want to generate a report manually, see *Generating a Report* on page 215 for details. To select the items that can appear on a PDF report, see *Customizing Reports* on page 150 for details.

To activate automated report creation:

1. From the **Main Menu**, tap the **User Preferences** button, then select the **General** tab.
2. If you want to generate a report automatically upon saving, select the **File Functionalities** check box.

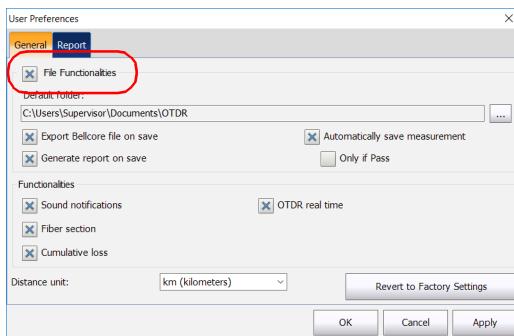

Customizing Your iOLM

Activating the Automated Report Creation

3. Select the **Generate report on save** check box.

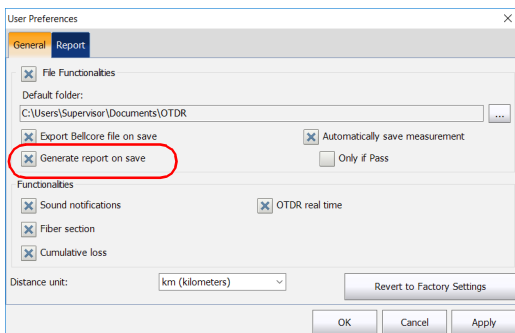

4. Tap **OK** to return to the main window.

Enabling or Disabling Sound Notifications

The application can emit a sound to inform you that important events are detected or when the acquisition sequence is complete.

To enable or disable sound notifications:

- 1.** From the **Main Menu**, tap the **User Preferences** button, then select the **General** tab.
- 2.** If you want to enable sound notifications, select the **Sound notifications** check box.

OR

If you prefer to disable sound notifications, clear the box.

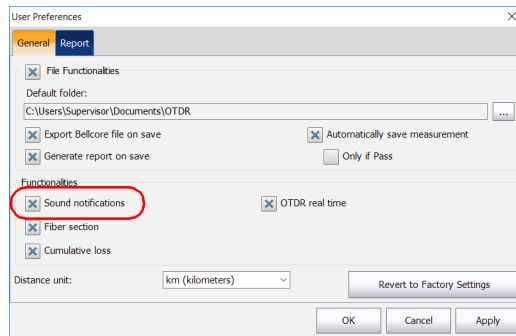

- 3.** Tap **OK** to close the window.

Displaying or Hiding Fiber Sections

You can select the section in the link view and the corresponding details of the selected section to be displayed in the **Elements** table.

To display or hide fiber sections:

1. From the **Main Menu**, tap the **User Preferences** button, then select the **General** tab.
2. If you want to display fiber sections, select the **Fiber section** check box.

OR

If you prefer to hide fiber sections, clear the box.

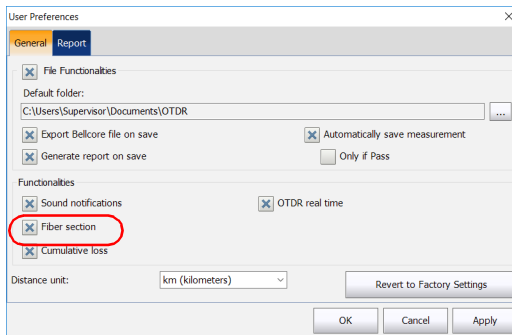

3. Tap **OK** to close the window.

Selecting the Distance Units

You can select the distance units that will be used throughout the application.

To select the distance units:

1. From the **Main Menu**, tap the **User Preferences** button, then select the **General** tab.
2. Select the distance unit in the list of available choices.

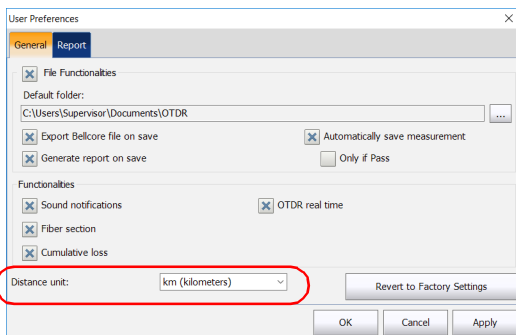

3. Tap **OK** to close the window.

Enabling or Disabling the Automatic Storage of the Files

By default, the application does not save the measurements automatically after an acquisition. However, you can configure it to save the measurements automatically. You can also specify if you prefer to store all the measurements regardless of the results, or only when the results have a pass status.

This feature is not available if you are working with the optical switch.

To enable or disable the automatic storage of the files:

1. From the **Main Menu**, tap the **User Preferences** button, then select the **General** tab.
2. Select the **File Functionalities** check box.

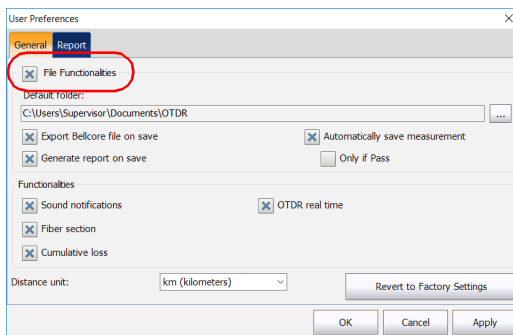

3. Select whether you want the measurements to be stored automatically regardless of the results, or only when the results have a pass status.

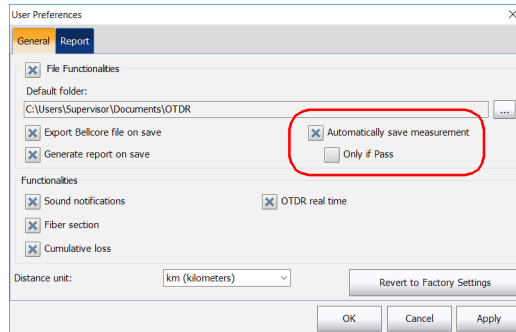

Note: *If the measurement was not automatically stored and you want to keep it, you will have to store it manually.*

4. Tap **OK** to return to the main window.
The changes are applied automatically.

10 Understanding Diagnostics

Diagnostics are used to provide additional information about detected problems or ambiguous measurement situations, such as root cause possibilities for the fail status of a link element. The diagnostics provide help to troubleshoot faulty connectors, understand why link elements are tagged as fail or unknown, indicate unexpected instrumentation or test conditions and so forth. More than one diagnostic can be associated with any given element.

Elements diagnostics are associated with specific link elements issues. Each failed link element will have associated diagnostics to assist in troubleshooting. Some elements, such as macrobends, will have associated diagnostics even with a pass status.

To view the diagnostics:

From the **Link View** or **Elements** tab, tap on the  icon next to the result you want to see.

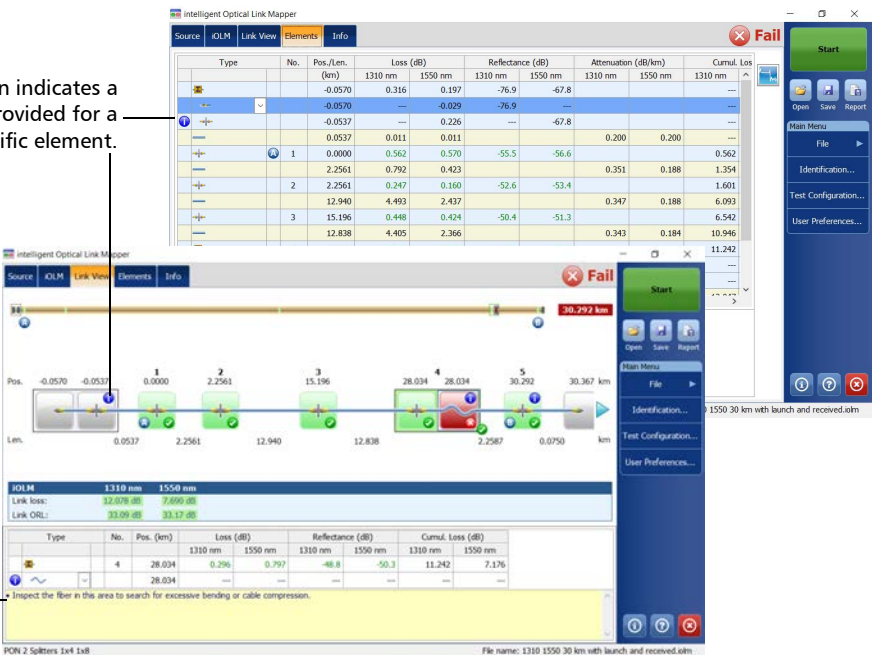

The icon indicates a diagnostic is provided for a specific element.

Diagnostic details.

Type	No.	Pos. (km)	Loss (dB)		Reflectance (dB)		Attenuation (dB/km)		Cumul. Loss
			1310 nm	1550 nm	1310 nm	1550 nm	1310 nm	1550 nm	
		-0.0570	0.316	0.197		-76.9	-67.8		
		-0.0570		-0.029		-76.9			
		-0.0537		0.226			-67.8		
		0.0537	0.011	0.011			0.200	0.200	
	1	0.0000	0.562	0.570		-55.5	-56.6		0.562
	2	2.2561	0.792	0.423			0.351	0.188	1.254
		12.940	0.247	0.160		-52.6	-53.4		1.601
		12.940	4.493	2.437			0.347	0.188	6.093
	3	15.196	0.448	0.424		-50.4	-51.3		6.542
		12.838	4.405	2.366			0.343	0.184	10.946

Type	No.	Pos. (km)	Loss (dB)		Reflectance (dB)		Cumul. Loss (dB)		
			1310 nm	1550 nm	1310 nm	1550 nm	1310 nm	1550 nm	
	4	28.034	0.296	0.797		-48.8	-50.3	11.242	7.176
		28.034							

Inspect the fiber in this area to search for excessive bending or cable compression.

PON 2 Splitters 1x4 1x8 File name: 1310 1550 30 km with launch and received.odm

11 ***Using the Inline Power Meter (Optional on Some Models)***

Your unit may be equipped with an inline power meter allowing you to perform acquisitions.

Note: *The OPM tab will not be available if no inline power meter is available for your unit.*

Understanding the Inline Power Meter

The inline power meter in your module measures the power of the link through the SM live port, which is also used for iOLM measurements.

Minimum and maximum power threshold values are displayed in the same window used to display the current power meter value. The pass/fail thresholds wavelength are the same as the current power meter reading.

The inline power meter can be equipped with two-channels for taking the power meter measurements at multiple wavelengths at once.

When two power meter values are displayed, one for each channel, according to the wavelength, two sets of minimum and maximum power threshold values are displayed side by side, one for each channel. Both values will be refreshed at the same time.

Using the Inline Power Meter (Optional on Some Models)

Understanding the Inline Power Meter

A visual representation of the power value for each channel is displayed and updated each time a new power value is measured. This visual representation of power value gives an idea of the power on a scale and power level versus pass/fail thresholds.

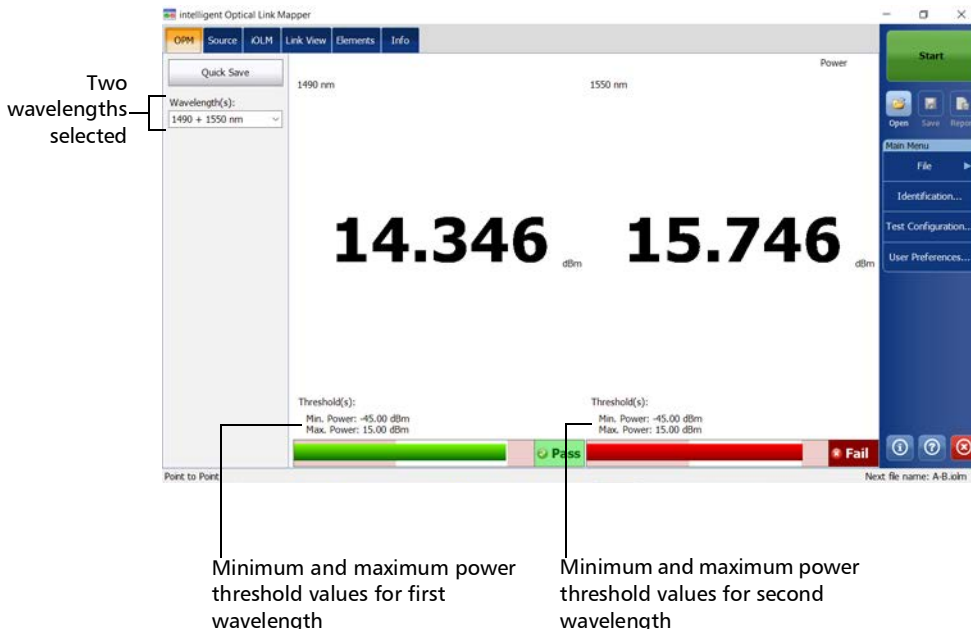

Setting Custom Power Meter Thresholds

You can set thresholds for the maximum and minimum power, and select the wavelength for which the different pass/fail threshold values can be specified. The available choices of wavelength depends on the iOLM module and the measurement mode you have selected for your tests. See *Selecting the Measurement Mode* on page 165 for details.

To set the power meter threshold values:

1. From the **Main Menu**, tap **Test Configuration**.

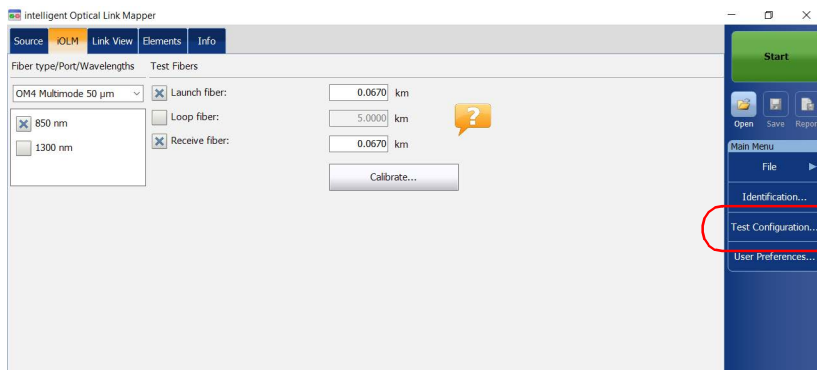

2. Select the configuration you want to edit and tap **Modify**.

Using the Inline Power Meter (Optional on Some Models)

Setting Custom Power Meter Thresholds

3. Select the **OPM P/F Thresholds** tab.

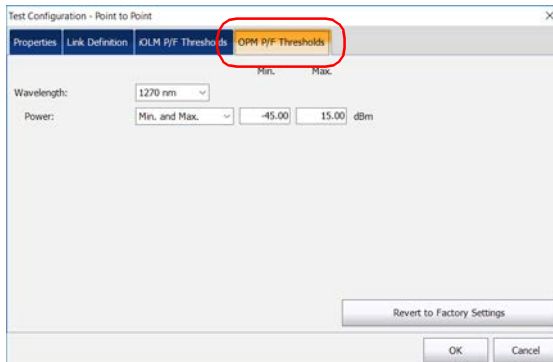

4. Enter the desired values for the minimum and maximum power, and select the wavelength for which the different pass/fail threshold values can be specified.

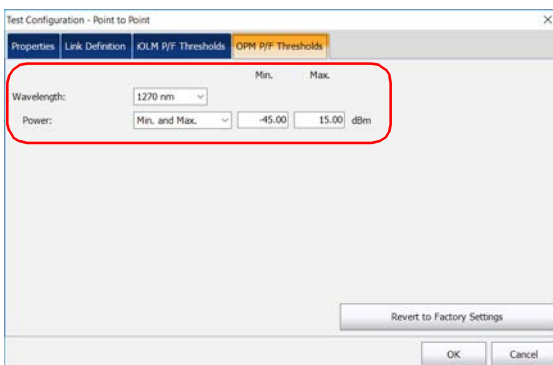

Note: *Any* will be displayed in the list of available wavelengths only if more than one wavelength is present. If you choose **Any**, the threshold values will be applied to all wavelengths present in the drop-down box.

5. Tap **OK** to confirm your changes and close the window. Tap **Cancel** to ignore your changes and close the window.

Selecting the Measurement Mode

You can use the optical power meter in two different modes. This will have an impact on the available wavelengths displayed in the **OPM** tab of the main window.

- You can use the FTTx/PON mode during service activation (at ONT) or to troubleshoot passive optical networks (at ONT, drop terminal, fiber distribution hub or CO). Depending on the configuration of the unit, you can measure more than one wavelength simultaneously.
- The CWDM mode is particularly useful if you want to measure networks or devices carrying only one wavelength. You can measure the output power (in dBm) or loss (in dB) using one of the CWDM wavelengths available.

To select the measurement mode:

1. From the **Main Menu**, tap **User Preferences**.

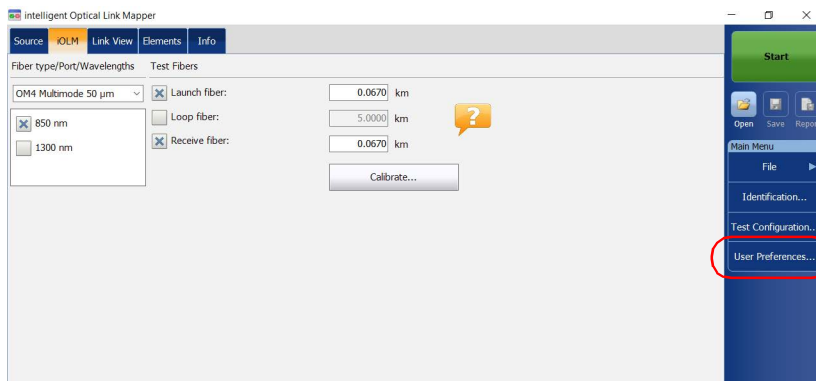

Using the Inline Power Meter (Optional on Some Models)

Selecting the Measurement Mode

2. Select the **OPM** tab.

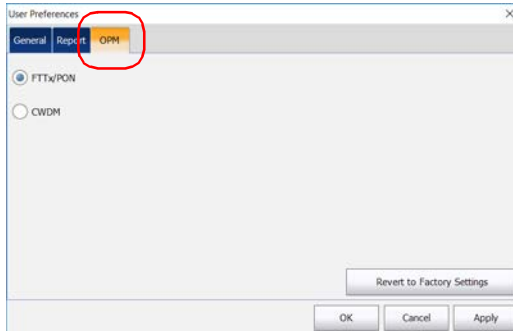

3. Select the power meter mode.

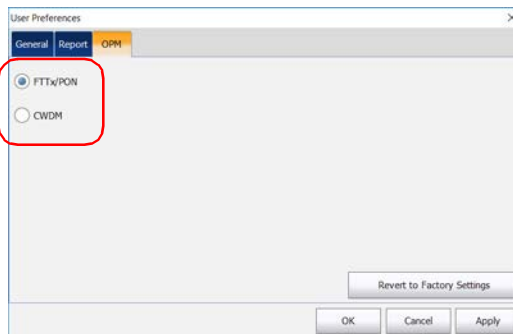

Note: The selection of the power mode will have an impact on the available wavelengths displayed in the **OPM** tab of the main window.

4. Tap **Apply** to save the changes.
5. Tap **OK** to close the window. Tap **Cancel** to exit without saving.

Measuring Power Levels

The power meter level is refreshed in real time and can help you decide if an iOLM acquisition is required to identify the cause and location of a problem. Depending on your iOLM unit, you can select which wavelength you want to use from the list of available wavelengths. If no wavelength is selected, you cannot perform a power meter acquisition.

You can save the current power levels in a file for future reference and you can view this file anytime by loading it in the iOLM application.

The power levels are also displayed in the **Link View** tab under **OPM**.

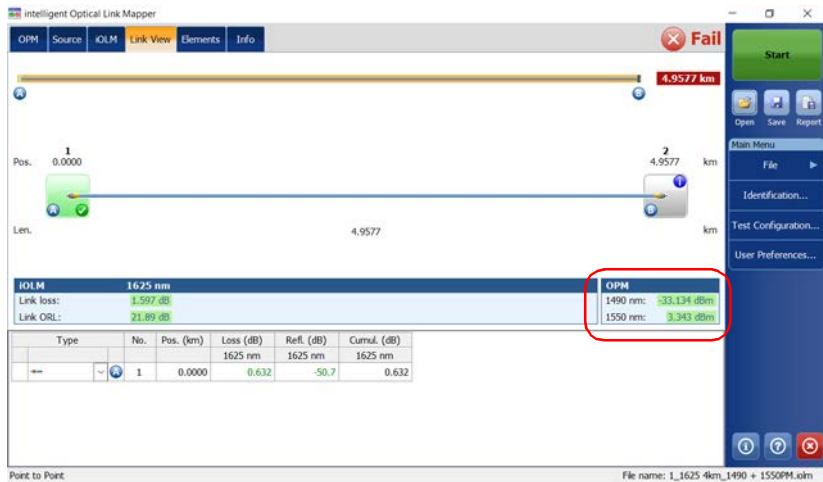

Using the Inline Power Meter (Optional on Some Models)

Measuring Power Levels

To measure power levels:

1. Select the **OPM** tab.
2. Select the wavelengths at which you want to measure the power levels.



3. Tap **Quick Save** to save the power levels into a file.

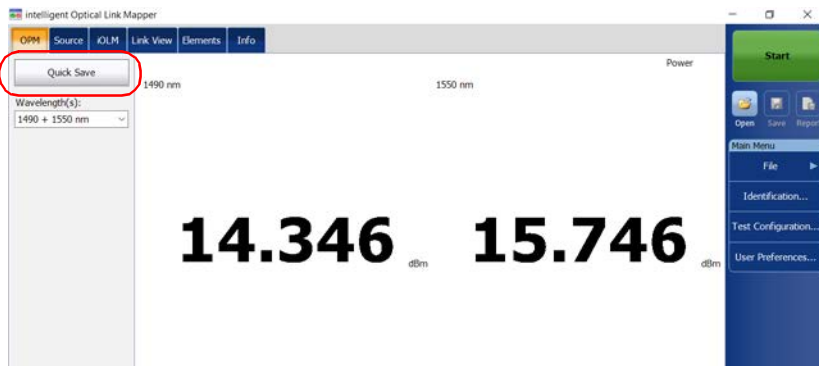

Note: Upon saving, the file is automatically sent to the default folder you have defined in the user preferences. See *Setting the Default Storage Folder* on page 147 for details.

Performing an iOLM Acquisition with a Power Meter

The iOLM and power meter acquisition is performed together to save the iOLM acquisition results along with the power levels (power meter acquisition results) in a file for future reference.

The measurements are taken at the wavelengths selected from the list of available wavelengths.

The wavelengths used to take the power meter measurement during iOLM acquisition process are the same as those used to display power levels in real-time.

Note: *The power meter acquisition is taken on the SM live port of the iOLM.*

To perform an iOLM acquisition with a power meter:

1. Select the **OPM** tab.
2. Select the wavelengths at which you want to take the power meter measurements.



Note: *Two power levels are considered for measurement when two wavelengths are selected from the **Wavelength(s)** drop-down box.*

Using the Inline Power Meter (Optional on Some Models)

Performing an iOLM Acquisition with a Power Meter

3. Select a Singlemode Live port and the iOLM wavelengths from the **iOLM** tab.

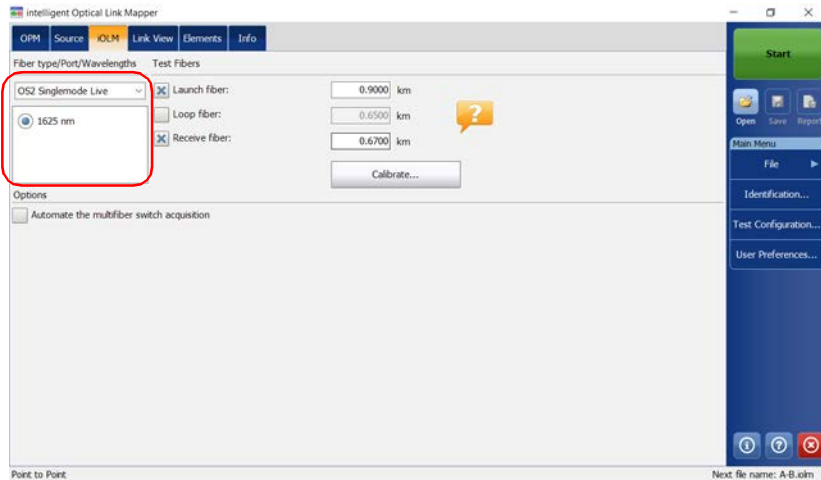

4. Tap **Start**.

12 Using Your Module as a Source

You can operate the existing OTDR laser as a source to perform power meter measurements at the other end of the fiber. With this method, you can quickly locate the correct fiber or perform loss measurements.

To use the OTDR as a source:

1. From the main window, tap the **Source** tab.
2. If you have a standard iOLM, select the desired wavelength in the list of available choices.

OR

If you have a DWDM or a CWDM module, select a channel filter and a specific channel. See *Working With the DWDM Module* on page 63 or *Working With the CWDM Module* on page 73 for details.

Standard iOLM



DWDM and CWDM modules



Note: If you have a DWDM or a CWDM module, the parameters set in the **iOLM** tab are applied automatically in the **Source** tab. See *Working With the DWDM Module* on page 63 or *Working With the CWDM Module* on page 73 for details.

3. Select the desired modulation in the list of available choices.
 - For loss measurement, with a power meter at the other end, select **Continuous**.



IMPORTANT

intelligent Optical Link Mapper can be used in continuous source mode (CW) to perform optical power measurements and it is compatible only with the following: high power Germanium (GeX) versions of the 300 and 600 Series, the PX1-H and PX1-PRO-H, as well as any unit's built-in GeX power meters.

The EPM-50 power meter and MPC-100 power checker are not compatible for measurements using an intelligent Optical Link Mapper in Continuous setting.

- For fiber identification, select **270 Hz** (7xxD Series), **330 Hz**, **1 kHz** or **2 kHz**. This will allow the person at the other end of the link to identify the fiber under test, which could be particularly useful when working with cables containing many fibers.

For easier fiber identification, the application also offers a flashing pattern. If you select this pattern, the modulated signal (1 KHz or 2 KHz) will be sent for 1 second, then will be off for the next second, then be sent again for 1 second, and so on. If you want the OTDR to emit light in a flashing pattern, select **1 kHz + Blink** or **2 kHz + Blink**.

Standard iOLM



DWDM and CWDM modules



Using Your Module as a Source

4. Tap **Turn On**. You can stop light emission at any time by tapping **Turn Off**.

Standard iOLM

The color red indicates that the source is active.

Point to Point Source: 1550 nm (SM)

DWDM and CWDM modules

CWDM-DWDM Source: 41 - 194.100 THz - 1544.526 nm

13 Analyzing and Managing Results

Once a measurement is performed, you can view the results in different tabs:

- **Link View:** shows an intuitive representation of a specific link, which combines several measurements results and value into a single view. See *Viewing Results in the Link View* on page 175 for details.
- **Elements:** displays detailed results corresponding to the elements or sections selected in the link view. The loss and reflectance are displayed with appropriate coloring based on the pass/fail status of each value. See *Viewing Results of Elements and Fiber Section Details* on page 195 for details.
- **Info:** indicates information about a measurement, such as the file name, acquisition date, and acquisition status. See *Viewing Measurement Information* on page 207 for details.
- **Summary:** is only available when an externally controlled MPO optical switch is connected to the unit. See *Viewing Multifiber Results* on page 208 for details.

Viewing Results in the Link View

The link view is divided into different regions.

- **Link overview:** displays the entire link from the beginning of the link under test to the end. See *Link Overview* on page 177 for details.
- **Link composition:** displays every element present on the link. Each element (except fiber section) has its own identification number. See *Link Composition* on page 178 for details.
- **iOLM results:** present the acquisition results for all wavelengths at which the iOLM acquisition was performed. See *iOLM Results* on page 189 for details.

Analyzing and Managing Results

Viewing Results in the Link View

- Power meter results (if power meter measurements are taken): present the acquisition results for all wavelengths at which the power meter acquisition was performed. See *Power Meter Results* on page 191 for details.
- Global Pass/Fail Status: shows the status of the link under test. See *Global Pass/Fail Status* on page 192 for details.

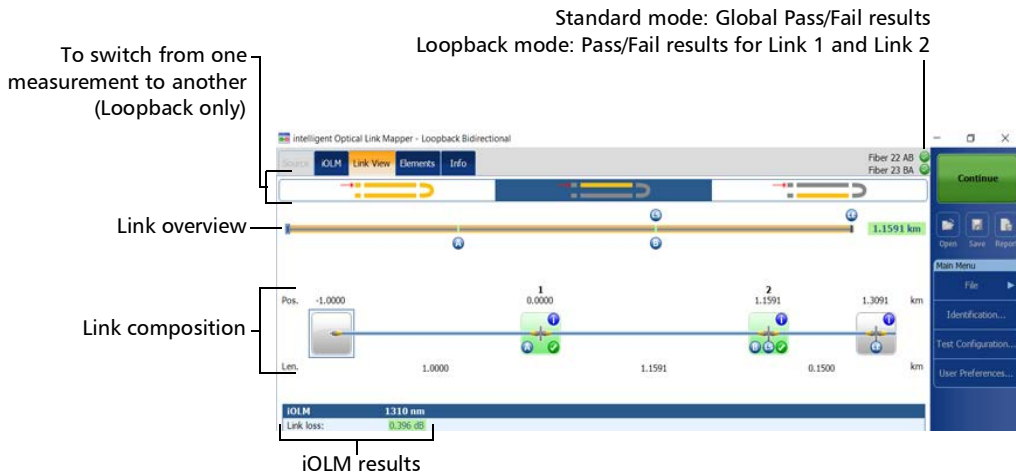

Link Overview

The link overview displays the entire link from the beginning of the link under test to the end.

The following color codes are used for the elements composing the link overview.

- Red: The status of the element is fail.
- Green: The status of the element is pass.
- Blue: The element is not tested for pass/fail or the status of the element is unknown.

The link overview representing all the elements found on the link is described below.

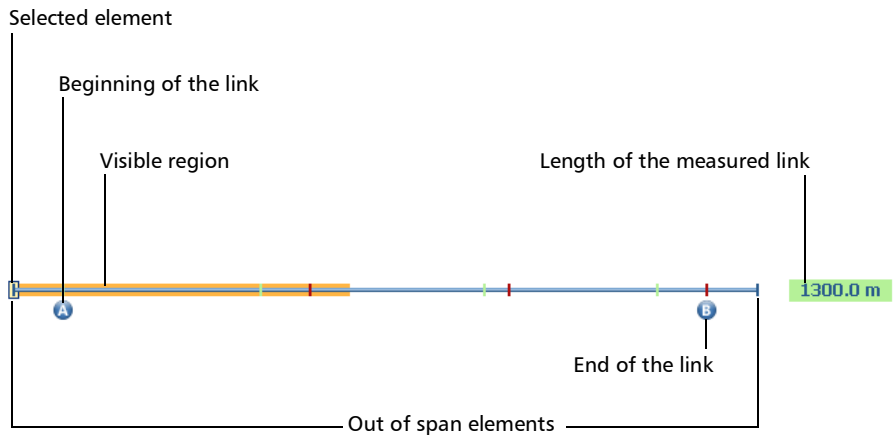

Analyzing and Managing Results

Viewing Results in the Link View

- Selected element: The rectangle indicates the position of the selected element in the link composition.
- Beginning of the link: The letter A (launch fiber) indicates the beginning of the link under test. See *Launch, Receive, and Loop Fibers* on page 10 for details.
- Visible region: The colored background represents the visible region in the link composition view.
- End of the link: The letter B (receive fiber) indicates the end of the link under test. See *Launch, Receive, and Loop Fibers* on page 10 for details.
- Length of the measured link: This value excludes the launch and receive fiber.

Elements before A and after B are referred to as *out of span* elements. These elements are not tested for pass/fail status, but can have diagnostics on them. If no receive fiber is defined, the element marked as "B" will not be tested for pass/fail.

Link Composition

The number of items displayed in the link composition varies according to the available space, number of elements, and section size. When the link length is too long, you may need to scroll on the link using the navigation arrow.

Note: *The distance between the elements is not 100 % proportional. To have a proportional representation of the element, see Link Overview on page 177.*

The link composition displays every element present on the link. Each element (except fiber section) has its own identification number.

Note: *The custom element types (including those represented by your own images) may appear in the link composition. See Defining the Link for Your Test on page 98 for details.*

Standard measurement

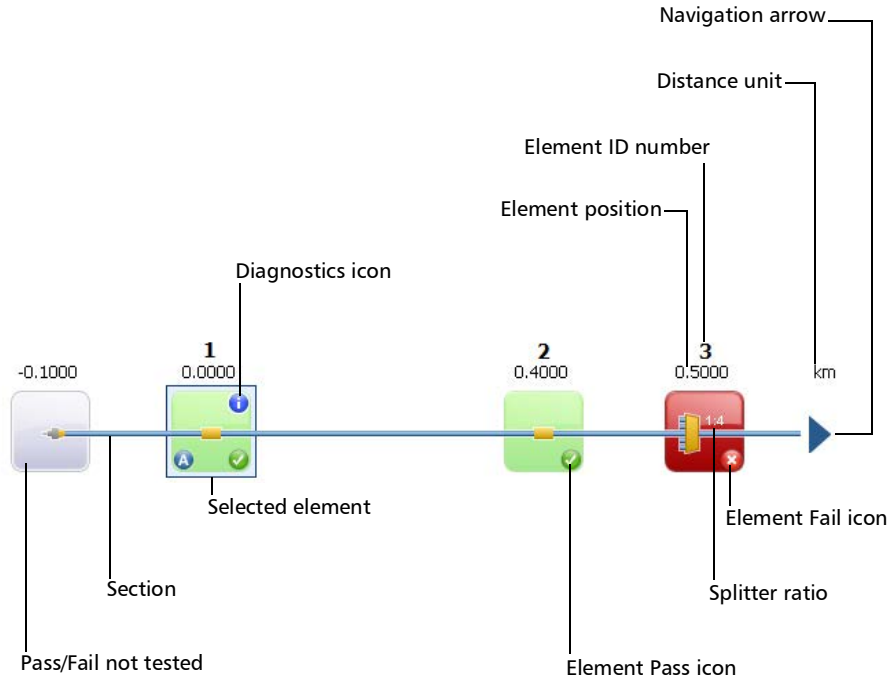

Loopback measurement

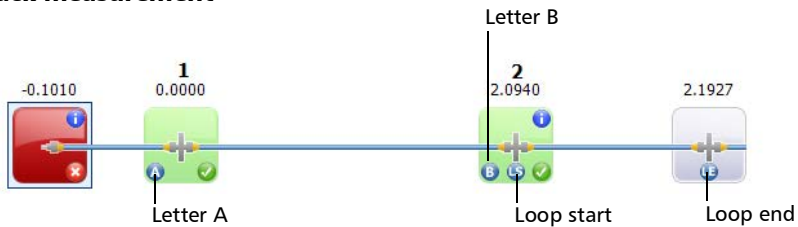



Analyzing and Managing Results

Viewing Results in the Link View



- Diagnostics icon : This icon specifies that some diagnostics are present on the element to provide additional information about detected problems or ambiguous measurement situations. See *Understanding Diagnostics* on page 159 for more details.
- Element position: This value represents the distance of the element from the beginning of the link under test.
- Pass/Fail not tested: The gray background indicates that the status of the element is unknown or it has not been evaluated because this element is not part of the link (out of span). If there is no pass or fail icon in the right side corner, it means that thresholds are not applied on this element and it is not tested for a pass or fail status. The element status remains unknown in the following scenarios:
 - If any element is followed by a 2:N splitter in the link, then the element's loss pass/fail status is displayed as unknown.
 - If the element has a reflectance value and it is placed after the 2:N splitter element, then the element's reflectance pass/fail status is displayed as unknown.
 - If the 2:N splitter is in a group of elements and an element follows the 2:N splitter in the group, then the pass/fail status of the group is displayed as unknown.

Note: *2:N splitters are not supported if you are working with a MAX/FTBx-740C module.*

- Selected element: The element outlined in blue indicates that it is currently selected.
- Section: A fiber section is delimited by two elements. Fiber sections do not have an identification number.
- Element ID number: A sequential number is assigned by the application for each element displayed along the link.
- Element Pass icon : Green is associated with a pass status.

- Element Fail icon : Red is associated with a fail status.
- Splitter ratio: The value displayed on the element corresponds to the splitter ratio. See *Defining the Link for Your Test* on page 98 for details.
- Distance unit: You can choose the distance units you will use for your measurements in a list of available choices. See *Selecting the Distance Units* on page 155 for details.
- Navigation arrow: When more items are available on a particular side, it indicates that you have to scroll to view those items.
- Letter A: This indicates the beginning of the link under test (launch fiber). The elements located before the beginning of the link do not have an identification number. See *Launch, Receive, and Loop Fibers* on page 10 for details.
- Letter B: This indicates the end of the link under test (receive fiber). The elements located after the end of the link do not have an identification number. See *Launch, Receive, and Loop Fibers* on page 10 for details.



Note: An arrow () icon is displayed on the element when the start and the end of the link are represented by the same element.





- Loop start icon : In loopback measurements, indicates the beginning of the loop.
- Loop end icon : In loopback measurements, indicates the end of the loop.
- Loop middle icon : In loopback measurements, this icon is displayed on the element if the loop is configured on a single element. The element can be a splice or a connector. When the length of the loop is set to zero, the loop is identified in the middle of the link. An item is automatically added to the links when no one is found.

Analyzing and Managing Results

Viewing Results in the Link View



In addition, you can have elements represented by specific icons.



Element Name	Element Icon	Element Description
Macrobends		<p>Macrobends can be displayed in the link view when more than one wavelength is present in the measurement.</p> <p>Note: <i>Macrobends are not detected if you are working with a MAX/FTBx-740C-DWx module.</i></p> <p>Note: <i>The macrobend will always be displayed as a failed element.</i></p>
Out of Range		<p>The out of range element is displayed when the end of fiber could not be detected by the module because of insufficient dynamic range.</p>
Splitter		<p>The splitter is a passive fiber optic coupler that divides light from a single fiber into two or more fiber channels. The splitter ratio is displayed beside the icon.</p>

Element Name	Element Icon	Element Description
2:N Splitter		<p>2:N splitter can be used to create network redundancy. If a network break occurs, the operator can connect through the other network branch. The splitter ratio is displayed beside the icon.</p> <p>Note: <i>2:N splitters are not supported if you are working with a MAX/FTBx-740C module.</i></p>
Splice		<p>The splice can indicate the junction of two fiber sections, the presence of a macrobend, or a microbend in the fiber.</p>
Connector		<p>The connector is used to join two fibers.</p>
Switch		<p>Indicates that a switch has been detected. See <i>Connecting an Optical Switch to the iOLM</i> on page 31 for details.</p>

Analyzing and Managing Results

Viewing Results in the Link View

Element Name	Element Icon	Element Description
Fault		<p>For the PON Last Mile measurement type, the fault icon indicates that a problem occurred during the analysis.</p> <p>For example, when a splitter is on the link, a loss and a section of fiber are expected after the splitter. If no splitter is found on the link but an end of fiber is detected, the fault icon is displayed instead of the end of fiber to indicate there is a problem.</p>
Coupler		<p>A coupler port is an optical fiber device with one or more input fibers and one or several output fibers. This device is associated with a minimum loss value; for example, a 1 x2 coupler has a loss of 3 dB.</p>
Unbalanced splitter (coupler)		<p>This splitter is displayed when working on unbalanced PON. This is the equivalent of a coupler icon, but for unbalanced PONs. The splitter ratio is displayed beside the icon.</p>

Element Name	Element Icon	Element Description
Unbalanced splitter (through the output port)		When working on unbalanced PONs, it identifies the splitter used to test one or several customers. The splitter ratio and the number of ports are displayed beside the icon.
Unbalanced splitter (through the trunk cable)		This icon is also displayed when working on unbalanced PONs. It indicates that the light is going to the next splitter in the cascade of splitters along the cable. The splitter ratio and the number of ports are displayed beside the icon.

Sometimes, when the analysis detects several link elements that are too close to one another to be independently characterized, the link elements will be displayed as groups. When this occurs, as much information as possible will be displayed for each individual sub-element. The pass/fail status is applied to each sub-element whenever possible, and a global status is also displayed for the group.

Only one identification number is displayed for a group of elements and the cumulative loss value is displayed for the element representing the group. See *Enabling or Disabling the Cumulative Loss* on page 58 for details.

Groups can also be displayed when a link element (such as a splitter) is found to have wavelength dependent loss. In that case, the link element is grouped with a macrobend element. In this particular case, there might not be a physical macrobend next to the link element, but the macrobend icon is used to highlight the presence of the wavelength dependent loss.

Note: *Macrobends are not detected if you are working with a MAX/FTBx-740C-DWx module.*

Analyzing and Managing Results

Viewing Results in the Link View

When elements are grouped, the group loss and group reflectance values are also displayed in the **Elements** tab.

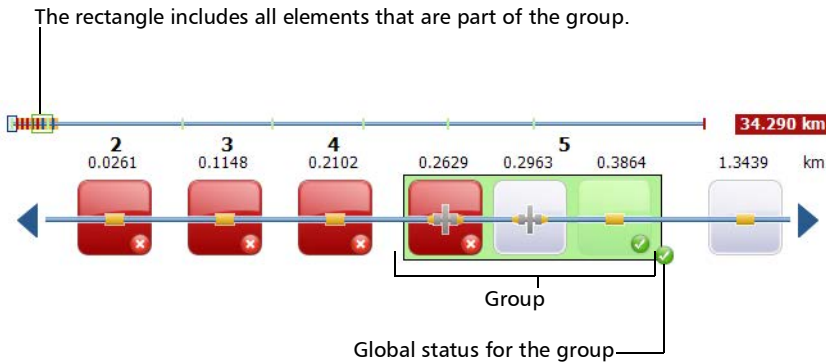

Note: *If some elements are grouped, the total group loss value is compared with the sum of the thresholds defined for the individual elements in a group. If the total group loss value is greater than the sum of the thresholds defined for the individual elements in a group, the element will show a fail status.*

You can select grouped elements individually as you would do with any other standalone element.

When elements are grouped at the beginning of the link, icon A is displayed on one of the sub-elements.

When elements are grouped at the end of the link, icon B is displayed on one of the sub-elements.

The elements located before the beginning of the link or after the end of the link do not have an identification number. See *Launch, Receive, and Loop Fibers* on page 10 for details.

Some types of unbalanced splitters have slightly reflective elements on that are visible on the OTDR traces and that your unit will detect. Grouping these elements with the unbalanced splitter element or group identified by your iOLM will allow you to have a representation that is more truthful to your topology.

If you have not selected the automated grouping feature as explained in *Working on Unbalanced PONs (MAX-730/FTBx-730/735/ MAX-740C and D and FTBx-730D/740C and D Units Only)* on page 113, you can also group them manually. You can group all elements between A and B; however, the group option is only available for splitters (unbalanced), splices and connectors. The corresponding pass/fail thresholds will be applied to the new merged element.

Note: *If there are tap side measurements in the link, they will automatically be grouped.*

To group an element or group to another element or group:

1. From the **Link View** tab, select the element you want to group by tapping and holding so that the contextual menu appears. Depending if you can group to the right or left, the relevant action is available.

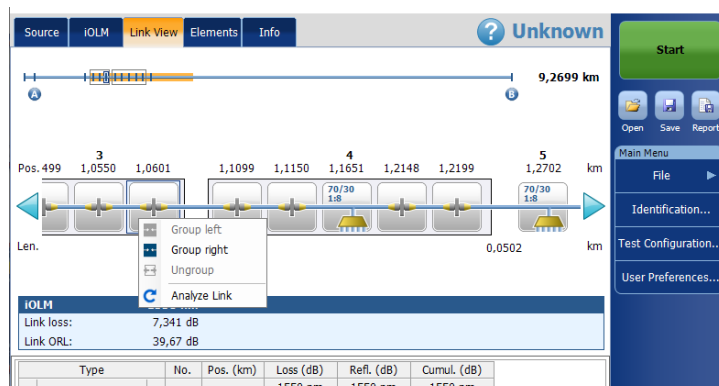

2. Select **Group right/left**.

Analyzing and Managing Results

Viewing Results in the Link View

To ungroup an element or group from another one:

1. From the **Link View** tab, select the element or group you want to ungroup by tapping and holding so that the contextual menu appears.

The screenshot shows the Link View interface for a fiber link. The top navigation bar includes tabs for Source, iOLM, Link View (selected), Elements, and Info. The link is labeled 'Unknown' and has a total length of 9,2699 km. The main view displays a series of fiber elements along a horizontal axis. A group of three elements is highlighted with a blue border, and a contextual menu is open over it, showing options: Group left, Group right, Ungroup, and Analyze Link. The menu also shows a '70/30 1/8' label. Below the main view, there is a summary section for 'iOLM 1550 nm' with the following data:

Link loss:	7,341 dB
Link ORL:	39,67 dB

At the bottom, there is a table with the following columns: Type, No., Pos. (km), Loss (dB), Refl. (dB), and Cumul. (dB). The table contains one row of data:

Type	No.	Pos. (km)	Loss (dB)	Refl. (dB)	Cumul. (dB)
1550 nm		1550 nm		1550 nm	1550 nm

2. Select **Ungroup**.

iOLM Results

The iOLM acquisition results are displayed for all the wavelengths at which the acquisition was performed.

When an acquisition is performed with the MAX/FTBx-740C-DWx module, the ITU channel, followed by the frequency (in THz), and the center wavelength (in nm), is displayed in the iOLM acquisition results.

Note: *iOLM results are not displayed if they are not available.*

iOLM		1310 nm	1550 nm
Link loss:		9.587 dB	8.525 dB
Link ORL:		33.61 dB	32.10 dB

Type	No.	Pos. (km)	Loss (dB)		Reflectance (dB)		Cumul. Loss (dB)	
			1310 nm	1550 nm	1310 nm	1550 nm	1310 nm	1550 nm
	1	0.0000	0.601	0.485	-77.4	-77.1	0.601	0.485
		0.0000	-0.069	---	---	-77.1	---	---

Point to Point File name: 1310 1550 Access jg.iolm

Element ID number Cumulative loss for each wavelength

The custom elements represented by your own images may also appear in the drop-down list if any are defined.

When a multiple-wavelength acquisition is in progress, only the wavelength currently being acquired and the ones already completed are displayed. Link loss, link ORL, and propagation delay (multimode only) are displayed for each wavelength. For the link loss and the link ORL, the values are tested and displayed according to current pass/fail settings.

Note: *The propagation delay (multimode only) is a global link measurement which is measured by the OTDR. It is defined by the amount of time necessary for a signal to travel from point A to point B. It may vary between wavelengths.*

Note: *If the link ORL value is displayed with a < symbol, it is saturated. A test to obtain a pass/fail status can reveal if the element is fail, but will not be able to specify a pass status.*

Analyzing and Managing Results

Viewing Results in the Link View

Unidirectional and Bidirectional Loopback Results

The loopback measurement is especially designed for testing cables formed of a pair of identical fibers of an equivalent length. The measuring time is optimized because two fibers are checked in a single measurement.

The loopback results appear after a successful split.

- In the case of a uni-bidirectional loopback measurement:

You can navigate through the split measurement and the original measurement by selecting the appropriate icon at the top of the link view.

The original measurement is analyzed and the pass/fail thresholds are displayed for this measurement. However, there is no overall status for the original measurement. The overall status is only for the split measurements.

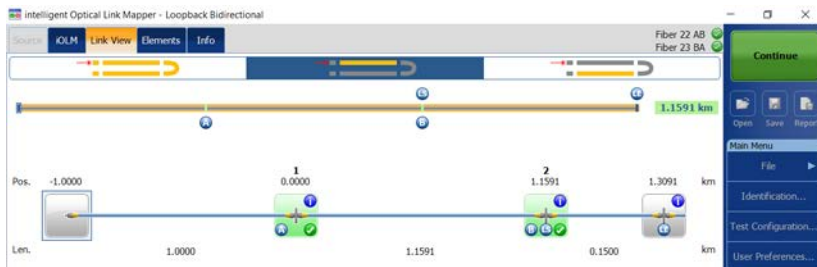

- In the case of a bidirectional loopback measurement:

After the first measurement is taken, the results are presented exactly as they would be for a non-bidirectional loopback measurement.

After the second measurement is taken, both measurements are split properly, and the application generates the bidirectional measurement for the two fibers.

Power Meter Results

The power meter acquisition results are displayed for all the wavelengths at which the power meter acquisition was performed.

Note: *The power meter results are not displayed if they are not available.*

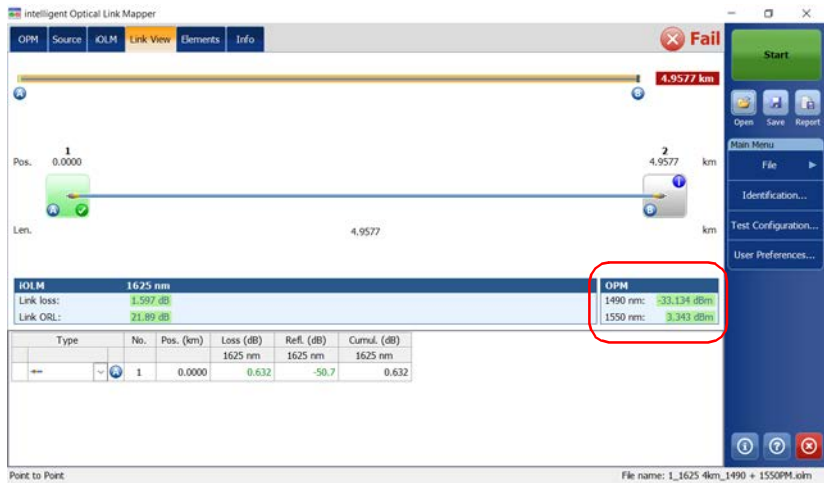

More than one wavelengths can be displayed in the power meter section. All values are tested and displayed according to the current pass/fail settings.

Analyzing and Managing Results

Viewing Results in the Link View

Global Pass/Fail Status

The global pass/fail status depends on the pass/fail status of the link length, link loss, link ORL, power meter values (if taken), and the link elements. If any of the statuses is fail, then the global pass/fail status will be fail.

If you are working with a MAX/FTBx-740C module, the iOLM will automatically detect the coupler element (one of the elements that can be part of the link) in the following cases:

- A MUX is detected between the link start (element A) and the link end (element B) inclusively. When no launch fiber is defined, element A is excluded from the detection range.
- the iOLM looks for a DEMUX when a MUX is detected. The DEMUX will be placed between the MUX and the link end (element B) if the latter has a loss that can be measured (the receive fiber is long enough). If no element fits these criteria and no receive fiber is defined, the DEMUX is placed on the link end (element B).

Since no pass/fail thresholds are applied on coupler elements detected automatically by the application, the global pass/fail status is not affected by this specific element type. However, when you define the coupler element as a custom element, the thresholds applied on the coupler element affect the global pass/fail status directly. If no thresholds are defined for the custom coupler, this element will not be taken into account in the global pass/fail status. See *Defining the Link for Your Test* on page 98 for details.

The status is automatically updated when a value is modified in the application. When the element type is changed from the **Elements** tab, the individual pass/fail status is recalculated, which might affect the global pass/fail status. See *Managing Elements and Analyzing Links* on page 199 for details.

The iOLM application waits for the acquisition to finish before displaying the pass status. However, the fail status is displayed as soon as any of the values tested has a fail status. A fail value can change to unknown or pass when the acquisition is finished.

Note: *It is important to complete the entire acquisition process to have a good pass/fail status.*

The global pass/fail status of the iOLM measurement is displayed as unknown if there is no failed value and one element is not tested because it follows the 2:N splitter on the link.

Note: *2:N splitters are not supported if you are working with a MAX/FTBx-740C module.*

Analyzing and Managing Results

Viewing Results in the Link View

In loopback measurements modes, when the measurement is split (link 1 and link 2), the global pass/fail status is replaced by the link 1 and link 2 statuses.

Standard measurement

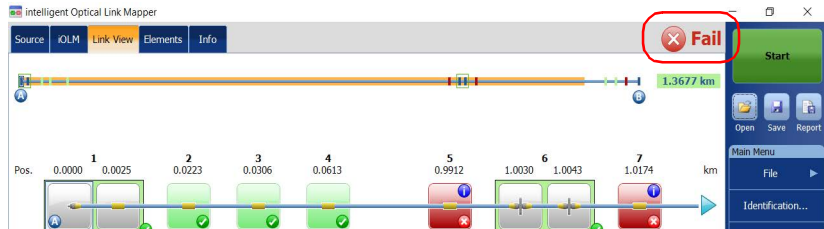

Loopback measurements

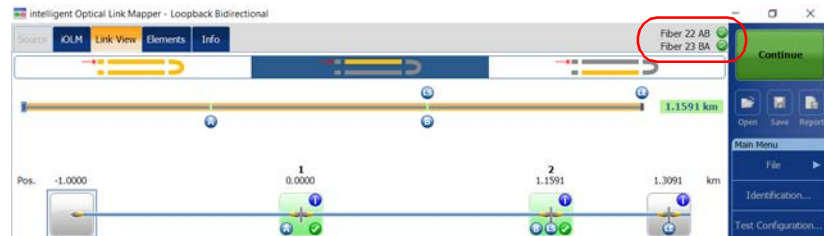

If you have selected more than one predefined certification standards to perform an acquisition, you can view which ones have a pass or fail status by tapping on the global pass/fail status icon.



Viewing Results of Elements and Fiber Section Details

When an element or fiber section is selected in the link view, the details of the corresponding selection are automatically displayed in the **Elements** tab. Each element (except fiber section) has its own identification number. However, some elements may be displayed as groups. When this is the case, only the element representing the group has an identification number. See *Viewing Results in the Link View* on page 175 for details.

The loss and reflectance results are displayed with appropriate coloring based on the pass/fail status of each value.

The loss or reflectance value may be underestimated if the noise level is too high (for instance, after a lot of loss on the link, the noise levels increase). In that case, it is possible for the signal processing algorithms to detect an element and estimate the loss/reflectance values, but since the measured signal does not completely clear the noise floor, the loss or reflectance/attenuation values are likely to be underestimated.

Underestimated loss, reflectance, and attenuation values are displayed with a > symbol.

Note: *If the loss or reflectance value is saturated, it is displayed with a > symbol. The application will be able to specify a fail status if the value is fail, but in all other cases, the application will set the status to unknown.*

The 0.0 value is set on the first element when the launch fiber is present.

Note: *You can select a section only if the **Fiber section** option is enabled in the **User Preferences** window. See *Displaying or Hiding Fiber Sections* on page 154 for details.*

The cumulative loss values are not displayed for elements located before the beginning of the link or after the end of the link. See *Enabling or Disabling the Cumulative Loss* on page 58 and *Launch, Receive, and Loop Fibers* on page 10 for details.

Analyzing and Managing Results

Viewing Results of Elements and Fiber Section Details

To view elements or section details:

1. From the **Link View** tab, select the desired element or fiber section on the link composition.
2. Tap the **Elements** tab to view the selected element or section details.

Cumulative loss for each wavelength

Type	No.	Pos./Len. (km)	Loss (dB)		Reflectance (dB)		Attenuation (dB/km)		Cumul. Loss
			1310 nm	1550 nm	1310 nm	1550 nm	1310 nm	1550 nm	
		-0.1979	0.946	0.743	-54.1	-55.2			
		-0.1947		0.661	-54.1	-55.2			
		0.1947	0.063	0.043			0.324	0.221	
	1	0.0000	0.473	0.427	-81.6	-76.8			0.473
		0.0321	0.006	0.006			0.200	0.200	0.479
	2	0.0321	0.402	0.294					0.881
		0.0522	0.035	0.011			0.674	0.200	0.916
		0.0843			>-14.5	>-14.1			

Beginning of the link

End of the link

Element ID number

Pass

Start

Open Save Report

Main Menu

File

Identification...

Test Configuration...

User Preferences...

PON 2 Splitters 1x4 1x8

File name: 1310 1550 80 m with launch including jumper.sdm

Editing Element Types

Depending on the characteristics of a specific element, it may be possible to change its type.

Note: When an element is edited on a multimode wavelength, it is impossible to change the type of this element to a splitter.

Note: With an acquisition performed on an unbalanced PON, you cannot edit an element on the link.

To edit element types:

1. From the **Elements** tab, select the element you want to modify in the **Type** column.



Analyzing and Managing Results

Editing Element Types

2. Choose an element type from the list of available choices.



You can also change the splitter ratio if the selected element is a splitter.

Note: The custom element types appear in the **Type** list. If you have custom elements using your own images, they will also appear in the list. See *Defining the Link for Your Test on page 98* for details.

Note: When the type of an element is modified, a “*” sign is displayed next to the element in the **Type** column. The “*” sign is also displayed in the **Type** column when a report is generated.

Managing Elements and Analyzing Links

The application allows you to add and delete elements. Adding an element does not modify the link but it automatically adds an identification number at the location of the insertion.

Note: *With an acquisition performed on an unbalanced PON, you cannot add or delete an element on the link.*

You can also analyze the link after you make changes to a specific link.

Adding Elements

The iOLM application allows you to add elements on a link by selecting any element or fiber section. However, you cannot add an element after the last element on a link.

Note: *You can select a section only if the **Fiber section** option is enabled in the **User Preferences** window. See *Displaying or Hiding Fiber Sections on page 154* for details.*

Note: *As soon as you add an element manually, the “*” sign is displayed in the **Type** column in the **Elements** table.*

When you add a new element on a link to an existing element or group of elements, the loss and reflectance values are set to “--” and the pass/fail threshold is not applied to the newly added element. Accordingly the status for the new element is reflected as unknown. The global pass/fail status can be affected after adding an element on an existing element. See *Global Pass/Fail Status* on page 192 for details. The added elements are taken into account to determine the pass/fail status of a group of elements.

Note: *You cannot insert elements on the links that result from a multifiber acquisition sequence with the MPO switch.*

Analyzing and Managing Results

Managing Elements and Analyzing Links

To add an element:

1. Open an iOLM file.
2. Select an existing element in the link composition where you want to add the new element.

OR

Select an element from the **Elements** tab.

3. Tap and hold on the element to view the contextual menu and select **Add Element**.

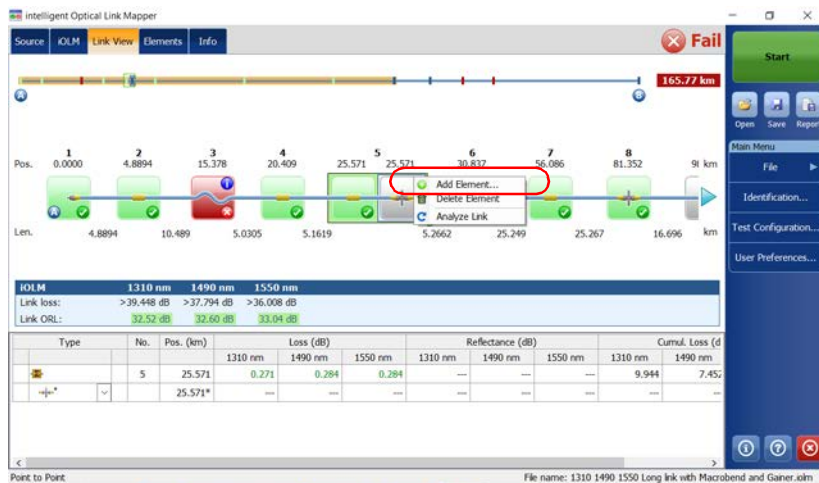

4. In the **New Element** dialog box, proceed as follows:
 - 4a. Select the location where you want to add the new element.
 - 4b. Select the type of the new element.

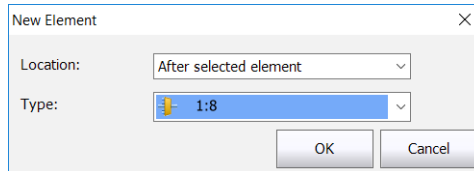

Note: *The custom element types appear in the **Type** list. If you have custom elements using your own images, they will also appear in the list. See Defining the Link for Your Test on page 98 for details.*

Note: *The 2:N splitter and custom elements are displayed in the element type list if they are present in the selected iOLM files.*

- 4c. Tap **OK** to confirm your changes and close the window. Tap **Cancel** to ignore your changes and close the window.

Analyzing and Managing Results

Managing Elements and Analyzing Links

To add an element on a fiber section:

1. Open an iOLM file.
2. Select an existing fiber section in the link composition where you want to add the new element.

OR

Select the section from the **Elements** tab.

3. Tap and hold on the fiber section to view the contextual menu and select **Add Element**.

iOLM		1310 nm	1490 nm	1550 nm
Link loss:		>39.448 dB	>37.794 dB	>36.008 dB
Link ORL:		32.52 dB	32.60 dB	33.04 dB

Type	No.	Pos. (km)	Loss (dB)			Reflectance (dB)			Cumul. Loss (dB)	
			1310 nm	1490 nm	1550 nm	1310 nm	1490 nm	1550 nm	1310 nm	1490 nm
	5	25.571	0.271	0.284	0.284	---	---	---	9.944	7.452
		25.571*	---	---	---	---	---	---	---	---

4. In the **New Element** dialog box, proceed as follows:
 - 4a. Enter the position that better suit your needs. To change the distance units, see *Selecting the Distance Units* on page 155.
 - 4b. Select the type of the new element.

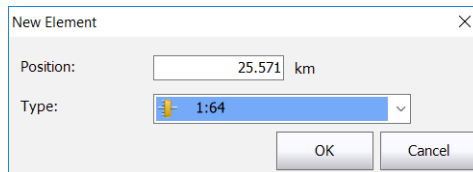

The image shows a dialog box titled "New Element" with a close button (X) in the top right corner. It contains two input fields: "Position:" with a text box containing "25.571" and "km" to its right, and "Type:" with a dropdown menu showing "1:64" and a downward arrow. At the bottom right, there are two buttons: "OK" and "Cancel".

Note: *The custom element types appear in the **Type** list. If you have custom elements using your own images, they will also appear in the list. See *Defining the Link for Your Test* on page 98 for details.*

Note: *The 2:N splitter and custom elements are displayed in the element type list if they are present in the selected iOLM files.*

- 4c. Tap **OK** to confirm your changes and close the window. Tap **Cancel** to ignore your changes and close the window.

Analyzing and Managing Results

Managing Elements and Analyzing Links

Deleting Elements

The application allows you to manually delete added elements.

Note: *You cannot delete elements on the link of a loopback measurement for the original measurement, but you can delete added elements when working with the split measurements.*

To delete an element:

1. Open an iOLM file.
2. In the link composition, select the element you want to delete.

OR

Select the element you want to delete from the **Elements** tab.

3. Tap and hold on the element to view the contextual menu and select **Delete Element**.

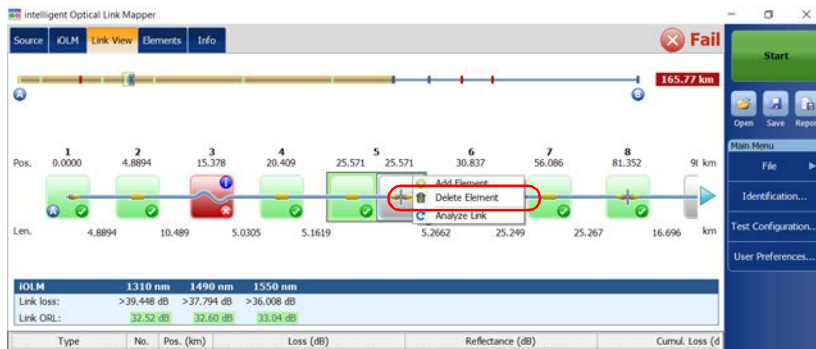

4. When the application prompts you, select **Yes** to delete the element or **No** to cancel your choice.

Analyzing Links

The application allows you to reanalyze measurements from the **Link View** or **Elements** tabs. When you reanalyze a link, it regenerates all the elements from the acquired measurement and resets the link start and link end values. Once a measurement is reanalyzed, any element related to the link composition, values, and characteristics, as well as the global pass/fail status is refreshed. All the elements added manually are removed from the link.

Note: *You cannot analyze elements on the link of a loopback measurement (either original measurement or split measurements).*

To analyze the link:

1. Open an iOLM file.
2. From the **Link View** or **Elements** tab, tap and hold to view the contextual menu and select **Analyze Link**.

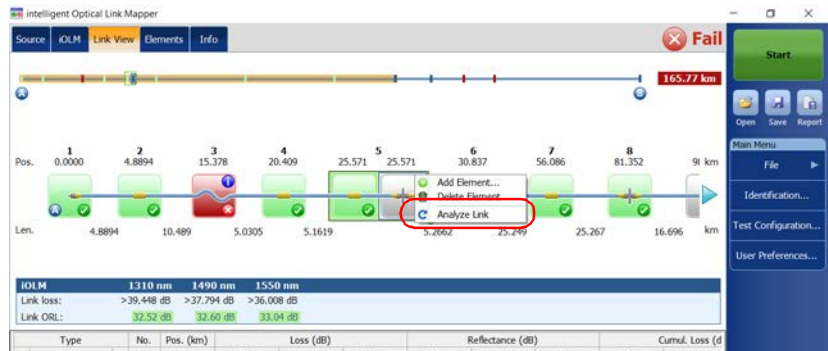

3. When the application prompts you, select **Yes** to analyze the link or **No** to cancel your choice.

Analyzing and Managing Results

Viewing .SOR Traces in the OTDR Viewer

Viewing .SOR Traces in the OTDR Viewer

The IADV software option enables you to view acquisitions taken in the iOLM application directly in the OTDR Viewer.

When the .sor trace is displayed in the OTDR Viewer, you can navigate between wavelengths using the previous and next buttons. You can visualize, in turn, the .sor traces taken for each wavelength and navigate through the events or sections directly on the graph or in the event table. However, you cannot delete, change or edit an event. You cannot reanalyze an acquisition either.

The zoom controls are available if you want to view specific portion of the acquisition.

By default, the OTDR Viewer tries to match the wavelengths with those used in the iOLM application.

The OTDR Viewer will use the same distance units as the ones used in the iOLM application.

To view .sor traces in the OTDR Viewer:

1. With the iOLM application, perform an acquisition or open an iOLM file.
2. In the **Elements** tab, select an element or a fiber section.
3. Tap the  button.



The screenshot shows the iOLM application interface. The 'Elements' tab is active, displaying a table of fiber sections. A red circle highlights a 'Fail' status indicator in the top right corner of the table. The table columns include Type, No., Pos./Len. (km), Loss (dB) at 1310 nm and 1550 nm, Reflectance (dB) at 1310 nm and 1550 nm, Attenuation (dB/km) at 1310 nm and 1550 nm, and Cumul. Loss (dB) at 1310 nm.

Type	No.	Pos./Len. (km)	Loss (dB)		Reflectance (dB)		Attenuation (dB/km)		Cumul. Loss (dB)
			1310 nm	1550 nm	1310 nm	1550 nm	1310 nm	1550 nm	
		-0.0570	0.316	0.197	-76.9	-67.8			
		-0.0570	---	-0.029	-76,9	---			
		-0.0537	---	0.226	---	-67.8			
		0.0537	0.011	0.011			0.200	0.200	
	1	0.0000	0.562	0.570	-55.5	-56.6			0.562
		2.2561	0.792	0.423			0.351	0.188	1.354
	2	2.2561	0.247	0.160	-52.6	-53.4			1.601
		12.940	4.493	2.437			0.347	0.188	6.093
	3	15.196	0.448	0.424	-50.4	-51.3			6.542
		12.838	4.405	2.366			0.343	0.184	10.946

In the OTDR Viewer, you can navigate through the events or sections directly on the graph or in the event table.

Viewing Measurement Information

You can find information about a measurement, in the application, such as the file name, the acquisition date, the acquisition status, and the test configuration used.

To view measurement information:

From the main window, tap **Info**.



Note: *If the file autonaming is not configured, the file name will be “---”. See Naming Trace Files Automatically on page 36 for details.*

Viewing Multifiber Results

As soon as you start a multifiber acquisition sequence, a summary with the global pass/fail status for the entire MPO cable is displayed. The results are displayed as the acquisition progresses. Detailed information is shown for each fiber as well.

The summary is not displayed when you open a new file or if an acquisition sequence is started and the externally controlled MPO optical switch is not connected to the unit.

After an acquisition sequence is completed or interrupted, you can select a specific measurement and view the results.

Indicates if the loss and reflectance values of the SPSB connectors comply with the recommended thresholds.

#	File name	Link Length (km)	Link Loss (dB) 1310 nm	Link ORL (dB) 1310 nm	Status
1	Cable 13_01.slm	0.3711	0.236	44.10	Pass
2	Cable 13_02.slm	0.3711	0.234	44.09	Pass
3	Cable 13_03.slm	0.3708	0.234	44.10	Pass
4	Cable 13_04.slm	0.3711	0.238	44.09	Pass
5	Cable 13_05.slm	0.3675	>0.000	38.87	Pass
6	Cable 13_06.slm	0.3711	0.235	44.07	Pass
7	Cable 13_07.slm	0.3711	0.238	44.11	Pass
8	Cable 13_08.slm	0.3709	0.232	44.10	Pass
9	Cable 13_09.slm	0.3710	0.221	44.08	Pass
10	Cable 13_10.slm	0.3711	0.238	44.09	Pass
11	Cable 13_11.slm	0.3712	0.224	44.12	Pass
12	Cable 13_12.slm	0.3707	0.218	44.11	Pass

When the results are displayed, you may noticed that all 12 fibers of an MPO test cable do not have exactly the same length. This may be explained by the type of connector used. APC fiber ends tend to be less reflective, compared to the UPC fiber ends, and the position accuracy is also different between the two fiber ends. The distance reliability will vary depending on the Optimode chosen and the OTDR unit used. For exemple, using an FTB-720C module with the Fast Short Link mode will give the worst results and an FTB-750C module used with the Short Link Close Events mode will give the best results.

Sometimes, the APC MPO connections cannot be detected, as no loss and no reflectance are noticeable. Also, if you use the SLCE and FSL Optimodes, when no reflectance is found on an element, the latter will be converted into a connector instead of a splice.

When an MPO switch is connected, the application manages the fibers of the cable as individual fibers with their own elements. No post-treatment is performed to align elements detected on all fibers, or to add elements that may not have been detected on some of the fibers.

You can view the predefined certification standards applied to each fiber and their corresponding pass or fail status by tapping on the status icon at the end of the row.

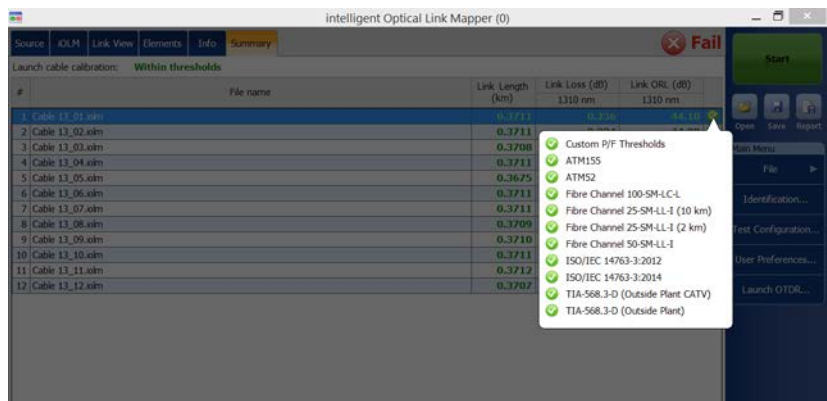

You can set your unit to generate a report automatically after each sequence. For more information, see *Activating the Automated Report Creation* on page 151.

14 Managing Files

Managing your files can be done using the shortcut buttons, or the **File** menu.

Opening Files

You can open files directly from the application to view them.

To open a file:

1. From the main window, tap the  button.

OR

From the **Main Menu**, tap **File**, then **Open**.

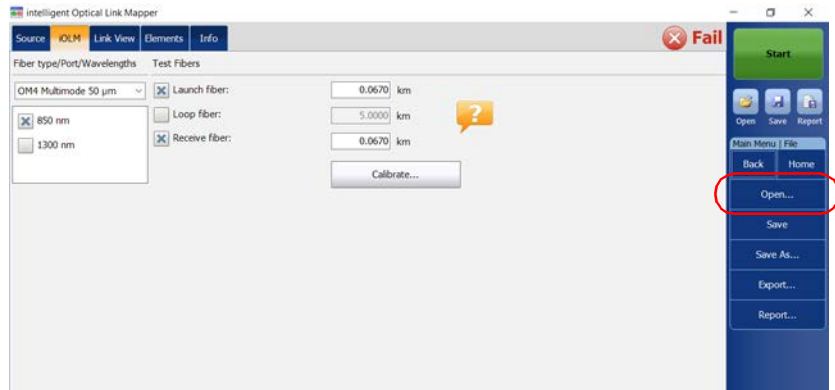

2. Select the file you want to open and tap **Open**.

Managing Files

Saving Files

Saving Files

You can save the files manually for future reference. If you want to export your files in Bellcore format automatically each time you save a measurement, see *Saving Files in Bellcore Format* on page 148 for details.

Note: *If an OTDR Bellcore (.sor) file already exists on disk, a number in parenthesis will be automatically incremented at the end of the file name to avoid unwanted overwrite.*

To save a file:

From the main window, tap the  button.

OR

From the **Main Menu**, tap **File**, then **Save**.

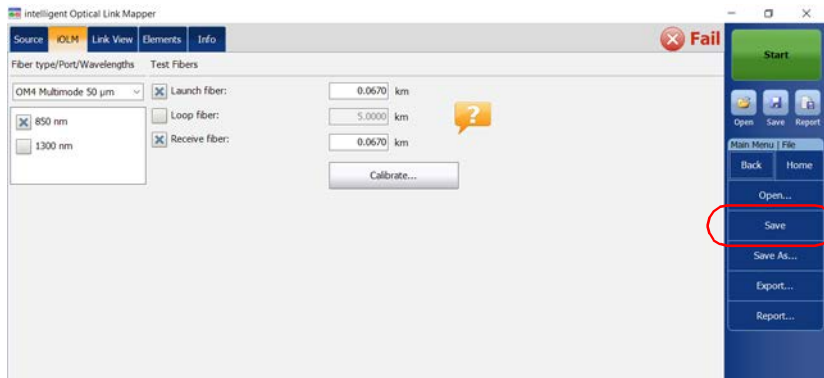

To save a file under a different name or location:

1. From the **Main Menu**, tap **File**, then **Save As**.



2. Select the location where you will store your file as needed.
3. Change the name of the file as needed.
4. Tap **Save**.

Managing Files

Exporting Files to the Bellcore Format

Exporting Files to the Bellcore Format

You can export an OTDR Bellcore file to the disk manually. You can also decide to export files automatically to the Bellcore format each time an iOLM measurement is saved. See *Saving Files in Bellcore Format* on page 148 for details.

If multiple wavelengths are present in the iOLM measurement, a Bellcore (.sor) file is generated for each wavelength.

Note: When a bidirectional measurement is loaded in memory, the **Export** button is disabled.

To export a file manually to the Bellcore format:

1. From the **Main Menu**, tap **File**, then **Export**.



2. Select the location where you will store your file as needed.
3. Change the name of the file as needed.
4. Tap **Save**.

Note: When you attempt to generate the .sor file and that the iOLM measurement does not contain the necessary intermediate OTDR measurements, you are notified that the file was not generated, and the reason why. If you interrupt the generation of the .sor file, you are also notified that the file was not generated.

Generating a Report

You can have reports generated for the iOLM, the power meter or the iOLM and power meter results combined.

You can customize the contents of your report. See *Customizing Reports* on page 150 for details. You can also set the application to generate a report each time a measurement is saved. See *Activating the Automated Report Creation* on page 151 for details.

Note: *In Internet Explorer, you have to enable the **Print Background Colors and Images** option from **File > Page Setup** to print the report properly.*

To generate a report:

1. From the main window, tap the  button.

OR

From the **Main Menu**, tap **File**, then **Report**.

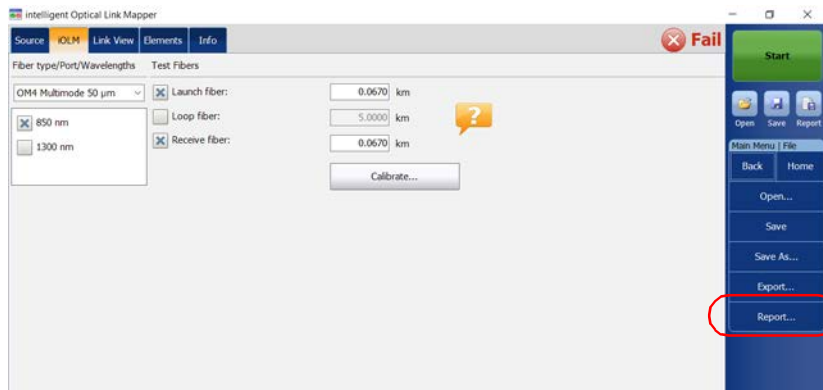

2. Select the location where you will store your file as needed.
3. Change the name of the file as needed.
4. Tap **Save**.

15 Maintenance

To help ensure long, trouble-free operation:

- Always inspect fiber-optic connectors before using them and clean them if necessary.
- Keep the unit free of dust.
- Clean the unit casing and front panel with a cloth slightly dampened with water.
- Store unit at room temperature in a clean and dry area. Keep the unit out of direct sunlight.
- Avoid high humidity or significant temperature fluctuations.
- Avoid unnecessary shocks and vibrations.
- If any liquids are spilled on or into the unit, turn off the power immediately, disconnect from any external power source, remove the batteries and let the unit dry completely.



WARNING

The use of controls, adjustments and procedures, namely for operation and maintenance, other than those specified herein may result in hazardous radiation exposure or impair the protection provided by this unit.

Cleaning EUI Connectors

Regular cleaning of EUI connectors will help maintain optimum performance. There is no need to disassemble the unit.



WARNING

Looking into the optical connector while the light source is active **WILL** result in permanent eye damage. EXFO strongly recommends to **TURN OFF** the unit before proceeding with the cleaning procedure.



IMPORTANT

If any damage occurs to internal connectors, the module casing will have to be opened and a new calibration will be required.

To clean EUI connectors:

1. Remove the EUI from the instrument to expose the connector baseplate and ferrule.

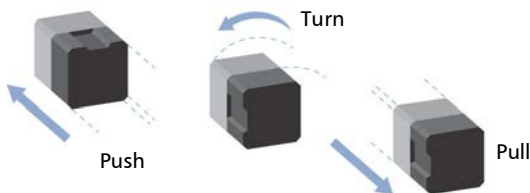

2. Moisten a 2.5 mm cleaning tip with *one drop* of optical-grade liquid cleaner.

3. Slowly insert the cleaning tip into the EUI adapter until it comes out on the other side (a slow clockwise rotating movement may help).

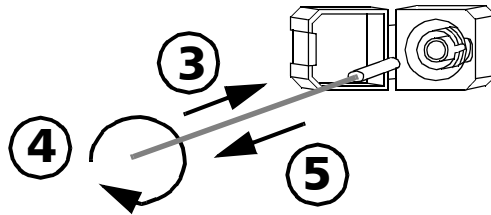

4. Gently turn the cleaning tip one full turn, then continue to turn as you withdraw it.
5. Repeat steps 3 to 4 with a dry cleaning tip.

Note: *Make sure you don't touch the soft end of the cleaning tip.*

6. Clean the ferrule in the connector port as follows:
 - 6a. Deposit *one drop* of optical-grade liquid cleaner on a lint-free wiping cloth.



IMPORTANT

Avoid contact between the tip of the bottle and the wiping cloth, and dry the surface quickly.

- 6b. Gently wipe the connector and ferrule.
- 6c. With a dry lint-free wiping cloth, gently wipe the same surfaces to ensure that the connector and ferrule are perfectly dry.
- 6d. Verify connector surface with a fiber inspection probe (for example, EXFO's FIP).
7. Put the EUI back onto the instrument (push and turn clockwise).
8. Throw out cleaning tips and wiping cloths after one use.

Maintenance

Cleaning Optical Connectors Using a Mechanical Cleaner

Cleaning Optical Connectors Using a Mechanical Cleaner

Optical connectors are fixed on your unit and can be cleaned using a mechanical cleaner.



WARNING

Verifying the surface of the connector with a fiber-optic microscope **WHILE THE UNIT IS ACTIVE** will result in permanent eye damage.



CAUTION

If you are cleaning an EUI with a mechanical cleaner, do not remove it from your device to clean it.

To clean a connector using a mechanical cleaner:

1. Insert the cleaning tip into the optical adapter, and push the outer shell into the cleaner.

Note: *The cleaner makes a clicking sound to indicate that the cleaning is done.*

2. Verify connector surface with a fiber inspection probe (for example, EXFO's FIP).

Verifying the Optical Output of Your Unit

Your unit comes with a wizard that verifies the optical output and provides you with information about the condition of the external and the internal optical connectors.

Once its verification is complete, the wizard rates the result from zero to five stars (half-stars are possible). Any verification receiving a three-star rating or less requires your attention. This can help you determine if the optical connectors are still working properly or if a replacement is necessary.

- If your unit is equipped with a Click-Out optical connector, you can replace it should it become damaged with time. You can purchase new Click-Out connectors from EXFO.
- If your unit is not equipped with a Click-Out optical connector and a connector replacement is necessary, you will need to contact EXFO.



CAUTION

To ensure that the internal optical connection remains in the best condition possible, **DO NOT REMOVE** the Click-Out connector from your unit unless it is absolutely necessary.



IMPORTANT

Your unit has been designed not to require frequent calibrations (see *Recalibrating the Unit* on page 232). However, to ensure that the performance of your unit remains optimum, EXFO recommends to perform regular optical output verifications on it.

Maintenance

Verifying the Optical Output of Your Unit

To verify the optical output of your unit:

1. Inspect and clean the unit's optical port.
2. If the port is damaged and you have Click-Out connectors, you can replace it (see *Replacing the Click-Out Optical Connector* on page 228). If the port is damaged and your unit is not equipped with a Click-Out connector, contact EXFO (see *Service and Repairs* on page 282).

OR

If the port seems fine, continue with the remaining steps of this procedure.

3. Inspect and clean the connector of the launch cord that you will be connecting to the optical port during the verification process.
4. On your unit, from the main window, tap **Tools**.

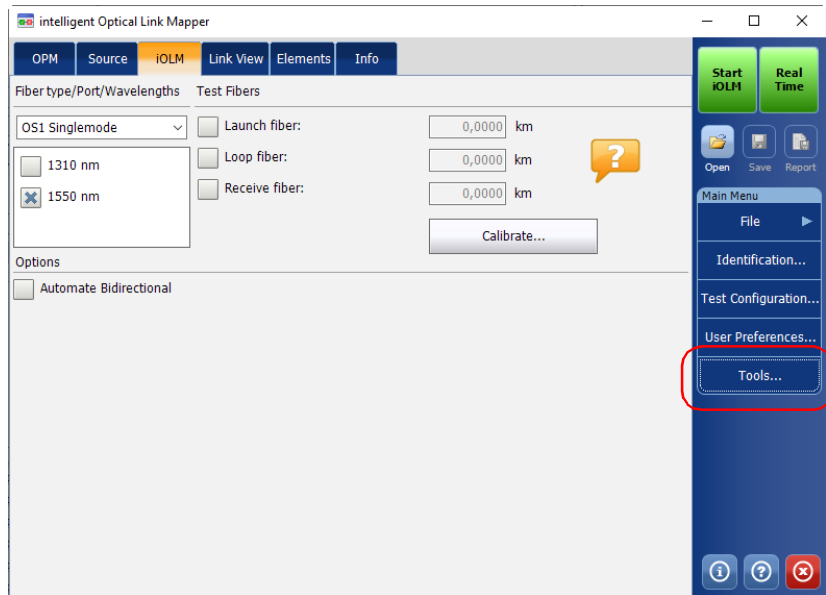

5. The most recent diagnoses for your connectors appear on screen. Tap on the **Test** button next to the connector you want to test. You can have one or two connectors, SM and MM.

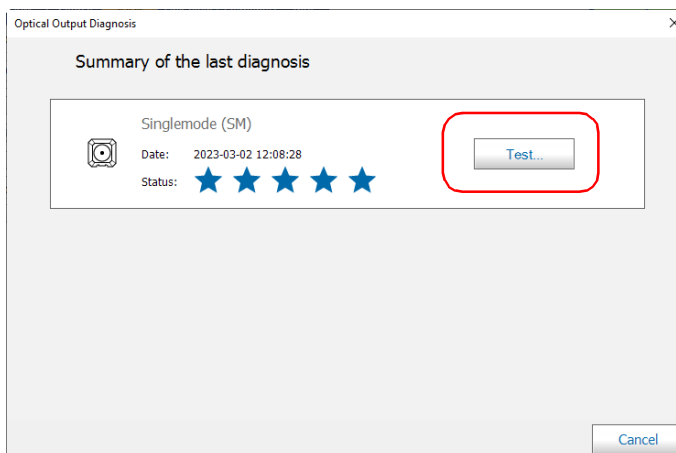

6. Select the connector type that you want to test, then tap **Next**.

Note: *For multimode, only the UPC connector is available.*

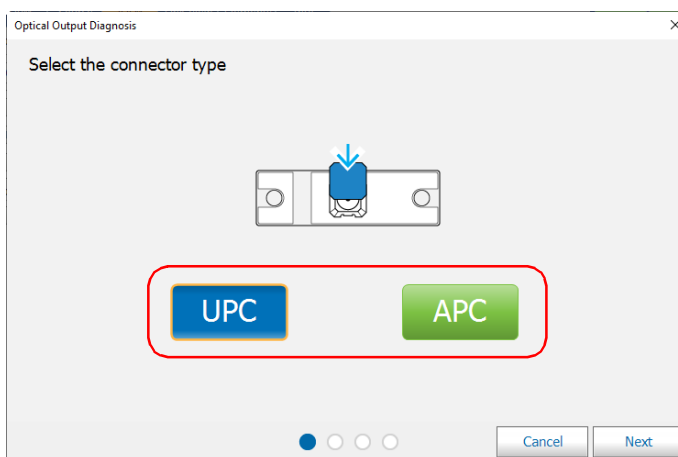

Maintenance

Verifying the Optical Output of Your Unit

7. Connect the test cord to the optical port of your unit, and then tap **Next**.

Note: *The other end of the cord must remain unconnected.*

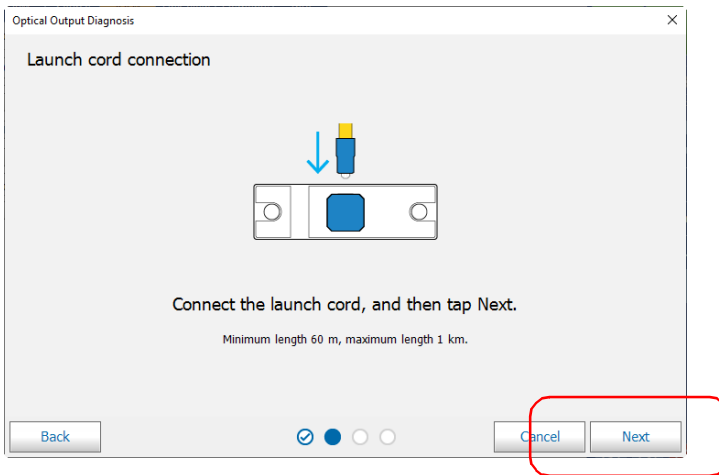

Once the test is complete, the unit displays the result of the verification as well as recommendations, when applicable. If you have finished your work, tap **Done**. If you want to perform the verification again, tap **Back** from the lower left corner of the screen.

Note: *If you want to know if the internal connector is damaged or if you could only replace the Click-Out connector, see Determining the Condition of the Click-Out Optical Connector on page 226. If your unit is not equipped with a Click-Out connector and the unit needs a connector replacement, you have to contact EXFO (see Service and Repairs on page 282).*

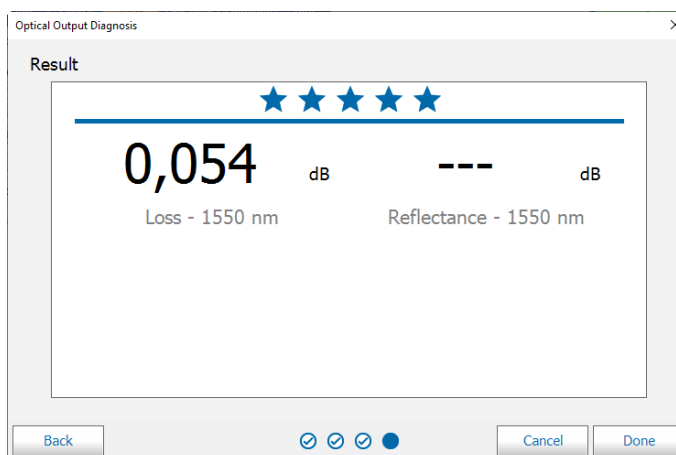

Maintenance

Determining the Condition of the Click-Out Optical Connector

Determining the Condition of the Click-Out Optical Connector

You can perform a procedure to help you determine if there is a problem with the internal connector or only with the replaceable Click-Out connector.

To determine if the Click-Out connector needs to be replaced:

1. Remove the Click-Out connector from the unit (see the corresponding procedure in *Replacing the Click-Out Optical Connector* on page 228).
2. Clean and inspect the optical port and the optical connector that connects inside the unit.

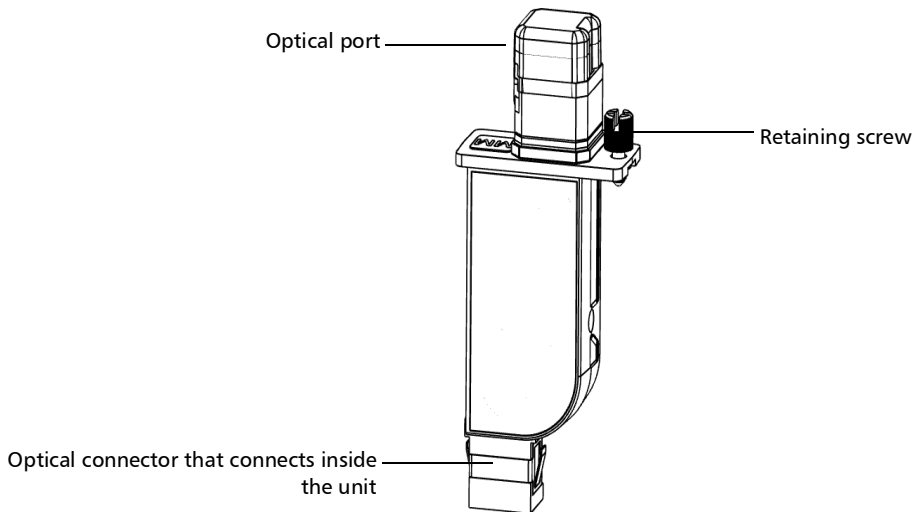

3. If the port or the connector is damaged, replace the Click-Out connector (see *Replacing the Click-Out Optical Connector* on page 228).

OR

If the port and connector seem fine, continue with the remaining steps of this procedure.

4. It is not necessary nor recommended to clean or inspect the internal connector. However, if you still need to clean the internal connector, you can do so from the Click-Out connector bay by using a 2.5 mm pencil cleaner (see *Cleaning Optical Connectors Using a Mechanical Cleaner* on page 220 for details)

Note: *If you do not have a 2.5 mm pencil cleaner, you can use a dry lint-free swab.*

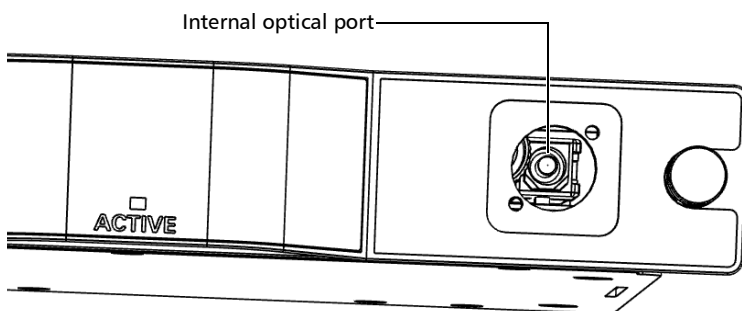

5. Place the Click-Out connector back in the unit (see the corresponding procedure in *Replacing the Click-Out Optical Connector* on page 228).
6. Perform an optical output test again.
7. If the rating remains low (three stars or less), you could repeat the steps above. If after a couple of tries the rating remains low, it probably means that the internal connector needs to be replaced. In this case, contact EXFO (see *Service and Repairs* on page 282).

Maintenance

Replacing the Click-Out Optical Connector

Replacing the Click-Out Optical Connector

Click-Out optical connectors are designed so that you can replace them should you need a different connector type (APC or UPC), or if it becomes damaged with time. You can purchase new Click-Out connectors from EXFO.

If your unit is not equipped with a Click-Out optical connector and the connector has to be replaced, you need to contact EXFO (see *Service and Repairs* on page 282).

To remove the Click-Out optical connector:

1. Turn off the unit (shutdown).
2. Disconnect the fiber and USB cable from the unit, if applicable.
3. Position the unit so that you can see its Click-Out connector and easily access it., then loosen the retaining screw on it.

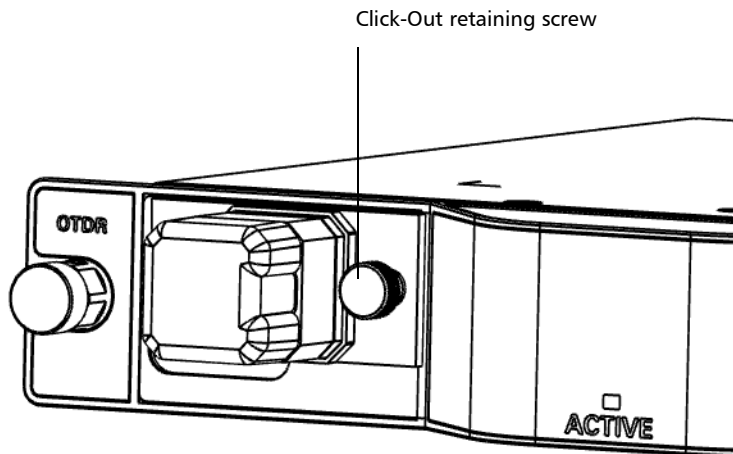

4. Pull the Click-Out connector out of the unit.

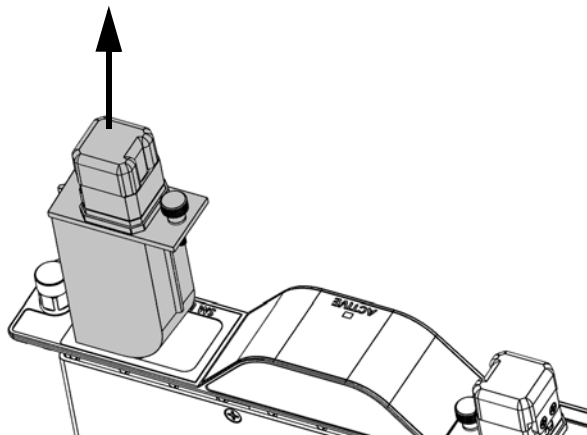

Maintenance

Replacing the Click-Out Optical Connector

To replace (or reinstall) the Click-Out optical connector:

1. Position the new Click-Out connector vertically so that the retaining screw is toward the middle of the module and that the optical port is pointing upwards.

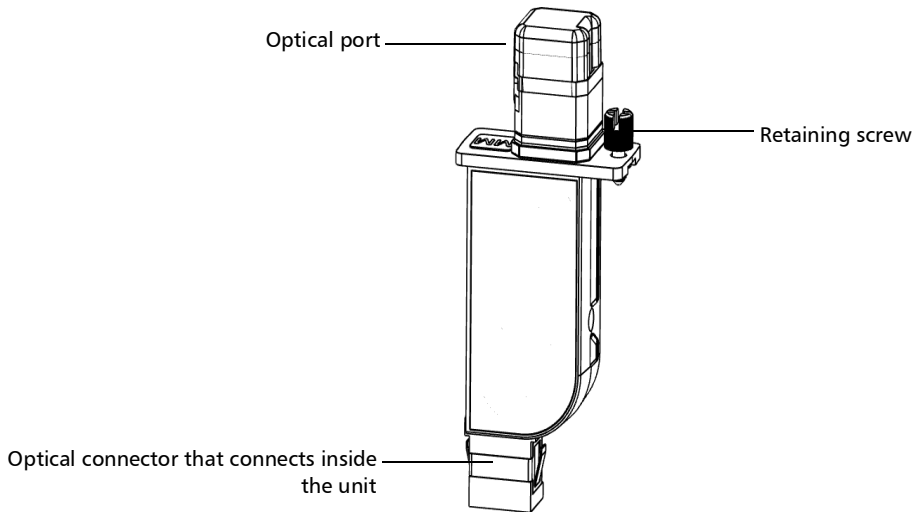

2. Remove the dust cap protecting the optical connector (which should be pointing downwards), being careful not to touch the optical connector.
3. Inspect the optical connector (from which you have just removed the dust cap), and clean it if necessary.

4. Slide the Click-Out connector into the unit until it clicks into place.

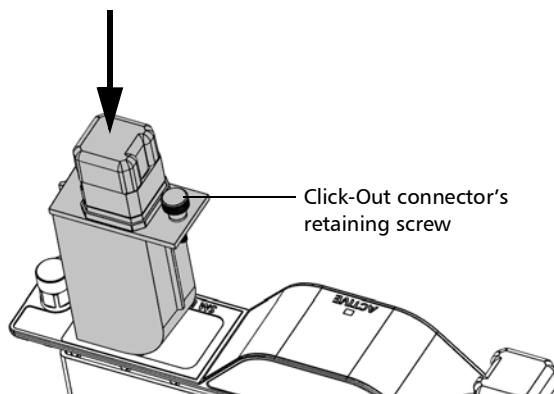

There should be no gap between the edges of the Click-Out connector and its bay when it is inserted properly.

5. Tighten the retaining screw to hold the connector in place.
6. Inspect and clean the optical port if necessary.
7. Turn on the unit.
8. Perform an optical output verification to ensure that the new Click-Out connector is installed properly and that the unit takes into account the right connector type (see *Verifying the Optical Output of Your Unit* on page 221).

Note: *If the optical output verification detects issues, see the step about how to clean the internal connector in Determining the Condition of the Click-Out Optical Connector on page 226.*

Your unit is ready to use.

Recalibrating the Unit

EXFO manufacturing and service center calibrations are based on the ISO/IEC 17025 standard (*General Requirements for the Competence of Testing and Calibration Laboratories*). This standard states that calibration documents must not contain a calibration interval and that the user is responsible for determining the re-calibration date according to the actual use of the instrument.

The validity of specifications depends on operating conditions. For example, the calibration validity period can be longer or shorter depending on the intensity of use, environmental conditions and unit maintenance, as well as the specific requirements for your application. All of these elements must be taken into consideration when determining the appropriate calibration interval of this particular EXFO unit.

Under normal use, the recommended interval for your intelligent Optical Link Mapper is: one year.

For newly delivered units, EXFO has determined that the storage of this product for up to six months between calibration and shipment does not affect its performance.

To help you with calibration follow-up, EXFO provides a special calibration label that complies with the ISO/IEC 17025 standard and indicates the unit calibration date and provides space to indicate the due date. Unless you have already established a specific calibration interval based on your own empirical data and requirements, EXFO would recommend that the next calibration date be established according to the following equation:

Next calibration date = Shipping date + Recommended calibration period (one year)

To ensure that your unit conforms to the published specifications, calibration may be carried out at an EXFO service center or, depending on the product, at one of EXFO's certified service centers. Calibrations at EXFO are performed using standards traceable to national metrology institutes.

Note: *You may have purchased a FlexCare plan that covers calibrations. See the Service and Repairs section of this user documentation for more information on how to contact the service centers and to see if your plan qualifies.*

Recycling and Disposal



This symbol on the product means that you should recycle or dispose of your product (including electric and electronic accessories) properly, in accordance with local regulations. Do not dispose of it in ordinary garbage receptacles.

For complete recycling/disposal information, visit the EXFO Web site at www.exfo.com/recycle.

16 *Troubleshooting*

Viewing Online Documentation

An online version of the intelligent Optical Link Mapper user guide is available at all times from the application.

To access online help:

At the bottom of the **Main Menu**, tap .

Contacting the Technical Support Group

To obtain after-sales service or technical support for this product, contact EXFO at one of the following numbers. The Technical Support Group is available to take your calls from Monday to Friday, 8:00 a.m. to 7:00 p.m. (Eastern Time in North America).

Technical Support Group

400 Godin Avenue
Quebec (Quebec) G1M 2K2
CANADA

1 866 683-0155 (USA and Canada)
Tel.: 1 418 683-5498
Fax: 1 418 683-9224
support@exfo.com

For detailed information about technical support, and for a list of other worldwide locations, visit the EXFO Web site at www.exfo.com.

If you have comments or suggestions about this user documentation, you can send them to customer.feedback.manual@exfo.com.

To accelerate the process, please have information such as the name and the serial number (see the product identification label), as well as a description of your problem, close at hand.

Troubleshooting

Viewing Information About Your iOLM

Viewing Information About Your iOLM

You can view information about your iOLM such as the version number and contact information for technical support in the **About** window.

To view iOLM information:

From the main window, tap .

Transportation

Maintain a temperature range within specifications when transporting the unit. Transportation damage can occur from improper handling. The following steps are recommended to minimize the possibility of damage:

- Pack the unit in its original packing material when shipping.
- Avoid high humidity or large temperature fluctuations.
- Keep the unit out of direct sunlight.
- Avoid unnecessary shocks and vibrations.

17 Warranty

General Information

EXFO Inc. (EXFO) warrants this equipment against defects in material and workmanship for a period of one year from the date of original shipment. EXFO also warrants that this equipment will meet applicable specifications under normal use.

During the warranty period, EXFO will, at its discretion, repair, replace, or issue credit for any defective product, as well as verify and adjust the product free of charge should the equipment need to be repaired or if the original calibration is erroneous. If the equipment is sent back for verification of calibration during the warranty period and found to meet all published specifications, EXFO will charge standard calibration fees.



IMPORTANT

The warranty can become null and void if:

- unit has been tampered with, repaired, or worked upon by unauthorized individuals or non-EXFO personnel.
- warranty sticker has been removed.
- case screws, other than those specified in this guide, have been removed.
- case has been opened, other than as explained in this guide.
- unit serial number has been altered, erased, or removed.
- unit has been misused, neglected, or damaged by accident.

THIS WARRANTY IS IN LIEU OF ALL OTHER WARRANTIES EXPRESSED, IMPLIED, OR STATUTORY, INCLUDING, BUT NOT LIMITED TO, THE IMPLIED WARRANTIES OF MERCHANTABILITY AND FITNESS FOR A PARTICULAR PURPOSE. IN NO EVENT SHALL EXFO BE LIABLE FOR SPECIAL, INCIDENTAL, OR CONSEQUENTIAL DAMAGES.

Warranty

Gray Market and Gray Market Products

Gray Market and Gray Market Products

Gray market is a market where products are traded through distribution channels that are legal but remain unofficial, unauthorized, or unintended by the original manufacturer. Intermediaries using such channels to distribute products are considered to be part of the gray market (hereafter unauthorized intermediary).

EXFO considers that a product originates from the gray market (hereafter gray market product) in the following situations:

- A product is sold by an unauthorized intermediary.
- A product is designed and destined for a particular market and sold on a second market.
- A product is resold, despite being reported lost or stolen.

When products are purchased on the gray market, rather than through an authorized EXFO distribution channel, EXFO is unable to guarantee the source and quality of those products nor the local safety regulations and certifications (CE, UL, etc.).

EXFO will not honor warranty, install, maintain, repair, calibrate, provide technical support nor make any support contracts available for gray market products.

For complete information, refer to EXFO's policy regarding gray market products at www.exfo.com/en/how-to-buy/sales-terms-conditions/gray-market/

Liability

EXFO shall not be liable for damages resulting from the use of the product, nor shall be responsible for any failure in the performance of other items to which the product is connected or the operation of any system of which the product may be a part.

EXFO shall not be liable for damages resulting from improper usage or unauthorized modification of the product, its accompanying accessories and software.

Exclusions

EXFO reserves the right to make changes in the design or construction of any of its products at any time without incurring obligation to make any changes whatsoever on units purchased. Accessories, including but not limited to fuses, pilot lamps, batteries and universal interfaces (EUI) used with EXFO products are not covered by this warranty.

This warranty excludes failure resulting from: improper use or installation, normal wear and tear, accident, abuse, neglect, fire, water, lightning or other acts of nature, causes external to the product or other factors beyond the control of EXFO.



IMPORTANT

In the case of products equipped with optical connectors, EXFO will charge a fee for replacing connectors that were damaged due to misuse or bad cleaning.

Certification

EXFO certifies that this equipment met its published specifications at the time of shipment from the factory.

Service and Repairs

EXFO commits to providing product service and repair for five years following the date of purchase.

To send any equipment for service or repair:

1. Call one of EXFO's authorized service centers (see *EXFO Service Centers Worldwide* on page 241). Support personnel will determine if the equipment requires service, repair, or calibration.
2. If equipment must be returned to EXFO or an authorized service center, support personnel will issue a Return Merchandise Authorization (RMA) number and provide an address for return.
3. If possible, back up your data before sending the unit for repair.
4. Pack the equipment in its original shipping material. Be sure to include a statement or report fully detailing the defect and the conditions under which it was observed.
5. Return the equipment, prepaid, to the address given to you by support personnel. Be sure to write the RMA number on the shipping slip. *EXFO will refuse and return any package that does not bear an RMA number.*

Note: *A test setup fee will apply to any returned unit that, after test, is found to meet the applicable specifications.*

After repair, the equipment will be returned with a repair report. If the equipment is not under warranty, you will be invoiced for the cost appearing on this report. EXFO will pay return-to-customer shipping costs for equipment under warranty. Shipping insurance is at your expense.

Routine recalibration is not included in any of the warranty plans. Since calibrations/verifications are not covered by the basic or extended warranties, you may elect to purchase FlexCare Calibration/Verification Packages for a definite period of time. Contact an authorized service center (see *EXFO Service Centers Worldwide* on page 241).

EXFO Service Centers Worldwide

If your product requires servicing, contact your nearest authorized service center.

EXFO Headquarters Service Center

400 Godin Avenue
Quebec (Quebec) G1M 2K2
CANADA

1 866 683-0155 (USA and Canada)
Tel.: 1 418 683-5498
Fax: 1 418 683-9224
support@exfo.com

EXFO Europe Service Center

Winchester House, School Lane
Chandlers Ford, Hampshire S053 4DG
ENGLAND

Tel.: +44 2380 246800
Fax: +44 2380 246801
support.europe@exfo.com

EXFO Telecom Equipment (Shenzhen) Ltd.

3rd Floor, Building C,
FuNing Hi-Tech Industrial Park, No. 71-3,
Xintian Avenue,
Fuhai, Bao'An District,
Shenzhen, China, 518103

Tel: +86 (755) 2955 3100
Fax: +86 (755) 2955 3101
support.asia@exfo.com

To view EXFO's network of partner-operated Certified Service Centers nearest you, please consult EXFO's corporate website for the complete list of service partners:

<http://www.exfo.com/support/services/instrument-services/exfo-service-centers>.

A Automating Bidirectional Acquisitions

Note: *This feature is available through the iLoop software option. For more information about installing and activating software options using Update Manager, refer to your platform user guide.*

Note: *This feature is not available on the MAX platform.*

Note: *Both of your modules must either have the iCert option, or not have it. You cannot use only one iCert module to perform the automated bidirectional measurement.*

The automated bidirectional acquisition option allows you to automate a bidirectional measurement between two units connected end to end in order to run a series of tests defined in a job. Once the fiber under test is connected between the two units, the bidirectional measurement is performed in one step. The connection is automatically synchronized between the two units through a communication fiber, with the main unit (A) being used to create the jobs and start the acquisition. The results (iOLM, bidir, .sor, PDF) are saved automatically and named using the test name defined in the job.

Before you connect your two units, a wizard will guide you to establish a proper bidirectional communication between your two units.

Note: *This feature is not available on 740C (CWDM and DWDM) modules.*

Automating Bidirectional Acquisitions

To install the accessory bag to your unit:

- 1.** Align the notches on each side of the bag with the metal rods on your unit, then lower the bag onto it.

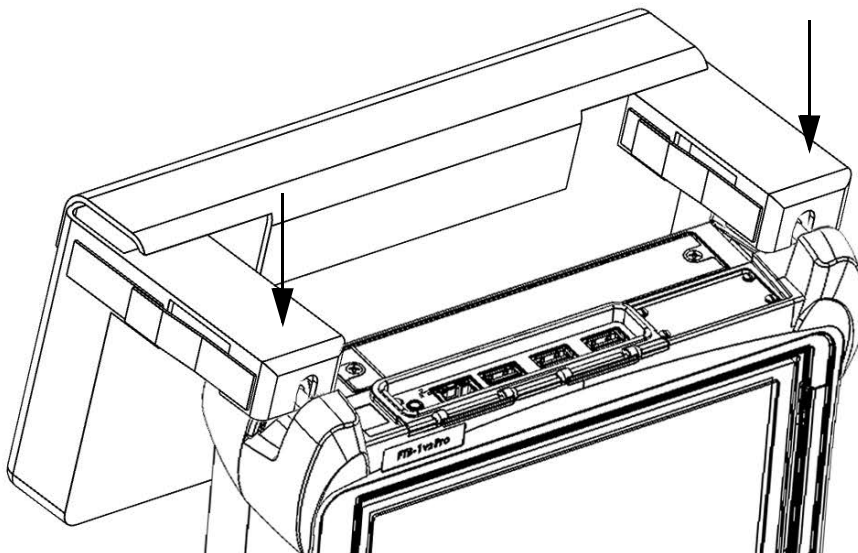

2. Use the Velcro fasteners on each side to tighten the grip around the unit.

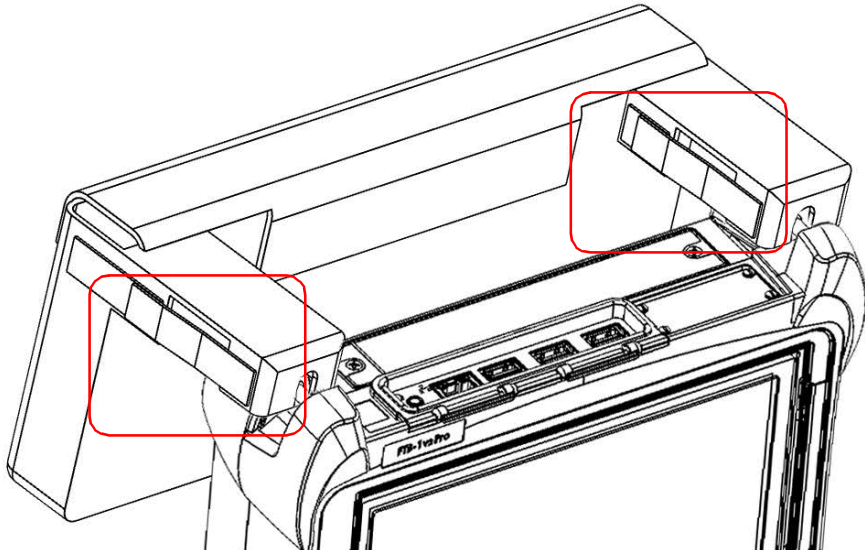

Automating Bidirectional Acquisitions

3. Place your setup components inside the bag as follows:



To analyze the link and optimize communication between the two units:

1. From the **iOLM** tab, tap **Automate Bidirectional** to display the SFP selection wizard.
2. Tap **Recommend SFP**.

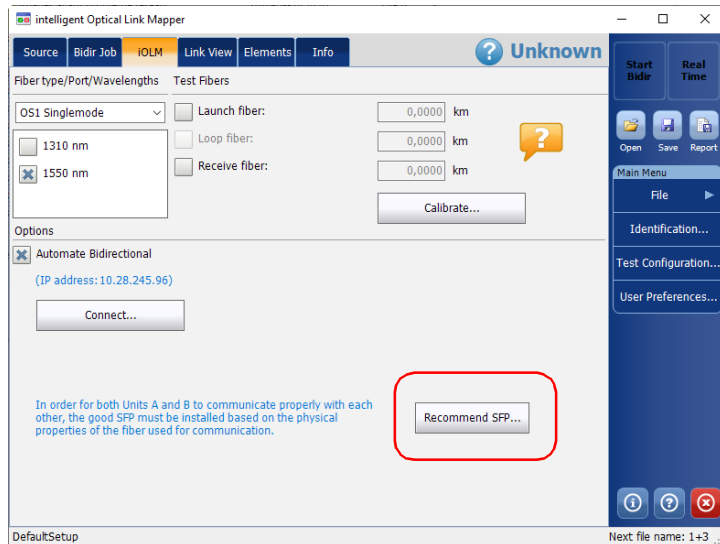

Automating Bidirectional Acquisitions

3. Connect the communication fiber into the SM port of your unit. The units must be connected using the same communication fiber.



4. Tap **OK** to start the analysis.

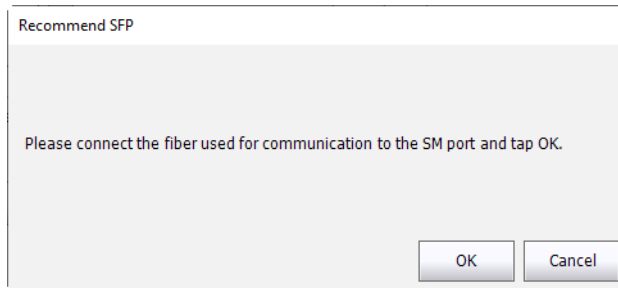

5. The recommended SFP and attenuator appear on-screen. After you have connected the SFP on your side, contact the technician working with unit B so that they install the other SFP on their side. Once you have connected your setup accordingly, you are ready to perform the job. Tap **OK** to exit the wizard.

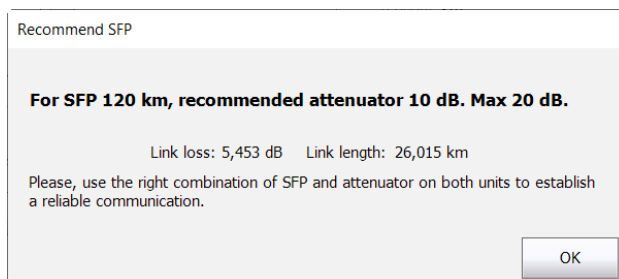

Automating Bidirectional Acquisitions

To connect units A and B:

1. Connect the communication fiber (dark fiber) to the SFP according to the configuration below:

Configuration	Unit A	Unit B
1	SFP 1550-1490	SFP 1490-1550
2	SFP 1490-1550	SFP 1550-1490

2. Connect the media adapter to your platform through their Ethernet ports using an RJ-45 cable.

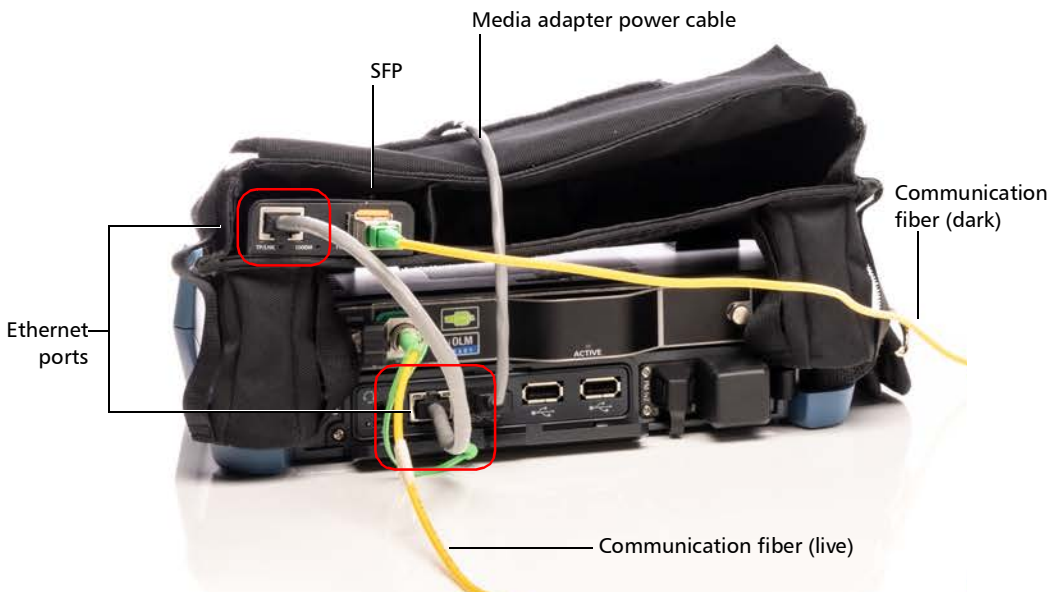

3. On both units, from the **iOLM** tab, tap **Automate Bidirectional** if you have not done so already.

Note: The IP address for each unit appears on-screen.

4. If you have not done so already, select the appropriate SFP and attenuators using the wizard (as explained in *To analyze the link and optimize communication between the two units*: on page 247)
5. Note down the IP address for unit B or have the other technician provide it to you, then tap **Connect** on unit A.

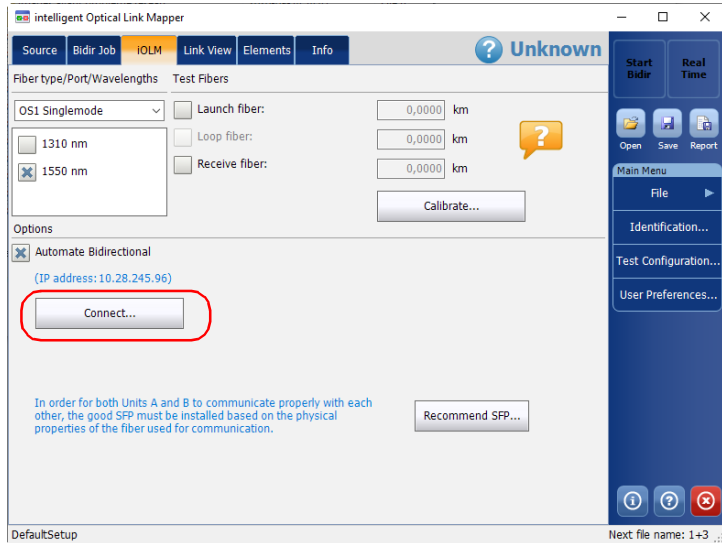

6. Enter the IP address of unit B, then tap **OK**.

The screenshot shows a dialog box titled 'IP Address'. It contains the text 'Enter the IP address for Unit B:' followed by a text input field containing the IP address '10.28.245.96'. Below the input field are two buttons: 'OK' and 'Cancel'.

Automating Bidirectional Acquisitions

Both units synchronize and unit B will display the current job information and identifiers automatically.

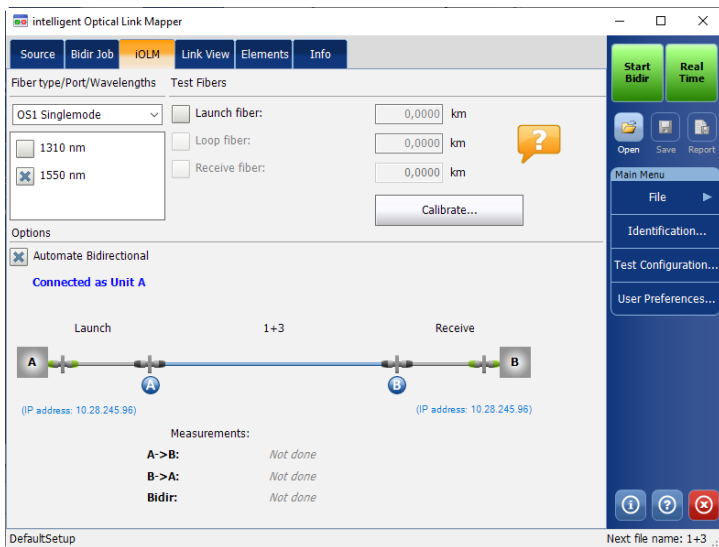

To create a job:

1. From the **iOLM** tab of unit A, tap **Automate Bidirectional** to display the **Bidir Job** tab.

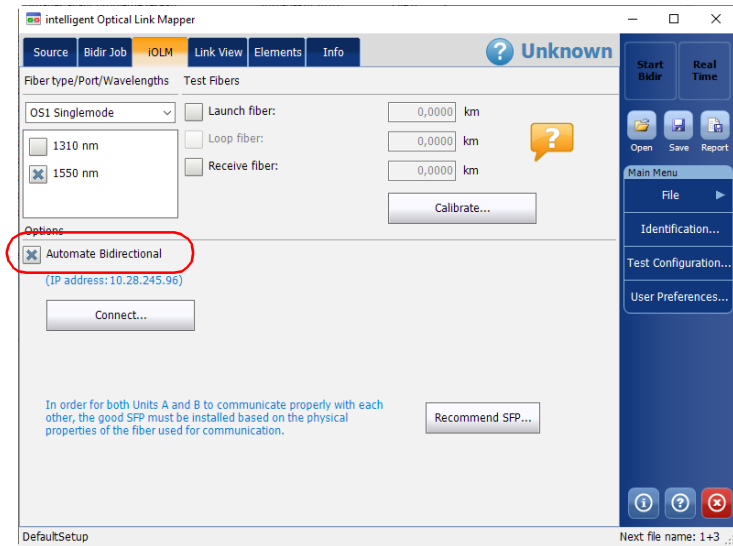

Automating Bidirectional Acquisitions

2. Tap on the tab to access it, then tap **Create Job**.

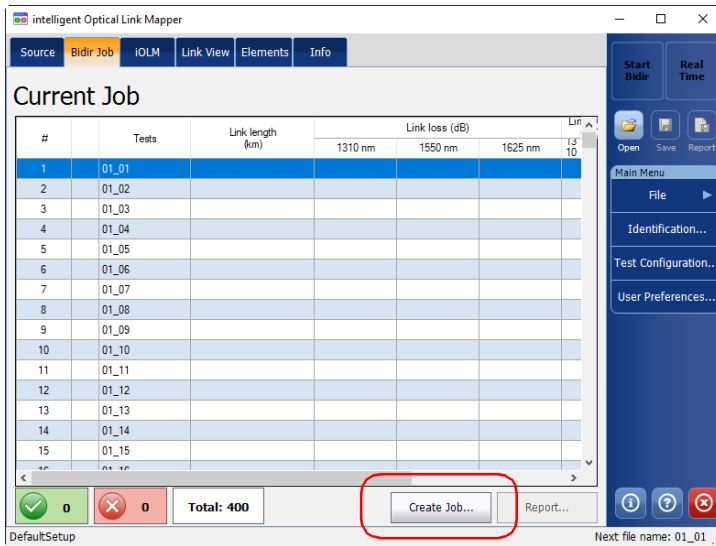

3. Enter the information to identify the job, then tap **Next**.

The 'New Job' dialog box contains the following fields:

- Job *: Current Job
- Company: My Company
- Customer: My Customer
- Operator A: Op. A
- Operator B: Op. B
- Location A: Loc. A
- Location B: Loc. B
- Comments: This is the current job

At the bottom of the dialog, the 'Next >' button is highlighted with a red circle, and the 'Cancel' button is also visible.

4. Select at least one identifier for your acquisitions. Enter a range as needed, and a the type of separator to put between each measurement. The range can be alphabetic or numeric.

My test job

Identifier	From	To	Separator
Cable ID	A	A	-
Fiber ID	01	10	

Preview: 10 Tests

A-04
A-05
A-06
A-07
A-08
A-09
A-10

< Back Create Cancel

Note: *Alphabetic ranges are limited to one value and will not increment.*

Note: *You must enter the same number of digits in your range values. For examples if your range is from 1 to 100, you must enter 001 as the start value and 100 as the end value. Once you have set the identifiers and range, tap **Create**. The **Bidir Job** tab is populated accordingly.*

Automating Bidirectional Acquisitions

To perform an automated bidirectional acquisition:

1. Connect units A and B together as explained in *To connect units A and B:* on page 250.
2. Create a job on unit A as indicated in *To create a job:* on page 253.
3. On the **iOLM** tab, enter the value for the launch fibers on both units.

Note: *The receive fibers will be automatically entered.*

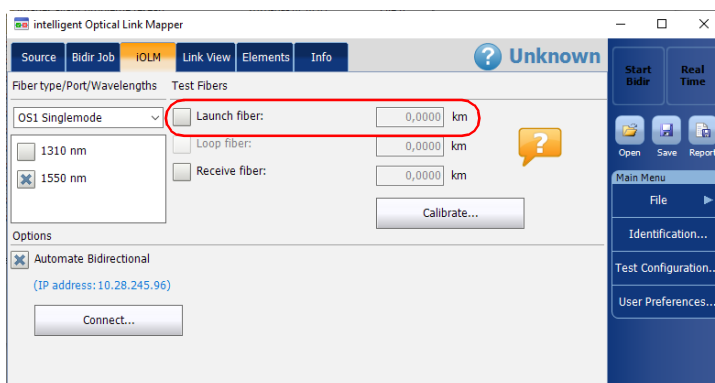

4. If you have not done so already, select the test configuration you want to use for the job as explained in *Selecting a Test Configuration* on page 87.

5. Select the wavelengths to use for the job.

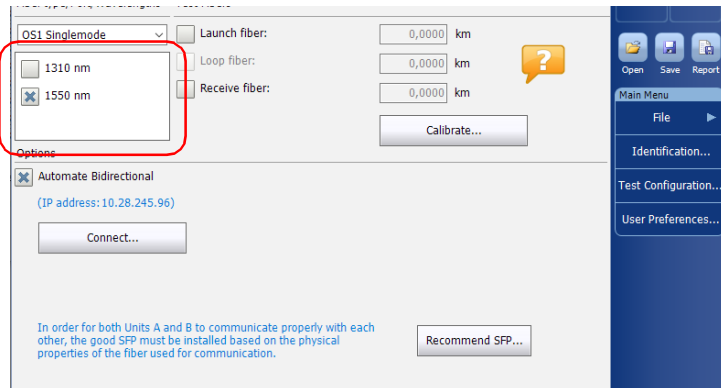

6. Tap **Start Bidir**. The results are displayed as the test progresses.

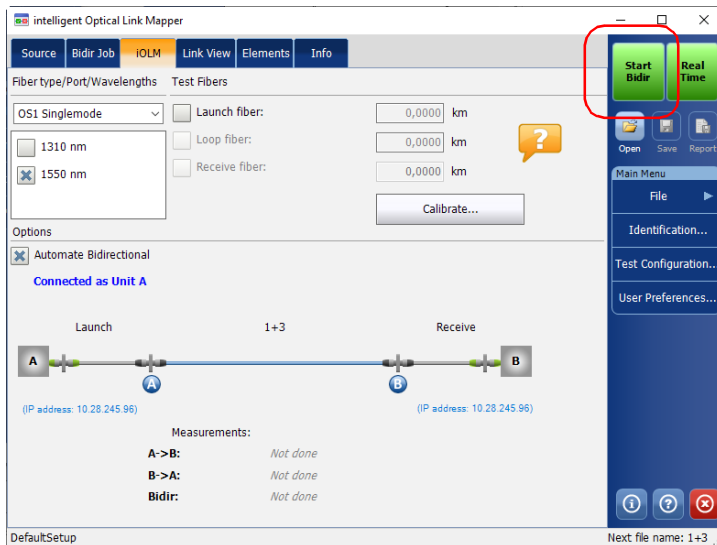

By default, the application will proceed with the next unperformed test, but you can also go in the **Bidir Job** tab to select a specific test to perform.

Automating Bidirectional Acquisitions

To view test results:

The **Bidir Job** tab of either unit will show the summary view of the tests. If you tap on a result in the list, the other tabs will display detailed information about the result.

Note: All of the bidirectional tests, PDF reports and .sor traces generated for a job are stored in the default folder set in the user preferences, in a subfolder bearing the job name.

To repeat an existing test:

From the **Bidir Job** tab, select the test you want to perform again, then tap **Test again**. The results will be updated accordingly.

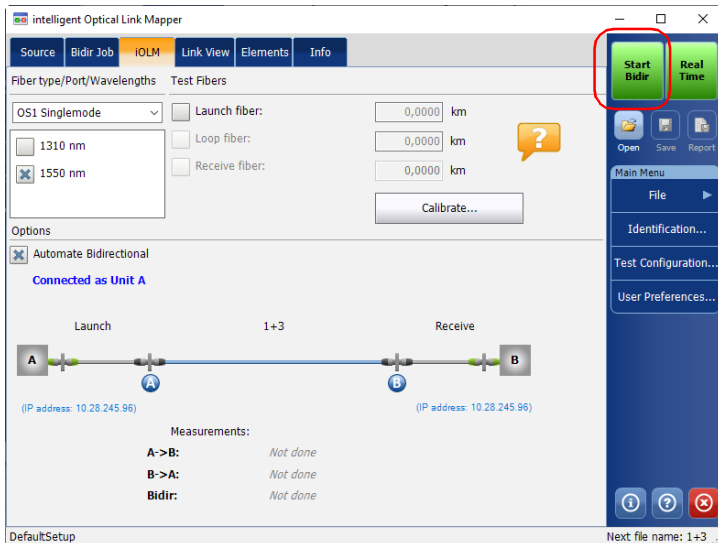

To create a report of the bidirectional jobs:

1. From the **iOLM** tab, tap **Automate Bidirectional** to display the **Bidir Job** tab if you have not done so already.

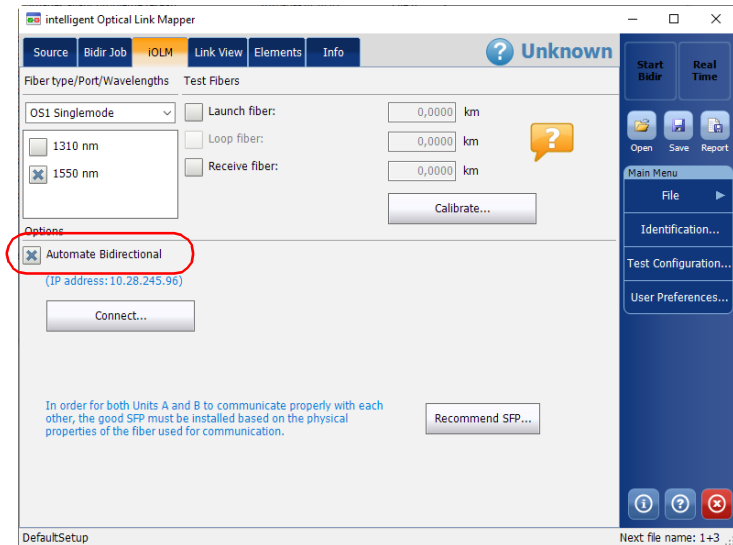

Automating Bidirectional Acquisitions

2. Tap on the tab to access it, then tap **Report**.

The screenshot displays the Intelligent Optical Link Mapper (iOLM) software interface. The main window is titled "Test Job" and contains a table with the following data:

#	Tests	Link length (km)	Link loss (dB)			Link
			1310 nm	1550 nm	1625 nm	
1	1+1	0.0000				
2	1+2	0.0000				
3	1+3	4.1648				
4	1+4	4.1648		1.094		
5	1+5	4.1648		1.095		
6	2+1	4.1648		1.093		
7	2+2					
8	2+3					
9	2+4					
10	2+5					
11	3+1					
12	3+2					
13	3+3					
14	3+4					
15	3+5					

At the bottom of the interface, there is a status bar showing "4" tests passed, "0" tests failed, and a "Total: 25" count. A "Report..." button is highlighted with a red circle. The interface also includes a "Pass" indicator, a "Main Menu" sidebar, and a "Next file name: 1+4" field.

3. Select the type of report you want to create, either a summary of the job or each result individually.

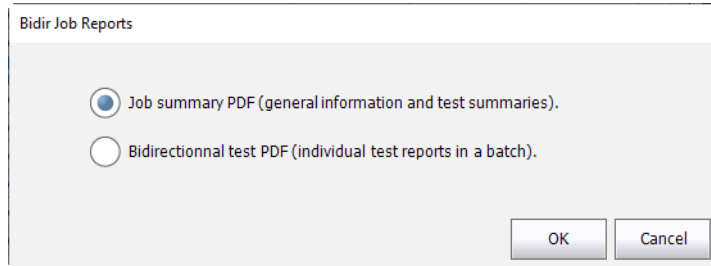

4. Tap **OK**. The reports are generated automatically according to the report settings of your application. For more information on setting up the format and location of the reports, see *Setting the Default Storage Folder* on page 147 and *Customizing Reports* on page 150.

Note: *All of the bidirectional tests, PDF reports and .sor traces generated for a job are stored in the default folder set in the user preferences, in a subfolder bearing the job name.*

Index

- 199
- 207
- * 198, 199
- # 37, 41
- < 189
- > 195

- 1:? splitter ratio 111, 112
- 1:N splitter 109
- 2:N splitter 109, 112, 180, 183, 201, 203

- A**
- accessory bag 244
- acquiring traces
 - sequentially with a CWDM module 79
 - sequentially with a DWDM module 69
- acquisition
 - automated bidir 256
 - automated sequence 59, 60
 - multiple wavelengths 189
 - progress bar 30
 - real-time mode 144
 - status 137
 - stopped 143
 - time selection 91, 94
 - types 7
 - wavelength displayed 30
 - with a power meter 169
- activating
 - automated acquisition sequence 59, 60
 - automated report creation 151
 - automated storage of the files 156
 - cumulative loss 58
 - real-time mode 144
- adding
 - custom elements 105
 - elements on a link 199, 200
 - elements on fiber sections 202
 - favorite channels 66, 76
- additional verifications on connectors 226
- after-sales service 235
- analyzing links 199, 205
- APC connectors 11, 208
- application, certification standards 119
- attenuation, high values 84
- automated
 - acquisition sequence 59, 60
 - report creation 151
 - storage of the files 156
- automated bidir
 - connecting units 250
 - jobs 253
 - option 243
 - performing acquisition 256
 - repeating test 258
 - reports 259
 - test results 258
- autonaming 38, 207

- B**
- backscatter
 - coefficients 12
 - values 101, 107
- basic element types, icons 101
- batch post-processing 8
- beginning
 - of loop 181
 - of the link 178, 181, 186, 195
- Bellcore (.sor) format 69, 79, 148, 212, 214
- bidirectional
 - automated testing 243
 - loopback acquisitions 139

Index

- loopback results 190
- selecting option 52
- test results 258

- C**
- cabling standards 119
- calculating link loss budget 120
- calibration process 57
- caution
 - of personal hazard 16
 - of product hazard 16
- certification standards
 - predefined 209
 - selection 90, 119
- changing
 - connector 228
 - default name 36
 - distance units 155
 - test configuration properties 91
- channel
 - filter selection 74
 - spacing selection 64
 - wavelength selection 65, 75
- channels for inline power meter 161
- cleaning
 - connectors 220
 - EUI connectors 218
 - fiber ends 33
 - front panel 217
- Click-Out
 - connector verifications 221
 - optical connector 226, 228
- colored background 178
- compliance, encircled flux 9
- configuration
 - file name selected 30
 - name 90
- configuring
 - automatic file naming 38
 - in loopback mode 47
 - in standard mode 43
- iOLM 42
- connecting
 - switch 31, 53
 - units, automated bidir 250
- connector
 - A 58, 178, 181, 186, 195
 - APC 11, 208
 - B 58, 178, 181, 186, 195, 199
 - loss 11
 - MPO 32
 - on link 183
 - UPC 208
 - verifications 221
 - verifying 226
- connector cleaner 220
- connectors, cleaning 218
- conventions, safety 16
- core size 9, 101, 107
- coupler 59, 184, 192
- creating automated bidir job 253
- cumulative loss 58, 185, 195
- custom
 - elements, creating 102
 - power meter thresholds values 163
- custom configurations
 - creating 89
 - deleting 134
 - duplicating 89
 - editing 129
 - exporting 132
 - importing 130
 - selecting 87, 88
- custom elements, creating 105
- customer service 240
- customizing
 - icon 101
 - power meter thresholds values 128
 - reports 150
 - time values 91, 94
- CWDM
 - adding favorite channels 76
 - channel filter selection 74

- channel selection 75
 - dark fiber 84
 - definition 1, 73
 - displaying favorite channels 78
 - dynamic range 84
 - electronic noise 84
 - live-fiber testing 84
 - macroband detection 81
 - main features 73
 - measurement mode 165
 - module 73
 - mux/demux channels 84
 - removing favorite channels 77
 - residual light 84
- D**
- damaged connector on unit 228
 - dark fiber 71, 84, 250
 - deactivating
 - acquisition sequence 59, 60
 - automated storage of the files 156
 - cumulative loss 58
 - real-time mode 146
 - decrementing name 36
 - default
 - folder 147, 148, 151
 - icon 101, 102
 - defining
 - link 90, 98, 102
 - splitter ratio 109
 - definition
 - CWDM 1
 - DWDM 1
 - standard iOLM 1
 - deleting
 - custom elements 106
 - elements on a link 204
 - test configurations 134
 - delta loss value 81
 - detecting macrobands, CWDM module 81
 - diagnostics icon 159, 178, 180
 - direction appended to file name 148
 - disabling
 - automated acquisition sequence 59, 60
 - automated storage of the files 156
 - cumulative loss 58
 - sound notifications 153
 - displaying
 - favorite channels 68, 78
 - fiber sections 154
 - distance
 - between elements 178
 - units 155, 181, 203
 - duplicating test configurations 89
 - DWDM
 - adding favorite channels 66
 - channel selection 65
 - channel spacing selection 64
 - dark fiber 71
 - definition 1, 63
 - displaying favorite channels 68
 - dynamic range 71
 - electronic noise 71
 - live-fiber testing 71
 - main features 63
 - mux/demux channels 71
 - removing favorite channels 67
 - residual light 71
 - dynamic
 - loss budget 123, 124
 - range 57, 71, 84, 182
- E**
- editing
 - custom elements 105
 - element types 197
 - macroband threshold value ... 83, 101, 108
 - pass/fail thresholds 90
 - power meter thresholds 90
 - test configurations 129
 - EF-compliant device 9
 - electrical safety information 28

Index

- electronic noise 71, 84
 - element
 - 2:N splitter..... 183
 - connector 183
 - coupler 184, 192
 - fail icon..... 181
 - fault..... 184
 - grouping 187
 - identification number .. 180, 186, 195, 199
 - macroband 182
 - out of range 182
 - pass icon..... 180
 - position 180
 - selected 178, 180
 - splice 183
 - splitter 182
 - switch..... 183
 - types, edition..... 197
 - unbalanced splitter..... 184, 185
 - ungrouping 188
 - Elements tab 159, 175, 196, 197, 200, 202, 204, 205
 - enabling
 - 2:N splitter..... 112
 - automated acquisition sequence 59, 60
 - automated storage of the files 156
 - cumulative loss 58
 - sound notifications..... 153
 - encircled flux compliance 9
 - end
 - of loop..... 181
 - of the link 12, 58, 178, 181, 186, 195, 199
 - equipment returns 240
 - EUI
 - baseplate..... 35
 - connector adapter 35
 - connectors, cleaning..... 218
 - dust cap..... 35
 - EXFO universal interface. *see* EUI
 - expected loss budget of a link..... 86
 - exporting
 - data to other formats 8
 - files in Bellcore format 214
 - test configurations..... 132
- F**
- factory settings..... 41
 - fail
 - icon..... 180
 - status 143, 177, 181, 192, 209
 - fault..... 184
 - favorite channels
 - adding 66, 76
 - displaying 68, 78
 - managing 66, 76
 - removing 67, 77
 - fiber
 - core size..... 43, 48, 107
 - dark 71, 84
 - identifying by name 36
 - section 154, 180, 195, 202
 - types 98, 99
 - types, selection 90
 - water peak 84
 - fiber ends, cleaning 33
 - fiber properties
 - backscatter 107
 - core size..... 107
 - IOR..... 107
 - file
 - autonaming 207
 - exporting in Bellcore format 214
 - opening 211
 - saving 212
 - saving in Bellcore format 69, 79
 - saving in native format 69, 79
 - file name
 - configuration 38
 - decrementing..... 36
 - direction appended 148
 - incrementing 36

order of appearance 39
 preview 36, 39
 separator 39
 wavelength value appended 148
 first
 connector value 124
 element on link 11, 58, 178, 181,
 186, 195
 fixed loss budget 123
 front panel, cleaning 217
 FTTx/PON measurement mode 165

G

General tab 147, 151, 153, 154, 155
 generating a report
 automated acquisition sequence 59
 automated bidirectional job 259
 automatically 150, 151, 209
 manually 150, 215
 global pass/fail status
 displayed 143, 176, 192, 199, 205, 208
 for a group of elements 185
 icon 194
 graph generation 150
 gray background, element 180
 group
 loss value 186
 of elements on link 58, 180, 185, 199
 of elements, identification
 number 185, 195
 reflectance value 186
 grouping elements 187

H

help icon 42, 235
 help. see online user guide
 hiding fiber sections 154
 high attenuation, values 84

I

icon
 2:N splitter 183
 arrow 181
 basic element types 101
 connector 183
 coupler 184
 customized 101
 diagnostics 159, 178, 180
 fail 180, 181
 fault 184
 global pass/fail status 194
 help 42
 loop end 181
 loop middle 181
 loop start 181
 macrobend 182
 out of range 182
 pass 180
 splice 183
 splitter 182
 status 209
 switch 183
 unbalanced splitter 184, 185
 identification label 235
 identification number 180, 185, 186,
 195, 199
 iLoop software option 243
 impacts of test configurations 86
 importing test configurations 130
 incrementing name 36
 Info tab 143, 175, 207
 inline power meter
 available on unit 128
 CWDM, measurement mode 165
 definition 2, 161
 FTTx/PON measurement mode 165
 number of channels available 161
 power levels 167
 threshold values 161, 162
 input connector of MPO switch 32

Index

- inserting test modules..... 29
- insertion loss..... 12
- internal connector..... 221, 226, 228
- iOLM
 - basic theory..... 7
 - bidirectional loopback acquisitions..... 139
 - configuration..... 42
 - definition..... 1
 - loopback acquisitions..... 137
 - loopback mode configuration..... 47
 - main window..... 29
 - P/F Thresholds tab..... 90, 100, 120, 122
 - results..... 175, 189
 - selecting a port..... 43, 48, 54, 60
 - selecting wavelengths..... 44, 49, 54, 61
 - standard acquisitions..... 137, 138
 - standard mode configuration..... 43
 - tab..... 42
 - testing modes..... 8
 - working with the switch..... 53
- IOR..... 101, 107
- ITU-T grid..... 63, 65, 73, 75

- J**
- jobs, automated bidir..... 243, 253
- junction between fiber sections..... 183

- L**
- label, identification..... 235
- last
 - connector, value..... 124
 - element on link..... 12, 58, 178, 181, 186, 195, 199
- launch cable
 - for MPO switch..... 32
 - length..... 10
- launch fiber
 - length..... 47
 - on a link ... 10, 11, 13, 45, 50, 55, 58, 178, 181, 186, 195
- LED..... 3, 4, 5, 6

- length
 - of the loop..... 181
 - of the measured link..... 178
- link
 - elements..... 192
 - end values..... 205
 - length..... 192
 - loss..... 189, 192
 - loss budget..... 120
 - ORL..... 189, 192
 - start values..... 205
- link composition
 - 2:N splitter..... 183
 - arrow icon..... 181
 - connector..... 183
 - coupler..... 184, 192
 - definition..... 175, 178
 - diagnostics icon..... 180
 - distance between elements..... 178
 - distance units..... 181
 - element fail icon..... 181
 - element identification number..... 180
 - element pass icon..... 180
 - element position..... 180
 - fault..... 184
 - fiber section..... 180
 - group of elements..... 180, 185
 - letter A..... 186
 - letter B..... 186
 - loop end icon..... 181
 - loop middle icon..... 181
 - loop start icon..... 181
 - macrobend..... 182
 - navigation arrow..... 178, 181
 - out of range..... 182
 - pass/fail not tested..... 180
 - selected element..... 180
 - splice..... 183
 - splitter..... 182
 - splitter ratio..... 181
 - switch..... 183
 - unbalanced splitter..... 184, 185

-
- Link Definition tab..... 90, 98, 103, 110, 114
 - link overview
 - beginning of the link 178
 - definition 175, 177
 - end of the link 178
 - length of the measured link..... 178
 - selected element..... 178
 - visible region 178
 - link view
 - bidirectional loopback results 190
 - global pass/fail status 176, 192
 - iOLM results..... 175, 189
 - power meter results..... 176, 191
 - unidirectional loopback results 190
 - Link View tab 137, 142, 159, 175, 196, 205
 - live-fiber testing 71, 84
 - loop
 - end, icon..... 181
 - fiber length..... 10, 47, 181
 - fiber on a link 13, 50
 - middle, icon..... 181
 - start, icon 181
 - loopback
 - all links combined in one report 150
 - configuration mode 47
 - measurements 13, 138, 181
 - loopback acquisitions..... 137
 - loss
 - results 195
 - thresholds..... 57
 - values 86, 175, 199
 - loss budget
 - dynamic 124
 - fixed 123
 - of a link 86
- M**
- macrobend..... 81, 83, 101, 108, 182
 - main features
 - CWDM 73
 - DWDM..... 63
 - main window
 - iOLM 29
 - status bar..... 30
 - maintenance
 - EUI connectors..... 218
 - front panel..... 217
 - general information 217
 - managing elements
 - adding on a link..... 199, 200
 - adding on fiber sections 202
 - analyzing links 205
 - deleting 204
 - measurement
 - assistant..... 45, 51, 56
 - information..... 207
 - multimode 9
 - of power levels..... 167, 168
 - measurement modes, inline power meter
 - CWDM 165
 - FTTx/PON..... 165
 - mechanical connector cleaning 220
 - merging elements..... 187
 - middle of the loop..... 181
 - models
 - with Click-Out connector 221, 226, 228
 - without Click-Out connector 221, 228
 - modifying
 - acquisition time 91, 94
 - backscatter 101, 107
 - core size..... 101, 107
 - custom elements..... 105
 - IOR..... 101, 107
 - macrobend threshold value ... 83, 101, 108
 - pulse width 91, 94
 - test configurations..... 129
 - modulation..... 172
 - module 98
 - configuration 7
 - DWDM 63
 - multimode 99
 - singlemode 98
 - monitoring fibers in real-time mode..... 144

Index

mounting EUI connector adapter 35
MPO
 cable 208, 209
 connectors 32
 launch cable 32
 switch 199
multifiber
 acquisitions 31, 53, 199, 208
 results 208
multimode
 measurements 9
 module 99
 port 3, 107
 wavelengths 107, 197
multiple-wavelength acquisition 7, 189
mux/demux channels 71, 84

N

name of the configuration 90
naming measurement automatically 36
navigation arrow 178, 181
noise level 195
number
 of connections 104, 120
 of digits displayed 37, 41
 of ports 185
 of splices 104, 120

O

online user guide 235
opening file 211
OPM
 P/F Thresholds tab 90, 128, 164
 tab 166, 168
optical
 cable 32
 Click-Out connector 226, 228
 output diagnosis 221
 switch 31, 53, 199, 208

Optimode
 definition 8, 87
 selection 90, 94, 208
 test configuration 87
ORL 10, 11, 12, 123
OTDR
 Bellcore (.sor) format 148, 212
 graph generation 150
 ports 2, 3, 4, 5, 6, 59
 source 171
 viewing acquisitions 206
out of range
 element 182
 value 42
out of span element 178
output connector of MPO switch 32
overall status 190

P

parameters
 acquisition time 91, 94
 pulse width 91, 94
pass
 icon 180
 status 177, 180, 193, 209
pass/fail
 not tested 180
 status 12, 142, 175, 178, 185, 192, 195
 threshold values 90, 163, 190, 192, 199
PDF format for reports 8, 151
PDF. see online user guide
PONs 109
port selection 43, 48, 54, 60
power levels
 in Link View tab 167
 measurements 167, 168
power meter
 acquisitions 169
 available on unit 128, 161
 results 176, 191
 threshold values 90, 128, 161, 162, 163

predefined certification standards
 applied to fiber 209
 selection 120
 preview of the file name 36, 39
 product
 identification label 235
 specifications 15
 progress of the acquisition 137
 propagation delay 189
 Properties tab 90
 pulse width selection 91, 94

R

Rayleigh backscatter coefficient 107
 real-time mode
 deactivation 146
 performing acquisitions 144
 receive cable length 10
 receive fiber
 length 12, 47
 on a link.... 10, 12, 13, 45, 50, 55, 58, 178,
 181, 186, 195, 199
 recommended SFP 247
 reflectance
 on events 209
 results 195
 values 57, 86, 175, 180, 199
 refraction index of the measurement 107
 regulatory information vii, x
 removing
 favorite channels 67, 77
 test modules 29
 repeating test 258
 replaceable Click-Out connector 221, 226, 228
 replacing connector 228
 report
 automated bidir job 259
 automatically sent to default folder.... 151
 creation 209, 215
 generated automatically 8

generated automatically, PDF 150, 151
 generated manually 150
 Report tab 150
 residual light 71, 84
 resolution performance 57
 results, multifiber 208
 return merchandise authorization (RMA) .. 240
 reverting to factory settings 41

S

safety
 caution 16
 conventions 16
 warning 16
 saving files
 Bellcore format 69
 in Bellcore format 79, 148
 in native format 69, 79
 manually 212
 selected element 178, 180
 selecting
 certification standards 90, 119
 channel 65, 75
 channel filter 74
 channel spacing 64
 distance units 155
 dynamic loss budget 123
 fiber types 90
 modulation 172
 Optimode 94
 port 43, 48, 54, 60
 predefined certification standards 120
 split ratio 111
 test configuration 87, 88
 wavelength 44, 49, 54, 61, 144, 171
 separator used in file name 39
 sequencing tests with TestFlow 15
 sequential acquisitions 69, 79
 service and repairs 240
 service centers 241

Index

- setting
 - acquisition time 91, 94
 - automated acquisition sequence 59, 60
 - custom power meter threshold
 - values 128, 163
 - default storage folder 147
 - fiber values automatically 45, 51, 56
 - launch cable length automatically .. 45, 50, 51, 56
 - launch cable length manually 45, 46, 50, 52
 - loop fiber length manually 50, 52
 - macroband parameters 81
 - power meter threshold values 90
 - pulse width 91, 94
 - receive cable length automatically .. 45, 50, 51, 56
 - receive cable length
 - manually 45, 46, 50, 52
 - test configuration properties 90
 - settings, factory 41
 - SFP, connecting 247
 - shipping to EXFO 240
 - single wavelength acquisitions 7
 - singlemode
 - live port 2, 3, 5, 6, 59, 161, 169
 - live/OPM port 3
 - OTDR port 2, 3, 4, 6, 59
 - wavelengths 107
 - software options 14
 - SOR pulse editor 94
 - sound notifications 153
 - source
 - included in module 171
 - modulation 172
 - specifications, product 15
 - splice 104, 183
 - split measurement 190
 - splitter
 - 1:N 109
 - 2:N 109, 112
 - element 182, 197
 - unbalanced 113, 114, 184, 185
 - splitter ratio
 - 1:? 111, 112
 - on element 109, 111, 181, 182, 183, 184, 185, 198
 - stage 1 112
 - standard
 - configuration mode 43
 - iOLM definition 1
 - measurements 138
 - testing mode 8
 - standard acquisitions 137, 138
 - status
 - bar 30, 137
 - fail 143, 177, 181, 192, 209
 - global pass/fail 192
 - icon 209
 - of the acquisition 143
 - pass 177, 180, 193, 209
 - unknown 143, 177, 180, 193, 199
 - stopping acquisition 143
 - storage requirements 217
 - storing files automatically 156
 - sub-element in grouped elements 185
 - Summary tab 175, 208
 - switch 31, 53, 183, 199, 208
 - symbols, safety 16
- ## T
- tab
 - Elements 159, 175, 195, 196, 197, 200, 202, 204, 205
 - General 147, 151, 153, 154, 155
 - Info 143, 175, 207
 - iOLM 42
 - iOLM P/F Thresholds 90, 100, 120, 122
 - Link Definition 90, 98, 103, 110, 114
 - Link View 137, 142, 159, 175, 196, 205
 - OPM 166, 168
 - OPM P/F Thresholds 164
 - OPM Pass/Fail 90, 128
 - Properties 90

-
- Report..... 150
 - Summary 175, 208
 - technical specifications..... 15
 - technical support 235
 - temperature for storage..... 217
 - test configurations
 - creating 89
 - deleting 134
 - duplicating 89
 - editing 129
 - exporting 132
 - impacts 86
 - importing 130
 - Optimode 87
 - properties 90, 91
 - selecting 87, 88
 - test modules, inserting and removing 29
 - test point 118
 - TestFlow 15
 - testing again 258
 - testing channels sequentially 69, 79
 - testing modes
 - Optimode 8
 - standard 8
 - theory, iOLM 7
 - threshold values
 - macroband 83
 - power meter 128
 - threshold values, macroband 101, 108
 - total insertion loss..... 12
 - transportation requirements 217, 236
 - type of fiber 98, 99
- U**
- unbalanced
 - PON networks..... 114
 - PONs..... 113
 - splitter element 184, 185
 - unbalanced splitters
 - grouping..... 187
 - ungrouping 188
 - ungrouping elements 188
 - unidirectional loopback result 190
 - unit, damaged connector..... 228
 - unknown status..... 143, 177, 180, 193, 199
 - unmerging elements 188
 - UPC connectors 208
 - USB
 - cable 31, 32
 - device 130, 132, 147
 - user guide. see online user guide
- V**
- value
 - cumulative loss 58, 185, 195
 - first connector 124
 - last connector 124
 - out of range..... 42
 - verifying optical output 221
 - viewing
 - acquisitions in OTDR application..... 206
 - automated bidir results..... 258
 - changes on fiber link..... 144
 - diagnostics..... 159
 - measurement information 207
 - multifiber results..... 208
 - results in Elements tab..... 195
 - results in Link View tab 175
 - visible region 178
- W**
- warranty
 - certification..... 239
 - exclusions 239
 - general..... 237
 - liability 239
 - null and void..... 237
 - wavelength
 - multimode 107
 - selection..... 44, 49, 54, 61, 144, 171
 - singlemode 107
 - value appended to file name 148

Index

wizard, recommended SFP	247
working	
on PONs.....	109
on unbalanced PON networks	114
on unbalanced PONs	113
with the switch.....	53

CHINESE REGULATION ON RESTRICTION OF HAZARDOUS SUBSTANCES (RoHS)

中国关于有害物质限制的规定

NAMES AND CONTENTS OF THE TOXIC OR HAZARDOUS SUBSTANCES OR ELEMENTS
CONTAINED IN THIS EXFO PRODUCT

包含在本 EXFO 产品中的有毒有害物质或元素的名称及含量

Part Name 部件名称	Lead 铅 (Pb)	Mercury 汞 (Hg)	Cadmium 镉 (Cd)	Hexavalent Chromium 六价铬 (Cr(VI))	Polybrominated biphenyls 多溴联苯 (PBB)	Polybrominated diphenyl ethers 多溴二苯醚 (PBDE)
Enclosure 外壳	O	O	O	O	O	O
Electronic and electrical sub-assembly 电子和电气组件	X	O	X	O	X	X
Optical sub-assembly ^a 光学组件 ^a	X	O	O	O	O	O
Mechanical sub-assembly ^a 机械组件 ^a	O	O	O	O	O	O

Note:

注:

This table is prepared in accordance with the provisions of SJ/T 11364.

本表依据 SJ/T 11364 的规定编制。

O: Indicates that said hazardous substance contained in all of the homogeneous materials for this part is below the limit requirement of GB/T 26572.

O: 表示该有害物质在该部件所有均质材料中的含量均在 GB/T 26572 标准规定的限量要求以下。

X: indicates that said hazardous substance contained in at least one of the homogeneous materials used for this part is above the limit requirement of GB/T 26572. Due to the limitations in current technologies, parts with the "X" mark cannot eliminate hazardous substances.



X: 表示该有害物质至少在该部件的某一均质材料中的含量超出 GB/T 26572 标准规定的限量要求。

标记 "X" 的部件, 皆因全球技术发展水平限制而无法实现有害物质的替代。

a. If applicable.

如果适用。

MARKING REQUIREMENTS
标注要求

Product 产品	Environmental protection use period (years) 环境保护使用期限 (年)	Logo 标志
This EXFO product 本 EXFO 产品	10	
Battery ^a 电池	5	

a. If applicable.
如果适用。

P/N: 32.0.1.1

www.EXFO.com · info@EXFO.com

CORPORATE HEADQUARTERS 400 Godin Avenue

Quebec (Quebec) G1M 2K2 CANADA
Tel.: 1 418 683-0211 · Fax: 1 418 683-2170

TOLL-FREE (USA and Canada)

1 800 663-3936

© 2023 EXFO Inc. All rights reserved.
Printed in Canada (2023-03)

The logo for EXFO, featuring the word "EXFO" in a bold, blue, sans-serif font. The letters are composed of horizontal lines, giving it a modern, digital appearance.