

SONET/SDH Application

IQS-8100 Series for IQS-600



Copyright © 2007–2014 EXFO Inc. All rights reserved. No part of this publication may be reproduced, stored in a retrieval system or transmitted in any form, be it electronically, mechanically, or by any other means such as photocopying, recording or otherwise, without the prior written permission of EXFO Inc. (EXFO).

Information provided by EXFO is believed to be accurate and reliable. However, no responsibility is assumed by EXFO for its use nor for any infringements of patents or other rights of third parties that may result from its use. No license is granted by implication or otherwise under any patent rights of EXFO.

EXFO's Commerce And Government Entities (CAGE) code under the North Atlantic Treaty Organization (NATO) is 0L8C3.

The information contained in this publication is subject to change without notice.

Trademarks

EXFO's trademarks have been identified as such. However, the presence or absence of such identification does not affect the legal status of any trademark.

Units of Measurement

Units of measurement in this publication conform to SI standards and practices.

December 1, 2014

Version number: 7.0.0

Contents

Certification Information	x
1 Introducing the IQS-8100 Series Transport Blazer	1
Module-Related Information	4
Conventions	5
2 Safety Information	7
Laser Safety Warnings	7
Installation Instruction Warnings	8
3 Getting Started	11
IQS Manager Installation	11
Inserting and Removing Test Modules	11
Turning the Unit On	11
4 Physical Interfaces and LEDs	13
Modules	13
Port Availability on IQS-8100 Series Module	18
OTN/OC-N/STM-N Interface Connections	20
Electrical SONET/DSn/SDH/PDH Interface Connection	22
Clock Interface Connections	23
Ethernet 10/100/1000Base-T Interface Connection	24
Ethernet ADD/DROP Gig-E Interface Connection	25
DCC/GCC/UC Interface Connection	26
Status LED	26
5 Introducing and Using the Graphical User Interface	27
Starting the IQS-8100 Series Transport Blazer Application	27
Main Window	29
Global Test Status and Controls	35
Favorites	40
Test Report Generation	42
Usual Tab Elements	46
Tab Configuration	49
Keyboard Usage	53
6 Creating and Starting a Test Case	59
Supported Paths/Mappings	59
Introducing the Test Setup	62
Typical Test Cases	65

7 Smart Mode	111
SmartMode Interface Description	112
Using SmartMode for Alarm/Error Monitoring	115
Creating and Starting a Test Case Using SmartMode	122
Legend	123
8 Summary Tabs	125
Test Summary	125
Alarm Summary	132
Test Logger	135
9 Port Tabs	137
Port TX (Electrical Interfaces)	138
Port RX (Electrical Interfaces)	142
Port TX (Optical Interfaces)	147
Port RX (Optical Interfaces)	150
10 OTN Tabs	153
FEC TX	154
FEC RX	156
OTU TX	157
OTU OH TX	160
OTU TTI TX	162
OTU RX	163
OTU OH RX	166
OTU TTI RX	168
ODU TCM TX	170
ODU TCM TTI TX	173
ODU TCM RX	175
ODU TCM TTI RX	178
ODU TX	180
ODU OH TX	182
ODU TTI/FTFL TX	186
ODU RX	189
ODU OH RX	191
ODU TTI/FTFL RX	194
OPU TX	197
OPU OH TX	200
OPU RX	203
OPU OH RX	205
GMP TX	208
GMP RX	209

11 SONET Tabs	211
Section TX (SONET)	213
Section RX (SONET)	219
Section OH TX/RX (SONET)	221
Line TX (SONET)	223
Line RX (SONET)	228
Line OH TX/RX (SONET)	234
APS/Advanced Line OH TX/RX (SONET)	236
HOP TX (SONET)	245
HOP RX (SONET)	251
HOP OH TX/RX (SONET)	254
Path Signal Label (C2)	256
LOP TX (SONET)	257
LOP RX (SONET)	263
LOP OH TX/RX (SONET)	266
12 DSn Tabs	269
DS0/64K TX	270
DS0/64K RX	273
DS1/1.5M TX	275
DS1/1.5M RX	278
FDL TX	280
FDL RX	285
FDL PRM TX	288
FDL PRM RX	290
FDL PRM Content RX	291
DS3/45M TX	293
DS3/45M RX	295
DS3 FEAC TX	297
DS3 FEAC RX	301

13 SDH Tabs	303
Regenerator Section TX (SDH)	305
Regenerator Section RX (SDH)	311
Regenerator Section OH TX/RX (SDH)	313
Multiplex Section TX (SDH)	315
Multiplex Section RX (SDH)	320
Multiplex Section OH TX/RX (SDH)	326
Multiplex Section APS/Advanced OH TX/RX (SDH)	328
HOP TX (SDH)	335
HOP RX (SDH)	341
HOP OH TX/RX (SDH)	344
LOP TX (SDH)	347
LOP RX (SDH)	353
LOP OH TX/RX (SDH)	356
LOP TX (SDH, TU-3 path)	358
LOP RX (SDH, TU-3 path)	364
LOP OH TX/RX (SDH, TU-3 path)	367
14 PDH Tabs	369
E0/64K TX	370
E0/64K RX	373
E1/2M TX	375
E1/2M RX	378
E2/8M TX	381
E2/8M RX	383
E3/34M TX	385
E3/34M RX	387
E4/140M TX	389
E4/140M RX	391
15 Ethernet Tabs	393
Configuration	393
Error/Alarm TX	396
Error/Alarm RX	399
Statistics TX	401
Statistics RX	402
16 BERT Tabs	405
Pattern TX	405
Pattern RX	409

17 Advanced Tabs	411
Service Disruption Time (SDT)	411
Service Disruption Time (SDT) - Monitor	415
Service Disruption Time (SDT) - Results	421
Round Trip Delay (RTD)	425
18 Next-Generation Tabs	429
GFP Overview TX	431
GFP Frame TX	432
GFP Channel TX	435
GFP Channel Stats TX	439
GFP OH TX	440
GFP Client TX	444
GFP Overview RX	447
GFP Frames RX	449
GFP Channel RX	451
GFP Channel Stats RX	454
GFP OH RX	455
GFP Client RX	457
VCAT TX - Overview	459
VCAT TX - Diff Delay	461
VCAT RX - Overview	463
VCAT RX - Diff Delay	466
LCAS - Source	468
LCAS Sink	481
19 Common Tabs	491
HOP/LOP Pointer Adjust TX (SONET/SDH)	492
HOP/LOP Pointer Adjust RX (SONET/SDH)	495
TCM TX	497
TCM RX	500
Performance Monitoring (PM)	504
Client Offset TX	513
Client Offset RX	515
20 System Tab	519
Clock Synchronization	520
Application Preferences	528
Default Test Preferences	530
Module Information	544
Software Options	546
Remote Control	549

21 Tools Tab	551
Script Tab	551
22 Maintenance	555
Recalibrating the Unit	556
Recycling and Disposal (Applies to European Union Only)	558
23 Troubleshooting	559
Solving Common Problems	559
Contacting the Technical Support Group	560
Transportation	560
24 Warranty	561
General Information	561
Liability	561
Exclusions	562
Certification	562
Service and Repairs	563
EXFO Service Centers Worldwide	564
A Specifications	565
Electrical Interfaces for IQS-8105/15/20/30	565
Optical Interfaces	566
Synchronization Interfaces for IQS-8105/15/20/30	568
Synchronisation Interfaces for IQS-8140	569
Ethernet Add/Drop Interfaces for IQS-8105/15/20/30	569
Ethernet Interfaces	570
General Specifications	571

B Glossary	573
SONET/DSn/SDH/PDH Nomenclature	573
Signal Rates	573
SONET/SDH High and LowOrder Path Nomenclature	574
SONET/SDH Alarms and Errors Nomenclature	575
Acronym List	577
G.709 Optical Transport Network (OTN)	597
SONET Numbering Convention	612
SDH Numbering Convention	614
SONET - Section Overhead (SOH)	618
SONET - Line Overhead (LOH)	620
SONET - Path Overhead (POH)	623
SONET - VT Path Overhead	626
SDH - Regenerator Section Overhead (RSOH)	630
SDH - Multiplex Section Overhead (MSOH)	632
SDH - Higher-Order Path Overhead (HP-POH)	634
SDH - Lower-Order Path Overhead	637
10G Ethernet	640
Next-Gen - Generic Framing Procedure (GFP)	643
Next-Gen - Virtual Concatenation (VCAT)	656
Next-Gen - Link-Capacity Adjustment Scheme (LCAS)	669
Index	681

Certification Information

Federal Communications Commission (FCC) and Industry Canada (IC) Information

Electronic test and measurement equipment is exempt from FCC Part 15 compliance in the United States and from IC ICES 003 compliance in Canada. However, EXFO Inc. (EXFO) makes reasonable efforts to ensure compliance to the applicable standards.

The limits set by these standards are designed to provide reasonable protection against harmful interference when the equipment is operated in a commercial environment. This equipment generates, uses, and can radiate radio frequency energy and, if not installed and used in accordance with the user guide, may cause harmful interference to radio communications. Operation of this equipment in a residential area is likely to cause harmful interference in which case the user will be required to correct the interference at his own expense.

European Union (CE) Information

Electronic test and measurement equipment is subject to the EMC Directive in the European Union. The EN61326 standard prescribes both emission and immunity requirements for laboratory, measurement, and control equipment. This unit has been tested and found to comply with the limits for a Class A digital device. Please refer to the *CE Declaration of Conformity* on page xii.

For continued compliance to the requirements of the EMC Directive:

- 1.** For the **BNC/AUX** port(s) use double-shielded coaxial cable, type 734A or equivalent.
- 2.** For the **REF OUT** port use double shielded cable, type LMR-240 ULTRAFLEX or equivalent, with a maximum length of 3m for IQS-8105/15/20/30 and 1m for IQS-8140.
- 3.** For the **DCC/GCC/UC** port use shielded cable, type Molex 83421 or equivalent, with a maximum length of 3m.

Note: *If the equipment described herein bears the CE symbol, the said equipment complies with the applicable European Union Directive and Standards mentioned in the Declaration of Conformity.*

Laser

For all models at the exception of the IQS-8140:

This product complies with 21 CFR 1040.10 and with EN 60825-1.

This product may employ a Class 1 or Class 1M laser SFP or XFP. The laser classification is reproduced on the SFP/XFP.

For the IQS-8140:

Class 1 laser product.

This product complies with IEC/EN 60825-1 and 21 CFR 1040.10 except for deviations pursuant to Laser Notice No. 50, dated July 26, 2001.

CE Declaration of Conformity

EXFO DECLARATION OF CONFORMITY

Application of Council Directive(s):	2006/95/EC - The Low Voltage Directive 2004/108/EC - The EMC Directive 2006/66/EC - The Battery Directive 93/68/EEC - CE Marking And their amendments
Manufacturer's Name:	EXFO Inc.
Manufacturer's Address:	400 Godin Avenue Quebec, Quebec Canada, G1M 2K2
Equipment Type/Environment:	Test & Measurement / Industrial
Trade Name/Model No.:	Transport Blazer Series / FTB-8105/8115/8120/8120NG/8130/8130NG/8140 AND IQS-8105/8115/8120/8120NG/8130/8130NG/8140

Standard(s) to which Conformity is Declared:

EN 61010-1:2001 Edition 2.0	Safety Requirements for Electrical Equipment for Measurement, Control, and Laboratory Use – Part 1: General Requirements.
EN 61326-1:2006	Electrical Equipment for Measurement, Control and Laboratory Use - EMC Requirements
EN 60825-1:2007 Edition 2.0	Safety of laser products – Part 1: Equipment classification and requirements
EN 55022: 2006 + A1: 2007	Information technology equipment — Radio disturbance characteristics — Limits and methods of measurement

I, the undersigned, hereby declare that the equipment specified above conforms to the above Directives and Standards.

Manufacturer

Signature:



Full Name: Stephen Bull, E. Eng
Position: Vice-President, Research and Development
Address: 400 Godin Avenue, Quebec (Quebec),
Canada, G1M 2K2
Date: February 1, 2009

EXFO **CE** **DECLARATION OF CONFORMITY**

Application of Council Directive(s):	2006/95/EC - The Low Voltage Directive 2004/108/EC - The EMC Directive 2006/66/EC - The Battery Directive 93/68/EEC - CE Marking And their amendments
Manufacturer's Name:	EXFO Inc.
Manufacturer's Address:	400 Godin Avenue Quebec, Quebec Canada, G1M 2K2
Equipment Type/Environment:	Test & Measurement / Industrial
Trade Name/Model No.:	Next-Generation Multiservice Test Modules / FTB-8120NGE/8130NGE AND IQS-8120NGE/8130NGE Power Blazer

Standard(s) to which Conformity is Declared:

EN 61010-1:2001 Edition 2.0	Safety Requirements for Electrical Equipment for Measurement, Control, and Laboratory Use – Part 1: General Requirements.
EN 61326-1:2006	Electrical Equipment for Measurement, Control and Laboratory Use - EMC Requirements
EN 60825-1:2007 Edition 2.0	Safety of laser products – Part 1: Equipment classification and requirements
EN 55022: 2006 + A1: 2007	Information technology equipment — Radio disturbance characteristics — Limits and methods of measurement

I, the undersigned, hereby declare that the equipment specified above conforms to the above Directives and Standards.

Manufacturer

Signature:



Full Name: Stephen Bull, E-Eng
Position: Vice-President Research and Development
Address: 400 Godin Avenue, Quebec (Quebec),
Canada, G1M 2K2
Date: February 1, 2009

1 **Introducing the IQS-8100 Series Transport Blazer**

Fully integrated test solution supporting next-generation SONET/SDH, optical transport network (OTN), Ethernet, and Fibre Channel test functions.

This user guide covers the IQS-8100 Series of modules including the IQS-8105, IQS-8115, IQS-8120, IQS-8120NG, IQS-8120NGE, IQS-8130, IQS-8130NG, IQS-8130NGE, and IQS-8140.

This user guide only covers the “SONET/SDH Application” which covers DSn/PDH, next-generation SONET/SDH, and OTN test functions. Refer to the “Ethernet and Fibre Channel Application” user guide for more information on Ethernet and Fibre Channel test functions.

SONET/SDH and OTN Service Turn-up and Troubleshooting

The IQS-8100 Series Transport Blazer modules offer a wide range of SONET/SDH and OTN test functions, allowing users to perform tests ranging from simple bit error rate (BER) testing to advanced characterization and troubleshooting procedures.

Next-Generation SONET/SDH Testing

The IQS-8120NG, and IQS-8130NG, IQS-8120NGE, and IQS-8130NGE modules support Next-Generation SONET/SDH capabilities in addition to providing SONET/SDH test functions.

Available Next-Generation SONET/SDH test functionality include generic framing procedure (GFP), virtual concatenation (VCAT) and link capacity adjustment scheme (LCAS).

SmartMode: Real-Time Signal Structure Discovery and Monitoring

The Transport Blazer supports a unique feature called SmartMode, which automatically discovers the signal structure of the OC-n/STM-n line including mixed mappings and virtual concatenation (VCAT) members. In addition to this in-depth multichannel visibility, SmartMode performs real-time monitoring of all discovered high-order paths and user selected low-order paths simultaneously, providing users with the industry's most powerful SONET/SDH multichannel monitoring and troubleshooting solution. SmartMode is not supported on the IQS-8140.

Key Features

- DS0/E0 to OC-192/STM-64/OTU-2; 10 Mbit/s to 10 Gbit/s LAN/WAN as well as 1x, 2x, 4x, and 10x Fibre Channel testing (Ethernet and Fibre Channel testing is only available with the IQS-8120NGE, and IQS-8130NGE modules)
- OC-768/STM-256 testing with STS-1/AU-3 granularity available on the IQS-8140
- Supports SONET, SDH, DSn, PDH and Next-Generation SONET/SDH and OTN testing
- OTN forward error correction (FEC) and optical channel data unit (ODU) multiplex testing capabilities as per ITU-T G.709
- Offers ODU0 (1.25 Gbit/s) container with Gigabit Ethernet and SONET/SDH client signals for qualifying transport and datacom services over OTN
- Supports circuit (CBR) and packet (Ethernet) ODUflex testing capabilities for optical transport network (OTN) bandwidth optimization
- Unframed optical signal testing at 10.7 Gbps, 11.0491 Gbps, 11.0957 Gbps, 11.270 Gbps, and 11.317 Gbps rates
- Overclocked OTU2 rates: OTU1e (11.049 Gbps), OTU2e (11.096 Gbps), OTU1f (11.270 Gbps), and OTU2f (11.317 Gbps)
- EoOTN testing using internally generated 10 GigE LAN and mapping onto OTU1e and OTU2e rates (IQS-8130NG and IQS-8130NGE)
- Ethernet-over-SONET/SDH (EoS) testing for GFP, VCAT and LCAS
- Comprehensive Fibre Channel test capabilities, including framed and unframed BERT, buffer-to-buffer credit estimation, and round-trip latency measurements
- Fully integrated solution for assessing the performance of Ethernet transport networks, including RFC 2544 and BER test functionalities

Introducing the IQS-8100 Series Transport Blazer

Module-Related Information

- SmartMode signal structure discovery for rates of up to 10 Gbps, with simultaneous monitoring of all discovered STS/AU and user selected VT/TUs channels. Not supported on the IQS-8140.
- Intuitive, feature-rich graphical user interface (GUI) with available automated test scripting and available multi-user remote management capabilities

Module-Related Information

This user guide describes the functionality of the Transport Blazer on the IQS-600.

- **IQS-8100 Series** indicates that the statement applies to all modules: IQS-8105, IQS-8115, IQS-8120, IQS-8120NG, IQS-8120NGE, IQS-8130, IQS-8130NG, IQS-8130NGE, and IQS-8140.
- **IQS-8105/15/20/30** indicate that the statement applies to the following modules: IQS-8105, IQS-8115, IQS-8120, IQS-8120NG, IQS-8120NGE, IQS-8130, IQS-8130NG, and IQS-8130NGE.
- **IQS-8115/20/30** indicate that the statement applies to the following modules: IQS-8115, IQS-8120, IQS-8120NG, IQS-8120NGE, IQS-8130, IQS-8130NG, and IQS-8130NGE.
- **IQS-8105, IQS-8115, IQS-8120, IQS-8120NG, IQS-8120NGE, IQS-8130, IQS-8130NG, IQS-8130NGE, and IQS-8140** indicate that the statement applies to the specified module(s) only.

Conventions

Before using the product described in this guide, you should understand the following conventions:



WARNING

Indicates a potentially hazardous situation which, if not avoided, could result in *death or serious injury*. Do not proceed unless you understand and meet the required conditions.



CAUTION

Indicates a potentially hazardous situation which, if not avoided, may result in *minor or moderate injury*. Do not proceed unless you understand and meet the required conditions.



CAUTION

Indicates a potentially hazardous situation which, if not avoided, may result in *component damage*. Do not proceed unless you understand and meet the required conditions.



IMPORTANT

Refers to information about this product you should not overlook.

2 **Safety Information**

Laser Safety Warnings



WARNING

When the LASER LED is on or flashing, the IQS-8100 Series is transmitting an optical signal.



WARNING

Do not install or terminate fibres while a laser source is active. Never look directly into a live fibre, and ensure that your eyes are protected at all times.



WARNING

This product may employ a Class 1M SFP or XFP. Check pluggable transceiver label for laser classification. Applies to IQS-8115, IQS-8120, IQS-8120NG, IQS-8120NGE, IQS-8130, IQS-8130NG, and IQS-8130NGE modules only.



WARNING

Use of optical instruments with this product will increase eye hazard.

Safety Information

Installation Instruction Warnings

Installation Instruction Warnings



CAUTION

This unit is designed for indoor use only.



CAUTION

For IQS-8105/15/20/30: Except for the Dual Bantam connector and the RJ-48C port, all telecom (electrical) interfaces are SELV (Safety Extra Low Voltage) circuitry intended for intra-building use only.

To reduce the risk of fire, use only No. 26 AWG or larger telecommunication line cord.

For IQS-8140: The AUX (BNC) interface employs SELV (Safety Extra Low Voltage) circuitry intended for intra-building use only.



CAUTION

No user serviceable parts are contained inside. Contact the manufacturer regarding service of this equipment.



CAUTION

Keep all ventilation openings clear and unobstructed.



IMPORTANT

All wiring and installation must be in accordance with local building and electrical codes acceptable to the authorities in the countries where the equipment is installed and used.



CAUTION

Electrostatic Discharge (ESD) Sensitive Equipment:

Plug-in modules can be damaged by static electrical discharge. To minimize the risk of damage, dissipate static electricity by touching a grounded unpainted metal object

- before removing, inserting, or handling the module.
- before connecting or disconnecting cables to/from the module.
- before inserting or removing SFP/XFPs to/from the module.

3 Getting Started

If the IQS-8100 Series Transport Blazer has been purchased at the same time as the IQS-600, the IQS-8100 Series module is pre-installed with the appropriate IQS Manager software version.

IQS Manager Installation

The IQS Manager is the baseline software and thus needs to be installed on the IQS-600 before using the IQS-8100 Series module.

Note: Refer to the IQS-600 platform user guide for more information on IQS Manager installation procedure.

Inserting and Removing Test Modules



CAUTION

Never insert or remove a module while the controller unit and its expansion units are turned on. This will result in immediate and irreparable damage to both the module and unit.

Note: Refer to the IQS-600 platform user guide for more information on how to insert a module into the IQS-600 or to remove a module from the IQS-600. For IQS-8140, use respectively the retaining screw number 2, 3, or 4 (from bottom to top) depending if the module is inserted in slots 0 to 5, 1 to 6, or 2 to 7.

Turning the Unit On

Turn on the IQS-600. Refer to the IQS-600 platform user guide for more information.

4 *Physical Interfaces and LEDs*

This section describes the connectors (ports) and LEDs available on each module.

Modules

IQS-8105 Module

SONET/SDH analyzer up to 155 Mbps.

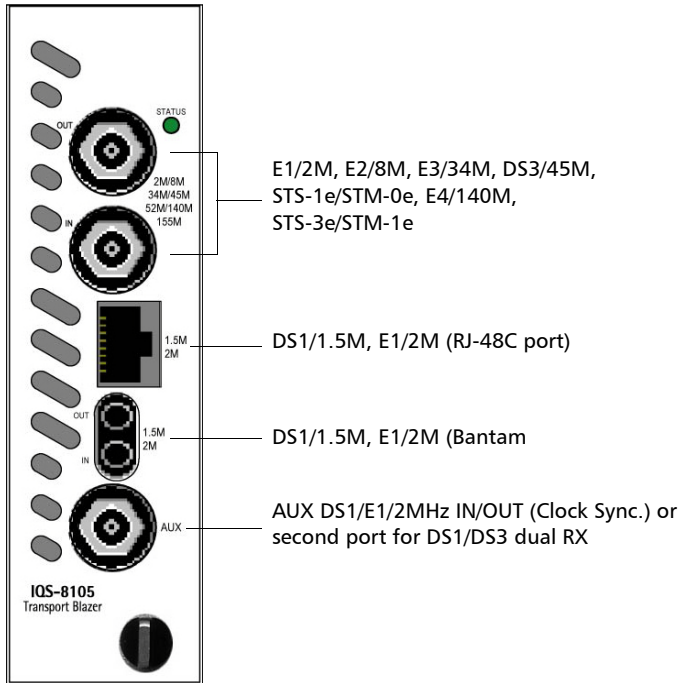

Physical Interfaces and LEDs

Modules

IQS-8115 Module

SONET/SDH analyzer up to 2.5 Gbps.

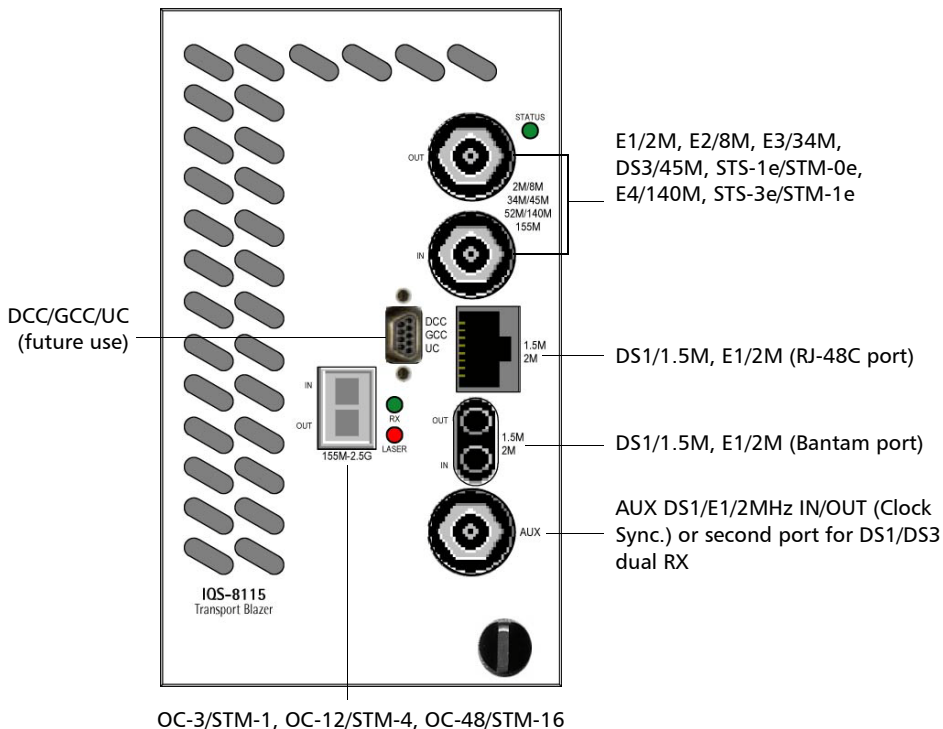

IQS-8120/IQS-8120NG/IQS-8120NGE Module

SONET/SDH/OTN analyzer up to 2.7 Gbps. The **IQS-8120NGE** also offers 1 Gbps Ethernet and up to 4x Fibre Channel testing; refer to the “Ethernet and Fibre Channel Application” user guide for more information.

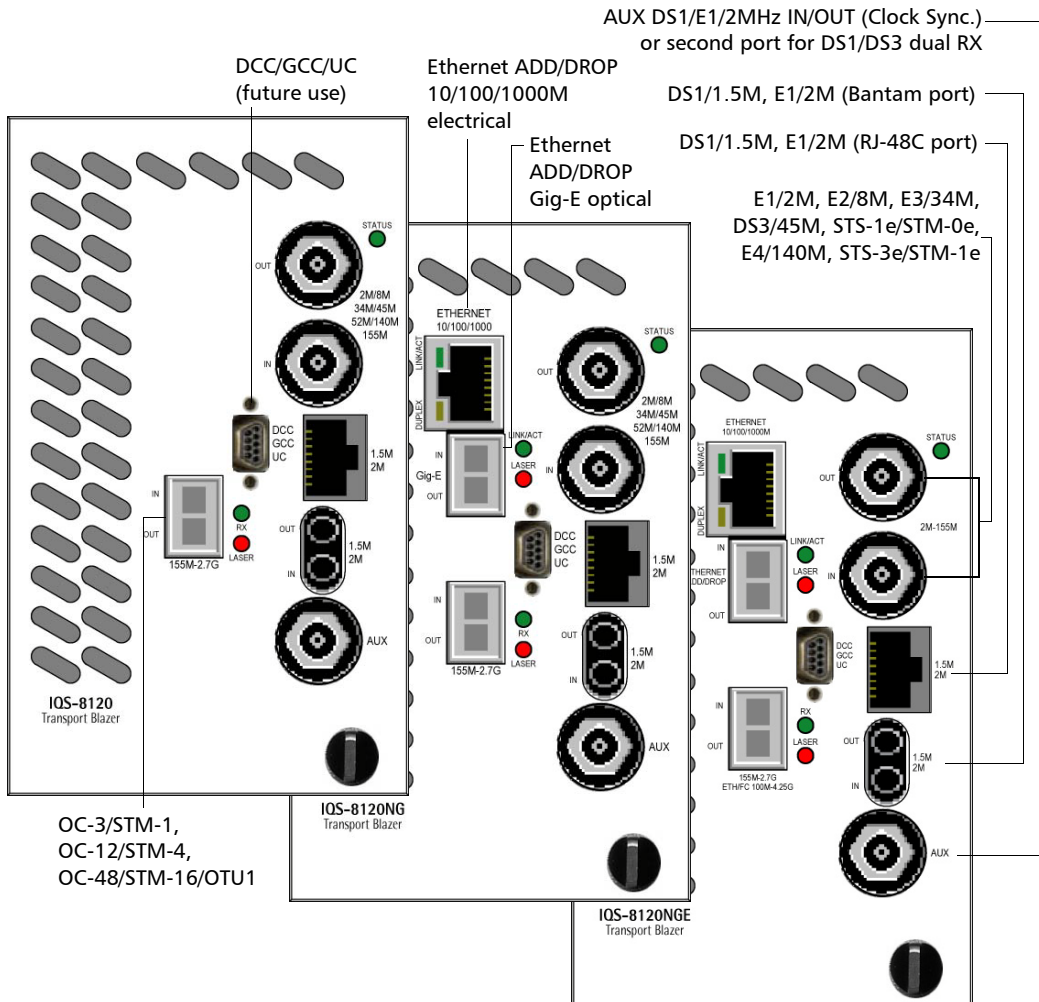

Physical Interfaces and LEDs

Modules

IQS-8130/IQS-8130NG/IQS-8130NGE Module

SONET/SDH/OTN analyzer up to 11.1 Gbps. The **IQS-8130NGE** also offers 10 Gbps Ethernet and up to 10x Fibre Channel; refer to the “Ethernet and Fibre Channel Application” user guide for more information.

REF OUT (Clock reference for eye diagram) available with OC-192/STM-64/OTU2/OTU1e/OTU2e/OTU1f/OTU2f configuration

AUX DS1/E1/2MHz IN/OUT (Clock Sync.) or second port for DS1/DS3 dual RX

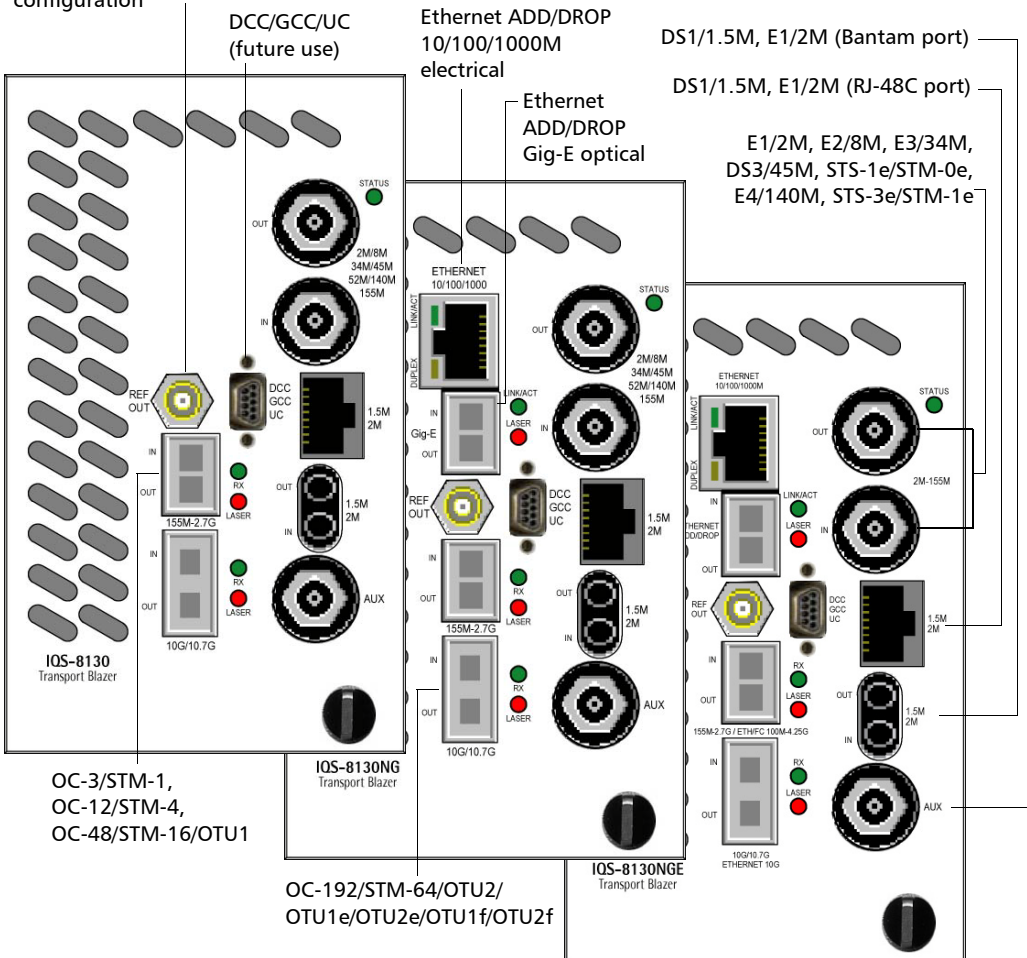

IQS-8140

SONET/SDH/OTN 40/43 Gbps analyzer.

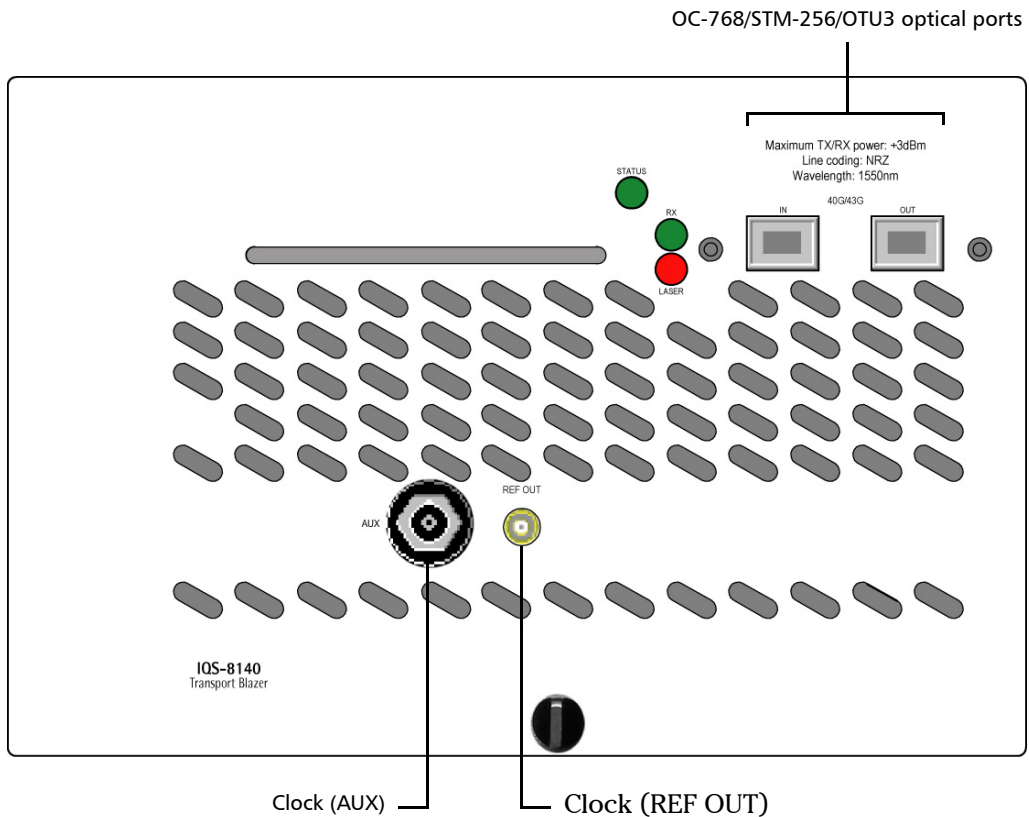

Two models are available:

- IQS-8140-NRZ: SONET/SDH/OTN test module with 40/43 Gbit/s, 1550 nm, NRZ 2 km transponder.
- IQS-8140-DPSK: SONET/SDH/OTN test module with 40/43 Gbit/s, tunable DPSK transponder.

Physical Interfaces and LEDs

Port Availability on IQS-8100 Series Module

Port Availability on IQS-8100 Series Module

The following table shows the list of available ports as well as a description and signals supported for each module. For Ethernet and Fibre Channel ports, refer to the “Ethernet and Fibre Channel Application” user guide.

Port labelled	Description	Supported signal(s)	Module
155M-2.5G	Optical IN/OUT port small form factor pluggable (SFP)	OC-3/STM-1, OC-12/STM-4, OC-48/STM-16	IQS-8115
155M-2.7G	Optical IN/OUT port small form factor pluggable (SFP)	OC-3/STM-1, OC-12/STM-4, OC-48/STM-16, OTU1	IQS-8120 IQS-8120NG IQS-8130 IQS-8130NG
100M-4.25G	Optical IN/OUT port small form factor pluggable (SFP)	OC-3/STM-1, OC-12/STM-4, OC-48/STM-16, OTU1, Ethernet 100Mbps, Ethernet 1000Mbps, FC 1x, FC 2x, FC 4x	IQS-8120NGE IQS-8130NGE
10G/10.7G	Optical IN/OUT port 10G small form factor pluggable (XFP)	OC-192/STM-64, OTU2, OTU2e, OTU1e, OTU1f, OTU2f, Ethernet 10Gig (IQS-8130NGE), FC 10x (IQS-8130NGE)	IQS-8130 IQS-8130NG IQS-8130NGE
40G/43G	Optical IN/OUT	OC-768/STM-256, OTU3	IQS-8140
2M/8M/34M/ 45M/52M/ 140M/155M, or 2M-155M	Electrical IN/OUT port BNC	E1/2M, E2/8M, E3/34M, DS3/45M, STS-1e/STM-0e/52M, E4/140M, STS-3e/STM-1e/155M	IQS-8105/15/2 0/30
1.5M/2M	Electrical IN/OUT port Bantam	DS1/1.5M, E1/2M	IQS-8100 Series
1.5M/2M	Electrical port RJ-48C	DS1/1.5M, E1/2M	IQS-8100 Series
AUX	Electrical port BNC	DS1/1.5M/E1/2M/2 MHz signal for external clock synchronization, or DS1/DS3 signal for Dual RX test.	IQS-8100 Series

Physical Interfaces and LEDs

Port Availability on IQS-8100 Series Module

Port labelled	Description	Supported signal(s)	Module
REF OUT	Reference output port SMA	See <i>Clock Interface Connections</i> on page 23 for more information.	IQS-8130 IQS-8130NG IQS-8130NGE IQS-8140
Ethernet 10/100/1000M	Electrical Ethernet port RJ-45	10/100/1000 Mbps (electrical)	IQS-8120NG IQS-8130NG IQS-8120NGE IQS-8130NGE
Gig-E / ETHERNET ADD/DROP	Optical IN/OUT Ethernet port small form pluggable (SFP)	1000 Mbps (optical)	IQS-8120NG IQS-8130NG IQS-8120NGE IQS-8130NGE
DCC GCC UC	Electrical IN/OUT micro DB-9 female DCE for DCC, GCC and UC signals.	Future use	IQS-8115 IQS-8120 IQS-8120NG IQS-8130 IQS-8130NG IQS-8120NGE IQS-8130NGE

Physical Interfaces and LEDs

OTN/OC-N/STM-N Interface Connections

OTN/OC-N/STM-N Interface Connections

For IQS-8115/IQS-8120/IQS-8120NG/IQS-8120NGE/IQS-8130/IQS-8130NG/IQS-8130NGE, plug the supplied SFP/XFP module into the respective slot on the module. Only use EXFO qualified SFP/XFPs. Using non-qualified SFP/XFPs can affect the Performance and accuracy of the optical port.

Description	Wavelength	Reach	Part Number
Multirate (155/622 Mbps, 2.5/2.7 Gbps/FC 1x/2x) optical SFP transceiver module with LC connector	1310 nm	short (15 Km)	FTB-8190
	1310 nm	intermediate (40 Km)	FTB-8191
	1550 nm	intermediate (40 Km)	FTB-8193
	1550 nm	long (80 Km)	FTB-8192
Multirate (10/10.7 Gbps) optical XFP transceiver module with LC connector	1310 nm	Short (10 Km)	FTB-81900
	1550 nm	Intermediate (40 Km)	FTB-81901
	1550 nm	Long (80 Km)	FTB-81902
Multirate (10/11.3 Gbps) optical XFP transceiver module with LC connector	1310 nm	Short (10 Km)	FTB-81903

Note: Do not replace a SFP/XFP while the test is running to avoid distorting statistics. First stop the test case, replace the SFP/XFP and then restart the test.

Carefully connect optical fibre cables to the SFP/XFP's (IQS-8115, IQS-8120, IQS-8120NG, IQS-8120NGE, IQS-8130, IQS-8130NG, and IQS-8130NGE) or transponder (IQS-8140) IN and OUT ports. To ensure good signal quality, make sure that the optical fibre connector is fully inserted into the optical connector port.



CAUTION

To prevent exceeding the maximum input power level please use an attenuator when a loopback configuration is used.

- **LASER** red LED: The LASER LED is on when the IQS-8100 Series is emitting an optical laser signal.
- **RX** green LED: The **RX** LED is on when the IQS-8100 Series is receiving an optical laser signal.

Electrical SONET/DSn/SDH/PDH Interface Connection

- **2M/8M/34M/45M/52M/140M/155M** port: The IQS-8105/15/20/30 provides two BNC connectors, labeled **2M-155M or 2M/8M/34M/45M/52M/140M/155M IN** and **OUT**, for E1/2M, E2/8M, E3/34M, DS3/45M, STS-1e/STM-0e/52M, E4/140M, STS-3e/STM-1e/155M testing capability. Connector type is BNC for coaxial 75-ohm cable connection.
- **1.5M/2M** Bantam port: The IQS-8105/15/20/30 provides an IN/OUT Bantam connectors for DS1/1.5M and E1/2M testing capability.
- **1.5M/2M** RJ-48C port: The IQS-8105/15/20/30 provides an IN/OUT RJ-48C connectors for DS1/1.5M and E1/2M testing capability.

Note: *Dual RX test case uses the BNC labelled AUX as the second RX port.*

Connect the signal to be tested to the corresponding port.

Clock Interface Connections

- **AUX port:** The IQS-8100 Series provides one connector, labeled **AUX**, that can be used either for DS1 (1.5M)/E1 (2M)/2 MHz external clock synchronization signal or as the second RX port for **Dual RX** (DS1 or DS3) testing (IQS-8105/15/20/30). This port is unidirectional and can be used either for input or output. Connector type is BNC for coaxial 75-ohm cable connection. An adapter cable (BNC to Bantam) is required for Bantam connection (not supplied).
- **REF OUT port:** The IQS-8130/IQS-8130NG/IQS-8130NGE/IQS-8140 provides one connector, labeled **REF OUT**, that can be used for the following clock signals. Connector type is SMA.

For OC-192/STM-64/OTU2/OTU1e/OTU2e/OTU1f/OTU2f

Clock divider	Output frequency for					
	OC-192/STM-64	OTU2	OTU1e	OTU2e	OTU1f	OTU2f
16	622.08 MHz	669.33 MHz	690.57 MHz	693.48 MHz	704.38 MHz	707.35 MHz
32	311.04 MHz	334.66 MHz	345.29 MHz	346.74 MHz	352.19 MHz	353.68 MHz
64	155.52 MHz	167.33 MHz	172.64 MHz	173.37 MHz	176.10 MHz	176.84 MHz

For OC-768/STM-256/OTU3

Output frequency for OC-768/STM-256	Output frequency for OTU3
2488.3 MHz	2688.7 MHz

Physical Interfaces and LEDs

Ethernet 10/100/1000Base-T Interface Connection

Ethernet 10/100/1000Base-T Interface Connection

ETHERNET 10/100/1000M port: The IQS-8120NG/IQS-8130NG/IQS-8120NGE/IQS-8130NGE provides an Ethernet port for electrical 10/100/1000 Mbps Ethernet connection allowing Ethernet testing through GFP.

Connect the signal to be tested to the **ETHERNET 10/100/1000M** RJ-45 port.

LED	Status	Description
LINK/ACT	On	Ethernet link up.
	Off	Ethernet link down.
	Flash	TX/RX activity.
DUPLEX	On	Full Duplex mode.
	Flash	Collisions are detected.

Ethernet ADD/DROP Gig-E Interface Connection

ETHERNET ADD/DROP or **Gig-E** port: The IQS-8120NG/IQS-8130NG/IQS-8120NGE/IQS-8130NGE provides a 1Gig-E port for optical 1000Base-X Ethernet connection allowing GFP and Ethernet testing.

Plug the supplied SFP modules into the **ETHERNET ADD/DROP** or Gig-E slot.

Only use EXFO qualified SFPs. Using non-qualified SFPs can affect the Performance and accuracy of the optical port.

Supported SFPs

Description	Wavelength	Reach	Part Number
GigE/FC/2FC optical SFP transceiver module with LC connector	850 nm	MMF < 500 m	FTB-8590
	1310 nm	10 Km	FTB-8591
	1550 nm	90 Km	FTB-8592
Multirate (155/622 Mbps, 2.5/2.7 Gbps/FC 1x/2x) optical SFP transceiver module with LC connector	1310 nm	short (15 Km)	FTB-8190
	1310 nm	intermediate (40 Km)	FTB-8191
	1550 nm	intermediate (40 Km)	FTB-8193
	1550 nm	long (80 Km)	FTB-8192

- The **LASER** LED lights up indicating that the Gig-E port is emitting an optical signal.
- The **RX** LED lights up indicating that the Gig-E port is receiving data.

Physical Interfaces and LEDs

DCC/GCC/UC Interface Connection

DCC/GCC/UC Interface Connection

These interfaces are not currently supported.

Status LED

Indicates the status of the IQS-8100 Series module. The **STATUS** LED is green when the module is active and operates normally. The **STATUS** LED is yellow when the module is in the booting process. The **STATUS** LED is red to indicate a failure of the module.

5 Introducing and Using the Graphical User Interface

Starting the IQS-8100 Series Transport Blazer Application

To Start the IQS-8100 Series Application:

1. Once your IQS-8100 Series module is installed, turn on the IQS-600.
2. In the IQS Manager main window, under **Modules**, press IQS-8105, IQS-8115, IQS-8120, IQS-8120NG, IQS-8130, IQS-8130NG, IQS-8120NGE, IQS-8130NGE, or IQS-8140 once to select the module.

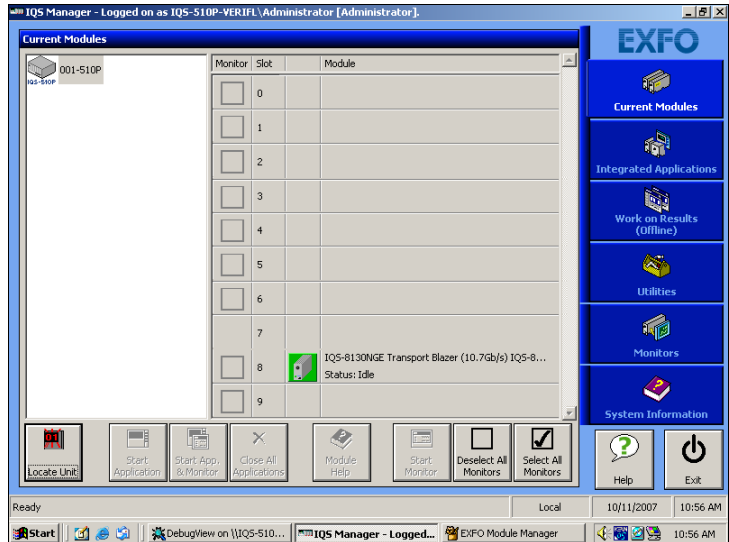

3. Press **Start Application** to start the module application or the **Network Analyzer**.
4. This step applies to the IQS-8120NGE/IQS-8130NGE module only. The **Network Analyzer** allows to either run the **SONET/SDH** or the **Packet Analyzer**. Both analyzers cannot run simultaneously. Press **SONET/SDH Analyzer** to start the module for SONET/SDH/OTN test.

Introducing and Using the Graphical User Interface

Starting the IQS-8100 Series Transport Blazer Application

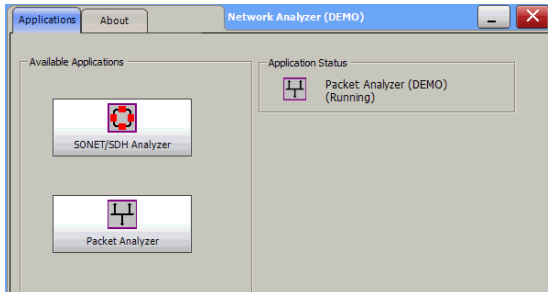

Note: Refer to the *Ethernet and Fibre Channel Application user guide* for more information on Packet Analyzer.

The exit button (X) closes the **Network Analyzer**, **SONET/SDH Analyzer**, and/or **Packet Analyzer** applications. If a test is created, one of the following confirmation messages is displayed, based on the standalone feature status (enabled or not). Refer to the IQS-600 user guide for more information on the standalone feature.

- The following message is displayed when exiting the GUI while a test is created and standalone is disabled.
Are you sure you want to exit the Network Analyzer, SONET/SDH Analyzer, and Packet Analyzer? Any unsaved information will be lost.
- The following message is displayed when exiting the GUI while a test is created and standalone is enabled.
Exiting the application will maintain the module alive as the Standalone mode is enabled. Are you sure you want to exit?

Main Window

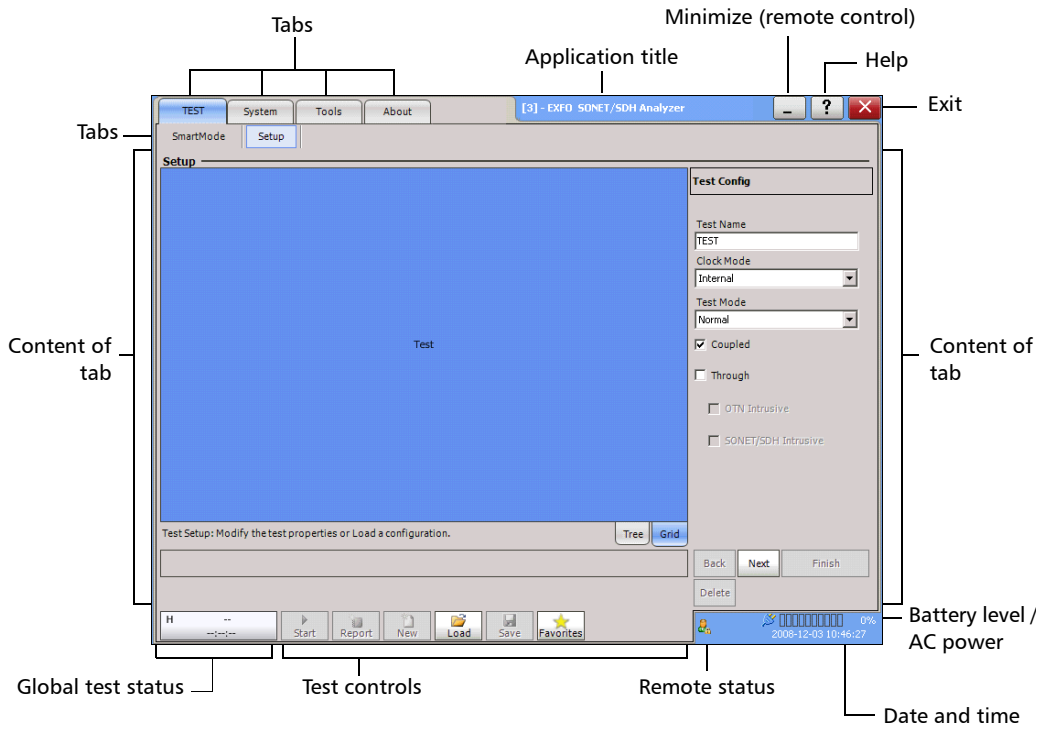

Introducing and Using the Graphical User Interface

Main Window

Tabs

The GUI application contains the following four main application tabs that contain other tabs.

➤ **TEST Tab**

The **TEST** tab gives access to the test creation, configuration, and results.

SmartMode is part of the **TEST** tab and allows to automatically identify the structure of the selected SONET/SDH signal rate that is connected to the **Transport Blazer** module. Refer to *Smart Mode* on page 111 for more information. Not available on the IQS-8140.

Setup is part of the **TEST** tab and allows setting up the test. Refer to page 62 for more information.

Once the test is created, other tabs are enabled allowing configuration of test parameters and viewing of the test status and results.

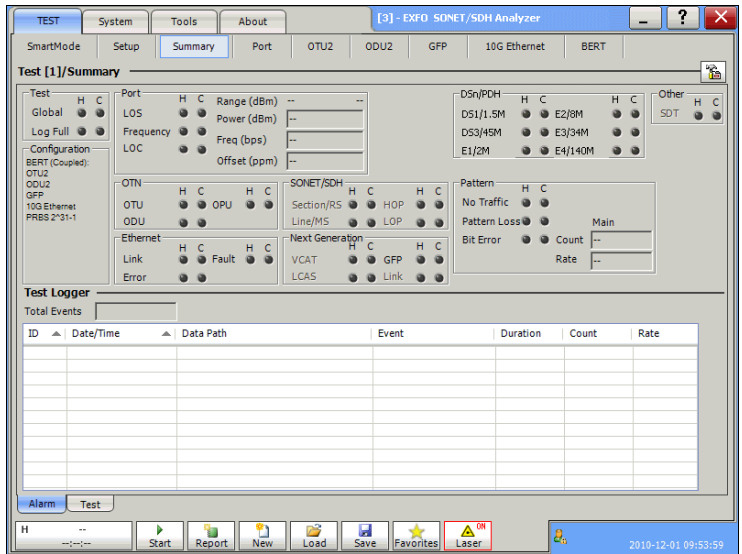

In this user guide, the tabs are grouped as shown below:

- *Summary Tabs* on page 125
- *Port Tabs* on page 137
- *OTN Tabs* on page 153
- *SONET Tabs* on page 211
- *DSn Tabs* on page 269
- *SDH Tabs* on page 303
- *PDH Tabs* on page 369
- *Ethernet Tabs* on page 393
- *BERT Tabs* on page 405
- *Advanced Tabs* on page 411
- *Next-Generation Tabs* on page 429
- *Common Tabs* on page 491
- **System** tab; refer to page 519 for more information.
- **Tools** tab; refer to page 551 for more information.
- **About** tab; gives information on EXFO company, contact, and product software release version.

Application Title

Displays the software application title which is **[x] - EXFO SONET/SDH Analyzer**. Where **x** is the slot ID in which the module is inserted.

A module description appears in front of the **[x]** slot ID when defined in IQS Manager. Refer to **Tools, Remote Control Configuration, and Module Description** field from the IQS-600 user guide for more information.

For Visual Guardian Lite, the IP address of the IQS-600 is inserted after the **[x]** slot ID.

For example: **Module #1 - [2] - 10.1.200.25 - EXFO SONET/SDH Analyzer**

Minimize

The minimize button (**_**) allows minimization of a remote **GUI** application (**Visual Guardian Lite**).

Help

The help button (?) displays the help information on the current window. A window pops up to select the area of the application where help is required. Press **OK** and the help information is immediately displayed.

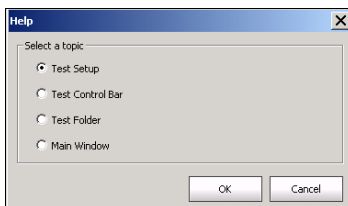

It is also possible to navigate through the help information once the help window is open.

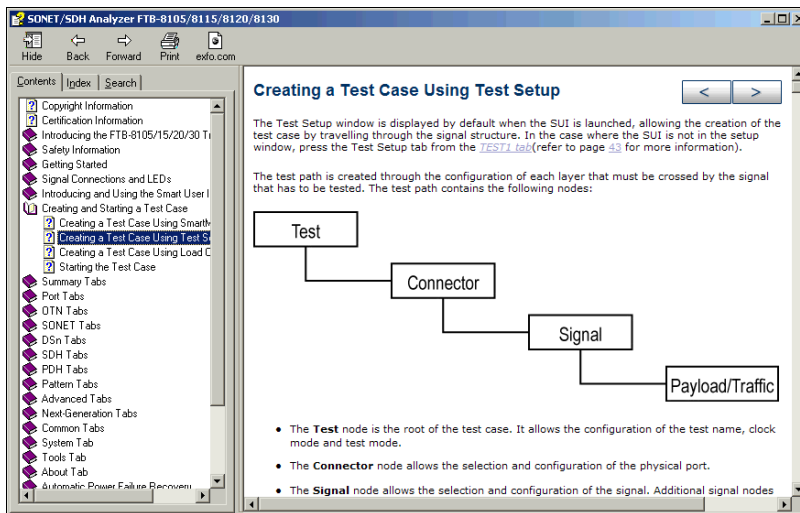

Exit

For IQS-8105, IQS-8115, IQS-8120, IQS-8120NG, IQS-8130, IQS-8130NG, and IQS-8140: The exit button (X) closes the current application. If a test is created, one of the following confirmation messages is displayed, based on the standalone feature status (enabled or not). Refer to the IQS-600 user guide for more information on the standalone feature.

- The following message is displayed when exiting the GUI while a test is created and standalone is disabled.

**Are you sure you want to exit the IQS-8100 Series Transport Blazer?
Any unsaved information will be lost.**

- The following message is displayed when exiting the GUI while a test is created and standalone is enabled.

**Exiting the application will maintain the module alive as the
Standalone mode is enabled. Are you sure you want to exit?**

For IQS-8120NGE, and IQS-8130NGE: The exit button (X) switches from the current application to the **Network Analyzer** application. If the test is running, a user confirmation is required to stop the test before switching the application. The switching puts the application in idle mode meaning that the test case configuration is kept and will be recovered when returning to that application.

Global Test Status and Controls

Global Test Status

The global test status button displays the alarm, pass/fail verdict, and test timer. Clicking on this button maximizes the view of these status. The maximized view is useful to facilitate distant viewing of these status.

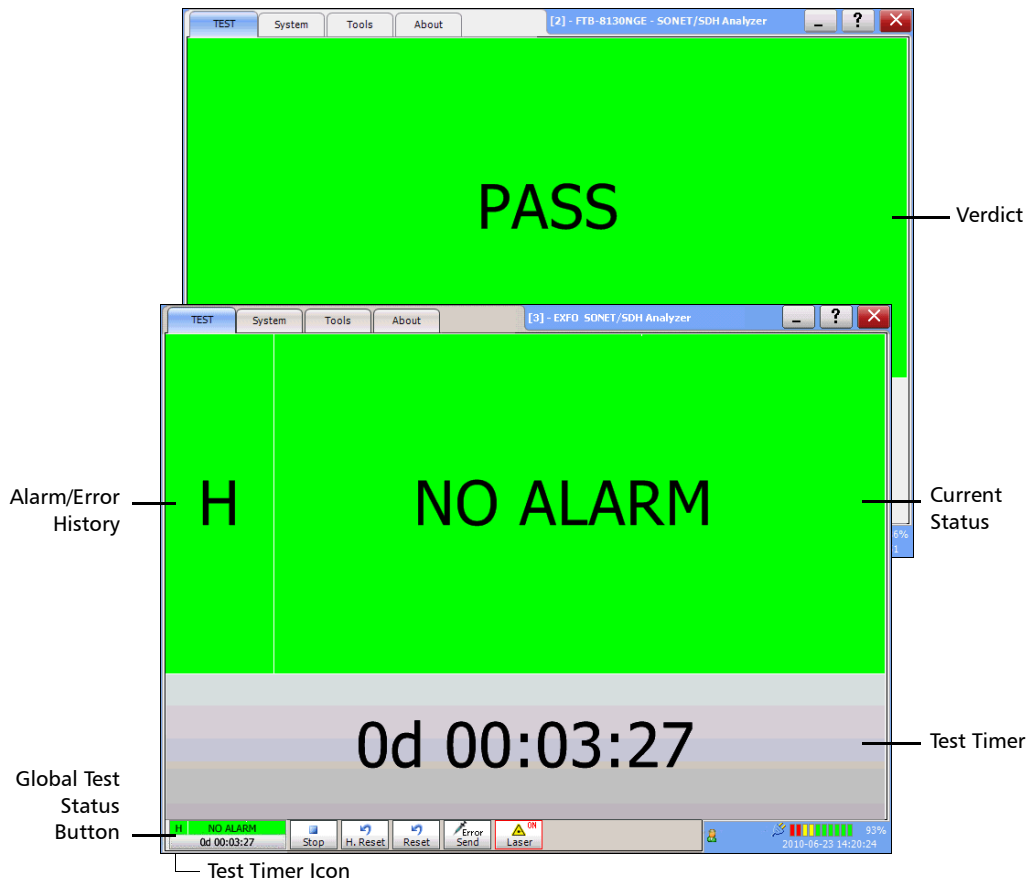

Introducing and Using the Graphical User Interface

Global Test Status and Controls

To minimize the view, either click on the global test status button or click anywhere on the maximized status area.









History and current status are reported for all tests at the exception of Multi-Channel SDT test mode which reports the pass/fail verdict when enabled.

- **H (History)**: Indicates if alarms/errors occurred in the past. A grey background indicates that the test did not run yet, a green background indicates that no alarm/error has occurred, while a red background indicates that at least one alarm/error has occurred.
- **Current status**: Indicates the current alarm/error status of the test. A grey background indicates that the test is not running (--), a green background indicates that there is no alarm/error active (**NO ALARM**), while a red background indicates that at least one alarm/error condition is active (**ALARM**).

Note: *The history and current alarm/error status are monitored once the test is started.*





- **Verdict**: Reports the SDT test verdict status when enabled. Only available with Multi-Channel SDT test mode.
 - **PASS** is displayed with a green background when all SDT result values are smaller or equal to the configured SDT threshold.
 - **FAIL** is displayed with a red background when any SDT result value is bigger than the configured SDT threshold.
 - **--** is displayed with a gray background when either the SDT threshold is not enabled or the test has not run yet.
- The test timer indicates the time elapsed since the beginning of the test. The test timer format is “day hour:minute:second”.
- The test timer icon indicates that the timer configuration is enabled. Refer to *Timer Configuration* on page 130 for more information.

Test Controls

Button	Description
	Starts the test. Start is available when the test is created and not running.
	Stops the test. ^a
	Resets the history (H) alarm and error LEDs. ^a
	Resets counters (seconds, count, and rate), test timer and both history (H) and current (C) LEDs for the entire test case. Also resets the logger. ^a
	Generates a report of the current test. See <i>Test Report Generation</i> on page 42 for more information. ^b
	Clears the current test. A user's confirmation is required before clearing the test. ^b
	<p>Loads a previously saved configuration. Select an existing file and press Open to confirm. The default directory is d:\IQSManager\User Files\SonetSdhAnalyzerG2\Configuration under Windows XP and Documents\User Files\SonetSdhAnalyzerG2\Configuration under Windows 8. The configuration file extension is cfg.^b</p> <p>An error message is displayed and the configuration is not loaded when the file is corrupted, the module is not properly installed, the hardware or software options are not compatible, invalid configuration (IQS-8105/15/20/30), or when the resources or power are not sufficient. Refer to <i>Solving Common Problems</i> on page 559 for more information.</p>
	<p>Saves the current test configuration. Select an existing file, or type a new name in the File name field, and press Save. The default directory is d:\IQSManager\User Files\SonetSdhAnalyzerG2\Configuration under Windows XP and Documents\User Files\SonetSdhAnalyzerG2\Configuration under Windows 8.^b</p>
	Generates pattern bit error according to the amount selected on the Pattern TX tab. Refer to <i>Pattern Error Injection</i> on page 408. ^a

Introducing and Using the Graphical User Interface



Global Test Status and Controls

Button	Description
	Indicates that the laser control is off. Pressing this button will activate the laser immediately by emitting an optical laser signal. This button is only available for optical interfaces. The laser is On by default when the test is created unless otherwise set from the <i>Default Test Preferences</i> on page 530.
	Indicates that the laser control is on. Pressing this button will turn off the laser. This button is only available for optical interfaces. The laser is On by default when the test is created unless otherwise set from the <i>Default Test Preferences</i> on page 530. The laser control button is not affected when turning off the laser by generating a LOS for example.
	Provides access to 10 default or customer defined test case configurations. See <i>Favorites</i> on page 40 for more information. ^b
	Allows the detection of the Line Coding , Framing , and Test Pattern of the selected DS1 or DS3 input signal once the test is created. Upon detection of specific alarms, the detection may not be possible, press Retry to invoke the detection again. ^b

- a. Only available when the test is running.
- b. Only available when the test is not running (Stop).

Remote Status

Indicates whether the remote control feature is enabled/disabled and indicates the number of connections established with the IQS-8100 Series when enabled.

	Indicates that the remote control feature is disabled. Refer to the IQS-600 user guide for more information on how to enable it.
	Indicates that a single connection is established with the IQS-8100 Series. The connection can be either local (on the IQS-600) or remote (on a remote PC using Visual Guardian Lite).
	Indicates that at least two connections are established with the IQS-8100 Series. Connections can be a combination of one local (on the IQS-600) and at least one remote connection (on a remote PC using Visual Guardian Lite), two or more remote connections.

Date and Time

Indicates the date (YYYY-MM-DD) and time (HH:MM:SS).

Refer to *Time Options* on page 528 for more information on time format and time zone.

AC Power

Indicates the presence of an AC power source.

Favorites

Favorites gives access to 10 factory test case configurations. Favorites is available when no test is running.

Press  .

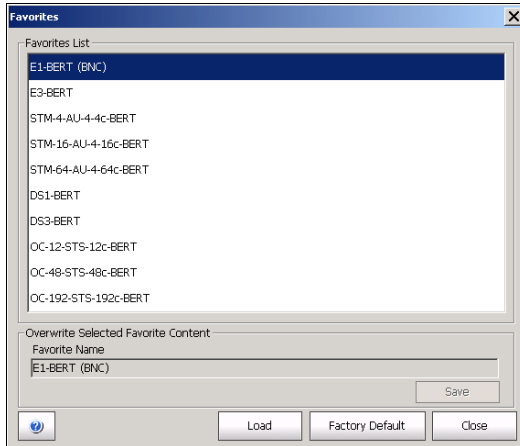

Favorites List

Allows to select a test case configuration. The test case configuration selected by default is the first one in the list.

Note: *Test cases not supported by the current IQS-8100 Series model and its options will not be created.*

Note: *Favorites may or may not be compatible from one version of software to another. They also may or may not be compatible from one module to another depending on the hardware and software option installed.*

Overwrite Selected Favorite Content

The factory test case configurations can be modified as well as their default names.

- **Favorite Name:** Allows changing the name of the test case configuration file. A maximum of 32 characters are allowed in the name.
- **Save:** Saves the current test case configuration using the specified favorite name.

Load

Loads the selected test case configuration. Loading a favorite configuration automatically clears the current test case.

Factory Default

Resets and regenerates the favorites list based on the module model and its enabled options.

Note: *A Default Favorites list is created the first time a specific module is used, based on its module type and options. A favorites list is generated for each module type used (IQS-8105, IQS-8115, IQS-8120, IQS-8120NG, IQS-8120NGE, IQS-8130, IQS-8130NG, IQS-8130NGE, and IQS-8140). The favorites list for a specific module type is common for all modules of the same type on the IQS-600. The favorites list is not updated even when either a new software option is installed or another module having different options is used. For these reasons, the **Factory Default** button allows to recreate the favorites list based on the current module and its options.*

Test Report Generation

Press **Report** from the *Global Test Status and Controls* to generate a report for the current test. The report contains all the information about the test including the job information, system information, interface setup, test summary, test configuration, results, etc.

Note: *The Report button is not available while the test is running or the SmartMode alarm scan is running.*

Note: *Nothing prevents the configuration and alarm/error injection setup while the test has been stopped; thus, the report should be saved before changing any test parameters to avoid discrepancy between the configuration and results.*

Information

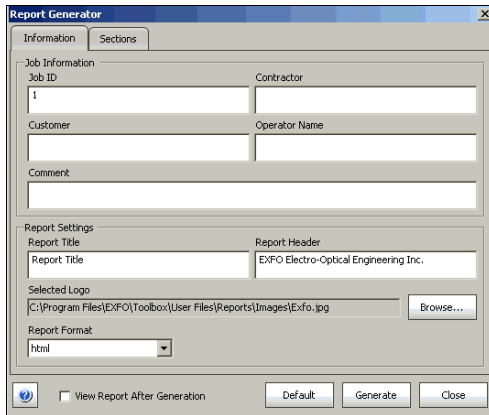

- **Job Information:** These parameters are used to identify the source of the report and are not mandatory. Enter the following job information if required: **Job ID**, **Contractor**, **Customer**, **Operator Name**, and **Comment**. Up to 256 characters are allowed for each parameter.

- **Report Settings:** These parameters are used to identify the report and are not mandatory. Enter the following report information if needed: **Report Title**, **Report Header**, **Selected Logo**, and **Report Format**.

Press **Browse** to select a different logo, then press **Open**.

Report Format: Select the report file format. Choices are **html**, **csv**, **pdf**, and **txt**. The **CSV** format (comma separated file format) generates a report with comma delimiter for English OS and semicolon for other OS languages. The default setting is **html**.

- **View Report After Generation:** Allows displaying the report once it is generated. However, the report can only be displayed when the Windows application supporting the selected **Report Format** is installed. The **View Report After Generation** check box is not selected by default.

Note: *Once generated, the report file can manually be opened typically using Windows Explorer. The default directory is **d:\IQSManager\User Files\SonetSdhAnalyzerG2\Reports** under Windows XP and **Documents\User Files\SonetSdhAnalyzerG2\Reports** under Windows 8.*

Note: *If the html report contains special characters, please make sure that the encoding in your Web browser is set to Western European ISO. To set the encoding to Western European ISO, right press the report from Internet Explorer, select Encoding, and select Western European ISO.*

- **Default** button: Press **Default** to restore the default report settings.

Introducing and Using the Graphical User Interface

Test Report Generation

- **Generate** button: Allows generating and saving the report. Select an existing file, or type a new name in the **File name** field and press **OK**. The default directory is **d:\IQSManager\User Files\SonetSdhAnalyzerG2\Reports** under Windows XP and **Documents\User Files\SonetSdhAnalyzerG2\Reports** under Windows 8.

The report file can be saved on the following locations:

Local memory (IQS-600): The file is saved locally on the IQS-600 memory.

Network drive: The file is saved on a network drive.

USB drive or Compact Flash: The file is saved on a removable drive.

Sections Tab

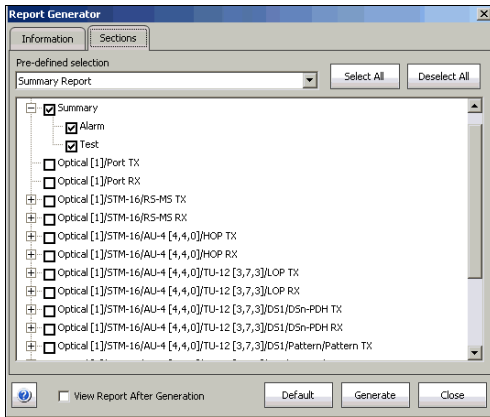

- **Pre-defined selection:** Allows selecting the type of report, and the window underneath allows selecting what will be part of the report. The default setting is **Summary Report**. Choices are:
 - **Summary Report** selects the **Summary** report section only.

- **SmartMode Report:** Selects the **SmartMode** report section only. **SmartMode** is not available on the IQS-8140. The **Graphical Overview** under SmartMode provides a graphical view of the SmartMode information. **Graphical Overview** is only available when the **Report Format** from the **Information** tab is set to **html** or **pdf**. The following picture shows an example of the SmartMode Graphical Overview.

The screenshot displays the 'Smart Mode Graphical Overview' for an OC-192 signal. The main area is a grid of status indicators for 12 STS-1 channels and 7 VT1.5 channels. The right-hand side contains detailed analysis for the selected channels, including 'Error Analysis' and 'Alarm Analysis' for B1, B2, REI-L, AIS-V, LOP-V, RDI-V, RFI-V, and REI-W. It also shows synchronization status messages and trace information.

- **Test Case Report** selects all the report sections.

Note: Once the report type is selected, each section can be selected to customize the report.

The **Select All** and **Deselect All** buttons are used to respectively select or deselect all the report sections.

Usual Tab Elements

Once the test is created, different tabs are available allowing test configuration and monitoring. The following section describes usual elements appearing on those tabs.

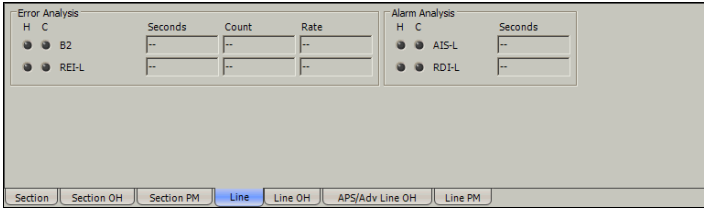

Status LEDs

- **H (History) LED:** Indicates that alarms/errors occurred in the past. A grey LED indicates that the test did not run yet, a green LED indicates that no alarm/error has occurred, while a red LED indicates that at least one alarm/error has occurred in the test.
- **C (Current) LED:** Gives the current status of the alarm/error. A grey LED indicates that the test is not running, a green LED indicates that there is no alarm/error, while a red LED indicates that at least one alarm/error condition has occurred in the last second.







Note: *The H and C LEDs are updated every second.*

Alarm/Error Measurements

Note: Alarms/Errors are only monitored once the test is started.

- **Seconds:** Gives the total number of the seconds in which one or more alarm/error occurred.
- **Count:** Gives the number of occurrences of a specific error. The count is displayed using integer value; exponential value (1.00000E10) is used when the count is bigger than the field display capacity.
- **Rate:** Calculates and displays the error rate. The rate is expressed using the exponential format with two decimal digits (example: 1.23E-04).
- Percentage values are expressed using one decimal digit. (example: 9.9%).
- Alphanumeric values display the extended ASCII character set including the *ITU T.50 Characters* on page 57. For Trace Messages using 64-bytes format, the last 2 bytes, Carriage Return and Line Feed, will be displayed within brackets (<cr> and <lf>).

Arrow Buttons

Button	Description
	Top arrow: Moves to the top of the list.
	Page up arrow: Moves one page up.
	Up arrow: Moves one row up.
	Down arrow: Moves one row down.
	Page down arrow: Moves one page down.
	End arrow: Moves to the end of the list.

Introducing and Using the Graphical User Interface

Usual Tab Elements

Table Sorting

Tables offer sorting capabilities on one or more columns.

An arrow next to the column label name, indicates the sorting column field and the sorting order. Pressing again on the selected sort column label will change the sort order.

Pressing another column label allows to sort using a different field.

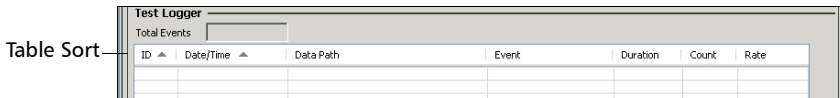

Left and Right Scroll Buttons

Left and right scroll buttons are used to respectively move left and right allowing to see more tabs. The left and right scroll buttons are not always displayed; they are only displayed when required.

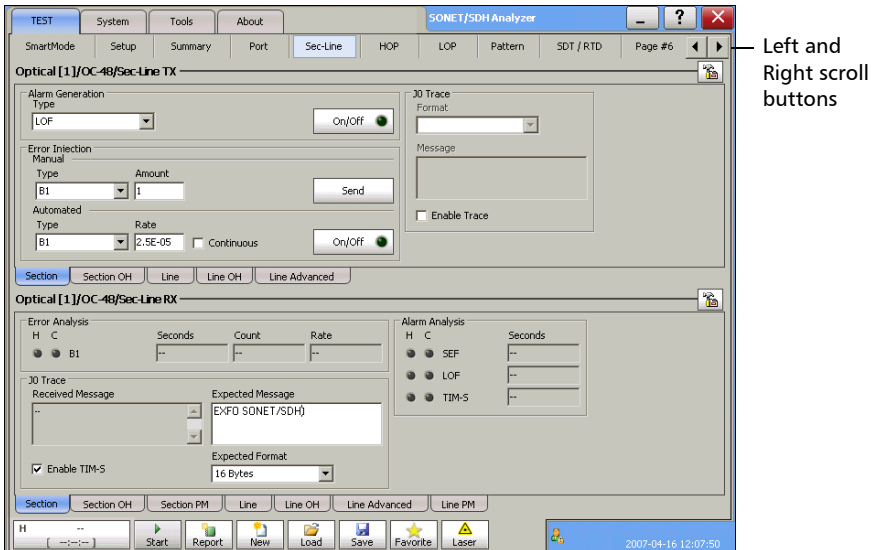

Tab Configuration

Once the test is created, other tabs next to the Test tabs are enabled allowing configuration of test parameters and viewing of the test status and results.

A tab configuration button is available at the top-right part of each tab.

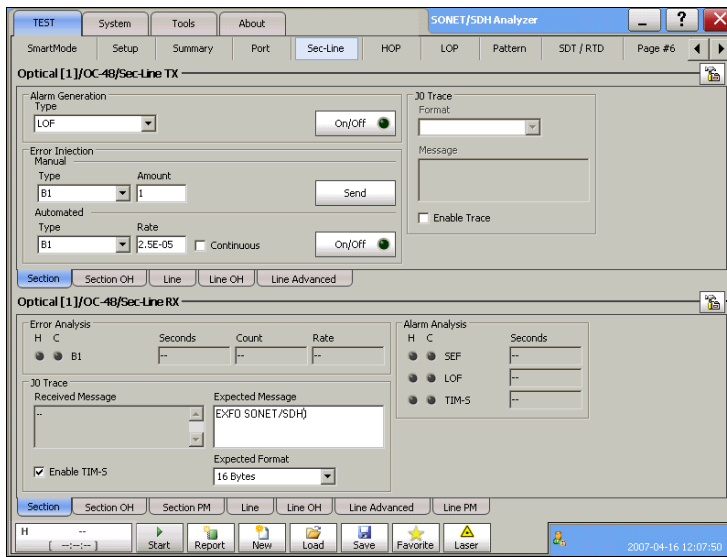

Tab Configuration buttons

Introducing and Using the Graphical User Interface

Tab Configuration

This tab configuration window allows configuration of all tabs on any page except for the **SmartMode**, **Test Setup**, and **Summary** tabs. The tab configuration allows also to jump directly to the desired page by selecting it from the *Defined Tabs* list and then pressing **OK**.

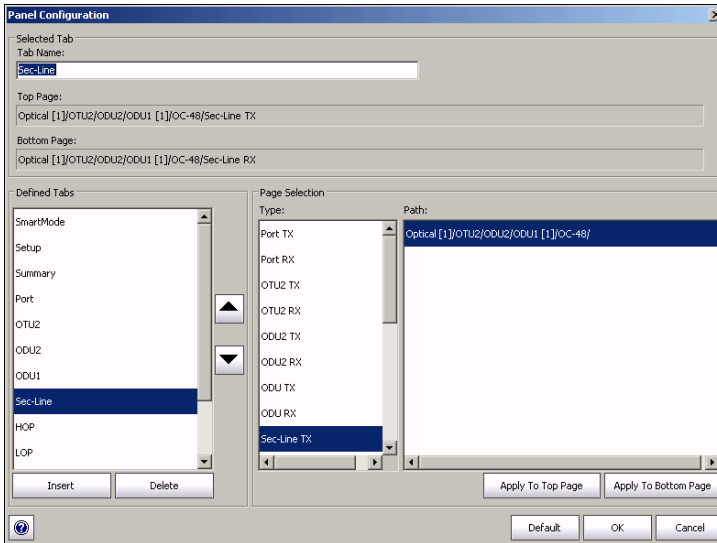

Selected Tab

- **Tab Name** indicates the name of the tab containing the two tabs (top and bottom page). Pressing this field allows changing the tab name. Tab name can be up to 35 characters long including the “/” and spaces.
- **Top Page** indicates the tab displayed at the top of the tab.
- **Bottom Page** indicates the tab displayed at the bottom of the tab.

Defined Tabs

Allows the selection of a tab.

Up and down arrows are used to respectively move the selected page up or down in the list.

Insert button allows the insertion of a new tab after the selected tab (the one highlighted) A maximum of 30 tabs can be displayed.

Delete button allows the deletion of the selected tab.

Page Selection

- **Type:** Allows the selection of a tab that will be assigned to the selected tab when pressing either **Apply to top page** or **Apply to bottom page**.
- **Path:** Indicates the test signal structure (layers/nodes of the test case) corresponding to the selected tab. Refer to *Supported Paths/Mappings* on page 59 for more information on test layers/nodes.
- **Apply To Top Page:** Applies the selected tab as top of page for the selected tab.
- **Apply To Bottom Page:** Applies the selected tab as bottom of page for the selected tab.

Note: *The available tabs listed are a function of the test path activated. **Empty Tab** displays a blank tab (Tabs that are not populated are left blank). **SmartMode**, **Test Setup**, and **Summary** tabs cannot be duplicated, deleted, or renamed.*

Help Button (?)

Displays the help information related to the tab configuration. It is also possible to navigate through the remainder of the help information.

Default Button

Return to the default page configuration layout.

OK Button

Accepts the page layout changes and jumps to the selected page (Defined tabs).

Cancel Button

Cancels the changes and returns to the page from where the tab configuration was launched.

Keyboard Usage

The GUI pops up different keyboards to modify data. Following are the usual keyboard keys:

- **Left arrow:** Moves the cursor one position to the left.
- **Right arrow:** Moves the cursor one position to the right.
- **Del:** Deletes the value at the cursor position.
- **Back:** Deletes the value preceding the cursor position.
- **Help:** Displays the help information related to the keyboard usage. It is also possible to navigate through the help information.
- **OK and Enter:** Completes data entry.
- **Cancel:** Closes the keyboard and discards the keyboard entry.
- **Binary keyboard:** Allows entering 0 and 1 values.

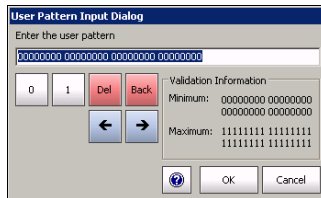

Introducing and Using the Graphical User Interface

Keyboard Usage

- Numerical keyboards: Allows entering integer/decimal values.
- For integer unsigned or signed values.

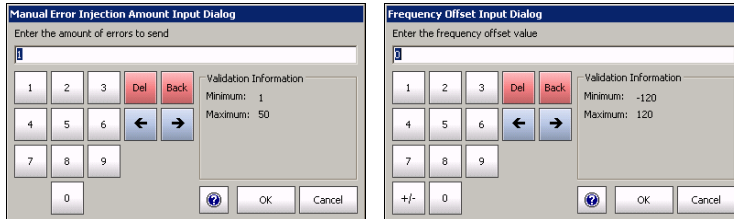

- For rate values: Allows entering the rate values (0 through 9, and exponent).

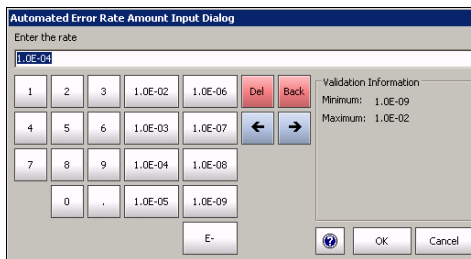

- Time Keyboard: Allows entering a time value.

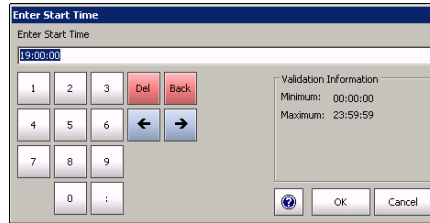

- Date keyboard: Allows selecting a date by pressing the date on the calendar. Use the left and right arrow to switch from one month to another or press the month area for quick month selection. Press the year area for quick year selection.

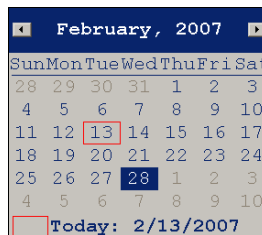

- Hexadecimal keyboards: Allows entering hexadecimal values (0 through 9 and A through F)

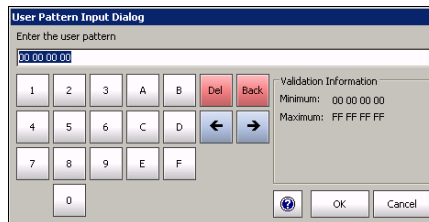

Introducing and Using the Graphical User Interface

Keyboard Usage

- Full keyboard: Allows entering numbers, letters and some other characters. The **Back**, **Del**, **Shift** and space bar keys have the same functionality as a regular PC keyboard.

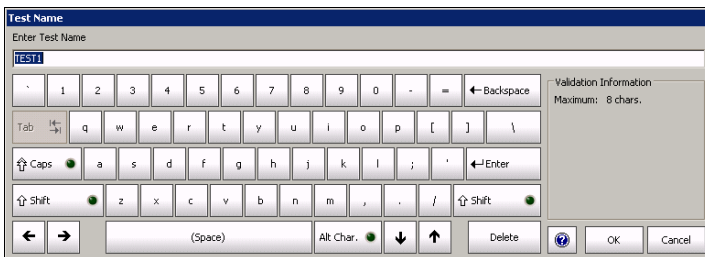

- Trace message keyboard Allows entering alphanumerical characters (ITU T.50) required for TTI, FTFL, J0, J1, and J2 Trace fields. Press the **Ctrl Char** button to access these characters.

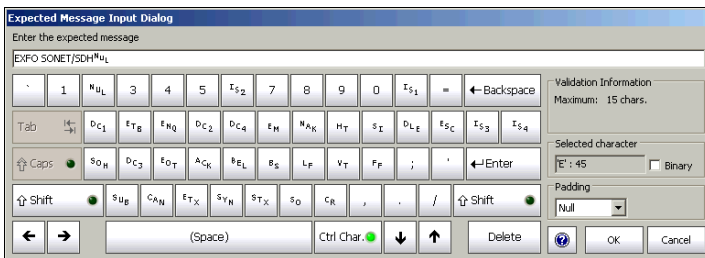

ITU T.50 Characters						
b7 to b1	Character	Description		b7 to b1	Character	Description
000 0000	NUL	Null		001 0000	DLE	Data Link Escape
000 0001	SOH	Start Of Heading		001 0001	DC1	Device Control 1
000 0010	STX	Start of Text		001 0010	DC2	Device Control 2
000 0011	ETX	End of Text		001 0011	DC3	Device Control 3
000 0100	EOT	End Of Transmission		001 0100	DC4	Device Control 4
000 0101	ENQ	Enquiry		001 0101	NAK	Negative Acknowledge
000 0110	ACK	Acknowledge		001 0110	SYN	Synchronous idle
000 0111	BEL	Bell		001 0111	ETB	End of Transmission Block
000 1000	BS	Backspace		001 1000	CAN	Cancel
000 1001	HT	Horizontal Tabulation		001 1001	EM	End of Medium
000 1010	LF	Line Feed		001 1010	SUB	Substitute character
000 1011	VT	Vertical Tabulation		001 1011	ESC	Escape
000 1100	FF	Form Feed		001 1100	IS4	Information Separator 4
000 1101	CR	Carriage Return		001 1101	IS3	Information Separator 3
000 1110	SO	Shift-Out		001 1110	IS2	Information Separator 2
000 1111	SI	Shift-In		001 1111	IS1	Information Separator 1

6 **Creating and Starting a Test Case**

A test case can be created using one of the following methods:

- **SmartMode** allows signal discovery and alarm/error monitoring. The test can be created according to the detected signal structure. **SmartMode** is only available for SONET/SDH signals (Not supported on the IQS-8140). See *Creating and Starting a Test Case Using SmartMode* on page 122.
- **Test Setup** allows the creation of the test case by travelling through the signal structure. See *Introducing the Test Setup* on page 62.
- **Favorites** allows setting up the test case by selecting a predefined test configuration. Refer to *Favorites* on page 40.
- **Load Configuration** allows setting up the test case by loading a previously saved configuration. Refer to **Load** from the *Global Test Status and Controls* on page 35.
- **Script** allows running a script that creates the test case. Refer to *Script Tab* on page 551.

Note: *Once the test case is created, press the **Start** button to start the test. Refer to Global Test Status and Controls on page 35 for more information on test management.*

Supported Paths/Mappings

The supported test paths/mappings are presented in the following charts and depend on modules and enabled options. Optical interfaces are not supported on the IQS-8105.

Creating and Starting a Test Case

Supported Paths/Mappings

OTN/Sonet/DSn Interface Path/Mapping

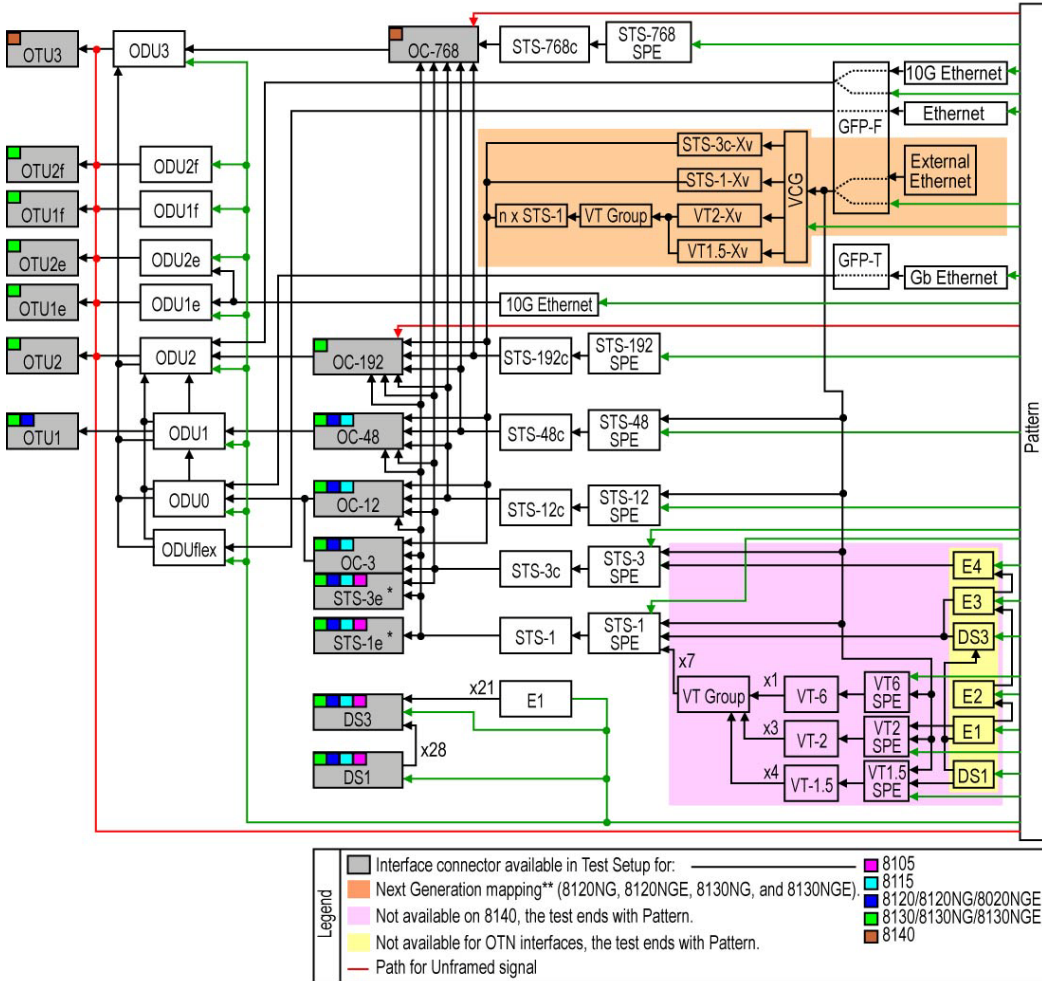

OTN/SDH/PDH Interface Path/Mapping

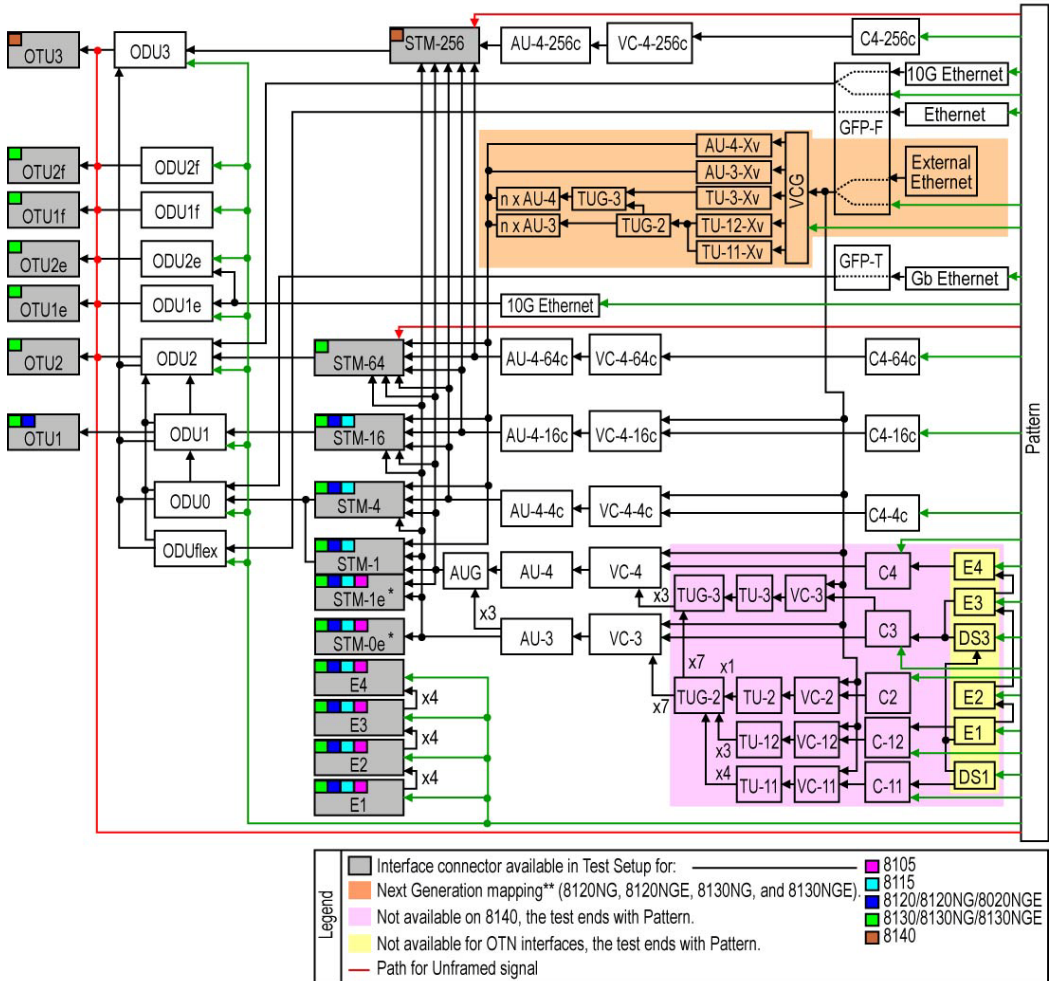

Creating and Starting a Test Case

Introducing the Test Setup

Introducing the Test Setup

The **Test Setup** window allows the creation of the test case by navigating through the signal structure. In the case where the GUI is not in the setup window, select the **Setup** tab from the *TEST Tab* (refer to 30).

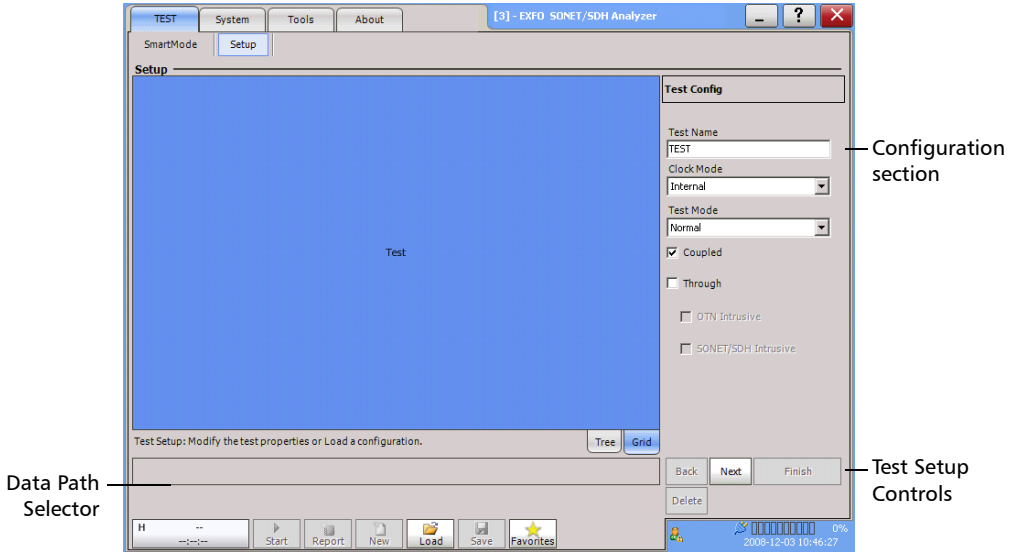

- **Tree** tab allows seeing the configuration test structure (data path).
- **Grid** tab is used for timeslot selection or test case direction (decoupled test mode).
- **Data Path Selector** is used for the selection of each node (for example: port, signal, tributary, VCG, GFP, Pattern) of the test case.
- **Configuration section** allows parameters configuration for each node of the test.

Test Name represents the name of the test. The default setting is **TEST**.

➤ **Test Setup Controls:**

- **Back** returns to the previous configuration step allowing to see, change or delete what had been selected.
- **Next** switches to the next configuration step. The **Next** button is only available when selection(s) from the Data Path Selector and/or the Grid tab has been made.
- **Delete** deletes the current path node.
- **Finish/Setup:**

Finish completes the configuration and creates the test case. Default parameters will be used for the remaining wizard steps. Thus, pressing **Finish** will automatically add a pattern at the end of the test case structure if not already selected.

Setup is displayed instead of **Finish** once the test is created allowing to return in setup mode. **Setup** is not available when the test is started (running).

The test path is created through the configuration of each layer that must be crossed by the signal under test. The test path contains the following nodes:

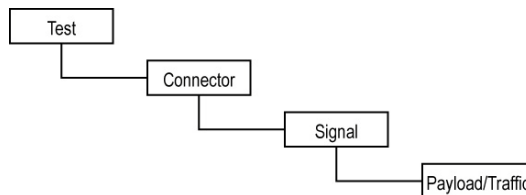

For example:

Test	Connector	Signal	Payload/Traffic
Normal - Coupled	Optical	OC-192, Normal, STS-1 Timeslot 1, VT1.5 Timeslot 1, DS1	Pattern

Creating and Starting a Test Case

Introducing the Test Setup

- The **Test** node is the root of the test case. It allows the configuration of the test name, clock mode and test mode.
- The **Connector** node allows the selection and configuration of the physical port.
- The **Signal** node allows the selection and configuration of the signal. Additional signal nodes are created for each step of the mapped signal level.
- The **Payload/Traffic** node completes the test path by selecting the pattern or an external traffic such as Ethernet interface with Packet Blazer.

Typical Test Cases

The remaining of this chapter describes how to create the following typical DS_n/PDH, SONET/SDH, OTN, Next Generation, and Ethernet over OTN test cases. The availability of test cases depend on the module and activated options.

- *Creating an Electrical DS_n/PDH Test Case in Normal Mode (IQS-8105/15/20/30) on page 66*
- *Creating an Electrical DS₁ or DS₃ Test Case in Dual RX Mode (IQS-8105/15/20/30) on page 71*
- *Creating an Electrical DS₁ Test Case in NI/CSU Emulation Mode (IQS-8105/15/20/30) on page 75*
- *Creating an Electrical SONET/SDH Test Case on page 79*
- *Creating an Optical SONET/SDH Test Case (IQS-8115/20/30) on page 83*
- *Creating an Optical SONET/SDH Test Case on an IQS-8140 on page 87*
- *Creating an Optical SONET/SDH/OTN Multi-Channel SDT Test Case (IQS-8120/8130/8140) on page 91*
- *Creating an OTN (OTU₁ and OTU₂) Test Case on page 92*
- *Creating an OTN (OTU₃) Test Case on page 97*
- *Creating a Next Generation Test Case including VCAT/LCAS and GFP on page 103*
- *Creating an OTN Overclocked (OTU_{1e}/OTU_{2e}/OTU_{1f}/OTU_{2f}) Test Case (IQS-8130, IQS-8130NG, and IQS-8130NGE) on page 108.*

Creating an Electrical DS_n/PDH Test Case in Normal Mode (IQS-8105/15/20/30)

The following procedures describe the creation of an electrical DS_n/PDH test case in **Normal** mode.

To create an Electrical DS_n/PDH Test in Normal mode:

1. Test configuration:

- 1a.** Select the source **Clock Mode** that will be used for the test. Refer to *Clock Configuration* on page 129 for more information.
- 1b.** Select **Normal** as the **Test Mode**. Refer to Test Configuration on page 126 for more information.
- 1c.** Select the **Coupled** check box to set the same settings for both the TX and RX signals or clear the **Coupled** check box to configure the TX and RX signal individually (decoupled).
- 1d.** Select the **Through** check box to loop the RX signal to the TX port. The **Clock Mode** is automatically set to **Recovered** when the **Through** check box is selected.
- 1e.** Leave the **SONET/SDH Intrusive** and **OTN Intrusive** check boxes cleared.
- 1f.** Press **Next**.

The screenshot shows a 'Test Config' dialog box with the following fields and options:

- Test Name: TEST
- Clock Mode: Internal (dropdown menu)
- Test Mode: Normal (dropdown menu)
- Coupled
- Through
- OTN Intrusive
- SONET/SDH Intrusive

2. Interface connector selection:

- 2a.** From the data path selector, press the desired electrical interface connector.



BNC for DS3, E4, E3, E2, and E1.

Bantam for DS1 and E1.

RJ-48c for DS1 and E1.

- 2b.** For **Decoupled** test mode, both TX and RX ports have to be selected and configured:

First select the interface type for TX from the data path selector then proceed with the

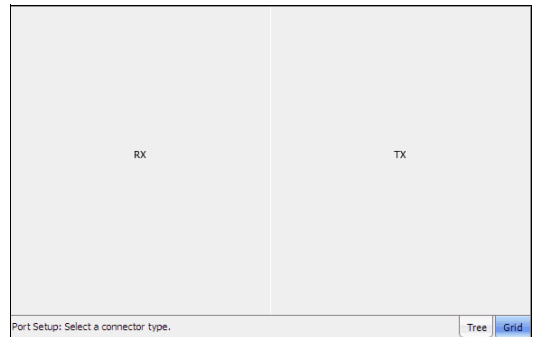

rest of the test setup steps to set the test parameters for the TX interface. At the end, do not press **Finish** yet. Press **Back** to return to the RX/TX selection screen and select the interface type for RX from the data path selector then proceed with the rest of the test setup steps to set the test parameters for the RX interface.

- 2c.** Press **Next**.

Creating and Starting a Test Case

Typical Test Cases

3. Interface selection and configuration:

- 3a. Press the desired interface: **DS3**, **DS1**, **E4**, **E3**, **E2**, or **E1**.



- 3b. Select the **Framing**, **Line Coding**, **TX LBO** (DSn interface only), and **RX Termination Mode**. **Term**, **Mon**, and **Bridge** (DS1/E1 only) termination mode are available. For more information, refer to **TX - DSn Tabs** on page 269 or **PDH Tabs** on page 369 for the framing, **Port TX (Electrical Interfaces)** on page 138 for Line Coding and LBO, to **RX - DSn Tabs** on page 269 or **PDH Tabs** on page 369 for Termination Mode.

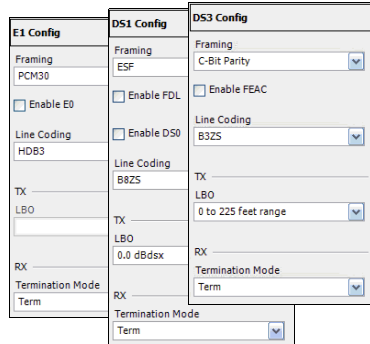

- 3c. For DS1, select the **Enable FDL** check box to allow facility data link testing.
- 3d. For DS1/E1, select the **Enable DS0/E0** check box to allow DS0 or E0 testing.
- 3e. For DS3 interface, select the **Enable FEAC** check box to allow far end alarm and control testing.
- 3f. Press Next or Finish.

4. Select the test path/mapping (For DS3, E4, E3, and E2).

- 4a. From the data path selector, press the desired mapping then press the timeslot from the **Grid** tab. Choices depend on the selected interface. See *Supported Paths/Mappings* on page 59 for more information.

	DS2 [1]	DS2 [2]	DS2 [3]	DS2 [4]	DS2 [5]	DS2 [6]	DS2 [7]
DS1 [1]	1	1	1	1	1	1	1
DS1 [2]	2	2	2	2	2	2	2
DS1 [3]	3	3	3	3	3	3	3
DS1 [4]	4	4	4	4	4	4	4

Path Setup: Select a mapping and its position or a payload. Tree **Grid**

DS1	E1	Pattern
-----	----	---------

- 4b. Select the **Framing**. For more information, refer to DS_n Tabs on page 269 or PDH Tabs on page 369.
- 4c. For DS1, select the **Enable FDL** check box to allow facility data link testing. For **Dual RX** test, FDL is only available for the primary DS1 TX/RX port.
- 4d. For DS1/E1, select the **Enable DS0/E0** check box to allow DS0 or E0 testing.
- 4e. For **Pattern**, go to step 5.
- 4f. Press Next or Finish.
- 4g. Repeat step 4 as required to complete the path/mapping. See *Supported Paths/Mappings* on page 59 for more information.

E1 [1,1] Config

Framing
PCM30

Enable E0

DS1 [1,1] Config

Framing
ESF

Enable FDL

Enable DS0

5. Pattern Configuration:

- 5a. Set the pattern parameters. Refer to *Pattern TX* on page 405 and *Pattern RX* on page 409 for more information.

Pattern Config

Configuration

Test Pattern
PRBS 2ⁿ-23-1

Invert

Live Traffic

Creating and Starting a Test Case

Typical Test Cases

6. Press **Finish** to complete the test setup. The **Grid** tab closes and automatically switch to the **Alarm** summary tab.
7. For additional configuration parameters and results, refer to *Summary Tabs* on page 125, *Port Tabs* on page 137, *DSn Tabs* on page 269, *PDH Tabs* on page 369, *BERT Tabs* on page 405, *Advanced Tabs* on page 411, and *Common Tabs* on page 491.
8. Press the **Start** button to start the test. Refer to *Global Test Status and Controls on page 35* for more information on test management.

Creating an Electrical DS1 or DS3 Test Case in Dual RX Mode (IQS-8105/15/20/30)

The following procedures describe the creation of an electrical DS1 or DS3 test case in **Dual RX** mode.

To create an Electrical DS1 or DS3 Test in Dual RX mode:

1. Test configuration:

- 1a.** Select the source **Clock Mode** that will be used for the test. Refer to *Clock Configuration* on page 129 for more information.
- 1b.** Select **Dual RX** (DS1 or DS3 signals) as the **Test Mode**. Refer to Test Configuration on page 126 for more information.

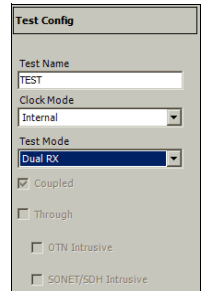

The **Coupled** check box is automatically selected for Dual RX mode meaning that the settings for both the TX and RX signals are the same.

- 1c.** Press **Next**.

2. Interface connector selection:

- 2a.** From the data path selector, press the desired electrical interface connector.

BNC for DS3, **Bantam** or **RJ-48c** for DS1.

- 2b.** Press **Next**.

Creating and Starting a Test Case

Typical Test Cases

3. Interface configuration:

3a. Select the **Framing**, **Line Coding**, **TX LBO**, and **RX Termination Mode**. **Term**, **Mon**, and **Bridge** (DS1 only) termination modes are available. For more information, refer to **TX - DS_n Tabs** on page 269 or **PDH Tabs** on page 369 for the framing, **Port TX (Electrical Interfaces)** on page 138 for Line Coding and LBO, or **RX DS_n Tabs** on page 269.

The image shows two configuration panels side-by-side. The left panel is titled 'DS1 Config' and includes fields for Framing (ESF), checkboxes for 'Enable FDL' and 'Enable DS0', Line Coding (B8ZS), TX (0 to 225 feet range), LBO (0.0 dBdsx), and RX. The right panel is titled 'DS3 Config' and includes Framing (C-Bit Parity), 'Enable FEAC' checkbox, Line Coding (B3ZS), TX (0 to 225 feet range), LBO, and RX Termination Mode (Term). Below the DS3 panel is a 'Termination Mode' dropdown menu with 'Term' selected.

3b. Select the **Termination Mode** for both RX ports. **Dual RX** test case uses the BNC labelled **AUX** for the second RX port.

3c. For DS1, select the **Enable FDL** check box to allow facility data link testing.

3d. For DS1/E1, select the **Enable DS0/E0** check box to allow DS0 or E0 testing.

3e. For DS3 interface, select the **Enable FEAC** check box to allow far end alarm and control testing.

3f. Press Next or Finish.

The image shows a 'DS3 Config' panel with Framing (C-Bit Parity), 'Enable FEAC' checkbox, Line Coding (B3ZS), TX (0 to 225 feet range), LBO, and RX Termination Mode (Term). Below the RX field are two 'Termination Mode' dropdown menus, one for RX1 and one for RX2, both with 'Term' selected.

4. For DS3, select the test path/mapping.
 - 4a. From the data path selector, press the desired mapping then press the timeslot from the **Grid** tab. Choices depend on the selected interface. See *Supported Paths/Mappings* on page 59 for more information.

	DS2 [1]	DS2 [2]	DS2 [3]	DS2 [4]	DS2 [5]	DS2 [6]	DS2 [7]
DS1 [1]	1	1	1	1	1	1	1
DS1 [2]	2	2	2	2	2	2	2
DS1 [3]	3	3	3	3	3	3	3
DS1 [4]	4	4	4	4	4	4	4

Path Setup: Select a mapping and its position or a payload. Tree **Grid**

DS1 E1 Pattern

- 4b. Select the **Framing**. For more information, refer to *DSn Tabs* on page 269.
- 4c. For DS1, select the **Enable FDL** check box to allow facility data link testing. FDL is only available for the main DS1 TX/RX port.
- 4d. For DS1, select the **Enable DS0/E0** check box to allow DS0 or E0 testing.
- 4e. For **Pattern**, go to step 5.
- 4f. Press Next or Finish.
- 4g. Repeat step 4 as required to complete the path/mapping. See *Supported Paths/Mappings* on page 59 for more information.

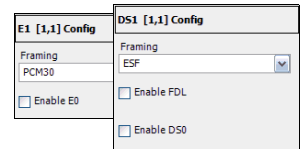

5. Pattern Configuration:
 - 5a. Set the pattern parameters. Refer to *Pattern TX* on page 405 and *Pattern RX* on page 409 for more information.

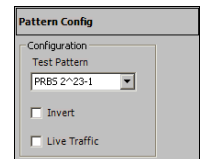

Creating and Starting a Test Case

Typical Test Cases

6. Press **Finish** to complete the test setup. The **Grid** tab closes and automatically switch to the **Alarm** summary tab.
7. For additional configuration parameters and results, refer to *Summary Tabs* on page 125, *Port Tabs* on page 137, *DSn Tabs* on page 269, *PDH Tabs* on page 369, *BERT Tabs* on page 405, *Advanced Tabs* on page 411, and *Common Tabs* on page 491.
8. Press the **Start** button to start the test. Refer to *Global Test Status and Controls on page 35* for more information on test management.

Creating an Electrical DS1 Test Case in NI/CSU Emulation Mode (IQS-8105/15/20/30)

The following procedures describe the creation of an electrical DS1 test case in **NI/CSU Emulation** mode.

To create an Electrical DS1 Test in NI/CSU Emulation mode:

1. Test configuration:

- 1a.** Select **NI/CSU Emulation** as the **Test Mode: Normal**. Refer to Test Configuration on page 126 for more information. The **Coupled** check box must be selected to allow **NI/CSU Emulation** mode selection.

The **Clock Mode** is automatically set to **Recovered**. Refer to *Clock Configuration* on page 129 for more information.

- 1b.** Press **Next**.

2. Interface connector selection:

- 2a.** From the data path selector, press the desired electrical interface connector: **Bantam** or **RJ-48c**.

- 2b.** Press **Next**.

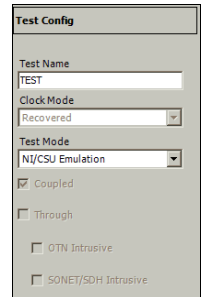

Creating and Starting a Test Case

Typical Test Cases

3. Interface configuration:

- 3a. From the **Interface** tab, select the **Framing**, **Line Coding**, and **TX LBO**.

The **RX Termination Mode** is set to **Term**.

For more information, refer to *DS1/1.5M TX* on page 275 for the framing, *Port TX (Electrical Interfaces)* on page 138 for Line Coding and LBO, and to *DS1/1.5M RX* on page 278 for Termination Mode.

Enable FDL check box is automatically selected to allow facility data link testing.

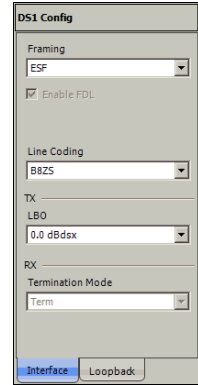

- 3b. From the **Loopback** tab, select the loopback control **Mode**: **Manual** or **Auto-Response**.

- 3c. For **Manual**:

Select the **Type** of loopback code that will be applied: **None**, **Line**, or **Payload**. **Payload** is only available with SF and ESF framings.

The **Loopback Active** LED indicates the presence of an active loopback.

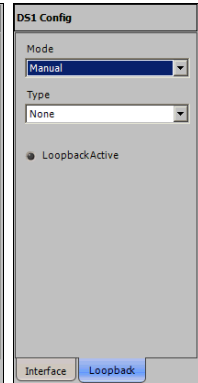
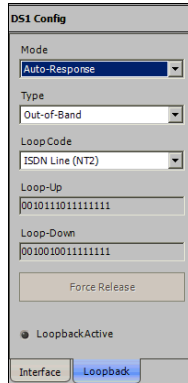

- 3d. For **Auto-Response**:

Select the **Type** of loopback code on which the module will respond: **In-Band** or **Out-of-Band**. **Out-of-Band** is only available when the interface framing is set to **ESF**.

Select the **Loop Code**:

In-Band loop code	Loop-UP Code	Loop-Down Code
CSU	10000	100
NIU FAC1	1100	1110
NIU FAC2	11000	11100
NIU FAC3	100000	100
Loop Code1 to 10	Refer to <i>DSn Loop Codes</i> on page 543 for more information.	
User Defined	Loop-Up and Loop-Down range is from 000 to 1111111111111111 . The default DS1 loop codes correspond to the DS1 In-Band loop codes (Loop-Up= 10000 , and Loop-Down= 100).	

Out-of-Band loop code	Loop-UP Code	Loop-Down Code
Line	00001110 11111111	00111000 11111111
Payload	00010100 11111111	00110010 11111111
Reserved For Network Use	00010010 11111111	00100100 11111111
ISDN Line (NT2)	00101110 11111111	00100100 11111111
CI/CSU Line(NT1)	00100000 11111111	00100100 11111111

The **Loop-UP** and **Loop-Down** values are automatically updated to the **In-Band** or **Out-of-Band** selection (**Type**). However these fields are editable when the **Loop Code** is set to **User Defined**.

The **Force Release** button allows to release a loopback condition initiated from the network. Only available when a loopback is active.

The **Loopback Active** LED indicates the presence of an active loopback.

3e. Press Next or Finish.

Creating and Starting a Test Case

Typical Test Cases

4. Press **Finish** to complete the test setup.

The DS1 Loopback function is now operational; no need to start the test. However, the test may be started to monitor the condition of the DS1 line connection to that test equipment.

5. For additional configuration parameters and results, refer to *Summary Tabs* on page 125, *Port Tabs* on page 137, and *DSn Tabs* on page 269.
6. For additional configuration parameters and results, refer to the following chapters: Summary, Port, and DSn tabs.
7. Press the **Start** button to start the test. Refer to Global Test Status and Controls on page 35 for more information on test management.

Creating an Electrical SONET/SDH Test Case

To create an Electrical SONET/SDH Test on an IQS-8105/15/20/30:

1. Test configuration:

- 1a.** Select the source **Clock Mode** that will be used for the test. Refer to *Clock Configuration* on page 129 for more information.
- 1b.** Select **Normal** as the **Test Mode**. Refer to Test Configuration on page 126 for more information.
- 1c.** Select the **Coupled** check box to set the same settings for both the TX and RX signals or clear the **Coupled** check box to configure the TX and RX signal individually (decoupled).
- 1d.** Select the **Through** check box to loop the RX signal to the TX port. The **Clock Mode** is automatically set to **Recovered** when the **Through** check box is selected.
- 1e.** Leave the **SONET/SDH Intrusive** and **OTN Intrusive** check boxes cleared.
- 1f.** Press **Next**.

Test Config	
Test Name	TEST
Clock Mode	Internal
Test Mode	Normal
<input checked="" type="checkbox"/> Coupled	
<input type="checkbox"/> Through	
<input type="checkbox"/> OTN Intrusive	
<input type="checkbox"/> SONET/SDH Intrusive	

Creating and Starting a Test Case

Typical Test Cases

2. Interface connector selection:

2a. From the data path selector, press the **BNC** electrical interface connector.



2b. For **Decoupled** test mode, both TX and RX ports have to be selected and configured:



First select the interface type for TX from the data path selector then proceed with the rest of the test setup steps to set the test parameters for the TX interface. At the end, do not press **Finish** yet. Press **Back** to return to the RX/TX selection screen and select the interface type for RX from the data path selector then proceed with the rest of the test setup steps to set the test parameters for the RX interface.

2c. Press **Next**.

3. Interface selection and configuration:

3a. Press the desired interface: **STS-3e**, **STS-1e**, **STM-1e**, or **STM-0e**.

3b. Select the **Line Coding**, **TX LBO**, and **RX Termination Mode (Term or Mon)**. For more information, refer *Port TX (Electrical Interfaces)* on page 138 for Line Coding and LBO, to *RX - DSn Tabs* on page 269 or *PDH Tabs* on page 369 for Termination Mode.

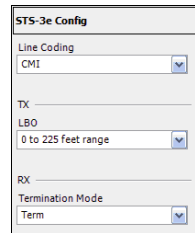

3c. Press **Next**.

4. Select the test path/mapping.
 - 4a. From the data path selector, press the desired path/mapping. Choices depend on the selected interface. See *Supported Paths/Mappings* on page 59 for more information.

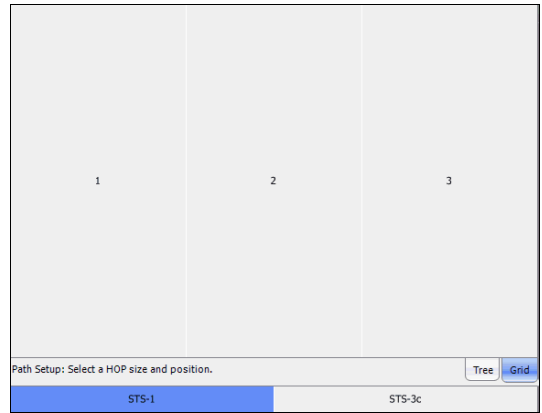

- 4b. Press a timeslot from the **Grid** tab when applicable.

- 4c. For STS/STM and VT/AU mapping level, select the **Enable TCM** check box if needed.

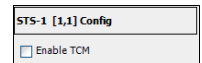

- 4d. For DS_n/PDH mapping level, select the **Framing**. For more information, refer to *DS_n Tabs* or *PDH Tabs*.

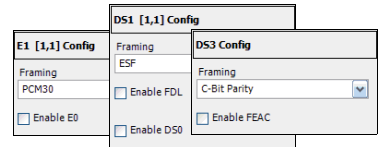

For DS3, select the **Enable FEAC** check box to allow far end alarm and control testing.

For DS1, select the **Enable FDL** check box to allow facility data link testing.

For DS1/E1, select the **Enable DS0/E0** check box to allow DS0 or E0 testing.

- 4e. For **Pattern**, go to step 5.
 - 4f. Press Next or Finish.
 - 4g. Repeat step 4 as required to complete the path/mapping. See *Supported Paths/Mappings* on page 59 for more information.

Creating and Starting a Test Case

Typical Test Cases

5. Pattern Configuration:

- 5a.** Set the pattern parameters. Refer to *Pattern TX* on page 405 and *Pattern RX* on page 409 for more information.

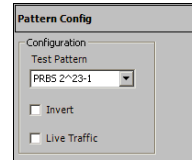

- 6.** Press **Finish** to complete the test setup. The **Grid** tab closes and automatically switch to the **Alarm** summary tab.
- 7.** For additional configuration parameters and results, refer to *Summary Tabs* on page 125, *Port Tabs* on page 137, *SONET Tabs* on page 211, *DSn Tabs* on page 269, *SDH Tabs* on page 303, *PDH Tabs* on page 369, *BERT Tabs* on page 405, *Advanced Tabs* on page 411, and *Common Tabs* on page 491.
- 8.** Press the **Start** button to start the test. Refer to Global Test Status and Controls on page 35 for more information on test management.

Creating an Optical SONET/SDH Test Case (IQS-8115/20/30)

The following procedure describes a normal optical SONET/SDH the test case on the IQS-8115/20/30 modules.

- For Next generation test case, see *Creating a Next Generation Test Case including VCAT/LCAS and GFP* on page 103.
- For IQS-8140, see *Creating an Optical SONET/SDH Test Case on an IQS-8140* on page 87.

To create an Optical SONET/SDH Test on an IQS-8115/20/30 module:

1. Test configuration:

- 1a.** Select the source **Clock Mode** that will be used for the test. Refer to *Clock Configuration* on page 129 for more information.
- 1b.** Select **Normal** as the **Test Mode**. Refer to *Test Configuration on page 126* for more information.
- 1c.** Select the **Coupled** check box to set the same settings for both the TX and RX signals or clear the **Coupled** check box to configure the TX and RX signal individually (decoupled).
- 1d.** Select the **Through** check box to loop the RX signal to the TX port. The **Clock Mode** is automatically set to **Recovered** when the **Through** check box is selected.
- 1e.** Select the **SONET/SDH Intrusive** check box to loop the RX signal to the TX port with TX overwrite capabilities. **SONET/SDH Intrusive** is not available on IQS-8115.
- 1f.** Leave the **OTN Intrusive** check box cleared. **OTN Intrusive** is not available on IQS-8115.
- 1g.** Press **Next**.

Test Config	
Test Name	TEST
Clock Mode	Internal
Test Mode	Normal
<input checked="" type="checkbox"/> Coupled	
<input type="checkbox"/> Through	
<input type="checkbox"/> OTN Intrusive	
<input type="checkbox"/> SONET/SDH Intrusive	

Creating and Starting a Test Case

Typical Test Cases

2. Interface connector selection:

2a. From the data path selector, press the **Optical** interface connector. **Optical** is automatically selected when **SONET/SDH Intrusive** check box is selected.



2b. For OC-192/STM-64 select **Framed** or **Unframed**. **Framed** is automatically selected in **Through** or decoupled mode. For all other optical interfaces, select **Framed**.

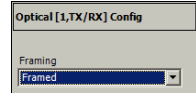

2c. For **Decoupled** test mode, both TX and RX ports have to be selected and configured:



First select the interface type for TX from the data path selector then proceed with the

rest of the test setup steps to set the test parameters for the TX interface. At the end, do not press **Finish** yet. Press **Back** to return to the RX/TX selection screen and select the interface type for RX from the data path selector then proceed with the rest of the test setup steps to set the test parameters for the RX interface.

2d. Press **Next**.

3. Interface selection:

3a. Press the desired interface: **OC-3, OC-12, OC-48, OC-192, STM-1, STM-4, STM-16, STM-64**. Choices depend on the rates available on the IQS-8115/20/30 module.

3b. Press **Next**. For OC-192/STM64 interface with **Unframed** mode, go to step 5.

4. Select the test Path/Mapping.

4a. From the Data Path Selector, select **Normal**.

4b. From the data path selector, press the desired path/mapping. Choices depend on the selected interface. See *Supported Paths/Mappings* on page 59 for more information.

4c. Press a timeslot from the **Grid** tab when applicable.

4d. For STS/STM and VT/AU mapping level, select the **Enable TCM** check box if needed.

4e. For DS_n/PDH mapping level, select the **Framing**. For more information, refer to *DS_n Tabs* or *PDH Tabs*.

1	2	3	4	5	6	7	8	9	10	11	12
13	14	15	16	17	18	19	20	21	22	23	24
25	26	27	28	29	30	31	32	33	34	35	36
37	38	39	40	41	42	43	44	45	46	47	48
49	50	51	52	53	54	55	56	57	58	59	60
61	62	63	64	65	66	67	68	69	70	71	72
73	74	75	76	77	78	79	80	81	82	83	84
85	86	87	88	89	90	91	92	93	94	95	96
97	98	99	100	101	102	103	104	105	106	107	108
109	110	111	112	113	114	115	116	117	118	119	120
121	122	123	124	125	126	127	128	129	130	131	132
133	134	135	136	137	138	139	140	141	142	143	144
145	146	147	148	149	150	151	152	153	154	155	156
157	158	159	160	161	162	163	164	165	166	167	168
169	170	171	172	173	174	175	176	177	178	179	180
181	182	183	184	185	186	187	188	189	190	191	192

Path Setup: Select a HOP size and position or Change the path type by selecting a VCG. Tree Grid

STS-1	STS-3c	STS-12c	STS-48c	STS-192c
Normal	LOP VCG-1 HOP VCG-1			

STS-1 [1,1] Config

Enable TCM

DS1 [1,1] Config

E1 [1,1] Config	DS3 Config
Framing PCM30	Framing C-Bit Parity
<input type="checkbox"/> Enable E0	<input type="checkbox"/> Enable FEAC
<input type="checkbox"/> Enable FDL	<input type="checkbox"/> Enable DS0

For DS3, select the **Enable FEAC** check box to allow far end alarm and control testing.

For DS1, select the **Enable FDL** check box to allow facility data link testing.

For DS1/E1, select the **Enable DS0/E0** check box to allow DS0 or E0 testing.

Creating and Starting a Test Case

Typical Test Cases

4f. For GFP, select the **UPI** (User Payload Identifier), **EXI** (Extension Header Identifier), and **CID** (Channel Identifier) parameters. GFP is available in Coupled test mode only. Refer to *GFP Frame TX* on page 432 for UPI and EXI, and to *GFP Channel TX* on page 435 for CID.

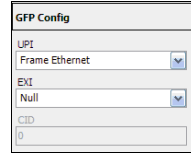

4g. For **External Ethernet**, which is available with GFP, select the interface and its rate. Refer to *GFP Client TX* on page 444 for more information. Go to step 8.

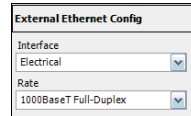

4h. For **Pattern**, go to step 5.

4i. Press Next or Finish.

4j. Repeat step 4 as required to complete the path/mapping. See *Supported Paths/Mappings* on page 59 for more information.

5. Pattern Configuration:

5a. Set the pattern parameters. Refer to *Pattern TX* on page 405 and *Pattern RX* on page 409 for more information.

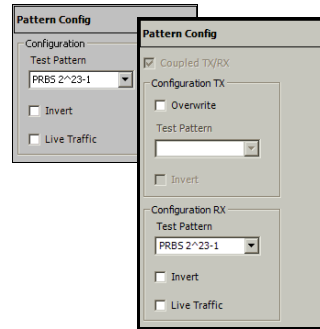

6. Press **Finish** to complete the test setup. The **Grid** tab closes and automatically switch to the **Alarm** summary tab.

7. For additional configuration parameters and results, refer to *Summary Tabs* on page 125, *Port Tabs* on page 137, *SONET Tabs* on page 211, *DSn Tabs* on page 269, *SDH Tabs* on page 303, *PDH Tabs* on page 369, *BERT Tabs* on page 405, *Advanced Tabs* on page 411, and *Common Tabs* on page 491. For **Unframed** mode, only **Summary**, **Port**, and **BERT** tabs are available.

8. Press the **Start** button to start the test. Refer to Global Test Status and Controls on page 35 for more information on test management.

Creating an Optical SONET/SDH Test Case on an IQS-8140

To create an Optical SONET/SDH Test on an IQS-8140:

1. Test configuration:

- 1a.** Select the source **Clock Mode** that will be used for the test. Refer to *Clock Configuration* on page 129 for more information.
- 1b.** Select **Normal** as the **Test Mode**. Refer to *Test Configuration on page 126* for more information.
- 1c.** Select the **Coupled** check box to set the same settings for both the TX and RX signals or clear the **Coupled** check box to configure the TX and RX signal individually (decoupled).
- 1d.** Select the **Through** check box to loop the RX signal to the TX port. The **Clock Mode** is automatically set to **Recovered** when the **Through** check box is selected.
- 1e.** Select the **SONET/SDH Intrusive** check box to loop the RX signal to the TX port with TX overwrite capabilities.
- 1f.** Leave the **OTN Intrusive** check box cleared.
- 1g.** Press **Next**.

The screenshot shows a 'Test Config' dialog box with the following fields and options:

- Test Name:** TEST
- Clock Mode:** Internal (dropdown menu)
- Test Mode:** Normal (dropdown menu)
- Coupled
- Through
- OTN Intrusive
- SONET/SDH Intrusive

Creating and Starting a Test Case

Typical Test Cases

2. Interface connector selection:

- 2a.** The **Optical** port is automatically selected. Select **Framed** or **Unframed**. **Framed** is automatically selected in **Through** or **decoupled** mode. For the IQS-8140-DPSK model, select the wavelength and invert the polarity if required (refer to *Wavelength (nm)* on page 148).

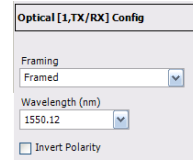

- 2b.** For **Decoupled** test mode, both TX and RX ports have to be selected and configured:

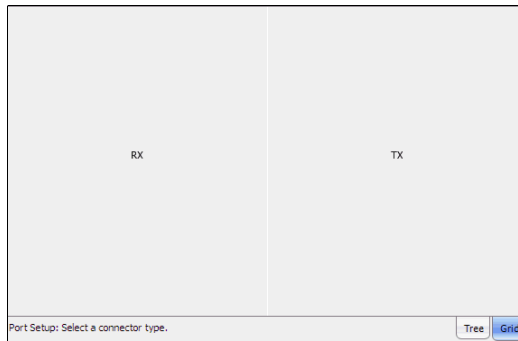

First select the interface type for TX from the data path selector then proceed with the

rest of the test setup steps to set the test parameters for the TX interface. At the end, do not press **Finish** yet. Press **Back** to return to the RX/TX selection screen and select the interface type for RX from the data path selector then proceed with the rest of the test setup steps to set the test parameters for the RX interface.

- 2c.** Press **Next**.

3. Interface selection.

- 3a.** Press the desired interface: **OC-768**, or **STM-256**.
- 3b.** Press **Next**. When **Unframed** is selected, press **Next** and go to step 5.

4. Select the test **Path/Mapping**

4a. From the data path selector, press the desired path/ mapping. Choices depend on the selected interface. See *Supported Paths/Mappings* on page 59 for more information.

4b. For **STS-1, STS-3c, STS-12c, AU-3, AU-4, and AU-4-4c** mapping, first select the timeslot group from the **Grid** tab.

To return to the timeslot group selection, press the **Full Grid** tab, then select a new group.

Select the timeslot from the **Details** tab.

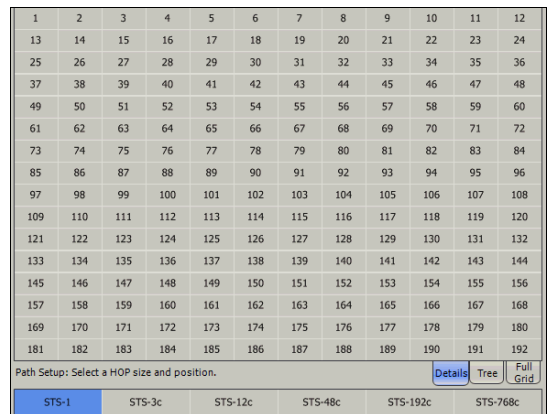
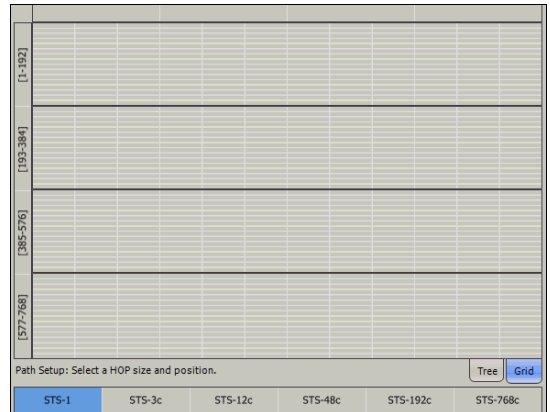

Creating and Starting a Test Case

Typical Test Cases

4c. For **STS-48c**, **STS-192c**, **AU-4-16c**, and **AU-4-64c**, select the timeslot from the **Grid** tab.

4d. For **STS-768c**, and **AU-4-256c** mapping, the timeslot is automatically selected in the **Grid** tab.

	1
	49
	97
	145
	193
	241
	289
	337
	385
	433
	481
	529
	577
	625
	673
	721

Path Setup: Select a HOP size and position. [Tree] [Grid]

STS-1 STS-3c STS-12c **STS-48c** STS-192c STS-768c

4e. Press Next or Finish.

5. Pattern Configuration:

5a. Set the pattern parameters. Refer to *Pattern TX* on page 405 and *Pattern RX* on page 409 for more information.

6. Press **Finish** to complete the test setup. The **Grid** tab closes and automatically switch to the **Alarm** summary tab.

7. For additional configuration parameters and results, refer to *Summary Tabs* on page 125, *Port Tabs* on page 137, *SONET Tabs* on page 211, *SDH Tabs* on page 303, *BERT Tabs* on page 405, *Advanced Tabs* on page 411, and *Common Tabs* on page 491. For **Unframed** mode, only **Summary**, **Port**, and **BERT** tabs are available.

8. Press the **Start** button to start the test. Refer to *Global Test Status and Controls* on page 35 for more information on test management.

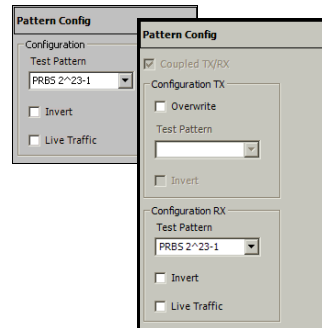

Creating an Optical SONET/SDH/OTN Multi-Channel SDT Test Case (IQS-8120/8130/8140)

The following procedure describes an optical SONET/SDH/OTN Multi-Channel test case on the IQS-8120, IQS-8120NG, IQS-8120NGE, IQS-8130, IQS-8130NG, IQS-8130NGE, and IQS-8140 modules.

To create an Optical SONET/SDH/OTN Multi-Channel Test:

1. Test configuration:

1a. Select **Multi-Channel SDT** as the **Test Mode**. Refer to Test Configuration on page 126 for more information.

1b. Press **Next**.

1c. The **Optical** port is automatically selected. Press **Next**.

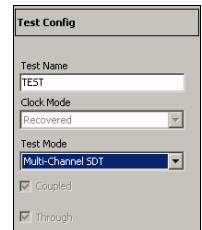

2. Interface selection:

2a. Press the desired interface: **OC-3, OC-12, OC-48, OC-192, OC-768, STM-1, STM-4, STM-16, STM-64, STM-256, OTU1, OTU2, OTU3**. Choices depend on the rates available on the module.

3. Press **Finish** to complete the test setup. The **Grid** tab closes and automatically switches to the **SDT - Monitor** tab.

4. For additional configuration parameters and results, refer to *Summary Tabs* on page 125 and *Service Disruption Time (SDT) - Results* on page 421.

5. Press the **Start** button to start the test. Refer to Global Test Status and Controls on page 35 for more information on test management.

Creating and Starting a Test Case

Typical Test Cases

Creating an OTN (OTU1 and OTU2) Test Case

The following procedure describes OTU1 and OTU2 test cases.

- For OTU1e and OTU2e, see *Creating an OTN Overclocked (OTU1e/OTU2e/OTU1f/OTU2f) Test Case (IQS-8130, IQS-8130NG, and IQS-8130NGE) on page 108.*
- For OTU3, see *Creating an OTN (OTU3) Test Case on page 97.*

To create an OTN Test on an IQS-8120, IQS-8120NG, IQS-8120NGE, IQS-8130, IQS-8130NG, or IQS-8130NGE module:

1. Test configuration:

- 1a.** Select the source **Clock Mode** that will be used for the test. Refer to *Clock Configuration on page 129* for more information.
- 1b.** Select **Normal** as the **Test Mode**. Refer to *Test Configuration on page 126* for more information.
- 1c.** Select the **Coupled** check box to set the same settings for both the TX and RX signals or clear the **Coupled** check box to configure the TX and RX signal individually (decoupled).
- 1d.** Select the **Through** check box to loop the RX signal to the TX port. The **Clock Mode** is automatically set to **Recovered** when the **Through** check box is selected.
- 1e.** Select the **OTN Intrusive** check box to loop the RX signal to the TX port with TX overwrite capabilities. Available when the **Coupled** check box is selected.
- 1f.** Leave the **SONET/SDH Intrusive** check box cleared.
- 1g.** Press **Next**.

Test Config	
Test Name	TEST
Clock Mode	Internal
Test Mode	Normal
<input checked="" type="checkbox"/> Coupled	
<input type="checkbox"/> Through	
<input type="checkbox"/> OTN Intrusive	
<input type="checkbox"/> SONET/SDH Intrusive	

2. Interface connector selection:

- 2a.** From the data path selector, press the **Optical** interface connector. **Optical** is automatically selected when **OTN Intrusive** check box is selected.



- 2b.** For OTU2 select **Framed** or **Unframed**. **Framed** is automatically selected in **Through** or **decoupled** mode. For OTU1, select **Framed**.

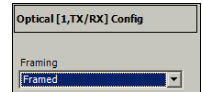

- 2c.** For **Decoupled** test mode, both TX and RX ports have to be selected and configured:



First select the interface type for TX from the data path selector then proceed with the

rest of the test setup steps to set the test parameters for the TX interface. At the end, do not press **Finish** yet. Press **Back** to return to the RX/TX selection screen and select the interface type for RX from the data path selector then proceed with the rest of the test setup steps to set the test parameters for the RX interface.

- 2d.** Press **Next**.

Creating and Starting a Test Case

Typical Test Cases

3. OTU Interface selection and configuration.

3a. Press **OTU1** or **OTU2**. Choices depend on the rates available on the Transport Blazer module.

3b. For OTU2 interface with **Unframed** mode, press **Next** and go to step 6.

3c. Select the **Enable FEC** and **Enable Scrambler** check boxes if needed. Refer to *FEC TX* on page 154 and *OTU TX* on page 157 for more information.

3d. Press **Next**.

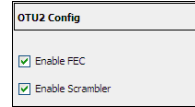

4. Select ODU TCM (TCM1 to TCM6) layers as required.

4a. Press Next or Finish.

5. Select the test **Path/Mapping**:

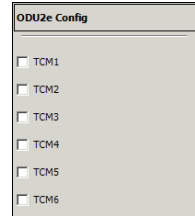

5a. From the data path selector, select the desired path/mapping. Choices depend on the selected interface. See *Supported Paths/Mappings* on page 59 for more information.

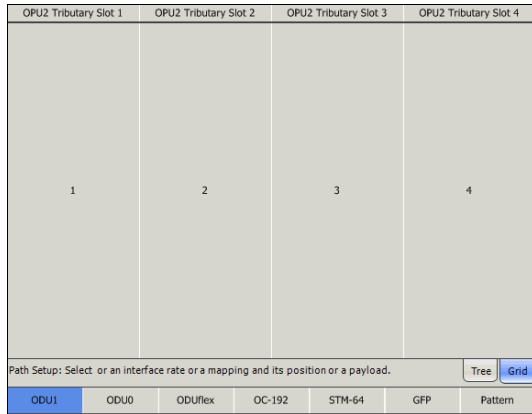

- 5b.** For ODU1 and ODU0, select a tributary slot, choices are:
 For ODU1 in ODU2: 1 of 4 OPU2 tributary slots
 For ODU0 in ODU2: 1 of 8 OPU2 tributary slots
 For ODU0 in ODU1: 1 of 2 OPU1 tributary slots.

Select ODU TCM (**TCM1 to TCM6**) layers as required. The **Tributary Port** associated to the selected tributary slot is displayed.

- 5c.** For ODUflex, select the OPU2 tributary slots (1 to 8), enable ODUflex TCM (**TCM1 to TCM6**) layers as required, and select the **Tributary Port** number (1 to 8) that will be associated to the selected tributary slots. The current bandwidth and the number of selected tributary slots are displayed.

- 5d.** For OC-x and STM-x, press **Next**.

- 5e.** For STS/VT/AU/TU mapping level, select the timeslot and enable **TCM** when required.

- 5f.** For GFP, the **UPI** and the **EXI** parameters are preset and not configurable. GFP is available in Coupled test mode only. Refer to *GFP Frame TX* on page 432 for more information.

- 5g.** For **10G Ethernet**, **Gb Ethernet**, or **Ethernet** in GFP, set the Ethernet parameters. Refer to *Configuration* on page 393 for more information.

- 5h.** Press **Next** or **Finish**.

Creating and Starting a Test Case

Typical Test Cases

6. Pattern Configuration:

- 6a.** Set the pattern parameters. Refer to *Pattern TX* on page 405 and *Pattern RX* on page 409 for more information.

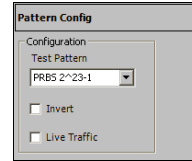

- 7.** Press **Finish** to complete the test setup. The **Grid** tab closes and automatically switch to the **Alarm** summary tab.
- 8.** For additional configuration parameters and results, refer to *Summary Tabs* on page 125, *Port Tabs* on page 137, *OTN Tabs* on page 153, *SONET Tabs* on page 211, *SDH Tabs* on page 303, *BERT Tabs* on page 405, *Advanced Tabs* on page 411, and *Common Tabs* on page 491. For **Unframed** mode, only **Summary**, **Port**, and **BERT** tabs are available.
- 9.** Press the **Start** button to start the test. Refer to *Global Test Status and Controls* on page 35 for more information on test management.

Creating an OTN (OTU3) Test Case

To create an OTN Test on an IQS-8140 module:

1. Test configuration:

- 1a.** Select the source **Clock Mode** that will be used for the test. Refer to *Clock Configuration* on page 129 for more information.
- 1b.** Select **Normal** as the **Test Mode**. Refer to *Test Configuration on page 126* for more information.
- 1c.** Select the **Coupled** check box to set the same settings for both the TX and RX signals or clear the **Coupled** check box to configure the TX and RX signal individually (decoupled).
- 1d.** Select the **Through** check box to loop the RX signal to the TX port. The **Clock Mode** is automatically set to **Recovered** when the **Through** check box is selected.
- 1e.** Select the **OTN Intrusive** check box to loop the RX signal to the TX port with TX overwrite capabilities. Available when the **Coupled** check box is selected.
- 1f.** Leave the **SONET/SDH Intrusive** check box cleared.
- 1g.** Press **Next**.

The screenshot shows a 'Test Config' dialog box with the following fields and options:

- Test Name: TEST
- Clock Mode: Internal
- Test Mode: Normal
- Coupled
- Through
- OTN Intrusive
- SONET/SDH Intrusive

Creating and Starting a Test Case

Typical Test Cases

2. Interface connector selection:

The **Optical** port is automatically selected.

2a. Select **Framed** or **Unframed**. **Framed** is automatically selected in **Through** or decoupled mode.

For the IQS-8140-DPSK model, select the wavelength and invert the polarity if required (refer to *Wavelength (nm)* on page 148).

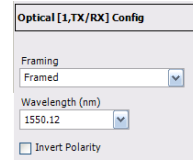

2b. For **Decoupled** test mode, both TX and RX ports have to be selected and configured:

First select the interface type for TX from the data path selector then proceed with the



rest of the test setup steps to set the test parameters for the TX interface. At the end, do not press **Finish** yet. Press **Back** to return to the RX/TX selection screen and select the interface type for RX from the data path selector then proceed with the rest of the test setup steps to set the test parameters for the RX interface.

2c. Press **Next**.

3. Interface selection and configuration.

3a. Press the **OTU-3** interface.

3b. When **Unframed** is selected, press **Next** and go to step 5.

3c. Select the **Enable FEC** and **Enable Scrambler** check boxes if needed (refer to *FEC TX* on page 154 and *OTU TX* on page 157).

3d. Press **Next**.

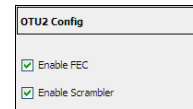

4. TCM Configuration:

4a. Select ODU TCM (**TCM1** to **TCM6**) layers as required

4b. Press Next or Finish.

5. Select the test **Path/Mapping**:

5a. From the data path selector, select the desired path/ mapping. See *Supported Paths/Mappings* on page 59 for more information.

5b. For ODU2, select ODU TCM (**TCM1** to **TCM6**) layers as required.

Select a group of four OPU3 tributary slots.
Choices are 1 to 16:

When the **Fixed Structure** check box is selected, the selection of a tributary slot will automatically select four tributary slots (from the same column) which constitute the foreground traffic. Choices are (1,5,9,13), (2, 6, 10, 14), (3, 7, 11,15), and (4, 8, 13, 16). Note that the **Tributary Port** number is automatically assigned.

When the **Fixed Structure** check box is cleared, select the four tributary slots individually, and select the **Tributary Port** number (1, 2, 3, or 4) that will be associated to the selected tributary slots.

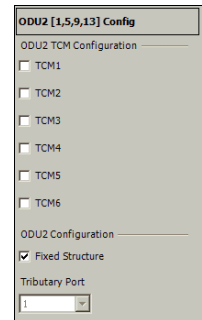
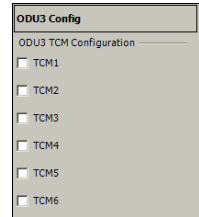

Creating and Starting a Test Case

Typical Test Cases

- 5c.** For ODU1 and ODU0, select a tributary slot, choices are:
For ODU1 in ODU3: 1 of 16 OPU3 tributary slots
For ODU1 in ODU2: 1 of 4 OPU2 tributary slots
For ODU0 in ODU3: 1 of 32 OPU3 tributary slots
For ODU0 in ODU2: 1 of 8 OPU2 tributary slots
For ODU0 in ODU1: 1 of 2 OPU1 tributary slots.

Select ODU TCM (**TCM1 to TCM6**) layers as required. The **Tributary Port** associated to the selected tributary slot is displayed.

- 5d.** For ODUFlex, select the OPU3 tributary slots (1 to 32), enable ODUFlex TCM (**TCM1 to TCM6**) layers as required, and select the **Tributary Port** number (1 to 32) that will be associated to the selected tributary slots. The current bandwidth and the number of selected tributary slots are displayed.

- 5e.** For OC-x and STM-x, press **Next**.

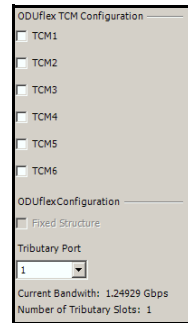
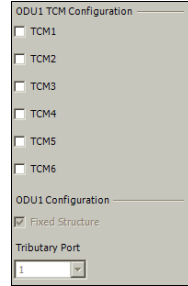

5f. For **STS-1, STS-3c, STS-12c, STS-48c, STS-192c, AU-3, AU-4, AU-4-4c, AU-4-16c, AU-4-64c** mapping, select the timeslot from the **Grid** tab.

1	2	3	4	5	6	7	8	9	10	11	12
13	14	15	16	17	18	19	20	21	22	23	24
25	26	27	28	29	30	31	32	33	34	35	36
37	38	39	40	41	42	43	44	45	46	47	48
49	50	51	52	53	54	55	56	57	58	59	60
61	62	63	64	65	66	67	68	69	70	71	72
73	74	75	76	77	78	79	80	81	82	83	84
85	86	87	88	89	90	91	92	93	94	95	96
97	98	99	100	101	102	103	104	105	106	107	108
109	110	111	112	113	114	115	116	117	118	119	120
121	122	123	124	125	126	127	128	129	130	131	132
133	134	135	136	137	138	139	140	141	142	143	144
145	146	147	148	149	150	151	152	153	154	155	156
157	158	159	160	161	162	163	164	165	166	167	168
169	170	171	172	173	174	175	176	177	178	179	180
181	182	183	184	185	186	187	188	189	190	191	192

Path Setup: Select a HOP size and position. Details Tree Full Grid

STS-1 STS-3c STS-12c STS-48c STS-192c STS-768c

However, for **STS-1, STS-3c, STS-12c, AU-3, AU-4, and AU-4-4c** in OC-768/STM-256 mapping level, first select the timeslot group from the **Grid** tab.

To return to the timeslot group selection, press the **Full Grid** tab, then select a new group.

[1-192]											
[193-384]											
[385-576]											
[577-768]											

Path Setup: Select a HOP size and position. Tree Grid

STS-1 STS-3c STS-12c STS-48c STS-192c STS-768c

5g. For GFP, the **UPI** and the **EXI** parameters are preset and not configurable. GFP is available in Coupled test mode only. Refer to *GFP Frame TX* on page 432 for more information.

GFP Config	
UPI	
EXI	Framed 64B/66B Ethernet
CID	Null

Creating and Starting a Test Case

Typical Test Cases

- 5h.** For **10G Ethernet**, **Gb Ethernet**, and **Ethernet** in GFP, set the Ethernet parameters. Refer to *Configuration* on page 393 for more information.
- 5i.** Press Next or Finish.
- 6.** Pattern Configuration:
- 6a.** Set the pattern parameters. Refer to *Pattern TX* on page 405 and *Pattern RX* on page 409 for more information.
- 7.** Press **Finish** to complete the test setup. The **Grid** tab closes and automatically switch to the **Alarm** summary tab.
- 8.** For additional configuration parameters and results, refer to *Summary Tabs* on page 125, *Port Tabs* on page 137, *OTN Tabs* on page 153, *SONET Tabs* on page 211, *SDH Tabs* on page 303, *BERT Tabs* on page 405, *Advanced Tabs* on page 411, and *Common Tabs* on page 491. For **Unframed** mode, only **Summary**, **Port**, and **BERT** tabs are available.
- 9.** Press the **Start** button to start the test. Refer to *Global Test Status and Controls* on page 35 for more information on test management.

The screenshot shows the '10G Ethernet Config' dialog box. It contains the following fields and options:

- Frame Size (Bytes): 64
- Tx Rate (%): 100.0
- Source MAC Address: 00:03:01:08:36:DD
- Destination MAC Address: FE:FE:FE:FE:FE:FE
- VLAN
- ID: [Empty field]
- Type: [Empty field]
- Priority: [Dropdown menu]

The screenshot shows the 'Pattern Config' dialog box. It contains the following fields and options:

- Configuration: [Empty field]
- Test Pattern: PRBS 2^23-1
- Invert
- Live Traffic

Creating a Next Generation Test Case including VCAT/LCAS and GFP

The following procedure describes a Next Generation test case, including VCAT/LCAS and GFP.

To create a Next Generation Test Case on an IQS-8120NG, IQS-8120NGE, IQS-8130NG, or IQS-8130NGE module:

1. Test configuration:

- 1a.** Select the source **Clock Mode** that will be used for the test. Refer to Clock Configuration on page 129 for more information.
- 1b.** Select **Normal** as the **Test Mode**. Refer to Test Configuration on page 126 for more information.
- 1c.** Leave the **Coupled** check box selected.
- 1d.** Select the **Through** check box to loop the RX signal to the TX port. The **Clock Mode** is automatically set to **Recovered** when the **Through** check box is selected.
- 1e.** Select the **SONET/SDH Intrusive** check box to loop the RX signal to the TX port with TX overwrite capabilities. Available when the **Coupled** check box is selected.
- 1f.** Leave the **OTN Intrusive** check box cleared.
- 1g.** Press **Next**.

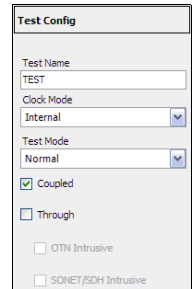

2. Interface connector selection:

- 2a.** From the data path selector, press the **Optical** interface connector. **Optical** is automatically selected when **SONET/SDH Intrusive** check box is selected.
- 2b.** For OC-192/STM-64 leave the **Framing** selection to **Framed**.

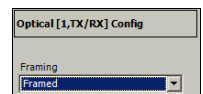

Creating and Starting a Test Case

Typical Test Cases

3. Interface selection.

3a. Press the desired interface: **OC-3, OC-12, OC-48, OC-192, STM-1, STM-4, STM-16, STM-64, OTU1, or OTU2.** However, for the **OTU1** and **OTU2** interfaces, OC-N/STM-N must be part of the test path (refer to *Creating an OTN (OTU1 and OTU2) Test Case*). Choices depend on the rates available on the module.

3b. Press **Next**.

4. Select the test **Path/Mapping**.

4a. From the data path selector, select **LOP VCG-1** or **HOP VCG-1**.

4b. Press the desired path/ mapping. See *Supported Paths/Mappings* on page 59 for more information.

1	2	3	4	5	6	7	8	9	10	11	12
13	14	15	16	17	18	19	20	21	22	23	24
25	26	27	28	29	30	31	32	33	34	35	36
37	38	39	40	41	42	43	44	45	46	47	48
49	50	51	52	53	54	55	56	57	58	59	60
61	62	63	64	65	66	67	68	69	70	71	72
73	74	75	76	77	78	79	80	81	82	83	84
85	86	87	88	89	90	91	92	93	94	95	96
97	98	99	100	101	102	103	104	105	106	107	108
109	110	111	112	113	114	115	116	117	118	119	120
121	122	123	124	125	126	127	128	129	130	131	132
133	134	135	136	137	138	139	140	141	142	143	144
145	146	147	148	149	150	151	152	153	154	155	156
157	158	159	160	161	162	163	164	165	166	167	168
169	170	171	172	173	174	175	176	177	178	179	180
181	182	183	184	185	186	187	188	189	190	191	192

Path Setup: Select a HOP size and position. Tree Grid

STS-1	
Normal	LOP VCG-1 HOP VCG-1

For LOP VCG-1, **STS-1** is automatically

selected for SONET and choices are **AU-3** and **AU-4** for SDH.

For HOP VCG-1, choices are **STS-1-Xv** and **STS-3c-Xv** for SONET, **VC-3-Xv** and **VC-4-Xv** for SDH.

4c. VCG configuration:

Enable LCAS: Allows enabling LCAS configuration. This setting is disabled by default.

Add Member(s) at Start: Allows enabling by default all the new members that will be selected for this VCG group. The activation can be done individually for the Source and Sink. This default setting can further be overwritten individually for each member that will be added to the group (See *Auto Add at Startup* on page 106). All members enabled will be automatically added (applied) when the test is started. This setting is disabled by default unless otherwise set from the *LCAS Auto-Add at Startup* on page 542.

Remote DUT: Non-LCAS Specifies that the remote device connected to the IQS-8115/20/30 is LCAS (when disabled) or Non-LCAS (when enabled).

Group Size indicates the type and size of the VCG members as well as the bandwidth used by the VCG group.

- 4d. For **LOP VCG-1**, press a first STS-1/AU timeslot, press **Next**, select the VT/TU mapping, press every LOP timeslot that need to become VCG member of the selected STS-1/AU timeslot.
- 4e. For **HOP VCG-1**, press a first timeslot that need to become a VCG member.

Creating and Starting a Test Case

Typical Test Cases

- 4f.** Configure the following VCG parameters:

Set the **SQ** and **ExSQ** number (when **LCAS** is not enabled) or set the **Auto Add at Startup** (when **LCAS** is enabled) for each timeslot selected.

SQ: The **SQ** number of each member can be changed when **LCAS** is not enabled. Press a specific member **SQ** number and enter the new number. Possible values are from **0** to **63**.

ExSQ: The **ExSQ** number of each member can be changed when **LCAS** is not enabled. Press a specific member **ExSQ** number and enter the new number. Possible values are from **0** to **63**.

Auto Add at Startup: Enables the selected member to be automatically added (applied) when the test is started. The activation can be done individually for the Source and Sink. Only available when **LCAS** is enabled. This setting is disabled by default unless otherwise set from either the **Add Member(s) at Start** on page 105 or *LCAS Auto-Add at Startup* on page 542.

Group Size indicates the type and size of the VCG members as well as the bandwidth used by the VCG group.

- 4g.** To add another timeslot to the VCG group:

For **LOP VCG-1**, press **Back**, select another STS-1/AU timeslot, press **Next** then press and configure (see step 4f) every LOP timeslot that need to become VCG member of the selected STS-1/AU timeslot

For **HOP VCG-1**, select another timeslot and configure its parameters as described in the step 4f.

- 4h.** Repeat step 4g to add more timeslot to the LOP/HOP VCG group.
4i. Press Next or Finish.

STS-1-Xv [1,1] Config

SQ
0

ExS
0

Add Member(s) at Start

Source (Default)

Sink (Default)

Group Size

STS-1-3v = 145.152 Mbps

5. Select the payload: **GFP** or **Pattern**.

- 5a.** For **GFP**, select the **UPI**, **EXI**, and **CID** parameters. GFP is available in Coupled test mode only. Refer to *GFP Frame TX* on page 432 for UPI and EXI, and to *GFP Channel TX* on page 435 for CID. Press Next or Finish.

GFP Config	
UPI	Frame Ethernet
EXI	Null
CID	0

- 5b.** For **Pattern**, go to step 7.

6. Select the GFP payload: **Pattern** or **External Ethernet**.

- 6a.** For **External Ethernet**, which is available with GFP, select the interface and its rate. Refer to *GFP Client TX* on page 444 for more information. Go to step 8.

External Ethernet Config	
Interface	Electrical
Rate	1000BaseT Full-Duplex

- 6b.** For **Pattern**, go to step 7.

7. Pattern Configuration:

- 7a.** Set the pattern parameters. Refer to *Pattern TX* on page 405 and *Pattern RX* on page 409 for more information.

Pattern Config	
Configuration	
Test Pattern	PRBS 2 ²³ -1
<input type="checkbox"/>	Invert
<input type="checkbox"/>	Live Traffic

- 8.** Press **Finish** to complete the test setup. The **Grid** tab closes and automatically switch to the **Alarm** summary tab.
- 9.** For additional configuration parameters and results, refer to *Summary Tabs* on page 125, *Port Tabs* on page 137, *OTN Tabs* on page 153, *SONET Tabs* on page 211, *SDH Tabs* on page 303, *BERT Tabs* on page 405, *Advanced Tabs* on page 411, and *Common Tabs* on page 491.
- 10.** Press the **Start** button to start the test. Refer to Global Test Status and Controls on page 35 for more information on test management.

Creating an OTN Overclocked (OTU1e/OTU2e/OTU1f/OTU2f) Test Case (IQS-8130, IQS-8130NG, and IQS-8130NGE)

To create an OTN overclocked test on an IQS-8130, IQS-8130NG, or IQS-8130NGE module:

1. Test configuration:

- 1a.** Select the source **Clock Mode** that will be used for the test. Refer to *Clock Configuration* on page 129 for more information.
- 1b.** Select **Normal** as the **Test Mode**. Refer to *Test Configuration on page 126* for more information.
- 1c.** Make sure the **Coupled** check box is selected.
- 1d.** Select the **Through** check box to loop the RX signal to the TX port. The **Clock Mode** is automatically set to **Recovered** when the **Through** check box is selected.
- 1e.** Select the **OTN Intrusive** check box to loop the RX signal to the TX port with TX overwrite capabilities.
- 1f.** Leave the **SONET/SDH Intrusive** check box cleared.
- 1g.** Press **Next**.

The image shows a 'Test Config' dialog box with the following fields and options:

- Test Name:** A text input field containing the word 'TEST'.
- Clock Mode:** A dropdown menu currently set to 'Internal'.
- Test Mode:** A dropdown menu currently set to 'Normal'.
- Coupled:** A checked checkbox.
- Through:** An unchecked checkbox.
- OTN Intrusive:** An unchecked checkbox.
- SONET/SDH Intrusive:** An unchecked checkbox.

2. Interface connector selection:

2a. From the data path selector, press the



Optical interface connector. **Optical** is automatically selected when **OTN Intrusive** check box is selected.

2b. Select **Framed** or **Unframed**. **Framed** is automatically selected in **Through** or **decoupled** mode.

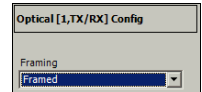

2c. Press **Next**.

3. Interface selection and configuration:

3a. Press the desired interface: **OTU1e (11.049G)**, **OTU2e (11.096G)**, **OTU1f (11.270G)** or **OTU2f (11.317G)**.

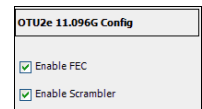

3b. When **Unframed** is selected, press **Next** and go to step 6.

3c. Select the **Enable FEC** and **Enable Scrambler** check boxes if needed. Refer to *FEC TX* on page 154 and *OTU TX* on page 157 for more information.

3d. Press **Next**.

4. Select ODU TCM (**TCM1** to **TCM6**) layers as required and press **Next** or **Finish**.

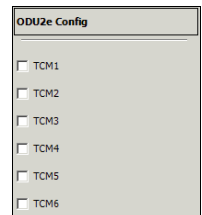

Creating and Starting a Test Case

Typical Test Cases

5. For OTU1e/OTU2e, if required, select **10G Ethernet** as the mapping and set the Ethernet parameters. Refer to *Configuration* on page 393 for more information.

The 10G Ethernet link status is available from the **Tree** tab.

- 5a. Press Next or Finish.

6. Pattern Configuration:

- 6a. Set the pattern parameters. Refer to *Pattern TX* on page 405 and *Pattern RX* on page 409 for more information.

7. Press **Finish** to complete the test setup. The **Grid** tab closes and automatically switch to the **Alarm** summary tab.
8. For additional configuration parameters and results, refer to *Summary Tabs* on page 125, *Port Tabs* on page 137, *OTN Tabs* on page 153, *Ethernet Tabs* on page 393 (OTU1e/OTU2e only), *BERT Tabs* on page 405, and *Advanced Tabs* on page 411. For **Unframed** mode, only **Summary**, **Port**, and **BERT** tabs are available.
9. Press the **Start** button to start the test. Refer to Global Test Status and Controls on page 35 for more information on test management.

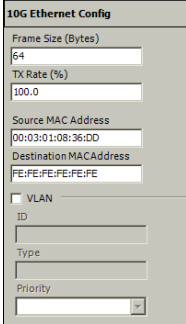

The screenshot shows the '10G Ethernet Config' dialog box. It contains the following fields and options:

- Frame Size (Bytes): 64
- TX Rate (%): 100.0
- Source MAC Address: 00:03:01:08:36:DD
- Destination MAC Address: FE:FE:FE:FE:FE:FE
- VLAN
- ID: [Empty field]
- Type: [Empty field]
- Priority: [Dropdown menu]

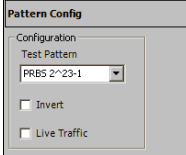

The screenshot shows the 'Pattern Config' dialog box. It contains the following fields and options:

- Configuration: [Empty field]
- Test Pattern: PRBS 2^23-1
- Invert
- Live Traffic

7 **Smart Mode**

SmartMode allows to automatically identify the structure of the selected SONET/SDH signal rate that is connected to the **Transport Blazer** module. The identified signal structure can then, be used to simplify the setup of a test case. **SmartMode** allows also to monitor the basic SONET/SDH alarms/errors of each layer of the discovered signal structure.

Note: *SmartMode is not available when a test is running. No other test functions are available when SmartMode is running (Smart Scan, Trib Scan or Alarm Scan). **SmartMode** is not available on the IQS-8140.*

The **Smart Mode** window is displayed by default when the GUI is started

The following sections describe the **SmartMode** usage:

- *SmartMode Interface Description* on page 112
- *Using SmartMode for Alarm/Error Monitoring* on page 115
- *Creating and Starting a Test Case Using SmartMode* on page 122
- *Legend* on page 123

Smart Mode

SmartMode Interface Description

SmartMode Interface Description

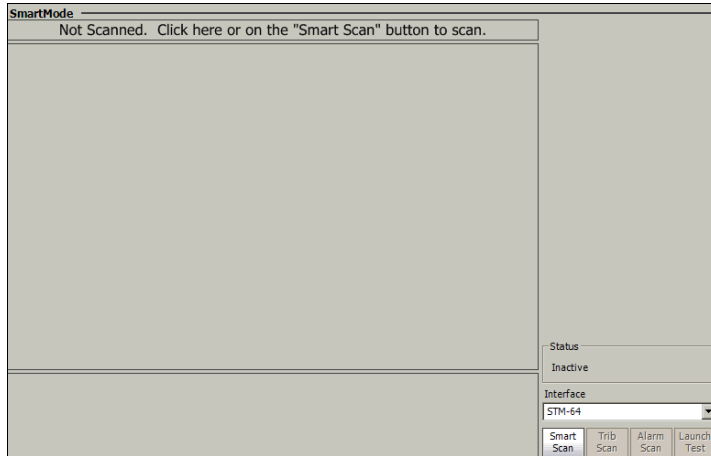

- **Not Scanned. Click here or on the Smart Scan button to scan and Smart Scan:** Allows starting the signal scan of the selected interface to discover the high order path (HOP) signal structure. Make sure that the selected interface rate corresponds to the interface connected to the module. A **Smart Scan** takes about 5 seconds to discover the signal structure. This button gives the same result as the **Smart Scan** button but it is only available the first time the **SmartMode** is run.

- **Status:** Indicates the status of the **SmartMode**. Possible choices are:
 - Stopped** indicates that **SmartMode** did not run yet.
 - Inactive** indicates that **SmartMode** is not running or not available.
 - Smart Scan In-Progress** indicates that the **Smart Scan** is scanning the selected/connected signal. Once the signal has been scanned, the **Alarm Scan In-Progress** message is displayed indicating that the **Alarm Scan** is running.
 - Trib Scan In-Progress** indicates that the **Trib Scan** is discovering the LOPs of the selected timeslot. Once the tributaries have been discovered, the **Alarm Scan In-Progress** message is displayed indicating that the Alarm Scan is running.
 - Alarm Scan In-Progress** indicates that the **Alarm Scan** is continuously scanning the alarms/errors.

- **Interface:** Allows the selection of the SONET/SDH interface connected to the module that will be used for the **Smart Scan**. Choices are:
 - For SONET: **STS-1e**, **STS-3e**, **OC-3**, **OC-12**, **OC-48**, **OC-48 (OTU1)**, **OC-192**, and **OC-192 (OTU2)**.
 - For SDH: **STM-0e**, **STM-1e**, **STM-1**, **STM-4**, **STM-16**, **STM-16 (OTU1)**, **STM-64**, and **STM-64 (OTU2)**.

Choices depend on the rates available on the IQS-8100 Series module. The default setting is the highest rate supported by the module. The default highest rate will be SONET when both SONET and SDH are supported by the module. OTU1 and OTU2 structures are not scanned, only the SONET/SDH part of the OTN signal is scanned.

- **Smart Scan** button: Allows starting the signal scan of the selected interface to discover the high order path (HOP) signal structure. Make sure that the selected interface rate corresponds to the interface connected to the module. A Smart Scan takes about 5 seconds to discover the signal structure. The Smart Scan button gives the same result as the **Not Scanned**. **Click here or on the “Smart Scan” button to scan** button.

Smart Mode

SmartMode Interface Description

- **Trib Scan** button: Allows starting the **Trib Scan** of the selected HOP to discover its low order path (LOP) information. This button is only available when the selected timeslot contains LOPs (VT/TU/TUG equipped). A **Trib Scan** takes about 5 seconds to discover the signal structure.
- **Alarm Scan** button: Allows to monitor the **Port, Section/MS, Line/RS, HOP**, and **LOP** alarms and errors. **Alarm Scan** is automatically started after a successful **Smart Scan** or **Trib Scan**. **Alarm Scan** displays the information of the selected timeslot or tributary. The alarm scan monitors in parallel all the HOPs discovered during the scan as well as the LOPs of the selected HOP.
- **Launch Test**: Allows creating and starting the test case based on the scanned signal for the selected path. This automatically stops the **Alarm Scan** and disables the **SmartMode** functionality with the exception of the **Report**. To re-enable access to the **SmartMode** functions, the test must be cleared.

Note that the default test preferences will be used for the test. For example, the laser will be Off if not enabled from the *Default Test Preferences* on page 530. However, the laser can be enabled once the test is started from the Test Setup or from the **Port TX** tab; first stop the test, enable the laser and re-start the test.

Using SmartMode for Alarm/Error Monitoring

Note: The default test preferences will be used for alarm/error monitoring. Refer to Default Test Preferences on page 530 for the list of test preferences.

To monitor alarms/errors using SmartMode:

1. Select the OTN/SONET/SDH signal interface rate corresponding to the signal connected to the module.
2. Press either the **Not Scanned**. [Click here](#) or on the “**Smart Scan**” button to scan or the **Smart Scan** button.

The structure of the signal is displayed when the scan succeeds; otherwise, a LOS is declared and a red border appears around the signal button. If the scan failed, make sure the selected interface rate corresponds to the signal connected to the module.

Signal button →

The screenshot displays the SmartMode interface for an STM-64 signal. The main area shows a hierarchical signal structure diagram with components like VCG, AU-3, AU-4, and AU-4-16c. A red border highlights the 'Signal button' (VCG) in the top-left corner. The right-hand panel provides 'Alarm Analysis' for the STM-64 signal, showing 'H: C' status, 'Frequency' (9953280000 bps), 'Range (dBm)' (-25.5 to -5.5), and 'Power (dBm)' (-4.9). The 'Status' section indicates 'Alarm Scan In-Progress...'. At the bottom, there are buttons for 'Smart Scan', 'Trib Scan', 'Alarm Scan', and 'Launch Test'.

Frequency indicates current and history frequency alarm. Refer to *Port RX (Optical Interfaces)* on page 150 for more information.

LOS indicates current and history LOS alarm. Refer to *Port RX (Optical Interfaces)* on page 150 for more information.

Smart Mode

Using SmartMode for Alarm/Error Monitoring

Range indicates the minimum and maximum optical power values necessary to meet the standard BER for the test interface.

Power indicates the power level of the input signal in dBm. The background color of the **Power** field indicates the input presence as follow:

Background color	Description
Green	Power level in-range.
Yellow	Power level out of operational range.
Red	Power level crosses the “Close-to-damage” threshold.
Grey	LOS or invalid operational range value reported by the optical device (SFP/XFP).

Frequency (bps) indicates the received signal frequency in bps.

Note: *The port statistics are only refreshed (live) when the alarm scan is running.*

3. To see the **Section/RS/Line/RS/MS** analysis, press the signal button and press the **Section/Line/RS/MS** tab.

J0 Trace indicates the J0 Trace value. Refer to *J0 Trace* on page 220 (SONET) or page 310 (SDH) for more information.

B1, LOF and **SEF** indicates Section/RS alarms/errors. Refer to *Section RX (SONET)* on page 219 and *Regenerator Section RX (SDH)* on page 311 for more information.

Synchronization Status message indicates the received synchronization status of the NE. Refer to *APS/Advanced Line OH TX/RX (SONET)* on page 236 and *Multiplex Section APS/Advanced OH TX/RX (SDH)* on page 328 for more information.

B2, REI-L, AIS-L, and RDI-L indicates **Line/MS** alarms/errors. Refer to *Line RX (SONET)* on page 228 and *Multiplex Section RX (SDH)* on page 320 for more information.

Smart Mode

Using SmartMode for Alarm/Error Monitoring

4. Selection of a timeslot for alarm/error analysis

Press a timeslot to select it. The alarms/errors displayed correspond to the selected timeslot. The following screen is displayed when a timeslot is selected. To return to the signal analysis, press the signal button.

The screenshot shows the SmartMode interface for STM-64. The main area is a grid of timeslots. The second row, second column (AU-3) is highlighted in red and labeled 'Selected Timeslot'. The first row, second column (VCG) is labeled 'Signal button'. The first row, first column (VCG) is labeled 'Structured Payload'. The right-hand panel shows details for the selected timeslot 'AU-3 [1,1,1,1]'. It includes sections for Error Analysis, Alarm Analysis, Path Signal Label (C2), J1 Trace, Status, and Interface. The Interface dropdown is set to STM-64. At the bottom right, there are buttons for Smart Scan, Trib Scan, Alarm Scan, and Launch Test.

STM-64											
VCG	VCG	AU-3	VCG	VCG	AU-3	VCG	VCG	AU-3	VCG	VCG	AU-3
AU-3	AU-3	AU-3	AU-3	AU-3	AU-3	AU-3	AU-3	AU-3	AU-3	AU-3	AU-3
VCG	AU-4			AU-4			VCG			VCG	
AU-4				AU-4			VCG			AU-4	
AU-4-4c											
AU-4			AU-4		?	?	?	?	?	?	?
AU-4			AU-4				AU-4			AU-4	
AU-4			AU-4				AU-4			AU-4	
AU-4-16c											
AU-4-16c											

SmartMode

AU-3 [1,1,1,1]

Error Analysis
H: C H: C
● B3 ● HP-REI

Alarm Analysis
● AU-AIS ● ERDI-SD
● AU-LOP ● ERDI-PD
● HP-RDI ● ERDI-CD
● H4-LOM

Path Signal Label (C2)
Reserved (Equipped Non-Specific)

J1 Trace
HO-SmartMode
Demo N₀₁ N₀₂ N₀₃ N₀₄ N₀₅ N₀₆ N₀₇ N₀₈ N₀₉ N₁₀ N₁₁ N₁₂ N₁₃ N₁₄ N₁₅ N₁₆ N₁₇ N₁₈ N₁₉ N₂₀ N₂₁ N₂₂ N₂₃ N₂₄ N₂₅ N₂₆ N₂₇ N₂₈ N₂₉ N₃₀ N₃₁

Last Alarm Scan Date
--

Status
Alarm Scan In-Progress...

Interface
STM-64

Smart Scan Trib Scan Alarm Scan Launch Test

Timeslot indicates the selected path number being monitored.

Error Analysis gives current and history status of the main errors. Refer to *SONET Tabs* on page 211 or *SDH Tabs* on page 303 for the error descriptions.

Alarm Analysis gives current and history status of the main alarms. Refer to *SONET Tabs* on page 211 or *SDH Tabs* on page 303 for the alarm descriptions.

Last Alarm Scan Date indicates the date and time of the last **Alarm Scan**. The date is only displayed when the **Alarm Scan** is stopped.

Path Signal Label (C2) indicates the path signal label of the selected timeslot. Refer to *Path Signal Label (C2)* on page 256 (SONET) or page 346 (SDH) for more information.

J1 Trace indicates the J1 Trace value of the selected timeslot. Refer to *J1 Trace* on page 253 (SONET) or page 366 (SDH) for more information.

- For VT/TUG structured payload, press VT/TUG structured payload timeslot then, press **Not Scanned**. **Click here or on the “Trib Scan” button to scan or Trib Scan**. The LOP tributaries are displayed.

The screenshot shows the SmartMode interface for an STM-64 interface. The main table displays a grid of timeslots with labels like VCG, AU-3, AU-4, and AU-4-16c. A red box highlights the 'VCG' label in the first row. The right-hand panel contains several sections: 'AU-4 [1,4,1,0]', 'Error Analysis' (with H and C indicators), 'Alarm Analysis' (with various status icons), 'Path Signal Label (C2)', 'TUG structure', 'J1 Trace', and 'Last Alarm Scan Date'. At the bottom right, there are buttons for 'Smart Scan', 'Trib Scan', 'Alarm Scan', and 'Launch Test'. A message at the bottom of the main area reads: 'Not Scanned. Click here or on the "Trib Scan" button to scan.'

Smart Mode

Using SmartMode for Alarm/Error Monitoring

Press an LOP tributary then, the following tributary analysis is displayed.

The screenshot displays the SmartMode interface for STM-64. The main grid shows a hierarchy of units: VCG, AU-3, and AU-4. A specific AU-4-16c unit is expanded to show a grid of TU-11 and TU-12 units. The right-hand panel provides detailed analysis for the selected TU-11 [1,1,1].

Tributary (TU-11 [1,1,1])

Selected Tributary (TU-11)

Error Analysis

H	C		
●	●	BIP-2	LP-REI

Alarm Analysis

●	●	TU-AIS	ERDI-SD
●	●	TU-LOP	ERDI-PD
●	●	LP-RDI	ERDI-CD

Path Signal Label (V5)

Reserved (Equipped Non-Specific)

Extended Signal Label

Reserved

32 Trace

LO-SmartMode

Demo^{N₀₁} N₀₂ N₀₃ N₀₄ N₀₅ N₀₆ N₀₇ N₀₈ N₀₉ N₁₀ N₁₁ N₁₂ N₁₃ N₁₄ N₁₅ N₁₆ N₁₇ N₁₈ N₁₉ N₂₀ N₂₁ N₂₂ N₂₃ N₂₄ N₂₅ N₂₆ N₂₇ N₂₈ N₂₉ N₃₀ N₃₁ N₃₂

Last Alarm Scan Date

--

Status

Alarm Scan In-Progress...

Interface

STM-64

Smart Scan Trib Scan Alarm Scan Launch Test

Tributary indicates the selected timeslot or the number associated to the virtual tributary or tributary unit.

Error Analysis gives current and history status of the main errors. Refer to *SONET Tabs* on page 211 or *SDH Tabs* on page 303 for the error descriptions.

Alarm Analysis gives current and history status of the main alarms. Refer to *SONET Tabs* on page 211 or *SDH Tabs* on page 303 for the alarm descriptions.

Last Alarm Scan Date indicates the date and time of the last **Alarm Scan**. The date is only displayed when the **Alarm Scan** is stopped.

Path Signal Label (V5) indicates the path signal label of the selected tributary. Refer to *Path Signal Label (V5)* on page 267 (SONET) or page 357 (SDH) for more information.

Extended Signal Label indicates the extended signal label of the selected tributary.

Extended Signal Label		
SONET	SDH	Hex value
Reserved	Reserved	00 to 07
Experimental or development mapping	Experimental mapping	08
ATM mapping	ATM mapping	09
Mapping of HDLC/PPP framed signal	Mapping of HDLC/PPP framed signal	0A
Mapping of HDLC/LAPS framed signal	Mapping of HDLC/LAPS framed signal	0B
Virtually Concatenated O.181 test signal	VCAT test signal, O.181 specific mapping	0C
GFP mapping	GFP mapping	0D
Reserved for proprietary use	Reserved	D0 to DF
Reserved	Reserved	FF

J2 Trace indicates the **J2 Trace** value for the selected tributary. Refer to *J2 Trace* on page 265 (SONET) or page 352 (SDH) for more information.

Last Trib Scan indicates the date and time of the last **Trib Scan**.

Smart Mode

Creating and Starting a Test Case Using SmartMode

Creating and Starting a Test Case Using SmartMode

Note: *The default test preferences will be used for the test. For example, the laser will be Off if not enabled from the Default Test Preferences on page 530.*











To setup a test case using SmartMode:

- 1.** Select the SONET/SDH signal corresponding to the signal connected to the module.
- 2.** Press either **Not Scanned**. **Click here or on the “Smart Scan” button to scan** or **Smart Scan**. A **Trib Scan** is also required for LOP test purposes otherwise, a HOP test case will be created even if the signal contains LOP.
- 3.** The structure of the signal is displayed when the scan succeeds. If the scan succeeds, press **Launch Test** to start the test.

Note: *The user must select the desired HOP and LOP timeslots before pressing **Launch Test** otherwise, the first valid timeslot scanned will be used.*

Legend

SmartMode uses visual indicators to identify particular information like alarms/errors, structured payload, selected timeslot/tributary, VCG, etc. The following table shows the different indicators.

Visual Indicator	Indicator Description	Description	Apply to
	Light blue color	Not selected	Timeslot, Tributary
	Dark blue color	Selected	Signal, Timeslot, Tributary
	Red color	Current alarm/error	
	Yellow color	History alarm/errors	
	Light gray color	Unequipped	Timeslot, Tributary
	Underlined timeslot (STS-1 is used as example)	VT/TUG Structured Payload	Timeslot
	Underlined timeslot with a little triangle in the bottom-right corner (STS-1 is used as example)	VT/TUG Structured payload Scanned. The little triangle summarizes LOP alarms/errors.	
	Little blue square in the top-left corner (STS-1 is used as example)	Pointer Adjustment	Timeslot, Tributary
	Low Order Path (LOP)	Type of payload Examples: VCG, VT1.5, etc.	Tributary
	Light gray background color with a question mark (?)	Unidentified	Timeslot, Tributary

8 Summary Tabs

The summary tabs allow to configure the test parameters and to view the test status and results.

Tab	Page
<i>Test Summary</i>	125
<i>Alarm Summary (including the Logger)</i>	132
<i>Test Logger</i>	135

Test Summary

Gives the test configuration, status, preferences, and timer configuration.

Press **TEST**, **Summary**, and **Test**.

The screenshot displays a software interface for configuring a test. It is divided into several sections:

- Test Status:** Shows 'Start Time: --:--:--' and a 'Link' button with a red dot.
- Test Configuration:** Includes 'Test Name' (TEST), 'Test Mode' (Normal), and checkboxes for 'Coupled', 'OTN Intrusive', 'Through', and 'SONET/SDH Intrusive'. There is also a 'Test Description' text area.
- Clock Configuration:** Features a 'Clock Mode' dropdown set to 'Internal'.
- Alarm Analysis:** Shows radio buttons for 'H C' and 'LOC', and a 'Seconds' field.
- Test Preferences:** Contains 'Background Traffic' settings for 'OTN (Mux Type PT 20)' and 'OTN (Mux Type PT 21)', and dropdowns for 'SONET/SDH HOP', 'SONET/SDH LOP', and 'DSn/PDH'. It also has a 'STS-1 Fixed Stuff Columns' section with 'Bulk Filled Overwrite Enable' checked and a 'Computation Method' dropdown.
- Timer Configuration:** Includes 'Start Time' and 'Stop Time' (both 2010-11-03 13:52:40), a 'Duration' dropdown (15 minutes), and 'User Duration' (004:00:15:00). An 'On/Off' button with a green dot is also present.

At the bottom left, there are 'Alarm' and 'Test' buttons.

Summary Tabs

Test Summary

Test Status

- **Start Time:** Indicates the date and time the test has been started. The date and time reset every time the test is restarted. The default time format is ISO (yyyy-mm-dd hh:mm:ss) unless otherwise set from the *Application Preferences* on page 528.
- **Link:** Indicates the status of the 10G Ethernet RX signal. Only available with OTU1e/OTU2e interface when **10G Ethernet** is selected.

Test Configuration

- **Test Name:** The name of the test connection is used to identify the test. A maximum of 8 characters are allowed. The default setting is **TEST**.
- **Test Mode:** Indicates the selected test mode.
 - **Normal:** Indicates that the unit is monitoring a signal in coupled/decoupled and/or through mode.
 - **Dual RX:** Indicates that the IQS-8105/15/20/30 unit is monitoring two DS1 or DS3 signals at the same time. Both RX ports are coupled at the exception of the termination mode. **Dual RX** is not available then the AUX connector is used for synchronization (refer to Clock Synchronization *on page 520* for more information).

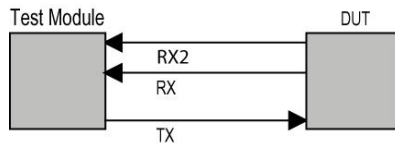

- **NI/CSU Emulation:** Indicates that the IQS-8105/15/20/30 unit is emulating the loopback capabilities of a network device in order to respond to an incoming loopback code of a DS1 signal. It can also be used to manually configure a payload or DS1 loopback adapted to the frame format.

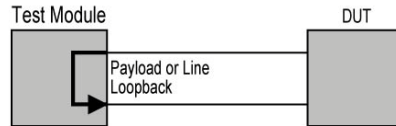

- **Multi-Channel SDT:** Indicates that the RX signal is looped to the TX port at the highest termination layer and the RX signal is monitored at each layer defined in the test case.

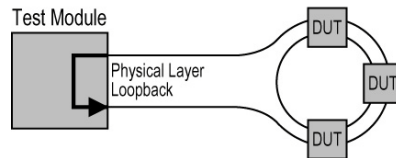

➤ Coupled:

- Indicates that both TX and RX parameters are coupled when the **Coupled** check box is selected.

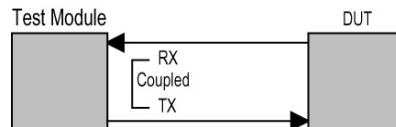

- Indicates that TX and RX parameters are independent (decoupled) when the **Coupled** check box is cleared.

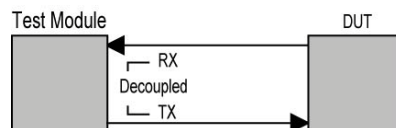

Summary Tabs

Test Summary

- **Through:** When enabled, indicates that the RX signal is looped to the TX port.

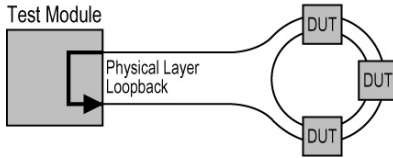

- **OTN Intrusive** and **SONET/SDH Intrusive** are mutually exclusive. When enabled, indicates that the RX signal is looped to the TX port with limited TX overwrite capabilities (For **SONET/SDH Intrusive**: OH and alarm/error generation). **SONET/SDH Intrusive** and **OTN Intrusive** are not available on IQS-8105/IQS-8115.

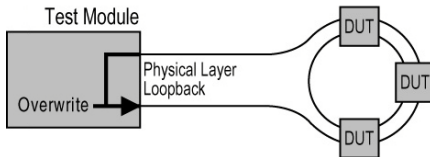

- **Test Description:** The test description is used to describe the test case. A maximum of 64 ASCII characters are allowed.

Clock Configuration

Note: *Clock Mode* is only available when the test is not started. **External** and **Backplane** clock modes are not available with the OTU1e, OTU2e, OTU1f, and OTU2f interfaces.

Clock Mode allows the clock source selection that will be used for the test.

Internal: Internal clock of the unit (STRATUM 3).

External: Clock from the connected DS1/E1/2M external clock signal (AUX-BNC port). Refer to *Clock Synchronization - RX* on page 522 to complete the external clock settings.

Recovered: Clock from the test optical/electrical port input signal. Recovered is the only choice available when the **Test Mode** is set to **Through** mode.

Backplane: 8 kHz clock from another test module on the IQS-600. Note that the other module must support the backplane clock feature and must be enabled (refer to *Backplane* on page 526 for more information). Only one module should have its backplane clock enabled to avoid a LOC.

Alarm Analysis

LOC indicates that the IQS-8100 Series is unable to synchronize with the selected test clock.

Test Preferences

Allows the configuration of the **Background Traffic**, **STS-1 Fixed Stuff Column**, and **OC-192/STM-64 REI-L/MS-REI** parameters. Refer to Default Test Preferences on page 530 for the description of each parameter.

Summary Tabs

Test Summary

Timer Configuration

Allows to automatically start and/or stop a test case at a given time or for a specific duration.

- **Start Time:** Allows the selection of the specific time the created test case will automatically start. The start time check box has to be checked to be included in the test timer.

Note: *A valid start time has to be subsequent to the current time.*

- **Stop Time:** Allows the selection of the specific time the test case will automatically stop. The stop time check box has to be checked to be included in the test timer.

Note: *A valid stop time has to be subsequent to the current time or to the start time, when enabled. The Stop Time must not exceed 30 days based on the start time. Stop Time cannot be enabled while Duration is enabled.*

- **Duration:** Allows the selection of the test duration based on the test case start time. The test case start time can be the time the user presses the start button or the time the test is automatically started when the Start Time has been enabled. The Duration check box has to be checked to be included in the test timer. Choices are **15 minutes, 1, 2, 24, 48, 72 hours, 7 days**, or **User Defined** (see User Duration below). The default setting is 15 minutes.

Note: *Duration cannot be enabled while Stop Time is enabled. When the test is started while duration is enabled, the stop time is calculated and the Stop Time field is updated to indicate the time the test will stop.*

- **User Duration:** Allows the selection of the test duration when **User Defined** has been selected for duration. Choices are from **1 second to 30 days**. The default setting is **15 minutes**.

- **On/Off** button allows enabling the test timer. An error message is displayed and the test timer is not enabled when the provided start time or stop time is not valid. It is not possible to enable the test timer while the test is running. When the timer is enabled (On), it is possible to disable it even when the test is running. This setting is disabled (Off) by default.

When test timer is enabled, it is possible to manually stop a test case using the main test case Stop button. However, it is not possible to start the test case when the **Start Time** is enabled. An icon is displayed in the global test status area, in front of the test time, indicating that the timer is enabled.

The test timer is automatically disabled either when the user manually stops the test, or when the given stop time or duration has expired.

Note: *When using Visual Guardian Lite for remote control, the timer configuration values will be based on the PC clock and not on the IQS-8100 Series. Make sure to consider the time zone differential if it exists between the PC and the IQS-8100 Series.*

Summary Tabs

Alarm Summary

Alarm Summary

Press **TEST**, **Summary**, and **Alarm**.

The **Alarm** summary tab gives access to the alarm summary including the test logger. See *Test Logger* on page 135.

Alarm Summary

The alarm summary gives current and history summary of alarms and errors encountered during the test.

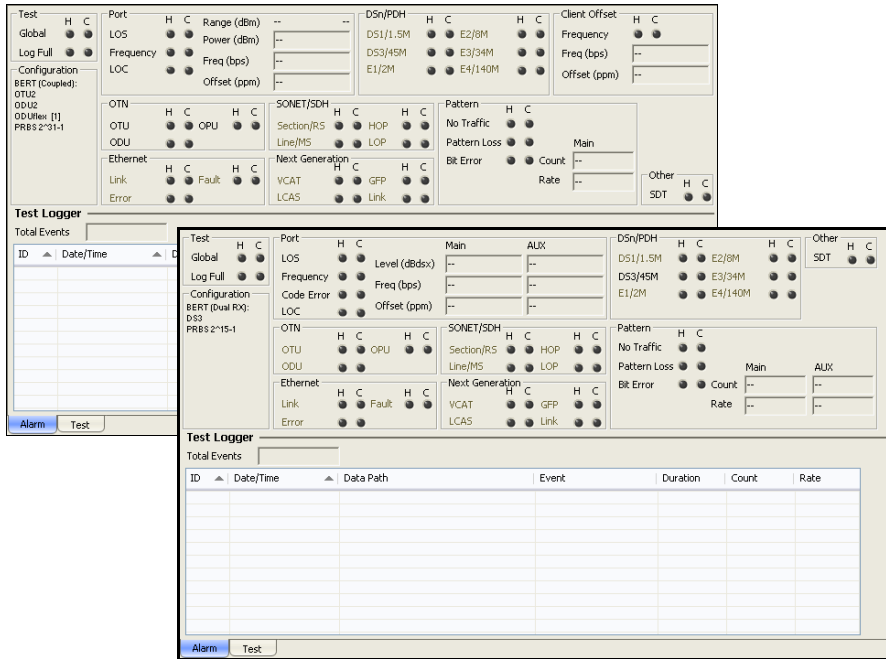

Note: The list of available alarms and errors depends on the test case.

➤ **Test**

Global: Indicates the presence of any alarms/errors related to the test such as **Port**, OTN, SONET/SDH, DS_n/PDH, Next Generation, Pattern, and **Other**.

Log Full: Indicates that the logger reached its maximum capacity of 5000 events.

➤ **Configuration:** Indicates the test structure (data path).

➤ **Port:** Indicates the presence of any alarms/errors related to the physical port such as **LOS**, **Frequency**, **LOC**, and **Code Errors** (for electrical port: BPV, EXZ, or CV errors). Also indicates the port power measurement **Power (dBm)** and **Range (dBm)** for optical port, frequency **Freq (bps)**, and **Offset (ppm)**. For **Dual RX** test case, the measurements are available for both the Main (test port) and AUX ports. Refer to *Port Tabs* on page 137 for more information.

➤ **OTN:** Indicates the presence of any alarms/errors related to the OTN such as **OTU**, **ODU** (includes ODU TCM alarms), and **OPU**. Refer to *OTN Tabs* on page 153 for more information.

➤ **SONET/SDH:** Indicates the presence of any alarms/errors related to SONET/SDH testing such as **Section/RS**, **Line/MS**, **HOP** (High Order Path), and **LOP** (Low Order Path). LOP is not supported on the IQS-8140. Refer to *SONET Tabs* on page 211 and *SDH Tabs* on page 303 for more information.

➤ **Next Generation:** Indicates the presence of any alarms/errors related to Next Generation testing such as **VCAT**, **LCAS**, **GFP**, and **Link**. Refer to *Next-Generation Tabs* on page 429 for more information.

➤ **DS_n/PDH:** Indicates the presence of any alarms/errors related to DS_n/PDH testing such as **DS1/1.5M**, **DS3/45M**, **E1/2M**, **E2/8M**, **E3/34M**, and **E4/140M**. Not supported on the IQS-8140. Refer to *DS_n Tabs* on page 269 and *PDH Tabs* on page 369 for more information.

Summary Tabs

Alarm Summary

- **Ethernet:** Indicates the presence of any alarms/errors related to Ethernet, Gb Ethernet, and 10G Ethernet testing such as **Errors (FCS, Jabber, Runt, Oversize)** when enabled (refer to *Oversize Monitoring on page 399*), **Undersize, Block Error, Out-of-sequence, or Frame Loss**, **Link**, and **Fault**. Refer to *Ethernet Tabs* on page 393 for more information.
- **Pattern:** Indicates the presence of any alarms/errors related to pattern testing such as **Bit Error**, and **Pattern Loss**. Indicates also the **Bit Error** rate and count for both **Main** (test port) and **AUX** ports. Refer to *BERT Tabs* on page 405 for more information.
- **Client Offset:** Indicates the presence of client frequency alarm as well as the client frequency measurement value and its offset. Refer to *Client Offset RX* on page 515 for more information.
- **Other:** Indicates all other alarms/errors such as **SDT**. Refer to *Service Disruption Time (SDT)* on page 411 for more information.

Test Logger

Press **TEST**, **Summary**, and **Alarm**.

The **Test Logger** lists the test status/events.

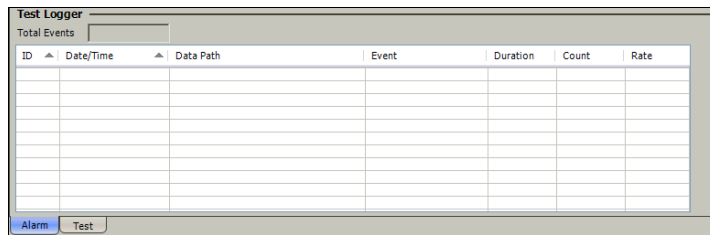

The screenshot shows a window titled "Test Logger" with a "Total Events" field and a table. The table has the following columns: ID, Date/Time, Data Path, Event, Duration, Count, and Rate. The table is currently empty. Below the table are two buttons: "Alarm" and "Test".

ID	Date/Time	Data Path	Event	Duration	Count	Rate

Total Events

Indicates the total number of recorded events.

Note: *The Logger lists a maximum of 5000 events, over that amount the logger stops recording and the log full alarm is activated.*

Summary Tabs

Test Logger

Logger Table

An event is automatically listed in the logger and saved on the hard drive in case a power failure condition occurs.

The logger is cleared when one of the following conditions is met:

- A test case is stopped and restarted.
- The test case is cleared.
- When pressing  .

Events are listed by **ID - Date/Time** by default. Events can also be sorted by **Data Path** or **Event** by pressing on the corresponding column title.

- **ID:** Indicates the Event number. Events are sequentially numbered.
- **Date/Time:** Indicates the date and time the Alarm/Error condition has been detected.
- **Data Path:** Indicates the origin of the alarm/error. [P1] and [P2] in the data path represent respectively the Port 1 and Port 2.
- **Event:** Indicates the alarm/error type.
- **Duration:** Indicates the number of seconds (day:hour:minute:second format) within which the alarm/error occurred.
- **Count:** Indicates the number of occurrences of the error.
- **Rate:** Indicates the error rate.

Note: *In the Duration, Count and Rate columns, **Pending** indicates that the alarm/error condition persists or was persisting when the test was stopped.*

9 Port Tabs

This section describes the electrical and optical port tabs.

Note: *The available tabs listed are a function of the test path activated.*

Tab	Page
<i>Port TX (Electrical Interfaces)^a</i>	138
<i>Port RX (Electrical Interfaces)^a</i>	142
<i>Port TX (Optical Interfaces)^b</i>	147
<i>Port RX (Optical Interfaces)^b</i>	150

a. Not available on the IQS-8140.

b. Not available on the IQS-8105.

Port Tabs

Port TX (Electrical Interfaces)

Port TX (Electrical Interfaces)

Press **TEST**, **Port**, and **Port TX**.

The screenshot shows a configuration window for Port TX. It is divided into several sections:

- Configuration:** Line Coding is set to CMI, LBO is set to 0 to 225 feet range.
- Signal Analysis:** Output Presence is checked.
- Alarm generation:** Type is LOS, On/Off is checked.
- Error Injection:** Manual Type is BPV, Amount is 1, Send button is present. Automated Type is BPV, Rate is 1.0E-02, Continuous checkbox is unchecked, On/Off is checked.
- Frequency:** Frequency Offset (ppm) is 0, On/Off is checked. Actual Frequency (bps) and Nominal Frequency (bps) are both set to --.

Configuration

► Line Coding

Signal	Line Coding	Default setting
DS1	AMI and B8ZS	B8ZS
DS3	B3ZS	B3ZS
E1	AMI and HDB3	HDB3
E2	HDB3	HDB3
E3	HDB3	HDB3
E4	CMI	CMI
STS-1e/STM-0e	B3ZS	B3ZS
STS-3E/STM-1e	CMI	CMI

- **LBO (Line Build Out):** The **LBO** allows to meet the interface requirements over the full range of cable lengths. **LBO** is not available with E1, E2, E3, and E4 interfaces.

For DS1:

Preamplification values: **+3.0 dBdsx (533-655 ft)**, **+2.4 dBdsx (399-533 ft)**, **+1.8 dBdsx (266-399 ft)**, **+1.2 dBdsx (133-266 ft)**, and **+0.6 dBdsx (0-133 ft)**.

Cable simulation (CSU Emulation mode) values: **0.0 dBdsx**, **-7.5 dBdsx**, **-15.0 dBdsx**, and **-22.5 dBdsx**.

For DS3: **0 to 225 feet range**, **225 to 450 feet range**, and **Cable Simulation 900 ft**).

For STS-1e/STM-0e: **0 to 225 feet range**, **225 to 450 feet range**, and **Cable Simulation 900 ft**).

For STS-3e/STM-1e: **0 to 225 ft**.

Signal Analysis

Output Presence: Indicates the presence of a signal at the output port (green) or not (gray).

Alarm Generation

- **Type**

LOS (Loss Of Signal): Turns off the output port signal.

- **On/Off button:** Press **On/Off** to enable/disable the alarm generation.

Error Injection

Allows manual or automated error injection.

- **Type:** The following error types are available with both manual and automated injection mode.

BPV (DSn) or **CV** (PDH)

EXZ (Excessive Zeros) is only available with DS1 and DS3 interfaces.

The default setting is **BPV/CV**.

- **Amount:** Select the amount of error to be generated.
Choices are **1** through **50**. The default setting is **1**.
- **Send** button: Press **Send** to manually generate error(s) according to the **Error Type** and the **Amount of Errors** selected.
- **Rate:** Press **Rate** to select the injection rate for the selected error. The rate must be within the minimum and maximum values specified. The default setting is **1.0E-2**.
- **Continuous: Continuous**, when activated, generates the selected error to its theoretical maximum. This setting is disabled by default.
- **On/Off** button: The **On/Off** button is used to activate/deactivate the selected automated error at the rate specified or continuously when continuous is enabled. This setting is disabled (Off) by default.

Frequency

Note: Frequency offset generation is not available for 10Base-T test.

- **Frequency Offset (ppm):** Allows entering a positive or a negative frequency offset in ppm. Choices are listed in the table below. The default setting is **0**. The frequency offset value can be changed on the fly even when activated (On).
- **Actual Frequency (bps):** Indicates the frequency (actual frequency + Frequency offset) that will be used for transmission.
- **Nominal Frequency (bps):** Indicates the nominal frequency of the signal. The nominal frequencies are listed in the table below.
- **On/Off button:** Allows enabling the frequency offset generation. This setting is disabled (Off) by default.

Interface	Frequency Offset ^a	Nominal Frequency
DS1	± 140 ppm	1544000 bps
E1	± 70 ppm	2048000 bps
E2	± 50 ppm	8448000 bps
E3	± 50 ppm	34368000 bps
DS3	± 50 ppm	44736000 bps
STS-1e/STM-0e	± 50 ppm	51840000 bps
E4	± 50 ppm	139264000 bps
STS-3e/STM-1e	± 50 ppm	155520000 bps

- a. The frequency offset range is guaranteed for a source signal at 0 ppm. In the event that the source signal already has an offset then, the output signal may exhibit an offset larger than the range specified.

Port Tabs

Port RX (Electrical Interfaces)

Port RX (Electrical Interfaces)

Press **TEST**, **Port**, and **Port RX**.

The screenshot displays a configuration window for Port RX. It is divided into several sections:

- Configuration:** Includes a dropdown for 'Line Coding' (set to 'CMI') and a dropdown for 'Termination Mode' (set to 'Term').
- Alarm Analysis:** Features radio buttons for 'LOS' and 'Frequency', each with an associated 'Seconds' input field.
- Error Analysis:** Features radio buttons for 'H C' and 'BPV', with 'Seconds', 'Count', and 'Rate' input fields.
- Signal Analysis:** Includes 'Power Level (dbm)' and 'Amplitude (Vpp)' input fields, and a checked 'Input Presence' indicator.
- Frequency Analysis:** Includes 'Frequency (bps)', 'Frequency Offset', 'Max. Negative Offset', 'Max. Positive Offset', and 'Offset Unit' (set to 'ppm') input fields.

Note: For DS1/DS3 **Dual RX** test mode, the second RX port's tab is accessible using the Tab Configuration on page 49.

Configuration

Note: See Configuration on page 138 for more information on **Line Coding**.

Termination Mode

Choices are: **Term**, **Mon**, and **Bridge**. **Bridge** is only available for DS1/E1 interfaces.

Alarm Analysis

Possible alarms that can be detected are:

- **LOS** (Loss Of Signal): The **LOS** alarm indicates absence of an input signal or an all-zeros pattern was detected.
- **Frequency**: The frequency alarm indicates if the received signal rate meets the standard rate specifications (green) or not (red).

Interface	Standard Rate Specification
DS1	1544000 ±57 bps (±36.6 ppm)
E1	2048000 ±112 bps (±54.6 ppm)
E2	8448000 ±293 bps (±34.6 ppm)
E3	34368000 ±846 bps (±24.6 ppm)
DS3	44736000 ±1101 bps (±24.6 ppm)
STS-1e/STM-0e	51840000 ±1276 bps (±24.6 ppm)
E4	139264000 ±2730 bps (±19.6 ppm)
STS-3e/STM-1e	155520000 ±3826 bps (±24.6 ppm)

Error Analysis

Possible errors that can be detected are:

- For DS1 and DS3

BPV (Bipolar Violation): A **BPV** error indicates that pulses of the same consecutive polarity were detected, in violation with the bipolar signal format.

EXZ (Excessive Zeros)

For **DS1** with **AMI Line Coding**: Indicates that more than 15 consecutive bit periods with no pulses have been received.

For **DS1** with **B8ZS Line Coding**: Indicates that more than 7 consecutive bit periods with no pulses have been received.

For **DS3**: Indicates that more than 2 consecutive bit periods with no pulses have been received.

- For E1, E2, E3, E4, STS-1e/STM-0e, and STS-3e/STM-1e

CV (Code Violation): A **CV** error indicates that pulses of the same consecutive polarity were detected, in violation with the bipolar signal format.

Signal Analysis

- **Power Level:** Indicates the power level of the input signal in dBm for E1, E2, E3, E4, STS-1e/STM-0e, and STS-3e/STM-1e. In order to get accurate power level reading (within specified tolerance), an all-ones signal must be present at the interface under test otherwise this value only provide indicative reading.
- **Level (Vref = 6.00 Vpp) / Level (Vref = 1.21 Vpp):** Presents the received signal level in dBdsx for respectively DS1 and DS3. The dBdsx values are calculated with the following expressions:
For DS1: $20 \log (V_{pp} \text{ measured} / 6.00)$
For DS3: $20 \log (V_{pp} \text{ measured} / 1.21)$
- **Amplitude:** Indicates the amplitude of the input signal in Vpp.
- **Input Presence:** Indicates if there is a signal at the input port (green) or not (gray).

Frequency Analysis

The IQS-8100 Series allows the following frequency monitoring range.

Interface	Standard Rate Specification
DS1	1544000 ± 140 ppm
E1	2048000 ± 100 ppm
E2	8448000 ± 100 ppm
E3	34368000 ± 100 ppm
DS3	44736000 ± 100 ppm
STS-1e/STM-0e	51840000 ± 100 ppm
E4	139264000 ± 100 ppm
STS-3e/STM-1e	155520000 ± 100 ppm

- **Actual Frequency (bps):** Indicates the frequency of the input signal.
- **Frequency Offset:** Indicates the offset between the standard rate specification and the rate of the input signal.
- **Max. Positive Offset:** Indicates the offset between the standard rate specification and the largest rate recorded from the received signal.
- **Max. Negative Offset:** Indicates the offset between the standard rate specification and the smallest rate recorded from the received signal.

Offset Unit: Allows the selection of the frequency offset unit. Choices are **bps** and **ppm**. The default setting is **ppm**.

Port TX (Optical Interfaces)

Note: Available with OTN, SONET, and SDH interfaces.

Press **TEST** and **Port**.

The screenshot displays a configuration window for Port TX (Optical Interfaces) with two main sections: Signal Analysis and Alarm Generation.

Signal Analysis:

- Output Presence:** A green LED indicator is lit, signifying that a signal is present at the output port.
- Wavelength (nm):** A dropdown menu is set to 1550.12.
- Invert Polarity:** An unchecked checkbox.

Alarm Generation:

- Type:** A dropdown menu is set to LOS.
- On/Off:** A green LED indicator is lit, indicating that the alarm is currently active.
- Frequency:**
 - Frequency Offset (ppm):** A text field containing the value 0.
 - Actual Frequency (bps):** A text field containing the value 39813120000.
 - Nominal Frequency (bps):** A text field containing the value 39813120000.
- On/Off:** A green LED indicator is lit, indicating that the frequency-related alarm is currently active.

Signal Analysis

Output Presence: Indicates the presence of a signal at the output port (green) or not (grey). The output presence LED is grey when there is no SFP/XFP.

Port Tabs

Port TX (Optical Interfaces)

Wavelength (nm)

- **Wavelength (nm):** Indicates the detected SFP/XFP/TRN wavelength. Possible values are:
For IQS-8105/15/20/30: **850, 1310, 1550 nm**, or **unknown** if the SFP/XFP is missing or not recognized.
For IQS-8140-NRZ: 1550 nm.
For IQS-8140-DPSK: the wavelength is selectable.

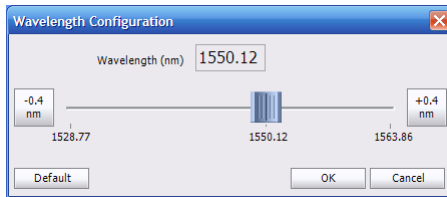

- **Invert Polarity:** For the IQS-8140-DPSK model, invert the polarity if required.

Alarm Generation

- **Type: LOS (Loss Of Signal):** Turns off the output port laser signal.
- **On/Off button:** Allows enabling the alarm generation. This setting is disabled (Off) by default.

Frequency

Note: Frequency offset is not available when **Through** mode is selected.

- **Frequency Offset (ppm):** Allows entering a positive or a negative frequency offset in ppm. The default setting is **0**.
- **Actual Frequency (bps):** Indicates the frequency (actual frequency + Frequency offset) used for transmission.
- **Nominal Frequency (bps):** Indicates the nominal frequency of the signal.
- **On/Off** button: Allows enabling the frequency offset generation. This setting is disabled (Off) by default.

Interface	Frequency Offset ^a	Nominal Frequency
OC-3/STM-1	± 50 ppm	155520000 bps
OC-12/STM-4	± 50 ppm	622080000 bps
OC-48/STM-16	± 50 ppm	2488320000 bps
OTU1	± 50 ppm	2666057143 bps
OC-192/STM-64	± 50 ppm	9953280000 bps
OTU2	± 50 ppm	10709225316 bps
OTU1e	± 115 ppm	11049107143 bps
OTU2e	± 115 ppm	11095727848 bps
OTU1f	± 115 ppm	11270089286 bps
OTU2f	± 115 ppm	11317642405 bps
OC-768/STM-256	± 50 ppm	39813120000 bps
OTU3	± 50 ppm	43018413559 bps

- a. The frequency offset range is guaranteed for a source signal at 0 ppm offset. In the event that the source signal already has an offset then, the output signal may exhibit an offset larger than the range specified.

Port Tabs

Port RX (Optical Interfaces)

Port RX (Optical Interfaces)

Press **TEST** and **Port**.

The screenshot displays a configuration window for Port RX (Optical Interfaces). It is divided into several sections: 'Signal Analysis' with 'Range (dBm)' (3.0, 8.0) and 'Power (dBm)' (6.0, highlighted in green); 'Alarm Analysis' with radio buttons for 'LOS', 'Frequency', and 'RX Tuning' (LOS is selected); and 'Frequency Analysis' with fields for 'Frequency (bps)', 'Frequency Offset', 'Offset Unit' (ppm), 'Max. Negative Offset', and 'Max. Positive Offset'.

Signal Analysis

- **Range** indicates the minimum and maximum optical power values necessary to meet the standard BER for the test interface.
- **Power (dBm)** indicates the power level of the input signal in dBm. The background color of the **Power Level** field indicates the input presence as follow:

Background color	Description
Green	Power level in-range.
Yellow	Power level out of operational range.
Red	Power level crosses the “Close-to-damage” threshold.
Grey	LOS or invalid operational range value reported by the optical device (SFP/XFP).

Alarm Analysis

- **LOS** (Loss Of Signal) indicates that there is no input signal or an all-zeros pattern on the incoming SONET/SDH signal persists for more than 100 μ s.
- **Frequency** alarm indicates that the received signal rate meets the standard rate specifications (green) or not (red).

Interface	Standard Rate Specification
OC-3/STM-1	155520000 \pm 3826 bps (\pm 24.6 ppm)
OC-12/STM-4	622080000 \pm 15304 bps (\pm 24.6 ppm)
OC-48/STM-16	2488320000 \pm 61213 bps (\pm 24.6 ppm)
OTU1	2666057143 \pm 65585 bps (\pm 24.6 ppm)
OC-192/STM-64	9953280000 \pm 244851 bps (\pm 24.6 ppm)
OTU2	10709225316 \pm 263446 bps (\pm 24.6 ppm)
OTU1e	11049107143 \pm 1155737 bps (\pm 104.6 ppm)
OTU2e	11095727848 \pm 1160613 bps (\pm 104.6 ppm)
OTU1f	11270089286 \pm 1178851 bps (\pm 104.6 ppm)
OTU2f	11317642405 \pm 1183825 bps (\pm 104.6 ppm)
OC-768/STM-256	39813120000 \pm 979402 bps (\pm 24.6 ppm)
OTU3	43018413559 \pm 1058253 bps (\pm 24.6 ppm)

- **RX Tuning** alarm indicates that the wavelength of the DPSK transponder is being adjusted. Only available with the IQS-8140-DPSK model.

Port Tabs

Port RX (Optical Interfaces)

Frequency Analysis

The IQS-8100 Series allows the following frequency monitoring range.

Interface	Measurement range
OC-3/STM-1	155520000 ±100 ppm
OC-12/STM-4	622080000 ±100 ppm
OC-48/STM-16	2488320000 ±100 ppm
OTU1	2666057143 ±100 ppm
OC-192/STM-64	9953280000 ±100 ppm
OTU2	10709225316 ±100 ppm
OTU1e	11049107143 ±120 ppm
OTU2e	11095727848 ±120 ppm
OTU1f	11270089286 ±120 ppm
OTU2f	11317642405 ±120 ppm
OC-768/STM-256	39813120000 ±100 ppm
OTU3	43018413559 ±100 ppm

Actual Frequency (bps) indicates the frequency of the input signal in bps.

Frequency Offset indicates the offset between the standard rate specification and the rate of the input signal.

Max. Negative Offset indicates the offset between the standard rate specification and the smallest rate recorded from the received signal.

Max. Positive Offset indicates the offset between the standard rate specification and the largest rate recorded from the received signal.

Offset Unit allows the selection of the frequency offset unit. Choices are **bps** and **ppm**. The default setting is **ppm**.

10 OTN Tabs

Note: OTN tabs are only available for OTU1, OTU2, OTU1e, OTU2e, OTU1f, OTU2f, and OTU3 interfaces. OTN options need to be enabled to be available. Refer to Available Options on page 547 for more information.

OTN	Tab	Page
FEC	<i>FEC TX</i>	154
	<i>FEC RX</i>	156
OTU3, OTU2, OTU1, OTU1e, OTU2e, OTU1f, OTU2f	<i>OTU TX</i>	157
	<i>OTU OH TX</i>	160
	<i>OTU TTI TX</i>	162
	<i>OTU RX</i>	163
	<i>OTU OH RX</i>	166
	<i>OTU TTI RX</i>	168
ODU3 TCM, ODU2 TCM, ODU1 TCM, ODU0 TCM, and ODUflex TCM	<i>ODU TCM TX</i>	170
	<i>ODU TCM TTI TX</i>	173
	<i>ODU TCM RX</i>	175
	<i>ODU TCM TTI RX</i>	178
ODU3, ODU2, ODU1, ODU0, and ODU FLEX	<i>ODU TX</i>	180
	<i>ODU OH TX</i>	182
	<i>ODU TTI/FTFL TX</i>	186
	<i>ODU RX</i>	189
	<i>ODU OH RX</i>	191
	<i>ODU TTI/FTFL RX</i>	194
OPU3, OPU2, OPU1, OPU0, OPUflex	<i>OPU TX</i>	197
	<i>OPU OH TX</i>	200
	<i>OPU RX</i>	203
	<i>OPU OH RX</i>	205
GMP	<i>GMP TX</i>	208
	<i>GMP RX</i>	209

FEC TX

Press **TEST**, **OTUK**, and **FEC** (under **OTUK TX**).

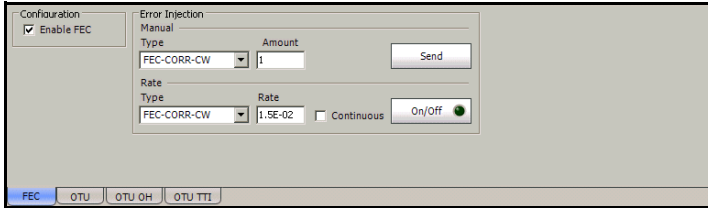

Configuration

Enable FEC allows detecting, reporting and correcting up to 8 symbol errors (Correctable) per codeword. Over 8 symbol errors, they are detected and reported as uncorrectable errors. This setting is enabled by default.

Note: *Enable FEC must be selected when **Enable Scrambler** is not selected in order to prevent potential alarms caused by a lack of transition on the optical signal. To disable **FEC**, first select **Enable Scrambler** then clear **Enable FEC**. See **OTU TX** on page 157 for more information on **Enable Scrambler**.*

Error Injection

Allows manual or automated error injection.

Note: *Error injection is only available when the **Enable FEC** check box is selected.*

- **Type:** The following error types are available with both manual and automated injection modes. The default setting is **FEC-CORR-CW**.
 - FEC-CORR-CW** (Forward Error Correction - Correctable - Codeword): Generates 8 symbols (bytes) containing 8 bits in error each, in each codeword.
 - FEC-UNCORR-CW** (Forward Error Correction - Uncorrectable - Codeword): Generates 16 symbol (bytes) containing 8 bits in error each, in each codeword.
 - FEC-CORR-SYMB** (Forward Error Correction - Correctable - Symbol): Generates 1 symbol (byte) containing 8 bits in error.
 - FEC-CORR-BIT** (Forward Error Correction - Correctable - Bit): Generates 1 symbol (byte) containing 1bit in error.
 - FEC-STRESS-CW** (Forward Error Correction - Stress - Codeword): Generates correctable errors composed of a random number of symbol errors (less or equal to 8) containing a random number of bits distributed all over the OTU frame.
- **Amount:** Select the amount of errors to be generated. Choices are **1** through **50**. The default setting is **1**.
- **Send** button: Press **Send** to manually generate error(s) according to the **Error Type** and the **Amount of Errors** selected.
- **Rate:** Press **Rate** to select the injection rate for the selected error. The rate must be within the minimum and maximum values specified. The default setting is **1.5E-2**.
- **Continuous:** Generates the selected error to its theoretical maximum rate when the **Continuous** check box is selected. The **Continuous** check box is cleared by default.
- **On/Off** button: The On/Off button is used to activate/deactivate the selected automated error at the rate specified or at its theoretical maximum rate when the **Continuous** check box is selected. This setting is disabled (Off) by default.

FEC RX

Press **TEST**, **OTUK**, and **FEC** (under **OTUK RX**).

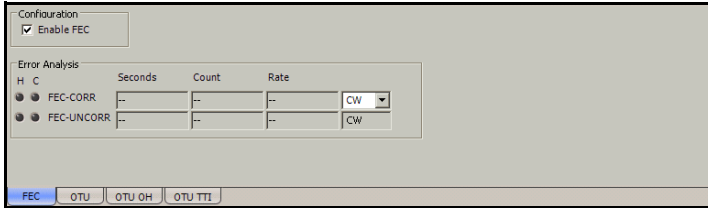

Configuration

Note: See OTU TX on page 157 for more information on **Enable FEC**.

Error Analysis

- **FEC-CORR** (FEC - Correctable): Gives statistics on codewords/symbols/bits corrected by the FEC.

CW/SYMB/BIT item list: FEC-CORR errors are displayed according with the select statistics. Available statistics are **Codeword (CW)**, **Symbol (SYMB)**, and **Bits (BIT)**. The default setting is **CW (Codeword)**.

- **FEC-UNCORR** (FEC - Uncorrectable): Gives statistics on the detected codewords (CW) having uncorrectable errors.

OTU TX

Press **TEST**, **OTUk**, and **OTU** (under **OTUk TX**).

The screenshot displays a configuration window for OTU TX. It is divided into three main sections: Configuration, Alarm Generation, and Error Injection. The Configuration section has a checked 'Enable Scrambler' checkbox. The Alarm Generation section shows 'Type' set to 'OTU-AIS' and an 'On/Off' button with a green indicator. The Error Injection section has a 'Manual' section with 'Type' set to 'OTU-BIP-8' and 'Amount' set to '1', and a 'Rate' section with 'Type' set to 'OTU-BIP-8', 'Rate' set to '6.5E-05', and an unchecked 'Continuous' checkbox. An 'On/Off' button with a green indicator is also present. A 'Send' button is located between the Manual and Rate sections. At the bottom, there are tabs for 'FEC', 'OTU', 'OTU OH', and 'OTU TTI', with 'OTU' currently selected.

Configuration

Note: Configuration for OTU TX and OTU RX are coupled.

Enable Scrambler provides enough “0” and “1” transitions on the optical signal for clock recovery. The **Enable Scrambler** check box is selected by default.

Note: **Enable Scrambler** must be selected when **Enable FEC** is not selected in order to prevent potential alarms caused by a lack of transition on the optical signal. To disable **Scrambler**, first select the **Enable FEC** check box then clear the **Enable Scrambler** check box. See **FEC TX** on page 154 for more information on **Enable FEC**.

Error Injection

Allows manual or automated error injection.

- **Type:** The following error types are available with both manual and automated injection mode: **OTU-BIP-8**, **OTU-BEI**, **FAS**, and **MFAS**. The default setting is **OTU-BIP-8**.
- **Amount:** Select the amount of errors to be generated. Choices are **1** through **50**. The default setting is **1**.
- **Send** button: Press **Send** to manually generate error(s) according to the **Error Type** and the **Amount of Errors** selected.
- **Rate:** Press **Rate** to select the injection rate for the selected error. The rate must be within the minimum and maximum values specified. The default setting is **6.5E-05**.
- **Continuous:** Generates the selected error to its theoretical maximum rate when the **Continuous** check box is selected. The **Continuous** check box is cleared by default.
- **On/Off** button: The On/Off button is used to activate/deactivate the selected automated error at the rate specified or at its theoretical maximum rate when the **Continuous** check box is selected. This setting is disabled (Off) by default.

Alarm Generation

Type: The following alarm types are available. The default setting is **OTU-AIS**.

- **LOF** (Loss Of Frame): Generates error in FAS bits continuously.
- **OOF** (Out-Of-Frame): Generates error in all FAS bits for 5 consecutive OTU frames.
- **LOM** (Loss Of Multiframe): Generates error in MFAS bits continuously.
- **OOM** (Out-Of-Multiframe): Generates error in multiframe number for 5 consecutive OTU frames.
- **OTU-AIS** (OTU - Alarm Indication Signal): Generates polynomial number 11 (PN-11) over all OTU frame bits including FAS and MFAS continuously.
- **OTU-BDI** (OTU - Backward Defect Indication): Generates “1” for the BDI bit in the SM overhead field (byte 3, bit 5) continuously.
- **OTU-IAE** (OTU - Incoming Alignment Error): Generates “1” for the IAE bit in the SM overhead field (byte 3, bit 6) continuously.
- **OTU-BIAE** (OTU - Backward Incoming Alignment Error): Generates “1011” for the BEI/BIAE bits in the SM overhead field (byte 3, bits 1 to 4) continuously.

On/Off button: The On/Off button is used to activate/deactivate the selected alarm. This setting is disabled (Off) by default.

OTU OH TX

Allows to modify the OTU overhead information to be transmitted.

Note: Only available for IQS-8120NG, IQS-8130NG, IQS-8120NGE, IQS-8130NGE, and IQS-8140 modules when **OTN Intrusive** through mode is not selected.

Press **TEST**, **OTUk**, and **OTU OH** (under **OTUk TX**).

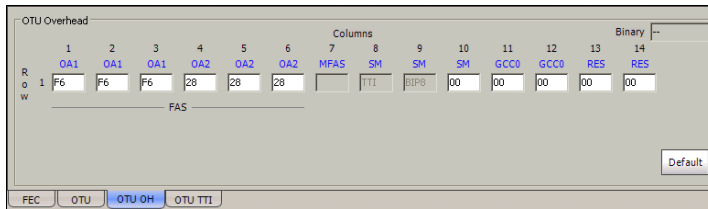

Note: Overhead bytes are organized using rows and columns structure as per G.709 standard.

Binary

The **Binary** field allows to individually edit any overhead byte in binary. Select the byte to be modified by clicking on its blue label and enter the new binary value. The **Binary** label will be replaced by the byte's label selected for modification.

Row 1

- **FAS:** All the Frame Alignment Signal OA1 bytes and OA2 bytes are individually configurable from **00** to **FF**. The default values are **F6** for all OA1 bytes and **28** for all OA2 bytes.
- **MFAS:** The Multi-Frame Alignment Signal byte is not configurable.

- **SM:** The Section Monitoring contains the following bytes.

The first SM byte (Column 8) contains the **TTI** multiframe byte that is only configurable from *OTU TTI TX* on page 162.

The second SM byte (Column 9) contains the **BIP-8** byte that is automatically generated for each frame. This byte is not configurable.

The third SM byte (Column 10) contains the following sub-fields. This byte is configurable from **00** to **FF**. The default value is **00**.

Sub-field	Bit
BEI/BIAE	1-4
BDI	5
IAE	6
RES	7-8

- **GCC0:** The two General Communication Channel-0 bytes are configurable from **00** to **FF**. The default value for each byte is **00**.
- **RES:** The two Reserved (RES) bytes are configurable from **00** to **FF**. The default value for each byte is **00**.

Default

Reverts the overhead bytes to their default values.

OTU TTI TX

Press **TEST**, **OTUk**, and **OTU TTI** (under **OTUk TX**).

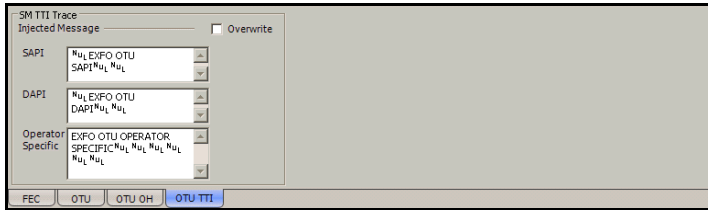

SM TTI Trace

Injected Message

- **SAPI** allows editing the Source Access point Identifier message to be generated (TTI bytes 1 to 15). A maximum of 15 characters are allowed. The default setting is **EXFO OTU SAPI**. The TTI byte 0 is set to NULL (all 0's).
- **DAPI** allows editing the Destination Access point Identifier message to be generated (TTI bytes 17 to 31). A maximum of 15 characters are allowed. The default setting is **EXFO OTU DAPI**. The TTI byte 16 is set to NULL (all 0's).
- **Operator Specific** allows editing the Operator Specific message to be generated (TTI bytes 32 to 63). A maximum of 32 characters are allowed. The default setting is **EXFO OTU OPERATOR SPECIFIC**.
- **Overwrite**: Available with **OTN Intrusive** through mode only (optional). The **Overwrite** check box when selected, generates the defined SM TTI Trace message. **Overwrite** is not available on IQS-8105/IQS-8115.

OTU RX

Press **TEST**, **OTUk**, and **OTU** (under **OTUk RX**).

Configuration		Alarm Analysis		Seconds		H		C		Seconds		H		C		Seconds	
<input checked="" type="checkbox"/> Enable Scrambler		<input type="checkbox"/> LOM	---	<input type="checkbox"/> OOM	---	<input type="checkbox"/> OTU-AIS	---	<input type="checkbox"/> OTU-TIM	---	<input type="checkbox"/> OTU-BDI	---	<input type="checkbox"/> OTU-IAE	---	<input type="checkbox"/> OTU-BIAE	---		
Error Analysis		<input type="checkbox"/> FAS	---	<input type="checkbox"/> MFAS	---	<input type="checkbox"/> OTU-BIP-8	---	<input type="checkbox"/> OTU-BEI	---								
H	C	Seconds	Count	Rate	H	C	Seconds	Count	Rate								
		---	---	---			---	---	---								

FEC | **OTU** | OTU OH | OTU TTI

Configuration

Note: See OTU TX on page 157 for more information on **Enable Scrambler**.

Alarm Analysis

Possible alarms that can be detected are:

- **LOF** (Loss Of Frame): LOF is declared when OOF is present for at least 3 ms.
- **OOF** (Out-Of-Frame): OOF is declared when FAS (bytes 3, 4, and 5) are in error for at least 5 consecutive OTU frames.
- **LOM** (Loss Of Multiframe): LOM is declared when OOM is present for at least 3 ms.
- **OOM** (Out-Of-Multiframe): OOM is declared when MFAS are in error for at least 5 consecutive OTU frames.
- **OTU-AIS** (OTU - Alarm Indication Signal): OTU-AIS is declared when polynomial number 11 (PN-11) is over all OTU frame bits including FAS and MFAS for at least 3 consecutive 8192 bit-interval.

- **OTU-TIM** (OTU - Trace Identifier Mismatch): OTU-TIM is declared when expected SM SAPI and/or SM DAPI do not match the received SM SAPI and/or DAPI for at least 3 consecutive TTI. This alarm is only available when the **Enable TIM SAPI** and/or **DAPI** check boxes are selected from *OTU TTI RX* on page 168.
- **OTU-BDI** (OTU - Backward Defect Indication): OTU-BDI is declared when the BDI bit in the SM overhead field (byte 3, bit 5) is “1” for at least 5 consecutive OTU frames.
- **OTU-IAE** (OTU - Incoming Alignment Error): OTU-IAE is declared when IAE bit in the SM overhead field (byte 3, bit 6) is “1” for at least 5 consecutive OTU frames.
- **OTU-BIAE** (OTU - Backward Incoming Alignment Error): OTU-BIAE is declared when BEI/BIAE bits in the SM overhead field (byte 3, bits 1 to 4) are “1011” for at least 3 consecutive frames.

Note: *Refer to Alarm/Error Measurements on page 47 for H/C LEDs and Seconds information.*

Error Analysis

Possible errors that can be detected are:

- **FAS** (Frame Alignment Signal): Indicates the FAS bits in error.
- **MFAS** (Multiframe Alignment Signal): Indicates the MFAS bits in error.
- **OTU-BIP-8** (OTU - Bit Interleave Parity-8): Indicates the SM BIP-8 mismatch between the received value and locally computed value (0 to 8).
- **OTU-BEI** (OTU - Backward Error Indication): Indicates SM BEI errors received from the DUT (value 0 to 8).

OTU BEI bits (1234)	BIP violations	ODUk BEI bits (1234)	BIP violations
0000	0	0101	5
0001	1	0110	6
0010	2	0111	7
0011	3	1000	8
0100	4	1001 to 1111	0

OTU OH RX

Displays the OTU overhead bytes received in the last second.

Press **TEST**, **OTUK**, and **OTU OH** (under **OTUK RX**).

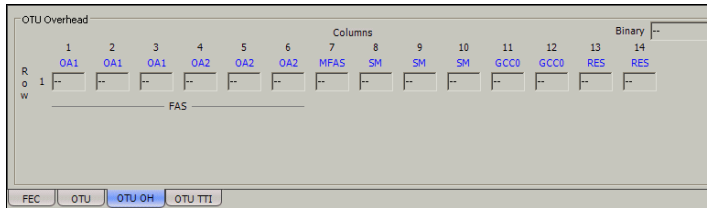

Note: *Overhead bytes are organized using rows and columns structure as per G.709 standard.*

Binary

The **Binary** field allows to individually display any overhead byte in binary. Select the byte to be displayed by clicking on its blue label. The **Binary** label will be replaced by the byte's label selected.

Row 1

- **FAS:** Displays the received Frame Alignment Signal OA1 and OA2 byte values.
- **MFAS:** Displays the received Multi-Frame Alignment Signal byte value.

- **SM:** Displays the received Section Monitoring bytes.
 The first SM byte (Column 8) contains the **TTI** multiframe byte.
 The second SM byte (Column 9) contains the **BIP-8** byte.
 The third SM byte (Column 10) contains the following sub-fields.

Sub-field	Bit
BEI/BIAE	1-4
BDI	5
IAE	6
RES	7-8

- **GCC0:** Displays the received General Communication Channel byte values.
- **RES:** Displays the received RES (Reserved) byte values.

OTU TTI RX

Press **TEST**, **OTUk**, and **OTU TTI** (under **OTUk RX**).

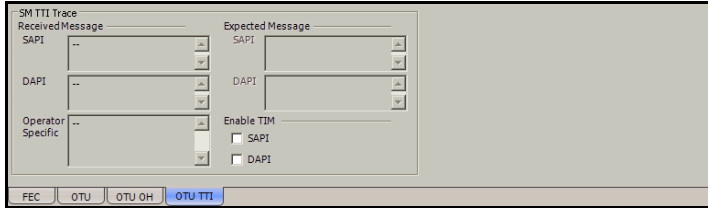

SM TTI Trace

Received Message

- **SAPI** indicates the received TTI (Trail Trace Identifier) Source Access Point Identifier. When the **Enable TIM SAPI** check box is selected, the SAPI field background becomes pink when there is a mismatch with the expected value and the OTU-TIM alarm is declared.
- **DAPI** indicates the received TTI Destination Access Point Identifier. When the **Enable TIM DAPI** check box is selected, the DAPI field background becomes pink when there is a mismatch with the expected value and the OTU-TIM alarm is declared.
- **Operator Specific** indicates the received TTI Operator Identifier.

Expected Message

- **SAPI** allows editing the expected Source Access point Identifier (TTI bytes 1 to 15). Available when the **Enable TIM SAPI** check box is selected. The default setting is **EXFO OTU SAPI**. The TTI byte 0 is set to NULL (all 0's).
- **DAPI** allows editing the expected Destination Access point Identifier (TTI bytes 17 to 31). Available when the **Enable TIM DAPI** check box is selected. The default setting is **EXFO OTU DAPI**. The TTI byte 16 is set to NULL (all 0's).

Enable TIM

- **SAPI** allows editing the expected Source Access Point Identifier when the **SAPI** check box is selected. Enables also the OTU-TIM alarm monitoring. The **SAPI** check box is cleared by default.
- **DAPI** allows editing the expected Destination Access Point Identifier when the **DAPI** check box is selected. Enables also the OTU-TIM alarm monitoring. The **DAPI** check box is cleared by default.

ODU TCM TX

Note: *This tab is not used when **OTN Intrusive** through mode is enabled.*

Press **TEST**, **ODUk**, and **ODU TCM** (under **ODUk TX**).

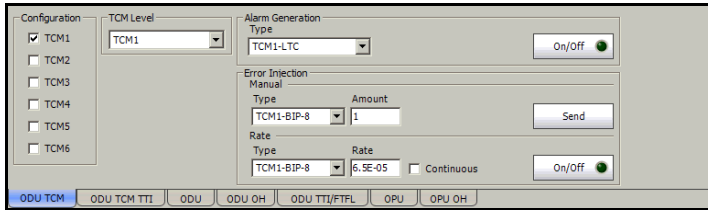

Configuration

TCM1 to **TCM6** allows enabling TCM level 1 to level 6. **TCM1** to **TCM6** are disabled by default.

TCM Level

Allows the selection of the TCM level for alarm/error generation. Choices are from **TCM1** to **TCM6**, but only enabled TCM levels are available.

Alarm Generation

Type: The following alarm types are available. The default setting is **TCMi-LTC**.

- **TCMi-LTC** (TCMi - Loss of Tandem Connection): Generates "000" in the STAT field of TCMi overhead (byte 3, bits 6 to 8) continuously.
- **TCMi-BDI** (TCMi - Backward Defect Indication): Generates a "1" in the BDI bit of the TCMi overhead field (byte 3, bit 5) continuously.
- **TCMi-IAE** (TCMi - Incoming Alignment Error): Generates "1" in the IAE bit of the TCMi overhead (byte 3, bit 6) continuously.
- **TCMi-BIAE** (TCMi - Backward Incoming Alignment Error): Generates "1011" in the BEI/BIAE bits of the TCMi overhead (byte 3, bits 1 to 4) continuously.

On/Off button: The On/Off button is used to activate/deactivate the selected alarm. This setting is disabled (Off) by default.

Error Injection

Allows manual or automated error injection.

- **Type:** The following error types are available with both manual and automated injection mode: **TCMi-BIP-8**, and **TCMi-BEI**. The default setting is **TCMi-BIP-8**.
- **Amount:** Select the amount of errors to be generated.
Choices are **1** through **50**. The default setting is **1**.
- **Send** button: Press **Send** to manually generate error(s) according to the **Error Type** and the **Amount of Errors** selected.
- **Rate:** Press **Rate** field to select the injection rate for the selected error. The rate must be within the minimum and maximum values specified. The default setting is **6.5E-05**.
- **Continuous:** Generates the selected error to its theoretical maximum rate when the **Continuous** check box is selected. The **Continuous** check box is cleared by default.
- **On/Off** button: The On/Off button is used to activate/deactivate the selected automated error at the rate specified or continuously when continuous is enabled. This setting is disabled (Off) by default.

Note: “*i*” is the level (1 to 6) of the selected TCM.

ODU TCM TTI TX

Note: This tab is not used when *OTN Intrusive* through mode is enabled.

Press **TEST**, **ODUk**, and **ODU TCM TTI** (under **ODUk TX**).

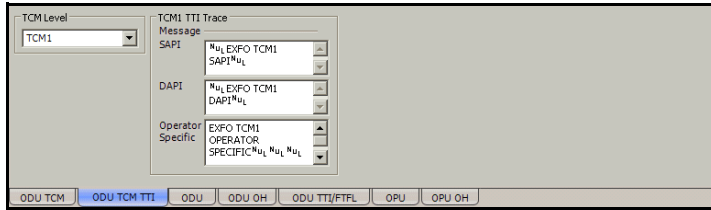

TCM Level

Allows the selection of the TCM level for alarm/error generation. Choices are from **TCM1** to **TCM6**, but only enabled TCM levels are available (see *TCM Level* on page 170).

TCMi TTI Trace

Message

- **SAPI** allows editing the Source Access Point Identifier to be generated (TTI bytes 1 to 15). A maximum of 15 characters are allowed. The default setting is **EXFO TCMi SAPI**. The TTI byte 0 is set to NULL (all 0's).
- **DAPI** allows editing the Destination Access Point Identifier to be generated (TTI bytes 17 to 31). A maximum of 15 characters are allowed. The default setting is **EXFO TCMi DAPI**. The TTI byte 16 is set to NULL (all 0's).
- **Operator Specific** allows editing the Operator Specific to be generated (TTI bytes 32 to 63). A maximum of 32 characters are allowed. The default setting is **EXFO TCMi OPERATOR SPECIFIC**.

Note: *“i” is the level (1 to 6) of the selected TCM.*

ODU TCM RX

Press **TEST**, **ODUk**, and **ODU TCM** (under **ODUk RX**).

Configuration		TCM Level	Error Analysis				
<input checked="" type="checkbox"/>	TCM1	TCM1	H	C	Seconds	Count	Rate
<input type="checkbox"/>	TCM2		<input type="checkbox"/>	<input type="checkbox"/>	TCM1-BIP-8	--	--
<input type="checkbox"/>	TCM3		<input type="checkbox"/>	<input type="checkbox"/>	TCM1-BEI	--	--
<input type="checkbox"/>	TCM4		Alarm Analysis				
<input type="checkbox"/>	TCM5		H	C	Seconds	H	C
<input type="checkbox"/>	TCM6		<input type="checkbox"/>	<input type="checkbox"/>	TCM1-LTC	--	--
			<input type="checkbox"/>	<input type="checkbox"/>	TCM1-TIM		
			<input type="checkbox"/>	<input type="checkbox"/>	TCM1-BDI	--	--
			<input type="checkbox"/>	<input type="checkbox"/>	TCM1-IAE	--	--
			<input type="checkbox"/>	<input type="checkbox"/>	TCM1-BIAE	--	--

Configuration

TCM1 to **TCM6** allows enabling TCM level 1 to level 6. **TCM1** to **TCM6** are disabled by default.

TCM Level

Allows the selection of the TCM level for alarm/error analysis. Choices are from **TCM1** to **TCM6**, but only enabled TCM levels are available.

Error Analysis

- **TCMi-BIP-8** (TCMi - Bit Interleave Parity-8): Indicates TCMi BIP-8 mismatch between the received value and locally computed value (0 to 8).
- **TCMi-BEI** (TCMi - Backward Error Indication): Indicates that interleaved-bit blocks in error are detected by the corresponding ODUk tandem connection monitoring sink using the BIP-8 code.

ODU TCMi BEI bits (1234)	BIP violations	ODU TCMi BEI bits (1234)	BIP violations
0000	0	0101	5
0001	1	0110	6
0010	2	0111	7
0011	3	1000	8
0100	4	1001 to 1111	0

Alarm Analysis

- **TCMi-LTC** (TCMi - Loss of Tandem Connection): TCMi-LTC is declared when the STAT information in the TCMi Byte 3, bits 6, 7, and 8 are “000” for at least 3 consecutive frames.
- **TCMi-TIM** (TCMi -Trace Identification Mismatch): TCMi-TIM is declared when the expected TCMi SAPI and/or TCMi DAPI do not match the received TCMi SAPI and/or TCMi DAPI for at least 3 TTI. This alarm is only available when the Enable TIM SAPI and/or DAPI check boxes are selected from *ODU TCM TTI RX* on page 178.
- **TCMi-BDI** (TCMi - Backward Defect Indication): TCMi-BDI is declared when the BDI bit in the TCMi overhead field Byte 3, bit 5 is “1” for at least 5 consecutive frames.
- **TCMi-IAE** (TCMi - Incoming Alignment Error): TCMi-IAE is declared when the STAT information in the TCMi is “010” for at least 3 consecutive frames.
- **TCMi-BIAE** (TCMi - Backward Incoming Alignment Error): TCMi-BIAE is declared when the BEI/BIAE bits in the TCMi overhead field Byte 3, bits 1 to 4 are “1011” for at least 3 consecutive frames.

Note: “i” is the level (1 to 6) of the selected TCM.

ODU TCM TTI RX

Press **TEST**, **ODUk**, and **ODU TCM TTI** (under **ODUk TX**).

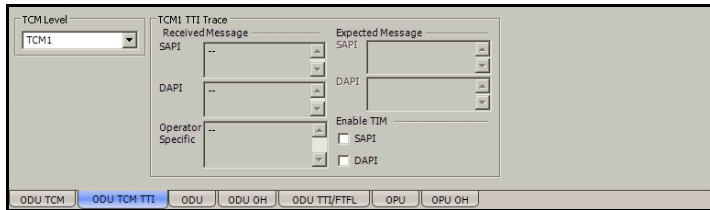

TCM Level

Allows the selection of the TCM level for alarm/error analysis. Choices are from **TCM1** to **TCM6**, but only enabled TCM levels from the ODU TCM tab are available.

TCMi TTI Trace

Received Message

- **SAPI** indicates the received TTI (Trail Trace identifier) Source Access Point Identifier. When the Enable TIM SAPI check box is selected, the SAPI field background becomes pink when there is a mismatch with the expected value and the TCMi-TIM alarm is declared.
- **DAPI** indicates the received TTI Destination Access Point Identifier. When the Enable TIM DAPI check box is selected, the DAPI field background becomes pink when there is a mismatch with the expected value and the TCMi-TIM alarm is declared.
- **Operator Specific** indicates the received TTI Operator Identifier.

Expected Message

- **SAPI** allows editing the expected Source Access point Identifier (TTI bytes 1 to 15). Available when **Enable TIM SAPI** is enabled. The default setting is **EXFO TCMi SAPI**. The TTI byte 0 is set to NULL (all 0's).
- **DAPI** allows editing the expected Destination Access point Identifier (TTI bytes 17 to 31). Available when **Enable TIM DAPI** is enabled. The default setting is **EXFO TCMi DAPI**. The TTI byte 16 is set to NULL (all 0's).
- **Enable TIM**

SAPI allows editing the expected Source Access Point Identifier when the **SAPI** check box is selected. Enables also the TCMi-TIM alarm monitoring. The **SAPI** check box is cleared by default.

DAPI allows editing the expected Destination Access Point Identifier when the **DAPI** check box is selected. Enables also the TCMi-TIM alarm monitoring. The **DAPI** check box is cleared by default.

Note: “i” is the level (1 to 6) of the selected TCM.

ODU TX

Press **TEST**, **ODUk**, and **ODU** (under **ODUk TX**).

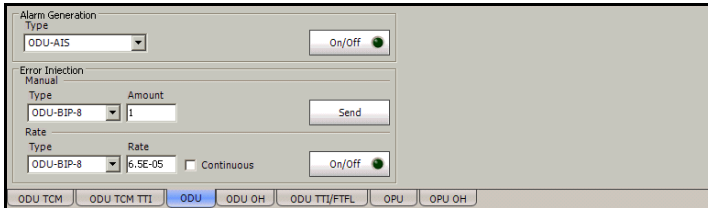

Error Injection

Allows manual or automated error injection.

- **Type:** The following error types are available with both manual and automated injection mode: **ODU-BIP-8**, and **ODU-BEI**. The default setting is **ODU-BIP-8**.
- **Amount:** Select the amount of errors to be generated. Choices are **1** through **50**. The default setting is **1**.
- **Send button:** Press **Send** to manually generate error(s) according to the **Error Type** and the **Amount of Errors** selected.
- **Rate:** Press **Rate** to select the injection rate for the selected error. The rate must be within the minimum and maximum values specified. The default setting is **6.5E-05**.
- **Continuous:** Generates the selected error to its theoretical maximum rate when the **Continuous** check box is selected. The **Continuous** check box is cleared by default.
- **On/Off button:** The On/Off button is used to activate/deactivate the selected automated error at the rate specified or at its theoretical maximum rate when the **Continuous** check box is selected. This setting is disabled (Off) by default.

Alarm Generation

Type: The following alarm types are available. The default setting is **ODU-AIS**.

- **ODU-LOFLOM** (ODU - Loss of Frame Loss Of Multiframe): Generates error continuously in FAS and MFAS of a multiplexed test case. Available for ODU mux test case on the ODU sub-layers only.
- **ODU-AIS** (ODU - Alarm Indication Signal): Generates an all "1"s pattern in the entire ODUk signal, excluding the frame alignment overhead (FA OH), OTUk overhead (OTUk OH) and ODUk FTFL.
- **ODU-OCI** (ODU - Open Connection Indication): Generates a repeating "01100110" pattern in the entire ODUk signal, excluding the frame alignment overhead (FA OH) and OTUk overhead (OTUk OH).
- **ODU-LCK** (ODU - Locked): Generates a repeating "01010101" pattern in the entire ODUk signal, excluding the frame alignment overhead (FA OH) and OTUk overhead (OTUk OH).
- **ODU-BDI** (ODU - Backward Defect Indication): Generates a "1" in the BDI (byte 3, bit 5) of the PM overhead field continuously.
- **ODU-FSF** (ODU - Forward Signal Fail): Generates a "00000001" pattern in the FTFL Byte 0 continuously.
- **ODU-BSF** (ODU - Backward Signal Fail): Generates a "00000001" pattern in the FTFL Byte 128 continuously.
- **ODU-FSD** (ODU - Forward Signal Degrade): Generates a "00000010" pattern in the FTFL Byte 0 continuously.
- **ODU-BSD** (ODU - Backward Signal Degrade): Generates a "00000010" pattern in the FTFL Byte 128 continuously.

On/Off button: The On/Off button is used to activate/deactivate the selected alarm. This setting is disabled (Off) by default.

ODU OH TX

Allows to modify the ODU overhead information to be transmitted.

Note: Only available when **Through** mode is not selected.

Press **TEST**, **ODUk**, and **ODU OH** (under **ODUk TX**).

ODU Overhead		Columns														Binary
		1	2	3	4	5	6	7	8	9	10	11	12	13	14	--
R o w s	2	RES	RES	PM&TCM	TCM ACT	TCM6	TCM6	TCM6	TCM5	TCM5	TCM5	TCM4	TCM4	TCM4	FTFL	
	3	TCM3	TCM3	TCM3	TCM2	TCM2	TCM2	TCM1	TCM1	TCM1	PM	PM	PM	EXP	EXP	
	4	FTFL	BIP8	00	FTFL	BIP8	00	FTFL	BIP8	00	FTFL	BIP8	01	00	00	
	5	GCC1	GCC1	GCC2	GCC2	APS/PCC	APS/PCC	APS/PCC	APS/PCC	RES	RES	RES	RES	RES	RES	Default

ODU TCM | ODU TCM TTI | ODU | **ODU OH** | ODU TTI/FTFL | OPU | OPU OH | GMP

Note: Overhead bytes are organized using rows and columns structure as per G.709 standard.

Binary

The **Binary** field allows to individually edit any overhead byte in binary. Select the byte to be modified by clicking on its blue label and enter the new binary value. The **Binary** label will be replaced by the byte's label selected for modification.

Row 2

- **RES:** The three Reserved (RES) bytes are configurable from **00** to **FF**. The default value for each byte is **00**.
- **PM&TCM:** The Path Monitoring & Tandem Connection Monitoring is configurable from **00** to **FF**. The default value is **00**.
- **TCM ACT:** The Tandem Connection Monitoring Activation is configurable from **00** to **FF**. The default value is **00**.
- **TCM6/TCM5/TCM4 (Row 2) and TCM3/TCM2/TCM1 (Row 3):** The Tandem Connection Monitoring overhead contains the following bytes.

The first TCMi byte contains the **TTI** multiframe byte and is only configurable from *ODU TTI/FTFL TX* on page 186.

The second TCMi byte contains the **BIP-8** byte and is automatically generated for each frame. This byte is not configurable.

The third TCMi byte contains the following sub-fields. This byte is configurable from **00** to **FF**. The default value is **00** when TCMi is disabled, and **01** when enabled.

Sub-field	Bit
BEI/BIAE	1-4
BDI	5
STAT	6-8

- **FTFL:** The Fault Type Fault Location multiframe byte is only configurable from *ODU TTI/FTFL TX* on page 186.

Row 3

- **TCM3/TCM2/TCM1:** See *Row 2* on page 183 for more information.
- **PM:** The Performance Monitoring overhead contains the following bytes.

The first PM byte (Column 10) contains the **TTI** byte that is not configurable.

The second PM byte (Column 11) contains the **BIP-8** byte and is automatically generated for each frame. This byte is not configurable.

The third PM byte (Column 12) contains the following sub-fields. This byte is configurable from **00** to **FF**. The default value is **01**.

Sub-field	Bit
BEI	1-4
BDI	5
STAT	6-8

- **EXP:** The two Experimental overhead bytes are configurable form **00** to **FF**. The default value for each byte is **00**.

Row 4

- **GCC1:** The two General Communication Channel-1 bytes are configurable from **00** to **FF**. The default value for each byte is **00**.
- **GCC2:** The two General Communication Channel-2 bytes are configurable from **00** to **FF**. The default value for each byte is **00**.
- **APS/PCC:** The Automatic Protection Switching / Protection Communication Channel overhead bytes are defined in the ITU-T G.709 standard. These bytes are configurable from **00** to **FF**. The default value is **00**.
- **RES:** The six Reserved (RES) bytes are configurable from **00** to **FF**. The default value for each byte is **00**.

Default

Reverts the overhead bytes to their default values.

ODU TTI/FTFL TX

Press **TEST**, **ODUk**, and **ODU TTI/FTFL** (under **ODUk TX**).

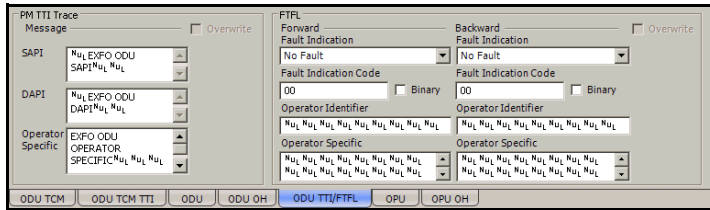

PM TTI Trace

Message

- **SAPI** allows editing the Source Access point Identifier message to be generated (TTI bytes 1 to 15). A maximum of 15 characters are allowed. The default setting is **EXFO ODU SAPI**. The TTI byte 0 is set to NULL (all 0's).
- **DAPI** allows editing the Destination Access point Identifier message to be generated (TTI bytes 17 to 31). A maximum of 15 characters are allowed. The default setting is **EXFO ODU DAPI**. The TTI byte 16 is set to NULL (all 0's).
- **Operator Specific** allows editing the Operator Specific message to be generated (TTI bytes 32 to 63). A maximum of 32 characters are allowed. The default setting is **EXFO ODU OPERATOR SPECIFIC**.
- **Overwrite**: Available with **OTN Intrusive** through mode only (optional). The **Overwrite** check box when selected, generates the defined PM TTI Trace message. **Overwrite** is not available on IQS-8105/IQS-8115.

FTFL TX

Allows the configuration of the **Forward** and **Backward** ODU Fault Type Fault Location (FTFL) to be generated.

- **Fault Indication** and **Fault Indication Code** allows the selection of the FTFL fault indicator message/code (byte 0 for forward, byte 128 for backward) to be generated. The default setting is **No fault (00)**. Choices are:

Fault Indication	Fault Indication Code
No fault	00
Signal fail	01
Signal Degrade	02
Reserved	03 ^a

- a. Selecting **Reserved** will use the hexadecimal code 03 but, all codes from 03 to FF are reserved for future international standardization.

Note: *The Fault Indication Code field is automatically updated when the Fault Indication is changed and vice versa.*

Binary allows either displaying the Fault Indication Code in binary (when enabled) or hexadecimal (when disabled). This setting is disabled by default.

OTN Tabs

ODU TTI/FTFL TX

- **Operator Identifier** allows editing the Operator Identifier (bytes 1 to 9 for forward, byte 129 to 137 for backward) to be generated. A maximum of 9 characters are allowed. By default no Operator Identifier is defined.
- **Operator Specific** allows editing the Operator Specific (bytes 10 to 127 for forward, byte 138 to 255 for backward) to be generated. A maximum of 118 characters are allowed. By default no Operator Specific is defined.
- **Overwrite:** Available with **OTN Intrusive** through mode only (optional). The **Overwrite** check box when selected, generates the defined FTFL. **Overwrite** is not available on IQS-8105/IQS-8115.

ODU RX

Press **TEST**, **ODUk**, and **ODU** (under **ODUk RX**).

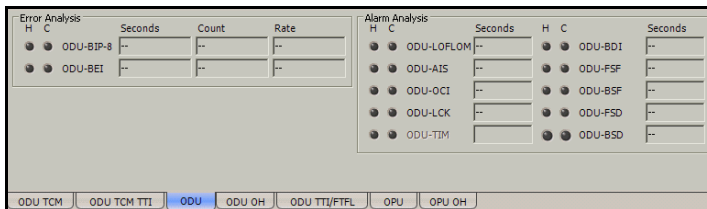

Error Analysis

- **ODU-BIP-8** (ODU - Bit Interleave Parity-8): Indicates the PM BIP-8 mismatch between the received value and locally computed value (0 to 8).
- **ODU-BEI** (ODU - Backward Error Indication): Indicates the interleaved block in error detected by the corresponding ODU path monitoring sink using the BIP-8 code.

ODU BEI bits (1234)	BIP violations	ODU BEI bits (1234)	BIP violations
0000	0	0101	5
0001	1	0110	6
0010	2	0111	7
0011	3	1000	8
0100	4	1001 to 1111	0

Alarm Analysis

- **ODU-LOFLOM** (ODU - Loss of Frame Loss Of Multiframe): Indicates that OOF is present for at least 3 ms. Available for ODU mux test case on the ODU sub-layers only.
- **ODU-AIS** (ODU - Alarm Indication Signal): Indicates that the STAT information detected, PM byte 3, bits 6 to 8 is “111” for at least 3 consecutive frames.
- **ODU-OCI** (ODU - Open Connection Indication): Indicates that the STAT information detected, PM byte 3, bits 6 to 8 is “110” for at least 3 consecutive frames.
- **ODU-LCK** (ODU - Lock): Indicates that the STAT information detected, PM byte 3, bits 6 to 8 is “101” for at least 3 consecutive frames.
- **ODU-TIM** (ODU - Trace Identification Mismatch): ODU-TIM is declared when the received SAPI and/or DAPI do not math the expected SAPI and/or DAPI. This alarm is only available when the Enable TIM SAPI and/or DAPI check boxes are selected from *ODU TTI/FTFL TX* on page 186.
- **ODU-BDI** (ODU - Backward Defect indication): ODU-BDI is declared when the BDI bit in the PM overhead field (byte 3, bit 5) is “1” for at least 5 consecutive frames.
- **ODU-FSF** (ODU - Forward Signal Fail): ODU-FSF is declared when the received FTFL byte 0 is “00000001”.
- **ODU-BSF** (ODU - Backward Signal Fail): ODU-BSF is declared when the received FTFL byte 128 is “00000001”.
- **ODU-FSD** (ODU - Forward Signal Degrade): ODU-FSD is declared when the received FTFL byte 0 is “00000010”
- **ODU-BSD** (ODU - Backward Signal Degrade): ODU-BSD is declared when the received FTFL byte 128 is “00000010”.

ODU OH RX

Displays the ODU overhead bytes received in the last second.

Press **TEST**, **ODUk**, and **ODU OH** (under **ODUk RX**).

ODU Overhead		Columns													Binary	
		1	2	3	4	5	6	7	8	9	10	11	12	13	14	
R O W S	2	RES	RES	PM&TCM	TCM ACT	TCM6	TCM6	TCM6	TCM5	TCM5	TCM5	TCM4	TCM4	TCM4	FTFL	<input type="checkbox"/>
	3	TCM3	TCM3	TCM3	TCM2	TCM2	TCM2	TCM1	TCM1	TCM1	PM	PM	PM	EXP	EXP	<input type="checkbox"/>
	4	GCC1	GCC1	GCC2	GCC2	APS/PCC	APS/PCC	APS/PCC	APS/PCC	RES	RES	RES	RES	RES	RES	<input type="checkbox"/>
	5															<input type="checkbox"/>

ODU TCM
 ODU TCM TTI
 ODU
 ODU OH
 ODU TTU/FTFL
 OPU
 OPU OH
 GMP

Note: Overhead bytes are organized using rows and columns structure as per G.709 standard.

Binary

The **Binary** field allows to individually display any overhead byte in binary. Select the byte to be displayed by clicking on its blue label. The **Binary** label will be replaced by the byte's label selected.

Row 2

- **RES:** Displays the three Reserved (RES) bytes values received.
- **PM&TCM:** Displays the Path Monitoring & Tandem Connection Monitoring value received.
- **TCM ACT:** Displays the Tandem Connection Monitoring Activation value received.
- **TCM6/TCM5/TCM4 (Row 2) and TCM3/TCM2/TCM1 (Row 3):** Displays the following Tandem Connection Monitoring overhead bytes.

The first TCM_i byte contains the **TTI** multiframe byte.

The second TCM_i byte contains the **BIP-8** byte.

The third TCM_i byte contains the following sub-fields.

Sub-field	Bit
BEI/BIAE	1-4
BDI	5
STAT	6-8

- **FTFL:** Displays the Fault Type Fault Location byte. See *FTFL RX* on page 196 for more information.

Row 3

- **TCM3/TCM2/TCM1**: See *Row 2* on page 192 for more information.
- **PM**: Displays the following Performance Monitoring overhead bytes.
The first PM byte (Column 10) contains the **TTI** multiframe byte.
The second SM byte (Column 11) contains the **BIP-8** byte.
The third PM byte (Column 12) contains the following sub-fields.

Sub-field	Bit
BEI	1-4
BDI	5
STAT	6-8

- **EXP**: Displays the two Experimental overhead bytes received.

Row 4

- **GCC1**: Displays the two General Communication Channel-1 bytes.
- **GCC2**: Displays the two General Communication Channel-2 bytes.
- **APS/PCC**: Displays the Automatic Protection Switching / Protection Communication Channel overhead bytes. The Automatic Protection Switching / Protection Communication Channel overhead bytes are defined in the ITU-T G.709 standard.
- **RES**: Displays the six Reserved (RES) bytes received.

ODU TTI/FTFL RX

Press **TEST**, **ODUk**, and **ODU TTI/FTFL** (under **ODUk RX**).

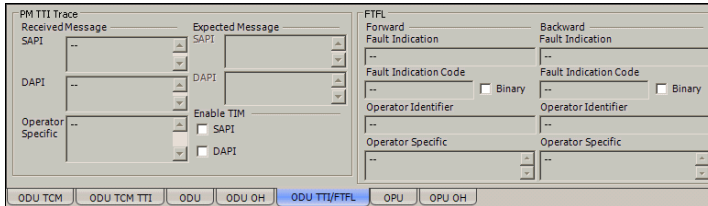

PM TTI Trace

Received Message

- **SAPI** indicates the received TTI (Trail Trace identifier) Source Access point Identifier. When TIM is enabled, the SAPI field background becomes pink when there is a mismatch with the expected value.
- **DAPI** indicates the received TTI Destination Access point Identifier. When TIM is enabled, the DAPI field background becomes pink when there is a mismatch with the expected value.
- **Operator Specific** indicates the received TTI Operator Identifier.

Expected Message

- **SAPI** allows editing the expected Source Access point Identifier (TTI bytes 1 to 15). Available when **Enable TIM SAPI** is enabled. The default setting is **EXFO ODU SAPI**. The TTI byte 0 is set to NULL (all zeros).
- **DAPI** allows editing the expected Destination Access point Identifier (TTI bytes 17 to 31). Available when **Enable TIM DAPI** is enabled. The default setting is **EXFO ODU DAPI**. The TTI byte 16 is set to NULL (all 0's).
- **Enable TIM**

SAPI allows the edition of the expected Source Access Point Identifier when the **SAPI** check box is selected. Enables also the ODU-TIM alarm monitoring. The **SAPI** check box is cleared by default.

DAPI allows the edition of the expected Destination Access Point Identifier when the **DAPI** check box is selected. Enables also the ODU-TIM alarm monitoring. The **DAPI** check box is cleared by default.

FTFL RX

Indicates the **Forward** and **Backward** ODU Fault Type Fault Location (FTFL).

- **Fault Indication** and **Fault Indication Code** displays the FTFL Fault Indication field (byte 0 for forward, byte 128 for backward). Possible Fault Indication are:

Fault Indication	Fault Indication Code
No fault	00
Signal fail	01
Signal Degrade	02
Reserved	03 to FF

Binary allows either displaying Fault Indication Code in binary (when enabled) or hexadecimal (when disabled). This setting is disabled by default.

- **Operator Identifier** displays the received operator identifier characters (bytes 1 to 9 for forward, byte 129 to 137 for backward).
- **Operator Specific** displays the received operator specific (bytes 10 to 127 for forward, byte 138 to 255 for backward).

OPU TX

Press **TEST**, **ODUk**, and **OPU** (under **ODUk TX**).

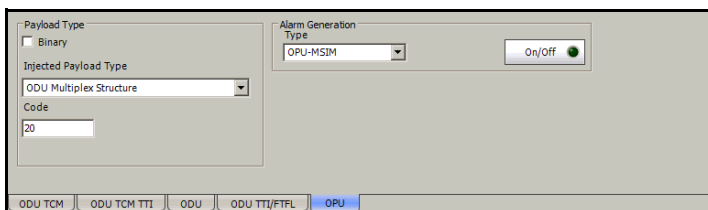

Payload Type

- **Injected Payload Type** allows the selection of the payload signal type to be generated.

Note: *Changing the payload type will not affect the test structure, only the generated payload will use the selected payload type.*

Payload type	Hex Code	MSB 1234	LSB 5678
Reserved for International Standardization ^a	00	0000	0000
Experimental	01	0000	0001
Asynchronous CBR	02	0000	0010
Bit Synchronous CBR	03	0000	0011
ATM	04	0000	0100
GFP	05	0000	0101
Virtual Concatenation Signal	06	0000	0110
1000Base-X into ODU0	07	0000	0111
FC-1200 into ODU2e	08	0000	1000

OTN Tabs

OPU TX

Payload type	Hex Code	MSB 1234	LSB 5678
GFP Into Extended OPU2	09	0000	1001
OC-3/STM1 mapping into ODU0	0A	0000	1010
OC-12/STM-4 into ODU0	0B	0000	1011
FC-100 into ODU0	0C	0000	1100
FC-200 into ODU1	0D	0000	1101
FC-400 into ODUflex	0E	0000	1110
FC-800 into ODUflex	0F	0000	1111
Bit Stream with Octet Timing	10	0001	0000
Bit Stream Without Octet Timing	11	0001	0001
ODU Multiplex with ODTUjk	20	0010	0000
ODU Multiplex with ODTUk.ts/ODTUjk	21	0010	0001
Not Available ^b	55	0101	0101
Reserved Codes for Proprietary Use ^c	80	1000	0000
NULL Test Signal	FD	1111	1101
PRBS Test Signal	FE	1111	1110

- a. Selecting **Reserved for International Standardization** will use the hexadecimal code 00 but, all codes not listed in the previous table at the exception of those cover in notes b and c are reserved for future standardization.
- b. Selecting **Not Available** will use the hexadecimal code 55 but, 66 and FF are also Not Available payload types.
- c. Selecting **Reserved Proprietary** will use the hexadecimal code 80 but, all codes from 80 to 8F are reserved proprietary payload types.

Note: Codes not listed in the previous table are reserved for future standardization (Reserved For International Standardization).

Note: *The Code field is automatically updated when the Injected payload Type is changed and vice versa.*

- **Overwrite:** Available with **OTN Intrusive** through mode only (optional). The **Overwrite** check box when selected, generates the defined Payload Type.
- **Code** allows entering the code of the payload type. Choices are **00** to **FF**.
- **Binary** allows either displaying the payload code value in binary (when enabled) or hexadecimal (when disabled). This setting is disabled by default.

Alarm Generation

Note: *Alarm generation is only available with multiplexed test case only.*

- **OPU-MSIM** (Multiplex Structure Identifier Mismatch): OPU-MSIM is an OPU alarm that is available for multiplexed test case only. The OPU-MSIM alarm is generated by corrupting the content of the PSI (bytes 2 and 3 for ODU0 in ODU1, bytes 2 to 5 for ODU1 in ODU2, and bytes 2 to 17 for ODU2 in ODU3).

Note: *OPU-AIS and OPU-CSF are only available on the OPU client signal (designated as LO in the standard). In this case, OPU-MSIM is not available.*

- **OPU-AIS** (OPU - Alarm Indication Signal): The OPU-AIS alarm is generated by generating the PRBS 2^{11-1} pattern.
- **OPU-CSF** (OPU - Client Signal Fail): The OPU-CSF alarm is generated by setting the bit 1 of the OPUk PSI[2] byte to “1”.
- **On/Off** button: The On/Off button is used to activate/deactivate the selected alarm. This setting is disabled (Off) by default.

OPU OH TX

Allows to modify the OPU overhead information to be transmitted.

Note: Only available when **Through** mode is not selected.

Press **TEST**, **ODUk**, and **OPU OH** (under **ODUk TX**).

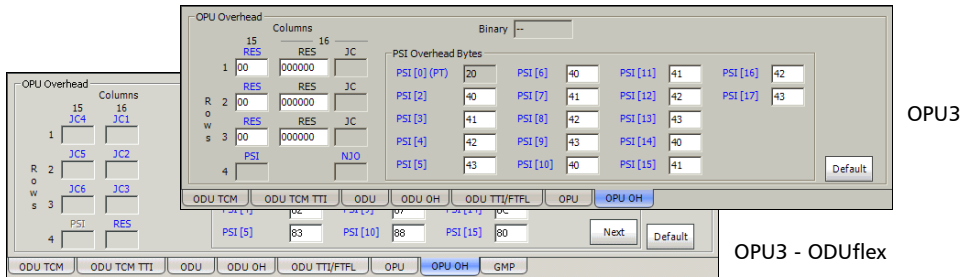

Note: Overhead bytes are organized using rows and columns structure as per G.709 standard.

Binary

The **Binary** field allows to individually edit any overhead byte in binary. Select the byte to be modified by clicking on its blue label and enter the new binary value. The **Binary** label will be replaced by the byte's label selected for modification.

Row 1/2/3

For Payload Type 20 test case

- **RES** (Column 15): The Reserved (RES) bytes are configurable from **00** to **FF**. The default value for each byte is **00**.
- **RES** and **JC** (Column 16):
 - RES**: The Reserved (RES) bits 1-6 are configurable from binary **000000** to **111111**. The default value for each byte is **000000**.
 - JC**: The Justification Control bits 7-8 are configurable from binary **00** to **11**. Not available with ODU mux. The default value for each JC is **00**. Changing the JC values will corrupt the payload.

For Payload Type 21 test case

- **JC1 to JC3** (Column 16): Displays the justification control bytes carrying the GMP Cm value.
- **JC4 to JC6** (Column 15): Displays the justification control bytes carrying the GMP CnD value.

Row 4

- **PSI** (Column 15): The Payload Structure Identifier is only configurable from *Payload Type* on page 197. The PSI byte is not displayed.

For Payload Type 20 test case

- **NJO** (Column 16): The Negative Justification Opportunity byte is not configurable.

For Payload Type 21 test case

- **RES** (Column 16): The Reserved (RES) byte is for future international standardization.

PSI Overhead Bytes

Note: *The PSI Overhead bytes are only available for OPU3, OPU2, and OPU1 with ODU mux.*

PSI [0] (PT): The Payload Structure Identifier (Payload Type) is only configurable from *Payload Type* on page 197.

PSI [2] up to PSI [17]: The Payload Structure Identifier bytes are configurable from **00** to **FF**. The first two bits are used to indicate the ODU mapping type while the remaining bits indicate the tributary port number.

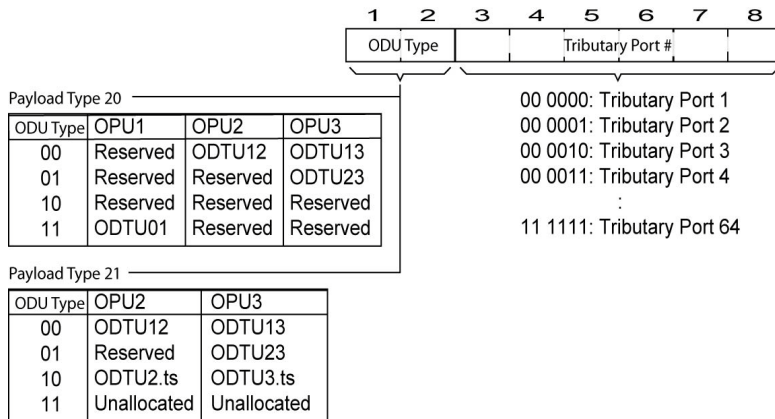

Note: *PSI [2] and PSI [3] and Tributary port 1 and 2 are supported with OPU1. PSI [2] to PSI [5] and Tributary port 1 to 4 are supported with OPU2. PSI [2] to PSI [17] and Tributary port 1 to 16 are supported with OPU3.*

Default

Reverts the overhead bytes to their default values.

OPU RX

Press **TEST**, **ODUk**, and **OPU** (under **ODUk RX**).

LO

The image shows two overlapping configuration windows for OPU RX. The top window is labeled 'LO' and the bottom window is labeled 'HO'. Both windows have a 'Payload Type' section and an 'Alarm Analysis' section.

LO Window:

- Received Payload Type (PT): --
- Expected Payload Type (PT): PRBS Test Signal
- Code: --
- Code: FE
- Binary:
- Binary:
- Enable OPU-PLM:

HO Window:

- Received Payload Type (PT): --
- Expected Payload Type (PT): ODU Multiplex Structure
- Code: --
- Code: 20
- Binary:
- Binary:
- Enable OPU-PLM:

Alarm Analysis Section (for both):

H	C	Seconds
<input type="radio"/>	<input type="radio"/>	--
<input type="radio"/>	<input type="radio"/>	--
<input type="radio"/>	<input type="radio"/>	--

Buttons at the bottom of the HO window: ODU TCM, ODU TCM TTI, ODU, ODU OH, ODU TTI/FTL, **OPU**, OPU OH

Alarm Analysis

- **OPU-PLM (Payload Mismatch):** OPU-PLM is declared when the Payload Structure Identifier (PSI) field do not match the expected PT for at least 3 consecutive frames. See **Enable OPU-PLM** on page 204.
- **OPU-MSIM (Multiplex Structure Identifier Mismatch):** OPU-MSIM is an HO alarm that is available for multiplexed test case only. OPU-MSIM is declared when the RX Payload Structure Identifier (PSI) information do not match the expected HO Multiplex Structure Identifier configuration defined from the test case setup.

Enable OPU-MSIM allows enabling the OPU-MSIM alarm analysis.

Note: *OPU-AIS and OPU-CSF are only available on the OPU client signal (designated as LO in the standard). In this case, OPU-MSIM is not available.*

OPU-AIS (OPU - Alarm Indication Signal): OPU-AIS is declared when a PRBS 2¹¹⁻¹ pattern is received indicating a failure of the client signal.

OPU-CSF (OPU - Client Signal Fail): OPU-CSF is declared when bit 1 of the OPU_k PSI[2] byte is set to “1” indicating a failure of the client signal mapped into the OPU_k of the OTN signal.

Payload Type

- **Binary** allows either displaying the payload code value in binary (when enabled) or hexadecimal (when disabled). This setting is disabled by default.
- **Received Payload Type (PT)** indicates the received payload signal type. See *Payload Type* on page 197 for more information.

Code indicates the corresponding payload type hexadecimal code.

- **Expected Payload Type** allows the selection of the expected payload type signal. See *Payload Type* on page 197 for choices.

Note: *The Code field is automatically updated when the Expected payload is changed and vice versa.*

Code allows entering the code of the payload type. Choices are **00** to **FF**. The default setting is **03**.

- **Enable OPU-PLM** allows enabling the OPU-PLM alarm analysis.

OPU OH RX

Displays the OPU overhead bytes received in the last second.

Press **TEST**, **ODUk**, and **OPU OH** (under **ODUk RX**).

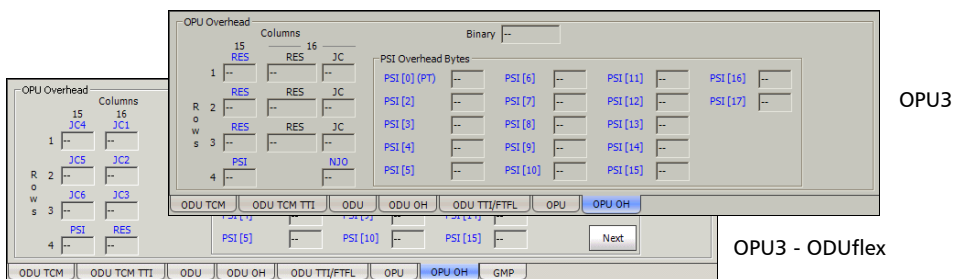

Note: Overhead bytes are organized using rows and columns structure as per G.709 standard.

Binary

The **Binary** field allows to individually display any overhead byte in binary. Select the byte to be displayed in binary by clicking on its blue label. The **Binary** label will be replaced by the label of the selected byte.

Row 1/2/3

For Payload Type 20 test case

- **RES** (Column 15): Displays the received Reserved (RES) bytes.
- **RES** and **JC** (Column 16):
 - RES**: Displays the received Reserved (RES) bits 1-6.
 - JC**: Displays the received Justification Control bits 7-8. Not available with ODU mux.

For Payload Type 21 test case

- **JC1 to JC3** (Column 16): Displays the received justification control bytes carrying the GMP Cm value.
- **JC4 to JC6** (Column 15): Displays the received justification control bytes carrying the GMP CnD value.

Row 4

- **PSI** (Column 15): Displays the received Payload Structure Identifier (Payload Type). See *Payload Type* on page 197 for more information.

For Payload Type 20 test case

- **NJO** (Column 16): Displays the received Negative Justification Opportunity byte.

For Payload Type 21 test case

- **RES** (Column 16): Displays the received Reserved (RES) byte.

PSI Overhead Bytes

Note: The PSI Overhead bytes are only available for OPU3, OPU2, and OPU1 with ODU mux.

PSI [0] (PT): Displays the received Payload Structure Identifier (Payload Type). See *Payload Type* on page 197 for more information.

PSI [2] to PSI [17] bytes: For OPU3, displayed the received Payload Structure Identifier bytes. The first two bits are indicate the ODU mapping type while the remaining bits indicate the tributary port numbers.

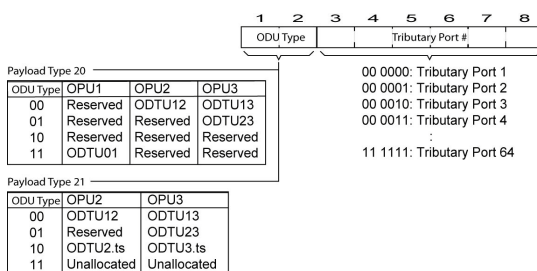

Note: *PSI [2] and PSI [3] and Tributary port 1 and 2 are supported with OPU1. PSI [2] to PSI [5] and Tributary port 1 to 4 are supported with OPU2. PSI [2] to PSI [17] and Tributary port 1 to 16 are supported with OPU3.*

Next/Previous button, available with ODU3, allows to respectively access the next (bytes 18 to 33) or previous (bytes 1 to 17) PSI Overhead bytes.

GMP TX

Generic Mapping Procedure (GMP) is available with GFP-F over ODUflex, GFP-T over ODU0, and SONET/SDH over ODU0. GMP is available on both HO and LO for ODU0 over ODU2 or ODU0 over ODU3 mapping.

Press **TEST**, **ODUk**, and **GMP** (under **ODUk TX**).

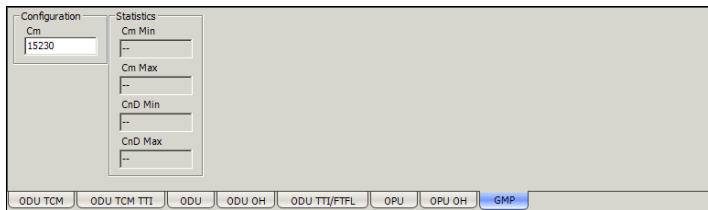

Configuration

Note: Only available for Ethernet in ODUflex over ODU3. Not supported with ODUflex CBR test case. This value is set to **15230** for Ethernet in ODUflex over ODU2.

Cm corresponds to the number of payload bytes per framed transported. Choices are from **15165** to **15230** bytes. The default setting is **15230** bytes. A minimum Cm value higher than 15165 may be imposed in order to guarantee that no packet is lost.

Statistics

Cm Min and **Cm Max:** Indicates respectively the minimum and maximum Cm values transmitted during the test.

CnD Min and **CnD Max:** Indicates respectively the minimum and maximum CnD values transmitted during the test.

GMP RX

Generic Mapping Procedure (GMP) is available with GFP-F over ODUflex, GFP-T over ODU0, and SONET/SDH over ODU0. GMP is available on both HO and LO for ODU0 over ODU2 or ODU0 over ODU3 mapping.

Press **TEST**, **ODUk**, and **GMP** (under **ODUk RX**).

Alarm Analysis		
H	C	Seconds
●	●	GMP OOS

Error Analysis				
H	C	Seconds	Count	Rate
●	●	Cm CRC-8	--	--
●	●	CnD CRC-5	--	--

Statistics	
Cm Min	--
Cm Max	--
CnD Min	--
CnD Max	--

ODU TCM | ODU TCM TT | ODU | ODU OH | ODU TT/FTL | OPU | OPU OH | **GMP**

Alarm Analysis

GMP OOS (Generic Mapping Procedure Out Of Synchronization): Indicates that the GMP RX cannot synchronize with the GMP TX.

Error Analysis

Cm CRC-8: Indicates Cm CRC-8 mismatch between received value and locally computed value.

CnD CRC-5: Indicates CnD CRC-5 mismatch between received value and locally computed value.

Statistics

Cm Min and **Cm Max**: Indicates respectively the minimum and maximum Cm value captured during the test.

CnD Min and **CnD Max**: Indicates respectively the minimum and maximum CnD value captured during the test.

11 SONET Tabs

The SONET tabs allow configuration of different test parameters and display the test status and results.

Note: *The available tabs listed are a function of the test path activated.*

SONET	Tab	Page
Section	<i>Section TX (SONET)</i>	213
	<i>Section RX (SONET)</i>	219
	<i>Section OH TX/RX (SONET)</i>	221
	<i>Performance Monitoring (PM)^a</i>	504
Line	<i>Line TX (SONET)</i>	223
	<i>Line RX (SONET)</i>	228
	<i>Line OH TX/RX (SONET)</i>	234
	<i>APS/Advanced Line OH TX/RX (SONET)</i>	236
	<i>Performance Monitoring (PM)^a</i>	504
HOP	<i>HOP TX (SONET)</i>	245
	<i>HOP RX (SONET)</i>	251
	<i>HOP OH TX/RX (SONET)</i>	254
	<i>HOP/LOP Pointer Adjust TX (SONET/SDH)^a</i>	492
	<i>HOP/LOP Pointer Adjust RX (SONET/SDH)^a</i>	495
	<i>TCM TX^{ab}</i>	497
	<i>TCM RX^{ab}</i>	500
	<i>Performance Monitoring (PM)^a</i>	504

SONET Tabs

SONET	Tab	Page
LOP ^b	<i>LOP TX (SONET)</i>	257
	<i>LOP RX (SONET)</i>	263
	<i>LOP OH TX/RX (SONET)</i>	266
	<i>HOP/LOP Pointer Adjust TX (SONET/SDH)^a</i>	492
	<i>HOP/LOP Pointer Adjust RX (SONET/SDH)^a</i>	495
	<i>TCM TX^a</i>	497
	<i>TCM RX^a</i>	500
	<i>Performance Monitoring (PM)^a</i>	504

- a. These tabs are described in *Common Tabs* on page 491.
b. Not available on the IQS-8140.

Section TX (SONET)

Press **TEST**, **Sec-Line**, and **Section** (under **Sec-Line TX**).

The screenshot shows the SONET configuration interface. The 'Error Injection' section has three radio buttons: 'Manual' (selected), 'Rate', and 'Burst'. The 'Type' dropdown is set to 'B1' and the 'Amount' text box contains '1'. A 'Send' button is to the right. Below this, the 'Alarm Generation' section has two radio buttons: 'Continuous' (selected) and 'Burst'. The 'Type' dropdown is set to 'LOF'. An 'On/Off' button with a green indicator is to the right. To the right of the main settings is a 'J0 Trace' section with a 'Format' dropdown, a 'Message' text area, and two checkboxes: 'Enable Trace' (unchecked) and 'Overwrite' (unchecked). At the bottom, there are tabs: 'Section' (selected), 'Section OH', 'Line', 'Line OH', and 'APS/Adv Line OH'.

Error Injection

Allows **Manual**, **Rate**, or **Burst** error injection methods.

The first screenshot shows the 'Error Injection' section with 'Manual' selected, 'Type' set to 'B1', and 'Amount' set to '1'. A 'Send' button is present. The second screenshot shows the 'Error Injection' section with 'Rate' selected, 'Type' set to 'B1', and 'Rate' set to '2.5E-05'. There is an unchecked 'Continuous' checkbox and an 'On/Off' button with a green indicator. The third screenshot shows the 'Error Injection' section with 'Burst' selected, 'Type' set to 'Single', 'Duration' set to '1', and 'Unit' set to 'Frames'. There is an 'On/Off' button with a green indicator.

➤ **Type:** The following errors are available: **B1** and **FAS**.

SONET Tabs

Section TX (SONET)

For **Manual** method:

- **Amount:** Select the amount of manual error to be generated. Choices are **1** through **50**. The default setting is **1**.
- **Send** button: Press **Send** to manually generate error(s) according to the **Error Type** and the **Amount of Errors** selected.

For **Rate** method:

- **Rate:** Select the injection rate for the selected error. The rate must be within the minimum and maximum values specified.
- **Continuous:** Generates the selected error to its theoretical maximum rate when the **Continuous** check box is selected. The **Continuous** check box is cleared by default.
- **On/Off** button: The On/Off button is used to activate/deactivate the selected error at the rate specified or at its theoretical maximum rate when the **Continuous** check box is selected. This setting is disabled (Off) by default.

For **Burst** method:

The burst method injects the programmed number of consecutive errored frames, representing the burst duration (M), over a specific event period (N).

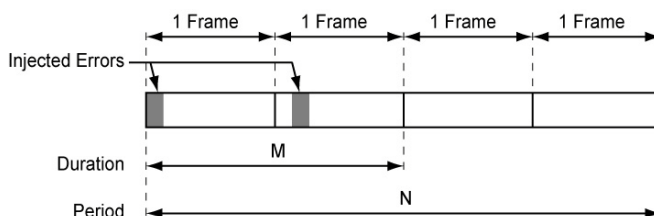

- **Duration and Unit:** Select the number of consecutive errored frames or the number of consecutive seconds in error.
- **Mode:** Allows the selection of the burst mode that will determine if the burst will be repeated (**Repeat**) at the beginning of each period or not (**Single**).
- **Period and Unit:** When the **Mode** is set to **Repeat**, select the interval, either in frames or in seconds, the error burst will be repeated.
- **On/Off** button: The On/Off button is used to activate/deactivate the selected error for the selected **Duration** and **Period**. For **Single Mode**, the injection will be active for the specified duration and will automatically stop (the On/Off button turns Off). For **Repeat Mode** the error injection will be active for the specified duration and will be repeated continuously at the beginning of each period until the On/Off button is turned Off. This setting is disabled (Off) by default.

Alarm Generation

Allows **Continuous** or **Burst** alarm generation methods.

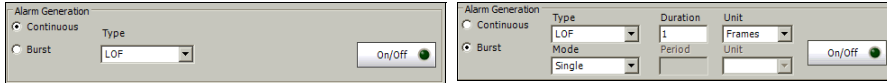

➤ **Type**

LOF (Loss Of Frame): Generates non-valid framing bytes (A1 and A2).

SEF (Severely Errored Framing): Generates four consecutive errored framing patterns.

For **Continuous** method:

- **On/Off** button: The On/Off button is used to activate/deactivate the selected alarm. This setting is disabled (Off) by default. Exceptionally for continuous SEF alarm, the On/Off button turns Off once the SEF alarm has been sent.

For **Burst** method:

The burst method injects the programmed number of consecutive alarmed frames, representing the burst **Duration** (M), over a specific event **Period** (N).

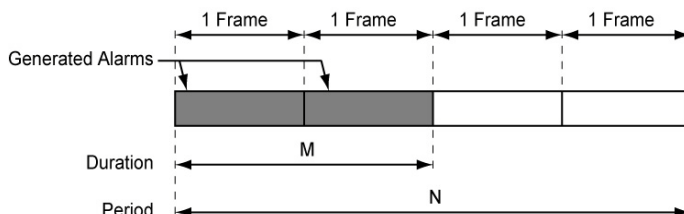

- **Duration and Unit:** Select the number of consecutive alarmed frames or the number of consecutive seconds in alarm.
- **Mode:** Allows the selection of the burst mode that will determine if the burst will be repeated (**Repeat**) at the beginning of each period or not (**Single**).
- **Period and Unit:** When the **Mode** is set to **Repeat**, select the interval, either in frames or in seconds, the alarm burst will be repeated.
- **On/Off button:** The On/Off button is used to activate/deactivate the selected alarm for the selected **Duration** and **Period**. For **Single Mode**, the alarm generation will be active for the specified duration and will automatically stop (the On/Off button turns Off). For **Repeat Mode** the alarm generation will be active for the specified duration and will be repeated continuously at the beginning of each period until the On/Off button is turned Off. This setting is disabled (Off) by default.

J0 Trace

- **Format:** Displays the J0 value in **16** or **64 bytes** format. The default setting is **16 bytes**.
- **Message:** Enter the J0 trace value in 16 or 64 bytes format as selected. The default message is **EXFO SONET/SDH** for 16 bytes and **EXFO SONET/SDH Analyzer Section/RS trace test message** for 64 bytes.
- **Enable Trace:** Generates the defined J0 Trace message except for **SONET/SDH Intrusive** mode (see **Overwrite**) when the **Enable Trace** check box is selected. The **Enable Trace** check box has to be selected to give access to the trace format and message. When the **Enable Trace** check box is cleared, the J0 1-byte format is used and can be configured from the *Section OH TX* on page 221.
- **Overwrite:** Available with **SONET/SDH Intrusive** through mode only (optional). Overwrite is not available on IQS-8105/IQS-8115. The **Overwrite** check box when selected, generates the defined J0 Trace message. The **Enable Trace** check box has to be selected to give access to the trace **Format, Message, and Overwrite**.

Note: *16-bytes selection allows typing up to 15 bytes (a CRC-7 byte will be added in front for a total of 16 bytes). 64-bytes selection allows typing up to 62-bytes (<C_R> and <L_F> bytes will be added at the end for a total of 64-bytes).*

Section RX (SONET)

Press **TEST**, **Sec-Line**, and **Section** (under **Sec-Line RX**).

Error Analysis

FAS (Frame Alignment Signal): A FAS defect indicates that at least one A1 or A2 byte of the FAS word is in error.

B1 (BIP-8, Bit-Interleave Parity - 8 bits): The B1 (BIP-8) error indicates a Section parity error by performing a routine even-parity check over all frames of the previous STS-n signal (located in the first STS-1 of an STS-n signal).

Alarm Analysis

- **SEF** (Severely Errored Framing): A SEF defect indicates that a minimum of four consecutive errored framing patterns are received.
- **LOF** (Loss Of Frame): A Loss Of Frame alarm indicates that a Severely Error Framing (SEF) defect on the incoming SONET signal persists for at least 3 milliseconds.
- **TIM-S** (Trace Identifier Mismatch - Section): The TIM-S defect indicates that the received J0 Trace doesn't match the expected message value. The TIM-S alarm is only available when **Enable TIM-S** check box from J0 Trace section has been selected.

J0 Trace

- **Received Message:** Displays the received J0 value. The <crc7> represents the CRC-7 for a 16-bytes format. The last two bytes of a 64-bytes format, <C_R> and <L_F>, represent respectively a carriage return and a line feed.
- **Enable TIM-S (Trace Identifier Mismatch - Section):** Allows enabling the Trace Identifier Mismatch for the expected message defined. **Enable TIM-S** has to be enabled to give access to the expected trace format and message.
- **Expected Message:** Allows entering the expected J0 Trace message. J0 value should be ASCII suitable characters. The default message is **EXFO SONET/SDH** for 16 bytes and **EXFO SONET/SDH Analyzer Section/RS trace test message** for 64 bytes.
- **Expected Format:** Allows the selection of the expected format: 16 or 64 bytes. The default setting is **16 bytes**.

Section OH TX/RX (SONET)

The **Section OH TX** allows changing the transport overhead information to be transmitted while the **Section OH RX** allows verification of the transport overhead information received. Refer to *Glossary* on page 573 for detailed overhead information.

Press **TEST**, **Sec-Line**, and **Section OH** (under **Sec-Line TX/RX**).

The screenshot displays two overlapping windows of the SONET configuration interface. The top window is titled 'Section Overhead' and shows the 'TX' configuration. It includes a 'Timeslot' field set to '1', an 'Overwrite' checkbox, and a grid of fields for A1, A2, J0, D1, B1, E1, F1, D2, and D3. A 'Disable All' button is also present. The bottom window shows the 'RX' configuration, with the 'Timeslot' field set to '00' and the grid fields containing dashes ('--'). Both windows have a navigation bar at the bottom with tabs for 'Section', 'Section OH', 'Section PM', 'Line', 'Line OH', 'APS/Adv Line OH', and 'Line PM'.

Section Overhead

- **Timeslot:** Select the timeslot number that will be used for verification. Choices are **1 to 3, 12, 48, 192, or 768** depending on the OC-N interface selected. The default setting is **1**.

SONET Tabs

Section OH TX/RX (SONET)

The following controls are available with **SONET/SDH Intrusive** through mode only (optional):

- The **Overwrite** check box when enabled, allows the generation of the selected byte. The byte can be selected by clicking on its blue label. The byte having its **Overwrite** check box selected will have its hexadecimal value on a yellow background. A byte having its hexadecimal value with a gray background cannot be overwritten.
- The **Overwrite** LED indicates if there is any byte in any timeslot having the **Overwrite** check box selected (LED is green) or not (LED is gray).
- **Disable All** allows to clear the **Overwrite** check box for all bytes in all timeslots.

The following section overhead byte values are displayed in hexadecimal format. However, a common field allows to see the value of specific byte in binary format. Click on the blue label of a byte and its binary value will be displayed in the common field beside the **Timeslot** selection.

- **A1** and **A2**: Framing. The value should be hexadecimal **F6** for A1 and **28** for A2.
- **J0/Z0**
 - J0**: Trace: STS-1 #1 of an electrical or OC-N signal. J0 is only available when the **Enable Trace** check box from the *Section TX (SONET)* on page 213 is cleared.
 - Z0**: Growth: STS-1 #2 to STS-1 #N of a OC-N signal.
- **B1**: BIP-8. This byte is not programmable from this tab
- **E1**: Orderwire.
- **F1**: User.
- **D1, D2, and D3**: Data Communications Channel (DCC).

Line TX (SONET)

Press **TEST**, **Sec-Line**, and **Line** (under **Sec-Line TX**).

The screenshot shows a configuration window for Line TX (SONET). It features two main sections: 'Error Injection' and 'Alarm Generation'. In the 'Error Injection' section, the 'Manual' radio button is selected. The 'Type' dropdown is set to 'B2' and the 'Amount' text box contains the value '1'. A 'Send' button is located to the right. In the 'Alarm Generation' section, the 'Continuous' radio button is selected. The 'Type' dropdown is set to 'AIS-L'. An 'On/Off' button with a green indicator is to the right. At the bottom, a navigation bar shows 'Section', 'Section OH', 'Line' (highlighted), 'Line OH', and 'APS/Adv Line OH'.

Error Injection

Allows **Manual**, **Rate**, or **Burst** error injection methods.

The image displays three different configurations for the Error Injection window. The top-left configuration has 'Manual' selected, 'Type' set to 'B2', and 'Amount' set to '1'. The top-right configuration has 'Rate' selected, 'Type' set to 'B2', 'Rate' set to '1.2E-03', and the 'Continuous' checkbox checked. The bottom configuration has 'Burst' selected, 'Type' set to 'Single', 'Duration' set to '1', and 'Unit' set to 'Frames'.

- **Type:** The following errors are available: **B2** (BIP-8), and **REI-L** (Remote Error Indication). The default setting is **B2**.

SONET Tabs

Line TX (SONET)

For **Manual** method:

- **Amount:** Select the amount of manual error to be generated. Choices are **1** through **50**. The default setting is **1**.
- **Send** button: Press **Send** to manually generate error(s) according to the **Error Type** and the **Amount of Errors** selected.

For **Rate** method:

- **Rate:** Select the injection rate for the selected error. The rate must be within the minimum and maximum values specified.
- **Continuous:** Generates the selected error to its theoretical maximum rate when the **Continuous** check box is selected. The **Continuous** check box is cleared by default.
- **On/Off** button: The On/Off button is used to activate/deactivate the selected error at the rate specified or at its theoretical maximum rate when the **Continuous** check box is selected. This setting is disabled (Off) by default.

For **Burst** method:

The burst method injects the programmed number of consecutive errored frames, representing the burst duration (M), over a specific event period (N).

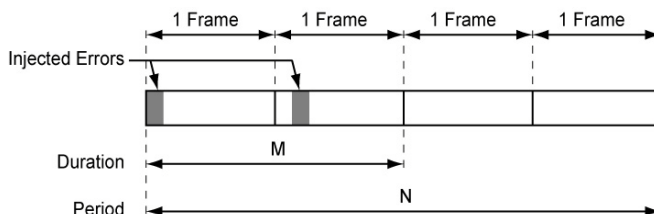

- **Duration and Unit:** Select the number of consecutive errored frames or the number of consecutive seconds in error.
- **Mode:** Allows the selection of the burst mode that will determine if the burst will be repeated (**Repeat**) at the beginning of each period or not (**Single**).
- **Period and Unit:** When the **Mode** is set to **Repeat**, select the interval, either in frames or in seconds, the error burst will be repeated.
- **On/Off** button: The On/Off button is used to activate/deactivate the selected error for the selected **Duration** and **Period**. For **Single Mode**, the injection will be active for the specified duration and will automatically stop (the On/Off button turns Off). For **Repeat Mode** the error injection will be active for the specified duration and will be repeated continuously at the beginning of each period until the On/Off button is turned Off. This setting is disabled (Off) by default.

Alarm Generation

Allows **Continuous** or **Burst** alarm generation methods.

The image displays two screenshots of the 'Alarm Generation' configuration window. The left screenshot shows the 'Continuous' method selected, with a 'Type' dropdown menu set to 'AIS-L' and an 'On/Off' button. The right screenshot shows the 'Burst' method selected, with a 'Type' dropdown menu set to 'AIS-L', a 'Mode' dropdown menu set to 'Single', a 'Duration' field set to '1', and a 'Unit' dropdown menu set to 'Frames'. Both screenshots include an 'On/Off' button with a green indicator light.

► Type

AIS-L (Alarm Indication Signal - Line): Generates a SONET signal that contains a valid Section Overhead (SOH) and an all-ones pattern on the SPE.

RDI-L (Remote Defect Indication - Line): Generates a “110” pattern for the bits 6, 7 and 8 of the K2 byte.

The default setting is **AIS-L**.

For **Continuous** method:

- **On/Off** button: The On/Off button is used to activate/deactivate the selected alarm. This setting is disabled (Off) by default.

For **Burst** method:

The burst method injects the programmed number of consecutive alarmed frames, representing the burst **Duration** (M), over a specific event **Period** (N).

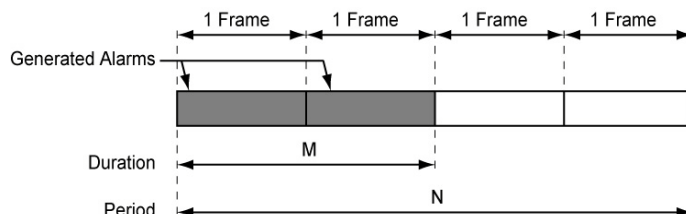

- **Duration and Unit:** Select the number of consecutive alarmed frames or the number of consecutive seconds in alarm.
- **Mode:** Allows the selection of the burst mode that will determine if the burst will be repeated (**Repeat**) at the beginning of each period or not (**Single**).
- **Period and Unit:** When the **Mode** is set to **Repeat**, select the interval, either in frames or in seconds, the alarm burst will be repeated.
- **On/Off button:** The On/Off button is used to activate/deactivate the selected alarm for the selected **Duration** and **Period**. For **Single Mode**, the alarm generation will be active for the specified duration and will automatically stop (the On/Off button turns Off). For **Repeat Mode** the alarm generation will be active for the specified duration and will be repeated continuously at the beginning of each period until the On/Off button is turned Off. This setting is disabled (Off) by default.

Line RX (SONET)

Press **TEST**, **Sec-Line**, and **Line** (under **Sec-Line RX**).

The screenshot displays a software interface for monitoring SONET Line RX. It features two main data tables: 'Error Analysis' and 'Alarm Analysis'. Below these tables is a navigation bar with several tabs: 'Section', 'Section OH', 'Section PM', 'Line' (which is currently selected and highlighted in blue), 'Line OH', 'APS/Adv Line OH', and 'Line PM'.

Error Analysis					
H	C	Seconds	Count	Rate	
<input type="radio"/>	<input type="radio"/>	B2	--	--	--
<input type="radio"/>	<input type="radio"/>	REI-L	--	--	--

Alarm Analysis			
H	C	Seconds	
<input type="radio"/>	<input type="radio"/>	AIS-L	--
<input type="radio"/>	<input type="radio"/>	RDI-L	--

Section | Section OH | Section PM | **Line** | Line OH | APS/Adv Line OH | Line PM

Error Analysis

- **B2 (BIP-8, Bit-Interleave Parity - 8 bits):** The B2 (BIP-8) error indicates a Line parity error by performing an even-parity check over all bits of the LOH and SPE of the previous frame (located in every STS-1 of an STS-n signal).

➤ **REI-L** (Remote Error Indicator - Line):

For STS-1e: The REI-L error is declared when the M0 byte located in the first STS-1 indicates that one or more BIP violations have been detected.

M0, bits 234 5678	Indicates
000 0000	0 BIP violation
000 0001	1 BIP violation
000 0010	2 BIP violations
:	:
000 1000	8 BIP violations
000 1001	0 BIP violation
:	:
111 1111	0 BIP violation

SONET Tabs

Line RX (SONET)

For STS-3e and OC-3: The REI-L error is declared when the M1 byte located in the STS-1 #3 indicates that one or more BIP violations have been detected

M1, bits 234 5678	Indicates
000 0000	0 BIP violation
000 0001	1 BIP violation
000 0010	2 BIP violations
:	:
001 1000	24 BIP violations
001 1001	0 BIP violation
:	:
111 1111	0 BIP violation

For OC-12: The REI-L error is declared when the M1 byte located in the STS-1 #7 indicates that one or more BIP violations have been detected.

M1, bits 234 5678	Indicates
000 0000	0 BIP violation
000 0001	1 BIP violation
000 0010	2 BIP violations
:	:
110 0000	96 BIP violations
110 0001	0 BIP violation
:	:
111 1111	0 BIP violation

For OC-48: The REI-L error is declared when the M1 byte located in the STS-1 #7 indicates that one or more BIP violations have been detected.

M1	Indicates
0000 0000	0 BIP violation
0000 0001	1 BIP violation
0000 0010	2 BIP violations
:	:
1111 1111	255 BIP violations

SONET Tabs

Line RX (SONET)

For OC-192: The REI-L error is declared when either the M1 byte located in the STS-1 #7 indicates that one or more BIP violations have been detected, or the combination of the M0 and M1 bytes indicates that one or more BIP violations have been detected. Refer to *OC-192/STM-64 REI-L/MS-REI* on page 542 for REI-L computation method.

M1	Indicates
0000 0000	0 BIP violation
0000 0001	1 BIP violation
0000 0010	2 BIP violations
:	:
1111 1111	255 BIP violations

M0 Located in STS-1 #4	M1 Located in STS-1 #7	Indicates
0000 0000	0000 0000	0 BIP violation
0000 0000	0000 0001	1 BIP violation
0000 0000	0000 0010	2 BIP violations
:	:	
0000 0110	0000 0000	1536 BIP violations
0000 0110	0000 0001	0 BIP violation
:		:
1111 1111	1111 1111	0 BIP violation

For OC-768: The REI-L error is declared when the combination of the M0 and M1 bytes indicates that one or more BIP violations have been detected.

M0 Located in STS-1 #4	M1 Located in STS-1 #7	Indicates
0000 0000	0000 0000	0 BIP violation
0000 0000	0000 0001	1 BIP violation
0000 0000	0000 0010	2 BIP violations
:	:	
0001 1000	0000 0000	6144 BIP violations
0001 1000	0000 0001	0 BIP violation
:		:
1111 1111	1111 1111	0 BIP violation

Alarm Analysis

- **AIS-L** (Alarm Indication Signal - Line): The AIS-L alarm is declared when bits 6, 7 and 8 of the K2 byte contain the “111” pattern in five consecutive frames.
- **RDI-L** (Remote Defect Indication - Line): The RDI-L alarm is declared when bits 6, 7, and 8 of the K2 byte contain the “110” pattern in five consecutive frames.

SONET Tabs

Line OH TX/RX (SONET)

Line OH TX/RX (SONET)

The Line OH TX allows changing the line overhead information to be transmitted while the Line OH RX allows verification of the line overhead information received.

Press **TEST**, **Sec-Line**, and **Line OH** (under **Sec-Line TX/RX**).

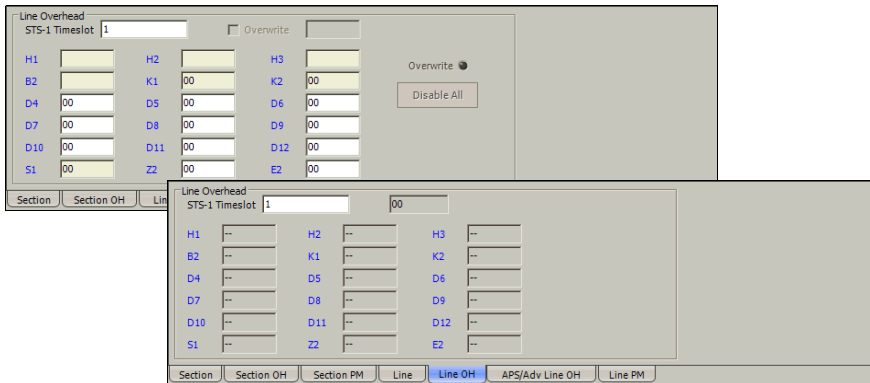

Line Overhead

- **Timeslot:** Select the timeslot number that will be used for the test.

Choices are **1 to 3, 12, 48, 192, or 768** depending on the OC-N interface selected. The default setting is **1**.

The following controls are available with **SONET/SDH Intrusive** through mode only (optional):

- The **Overwrite** check box when enabled, allows the generation of the selected byte. The byte can be selected by clicking on its blue label. The byte having its **Overwrite** check box selected will have its hexadecimal value on a yellow background. A byte having its hexadecimal value with a gray background cannot be overwritten.

- The **Overwrite** LED indicates if there is any byte in any timeslot having the **Overwrite** check box selected (LED is green) or not (LED is gray).
- **Disable All** allows to clear the **Overwrite** check box for all bytes in all timeslots.

The following overhead byte values are displayed in hexadecimal format. However, a common field allows to see the value of specific byte in binary format. Click on the blue label of a byte and its binary value will be displayed in the common field beside the **Timeslot** selection.

- **H1** and **H2**: Pointer
- **H3**: Pointer Action
- **B2**: BIP-8
- **K1** and **K2**: Automatic Protection Switching (APS)
- **D4** through **D12**: Data Communications Channel (DCC)
- **S1/Z1**
 - S1**: Synchronization Status (STS-1 #1 of an electrical or OC-N signal)
 - Z1**: Growth (STS-1 #2, STS-1 #3, up to STS-1 #N of a OC-N (N>3) signal)
- **M0** or **M1/Z2**
 - M0**: REI-L (STS-1 #1 of an STS-1e signal; STS-1 #4 of OC-192/OC-768 signal)
 - M1**: REI-L (STS-1 #3 of STS-3e or OC-3 signal; STS-1 #7 of an OC-12/OC-48/OC-192/OC-768 signal)
 - Z2**: Growth (STS-1 #1 up to STS-1 #48 except for timeslots used by M0 and M1).
 - Undefined "--"** for all other timeslots not covered by M0, M1, and Z2.
- **E2**: Orderwire

SONET Tabs

APS/Advanced Line OH TX/RX (SONET)

APS/Advanced Line OH TX/RX (SONET)

The Line OH TX allows changing the line overhead information to be transmitted while the Line OH RX allows verification of the line overhead information received.

Press **TEST**, **Sec-Line**, and **APS/Adv Line OH** (under **Sec-Line TX/RX**).

The image displays two screenshots of a software interface for configuring APS/Advanced Line OH TX/RX. The top screenshot shows the 'Section OH' tab with the following settings: APS Switching Mode is 'Linear' (with an 'Override' checkbox), K1 Request is 'No Request (0000)' and Channel is '0 - Null', K2 Protected Channel is '0 - Null', Architecture is '1+1', and Operation Mode is 'Reserved (000)'. H1 SS Bits (H1) is '00' (with an 'Override' checkbox), and S1 Bits 1-4 is '0000'. The S1 Bits 5-8 (Synchronization Status Message) is set to 'Synchronized - Traceability Unknown (STU) (0000)'. The bottom screenshot shows the 'APS/Adv Line OH' tab, which includes a 'File Setup' button, a 'Transitions' field set to '50', and a 'Capture' button with a green indicator. The bottom navigation bar shows tabs for Section, Section OH, Section PM, Line, Line OH, APS/Adv Line OH (selected), and Line PM.

Gives access to the advanced section of the **Line OH TX/RX** signal.

APS

➤ Switching Mode

Allows the switching mode selection and is available on both TX and RX tabs. Choices are **Linear** and **Ring**. The default setting is **Linear**.

- **Override:** The **Override** check box when selected, allows the activation of the APS. **Override** is available with **SONET/SDH Intrusive** mode only.

➤ **K1**

- **Request:** Bits 1 through 4 of the K1 byte. The default setting is **No Request** (0000). Choices are:

Bits 1 to 4	Linear mode	Ring mode
0000	No Request	No Request
0001	Do Not Revert	Reverse Request - Ring
0010	Reverse Request	Reverse Request - Span
0011	Not Used	Exerciser - Ring
0100	Exerciser	Exerciser - Span
0101	Not Used	Wait-to-Restore
0110	Wait-to-Restore	Manual Switch - Ring
0111	Not Used	Manual Switch - Span
1000	Manual Switch	Signal Degrade - Ring
1001	Not Used	Signal Degrade - Span
1010	Signal Degrade - Low Priority	Signal Degrade -Protection
1011	Signal Degrade - High Priority	Signal Fail Ring
1100	Signal Fail - Low Priority	Signal Fail Span
1101	Signal Fail - High Priority	Force Switch - Ring
1110	Force Switch	Force Switch -Span
1111	Lockout of Protection	Lockout of Protection - Span/SF - P

SONET Tabs

APS/Advanced Line OH TX/RX (SONET)

► Channel/Destination Node ID

Bits 5 through 8 of the K1 byte. Channel if available with Linear switching mode while Destination Node ID is available with Ring switching mode. The default setting is **Null Channel** for **Linear** switching mode and **0** for **Ring** switching mode.

Bits 5 to 8	Channel ID (Linear mode)	Destination Node ID (Ring mode)
0000	0 - Null	0
0001	1	1
0010	2	2
0011	3	3
0100	4	4
0101	5	5
0110	6	6
0111	7	7
1000	8	8
1001	9	9
1010	10	10
1011	11	11
1100	12	12
1101	13	13
1110	14	14
1111	15 - Extra Traffic	15

- **K2**
 - **Protected Channel/Source Node ID:** Bits 1 through 4 of the K2 byte. **Protected Channel** is available with **Linear** switching mode while Source Node ID is available with **Ring** switching mode. The default setting is **Null Channel** for **Linear** switching mode and **0** for **Ring** switching mode.

Bits 1 to 4	Protected Channel (Linear mode)	Source Node ID (Ring mode)
0000	0 - Null	0
0001	1	1
0010	2	2
0011	3	3
0100	4	4
0101	5	5
0110	6	6
0111	7	7
1000	8	8
1001	9	9
1010	10	10
1011	11	11
1100	12	12
1101	13	13
1110	14	14
1111	15 - Extra Traffic	15

SONET Tabs

APS/Advanced Line OH TX/RX (SONET)

- **Architecture/Bridge Request:** Bit 5 of the K2 byte. **Architecture** is available with **Linear** switching mode while **Bridge Request** is available with **Ring** switching mode. The default setting is **1+1** for Linear switching mode and **Short Path Request** for Ring switching mode.

Bit 5	Architecture (Linear mode)	Bridge Request (Ring mode)
0	1+1	Short Path
1	1:n	Long Path

- **Operation Mode:** Bits 6 through 8 of the K2 byte. The default setting is **Reserved (000)** for Linear switching mode and **Idle** for Ring switching mode.

Bits 6 to 8	Linear mode	Ring mode
000	Reserved	Idle
001	Reserved	Bridged
010	Reserved	Bridged and Switched
011	Reserved	Extra Traffic - Protection
100	Unidirectional	Reserved
101	Bidirectional	Reserved
110	RDI-L	RDI-L
111	AIS-L	AIS-L

K1-K2 Capture

This feature allows to capture and save the K1/K2 byte transitions to a text file on disk. Not available on IQS-8105 and IQS-8115.

Once generated and saved, the K1/K2 capture file can be loaded using Windows File Manager. The default directory is

d:\IQSManager\User Files\SonetSdhAnalyzerG2\Reports under Windows XP and **Documents\User Files\SonetSdhAnalyzerG2\Reports** under Windows 8. The following is an example of captured K1/K2 byte transition file.

```
*****
Start Capture
Transitions  K1      K2      Time to detect (Frames)
              0:    A0      02      >32768
              1:    A0      00      >32768
              2:    00      00      --
End Capture
*****

*****
Start Capture
Transitions  K1      K2      Time to detect (Frames)
              0:    00      00      23666
              1:    20      00      14995
              2:    60      00      22172
              3:    C0      00      >32768
              4:    B0      00      24659
              5:    00      00      --
End Capture
*****
```

Note: The transition #0, indicates the state of K1 and K2 before the capture starts.

SONET Tabs

APS/Advanced Line OH TX/RX (SONET)

➤ **Files Setup**

Press the **File Setup** button to select the file that will be used to save the captured K1/K2 byte transitions. Selecting a new file name will create an empty file on disk that will be used to capture the K1/K2 byte transitions. Selecting an existing file name will overwrite the existing file.

➤ **Transitions**

Allows to select the number of K1/K2 byte transitions that will be captured. Once the number of K1/K2 byte transitions is reached, the capture stops (the **Capture** button LED turns off).

➤ **Capture**

Press the **Capture** button to enable the K1/K2 capture process. However the capture will only start when the test is started. The **Capture** button is only available when a file has been selected (see **File Setup** button).

If the capture is restarted, the content of the file will be appended.

H1

- **SS Bits (H1):** Bits 5 and 6 of the H1 byte represent the SS bits.

SS Bits	Description
00	SONET
01	Undefined
10	SDH
11	Undefined

- **Overwrite:** The **Overwrite** check box when selected, allows the generation of the selected **SS Bits**. **Overwrite** is available with **SONET/SDH Intrusive** mode only. In normal mode, the SS Bits are written on all timeslots (foreground and background). When **SONET/SDH Intrusive** is selected, the **SS Bits** are written on the foreground timeslots only.

SONET Tabs

APS/Advanced Line OH TX/RX (SONET)

S1

- **Overwrite:** The **Overwrite** check box when selected, allows the generation of the selected **S1** bits. **Overwrite** is available with **SONET/SDH Intrusive** mode only.
- **Bits 1-4:** Bits 1 through 4 of the S1 byte are currently undefined but can be set from 0000 to 1111 if required.
- **Bits 5-8 (Synchronization Status Message):** Bits 5 through 8 of the S1 byte are used to convey synchronization status of the NE. The default setting is **Synchronized - Traceability Unknown (0000)**. Choices are:

Bits 5 to 8	Description	Bits 5 to 8	Description
0000	Synchronized - Traceability Unknown	1000	Reserved
0001	Stratum 1 Traceable	1001	Reserved
0010	Reserved	1010	Stratum 3 Traceable
0011	Reserved	1011	Reserved
0100	Transit Node Clock Traceable	1100	SONET Minimum Clock Traceable
0101	Reserved	1101	Stratum 3E Traceable
0110	Reserved	1110	Provisionable by the Network Operator
0111	Stratum 2 Traceable	1111	Don't Use for Synchronization

HOP TX (SONET)

Press **TEST**, **HOP**, and **Path** (under **HOP TX**).

Error Injection

Allows **Manual**, **Rate**, or **Burst** error injection methods.

- **Type:** The following errors are available with both manual and automated injection modes: **B3** (BIP-8, Bit-Interleave Parity - 8 bits), and **REI-P** (Remote Error Indicator - Path).

SONET Tabs

HOP TX (SONET)

For **Manual** method:

- **Amount:** Select the amount of manual error to be generated. Choices are **1** through **50**. The default setting is **1**.
- **Send** button: Press **Send** to manually generate error(s) according to the **Error Type** and the **Amount of Errors** selected.

For **Rate** method:

- **Rate:** Select the injection rate for the selected error. The rate must be within the minimum and maximum values specified.
- **Continuous:** Generates the selected error to its theoretical maximum rate when the **Continuous** check box is selected. The **Continuous** check box is cleared by default.
- **On/Off** button: The On/Off button is used to activate/deactivate the selected error at the rate specified or at its theoretical maximum rate when the **Continuous** check box is selected. This setting is disabled (Off) by default.

For **Burst** method:

The burst method injects the programmed number of consecutive errored frames, representing the burst duration (M), over a specific event period (N).

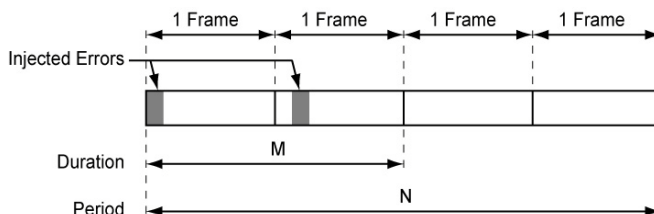

- **Duration and Unit:** Select the number of consecutive errored frames or the number of consecutive seconds in error.
- **Mode:** Allows the selection of the burst mode that will determine if the burst will be repeated (**Repeat**) at the beginning of each period or not (**Single**).
- **Period and Unit:** When the **Mode** is set to **Repeat**, select the interval, either in frames or in seconds, the error burst will be repeated.
- **On/Off** button: The On/Off button is used to activate/deactivate the selected error for the selected **Duration** and **Period**. For **Single Mode**, the injection will be active for the specified duration and will automatically stop (the On/Off button turns Off). For **Repeat Mode** the error injection will be active for the specified duration and will be repeated continuously at the beginning of each period until the On/Off button is turned Off. This setting is disabled (Off) by default.

Alarm Generation

Allows **Continuous** or **Burst** alarm generation methods.

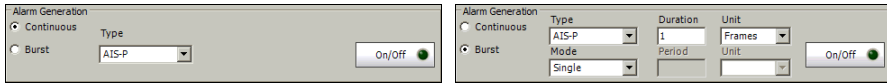

Type

- **AIS-P** (Alarm Indication Signal - Path): Generates an all-ones pattern over H1, H2, H3, and SPE.
- **RDI-P** (Remote Defect Indication - Path): Generates a “100” pattern for bits 5, 6 and 7 of the G1 byte.
- **ERDI-PSD** (Enhanced RDI - Path Server Defect): Generates a “101” pattern for bits 5, 6 and 7 of the G1 byte.
- **ERDI-PCD** (Enhanced RDI - Path Connectivity Defect): Generates a “110” pattern for bits 5, 6 and 7 of the G1 byte.
- **ERDI-PPD** (Enhanced RDI - Path Payload Defect): Generates a “010” pattern for bits 5, 6 and 7 of the G1 byte.
- **LOM** (Loss Of Multiframe): Generates a wrong H4 byte multiframe indicator sequence. Not supported on the IQS-8140.
- **LOP-P** (Loss Of Pointer - Path): Generates a non-valid pointer.
- **PDI-P** (Payload Defect Indication - Path): For VT-structured STS-1 SPE, generates a VT-structured STS-1 SPE with payload defect. For non-VT-structured STS-1 or STS-Nc SPE, generates a payload defect by inserting the hexadecimal FC code in the C2 byte.
- **UNEQ-P** (Unequipped - Path): Generates an all-zeros pattern over POH and SPE.

For **Continuous** method:

- **On/Off** button: The On/Off button is used to activate/deactivate the selected alarm. This setting is disabled (Off) by default.

For **Burst** method:

The burst method injects the programmed number of consecutive alarmed frames, representing the burst **Duration** (M), over a specific event **Period** (N).

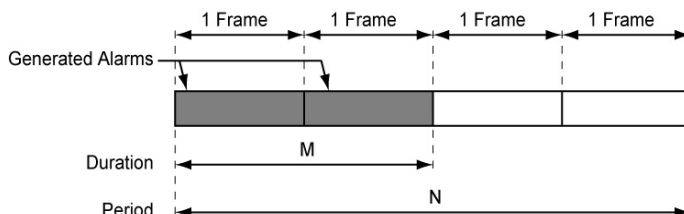

- **Duration and Unit:** Select the number of consecutive alarmed frames or the number of consecutive seconds in alarm.
- **Mode:** Allows the selection of the burst mode that will determine if the burst will be repeated (**Repeat**) at the beginning of each period or not (**Single**).
- **Period and Unit:** When the **Mode** is set to **Repeat**, select the interval, either in frames or in seconds, the alarm burst will be repeated.
- **On/Off button:** The On/Off button is used to activate/deactivate the selected alarm for the selected **Duration** and **Period**. For **Single Mode**, the alarm generation will be active for the specified duration and will automatically stop (the On/Off button turns Off). For **Repeat Mode** the alarm generation will be active for the specified duration and will be repeated continuously at the beginning of each period until the On/Off button is turned Off. This setting is disabled (Off) by default.

J1 Trace

- **Format:** Displays the J1 value in 16-bytes or 64-bytes format. Enter the J1 trace value in 16 or 64-bytes format as selected. The default setting is **16-bytes**.
- **Message:** Enter the J1 trace value in 16 or 64 bytes format as selected. The default message is **EXFO SONET/SDH** for 16 bytes and **EXFO SONET/SDH Analyzer high order path trace test message** for 64 bytes. However, with VCAT/LCAS the default message will be **EXFO** followed by the VCG number (VCAT and LCAS) and the SQ (VCAT only) number (for example **EXFO-VCG1-SQ0**) for both 16 and 64 bytes formats.
- **Enable Trace:** Generates the defined J1 Trace message defined except for **Intrusive** mode (see **Overwrite**) when the **Enable Trace** check box is selected. The **Enable Trace** check box has to be selected to give access to the trace format and message. When the **Enable Trace** check box is cleared, the J1 1-byte format is used and can be configured from the **HOP OH TX** on page 254.
- **Overwrite:** Available with **SONET/SDH Intrusive** through mode only (optional). Overwrite is not available on IQS-8105/IQS-8115. The **Overwrite** check box when selected, generates the defined J1 Trace message. The **Enable Trace** check box has to be selected to give access to the trace **Format, Message, and Overwrite**.

Note: *16-bytes selection allows typing up to 15 bytes (a CRC-7 byte will be added in front for a total of 16 bytes). 64-bytes selection allows typing up to 62-bytes (<C_R> and <L_F> bytes will be added at the end for a total of 64 bytes).*

HOP RX (SONET)

Press **TEST**, **HOP**, and **Path** (under **HOP RX**).

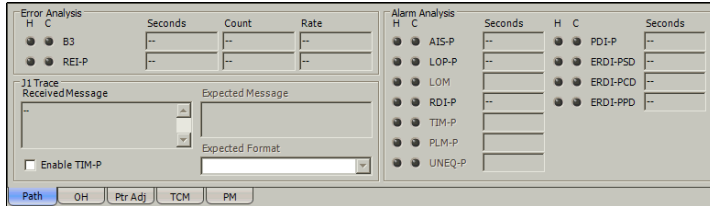

Error Analysis

- **B3** (BIP-8, Bit-Interleave Parity - 8 bits): The B3 (BIP-8) error indicates a Path parity error by performing an even-parity check over all bits of the previous SPE.
- **REI-P** (Remote Error Indicator - Path): The REI-P error is declared when bits 1 through 4 of the G1 byte contain one pattern from the following binary range: “0001” through “1000” (1 to 8) (located in every STS-1 of an STS-n signal).

Alarm Analysis

- **AIS-P** (Alarm Indication Signal - Path): The AIS-P alarm is declared when the H1 and H2 bytes for an STS path contain an all-ones pattern in three consecutive frames or more.
- **LOP-P** (Loss Of Pointer - Path): The LOP alarm indicates that a valid pointer is not found in N consecutive frames (where $8 \leq N \leq 10$), or that N consecutive NDFs (“1001” pattern) are detected (non-concatenated payloads).
- **LOM** (Loss Of Multiframe): For VT structured SONET frames, the LOM alarm indicates that the system loss track of the H4 byte multiframe indicator sequence. Not supported on the IQS-8140.
- **RDI-P** (Remote Defect Indication - Path): The RDI-P alarm is declared when bits 5, 6, and 7 of the G1 byte contain the “100” or “111” pattern in five consecutive frames.
- **TIM-P** (Trace Identifier Mismatch - Path): The TIM-P defect indicates that the received J1 Trace doesn’t match the expected message value. The TIM-P alarm is only available when **Enable TIM-P** check box from J1 Trace section has been selected.
- **PLM-P** (Payload Label Mismatch - Path): The PLM-P is declared upon receipt of five consecutive frames with mismatched STS signal labels (C2 byte).
- **UNEQ-P** (Unequipped - Path): UNEQ-P is declared when the C2 bytes contain “00 H” in five consecutive frames.
- **PDI-P** (Payload Defect Indication - Path): For VT-structured STS-1 SPE, the PDI-P is declared when detecting LOP-V, AIS-V, DS3 AIS, DS3 LOS, or DS3 OOF defect on any VT or DS3 payload that it embeds into the STS SPE that it is originating. For non-VT-structured STS-1 or STS-Nc SPE, and for IQS-8140, the PDI-P is declared when receiving the hexadecimal FC code (C2 byte).

- **ERDI-PSD** (Enhanced RDI - Path Server Defect): The ERDI-PSD alarm is declared when bits 5, 6 and 7 of the G1 byte contain the “101” pattern in five consecutive frames.
- **ERDI-PCD** (Enhanced RDI - Path Connectivity Defect): The ERDI-PCD alarm is declared when bits 5, 6 and 7 of the G1 byte contain the “110” pattern in five consecutive frames.
- **ERDI-PPD** (Enhanced RDI - Path Payload Defect): The ERDI-PPD alarm is declared when bits 5, 6 and 7 of the G1 byte contain the “010” pattern in five consecutive frames.

J1 Trace

- **Received Message:** Displays the J1 value in 16-bytes or 64-bytes format. The <crc7> represents the CRC-7 for a 16-bytes format. The last two bytes of a 64-bytes format, <C_R> and <L_F>, represent respectively a carriage return and a line feed.
- **Enable TIM-P** (Trace Identifier Mismatch - Path): Allows enabling the Trace Identifier Mismatch for the expected message defined. When the **Enable TIM-P** check box is cleared, the J1 1-byte is available from the **HOP OH RX (SONET)** on page 254. The **Enable TIM-P** check box has to be selected to give access to the expected trace format and message.
- **Expected Message:** Allows entering the message that is expected. J1 value should be ASCII suitable characters. The default message is **EXFO SONET/SDH** for 16 bytes and **EXFO SONET/SDH Analyzer high order path trace test message** for 64 bytes. However, with VCAT/LCAS the default message will be **EXFO** followed by the VCG number (VCAT and LCAS) and the SQ (VCAT only) number (for example **EXFO-VCG1-SQ0**) for both 16 and 64 bytes formats.
- **Expected Format:** Allows the selection of the format expected. Choices are **16** or **64** bytes. The default setting is **16 bytes**.

SONET Tabs

HOP OH TX/RX (SONET)

HOP OH TX/RX (SONET)

The HOP OH TX allows changing the high order path overhead information to be transmitted while the HOP OH RX allows verification of the high order path overhead information received.

Press **TEST**, **HOP**, and **OH** (under **HOP TX/RX**).

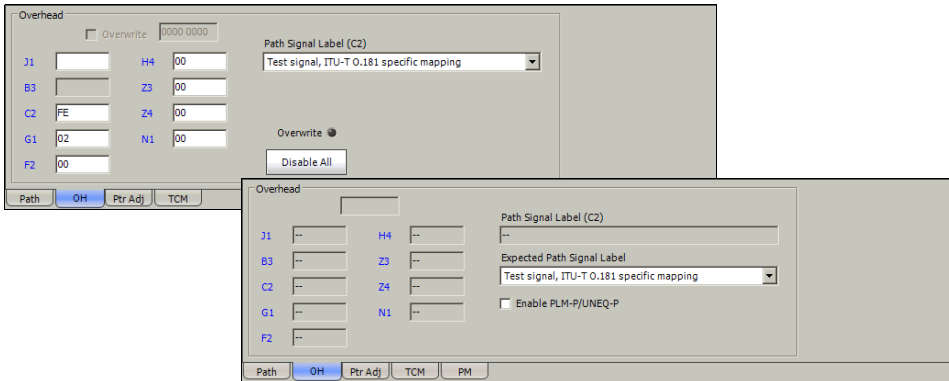

Path Overhead

The following controls are available with **SONET/SDH Intrusive** through mode only (optional):

- The **Overwrite** check box when enabled, allows the generation of the selected byte. The byte can be selected by clicking on its blue label. The byte having its **Overwrite** check box selected will have its hexadecimal value on a yellow background. A byte having its hexadecimal value on a gray background cannot be overwritten.
- The **Overwrite** LED indicates if there is any byte in any timeslot having the **Overwrite** check box selected (LED is green) or not (LED is gray).
- **Disable All** allows to clear the **Overwrite** check box for all OH bytes in the HOP.

The following section overhead byte values are displayed in hexadecimal format. However, a common field allows to see the value of specific byte in binary format. Click on the blue label of a byte and its binary value will be displayed in the common field beside the **Timeslot** selection.

- **J1**¹: Trace. J1 is only available when **Enable Trace** from the *HOP TX (SONET)* on page 245 is disabled.
- **B3**¹: BIP-8
- **C2**: Signal Label. Entering a C2 byte value will automatically update the Path Signal Label (C2) selection and vice versa.
- **G1**: Path Status
- **F2**: User Channel
- **H4**: Multiframe Indicator. This byte is not programmable with LOP or VCAT.
- **Z3** and **Z4**: Growth
- **N1**: Tandem Connection Monitoring

1. These bytes are not programmable from the HOP OH TX tab.

SONET Tabs

Path Signal Label (C2)

Path Signal Label (C2)

The C2 byte is allocated to indicate the content of the STS SPE, including the status of the mapped payloads.

Note: *Selecting the C2 byte from the list will automatically update the C2 byte from the Path Overhead section and vice versa.*

C2 (Hex.)	Description	C2 (Hex.)	Description
00*	Unequipped	16	Mapping of HDLC over SONET
01	Equipped - Non-Specific	17	SDL with self-synchronization scrambler
02	Floating VT Mode	18	Mapping of HDLC/LAPS
03	Locked VT Mode	19	SDL with use of a set-reset scrambler
04	Asynchronous Mapping for DS3	1A	10 Gbps Ethernet (IEEE 802.3)
05	Mapping under development	1B	GFP
12	Asynchronous Mapping for 140M (DS4NA)	CF	Reserved (Obsolete HDLC/PPP framed)
13	Mapping for ATM	E1 ^a to FC ^a	STS-1 w/1 VTx Payload Defects, STS-1 w/2 VTx Payload Defects, ... STS-1 w/28 VTx or STS-n/nc with Payload Defects
14	Mapping for DQDB	FE	Test Signal, ITU-T 0.181 specific mapping
15	Asynchronous Mapping for FDDI	FF ^a	STS SPE AIS (TCM)

a. These values cannot be selected as Expected Path Signal Label.

For HOP OH RX tab only:

- **Expected Path Signal Label:** Allows selecting the expected Path Signal Label.
- **Enable PLM-P/UNEQ-P (Payload Label Mismatch - Path / Unequipped - Path):** Enables the Payload Label Mismatch and UNEQ-P monitoring.

LOP TX (SONET)

Press **TEST**, **LOP**, and **Path** (under **LOP TX**).

Error Injection

Allows **Manual**, **Rate**, or **Burst** error injection methods.

- **Type:** The following errors are available: **BIP-2** (Bit-Interleave Parity - 2 bits) and **REI-V** (Remote Error Indicator - VT).

SONET Tabs

LOP TX (SONET)

For **Manual** method:

- **Amount:** Select the amount of manual error to be generated. Choices are **1** through **50**. The default setting is **1**.
- **Send** button: Press **Send** to manually generate error(s) according to the **Error Type** and the **Amount of Errors** selected.

For **Rate** method:

- **Rate:** Select the injection rate for the selected error. The rate must be within the minimum and maximum values specified.
- **Continuous:** Generates the selected error to its theoretical maximum rate when the **Continuous** check box is selected. The **Continuous** check box is cleared by default.
- **On/Off** button: The On/Off button is used to activate/deactivate the selected error at the rate specified or at its theoretical maximum rate when the **Continuous** check box is selected. This setting is disabled (Off) by default.

For **Burst** method:

The burst method injects the programmed number of consecutive errored frames, representing the burst duration (M), over a specific event period (N).

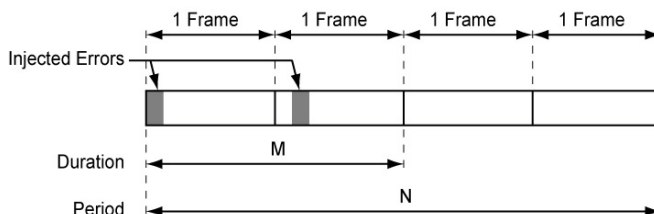

- **Duration and Unit:** Select the number of consecutive errored frames or the number of consecutive seconds in error.
- **Mode:** Allows the selection of the burst mode that will determine if the burst will be repeated (**Repeat**) at the beginning of each period or not (**Single**).
- **Period and Unit:** When the **Mode** is set to **Repeat**, select the interval, either in frames or in seconds, the error burst will be repeated.
- **On/Off** button: The On/Off button is used to activate/deactivate the selected error for the selected **Duration** and **Period**. For **Single Mode**, the injection will be active for the specified duration and will automatically stop (the On/Off button turns Off). For **Repeat Mode** the error injection will be active for the specified duration and will be repeated continuously at the beginning of each period until the On/Off button is turned Off. This setting is disabled (Off) by default.

Alarm Generation

Allows **Continuous** or **Burst** alarm generation methods.

The image shows two screenshots of the Alarm Generation configuration interface. The left screenshot shows the 'Continuous' method selected with 'Type' set to 'AIS-V' and an 'On/Off' button. The right screenshot shows the 'Burst' method selected with 'Type' set to 'AIS-V', 'Mode' set to 'Single', 'Duration' set to '1', and 'Unit' set to 'Frames', along with an 'On/Off' button.

- **Type:** The following alarms are available:

AIS-V (Alarm Indication Signal - VT): Generates an all-ones pattern for the V1 and V2 bytes of the VT path and payload.

RDI-V (Remote Defect indication - VT): Generates “1” for the bit 8 of the V5 byte and a “00” pattern for bits 6 and 7 of the Z7 byte.

ERDI-VSD (Enhanced RDI - VT Server Defect): Generates a “101” pattern for bits 5, 6, and 7 of the Z7 byte, and “1” for bit 8 of the V5 byte.

ERDI-VCD (Enhanced RDI - VT Connectivity Defect): Generates a “110” pattern for bits 5, 6, and 7 of the Z7 byte, and “1” for bit 8 of the V5 byte.

ERDI-VPD (Enhanced RDI - VT Payload Defect): Generates a “010” pattern for bits 5, 6, and 7 of the Z7 byte, and “0” for bit 8 of the V5 byte.

RFI-V (Remote Failure Indication - VT): Generates “1” for the bit 4 of the V5 byte.

LOP-V (Loss of Pointer - VT): Generates a non-valid pointer.

UNEQ-V (Unequipped - VT): Generates samples of unequipped VT signal label (bits 5 through 7 of V5 byte are set to “000”).

For **Continuous** method:

- **On/Off** button: The On/Off button is used to activate/deactivate the selected alarm. This setting is disabled (Off) by default.

For **Burst** method:

The burst method injects the programmed number of consecutive alarmed frames, representing the burst **Duration** (M), over a specific event **Period** (N).

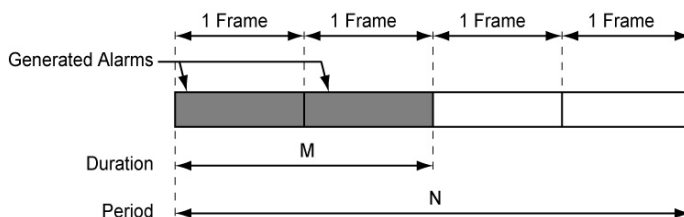

- **Duration** and **Unit**: Select the number of consecutive alarmed frames or the number of consecutive seconds in alarm.
- **Mode**: Allows the selection of the burst mode that will determine if the burst will be repeated (**Repeat**) at the beginning of each period or not (**Single**).
- **Period** and **Unit**: When the **Mode** is set to **Repeat**, select the interval, either in frames or in seconds, the alarm burst will be repeated.
- **On/Off** button: The On/Off button is used to activate/deactivate the selected alarm for the selected **Duration** and **Period**. For **Single Mode**, the alarm generation will be active for the specified duration and will automatically stop (the On/Off button turns Off). For **Repeat Mode** the alarm generation will be active for the specified duration and will be repeated continuously at the beginning of each period until the On/Off button is turned Off. This setting is disabled (Off) by default.

J2 Trace

Enable Trace: Generates the J2 Trace message defined when the **Enable Trace** check box is selected. The **Enable Trace** check box has to be selected to give access to the trace format and message. When the **Enable Trace** check box is cleared, the J2 1-byte format is used and can be configured from the *LOP OH TX/RX (SONET)* on page 266.

Format: Select the display format for J2. Choices are **16** and **64 bytes**. The default setting is **16-bytes**.

Message: Enter the J2 value in 16-bytes or 64-bytes format. The default message is **EXFO SONET/SDH** for 16 bytes and **EXFO SONET/SDH Analyzer low order path trace test message** for 64 bytes. However, with VCAT/LCAS the default message will be **EXFO** followed by the VCG number (VCAT and LCAS) and the SQ (VCAT only) number (for example **EXFO-VCG1-SQ0**) for both 16 and 64 bytes formats.

Note: *16-bytes selection allows typing up to 15 bytes (a CRC-7 byte will be added in front for a total of 16 bytes). 64-bytes selection allows typing up to 62-bytes (<cr> and <L_F> bytes will be added at the end for a total of 64 bytes). J2 value should be ASCII suitable characters including the ITU T.50 Characters on page 57.*

LOP RX (SONET)

Press **TEST**, **LOP**, and **Path** (under **LOP RX**).

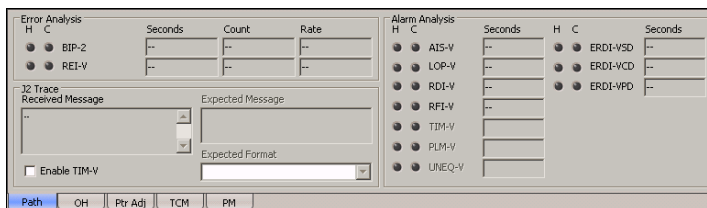

Error Analysis

- **BIP-2** (Bit-Interleave Parity - 2 bits): The BIP-2 error indicates a parity error by performing a routine even-parity check over all VT1.5 bytes of the previous frame of a composite signal (VT1.5/VT2/VT6).
- **REI-V** (Remote Error Indicator): The REI-V error is declared when bit 3 of the V5 byte is set to “1”.

Note: Refer to Alarm/Error Measurements on page 47 for *H/C LEDs*, *Seconds*, *Count*, and *Rate* information.

Alarm Analysis

- **AIS-V** (Alarm Indication Signal - VT): The AIS-V alarm is declared when V1 and V2 bytes for the VT path contain an all-ones pattern in three consecutive superframes.
- **LOP-V** (Loss Of Pointer - VT): The LOP alarm indicates that a valid pointer is not found in N consecutive superframes (where $8 \leq N \leq 10$), or if N consecutive NDFs (“1001” pattern) are detected.
- **RDI-V** (Remote Defect Indication - VT): The RDI-V alarm is declared when bit 8 of the V5 byte contains “1” in five consecutive VT superframes while bits 6 and 7 of the Z7 byte contain the “00” or “11” pattern.

SONET Tabs

LOP RX (SONET)

- **RFI-V** (Remote Failure Indication - VT): The RFI-V alarm is declared when bit 4 of the V5 byte contains “1” in five consecutive superframes.
- **TIM-V** (Trace Identifier Mismatch - VT): The TIM-V defect indicates that the received J2 Trace doesn’t match the expected message value. The TIM-V alarm is only available when **Enable TIM-V** check box from J2 Trace section has been selected.
- The TIM-V alarm result is only available when TIM-V from J2 Trace section has been enabled.
- **PLM-V** (Payload Label Mismatch - VT): The PLM-V is declared upon receipt of five consecutive superframes with mismatched VT Signal (bits 5 through 7 of the V5 byte are “000”, “001” or “111”).
- **UNEQ-V** (Unequipped - VT): UNEQ-V is declared when bit 5 through 7 of the V5 byte contain “000” for five consecutive superframes.
- **ERDI-VSD** (Enhanced RDI - VT Server Defect): The ERDI-VSD alarm is declared when bits 5, 6, and 7 of the Z7 byte contain the “101” pattern, and bit 8 of the V5 byte contain “1”, in five consecutive VT superframes.
- **ERDI-VCD** (Enhanced RDI - VT Connectivity Defect): The ERDI-VCD alarm is declared when bits 5, 6, and 7 of the Z7 byte contain the “110” pattern, and bit 8 of the V5 byte contain “1”, in five consecutive VT superframes.
- **ERDI-VPD** (Enhanced RDI - VT Path Payload Defect): The ERDI-VPD alarm is declared when bits 5, 6, and 7 of the Z7 byte contain the “010” pattern, and bit 8 of the V5 byte contain “0”, in five consecutive VT superframes.

J2 Trace

- **Received Message:** Displays the J2 value in 16-bytes or 64-bytes format. The <crc7> represents the CRC-7 for a 16-bytes format. The last two bytes of a 64-bytes format, <C_R> and <L_F>, represent respectively a carriage return and a line feed.
- **Enable TIM-V (Trace Identifier Mismatch - VT):** Allows enabling the Trace Identifier Mismatch for the expected message defined. The Enable TIM-V check box has to be selected to give access to the expected trace format and message. When the Enable TIM-V check box is cleared, the J2 1-byte is available from the **LOP OH RX** on page 266.
- **Expected Message:** Allows entering the message that is expected. J2 value should be ASCII suitable characters. The default message is **EXFO SONET/SDH** for 16 bytes and **EXFO SONET/SDH Analyzer high order path trace test message** for 64 bytes. However, with VCAT/LCAS the default message will be **EXFO** followed by the VCG number (VCAT and LCAS) and the SQ (VCAT only) number (for example **EXFO-VCG1-SQ0**) for both 16 and 64 bytes formats.
- **Expected Format:** Allows the selection of the format expected. Choices are **16** or **64** bytes. The default setting is **16 bytes**.

LOP OH TX/RX (SONET)

The LOP OH TX allows changing the low order path overhead information to be transmitted while the LOP OH RX allows verification of the low order path overhead information received.

Press **TEST**, **LOP**, and **OH** (under **LOP TX/RX**).

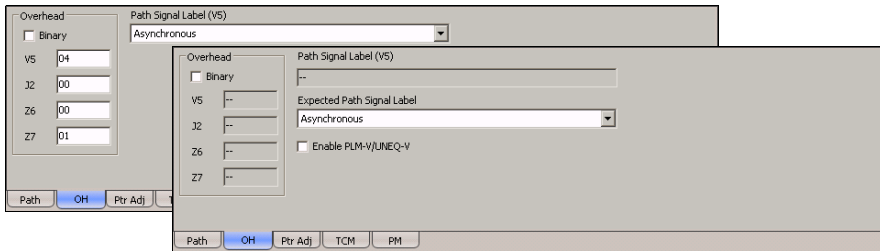

Path Overhead

- **Binary** allows either displaying all overhead values in binary (when enabled) or hexadecimal (when disabled). This setting is disabled by default.
- **V5** (VT Path Overhead)
- **J2** (VT Path Trace). J2 is only available when **Enable Trace** from the *LOP TX (SONET)* on page 257 is disabled.
- **Z6**: VT Tandem Connection Monitoring
- **Z7**: Extended signal label

Path Signal Label (V5)

The V5 byte is allocated to indicate the content of the VT path, including the status of the mapped payloads.

Bits 5, 6, 7 of V5	Description
000 ^a	Unequipped
001	Reserved (Equipped - Non-specific)
010	Asynchronous
011	Bit Synchronous
100	Byte Synchronous
101	Extended Signal Label
110	Test Signal, ITU-T 0.181 specific mapping
111 ^a	VT SPE AIS (TCM)

- a. These bytes cannot be selected in receive mode.

For LOP OH RX tab only:

- **Expected Path Signal Label:** Allows selecting the expected Path Signal Label.
- **Enable PLM-V/UNEQ-V (Payload Label Mismatch - VT / Unequipped - VT):** Allows enabling the Signal Label Mismatch for the expected message defined.

12 DS_n Tabs

The DS_n tabs allow configuration of different test parameters and to view the test status and results.

Note: *The available tabs listed are a function of the test path activated. Not available on the IQS-8140.*

Signal	Tab	Page
DS0/64K	<i>DS0/64K TX</i>	270
	<i>DS0/64K RX</i>	273
DS1/1.5M	<i>DS1/1.5M TX</i>	275
	<i>DS1/1.5M RX</i>	278
	<i>FDL TX</i>	280
	<i>FDL RX</i>	285
	<i>FDL PRM TX</i>	288
	<i>FDL PRM RX</i>	290
	<i>FDL PRM Content RX</i>	291
	<i>Performance Monitoring (PM)^a</i>	504
DS3/45M	<i>DS3/45M TX</i>	293
	<i>DS3/45M RX</i>	295
	<i>DS3 FEAC TX</i>	297
	<i>DS3 FEAC RX</i>	301
	<i>Performance Monitoring (PM)^a</i>	504

a. This tab is described in the *Common Tabs* section.

DS0/64K TX

Press **TEST**, **DSn-PDH**, and **DS0** (under **DSn-PDH TX**).

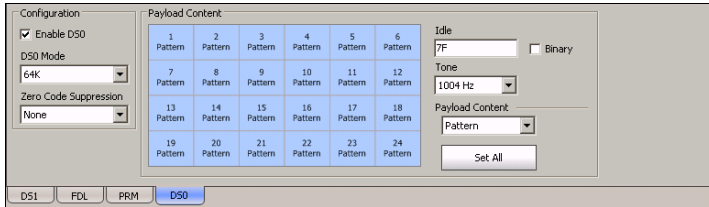

Note: *DS0/64K TX configuration is not available when the selected framing from the DS1/1.5M TX on page 275 is unframed.*

Configuration

- **Enable DS0:** Allows the activation of DS0/64K testing. This setting is disabled (Off) by default unless otherwise set during the test setup.
- **DS0 Mode:** Allows the selection of the channel timeslot data rate for the pattern payload content. Choices are **56K** and **64K**. The default setting is **64K**.

56K: A timeslot data rate of 56 Kbps uses 7 bits to carry the payload information.

64K: A timeslot data rate of 64 Kbps uses 8 bits to carry the payload information.

- **Zero Code Suppression:** Allows the selection of the Zero Code Suppression (ZCS) method used to replace the all-zero bytes of the Idle and Tone payload contents. The ZCS mechanism is a global parameter meaning that all channel timeslots configured with Tone/Idle data, use the same ZCS method. Choices are **None**, **Jammed Bit 8**, **GTE**, and **BELL**. The default setting is **None**.

None: No Zero Code Suppression

Jammed Bit 8: Every 8th (LSB) bit is forced to **1**.

GTE: Bit 8 of an all zero channel byte is replaced by **1**, except in signaling frames where bit 7 is forced to **1**.

Bell: Bit 7 of an all zero channel byte is replaced by **1**.

Note: *Bit 8 is the Least-Significant Bit (LSB) and bit 1 is the Most-Significant Bit (MSB).*

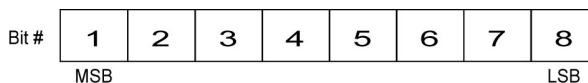

Payload Content

Select the payload content by pressing once or several times on each timeslot until the desired content appears (or use the Set All buttons). Choices are **Pattern**, **Idle**, and **Tone**. The default setting is **Pattern**.

- **Pattern:** Uses the selected pattern from the *Pattern TX* on page 405.
- **Idle:** Uses the Idle code byte from the Idle field. Choices are **00** to **FF**. The selected Idle code applies to all timeslots set to Idle. The default setting is **7F**.

Binary: Allows either displaying the Idle code values in binary (when enabled) or hexadecimal (when disabled). This setting is disabled by default.
- **Tone:** Allows the selection of a tone for digital milliwatt testing. The signal output power, when converted to analog, is 0 dBm. Choices are **1000 Hz** and **1004 Hz**. The selected Tone applies to all timeslots set to Tone. The default setting is **1004 Hz**.
- **Payload Content:** Allows the selection of the payload content that will be applied when pressing **Set All**. Choices are **Pattern**, **Idle** and **Tone**.
- **Set All:** Allows to set the payload content of all timeslots to the selected payload content with its Pattern, Idle, or Tone value.

Note: *The timeslots set to Idle or Tone can be changed from Idle to Tone and vice versa even when the test is running; the Idle and Tone values can also be changed.*

DS0/64K RX

Press **TEST**, **DSn-PDH**, and **DS0** (under **DSn-PDH RX**).

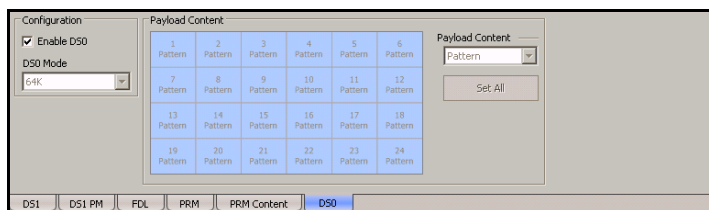

Note: *DS0/64K RX configuration is not available when the selected framing from the DS1/1.5M RX on page 278 is unframed.*

Configuration

Note: *See DS0/64K RX on page 273 for more information on **Enable DS0** and **DS0 Mode**.*

- **Enable:** Allows the activation of DS0/64K testing. This setting is disabled (Off) by default unless otherwise set during the test setup.
- **DS0 Mode:** For decoupled test mode, allows the selection of the channel timeslot data rate. Choices are **56K** and **64K**. The default setting is **64K**.

56K: A timeslot data rate of 56 Kbps uses 7 bits to carry the payload information.

64K: A timeslot data rate of 64 Kbps uses 8 bits to carry the payload information.

Payload Content

Note: *Payload content configuration is only available for decoupled test mode, otherwise the payload content is coupled with the DS0/64K TX configuration.*

Select the payload content by pressing once or several times on each timeslot until the desired content appears (or use the Set All buttons). Choices are **None** and **Pattern**. The default setting is **Pattern**.

- **Pattern:** Uses the pattern from the received signal.
- **None:** Does not use the pattern.
- **Set All:** Allows to set the payload content of all timeslots with (Pattern) or without (None) the selected Pattern.

DS1/1.5M TX

Press **TEST**, **DSn-PDH**, and **DS1** (under **DSn-PDH TX**).

The screenshot shows a configuration window for DS1/1.5M TX. It includes sections for Configuration (Framing: ESF), Alarm Generation (Type: AIS, On/Off button), Error Injection (Manual and Automated sections), and Loopback (Type: CSU (10000/100), Command: Loop-Up, Loop-Up/Down values: 10000/100). At the bottom, there are tabs for DS1, FDL, PRM, and DS0.

Configuration

Framing: Select the framing that will be used for transmission. Choices are **Unframed**, **SF**, and **ESF**. The default setting is **ESF**.

Alarm Generation

- **Type:** Select the type of alarm to be generated. Choices are **AIS**, **RAI**, and **OOF**. The default setting is **AIS**.

Note: Choices depend on the selected framing.

- **On/Off** button: Press **On/Off** to enable/disable the alarm generation.

Error Injection

Allows manual or automated error injection.

Note: *Error injection is not available when the framing is set to **Unframed**.*

- **Type:** The following error types are available with both manual and automated injection modes. Choices are **Framing Bit** and **CRC-6**. CRC-6 is only available with ESF framing.

Note: *Choices depend on the selected framing.*

- **Amount:** Select the amount of error to be generated. Choices are **1** through **50**. The default setting is **1**.
- **Send** button: Press **Send** to manually generate error(s) according to the Error Type and the Amount of Errors selected.
- **Rate:** Press **Rate** to select the injection rate for the selected error. The rate must be within the minimum and maximum values specified.
- **Continuous:** Generates the selected error to its theoretical maximum when the **Continuous** check box is selected. The **Continuous** check box is cleared by default.
- **On/Off** button: The On/Off button is used to activate/deactivate the selected automated error at the rate specified or at its theoretical maximum rate when the **Continuous** check box is selected. This setting is disabled (Off) by default.

Loopback

The Loopback feature generates a code that is interpreted by the DUT. The DUT interprets the command and implements the loopback.

- **Type** allows the selection of the type of loopback. Choices are **CSU (10000/100)**, **NIU FAC1 (1100/1110)**, **NIU FAC2 (11000/11100)**, **NIU FAC3 (100000/100)**, 10 predefined Loop Codes (refer to *DSn Loop Codes* on page 543), and **User Defined**.

Loopback Type	Command	
	Loop-Up	Loop-Down
CSU (10000/100)	10000	100
NIU FAC1 (1100/1110)	1100	1110
NIU FAC2 (11000/11100)	11000	11100
NIU FAC3 (100000/100)	100000	100

- **Loop-Up and Loop-Down:** Indicates respectively the **Loop-Up** and **Loop-Down** code corresponding to the selected loopback type. When the selected loopback type is **User Defined**, enter the **Loop-Up** and **Loop-Down** loopcode values from 3 to 16 bits (000 to 1111111111111111).
- **Command:** Allows the selection of the loopback codes that will be used to overwrite the traffic that will be generated. Choices are **Loop-Up** and **Loop-Down**. The default setting is **Loop-Up**.
- **Send:** Allows the injection of the selected loop code. The loop code will be generated continuously for a maximum of 10 seconds or until the loopback is confirmed. After 10 seconds, if the loopback has failed, a Loop-Down command is sent. A pop-up window appears indicating the loop code injection progress and result.

DS1/1.5M RX

Press **TEST**, **DSn-PDH**, and **DS1** (under **DSn-PDH RX**).



Configuration

Note: See DS1/1.5M TX on page 275 for more information on **Framing**.

Error Analysis

Possible errors that can be detected are:

- **Framing Bit:** A Framing Bit error indicates that an incorrect value appeared in a bit position reserved for framing.
- **CRC-6 (Cyclical Redundancy Check):** A CRC-6 error indicates that one or more bit errors have been detected in a block of data through cyclical redundancy check. CRC-6 is only available with ESF framing.

Alarm Analysis

Possible alarms that can be detected are:

- **OOF** (Out-Of-Frame): A OOF error indicates that four consecutive frame bit errors are detected.
- **RAI** (Yellow) (Remote Alarm Indication):
 - For SF framing:** The RAI alarm is declared when bit 2 in each timeslot contains “0”.
 - For ESF framing:** The RAI alarm is declared when eight “ones” followed by eight “zeros” pattern is received continuously in the data link (FDL).
- **AIS** (Alarm Indication Signal): The AIS alarm is declared when an unframed all-ones signal is received.

FDL TX

Press **TEST**, **DSn-PDH**, and **FDL** (under **DSn-PDH TX**).

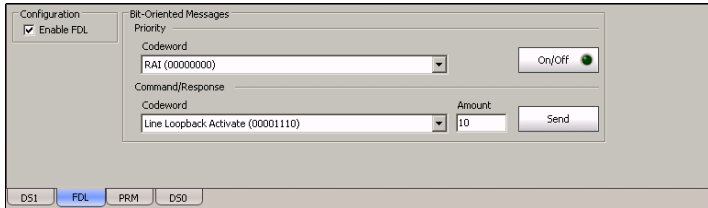

Note: *FDL TX is only available for DS1 interface with ESF framing. For Dual RX test, FDL is only available for the primary DS1 TX/RX port.*

The FDL TX tab is used to set and configure the Bit-Oriented Messages (BOM) of the Extended Super-Frame (ESF).

Configuration

Enable FDL: Allows the activation of the Facility Data Link testing. This setting is disabled (Off) by default unless otherwise set during the test setup.

Bit-Oriented Messages

The Bit-Oriented Messages are priority messages sent over the Data-Link. These messages are mostly used for networking operation and maintenance. A Bit-Oriented Message consists of 8 consecutive ones followed by a byte starting and ending by zeros.

► **Priority**

Priority Codeword	Pattern
RAI	00000000 11111111
Loopback Retention and Acknowledge	00101010 11111111
RAI-CI	00111110 11111111

On/Off allows generating the selected codeword priority message.

➤ **Command/Response**

Command/Response Codeword	Pattern
Line Loopback Activate	00001110 11111111
Line Loopback Deactivate	00111000 11111111
Payload Loopback Activate	00010100 11111111
Payload Loopback Deactivate	00110010 11111111
Reserved for Network Use	00010010 11111111 (Loopback Activate)
Universal Loopback (Deactivate)	00100100 11111111
ISDN Line Loopback (NT2)	00101110 11111111
CI/CSU Line Loopback (NT1)	00100000 11111111
For network use	00011100 11111111 (indication of NT1 power off)
Protection Switch Line 1 b	01000010 11111111
Protection Switch Line 2	01000100 11111111
Protection Switch Line 3	01000110 11111111
Protection Switch Line 4	01001000 11111111
Protection Switch Line 5	01001010 11111111
Protection Switch Line 6	01001100 11111111
Protection Switch Line 7	01001110 11111111
Protection Switch Line 8	01010000 11111111
Protection Switch Line 9	01010010 11111111
Protection Switch Line 10	01010100 11111111
Protection Switch Line 11	01010110 11111111
Protection Switch Line 12	01011000 11111111

Command/Response Codeword	Pattern
Protection Switch Line 13	01011010 11111111
Protection Switch Line 14	01011100 11111111
Protection Switch Line 15	01011110 11111111
Protection Switch Line 16	01100000 11111111
Protection Switch Line 17	01100010 11111111
Protection Switch Line 18	01100100 11111111
Protection Switch Line 19	01100110 11111111
Protection Switch Line 20	01101000 11111111
Protection Switch Line 21	01101010 11111111
Protection Switch Line 22	01101100 11111111
Protection Switch Line 23	01101110 11111111
Protection Switch Line 24	01110000 11111111
Protection Switch Line 25	01110010 11111111
Protection Switch Line 26	01110100 11111111
Protection Switch Line 27	01110110 11111111
Protection Switch Acknowledge	00011000 11111111
Protection Switch Release	00100110 11111111
Do Not use for Synchronization	00110000 11111111
Stratum 2 Traceable	00001100 11111111
SONET Minimum Clock Traceable	00100010 11111111
Stratum 4 Traceable	00101000 11111111
Stratum 1 Traceable	00000100 11111111
Synchronization Traceability Unknown	00001000 11111111
Stratum 3 Traceable	00010000 11111111

DSn Tabs

FDL TX

Command/Response Codeword	Pattern
Reserved for Network Synchronization	01000000 11111111
Transmit Node Clock (TNC)	01111000 11111111
Stratum 3E Traceable	01111100 11111111
Under study for maintenance	00101100 11111111
Under study for maintenance	00110100 11111111
Reserved for network use	00010110 11111111
Reserved for network use	00011010 11111111
Reserved for network use	00011110 11111111
Reserved for network use	00111010 11111111
Reserved for customer	00000110 11111111
Reserved for customer	00001010 11111111
Reserved for customer	00000010 11111111
Reserved for customer	00110110 11111111
Reserved for customer	00111100 11111111
Reserved for customer	01111010 11111111

- **Amount** allows the selection of the number of message to be generated. Choices are **1** to **15**. The default value is **10**.
- **Send** allows to manually generate the selected amount of messages.

FDL RX

Press **TEST**, **DSn-PDH**, and **FDL** (under **DSn-PDH RX**).

The screenshot shows a configuration window for FDL RX. It is divided into three main sections: Configuration, Bit-Oriented Messages, and Link Activity. The Configuration section has a checkbox for 'Enable FDL' which is checked. The Bit-Oriented Messages section has two groups of fields: 'Priority' and 'Command/Response'. Each group has 'Current' and 'Previous' fields, all containing '--'. The Link Activity section has five radio buttons: 'Idle', 'Priority', 'Command/Response', 'Unassigned', and 'PRM'. At the bottom of the window, there are several tabs: 'DS1', 'DS1 PM', 'FDL', 'PRM', 'PRM Content', and 'DS0'. The 'FDL' tab is currently selected and highlighted in blue.

Note: *FDL RX is only available for DS1 interface with ESF framing. For **Dual RX** test, FDL is only available for the primary DS1 TX/RX port.*

Note: *Path and test signal identification are not supported.*

Configuration

Note: *See FDL TX on page 280 for more information on **Enable FDL**.*

Bit-Oriented Messages

The Bit-Oriented Messages are priority messages send over the Data-Link. These messages are mostly used for networking operation and maintenance. A Bit-Oriented Message consists of 8 consecutive 1s followed by a byte starting and ending by zeros.

► Priority

Note: See *Priority* on page 281 for the list of possible **Priority** codeword messages.

Current indicates the priority message detected in the last second. If no priority message has been detected, "--" is displayed.

Previous indicates the last priority message detected excluding the current message. If no priority message has been detected since the beginning of the test, "--" is displayed.

► Command/Response

Note: See *Command/Response* on page 282 for the list of possible **Command/Response** codeword messages.

Current indicates the command/response message detected in the last second. If no priority message has been detected, "--" is displayed.

Previous indicates the last command/response message detected excluding the current message. If no command/response message has been detected since the beginning of the test, "--" is displayed.

Link Activity

Indicates the activity of the following parameters during the last second of measurement. A link activity is indicated by an LED.

Idle indicates that only idle codes have been detected in the last second.

Priority indicates that at least one valid priority message has been detected in the last second.

Command/Response indicates that at least one valid command and response has been detected in the last second.

Unassigned indicates that at least one unassigned message has been detected in the last second. Therefore, since an unassigned message is part of a Command/Response codewords, the Command/Response LED will also be red.

PRM indicates that at least one PRM has been detected in the last second.

FDL PRM TX

Press **TEST**, **DSn-PDH**, and **PRM** (under **DSn-PDH TX**).

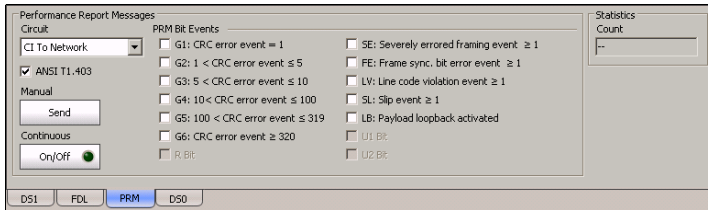

Note: *FDL PRM TX is only available for DS1 interface with ESF framing when Enable FDL from FDL TX/RX is enabled. For **Dual RX** test, FDL is only available for the primary DS1 TX/RX port.*

Performance Report Messages

- **Circuit** allows the selection of the circuit type. Choices are **CI to Network** and **Network to CI**. The default setting is **CI to Network**.
- **ANSI T1-403** allows the generation of a compliant ANSI T1.403 PRM Message.
- **Manual**
 - Send** allows to manually send the selected PRM Message(s).
- **Continuous**
 - On/Off** allows to generate the selected PRM Message(s) continuously.

- **PRM Bit Events:** Allows the activation of the following PRM bit events. All PRM bit events are disabled by default.

G1: CRC error event = 1

G2: $1 < \text{CRC error event} \leq 5$

G3: $5 < \text{CRC error event} \leq 10$

G4: $10 < \text{CRC error event} \leq 100$

G5: $100 < \text{CRC Error Event} \leq 319$

G6: CRC error event ≥ 320

R Bit (Reserved - Default value is 0)

SE: Severely errored framing event ≥ 1

FE: Frame synchronization bit error event ≥ 1

LV: Line code violation event ≥ 1

SL: Slip event ≥ 1

LB: Payload loopback activated

U1: Bit

U2: Bit

Statistics

Count indicates the number of PRM messages sent.

FDL PRM RX

Press **TEST**, **DSn-PDH**, and **PRM** (under **DSn-PDH TX**).

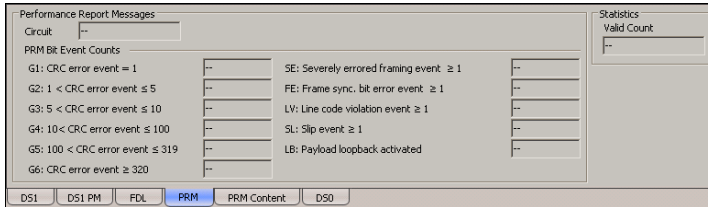

Note: *FDL PRM RX is only available for DS1 interface with ESF framing when **Enable FDL** from **FDL TX/RX** is enabled. For **Dual RX** test, FDL is only available for the primary DS1 TX/RX port.*

Performance Report Message

- **Circuit** indicates the selected circuit type which can be **CI to Network** or **Network to CI**.
- **PRM Bit Event Counts:** Indicates the count of the detected valid PRM bit events.

G1: CRC Error Event = 1	SE: Severely-Errored Framing Event ≥ 1
G2: $1 < \text{CRC Error Event} \leq 5$	FE: Frame Sync. Bit Error Event ≥ 1
G3: $5 < \text{CRC Error Event} \leq 10$	LV: Line Code Violation Event ≥ 1
G4: $10 < \text{CRC Error Event} \leq 100$	SL: Controlled Slip Event ≥ 1
G5: $100 < \text{CRC Error Event} \leq 319$	LB: Payload Loopback Activated
G6: CRC Error Event ≥ 320	

Statistics

Valid Count indicates the number of valid PRM messages received.

FDL PRM Content RX

Press **TEST**, **DSn-PDH**, and **PRM Content** (under **DSn-PDH RX**).

Current Performance Report Message															Statistics		
Time	G3	LV	G4	LI1	LI2	G5	SL	G6	FE	SE	LB	G1	R	G2	Nm	NI	Valid Count
T0	0	0	0	0	0	0	0	0	0	0	0	0	0	0	0	0	0
T0-1	0	0	0	0	0	0	0	0	0	0	0	0	0	0	0	0	0
T0-2	0	0	0	0	0	0	0	0	0	0	0	0	0	0	0	0	0
T0-3	0	0	0	0	0	0	0	0	0	0	0	0	0	0	0	0	0

DS1 DS1 PM FDL PRM **PRM Content** DS0

Note: *FDL PRM Content RX* is only available for DS1 interface with ESF framing when **Enable FDL** from **FDL TX/RX** is enabled. For Dual RX test, FDL is only available for the primary DS1 TX/RX port.

Current Performance Report Message

Each PRM is listed into four lines called Time (t0, t0-1, t0-2 and t0-3).

Where:

➤ **Time**

t0 represents the valid PRM message received in the last second of measurement (bytes 5 and 6).

t0-1 represents the message one PRM ago (bytes 7 and 8).

t0-2 represents the message two PRM ago (bytes 9 and 10).

t0-3 represents the message three PRM ago (bytes 11 and 12).

DSn Tabs

FDL PRM Content RX

- ▶ **G3:** $5 < \text{CRC Error Event} \leq 10$
- LV:** Line Code Violation Event ≥ 1
- G4:** $10 < \text{CRC Error Event} \leq 100$
- U1:** Under study for synchronization
- U2:** Under study for synchronization
- G5:** $100 < \text{CRC Error Event} \leq 319$
- SL:** Controlled Slip Event ≥ 1
- G6:** CRC Error Event ≥ 320
- FE:** Frame Sync. Bit Error Event ≥ 1
- SE:** Severely-Errored Framing Event ≥ 1
- LB:** Payload Loopback Activated
- G1:** CRC Error Event = 1
- R:** Reserved
- G2:** $1 < \text{CRC Error Event} \leq 5$
- Nm** and **NI:** One-second report modulo 4 counter.

Statistics

Valid Count indicates the number of valid PRM messages received.

DS3/45M TX

Press **TEST**, **DSn-PDH**, and **DS3** (under **DSn-PDH TX**).

The screenshot shows a configuration window for DS3. It is divided into three main sections: Configuration, Alarm Generation, and Error Injection. The Configuration section has a 'Framing' dropdown menu set to 'C-Bit Parity'. The Alarm Generation section has a 'Type' dropdown menu set to 'AIS' and an 'On/Off' button with a green indicator. The Error Injection section is split into 'Manual' and 'Automated' sub-sections. The 'Manual' section has a 'Type' dropdown set to 'C-Bit' and an 'Amount' input field set to '1', with a 'Send' button. The 'Automated' section has a 'Type' dropdown set to 'C-Bit', a 'Rate' input field set to '2.1E-04', a 'Continuous' checkbox, and an 'On/Off' button with a green indicator. A 'DS3' tab is visible at the bottom left of the window.

Configuration

Framing: Select the framing that will be used for transmission. Choices are **Unframed**, **M13**, and **C-Bit Parity**. The default setting is **C-Bit Parity**.

Alarm Generation

- **Type:** Select the type of alarm to be generated. Choices are **AIS**, **RDI**, **OOF**, and **Idle**. The default setting is **AIS**.
- **On/Off button:** Press **On/Off** to enable/disable the alarm generation.

Error Injection

Allows manual or automated error injection.

Note: *Error injection is not available when the framing is set to **Unframed**.*

- **Type:** The following error types are available with both manual and automated injection modes. Choices are **C-bit**, **F-bit**, **P-bit**, and **FEBE**. Choices depend also on the selected framing. The default setting is **C-bit**.
- **Amount:** Select the amount of error to be generated. Choices are **1** through **50**. The default setting is **1**.
- **Send** button: Press **Send** to manually generate error(s) according to the Error Type and the Amount of Errors selected.
- **Rate:** Press **Rate** to select the injection rate for the selected error. The rate must be within the minimum and maximum values specified. The default setting is **1.0E-2**.
- **Continuous:** Generates the selected error to its theoretical maximum when the **Continuous** check box is selected. The **Continuous** check box is cleared by default.
- **On/Off** button: The On/Off button is used to activate/deactivate the selected automated error at the rate specified or at its theoretical maximum rate when the **Continuous** check box is selected. This setting is disabled (Off) by default.

DS3/45M RX

Press **TEST**, **DSn-PDH**, and **DS3** (under **DSn-PDH RX**).

Configuration		Error Analysis					Alarm Analysis		
Framing		H	C	Seconds	Count	Rate	H	C	Seconds
C-Bit Parity		<input type="radio"/>	<input type="radio"/>	--	--	--	<input type="radio"/>	<input type="radio"/>	--
		<input type="radio"/>	<input type="radio"/>	--	--	--	<input type="radio"/>	<input type="radio"/>	--
		<input type="radio"/>	<input type="radio"/>	--	--	--	<input type="radio"/>	<input type="radio"/>	--
		<input type="radio"/>	<input type="radio"/>	--	--	--	<input type="radio"/>	<input type="radio"/>	--

DS3 DS3 PM

Configuration

Note: See DS3/45M TX on page 293 for more information on **Framing**.

Error Analysis

Possible errors that can be detected are:

- **C-Bit (Control-Bit):** A C-Bit error indicates that the three C-bits reserved to control bit stuffing are different of “111” and “000”.
- **F-Bit (Framing-Bit):** A F-Bit error indicates that the frame alignment pattern received is different of “1001”.
- **P-Bit (Parity-Bit):** A P-Bit error indicates that the P-Bits does not match the parity of all the information bits following the first X-Bit of the previous DS3 frame.
- **FEBE (Far-End Block Error):** A FEBE is detected when the three FEBE bits reserved for framing or parity error detection contain the “000” pattern.

Alarm Analysis

Possible alarms that can be detected are:

- **OOF** (Out-Of-Frame): A OOF error indicates that four consecutive frame bit errors are detected.
- **RDI** (Remote Defect Indicator): The RDI alarm is declared when both X-bits of the M-Frame are set to “0”.
- **AIS** (Alarm Indication Signal): The AIS alarm is declared when the M-frame contains zeros (0) for C-bits, ones (1) for X-bits, 1010... repeating sequence with a one (1) immediately following any of the control bit positions for the information bits.
- **Idle** (DS3 Idle): The Idle alarm is declared when subframe 3 of the M-frame contains zeros (0) for the three C-bits, ones (1) for X-bits, 1100... repeating sequence with the first two bits following each control bit set to 11 for the information bits.

DS3 FEAC TX

The Far-End Alarm and Control signal (*FEAC*) provides Communication Channel capability over a DS3 in a network applications using C-bit Parity configuration.

The DS3 FEAC TX tab is used to configure and send alarms/status information and control signals (loopback commands) to other network elements.

Note: *The DS3 FEAC tab is available when the DS3 framing is set to C-Bit Parity (see page 293).*

Press **TEST**, **DSn-PDH**, and **FEAC** (under **DSn-PDH TX**).

Configuration

Enable FEAC: Enables DS3 FEAC codeword configuration and analysis.

Alarm/Status Unassigned Messages

Allows manual or continuous alarm/status injection.

- **Codeword:** Select the codeword alarm/status to be generated either manually or continuously.

The FEAC message format is a 16 bit codeword (0xxxxxx0 1111111) with the rightmost bit transmitted first. The 0xxxxxx0 represents the message codeword.

Codeword	
DS3 Equipment Failure SA (00110010)	User Defined (00001100)
DS3 Loss of Signal (LOS) (00011100)	User Defined (00010000)
DS3 Out-of-Frame (00000000)	User Defined (00010100)
DS3 AIS Received (00101100)	User Defined (00010110)
DS3 Idle Signal Received (00110100)	User Defined (00011000)
DS3 Equipment Failure NSA (00011110)	User Defined (00011010)
DS3 NUI Loop Up (00010010)	User Defined (00100000)
DS3 NUI Loop Down (00100100)	User Defined (00100010)
Common Equipment Failure NSA (00111010)	User Defined (00101000)
Multiple DS1 LOS (00101010)	User Defined (00101110)
DS1 Equipment Failure SA (00001010)	User Defined (00110000)
Single DS1 LOS (00111100)	User Defined (00111110)
DS1 Equipment Failure NSA (00000110)	User Defined (01000000)
User Defined (00000010)	User Defined (01111010)
User Defined (00000100)	User Defined (01111100)
User Defined (00001000)	User Defined (01111110)

- **Amount:** Select the amount of codeword to be generated. Choices are **1** through **15**. The default setting is **10**.
- **Send** button: Press **Send** to manually generate error(s) according to the Codeword and the Amount of Errors selected.
- **On/Off** button: The On/Off button is used to activate/deactivate the transmission of the selected continuous codeword continuously. This setting is disabled (Off) by default.

Loopback Commands

- **Control Codeword:** Select the loopback control codeword to be generated. Choices are **Line Loopback Activate (00001110)** and **Line Loopback Deactivate (00111000)**.

Amount: Select the amount of **Control Codeword** to be generated. Choices are **1** through **15**. The default setting is **10**.

DSn Tabs

DS3 FEAC TX

- **Channel Codeword:** Select the channel codeword to be generated.

Channel Codeword	
DS3 Line (00110110)	DS1 Line-No15 (01011110)
DS1 Line-No1 (01000010)	DS1 Line-No16 (01100000)
DS1 Line-No2 (01000100)	DS1 Line-No17 (01100010)
DS1 Line-No3 (01000110)	DS1 Line-No18 (01100100)
DS1 Line-No4 (01001000)	DS1 Line-No19 (01100110)
DS1 Line-No5 (01001010)	DS1 Line-No20 (01101000)
DS1 Line-No6 (01001100)	DS1 Line-No21 (01101010)
DS1 Line-No7 (01001110)	DS1 Line-No22 (01101100)
DS1 Line-No8 (01010000)	DS1 Line-No23 (01101110)
DS1 Line-No9 (01010010)	DS1 Line-No24 (01110000)
DS1 Line-No10 (01010100)	DS1 Line-No25 (01110010)
DS1 Line-No11 (01010110)	DS1 Line-No26 (01110100)
DS1 Line-No12 (01011000)	DS1 Line-No27 (01110110)
DS1 Line-No13 (01011010)	DS1 Line-No28 (01111000)
DS1 Line-No14 (01011100)	DS1 Line-All (00100110)

Amount: Select the amount of Channel Codeword to be generated. Choices are **1** through **15**. The default setting is **10**.

- **Send button:** Press **Send** to generate the defined loopback command.

DS3 FEAC RX

The DS3 FEAC RX tab gives current and previous alarms/status and loopback commands as well as the link activity for the received DS3 signal.

Note: The DS3 FEAC RX tab is available when the DS3 framing is set to C-Bit Parity (see page 293).

Press **TEST**, **DSn-PDH**, and **FEAC** (under **DSn-PDH RX**).

Configuration

Enable FEAC: Enables DS3 FEAC codeword configuration and analysis.

Link Activity

- **No Activity (All 1's):** An all ones pattern (11111111 11111111) has been detected in the last second.
- **Alarm/Status:** An Alarm/Status codeword has been detected in the last second. An Alarm/Status is only detected when receiving at least 10 consecutive occurrences of a specific codeword.
- **Loopback:** A Loopback command message has been detected in the last second. A valid loopback command is detected only when receiving 10 consecutive occurrences of a specific **Loopback Command** immediately followed by 10 occurrences of a specific **Channel Codeword**.

- **Unassigned:** An unassigned message has been detected in the last second. An Unassigned message is only detected when receiving at least 10 consecutive occurrences of a specific unassigned codeword. An **Alarm/Status** codeword is also reported since **Unassigned** is part of the **Alarm/Status** group.

Alarm/Status Unassigned Messages

Displays the current and previously received **Codeword** messages.

Current: Indicates the last valid message, if any, received in the last second of measurement.

Previous: Indicates the message, if any, that was received just before the current measurement.

Loopback Commands

Current: Displays the valid message received in the last second of measurement. A valid message is detected only when receiving 10 consecutive occurrences of a specific **Loopback Command** immediately followed by 10 occurrences of a specific **Channel Codeword**. See DS3 FEAC TX *on page 297* for more information.

Previous: Displays the last valid message received excluding the actual **Current** message.

13 SDH Tabs

The SDH tabs allow configuration of different test parameters and to view the test status and results.

Note: *The available tabs listed are a function of the test path activated.*

SDH	Tab	Page
RS	<i>Regenerator Section TX (SDH)</i>	305
	<i>Regenerator Section RX (SDH)</i>	311
	<i>Regenerator Section OH TX/RX (SDH)</i>	313
	<i>Performance Monitoring (PM)^a</i>	504
MS	<i>Multiplex Section TX (SDH)</i>	315
	<i>Multiplex Section RX (SDH)</i>	320
	<i>Multiplex Section OH TX/RX (SDH)</i>	326
	<i>Multiplex Section APS/Advanced OH TX/RX (SDH)</i>	328
	<i>Performance Monitoring (PM)^a</i>	504
HOP	<i>HOP TX (SDH)</i>	335
	<i>HOP RX (SDH)</i>	341
	<i>HOP OH TX/RX (SDH)</i>	344
	<i>HOP/LOP Pointer Adjust TX (SONET/SDH)^a</i>	492
	<i>HOP/LOP Pointer Adjust RX (SONET/SDH)^a</i>	495
	<i>TCM TX^{ab}</i>	497
	<i>TCM RX^{ab}</i>	500
	<i>Performance Monitoring (PM)^a</i>	504

SDH Tabs

SDH	Tab	Page
LOP ^b	<i>LOP TX (SDH)</i>	347
	<i>LOP RX (SDH)</i>	353
	<i>LOP OH TX/RX (SDH)</i>	356
	<i>LOP TX (SDH, TU-3 path)</i>	358
	<i>LOP RX (SDH, TU-3 path)</i>	364
	<i>LOP OH TX/RX (SDH, TU-3 path)</i>	367
	<i>HOP/LOP Pointer Adjust TX (SONET/SDH)^a</i>	492
	<i>HOP/LOP Pointer Adjust RX (SONET/SDH)^a</i>	495
	<i>TCM TX^a</i>	497
	<i>TCM RX^a</i>	500
	<i>Performance Monitoring (PM)^a</i>	504

- a. These tabs are described in *Common Tabs* on page 491.
- b. Not available on the IQS-8140.

Regenerator Section TX (SDH)

Press **TEST**, **RS-MS**, and **RS** (under **RS-MS TX**).

Error Injection

Allows **Manual**, **Rate**, or **Burst** error injection methods.

➤ **Type:** The following errors are available: **B1** and **FAS**.

SDH Tabs

Regenerator Section TX (SDH)

For **Manual** method:

- **Amount:** Select the amount of manual error to be generated. Choices are **1** through **50**. The default setting is **1**.
- **Send** button: Press **Send** to manually generate error(s) according to the **Error Type** and the **Amount of Errors** selected.

For **Rate** method:

- **Rate:** Select the injection rate for the selected error. The rate must be within the minimum and maximum values specified.
- **Continuous:** Generates the selected error to its theoretical maximum rate when the **Continuous** check box is selected. The **Continuous** check box is cleared by default.
- **On/Off** button: The On/Off button is used to activate/deactivate the selected error at the rate specified or at its theoretical maximum rate when the **Continuous** check box is selected. This setting is disabled (Off) by default.

For **Burst** method:

The burst method injects the programmed number of consecutive errored frames, representing the burst duration (M), over a specific event period (N).

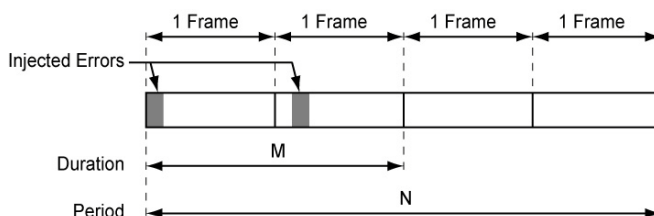

- **Duration and Unit:** Select the number of consecutive errored frames or the number of consecutive seconds in error.
- **Mode:** Allows the selection of the burst mode that will determine if the burst will be repeated (**Repeat**) at the beginning of each period or not (**Single**).
- **Period and Unit:** When the **Mode** is set to **Repeat**, select the interval, either in frames or in seconds, the error burst will be repeated.
- **On/Off** button: The On/Off button is used to activate/deactivate the selected error for the selected **Duration** and **Period**. For **Single Mode**, the injection will be active for the specified duration and will automatically stop (the On/Off button turns Off). For **Repeat Mode** the error injection will be active for the specified duration and will be repeated continuously at the beginning of each period until the On/Off button is turned Off. This setting is disabled (Off) by default.

Alarm Generation

Allows **Continuous** or **Burst** alarm generation methods.

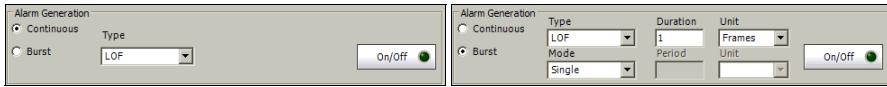

➤ **Type**

LOF (Loss Of Frame): Generates non-valid framing bytes (A1 and A2).

OOF (Out of Frame): Generates four consecutive errored framing patterns.

For **Continuous** method:

- **On/Off** button: The On/Off button is used to activate/deactivate the selected alarm. This setting is disabled (Off) by default. Exceptionally for continuous OOF alarm, the On/Off button turns Off once the OOF alarm has been sent.

For **Burst** method:

The burst method injects the programmed number of consecutive alarmed frames, representing the burst **Duration** (M), over a specific event **Period** (N).

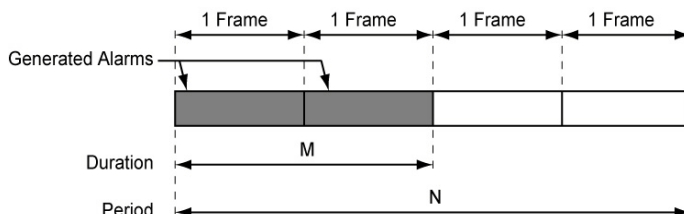

- **Duration and Unit:** Select the number of consecutive alarmed frames or the number of consecutive seconds in alarm.
- **Mode:** Allows the selection of the burst mode that will determine if the burst will be repeated (**Repeat**) at the beginning of each period or not (**Single**).
- **Period and Unit:** When the **Mode** is set to **Repeat**, select the interval, either in frames or in seconds, the alarm burst will be repeated.
- **On/Off button:** The On/Off button is used to activate/deactivate the selected alarm for the selected **Duration** and **Period**. For **Single Mode**, the alarm generation will be active for the specified duration and will automatically stop (the On/Off button turns Off). For **Repeat Mode** the alarm generation will be active for the specified duration and will be repeated continuously at the beginning of each period until the On/Off button is turned Off. This setting is disabled (Off) by default.

J0 Trace

- **Format:** Displays the J0 value in **16** or **64 bytes** format. The default setting is **16 bytes**.
- **Message:** Enter the J0 trace value in 16 or 64 bytes format as selected. The default message is **EXFO SONET/SDH** for 16 bytes and **EXFO SONET/SDH Analyzer Section/RS trace test message** for 64 bytes.
- **Enable Trace:** Generates the defined J0 Trace message except for **Intrusive** mode (see **Overwrite**) when the **Enable Trace** check box is selected. The **Enable Trace** check box has to be selected to give access to the trace format and message. When the **Enable Trace** check box is cleared, the J0 1-byte format is used and can be configured from the *Regenerator Section OH TX (SDH)* on page 313.
- **Overwrite:** Available with **SONET/SDH Intrusive** through mode only. Overwrite is not available on IQS-8105/IQS-8115. The **Overwrite** check box when selected, generates the defined J0 Trace message. The **Enable Trace** check box has to be selected to give access to the trace **Format, Message, and Overwrite**.

Note: 16-bytes selection allows typing up to 15 bytes (a CRC-7 byte will be added in front for a total of 16 bytes). 64-bytes selection allows typing up to 62-bytes (<C_R> and <L_F> bytes will be added at the end for a total of 64-bytes).

Regenerator Section RX (SDH)

Press **TEST**, **RS-MS**, and **RS** (under **RS-MS RX**).

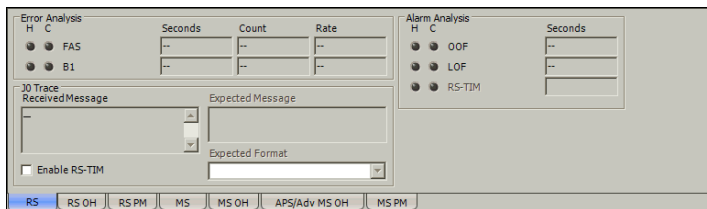

Error Analysis

FAS (Frame Alignment Signal): A FAS defect indicates that at least one A1 or A2 byte of the FAS word is in error.

B1 (BIP-8, Bit-Interleave Parity - 8 bits): The BIP-8 error indicates a Regenerator Section parity error by performing a routine even-parity check over all frames of the previous STM-n signal.

Alarm Analysis

- **OOF** (Out Of Frame): A OOF alarm indicates that a minimum of four consecutive errored framing patterns are received.
- **LOF** (Loss Of Frame): A LOF alarm indicates that an Out Of Frame (OOF) defect on the incoming optical signal persists for 3 milliseconds.
- **RS-TIM** (Regenerator Section - Trace Identifier Mismatch): The RS-TIM defect indicates that the received J0 Trace doesn't match the expected message value. RS-TIM alarm is only available when the **Enable RS-TIM** check box is selected.

Note: Refer to Alarm/Error Measurements on page 47 for **H/C LEDs**, and **Seconds** information.

J0 Trace

- **Received Message:** Displays the J0 value in 16 or 64 bytes format. The <crc7> represents the CRC-7 for a 16-bytes format. The last two bytes of a 64-bytes format, <C_R> and <L_F>, represent respectively a carriage return and a line feed.
- **Enable RS-TIM (Regenerator Section - Trace Identifier Mismatch):** Enables the Trace Identifier Mismatch for the expected message defined when the **Enable RS-TIM** check box is selected. The **Enable RS-TIM** check box has to be selected to give access to the expected trace format and message. When the **Enable RS-TIM** check box is selected, the J0 1-byte is available from the *Regenerator Section OH TX/RX (SDH)* on page 313.
- **Expected Message:** Allows entering the message that is expected. J0 value should be ASCII suitable characters. The default message is **EXFO SONET/SDH** for 16 bytes and **EXFO SONET/SDH Analyzer Section/RS trace test message** for 64 bytes.
- **Expected Format:** Allows the selection of the format expected. Choices are **16** or **64 bytes**. The default setting is **16 bytes**.

Regenerator Section OH TX/RX (SDH)

The **Regenerator Section OH TX** allows changing the regenerator transport overhead information to be transmitted while the **Regenerator Section OH RX** allows verification of the information received. Refer to *Glossary* on page 573 for detailed overhead information.

Press **TEST**, **RS-MS**, and **RS OH** (under **RS-MS TX/RX**).

The image shows two screenshots of the 'Regenerator Overhead' configuration window. The top screenshot shows the 'Regenerator Overhead' window with 'STM-1 Channel' set to 1. It displays a grid of bytes (A1/A1/A1, B1/-/-, D1/-/-, A2/A2/A2, E1/-/-, D2/-/-, J0/Z0/Z0, F1/-/-, D3/-/-) with hexadecimal values and 'Overwrite' checkboxes. The 'RS OH' tab is selected. The bottom screenshot shows the same window with the 'Disable All' button highlighted.

Regenerator Section Overhead

- **STM-1 Channel:** Select the channel number that will be used for verification. Choices are **1** for STM-1, **1 to 4** for STM-4, **1 to 16** for STM-16, **1 to 64** for STM-64, and 1 to 256 for STM-256.

The following controls are available with **SONET/SDH Intrusive** through mode only:

- The **Overwrite** check box when selected, allows the generation of the selected byte. The byte can be selected by clicking on its blue label. The byte having its **Overwrite** check box selected will have its hexadecimal value on a yellow background. A byte having its hexadecimal value with a gray background cannot be overwritten.
- The **Overwrite** LED indicates if there is any byte in any timeslot having the **Overwrite** check box selected (LED is green) or not (LED is gray).
- **Disable All** allows to clear the **Overwrite** check box for all bytes.

SDH Tabs

Regenerator Section OH TX/RX (SDH)

The following section overhead byte values are displayed in hexadecimal format. However, a common field allows to see the value of specific byte in binary format. Click on the blue label of a byte and its binary value will be displayed in the common field beside the **STM-1 Channel** selection.

- **A1** and **A2**: Framing. The value should be hexadecimal **F6** for A1 and **28** for A2.
- **J0/Z0**
 - J0**: Trace: STM-1 of a STM-N signal. J0 is only available when **Enable Trace** from the *Regenerator Section TX (SDH)* on page 305 is disabled.
 - Z0**: Growth
- **B1**: BIP-8. This byte is not programmable from this tab.
- **E1**: Orderwire
- **F1**: User
- **D1**, **D2**, and **D3**: Data Communications Channel (DCC)

Multiplex Section TX (SDH)

Press **TEST**, **RS-MS**, and **MS TX** (under **RS-MS TX**).

The screenshot shows a configuration window with two main sections: Error Injection and Alarm Generation. At the bottom, there are tabs for RS, RS OH, MS (selected), MS OH, and APS/Adv MS OH.

Error Injection:

- Manual: Selected
- Type: B2
- Amount: 1
- Send button

Alarm Generation:

- Continuous: Selected
- Type: MS-AIS
- On/Off button (green indicator)

Error Injection

Allows **Manual**, **Rate**, or **Burst** error injection methods.

The three screenshots show different configurations for the Error Injection section:

Top Left: Manual mode selected, Type: B2, Amount: 1, Send button.

Top Right: Rate mode selected, Type: B2, Rate: 1.2E-03, Continuous checkbox (unchecked), On/Off button (green indicator).

Bottom: Manual mode selected, Type: B2, Duration: 1, Unit: Frames, Mode: Single, Period: [empty], Unit: [empty], On/Off button (green indicator).

- **Type:** The following errors are available with both manual and automated injection modes: **B2** (BIP-8), and **MS-REI** (Multiplex Section - Remote Error Indication). The default setting is **B2**.

SDH Tabs

Multiplex Section TX (SDH)

For **Manual** method:

- **Amount:** Select the amount of manual error to be generated. Choices are **1** through **50**. The default setting is **1**.
- **Send** button: Press **Send** to manually generate error(s) according to the **Error Type** and the **Amount of Errors** selected.

For **Rate** method:

- **Rate:** Select the injection rate for the selected error. The rate must be within the minimum and maximum values specified.
- **Continuous:** Generates the selected error to its theoretical maximum rate when the **Continuous** check box is selected. The **Continuous** check box is cleared by default.
- **On/Off** button: The On/Off button is used to activate/deactivate the selected error at the rate specified or at its theoretical maximum rate when the **Continuous** check box is selected. This setting is disabled (Off) by default.

For **Burst** method:

The burst method injects the programmed number of consecutive errored frames, representing the burst duration (M), over a specific event period (N).

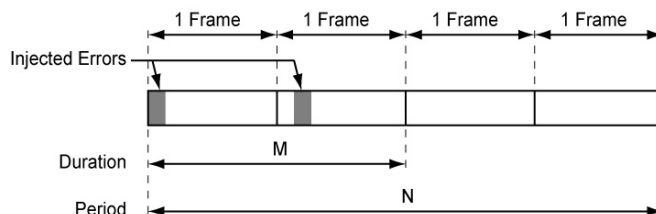

- **Duration and Unit:** Select the number of consecutive errored frames or the number of consecutive seconds in error.
- **Mode:** Allows the selection of the burst mode that will determine if the burst will be repeated (**Repeat**) at the beginning of each period or not (**Single**).
- **Period and Unit:** When the **Mode** is set to **Repeat**, select the interval, either in frames or in seconds, the error burst will be repeated.
- **On/Off** button: The On/Off button is used to activate/deactivate the selected error for the selected **Duration** and **Period**. For **Single Mode**, the injection will be active for the specified duration and will automatically stop (the On/Off button turns Off). For **Repeat Mode** the error injection will be active for the specified duration and will be repeated continuously at the beginning of each period until the On/Off button is turned Off. This setting is disabled (Off) by default.

Alarm Generation

Allows **Continuous** or **Burst** alarm generation methods.

The image shows two screenshots of the Alarm Generation configuration interface. The left screenshot shows the 'Continuous' method selected with 'MS-AIS' as the Type and an 'On/Off' button. The right screenshot shows the 'Burst' method selected with 'MS-AIS' as the Type, 'Mode' as a dropdown, 'Duration' as '1', 'Unit' as 'Frames', and an 'On/Off' button.

➤ Type

MS-AIS (Multiplex Section - Alarm Indication Signal): Generates an SDH signal that contains a valid Regenerator Section Overhead (RSOH) and an all-ones pattern on the SPE.

MS-RDI (Multiplex Section - Remote Defect Indication): Generates a “110” pattern for the bits 6, 7 and 8 of the K2 byte.

The default setting is **MS-AIS**.

For **Continuous** method:

- **On/Off** button: The On/Off button is used to activate/deactivate the selected alarm. This setting is disabled (Off) by default.

For **Burst** method:

The burst method injects the programmed number of consecutive alarmed frames, representing the burst **Duration** (M), over a specific event **Period** (N).

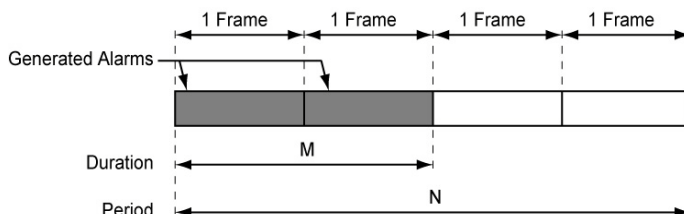

- **Duration and Unit:** Select the number of consecutive alarmed frames or the number of consecutive seconds in alarm.
- **Mode:** Allows the selection of the burst mode that will determine if the burst will be repeated (**Repeat**) at the beginning of each period or not (**Single**).
- **Period and Unit:** When the **Mode** is set to **Repeat**, select the interval, either in frames or in seconds, the alarm burst will be repeated.
- **On/Off button:** The On/Off button is used to activate/deactivate the selected alarm for the selected **Duration** and **Period**. For **Single Mode**, the alarm generation will be active for the specified duration and will automatically stop (the On/Off button turns Off). For **Repeat Mode** the alarm generation will be active for the specified duration and will be repeated continuously at the beginning of each period until the On/Off button is turned Off. This setting is disabled (Off) by default.

Multiplex Section RX (SDH)

Press **TEST**, **RS-MS**, and **MS RX** (under **RS-MS RX**).

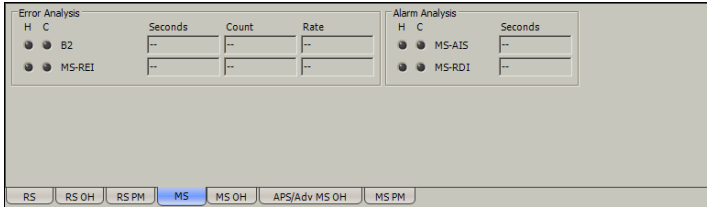

Alarm Analysis

- **MS-AIS** (Multiplex Section - Alarm Indication Signal): The MS-AIS alarm is declared when bits 6, 7 and 8 of the K2 byte contain the “111” pattern in three consecutive frames.
- **MS-RDI** (Multiplex Section - Remote Defect Indication): The MS-RDI alarm is declared when bits 6, 7, and 8 of the K2 byte contain the “110” pattern in five consecutive frames.

Note: Refer to Alarm/Error Measurements on page 47 for **H/C LEDs**, and **Seconds** information.

Error Analysis

- **B2** (BIP-Nx24, Bit-Interleave Parity - Nx24 bits): The B2 error indicates a Multiplex Section parity error by performing an even-parity check over all bits (except those in the RSOH bytes) of the previous frame of a STM-N signal.

- **MS-REI** (Multiplex Section - Remote Error Indicator):

For STM-0e: The MS-REI error is declared the M1 byte located in the STM-1 channel 1 (first timeslot) indicates that one or more BIP violations have been detected.

M1, bits 234 5678	Indicates
000 0000	0 BIP violation
000 0001	1 BIP violation
000 0010	2 BIP violations
:	:
000 1000	8 BIP violations
000 1001	0 BIP violation
:	:
111 1111	0 BIP violation

SDH Tabs

Multiplex Section RX (SDH)

For STM-1e and STM-1o: The MS-REI error is declared when the M1 byte located in the STM-1 channel 1 (timeslot #3) indicates that one or more BIP violations have been detected

M1, bits 234 5678	Indicates
000 0000	0 BIP violation
000 0001	1 BIP violation
000 0010	2 BIP violations
:	:
001 1000	24 BIP violations
001 1001	0 BIP violation
:	:
111 1111	0 BIP violation

For STM-4: The MS-REI error is declared when the M1 byte located in the STM-1 channel 3 (timeslot #7) indicates that one or more BIP violations have been detected.

M1, bits 234 5678	Indicates
000 0000	0 BIP violation
000 0001	1 BIP violation
000 0010	2 BIP violations
:	:
110 0000	96 BIP violations
110 0001	0 BIP violation
:	:
111 1111	0 BIP violation

For STM-16: The MS-REI error is declared when the M1 byte located in the STM-1 channel 3 (timeslot #7) indicates that one or more BIP violations have been detected.

M1	Indicates
0000 0000	0 BIP violation
0000 0001	1 BIP violation
0000 0010	2 BIP violations
:	:
1111 1111	255 BIP violations

SDH Tabs

Multiplex Section RX (SDH)

For STM-64: The MS-REI error is declared when either the M1 byte located in the timeslot #7 (STM-1 channel 3) indicates that one or more BIP violations have been detected, or the combination of the M0 and M1 bytes indicates that one or more BIP violations have been detected. Refer to *OC-192/STM-64 REI-L/MS-REI* on page 542 for MS-REI computation method.

M1	Indicates
0000 0000	0 BIP violation
0000 0001	1 BIP violation
0000 0010	2 BIP violations
:	:
1111 1111	255 BIP violations

M0 Located in STM-1 channel 2 (timeslot #4)	M1 Located in STM-1 channel 3 (timeslot #7)	Indicates
0000 0000	0000 0000	0 BIP violation
0000 0000	0000 0001	1 BIP violation
0000 0000	0000 0010	2 BIP violations
:	:	
0000 0110	0000 0000	1536 BIP violations
0000 0110	0000 0001	0 BIP violation
:		:
1111 1111	1111 1111	0 BIP violation

For STM-256: The MS-REI error is declared when the combination of the M0 and M1 bytes indicates that one or more BIP violations have been detected.

M0 Located in STM-1 channel 2 (timeslot #4)	M1 Located in STM-1 channel 3 (timeslot #7)	Indicates
0000 0000	0000 0000	0 BIP violation
0000 0000	0000 0001	1 BIP violation
0000 0000	0000 0010	2 BIP violations
:	:	
0001 1000	0000 0000	6144 BIP violations
0001 1000	0000 0001	0 BIP violation
:	:	
1111 1111	1111 1111	0 BIP violation

Multiplex Section OH TX/RX (SDH)

The **Multiplex Section OH TX** allows changing the multiplex transport overhead information to be transmitted while the **Multiplex Section OH RX** allows verification of the multiplex transport overhead information received.

Press **TEST**, **RS-MS**, and **MS OH** (under **RS-MS TX/RX**).

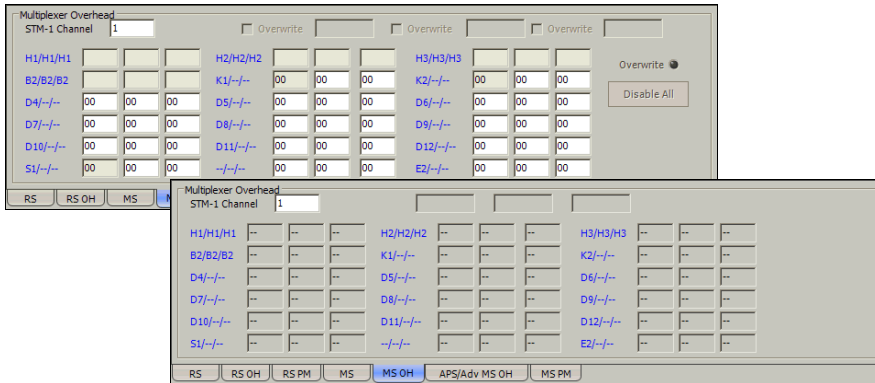

Multiplex Section Overhead

- **STM-1 Channel:** Select the timeslot number that will be used for the test. Choices are **1** for STM-1, **1 to 4** for STM-4, **1 to 16** for STM-16, **1 to 64** for STM-64, and **1 to 256** for STM-256. The default setting is **1**.

The following controls are available with **SONET/SDH Intrusive** through mode only:

- The **Overwrite** check box when selected, allows the generation of the selected byte. The byte can be selected by clicking on its blue label. The byte having its **Overwrite** check box selected will have its hexadecimal value on a yellow background. A byte having its hexadecimal value with a gray background cannot be overwritten.
- The **Overwrite** LED indicates if there is any byte in any timeslot having the **Overwrite** check box selected (LED is green) or not (LED is gray).
- **Disable All** allows to clear the **Overwrite** check box for all bytes.

The following overhead byte values are displayed in hexadecimal format. However, a common field allows to see the value of specific byte in binary format. Click on the blue label of a byte and its binary value will be displayed in the common field beside the **STM-1 Channel** selection.

- **H1** and **H2**: Pointer
- **H3**: Pointer Action
- **B2**: BIP-8
- **K1** and **K2**: Automatic Protection Switching (APS)
- **D4** through **D12**: Data Communications Channel (DCC)
- **S1**: Synchronization Status.
- **M0** or **M1**

M0: REI-L [STM-1 channel 1 of a STM-0e signal; STM-1 channel 2 of an STM-64/STM-256 signal]

M1: REI-L [STM-1 channel 1 of a STM-1e or STM-1o signal; STM-1 channel 3 of an STM-4/16/64/256 signal]

Undefined "--" for all other timeslots not covered by M0 and M1.

- **E2**: Orderwire

Multiplex Section APS/Advanced OH TX/RX (SDH)

The **APS/Advanced MS OH TX** allows changing the multiplex transport overhead information to be transmitted while the **APS/Advanced MS OH RX** allows verification of the multiplex transport overhead information received.

Press **TEST**, **RS-MS**, and **APS/Advanced MS OH** (under **RS-MS TX/RX**).

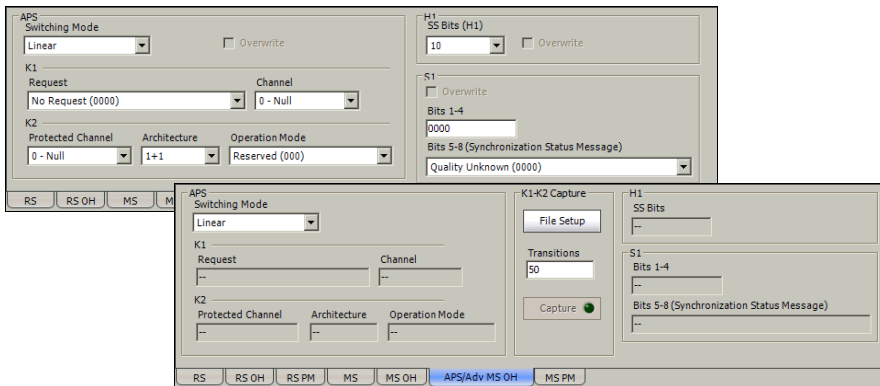

APS

➤ **Switching Mode**

Allows the switching mode selection and is available on both TX and RX tabs. Choices are **Linear** and **Ring**. The default setting is **Linear**.

➤ **Overwrite:** The **Overwrite** check box when selected, allows the activation of the APS. **Overwrite** is available with **SONET/SDH Intrusive** mode only.

- **K1**
 - **Request:** Bits 1 through 4 of the K1 byte. The default setting is **No Request** (0000). Refer to *K1* on page 237 for available/possible choices.
 - **Channel ID/Destination Node ID:** Bits 5 through 8 of the K1 byte. Channel ID is available with Linear switching mode while Destination Node ID is available with Ring switching mode. The default setting is **Null Channel** for **Linear** switching mode and **0** for **Ring** switching mode. Refer to *Channel/Destination Node ID* on page 238 for available/possible choices.
- **K2**
 - **Protected Channel/Source Node ID:** Bits 1 through 4 of the K2 byte. **Protected Channel** is available with **Linear** switching mode while **Source Node ID** is available with **Ring** switching mode. The default setting is **Null Channel** for **Linear** switching mode and **0** for **Ring** switching mode. Refer to *K2* on page 239 for available/possible choices.
 - **Architecture/Bridge Request:** Bit 5 of the K2 byte. **Architecture** is available with **Linear** switching mode while **Bridge Request** is available with **Ring** switching mode. The default setting is **1+1** for **Linear** switching mode and **Short Path Request** for **Ring** switching mode. Refer to *K2* on page 239 for available/possible choices.

SDH Tabs

Multiplex Section APS/Advanced OH TX/RX (SDH)

- **Operation Mode:** Bits 6 through 8 of the K2 byte. The default setting is **Reserved (000)** for Linear switching mode and **Idle** for Ring switching mode.

Bits 6 to 8	Linear mode	Ring mode
000	Reserved	Idle
001	Reserved	Bridged
010	Reserved	Bridged and Switched
011	Reserved	Extra Traffic - Protection
100	Unidirectional	Reserved
101	Bidirectional	Reserved
110	MS-RDI	MS-RDI
111	MS-AIS	MS-AIS

K1-K2 Capture

This feature allows to capture and save the K1/K2 byte transitions to a text file on disk. Not available on IQS-8105 and IQS-8115.

Once generated and saved, the K1/K2 capture file can be loaded using Windows File Manager. The default directory is **d:\IQSManager\User Files\SonetSdhAnalyzerG2\Reports** under Windows XP and **Documents\User Files\SonetSdhAnalyzerG2\Reports** under Windows 8. The following is an example of captured K1/K2 byte transition file.

```
*****
Start Capture
Transitions  K1      K2      Time to detect (Frames)
              0:   A0      02      >32768
              1:   A0      00      >32768
              2:   00      00      --
End Capture
*****

*****
Start Capture
Transitions  K1      K2      Time to detect (Frames)
              0:   00      00      23666
              1:   20      00      14995
              2:   60      00      22172
              3:   C0      00      >32768
              4:   B0      00      24659
              5:   00      00      --
End Capture
*****
```

Note: The transition #0, indicates the state of K1 and K2 before the capture starts.

SDH Tabs

Multiplex Section APS/Advanced OH TX/RX (SDH)

➤ **Files Setup**

Press the **File Setup** button to select the file that will be used to save the captured K1/K2 byte transitions. Selecting a new file name will create an empty file on disk that will be used to capture the K1/K2 byte transitions. Selecting an existing file name will overwrite the existing file.

➤ **Transitions**

Allows to select the number of K1/K2 byte transitions that will be captured. Once the number of K1/K2 byte transitions is reached, the capture stops (the **Capture** button LED turns off).

➤ **Capture**

Press the **Capture** button to enable the K1/K2 capture process. However the capture will only start when the test is started. The **Capture** button is only available when a file has been selected (see **File Setup** button).

If the capture is restarted, the content of the file will be appended.

H1

- **SS Bits (H1):** Bits 5 and 6 of the H1 byte represent the SS bits.

SS Bits	Description
00	SONET
01	Undefined
10	SDH
11	Undefined

- **Overwrite:** The **Overwrite** check box when selected, allows the generation of the selected **SS Bits**. **Overwrite** is available with **SONET/SDH Intrusive** mode only. In normal mode, the **SS Bits** are written on all timeslots (foreground and background). When **SONET/SDH Intrusive** is selected, the **SS Bits** are written on the foreground timeslots only.

SDH Tabs

Multiplex Section APS/Advanced OH TX/RX (SDH)

S1

- **Overwrite:** The **Overwrite** check box when selected, allows the generation of the selected **S1** bits. **Overwrite** is available with **SONET/SDH Intrusive** mode only.
- **Bits 1-4:** Bits 1 through 4 of the S1 byte are currently undefined but can be set from 0000 to 1111 if required.
- **Bits 5-8 (Synchronization Status Message):** Bits 5 through 8 of the S1 byte are used to convey synchronization status of the NE. The default setting is **Synchronized - Traceability Unknown (0000)**. Choices are:

Bits 5 to 8	Description	Bits 5 to 8	Description
0000	Quality Unknown	1000	SSU-B
0001	Reserved	1001	Reserved
0010	ITU G.811 (PRC)	1010	Reserved
0011	Reserved	1011	ITU-T G.813 Option I (SEC)
0100	SSU-A	1100	Reserved
0101	Reserved	1101	Reserved
0110	Reserved	1110	Reserved
0111	Reserved	1111	Do not use for synchronization

HOP TX (SDH)

Press **TEST**, **HOP**, and **Path** (under **HOP TX**).

Error Injection

Allows **Manual**, **Rate**, or **Burst** error injection methods.

- **Type:** The following errors are available: **B3** (BIP-8, Bit-Interleave Parity - 8 bits) and **HP-REI** (High Order path - Remote Error Indicator).

SDH Tabs

HOP TX (SDH)

For **Manual** method:

- **Amount:** Select the amount of manual error to be generated. Choices are **1** through **50**. The default setting is **1**.
- **Send** button: Press **Send** to manually generate error(s) according to the **Error Type** and the **Amount of Errors** selected.

For **Rate** method:

- **Rate:** Select the injection rate for the selected error. The rate must be within the minimum and maximum values specified.
- **Continuous:** Generates the selected error to its theoretical maximum rate when the **Continuous** check box is selected. The **Continuous** check box is cleared by default.
- **On/Off** button: The On/Off button is used to activate/deactivate the selected error at the rate specified or at its theoretical maximum rate when the **Continuous** check box is selected. This setting is disabled (Off) by default.

For **Burst** method:

The burst method injects the programmed number of consecutive errored frames, representing the burst duration (M), over a specific event period (N).

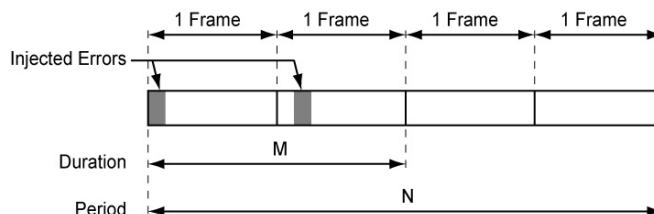

- **Duration and Unit:** Select the number of consecutive errored frames or the number of consecutive seconds in error.
- **Mode:** Allows the selection of the burst mode that will determine if the burst will be repeated (**Repeat**) at the beginning of each period or not (**Single**).
- **Period and Unit:** When the **Mode** is set to **Repeat**, select the interval, either in frames or in seconds, the error burst will be repeated.
- **On/Off** button: The On/Off button is used to activate/deactivate the selected error for the selected **Duration** and **Period**. For **Single Mode**, the injection will be active for the specified duration and will automatically stop (the On/Off button turns Off). For **Repeat Mode** the error injection will be active for the specified duration and will be repeated continuously at the beginning of each period until the On/Off button is turned Off. This setting is disabled (Off) by default.

Alarm Generation

Allows **Continuous** or **Burst** alarm generation methods.

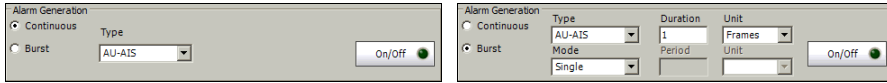

➤ Type

AU-AIS (Administrative Unit - Alarm Indication Signal): Generates an all-ones patterns over the H1, H2, H3, and SPE.

HP-RDI (High Order Path - Remote Defect Indication): Generates a “100” pattern for bits 5, 6 and 7 of the G1 byte.

ERDI-SD (Enhanced RDI - Server Defect): Generates a “101” pattern for the bits 5, 6 and 7 of the G1 byte.

ERDI-CD (Enhanced RDI - Connectivity Defect): Generates a “110” pattern for the bits 5, 6 and 7 of the G1 byte.

ERDI-PD (Enhanced RDI - Payload Defect): Generates a “010” pattern for the bits 5, 6 and 7 of the G1 byte.

H4-LOM (H4 - Loss Of Multiframe) (available with TU-11, TU-12 and TU-2): Generates a wrong H4 byte multiframe indicator sequence. Not supported on the IQS-8140.
AU-LOP (Administrative Unit - Loss Of Pointer): Generates a non-valid pointer.

HP-UNEQ (High Order Path - Unequipped): Generates an all-ones pattern over POH and SPE.

For **Continuous** method:

- **On/Off** button: The On/Off button is used to activate/deactivate the selected alarm. This setting is disabled (Off) by default.

For **Burst** method:

The burst method injects the programmed number of consecutive alarmed frames, representing the burst **Duration** (M), over a specific event **Period** (N).

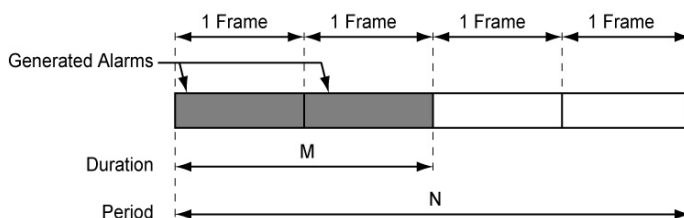

- **Duration** and **Unit**: Select the number of consecutive alarmed frames or the number of consecutive seconds in alarm.
- **Mode**: Allows the selection of the burst mode that will determine if the burst will be repeated (**Repeat**) at the beginning of each period or not (**Single**).
- **Period** and **Unit**: When the **Mode** is set to **Repeat**, select the interval, either in frames or in seconds, the alarm burst will be repeated.
- **On/Off** button: The On/Off button is used to activate/deactivate the selected alarm for the selected **Duration** and **Period**. For **Single Mode**, the alarm generation will be active for the specified duration and will automatically stop (the On/Off button turns Off). For **Repeat Mode** the alarm generation will be active for the specified duration and will be repeated continuously at the beginning of each period until the On/Off button is turned Off. This setting is disabled (Off) by default.

J1 Trace

- **Format:** Displays the J1 value in 16 or 64 bytes format. The default setting is **16 bytes**.
- **Message:** Enter the J1 trace value in 16 or 64 bytes format as selected. The default message is **EXFO SONET/SDH** for 16 bytes and **EXFO SONET/SDH Analyzer high order path trace test message** for 64 bytes. However, with VCAT/LCAS the default message will be **EXFO** followed by the VCG number (VCAT and LCAS) and the SQ (VCAT only) number (for example **EXFO-VCG1-SQ0**) for both 16 and 64 bytes formats.
- **Enable Trace:** Generates the defined J1 Trace message except for **Intrusive** mode (see **Overwrite**) when the **Enable Trace** check box is selected. The **Enable Trace** check box has to be selected to give access to the trace format and message. When the **Enable Trace** check box is not selected, the J0 1-byte format is used and can be configured from the **HOP OH TX (SDH)** on page 344.
- **Overwrite:** Available with **SONET/SDH Intrusive** through mode only (optional). Overwrite is not available on IQS-8105/IQS-8115. The **Overwrite** check box when selected, generates the defined J1 Trace message. The **Enable Trace** check box has to be selected to give access to the trace **Format, Message, and Overwrite**.

Note: *16-bytes selection allows typing up to 15 bytes (a CRC-7 byte will be added in front for a total of 16 bytes). 64-bytes selection allows typing up to 62-bytes (<C_R> and <L_F> bytes will be added at the end for a total of 64 bytes).*

HOP RX (SDH)

Press **TEST**, **HOP**, and **Path** (under **HOP RX**).

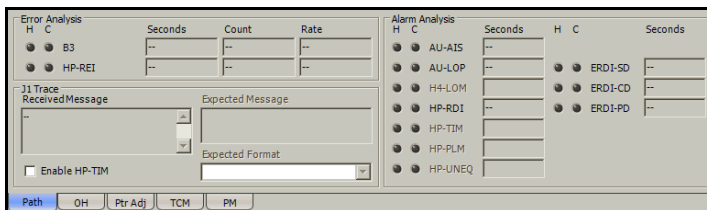

Error Analysis

- **B3** (BIP-8, Bit-Interleave Parity - 8 bits): The B3 error indicates a High Order Path parity error by performing an even-parity check over all bits of the previous VC-N.
- **HP-REI** (High Order Path - Remote Error Indicator): The HP-REI error is declared when bits 1 through 4 of the G1 byte contain one pattern from the following binary range: “0001” through “1000” (1 to 8) (located in every STM-1 of an STM-n signal).

Alarm Analysis

- **AU-AIS** (Administrative Unit - Alarm Indication Signal): The AU-AIS alarm is declared when the H1 and H2 bytes contain an all-ones pattern in three consecutive frames.
- **AU-LOP** (Administrative Unit - Loss Of Pointer): The LOP alarm indicates that a valid pointer is not found in N consecutive frames (where $8 \leq N \leq 10$), or that N consecutive NDFs (“1001” pattern) are detected (non-concatenated payloads).
- **H4-LOM** (H4 - Loss Of Multiframe): For TU structured optical frames, the H4-LOM alarm indicates that the system loss track of the H4 byte multiframe indicator sequence. Not supported on the IQS-8140.
- **HP-RDI** (High Order Path - Remote Defect Indication): The HP-RDI alarm is declared when bits 5, 6 and 7 of the G1 byte contain the “100” or “111” pattern in five consecutive frames.
- **HP-TIM** (High Order Path - Trace Identifier Mismatch): The HP-TIM defect indicates that the received J1 Trace doesn’t match the expected message value. The HP-TIM alarm result is only available when **Enable HP-TIM** check box from J1 Trace section has been selected.
- **HP-PLM** (High Order Path - Payload Label Mismatch): The HP-PLM is declared upon receipt of five consecutive frames with mismatched VC signal labels (C2 byte).
- **HP-UNEQ** (High Order Path - Unequipped): HP-UNEQ is declared when the C2 bytes contain “00 H” in five consecutive frames.
- **ERDI-SD** (Enhanced RDI - Server Defect): The ERDI-SD alarm is declared when bits 5, 6 and 7 of the G1 byte contain the “101” pattern in five consecutive frames.

- **ERDI-CD** (Enhanced RDI - Connectivity Defect): The ERDI-CD alarm is declared when bits 5, 6 and 7 of the G1 byte contain the “110” pattern in five consecutive frames.
- **ERDI-PD** (Enhanced RDI - Payload Defect): The ERDI-PD alarm is declared when bits 5, 6 and 7 of the G1 byte contain the “010” pattern in five consecutive frames.

J1 Trace

- **Received Message:** Displays the J1 value in 16-bytes or 64-bytes format. The <crc7> represents the CRC-7 for a 16-bytes format. The last two bytes of a 64-bytes format, <C_R> and <L_F>, represent respectively a carriage return and a line feed.
- **Enable HP-TIM:** Enables the Trace Identifier Mismatch for the expected message defined when the **Enable HP-TIM** check box is selected. The **Enable HP-TIM** check box has to be selected to give access to the expected trace format and message. When the **Enable HP-TIM** check box is cleared, the J1 1-byte is available from the **HOP OH RX (SDH)** on page 344.
- **Expected Message:** Allows entering the message that is expected. J1 value should be ASCII suitable characters. The default message is **EXFO SONET/SDH** for 16 bytes and **EXFO SONET/SDH Analyzer high order path trace test message** for 64 bytes. However, with VCAT/LCAS the default message will be **EXFO** followed by the VCG number (VCAT and LCAS) and the SQ (VCAT only) number (for example **EXFO-VCG1-SQ0**) for both 16 and 64 bytes formats.
- **Expected Format:** Allows the selection of the format expected. Choices are **16** or **64 bytes**. The default setting is **16 bytes**.

HOP OH TX/RX (SDH)

The **HOP OH TX** allows changing the high order path transport overhead information to be transmitted while the **HOP OH RX** allows verification of the high order path transport overhead information received.

Press **TEST**, **HOP**, and **OH** (under **HOP TX/RX**).

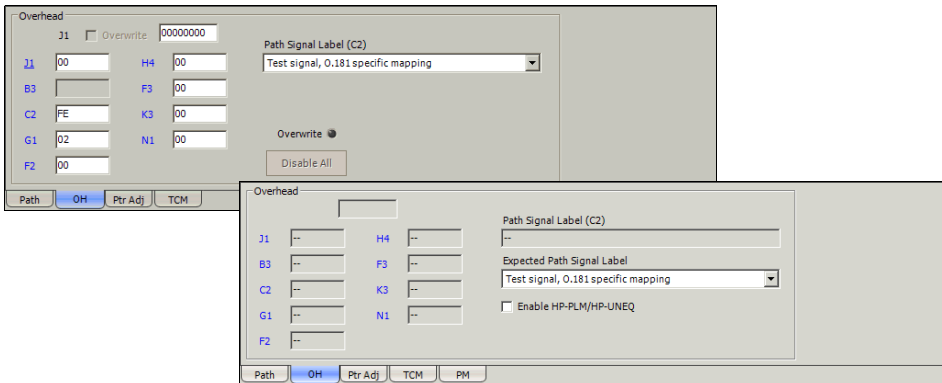

Path Overhead

The following controls are available with **SONET/SDH Intrusive** through mode only (optional):

- The **Overwrite** check box when enabled, allows the generation of the selected byte. The byte can be selected by clicking on its blue label. The byte having its **Overwrite** check box selected will have its hexadecimal value on a yellow background. A byte having its hexadecimal value on a gray background cannot be overwritten.
- The **Overwrite** LED indicates if there is any byte in any timeslot having the **Overwrite** check box selected (LED is green) or not (LED is gray).
- **Disable All** allows to clear the **Overwrite** check box for all OH bytes in the HOP.

The following section overhead byte values are displayed in hexadecimal format. However, a common field allows to see the value of specific byte in binary format. Click on the blue label of a byte and its binary value will be displayed in the common field beside the **Timeslot** selection.

- **J1**: Trace. J1 is only available when **Enable Trace** from the *HOP TX (SDH)* on page 335 is disabled.
- **B3**: BIP-8. This byte is not programmable from the HOP OH TX tab.
- **C2**: Path Signal Label. Entering a C2 byte will automatically update the Path Signal Label (C2) selection and vice versa.
- **G1**: Path Status
- **F2**: User Channel
- **H4**: Multiframe Indicator. This byte is not programmable with LOP or VCAT.
- **F3**: User Channel
- **K3**: Automatic Protection Switching (APS)
- **N1**: (Network operator byte) Tandem Connection Monitoring (TCM)

SDH Tabs

HOP OH TX/RX (SDH)

Path Signal Label (C2)

The C2 byte is allocated to indicate the content of the VC, including the status of the mapped payloads.

C2 (Hex.)	Description	C2 (Hex.)	Description
00 ^a	Unequipped or supervisory-unequipped	17	Reserved (SDL self-synch scrambler)
01	Reserved (Equipped - Non-Specific)	18	Mapping of HDLC/LAPS
02	TUG Structure	19	Reserved (SDL set-reset scrambler)
03	Locked TU-n	1A	Mapping of 10 Gbps Ethernet (IEEE 802.3)
04	Asynchronous Mapping of 34M/45M in C-3	1B	GFP
05	Experimental Mapping	1C	Mapping 10 Gbps FC
12	Asynchronous Mapping of 140M in C-4	20	Asynchronous Mapping of ODUk
13	ATM Mapping	CF	Reserved (obsolete HDLC/PPP framed)
14	MAN DQDB	FE	Test Signal, ITU-T 0.181 specific mapping
15	FDDI [3]-[11] Mapping	FF ^a	VC-AIS (TCM)
16	Mapping of HDLC/PPP		

- a. These values cannot be selected as Expected Path Signal Label.

For HOP OH RX tab only:

- **Expected Path Signal Label:** Allows selecting the expected Path Signal Label.
- **Enable HP-PLM/HP-UNEQ** (High Order Path - Payload Label Mismatch / Unequipped): Enables the Payload Label Mismatch and Unequipped monitoring..

LOP TX (SDH)

Note: See LOP TX (SDH, TU-3 path) on page 358 for TU-3 path test case.

Press **TEST**, **LOP**, and **Path** (under **LOP TX**).

Error Injection

Allows **Manual**, **Rate**, or **Burst** error injection methods.

- **Type:** The following errors are available: **BIP-2** (Bit-Interleave Parity - 2 bits) and **LP-REI** (Low Order Path - Remote Error Indicator).

SDH Tabs

LOP TX (SDH)

For **Manual** method:

- **Amount:** Select the amount of manual error to be generated. Choices are **1** through **50**. The default setting is **1**.
- **Send** button: Press **Send** to manually generate error(s) according to the **Error Type** and the **Amount of Errors** selected.

For **Rate** method:

- **Rate:** Select the injection rate for the selected error. The rate must be within the minimum and maximum values specified.
- **Continuous:** Generates the selected error to its theoretical maximum rate when the **Continuous** check box is selected. The **Continuous** check box is cleared by default.
- **On/Off** button: The On/Off button is used to activate/deactivate the selected error at the rate specified or at its theoretical maximum rate when the **Continuous** check box is selected. This setting is disabled (Off) by default.

For **Burst** method:

The burst method injects the programmed number of consecutive errored frames, representing the burst duration (M), over a specific event period (N).

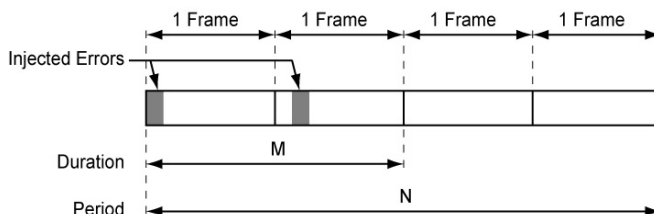

- **Duration and Unit:** Select the number of consecutive errored frames or the number of consecutive seconds in error.
- **Mode:** Allows the selection of the burst mode that will determine if the burst will be repeated (**Repeat**) at the beginning of each period or not (**Single**).
- **Period and Unit:** When the **Mode** is set to **Repeat**, select the interval, either in frames or in seconds, the error burst will be repeated.
- **On/Off** button: The On/Off button is used to activate/deactivate the selected error for the selected **Duration** and **Period**. For **Single Mode**, the injection will be active for the specified duration and will automatically stop (the On/Off button turns Off). For **Repeat Mode** the error injection will be active for the specified duration and will be repeated continuously at the beginning of each period until the On/Off button is turned Off. This setting is disabled (Off) by default.

Alarm Generation

Allows **Continuous** or **Burst** alarm generation methods.

➤ **Type:** The following errors are available:

TU-AIS (Tributary Unit - Alarm Indication Signal): Generates an all-ones pattern for the V1 and V2 bytes of the TU path and payload.

LP-RDI (Low Order Path - Remote Defect Indication): Generates “1” for the bit 8 of the V5 byte and a “00” pattern for bits 6 and 7 of the K4 byte.

ERDI-SD (Enhanced RDI - Server Defect): Generates a **101** pattern for bits 5, 6, and 7 of the K4 byte, and **1** for bit 8 of the V5 byte.

ERDI-CD (Enhanced RDI - Connectivity Defect): Generates a **110** pattern for bits 5, 6, and 7 of the K4 byte, and **1** for bit 8 of the V5 byte.

ERDI-PD (Enhanced RDI - Path Payload Defect): Generates a “010” pattern for bits 5, 6, and 7 of the K4 byte, and “0” for bit 8 of the V5 byte.

LP-RFI (Low Order Path - Remote Failure Indication) (available with VC-11 only): Generates “1” for the bit 4 of the V5 byte.

TU-LOP (Tributary Unit - Loss of Pointer): Generates a non-valid pointer.

LP-UNEQ (Low Order Path - Unequipped): Generates unequipped LP signal label (bits 5 through 7 of V5 byte are set to “000”).

For **Continuous** method:

- **On/Off** button: The On/Off button is used to activate/deactivate the selected alarm. This setting is disabled (Off) by default.

For **Burst** method:

The burst method injects the programmed number of consecutive alarmed frames, representing the burst **Duration** (M), over a specific event **Period** (N).

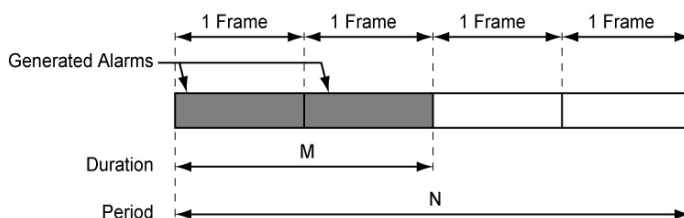

- **Duration** and **Unit**: Select the number of consecutive alarmed frames or the number of consecutive seconds in alarm.
- **Mode**: Allows the selection of the burst mode that will determine if the burst will be repeated (**Repeat**) at the beginning of each period or not (**Single**).
- **Period** and **Unit**: When the **Mode** is set to **Repeat**, select the interval, either in frames or in seconds, the alarm burst will be repeated.
- **On/Off** button: The On/Off button is used to activate/deactivate the selected alarm for the selected **Duration** and **Period**. For **Single Mode**, the alarm generation will be active for the specified duration and will automatically stop (the On/Off button turns Off). For **Repeat Mode** the alarm generation will be active for the specified duration and will be repeated continuously at the beginning of each period until the On/Off button is turned Off. This setting is disabled (Off) by default.

J2 Trace

- **Enable Trace:** Enable Trace, when enabled, generates the J2 Trace message defined. **Enable Trace** has to be enabled to give access to the trace format and message. When the J2 Trace is disabled, the J2 1-byte format is used and can be configured from the *LOP OH TX/RX (SDH, TU-3 path)* on page 367.
- **Format:** Select the display format for J2. Choices are **16** and **64 bytes**. The default setting is **16-bytes**.
- **Message:** Enter the J2 value in 16-bytes or 64-bytes format as selected. The default message is **EXFO SONET/SDH** for 16 bytes and **EXFO SONET/SDH Analyzer low order path trace test message** for 64 bytes. However, with VCAT/LCAS the default message will be **EXFO** followed by the VCG number (VCAT and LCAS) and the SQ (VCAT only) number (for example **EXFO-VCG1-SQ0**) for both 16 and 64 bytes formats.

Note: *16-bytes selection allows typing up to 15 bytes (a CRC-7 byte will be added in front for a total of 16 bytes). 64-bytes selection allows typing up to 62-bytes (<C_R> and <L_F> bytes will be added at the end for a total of 64 bytes). J1 value should be ASCII suitable characters including the ITU T.50 Characters on page 57.*

LOP RX (SDH)

Note: See *LOP RX (SDH, TU-3 path)* on page 364 for *TU-3 path test case*.

Press **TEST**, **LOP**, and **Path** (under **LOP RX**).

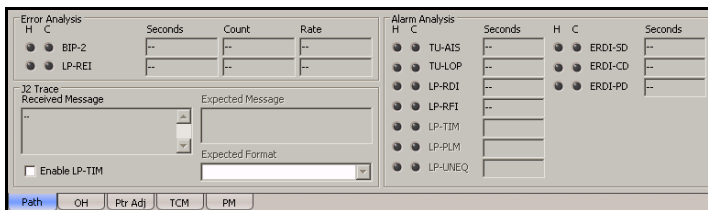

Error Analysis

- **BIP-2** (Bit-Interleave Parity - 2 bits): The BIP-2 error indicates a Low Order Path parity error by performing a routine even-parity check over all bytes of the previous VC frame.
- **LP-REI** (Low Order Path Remote Error Indicator): The LP-REI error is declared when bit 3 of the V5 byte is set to “1”.

Note: Refer to *Alarm/Error Measurements* on page 47 for **H/C LEDs**, **Seconds**, **Count**, and **Rate** information.

Alarm Analysis

- **TU-AIS** (Tributary Unit - Alarm Indication Signal): The TU-AIS alarm is declared when V1 and V2 bytes for the TU path contain an all-ones pattern in five consecutive superframes.
- **TU-LOP** (Tributary Unit - Loss Of Pointer): The TU-LOP alarm indicates that a valid pointer is not found in N consecutive superframes (where $8 \leq N \leq 10$), or if N consecutive NDFs (“1001” pattern) are detected.
- **LP-RDI** (Tributary Unit - Remote Defect Indication): The LP-RDI alarm is declared when bit 8 of V5 byte contains “1” in five consecutive TU superframes while bits 6 and 7 of the K4 byte contain the “00” or “11” pattern.
- **LP-RFI** (Low Order Path - Remote Failure Indication) (available with VC-11 only): The LP-RFI alarm is declared when bit 4 of V5 byte contains “1” in five consecutive superframes.
- **LP-TIM** (Low Order Path - Trace Identifier Mismatch): The LP-TIM defect indicates that none of the sampled LP trace strings match the expected message value. The LP-TIM alarm result is only available when LP-TIM from J2 Trace section has been enabled.
- **LP-PLM** (Low Order Path - Payload Label Mismatch): The LP-PLM is declared upon receipt of five consecutive superframes with mismatched LP Signal (bits 5 through 7 of the V5 byte are “000”, “001” or “111”)
- **LP-UNEQ** (Low Order Path - Unequipped): LP-UNEQ is declared when bit 5 through 7 of the V5 byte contain “000” for five consecutive superframes.
- **ERDI-SD** (Enhanced RDI - Server Defect): The ERDI-SD alarm is declared when bits 5, 6, and 7 of the K4 byte contain the “101” pattern, and bit 8 of the V5 byte contain “1”, in five consecutive LP superframes.

- **ERDI-CD** (Enhanced RDI - Connectivity Defect): The ERDI-CD alarm is declared when bits 5, 6, and 7 of the K4 byte contain the “110” pattern, and bit 8 of the V5 byte contain “1”, in five consecutive LP superframes.
- **ERDI-PD** (Enhanced RDI - Path Payload Defect): The ERDI-PD alarm is declared when bits 5, 6, and 7 of the K4 byte contain the “010” pattern, and bit 8 of the V5 byte contain “0”, in five consecutive LP superframes.

Note: Refer to Alarm/Error Measurements on page 47 for **H/C LEDs**, and **Seconds** information.

J2 Trace

- **Received Message:** Displays the J2 value in 16-bytes or 64-bytes format. The <crc7> represents the CRC-7 for a 16-bytes format. The last two bytes of a 64-bytes format, <C_R> and <L_F>, represent respectively a carriage return and a line feed.
- **Enable LP-TIM** (Low Order Path - Trace Identifier Mismatch): Allows enabling the Trace Identifier Mismatch for the expected message defined. **Enable LP-TIM** has to be enabled to give access to the expected trace format and message. When Enable LP-TIM is disabled, the J2 1-byte is available from the *LOP OH TX/RX (SDH)* on page 356.
- **Expected Message:** Allows entering the message that is expected. J2 value should be ASCII suitable characters. The default message is **EXFO SONET/SDH** for 16 bytes and **EXFO SONET/SDH Analyzer high order path trace test message** for 64 bytes. However, with VCAT/LCAS the default message will be **EXFO** followed by the VCG number (VCAT and LCAS) and the SQ (VCAT only) number (for example **EXFO-VCG1-SQ0**) for both 16 and 64 bytes formats.
- **Expected Format:** Allows the selection of the format expected. Choices are **16** or **64 bytes**. The default setting is **16 bytes**.

LOP OH TX/RX (SDH)

The LOP OH TX allows changing the low order path transport overhead information to be transmitted while the LOP OH RX allows verification of the low order path transport overhead information received.

Note: See *LOP OH TX/RX (SDH, TU-3 path)* on page 367 for *TU-3 path test case*.

Press **TEST**, **LOP**, and **OH** (under **LOP TX/RX**).

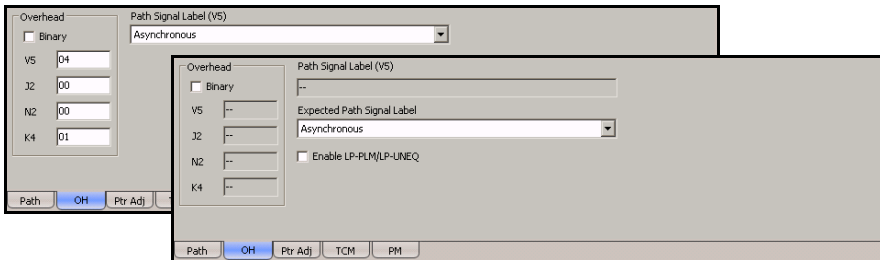

Path Overhead

Enter the path overhead values in hexadecimal or binary.

- **Binary** allows either displaying all overhead values in binary (when enabled) or hexadecimal (when disabled). This setting is disabled by default.
- **V5** (VC Path Overhead)
- **J2** (Path Trace). J2 is only available when **Enable Trace** from the *LOP TX (SDH)* on page 347 is disabled.
- **N2** (Network operator byte) Tandem Connection Monitoring
- **K4** (Extended signal label)

Path Signal Label (V5)

The V5 byte is allocated to indicate the content of the VC path, including the status of the mapped payloads.

Bits 5, 6, 7 of V5	Description
000 ^a	Unequipped or supervisory-unequipped
001	Reserved (Equipped - Non-specific)
010	Asynchronous
011	Bit Synchronous
100	Byte Synchronous
101	Extended Signal Label
110	Test Signal, ITU-T 0.181 specific mapping
111 ^a	VC-AIS (TCM)

- a. These bytes cannot be selected in receive mode.

For HOP OH RX tab only:

- **Expected Path Signal Label:** Allows selecting the expected Path Signal Label.
- **Enable LP-PLM/LP-UNEQ (Low Order Path - Payload Label Mismatch / Unequipped):** Allows enabling the Signal Label Mismatch for the expected message defined.

LOP TX (SDH, TU-3 path)

Press **TEST**, **LOP**, and **Path** (under **LOP TX**).

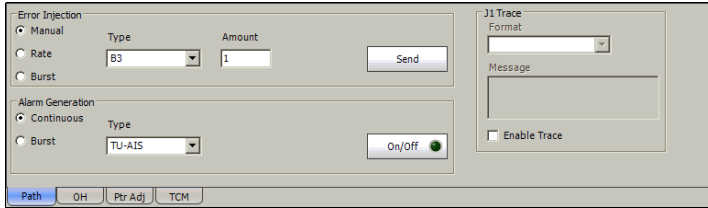

Error Injection

Allows **Manual**, **Rate**, or **Burst** error injection methods.

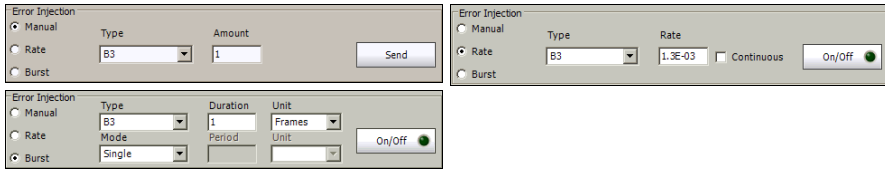

- **Type:** The following errors are available: **B3** (BIP-8, Bit-Interleave Parity - 8 bits) and **LP-REI** (Low Order Path - Remote Error Indicator).

For **Manual** method:

- **Amount:** Select the amount of manual error to be generated. Choices are **1** through **50**. The default setting is **1**.
- **Send** button: Press **Send** to manually generate error(s) according to the **Error Type** and the **Amount of Errors** selected.

For **Rate** method:

- **Rate:** Select the injection rate for the selected error. The rate must be within the minimum and maximum values specified.
- **Continuous:** Generates the selected error to its theoretical maximum rate when the **Continuous** check box is selected. The **Continuous** check box is cleared by default.
- **On/Off** button: The On/Off button is used to activate/deactivate the selected error at the rate specified or at its theoretical maximum rate when the **Continuous** check box is selected. This setting is disabled (Off) by default.

SDH Tabs

LOP TX (SDH, TU-3 path)

For **Burst** method:

The burst method injects the programmed number of consecutive errored frames, representing the burst duration (M), over a specific event period (N).

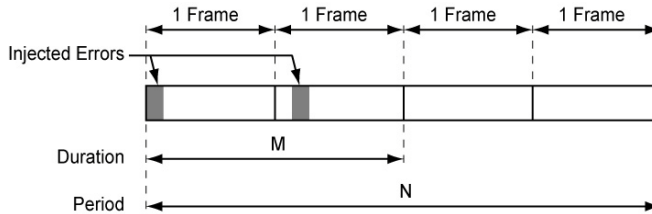

- **Duration and Unit:** Select the number of consecutive errored frames or the number of consecutive seconds in error.
- **Mode:** Allows the selection of the burst mode that will determine if the burst will be repeated (**Repeat**) at the beginning of each period or not (**Single**).
- **Period and Unit:** When the **Mode** is set to **Repeat**, select the interval, either in frames or in seconds, the error burst will be repeated.
- **On/Off** button: The On/Off button is used to activate/deactivate the selected error for the selected **Duration** and **Period**. For **Single Mode**, the injection will be active for the specified duration and will automatically stop (the On/Off button turns Off). For **Repeat Mode** the error injection will be active for the specified duration and will be repeated continuously at the beginning of each period until the On/Off button is turned Off. This setting is disabled (Off) by default.

Alarm Generation

Allows **Continuous** or **Burst** alarm generation methods.

The image shows two side-by-side screenshots of the 'Alarm Generation' configuration window. Both windows have a title bar 'Alarm Generation' and two radio buttons: 'Continuous' (selected) and 'Burst'.
 The left window shows the 'Continuous' method with a 'Type' dropdown menu set to 'TU-AIS' and an 'On/Off' button with a green indicator.
 The right window shows the 'Burst' method. It has a 'Type' dropdown menu set to 'TU-AIS', a 'Duration' field set to '1', and a 'Unit' dropdown menu set to 'Frames'. It also has an 'On/Off' button with a green indicator.

➤ **Type:** The following errors are available:

TU-AIS (Tributary Unit - Alarm Indication Signal): Generates an all-ones patterns for the path and payload.

LP-RDI (Low Order Path - Remote Defect Indication): Generates a “100” pattern for bits 5, 6 and 7 of the G1 byte.

ERDI-SD (Enhanced RDI - Server Defect): Generates a “101” pattern for the bits 5, 6 and 7 of the G1 byte.

ERDI-CD (Enhanced RDI - Connectivity Defect): Generates a “110” pattern for the bits 5, 6 and 7 of the G1 byte.

ERDI-PD (Enhanced RDI - Path Payload Defect): Generates a “010” pattern for the bits 5, 6 and 7 of the G1 byte.

TU-LOP (Tributary Unit - Loss of Pointer): Generates a non-valid pointer.

LP-UNEQ (Low Order Path - Unequipped): Generates samples of unequipped signal labels (C2 is set to “00 H”).

SDH Tabs

LOP TX (SDH, TU-3 path)

For **Continuous** method:

- **On/Off** button: The On/Off button is used to activate/deactivate the selected alarm. This setting is disabled (Off) by default.

For **Burst** method:

The burst method injects the programmed number of consecutive alarmed frames, representing the burst **Duration** (M), over a specific event **Period** (N).

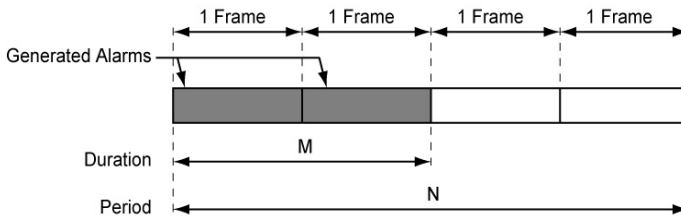

- **Duration** and **Unit**: Select the number of consecutive alarmed frames or the number of consecutive seconds in alarm.
- **Mode**: Allows the selection of the burst mode that will determine if the burst will be repeated (**Repeat**) at the beginning of each period or not (**Single**).
- **Period** and **Unit**: When the **Mode** is set to **Repeat**, select the interval, either in frames or in seconds, the alarm burst will be repeated.
- **On/Off** button: The On/Off button is used to activate/deactivate the selected alarm for the selected **Duration** and **Period**. For **Single Mode**, the alarm generation will be active for the specified duration and will automatically stop (the On/Off button turns Off). For **Repeat Mode** the alarm generation will be active for the specified duration and will be repeated continuously at the beginning of each period until the On/Off button is turned Off. This setting is disabled (Off) by default.

J1 Trace

- **Enable Trace:** Enable Trace, when enabled, generates the J1 Trace message defined. **Enable Trace** has to be enabled to give access to the trace format and message. When the J1 Trace is disabled, the J1 1-byte format is used and can be configured from the *LOP OH TX* on page 356.
- **Format:** Displays the J1 value in **16-bytes** or **64-bytes** format. The default setting is **16-bytes**.
- **Message:** Enter the J1 trace value in 16 or 64 bytes format as selected. The default message is **EXFO SONET/SDH** for 16 bytes and **EXFO SONET/SDH Analyzer low order path trace test message** for 64 bytes. However, with VCAT/LCAS the default message will be **EXFO** followed by the VCG number (VCAT and LCAS) and the SQ (VCAT only) number (for example **EXFO-VCG1-SQ0**) for both 16 and 64 bytes formats.

Note: *16-bytes selection allows typing up to 15 bytes (a CRC-7 byte will be added in front for a total of 16 bytes). 64-bytes selection allows typing up to 62-bytes (<C_R> and <L_F> bytes will be added at the end for a total of 64 bytes). J1 value should be ASCII suitable characters including the ITU T.50 Characters on page 57.*

SDH Tabs

LOP RX (SDH, TU-3 path)

LOP RX (SDH, TU-3 path)

Press **TEST**, **LOP**, and **Path** (under **LOP RX**).

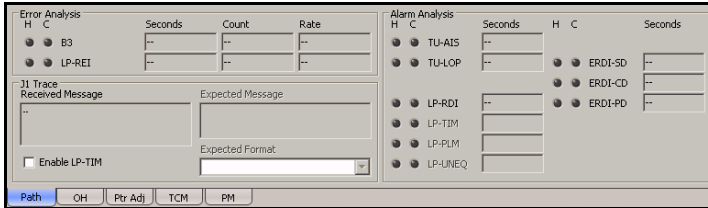

Error Analysis

- **B3 (BIP-8, Bit-Interleave Parity - 8 bits):** The B3 error indicates a High Order Path parity error by performing a routine even-parity check over all High Order Path bits of the previous VC-N.
- **LP-REI (Low Order Path Remote Error Indicator):** The LP-REI error indicates the count of B3 errors detected.

Note: Refer to Alarm/Error Measurements on page 47 for **H/C LEDs**, **Seconds**, **Count**, and **Rate** information.

Alarm Analysis

- **TU-AIS** (Tributary Unit - Alarm Indication Signal): The TU-AIS alarm is declared when the H1 and H2 bytes contain an all-ones pattern in three consecutive frames
- **TU-LOP** (Tributary Unit - Loss Of Pointer): For non-concatenated payloads, the TU-LOP alarm indicates that a valid pointer is not found in N consecutive frames (where $8 \leq N \leq 10$), or N consecutive NDFs (“1001” pattern) are detected.
- **LP-RDI** (Tributary Unit - Remote Defect Indication): The LP-RDI alarm is declared when bits 5, 6 and 7 of the G1 byte contain the “100” or “111” pattern in five consecutive frames.
- **LP-TIM** (Low Order Path - Trace Identifier Mismatch): The LP-TIM defect indicates that none of the sampled path trace strings match the expected message value. The LP-TIM alarm result is only available when LP-TIM from J1 Trace section has been enabled.
- **LP-PLM** (Low Order Path - Payload Label Mismatch): The LP-PLM is declared upon receipt of five consecutive frames with mismatched VC signal labels.
- **LP-UNEQ** (Low Order Path - Unequipped): LP-UNEQ is declared when the C2 bytes contain “00 H” in five consecutive frames.
- **ERDI-SD** (Enhanced RDI - Server Defect): The ERDI-SD alarm is declared when bits 5, 6 and 7 of the G1 byte contain the “101” pattern in five consecutive frames.

SDH Tabs

LOP RX (SDH, TU-3 path)

- **ERDI-CD** (Enhanced RDI - Connectivity Defect): The ERDI-CD alarm is declared when bits 5, 6 and 7 of the G1 byte contain the “110” pattern in five consecutive frames.
- **ERDI-PD** (Enhanced RDI - Path Payload Defect): The ERDI-PD alarm is declared when bits 5, 6 and 7 of the G1 byte contain the “010” pattern in five consecutive frames.

Note: Refer to Alarm/Error Measurements on page 47 for **H/C LEDs**, and **Seconds** information.

J1 Trace

- **Received Message:** Displays the J1 value in 16-bytes or 64-bytes format. The <crc7> represents the CRC-7 for a 16-bytes format. The last two bytes of a 64-bytes format, <C_R> and <L_F>, represent respectively a carriage return and a line feed.
- **Enable LP-TIM** (Trace Identifier Mismatch - Path): Allows enabling the Trace Identifier Mismatch for the expected message defined. **Enable LP-TIM** has to be enabled to give access to the expected trace format and message. When Enable LP-TIM is disabled, the J1 1-byte is available from the *LOP OH RX (SDH, TU-3 path)* on page 367.
- **Expected Message:** Allows entering the message that is expected. J1 value should be ASCII suitable characters. The default message is **EXFO SONET/SDH** for 16 bytes and **EXFO SONET/SDH Analyzer high order path trace test message** for 64 bytes. However, with VCAT/LCAS the default message will be **EXFO** followed by the VCG number (VCAT and LCAS) and the SQ (VCAT only) number (for example **EXFO-VCG1-SQ0**) for both 16 and 64 bytes formats.
- **Expected Format:** Allows the selection of the format expected. Choices are **16** or **64 bytes**. The default setting is **16 bytes**.

LOP OH TX/RX (SDH, TU-3 path)

The **LOP OH TX** allows changing the low order path transport overhead information to be transmitted while the **LOP OH RX** allows verification of the low order path transport overhead information received.

Press **TEST**, **LOP**, and **OH** (under **LOP TX/RX**).

The image displays two screenshots of a configuration window. The top screenshot shows the 'Overhead' tab with a 'Binary' checkbox and input fields for J1, B3, C2, G1, F2, H4, F3, K3, and N1. The bottom screenshot shows the 'Path Signal Label (C2)' tab with the same input fields, an 'Expected Path Signal Label' field, and an 'Enable LP-PLM/LP-UNEQ' checkbox. Both screenshots have a 'Path' tab selected and a 'Ptr Adj' button.

Path Signal Label (C2)

The C2 byte is allocated to indicate the content of the VC, including the status of the mapped payloads. See *Path Signal Label (C2)* on page 346 for available/possible choices.

For LOP OH RX tab only:

- **Expected Path Signal Label:** Allows selecting the expected Path Signal Label.
- **Enable LP-PLM/LP-UNEQ (Low Order Path - Payload Label Mismatch / Unequipped):** Allows enabling the Signal Label Mismatch for the expected message defined.

SDH Tabs

LOP OH TX/RX (SDH, TU-3 path)

Path Overhead

- **Binary:** Allows either displaying all overhead values in binary (when enabled) or hexadecimal (when disabled). This setting is disabled by default.
- **J1:** Trace
- **B3:** BIP-8. This byte is not programmable from the HOP OH TX tab.
- **C2:** Path Signal Label
- **G1:** Path Status
- **F2:** User Channel
- **H4:** Multiframe Indicator
- **F3:** User Channel
- **K3:** Automatic Protection Switching (APS)
- **N1:** (Network Operator) Tandem Connection Monitoring (TCM)

14 PDH Tabs

The PDH tabs allow configuration of different test parameters and to view the test status and results.

Note: *The available tabs listed are a function of the test path activated. Not available on the IQS-8140.*

Signal	Tab	Page
E0/64K	<i>E0/64K TX</i>	370
	<i>E0/64K RX</i>	373
E1/2M	<i>E1/2M TX</i>	378
	<i>E1/2M RX</i>	378
	<i>Performance Monitoring (PM)^a</i>	504
E2/8M	<i>E2/8M TX</i>	381
	<i>E2/8M RX</i>	383
	<i>Performance Monitoring (PM)^a</i>	504
E3/34M	<i>E3/34M TX</i>	385
	<i>E3/34M RX</i>	387
	<i>Performance Monitoring (PM)^a</i>	504
E4/140M	<i>E4/140M TX</i>	389
	<i>E4/140M RX</i>	391
	<i>Performance Monitoring (PM)^a</i>	504

a. This tab is described in the *Common Tabs* section.

E0/64K TX

Press **TEST**, **DSn-PDH**, and **E0** (under **DSn-PDH TX**).

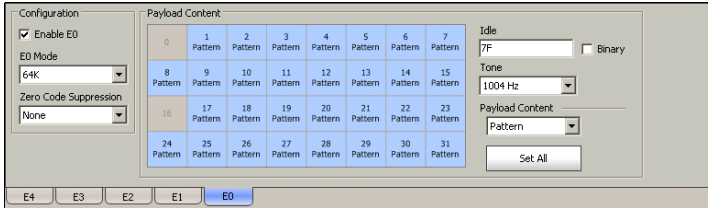

Note: *E0/64K TX configuration is not available when the selected framing from the E1/2M TX on page 375 is unframed. The framing structure PCM-30 and PCM30 CRC-4 have 30 channel timeslots while PCM-31 and PCM-31 CRC-4 have 31 channel timeslots.*

Configuration

- **Enable E0:** Allows the activation of E0/64K testing. This setting is disabled (Off) by default unless otherwise set during the test setup.
- **E0 Mode:** Allows the selection of the channel timeslot data rate for the pattern payload content. Choices are **56K** and **64K**. The default setting is **64K**.

56K: A timeslot data rate of 56 Kbps uses 7 bits to carry the payload information.

64K: A timeslot data rate of 64 Kbps uses 8 bits to carry the payload information.

- **Zero Code Suppression:** Allows the selection of the Zero Code Suppression (ZCS) method used to replace the all-zero bytes of all Idle and Tone payload contents. The ZCS mechanism is a global parameter meaning that all channel timeslots configured with Tone/Idle data, use the same ZCS method. Choices are **None** and **Jammed Bit 8**. The default setting is **None**.

None: No Zero Code Suppression

Jammed Bit 8: Every 8th (LSB) bit is forced to **1**.

Note: *Bit 8 is the Least-Significant Bit (LSB) and bit 1 is the Most-Significant Bit (MSB).*

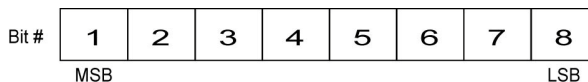

Payload Content

Select the payload content by pressing once or several times on each timeslot until the desired content appears (or use the Set All buttons). Choices are **Pattern**, **Idle**, and **Tone**. The default setting is **Pattern**.

- **Pattern:** Uses the selected pattern from the *Pattern TX* on page 405.
- **Idle:** Uses the Idle code byte from the Idle field. Choices are **00** to **FF**. The selected Idle code applies to all timeslots set to Idle. The default setting is **7F**.
Binary: Allows either displaying the Idle code values in binary (when enabled) or hexadecimal (when disabled). This setting is disabled by default.
- **Tone:** Allows the selection of a tone for digital milliwatt testing. The signal output power, when converted to analog, is 0 dBm. Choices are **1000 Hz** and **1004 Hz**. The selected Tone applies to all timeslots set to Tone. The default setting is **1004 Hz**.
- **Payload Content:** Allows the selection of the payload content that will be applied when pressing **Set All**. Choices are **Pattern**, **Idle**, and **Tone**.
- **Set All:** Allows to set the payload content of all timeslots to the selected payload content with its Pattern, Idle, or Tone value.

Note: *The timeslots set to Idle or Tone can be changed from Idle to Tone and vice versa even when the test is running; the Idle and Tone values can also be changed.*

E0/64K RX

Press **TEST**, **DSn-PDH**, and **E0** (under **DSn-PDH RX**).

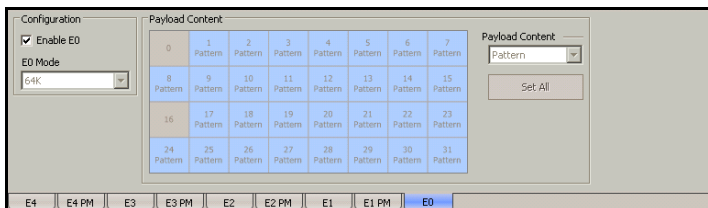

Note: E0/64K RX configuration is not available when the selected framing from the E1/2M RX on page 378 is unframed. The framing structure PCM-30 and PCM30 CRC-4 have 30 channel timeslots while PCM-31 and PCM-31 CRC-4 have 31 channel timeslots.

Configuration

Note: See E0/64K TX on page 370 for more information on **Enable E0** and **E0 Mode**.

Payload Content

Note: *Payload content configuration is only available for decoupled test mode, otherwise the payload content is coupled with the E0/64K TX configuration.*

Select the payload content by pressing once or several times on each timeslot until the desired content appears (or use the Set All buttons). Choices are **None** and **Pattern**. The default setting is **Pattern**.

- **Pattern:** Uses the pattern from the received signal.
- **None:** Does not use the pattern.
- **Set All:** Allows to set the payload content of all timeslots with (Pattern) or without (None) the selected Pattern.

E1/2M TX

Press **TEST**, **DSn-PDH**, and **E1** (under **DSn-PDH TX**).

Configuration

Framing: Select the framing that will be used for transmission. Choices are **Unframed**, **PCM30**, **PCM30 CRC-4**, **PCM31**, and **PCM31 CRC-4**. The default setting is **PCM30**.

Alarm Generation

Type: Select the type of alarm to be generated. Choices are **AIS**, **RAI**, **LOF**, **RAI MF**, **LOMF**, **CRC LOMF**, and **TS16 AIS**. The default setting is **AIS**.

Note: Only **AIS** is available when the framing is set to **Unframed**. **CRC LOMF** is available when the framing is set to **PCM30 CRC-4** or **PCM31 CRC-4**.

On/Off button: Press **On/Off** to enable/disable the alarm generation.

Error Injection

Allows manual or automated error injection.

- **Type:** The following error types are available with both manual and automated injection modes. Choices are **FAS**, **CRC-4**, and **E-bit**. The default setting is **FAS**.

Note: *Available choices depend on the selected framing.*

- **Amount:** Select the amount of error to be generated. Choices are **1** through **50**. The default setting is **1**.
- **Send** button: Press **Send** to manually generate error(s) according to the Error Type and the Amount of Errors selected.
- **Rate:** Press **Rate** to select the injection rate for the selected error. The rate must be within the minimum and maximum values specified. The default setting is **1.0E-2**.
- **Continuous:** Generates the selected error to its theoretical maximum when the **Continuous** check box is selected. The **Continuous** check box is cleared by default.
- **On/Off** button: The On/Off button is used to activate/deactivate the selected automated error at the rate specified or at its theoretical maximum rate when the **Continuous** check box is selected. This setting is disabled (Off) by default.

Spare Bits

Note: *Spare Bits are not available when Framing is set to Unframed.*

Press the individual drop list and select the value for each spare bit.

- **S_{i0}** is located in the bit 1 of the frame containing the frame alignment signal (FAS). S_{i0} is reserved for national use and should be set to 1 when not used. Choices are **0** and **1**. The default setting is **1**.
- **S_{i1}** is located in the bit 1 of the frame not containing the frame alignment signal (FAS). S_{i1} is reserved for national use and should be set to 1 when not used. Choices are **0** and **1**. The default setting is **1**.
- **S_{a4} to S_{a8}** are located in bit 4 to 8 of frame number 1, 3, 5 and 7 of sub-multiframe 1 and 2. S_{a4} to S_{a8} is reserved for national use and should be set to 1 when not used. Choices are **0** and **1** or **0000** to **1111** depending on the selected framing. The default setting is **1** or **1111** depending on the selected framing.
- **TS16 Frame 0 Bit 5, 7, 8** are located in bit 5, 7 and 8 from Timeslot 16 of frame 0 of a E1 signal. TS16 Frame 0 Bit 5, 7, 8 are reserved for national use and should be set to 1 when not used. Choices are **000** to **111**. The default setting is **111**.

E1/2M RX

Press **TEST**, **DSn-PDH**, and **E1** (under **DSn-PDH RX**).

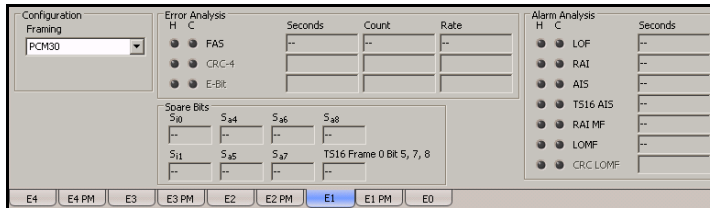

Configuration

Note: See E1/2M TX on page 375 for more information on **Framing**.

Error Analysis

- **FAS** (Frame Alignment Signal): A FAS error indicates that bits 2 to 8 of the frame containing the FAS differ from 0011011.
- **CRC-4** (Cyclical Redundancy Check): A CRC-4 error indicates that one or more bit errors are detected in a block of data through cyclical redundancy check.
- **E-Bit** (CRC-4 Error Signal): A E-Bit error indicates that bit 1 of sub-multiframe (SMF) II in frame 13 and/or 15 is set to 0 indicating a sub-multiframe error.

Alarm Analysis

Note: Only AIS is available when the **Framing** is set to **Unframed**.

- **LOF** (Loss Of Frame): The LOF alarm indicates that three consecutive incorrect frame alignment signals have been received.
- **RAI** (Yellow) (Remote Alarm Indication): The RAI alarm is declared when bit 3 in timeslot 0 is set to “1”.
- **AIS** (Alarm Indication Signal): The AIS alarm is declared when an unframed all-ones signal is received.
- **TS16 AIS** (TimeSlot 16 Alarm Indication Signal): The TS16 AIS alarm is declared when timeslot 16 is received as all-ones for all frames of two consecutive multiframes.
- **RAI MF** (Remote Alarm Indication Multi-Frame): The RAI MF alarm is declared when bit 6 of timeslot 16 of frame 0 is set to “1”.
- **LOMF** (Loss Of MultiFrame): The LOMF alarm indicates that two consecutive multiframes alignment signals (bits 1 through 4 of TS16 of frame 0) have been received with an error.
- **CRC LOMF** (CRC Loss Of MultiFrame): The CRC LOMF indicates that the first bit of the NFAS in frames 1, 3, 5, 7, 9 and 11 differ from 0, 0, 1, 0, 1 and 1 respectively. CRC LOMF is available when the framing is set to PCM30 CRC-4 or PCM31 CRC-4 and is based on CRC-4 errors.

Note: In most cases the CRC LOMF will be reported at the same time as LOF since the CRC LOMF leads to a LOF as per ITU G.706.

Spare Bits

Note: *Spare Bits are not available when Framing is set to Unframed.*

- **S_{i0}** is located in the bit 1 of the frame containing the frame alignment signal (FAS). Possible values are **0** and **1**.
- **S_{i1}** is located in the bit 1 of the frame not containing the frame alignment signal (FAS). Possible values are **0** and **1**.
- **S_{a4}** to **S_{a8}** are located in bit 4 to 8 of frame number 1, 3, 5 and 7 of sub-multiframe 1 and 2. Possible values are **0** and **1** or **0000** to **1111**.
- **TS16 Frame 0 Bit 5, 7, 8** are located in bit 5, 7 and 8 from Timeslot 16 of frame 0 of a E1 signal. Possible values are **000** to **111**.

E2/8M TX

Press **TEST**, **DSn-PDH**, and **E2** (under **DSn-PDH TX**).

The screenshot shows a configuration window for E2/8M TX. It is divided into three main sections: Configuration, Alarm Generation, and Error Injection. The Configuration section has a Framing dropdown set to 'Framed'. The Alarm Generation section has a Type dropdown set to 'AIS' and an On/Off button with a green indicator. The Error Injection section is split into Manual and Automated. The Manual section has a Type dropdown set to 'FAS' and an Amount input field set to '1', with a Send button. The Automated section has a Type dropdown set to 'FAS', a Rate input field set to '1.0E-02', a Continuous checkbox, and an On/Off button with a green indicator. At the bottom, there are tabs for E4, E3, E2 (selected), E1, and E0.

Configuration

Framing: Select the framing that will be used for transmission. Choices are **Unframed** and **Framed**. The default setting is **Framed**.

Alarm Generation

Type: Select the type of alarm to be generated. Choices are **AIS**, **RAI**, and **LOF**. The default setting is **AIS**.

Note: Only **AIS** is available when the **Framing** is set to **Unframed**.

On/Off button: Press **On/Off** to enable/disable the alarm generation.

Error Injection

Allows manual or automated error injection.

- **Type:** Only the **FAS** error is available with both manual and automated injection modes.
- **Amount:** Select the amount of error to be generated. Choices are **1** through **50**. The default setting is **1**.
- **Send** button: Press **Send** to manually generate error(s) according to the Error Type and the Amount of Errors selected.
- **Rate:** Press **Rate** to select the injection rate for the selected error. The rate must be within the minimum and maximum values specified. The default setting is **1.0E-2**.
- **Continuous:** Generates the selected error to its theoretical maximum when the **Continuous** check box is selected. The **Continuous** check box is cleared by default.
- **On/Off** button: The On/Off button is used to activate/deactivate the selected automated error at the rate specified or at its theoretical maximum rate when the **Continuous** check box is selected. This setting is disabled (Off) by default.

Spare Bits

Note: *Spare Bits are not available when Framing is set to Unframed.*

Press the drop list and select the value for the spare bit.

G.742 Bit 12 represents Bit 12 from Timeslot 1, 2, 3 and 4 respectively. Bit 12 is reserved for national use and should be set to 1 when not used. Choices are **0** and **1**. The default setting is **1**.

E2/8M RX

Press **TEST**, **DSn-PDH**, and **E2** (under **DSn-PDH RX**).

Configuration		Error Analysis			Alarm Analysis	
Framing	H	C	Seconds	Count	Rate	Seconds
Framed	<input type="radio"/>	<input type="radio"/>	--	--	--	<input type="radio"/>
	<input checked="" type="radio"/>	<input checked="" type="radio"/>				<input type="radio"/>
						<input type="radio"/>
						<input type="radio"/>
Spare Bits						
G.742 Bit 12						

E4 E4 PM E3 E3 PM **E2** E2 PM E1 E1 PM E0

Configuration

Note: See E2/8M TX on page 381 for more information on **Framing**.

Error Analysis

FAS (Frame Alignment Signal): A FAS error indicates that bits 1 to 10 of the first frame differ from 1111010000.

Alarm Analysis

Note: *Only AIS is available when the **Framing** is set to **Unframed**.*

- **LOF** (Loss Of Frame): The LOF alarm indicates that four consecutive incorrect frame alignment signals have been received.
- **RAI** (Remote Alarm Indication): The RAI alarm is declared when bit 11 of a framed E2 is set to “1”.
- **AIS** (Alarm Indication Signal): The AIS alarm is declared when an unframed all-ones signal is received.

Spare Bits

Note: *Spare Bits are not available when **Framing** is set to **Unframed**.*

G.742 Bit 12 represent Bit 12 from Timeslot 1, 2, 3 and 4 respectively. Possible values are **0** and **1**.

E3/34M TX

Press **TEST**, **DSn-PDH**, and **E3** (under **DSn-PDH TX**).

Configuration	Alarm Generation	Score Bits
Framing: Framed	Type: AIS	5/231 Bit: 12
	On/Off: <input checked="" type="checkbox"/>	
Error Injection Manual		
Type: FAS	Amount: 1	Send
Error Injection Automated		
Type: FAS	Rate: 1.0E-02	<input type="checkbox"/> Continuous
		On/Off: <input checked="" type="checkbox"/>
E4	E3	E2
		E1
		E0

Configuration

Framing: Select the framing that will be used for transmission. Choices are **Unframed** and **Framed**. The default setting is **Framed**.

Alarm Generation

Type: Select the type of alarm to be generated. Choices are **LOF**, **RAI**, and **AIS**. The default setting is **AIS**.

Note: Only **AIS** is available when the **Framing** is set to **Unframed**.

On/Off button: Press **On/Off** to enable/disable the alarm generation.

Error Injection

Allows manual or automated error injection.

- **Type:** Only the **FAS** error is available with both manual and automated injection modes.
- **Amount:** Select the amount of error to be generated. Choices are **1** through **50**. The default setting is **1**.
- **Send** button: Press **Send** to manually generate error(s)
- **Rate:** Press **Rate** to select the injection rate for the selected error. The rate must be within the minimum and maximum values specified. The default setting is **1.0E-2**.
- **Continuous:** Generates the selected error to its theoretical maximum when the **Continuous** check box is selected. The **Continuous** check box is cleared by default.
- **On/Off** button: The On/Off button is used to activate/deactivate the selected automated error at the rate specified or at its theoretical maximum rate when the **Continuous** check box is selected. This setting is disabled (Off) by default.

Spare Bits

Note: *Spare Bits are not available when **Framing** is set to **Unframed**.*

Press the drop list and select the value for the spare bit.

G.751 Bit 12 is reserved for national use and should be set to 1 when not used. Choices are **0** and **1**. The default setting is **1**.

E3/34M RX

Press **TEST**, **DSn-PDH**, and **E3** (under **DSn-PDH RX**).

Configuration			Error Analysis			Alarm Analysis														
Framing			H	C	Seconds	Count	Rate	H	C	Seconds										
Framed			<input type="radio"/>	<input type="radio"/>	--	--	--	<input type="radio"/>	<input type="radio"/>	--										
			Spare Bits						<input type="radio"/>											
			G.751 Bit 12						<input type="radio"/>											
			<input type="text"/>						<input type="radio"/>											
<table border="1"> <tr> <td>E4</td> <td>E4 PM</td> <td>E3</td> <td>E3 PM</td> <td>E2</td> <td>E2 PM</td> <td>E1</td> <td>E1 PM</td> <td>E0</td> </tr> </table>												E4	E4 PM	E3	E3 PM	E2	E2 PM	E1	E1 PM	E0
E4	E4 PM	E3	E3 PM	E2	E2 PM	E1	E1 PM	E0												

Configuration

Note: See E3/34M TX on page 385 for more information on **Framing**.

Error Analysis

FAS (Frame Alignment Signal): A FAS error indicates that bits 1 to 10 of the first frame differ from 1111010000.

Alarm Analysis

Note: *Only AIS is available when the **Framing** is set to **Unframed**.*

LOF (Loss Of Frame): The LOF alarm indicates that four consecutive incorrect frame alignment signals have been received.

RAI (Remote Alarm Indication): The RAI alarm is declared when bit 11 of a framed E3 is set to “1”.

AIS (Alarm Indication Signal): The AIS alarm is declared when an unframed all-ones signal is received.

Spare Bits

Note: ***Spare Bits** are not available when **Framing** is set to **Unframed**.*

G.751 Bit 12 is reserved for national use. Possible values are **0** and **1**. The default setting is **1**.

E4/140M TX

Press **TEST**, **DSn-PDH**, and **E4** (under **DSn-PDH TX**).

The screenshot shows a configuration window for E4/140M TX. It includes the following fields and controls:

- Configuration:** Framing dropdown set to "Framed".
- Alarm Generation:** Type dropdown set to "AIS", and an "On/Off" button with a green indicator.
- Score Bits:** A dropdown menu set to "111".
- Error Injection Manual:** Type dropdown set to "FAS", Amount input field set to "1", and a "Send" button.
- Error Injection Automated:** Type dropdown set to "FAS", Rate input field set to "1.0E-02", a "Continuous" checkbox, and an "On/Off" button with a green indicator.
- Navigation:** A row of tabs labeled E4, E3, E2, E1, and E0, with E4 selected.

Configuration

Framing: Select the framing that will be used for transmission. Choices are **Unframed** and **Framed**. The default setting is **Framed**.

Alarm Generation

Type: Select the type of alarm to be generated. Choices are **AIS**, **RAI**, and **LOF**. The default setting is **AIS**.

Note: Only **AIS** is available when the **Framing** is set to **Unframed**.

On/Off button: Press **On/Off** to enable/disable the alarm generation.

Error Injection

Allows manual or automated error injection.

- **Type:** Only **FAS** is available with both manual and automated injection modes.
- **Amount:** Select the amount of error to be generated. Choices are **1** through **50**. The default setting is **1**.
- **Send** button: Press **Send** to manually generate error(s) according to the Error Type and the Amount of Errors selected.
- **Rate:** Press **Rate** to select the injection rate for the selected error. The rate must be within the minimum and maximum values specified. The default setting is **1.0E-2**.
- **Continuous:** Generates the selected error to its theoretical maximum when the **Continuous** check box is selected. The **Continuous** check box is cleared by default.
- **On/Off** button: The On/Off button is used to activate/deactivate the selected automated error at the rate specified or at its theoretical maximum rate when the **Continuous** check box is selected. This setting is disabled (Off) by default.

Spare Bits

Note: *Spare Bits are not available when **Framing** is set to **Unframed**.*

Press the drop list and select the value for the spare bit.

G.751 Bit 14, 15, 16 are reserved for national use and should be set to 1 when not used. Choices are **000** to **111**. The default setting is **111**.

E4/140M RX

Press **TEST**, **DSn-PDH**, and **E4** (under **DSn-PDH RX**).

Configuration		Error Analysis			Alarm Analysis				
Framing	H	C	Seconds	Count	Rate	H	C	Seconds	
Framed	<input type="radio"/>	<input type="radio"/>	--	--	--	<input type="radio"/>	<input type="radio"/>	--	
Spare Bits							<input type="radio"/>	<input type="radio"/>	--
G.751 Bit 14, 15, 16							<input type="radio"/>	<input type="radio"/>	--
							<input type="radio"/>	<input type="radio"/>	--

Configuration

Note: See E4/140M TX on page 389 for more information on **Framing**.

Error Analysis

FAS (Frame Alignment Signal): A FAS error indicates that bits 1 to 12 of the first frame differ from 111110100000.

Alarm Analysis

Note: *Only AIS is available when the **Framing** is set to **Unframed**.*

- **LOF** (Loss Of Frame): The LOF alarm indicates that four consecutive incorrect frame alignment signals have been received.
- **RAI** (Remote Alarm Indication): The RAI alarm is declared when bit 13 of a framed E4 is set to “1”.
- **AIS** (Alarm Indication Signal): The AIS alarm is declared when an unframed all-ones signal is received.

Spare Bits

Note: *Spare Bits are not available when **Framing** is set to **Unframed**.*

G.751 Bit 14, 15, 16 are reserved for national use. Possible values are **000** to **111**.

15 Ethernet Tabs

This section describes the Ethernet, Gb Ethernet, and 10G Ethernet tabs.

Tab	Page
Configuration	393
Error/Alarm TX	396
Error/Alarm RX	399
Statistics TX	401
Statistics RX	402
Client Offset TX ^a	513
Client Offset RX ^a	515

a. These tabs are described in *Common Tabs*.

Note: For Gb Ethernet, the auto-negotiation is automatically activated for a test in **Normal** mode, and deactivated for a test in **Through** mode. The auto-negotiation is not configurable.

Configuration

Allows the configuration and activation of one stream.

Press **TEST, Ethernet / Gb Ethernet / 10G Ethernet, and Configuration.**

The screenshot shows a configuration window with two main sections: 'Stream' and 'Frame Configuration'.
- In the 'Stream' section, there is an 'Enable' checkbox (unchecked), a 'TX Rate' input field with '100.0', and a 'Unit' dropdown menu set to '%'.
- In the 'Frame Configuration' section, there are three input fields: 'Frame Size (Bytes)' with '64', 'Source MAC Address' with '00:03:01:08:36:DD', and 'Destination MAC Address' with 'FE:FE:FE:FE:FE:FE'.
- Below these are 'VLAN' settings: 'ID', 'Type', and 'Priority' (a dropdown menu), and a 'Binary' checkbox (unchecked).
- At the bottom, there are three tabs: 'Configuration' (selected), 'Error/Alarm', and 'Statistics'.

Note: The **Stream** and **Frame Configuration** parameters are only available for editing when the **Enable** check box is cleared.

Ethernet Tabs

Configuration

Stream

- **Enable:** Allows enabling the stream. The stream will be generated only when the test is started.

Note: *The stream can be enabled/disabled even when the test is started and running. A stream cannot be enabled if its MAC address is not valid.*

Note: *The stream is automatically enabled when the test is started and automatically disabled when the test is stopped.*

- **TX Rate:** Allows the selection of the stream rate. The default TX rate is **100%**. TX Rate is only available when the stream is not enabled.

Unit choices are %, **bps**, **Kbps**, **Mbps**, **Gbps**, **Bps**, **KBps**, **MBps**, **GBps**, **fps**, and **IFG**. The default setting is %.

Frame Configuration

Note: *The following frame configuration parameters are only available when the stream is not enabled.*

- **Frame Size (Bytes):** Select the frame size for the stream.

VLAN	Frame Size	
	Minimum	Maximum
None	48	16000
1 Tag	52	16000

Note: *Sending traffic with frame size >1518 in switched network may result in losing all frames.*

- **Source MAC Address:** A default and unique Source Media Access Control (MAC) address of the module is automatically given to the stream. Press the Source MAC address field if the stream MAC address has to be changed and enter the new MAC address.
- **Destination MAC Address:** Enter the destination MAC address of the stream. The default setting is **FE:FE:FE:FE:FE:FE**.
- **VLAN:** When enabled, allows the configuration of VLAN. This setting is disabled by default.

Note: *Enabling/disabling VLAN will affect the Frame Size value.*

- **ID:** Enter the VLAN ID. Choices are **0** through **4095**. The value **4095** is reserved while **0** and **1** have specific utility; refer to *VLAN* on page 642 for more information.
Binary: When selected, allows entering the VLAN ID in binary. The **Binary** check box is cleared by default.
- **Type:** Indicates the supported VLAN Ethernet Type (**8100**).
- **Priority:** Select the VLAN user priority. Choices are **0** to **7**; refer to *VLAN* on page 642 for more information. The default setting is **0 (000 - Low Priority)**.

Error/Alarm TX

Allows Ethernet alarm/error generation.

Press **TEST**, **Ethernet / Gb Ethernet / 10G Ethernet**, and **Error/Alarm TX**.

The screenshot shows a web-based configuration interface for Error/Alarm TX. It is organized into three main panels: PHY Error Injection, MAC Error Injection, and PHY Alarm Generation. Each panel has a 'Manual' section with a 'Type' dropdown menu, an 'Amount' input field, and a 'Send' button. Below the manual section is a 'Rate' section with a 'Type' dropdown, a 'Rate' input field, a 'Continuous' checkbox, and an 'On/Off' button. The 'PHY Alarm Generation' panel has a 'Type' dropdown and an 'On/Off' button. At the bottom of the interface, there are three tabs: 'Configuration', 'Error/Alarm', and 'Statistics'. The 'Error/Alarm' tab is currently selected.

PHY Error Injection

Note: *PHY error generation is not available with Ethernet in ODUflex, or when 10G Ethernet is mapped in GFP.*

- **Type:** The following error is available with both manual and automated injection modes: **Symbol** for Gb Ethernet and **Block** for 10G Ethernet.
- **Amount:** Allows the selection of the amount of manual error to be generated. Choices are **1** through **50**. The default setting is **1**.
- **Send** button: Press **Send** to manually generate error(s) according to the error type and the amount of error.
- **Rate:** Press the **Rate** field to select the rate for the automated error. Choices are: **1.0E-02**, **1.0E-03**, **1.0E-04**, **1.0E-05**, **1.0E-06**, **1.0E-07**, **1.0E-08**, **1.0E-09** or user definable from **1.0E-09** to **1.0E-02**. The default setting is **1.0E-04**.
- **Continuous:** Generates the selected error for each generated frame when the **Continuous** check box is selected while the **On/Off** button is enabled (On). The **Continuous** check box is cleared by default.
- **On/Off** button: The **On/Off** button is used to activate/deactivate the selected automated error at the rate specified or continuously. This setting is disabled (Off) by default.

PHY Alarm Generation

- **Type:** The following alarms are available:

Type	Available with		
	Ethernet	Gb Ethernet	10G Ethernet
Local Fault Generates a local fault sequence.	X		X
Remote Fault: Generates a remote fault sequence.	X	X	X
Link Down: Generates a continuous PCS error (block error). Not available with 10G Ethernet mapped in GFP.			X

- **On/Off** button: The **On/Off** button is used to activate/deactivate the selected alarm. This setting is disabled (Off) by default.

MAC Error Injection

- **Type:** The following error is available with both manual and automated injection modes: **FCS**.
- **Amount:** Allows the selection of the amount of manual error to be generated. Choices are **1** through **50**. The default setting is **1**.
- **Send** button: Press **Send** to manually generate error(s) according to the error type and the amount of selected error.
- **Rate:** Press the **Rate** field to select the rate for the automated error. Choices are: **1.0E-02**, **1.0E-03**, **1.0E-04**, **1.0E-05**, **1.0E-06**, **1.0E-07**, **1.0E-08**, **1.0E-09** or user definable from **1.0E-09** to **1.0E-02**. The default setting is **1.0E-04**.

Ethernet Tabs

Error/Alarm TX

- **Continuous:** Generates the selected error for each generated frame when the **Continuous** check box is selected while the **On/Off** button is enabled (On). The **Continuous** check box is cleared by default.
- **On/Off** button: The **On/Off** button is used to activate/deactivate the selected automated error at the rate specified or continuously. This setting is disabled (Off) by default.

Error/Alarm RX

The alarm/errors statistics are gathered on all received frames, independently of the destination MAC address.

Press **TEST**, **Ethernet / Gb Ethernet / 10G Ethernet**, and **Error/Alarm RX**.

Ethernet and 10G Ethernet

Configuration

Oversize Monitoring

Alarm Analysis

H C Seconds

Link Down --

Local Fault --

Remote Fault --

Error Analysis

H	C	Seconds	Count	Rate
<input type="radio"/>	<input type="radio"/>	--	--	--
<input type="radio"/>	<input type="radio"/>	--	--	--
<input type="radio"/>	<input type="radio"/>	--	--	--
<input type="radio"/>	<input type="radio"/>	--	--	--
<input type="radio"/>	<input type="radio"/>	--	--	--
<input type="radio"/>	<input type="radio"/>	--	--	--
		Total Error Count		--

Gb Ethernet

Configuration

Oversize Monitoring

Alarm Analysis

H C Seconds

Link Down --

Remote Fault --

Error Analysis

H	C	Seconds	Count	Rate
<input type="radio"/>	<input type="radio"/>	--	--	--
<input type="radio"/>	<input type="radio"/>	--	--	--
<input type="radio"/>	<input type="radio"/>	--	--	--
<input type="radio"/>	<input type="radio"/>	--	--	--
<input type="radio"/>	<input type="radio"/>	--	--	--
<input type="radio"/>	<input type="radio"/>	--	--	--
		Total Error Count		--

Configuration

Oversize Monitoring: Enables the monitoring of the **Oversize** error.

Alarm Analysis

- **Link Down:** Indicates that the Ethernet connection is down. The Ethernet connection is down when there is a local or a remote fault condition.
- **Remote Fault:** Indicates that a Remote Fault event is detected.
- **Local Fault:** Indicates that impairments such as LOS, AIS, and OCI are affecting the traffic. Available with Ethernet and 10G Ethernet only.

Note: Alarms/Errors are updated only during test execution.

Error Analysis

- **FCS:** The number of received frames with an invalid FCS.
- **Jabber/Giant:** The number of received frames larger than 1518 (no VLAN tag), or 1522 (1 VLAN tag) bytes with an invalid FCS.
- **Oversize:** The number of received frames larger than 1518 (no VLAN tag), or 1522 (1 VLAN tag) bytes with a valid FCS. **Oversize** error analysis is only available when **Oversize Monitoring** is enabled (see page 399).
- **Runt:** The number of received frames that are smaller than 64 bytes with an invalid FCS.
- **Undersize:** The number of received frames smaller than 64 bytes with a valid FCS.

For Gb Ethernet only:

- **Symbol:** A Symbol Error is declared when an invalid code-group in the code is detected.
- **Idle:** An Idle Error is declared when an error is detected between the end of a frame and the beginning of the next frame.
- **False Carrier:** A False Carrier is declared when data is being received with no valid start of frame.

For Ethernet and 10G Ethernet only:

- **Block:** The number of frames received with an errored block condition. Not available with 10G Ethernet in GFP.

Total Error Count: Indicates the total number of errors including all the above errors at the exception of **Oversize** when the **Oversize Monitoring** check box is not selected.

Statistics TX

Frame statistics are gathered for all Ethernet frames transmitted with a valid FCS.

Press **TEST, Ethernet / Gb Ethernet / 10G Ethernet, and Statistics TX.**

The screenshot displays a web interface for 'Statistics TX'. It features a table for 'Valid Frame Counts' with columns for frame type and 'TX Count'. The rows are Multicast, Broadcast, Unicast, N-Unicast, and Total. To the right, there is a section for 'Total Frame Counts' with a 'TX Count' field. At the bottom, there are three tabs: 'Configuration', 'Error/Alarm', and 'Statistics' (which is currently selected).

Valid Frame Counts	
	TX Count
Multicast	--
Broadcast	--
Unicast	--
N-Unicast	--
Total	--

Total Frame Counts	
	TX Count
	--

Configuration Error/Alarm **Statistics**

Valid Frame Counts

- **Multicast:** The number of Multicast frames transmitted without any FCS errors. Broadcast frames are not counted as multicast frames.
- **Broadcast:** The number of Broadcast frames transmitted without any FCS errors. Broadcast frames have a MAC address equal to **FF-FF-FF-FF-FF-FF**.
- **Unicast:** The number of Unicast frames transmitted without any FCS errors.
- **N-Unicast (Non-Unicast):** The sum of Multicast and Broadcast frames transmitted without any FCS errors.
- **Total:** The number of frames transmitted without any FCS error.

Total Frame Counts

TX Count: Gives the total of all transmitted valid and invalid frames.

Statistics RX

Frame statistics are gathered for all Ethernet frames received with a valid FCS.

Press **TEST, Ethernet / Gb Ethernet / 10G Ethernet, and Statistics RX.**

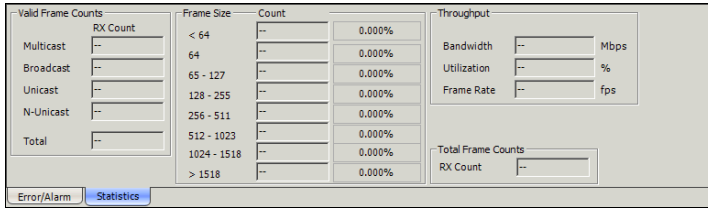

Valid Frame Counts

- **Multicast:** The number of Multicast frames received without any FCS errors. Broadcast frames are not counted as multicast frames.
- **Broadcast:** The number of Broadcast frames received without any FCS errors. Broadcast frames have a MAC address equal to **FF-FF-FF-FF-FF-FF**.
- **Unicast:** The number of Unicast frames received without any FCS errors.
- **N-Unicast (Non-Unicast):** The sum of Multicast and Broadcast frames received without any FCS errors.
- **Total:** The number of frames received without any FCS error.

Frame Size

- **Count:** Gives the count of each received frame size (valid and invalid).
- **Total:** Gives the percentage ratio of each received frame size based on the total count of frames.
- **< 64:** frames with less than 64 bytes.
- **64:** frames equal to 64 bytes.
- **65 - 127:** frames from 65 to 127 bytes.
- **128 - 255:** frames from 128 to 255 bytes.
- **256 - 511:** frames from 256 to 511 bytes.
- **512 - 1023:** frames from 512 to 1023 bytes.
- **1024 - 1518:** frames from 1024 to 1518 or 1522 (VLAN Tag) bytes.
- **> 1518:** frames with more than 1518 or 1522 (VLAN Tag) bytes.

Throughput

- **Bandwidth:** Gives the received data rate expressed in Mbps.
- **Utilization:** Gives the percentage of line rate utilization.
- **Frame Rate:** Gives the received number of frames (including bad frames, Broadcast frames and Multicast frames) in fps (Frame Per Second).

Total Frame Count

RX Count: Gives the total of all received valid and invalid frames.

16 BERT Tabs

This section describes the BERT tabs.

Tab	Page
<i>Pattern TX</i>	405
<i>Pattern RX</i>	409
<i>Performance Monitoring (PM)^a</i>	504
<i>Client Offset TX^a</i>	513
<i>Client Offset RX^a</i>	515

a. This tab is described in the *Common Tabs* section.

Pattern TX

Note: This tab is not used when **Through** mode is enabled.

Press **TEST**, and **BERT**.

The screenshot shows a software configuration window for BERT. It is divided into several sections:

- Configuration:** Includes an for 'Overwrite', a for 'Coupled TX/RX', a 'Test Pattern' dropdown set to 'PRBS 2ⁿ-31-1', an 'Invert' checkbox, a 'User Pattern' dropdown, a 'Pattern #' input field, a 'Value' input field, and a for 'Binary'.
- TX Rate:** A text field containing '1.2441819649382977' and a 'Gbps' dropdown menu.
- Alarm Generation:** A 'Type' dropdown set to 'Pattern Loss' and an 'On/Off' status indicator (green dot).
- Error Injection:** A 'Manual Type' dropdown set to 'Bit Error', an 'Amount' input field with '1', a 'Send' button, a 'Rate Type' dropdown set to 'Bit Error', a 'Rate' input field with '1.0E-02', a for 'Continuous', and an 'On/Off' status indicator (green dot).

At the bottom, there are two tabs: 'Pattern' (selected) and 'Client Offset'.

Configuration

- **Overwrite:** Available with **SONET/SDH Intrusive** through mode down to HOP mapping level only; not supported with DS_n/PDH, LOP, and Next Generation mapping levels. Not available on IQS-8105/IQS-8115. The **Overwrite** check box when selected, allows the termination of the RX pattern and the insertion (TX) of the selected PRBS test pattern.

BERT Tabs

Pattern TX

- **Coupled TX/RX:** Allows coupling both TX and RX signal with the same pattern configuration. This setting is enabled by default and only configurable when the **Overwrite** check box is selected.
- **Test Pattern:** Select the test pattern from the list. Choices are:
PRBS 2 ^ 31-1, PRBS 2 ^ 23-1, PRBS 2 ^ 20-1, PRBS 2 ^ 15-1, PRBS 2 ^ 11-1, PRBS 2 ^ 9-1, 1100, 1010, 1111, 0000, QRSS¹, 1in8, 1in16, 3in24¹, T1 DALY¹, 55 OCTET¹, NULL CLIENT¹, and User Pattern. Only **PRBS 2 ^ 31-1** is available for GFP. Choices depend on the selected test case.
- **Invert:** The generated test pattern will be inverted if the **Invert** check box is selected meaning that every 0 will be changed for 1 and every 1 for 0. For example, the pattern 1100 will be sent as 0011. When the **Invert** check box is selected, its label becomes **Invert (Non-ITU)** indicating that the pattern is inverted compared to the standard definition. The **Invert** check box is cleared by default.
- **User Pattern**
User Pattern is available when **User Pattern** is selected as the test pattern.
Pattern #: Up to 10 patterns can be programmed. Select the pattern number to configure. The default setting is **1**.
Value: Enter the pattern value (4 bytes). The default setting is **00 00 00 00**.
Binary: Allows displaying the pattern value either in binary (when the **Binary** check box is selected) or hexadecimal (when the **Binary** check box is cleared). The **Binary** check box is cleared by default.

Note: *The User Pattern for TX and RX tabs share the same pattern list.*

1. Not available on the IQS-8140.

➤ TX Rate

Allows the selection of the transmission rate. TX Rate is only available when ODUflex is directly mapped to pattern.

Unit choices are %, **Gbps**, **Mbps**, and **Kbps**. The default setting is **Gbps**. The default TX rate is **100%**.

Alarm Generation

Note: *Alarm generation is not available with GFP.*

Type: The only available type of pattern alarm is **Pattern Loss**.

On/Off button: Press the On/Off button to enable/disable the pattern alarm generation. This setting is disabled (Off) by default.

Error Injection

Allows selection and configuration of a manual or automated pattern error that will be generated.

Note: *Only manual error injection is available with GFP.*

Type: The only available type of pattern error is **Bit Error**.

Amount: Select the amount of error to be generated. Choices are **1** through **50**. The default setting is **1**.

Send button: Press **Send** to manually generate the pattern error according to the pattern error type and the amount.

Rate: Press the **Rate** field to select the rate for the selected pattern error. The rate must be within the minimum and maximum values specified.

Continuous: Generates the selected error to its theoretical maximum when the **Continuous** check box is selected while the **On/Off** button is enabled (On). The **Continuous** check box is cleared by default.

On/Off button: The On/Off button is used to activate/deactivate the selected automated pattern error at the rate specified or at its theoretical maximum rate when the **Continuous** check box is selected. This setting is disabled (Off) by default.

Note: *Manual and Automated error injection can run simultaneously.*

Pattern RX

Press **TEST**, and **BERT**.

Configuration

Note: See Configuration on page 405 for more information on **Test Pattern**, **Invert**, and **User Pattern**.

- **Live Traffic:** When enabled, Live Traffic analyzes the line traffic without test pattern thus squelching the pattern loss, bit error, and no traffic (10G Ethernet only) indications. **Live Traffic** is not available when the **Unframed** is selected.
- **Coupled RX/TX:** Allows coupling both TX and RX signal with the same pattern configuration. This setting is enabled by default and only configurable when the **Overwrite** check box is selected (see *Pattern TX* on page 405).

Alarm Analysis

Pattern Loss is declared when the bit error ratio is ≥ 0.20 during an integration interval of 1 second, or it can be unambiguously identified that the test sequence and the reference sequence are out of phase.

No Traffic is declared when no BERT traffic has been received in the last second. Only available when **10G Ethernet** is selected.

Error Analysis

Bit Error: A Bit Error indicates that there are logic errors in the bit stream (i.e., zeros that should be ones and vice versa).

Note: *The following errors are only available for 10G Ethernet.*

Mismatch '0': A Mismatch '0' Error indicates a bit error on a binary "0" (for example ones that should be zeros) found in the test pattern only.

Mismatch '1': A Mismatch '1' Error indicates a bit error on a binary "1" (for example zeros that should be ones) found in the test pattern only.

17 Advanced Tabs

Note: The available tabs listed are a function of the test path activated. Advanced tabs are not available with Unframed, VCAT, LCAS, and GFP.

Tab	Page
<i>Service Disruption Time (SDT)</i>	411
<i>Service Disruption Time (SDT) - Monitor^a</i>	415
<i>Service Disruption Time (SDT) - Results^a</i>	421
<i>Round Trip Delay (RTD)</i>	425

a. Only available with Multi-Channel SDT test mode.

Service Disruption Time (SDT)

The Service Disruption Time (SDT) corresponds to the time during which there is a disruption of service typically due to the network switching from the active channels to the backup channels or vice versa.

Press **TEST** and **SDT/RTD**.

The screenshot shows a software interface for configuring and monitoring Service Disruption Time (SDT). It is divided into two main sections: Configuration and Statistics.

Configuration Section:

- Layer: (Dropdown menu)
- Port: (Dropdown menu)
- Defect Selection: (Dropdown menu, currently set to LOS)
- No Defect Time: 10000 μ s (Text input with unit dropdown)
- Test Period: 5.0 min (Text input with unit dropdown)
- On/Off: (Toggle switch, currently On)

Statistics Section:

- Total Disruption Count: -- (Text input)
- Disruption Time: (Section header)
- Shortest: -- (Text input)
- Longest: -- (Text input)
- Last: -- (Text input)
- Average: -- (Text input)
- Total: -- (Text input)
- Unit: ms (Dropdown menu)

Alarm Analysis Section:

- H C: (Text input)
- Service Disruption: (Radio button, currently selected)
- Seconds: (Text input)

Advanced Tabs

Service Disruption Time (SDT)

Configuration

Select the criteria that will be used for the SDT measurement.

Note: *The service disruption measurements are cleared when changing the criteria.*

- **Layer:** Select on which layer the service disruption time test will be performed. Choices are **Port**, **FEC**, **OTU_k**, **ODU_k**, **OPU_k**, **OTU-1e¹**, **ODU-1e¹**, **OPU-1e¹**, **OTU-2e¹**, **ODU-2e¹**, **OPU-2e¹**, **OTU-1f¹**, **ODU-1f¹**, **OPU-1f¹**, **OTU-2f¹**, **ODU-2f¹**, **OPU-2f¹**, **Section/Regenerator**, **Line/Multiplex**, **HOP**, **LOP¹**, **DS1¹**, **DS3¹**, **E1¹**, **E2¹**, **E3¹**, **E4¹**, and **Pattern**. Where **k** is either 1, 2, or 3. With ODU MUX, ODU1 and OPU1 are not available. Choices depend on the selected test path.
- **Defect Selection:** Choices depend on the selected layer. Refer to the specific layer tab for possible alarms/errors.

Note: *The Service Disruption Time measurement supports a parent defect approach where the SDT measurement is triggered when the selected defect or a higher defect in the signal structure hierarchy is detected. For example, if Bit Error is selected, an OPU-AIS error will raise the SDT trigger.*

Note: *No defect is available with the layer Pattern when Live Traffic from the Pattern RX on page 409 is enabled.*

- **No Defect time:** Represents the period without any defects before stopping SDT measurement. Choices are from **5 μ s** to **1999999 μ s**. The maximum value is adjusted with respect to the test period (the max No Defect time is obtained when the Test Period value is set to its maximum value: 5 min). The default setting is **1000 μ s**. Unit measurement selections are **μ s**, **ms**, and **s**.

1. Not available on IQS-8140.

- **Test Period:** Represents the period of time used to calculate the SDT measurement. Choices are **6 μ s** to **5 minutes**. Unit choices are **μ s**, **ms**, **s**, and **min**. The default setting is **5 minutes**.
- **On/Off** button: Press On/Off to enable/disable the disruption time measurements. However, the measurement will only start if the test is already started, or when the test will be started.

Note: *Stopping the SDT test will stop the measurement without clearing the results. The SDT test is automatically stopped without clearing results when the test is stopped. However, starting the test again while the STD is still On (enabled) will reset the results before restarting.*

Statistics

- **Total Disruption Count:** Indicates the number of disruptions that happened since the beginning of the SDT test.
- **Shortest:** Indicates the shortest measured disruption time.
- **Longest:** Indicates the longest measured disruption time.
- **Last:** Indicates the length of the last measured disruption time.
- **Average:** Indicates the average length of all measured disruption times.
- **Total:** Indicates the total length of all measured disruption times.
- **Unit:** Select the unit for the statistics. Choices are **μ s**, **ms**, **s**, and **min**. The default setting is **ms**.

Note: *When the measured SDT is equal or longer than the Test Period, then the SDT equals the **Test Period time**.*

Advanced Tabs

Service Disruption Time (SDT)

- **Service Disruption:** Indicates the time (in seconds) during which there is a disruption of service due to the absence of traffic or to the detection of defects. The H and C LEDs indicate respectively the current (C) and history (H) SDT measurement states.

The **C** (Current) LED is green when there is no SDT. The **C** LED is red if there is an SDT, and last until the next No Defect Time has been met or the test period is elapsed.

The **H** (History) LED indicates if any SDT occurred in the past (LED is red) or not (LED is green).

Service Disruption Time (SDT) - Monitor

Note: The *SDT - Monitor* tab is available with Multi-Channel SDT test mode.

The Service Disruption Time (SDT) corresponds to the time during which there is a disruption of service due to the network switching from the active channels to the backup channels or vice versa.

Press **TEST**, **SDT**, and **Monitor**.

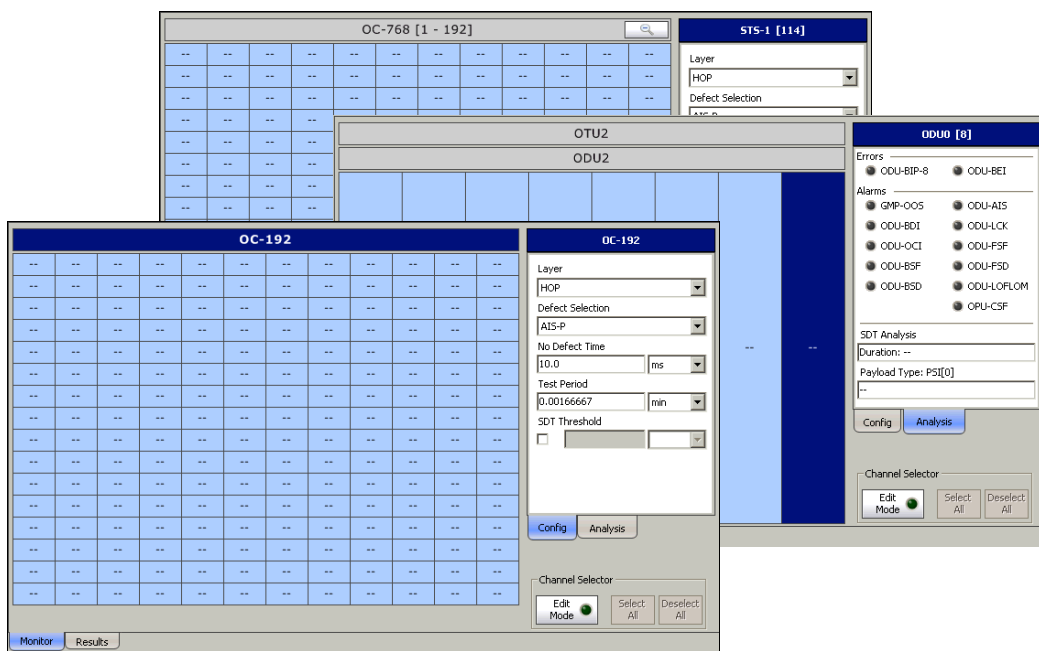

The channel grid is used to indicate the monitoring status of each channel and also to select channels for SDT monitoring when using the channel selector controls (see *Channel Selector* on page 418).

Advanced Tabs

Service Disruption Time (SDT) - Monitor

The channel grid provides the following monitoring information:

- Current alarm/error for all channels.
- Pass/Fail verdict and defect for each channel if global SDT threshold is enabled.
- Triggered on the selected defect for each channel selected if SDT threshold is enabled.
- The longest measured disruption time for each channel selected.

Different border and background colors are used to indicate the status of each channel.

	Color	Indicates
Monitoring	Red border	Any alarm/error is currently active.
	Red background ^a	At least one measured SDT value is bigger than the configured threshold (Fail).
	Green background ^a	All measured SDT values are smaller or equal to the configured threshold (Pass).
Channel selection	Light blue background	Channel selected for SDT measurement.
	Gray background	Channel not selected for SDT measurement.
	Dark blue background	Channel selected to display its detail analysis. Currently selected channel has its detail information presented in the Analysis tab.

- a. Only available when the SDT threshold is enabled

For IQS-8140, the channels are divided in 4 groups of 192 channels. Clicking on a group will zoom the view allowing the selection of a specific channel and display the monitoring status of these channels. The longest measured disruption time is only displayed in the zoomed view. Use the magnifying glass to close the zoomed view.

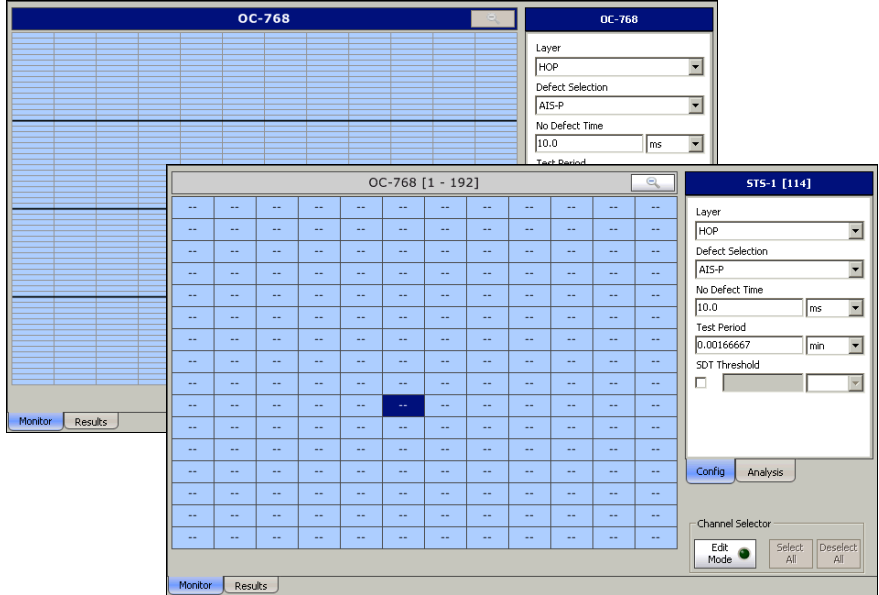

Advanced Tabs

Service Disruption Time (SDT) - Monitor

Channel Selector

- **Edit Mode:** Allows to add or remove channels on which SDT measurement will take place. Click on each channel to be added or removed. Only channels with blue background are selected for SDT measurement. All channels are selected by default.
- **Select All** selects all channels for SDT measurement.
- **Deselect All** deselects all channels.

Config Tab

The config tab displays and allows configuration of the global SDT parameters.

Note: *The service disruption measurements are cleared when changing the criteria. The test needs to be stopped to change the SDT parameters.*

- **Layer:** Select the protocol layer. Choices are **HOP** for SONET/SDH, **ODU0** and **OPU0** for OTN.
- **Defect Selection:** Select the defect which will be used to trigger the SDT measurement. Choices depend on the selected layer. Refer to the specific layer tab for possible alarms/errors (see *Errors/Alarms:* on page 420).

Note: *The Service Disruption Time measurement supports a parent defect approach where the SDT measurement is triggered when the selected defect or a higher defect is detected in the signal structure hierarchy is detected. For example, if Bit Error is selected, an OPU-AIS error will activate the SDT trigger.*

- **No Defect time:** Represents the required period of time without defect that it is needed to collect one disruption time value. Choices are from **10 μ s** to **2 s** in steps of 10 μ s. The maximum value is adjusted with respect to the test period (the max No Defect time is obtained when the Test Period value is set to its maximum value: 5 min). The default setting is **300 ms**. Unit choices are **μ s**, **ms** (default), **s**, and **min**.
- **Test Period:** Represents the maximum period of time allowed for SDT measurement. If this time is reached during a defect, the time measured is logged as an event and a new disruption measurement event is started. Choices are **20 μ s** to **5 minutes** in steps of 10 μ s. Unit choices are **μ s**, **ms**, **s**, and **min** (default). The default setting is **5 min**.

In the case where the duration of a defect is longer than the test period, more than one disruption event will be reported. Increasing the test period may avoid this situation. In the following example, the duration of the defect is longer than the test period.

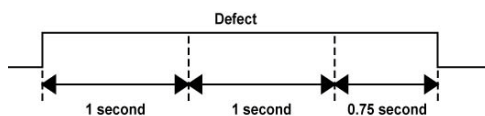

For a test period of 1 second,
 - Total disruption count = 3
 - Longest disruption = 1 second
 - Shortest disruption = 0.75 second

- **SDT Threshold** allows to enabled and enter the SDT threshold value that will be used to declare the pass/fail verdict: 0.001 to 299999.94 ms. The SDT Threshold check box is cleared by default and set to 50 ms. Unit choices are **μ s**, **ms** (default), **s**, and **min**.

Note: *Stopping the SDT test will stop the measurement process without clearing the results. However, starting the test again while the STD is still On (enabled) will reset the results.*

Advanced Tabs

Service Disruption Time (SDT) - Monitor

Analysis Tab

- **Port:** Available with OC-n, STM-n, and OTU1/OTU2/OTU3 signal levels. Refer to *Port RX (Optical Interfaces)* on page 150 for more information.
- **Errors/Alarms:**

	Refer to
Section/Line	<i>Section RX (SONET)</i> on page 219 <i>Line RX (SONET)</i> on page 228
STS-1 Channel	<i>HOP RX (SONET)</i> on page 251
RS/MS	<i>Regenerator Section RX (SDH)</i> on page 311 <i>Multiplex Section RX (SDH)</i> on page 320
AU-4 Channel	<i>HOP RX (SDH)</i> on page 341
OTU	<i>OTU RX</i> on page 163
ODU1/ODU2/ODU3	<i>ODU RX</i> on page 189
ODU0 Channel	<i>ODU RX</i> on page 189 <i>OPU RX</i> on page 203 <i>GMP RX</i> on page 209

- **SDT Analysis:** Available for each channel, indicates the pass/fail verdict and the longest measured disruption time when enabled (see *SDT Threshold* on page 419).
- **Path Signal Label (C2):** Available for each high order path channel, indicates the received Path Signal Label. Refer to *Path Signal Label (C2)* on page 256 for more information.
- **Payload Type PSI[0]:** Available for each ODU channel, indicates the received payload type. Refer to *OPU RX* on page 203 for more information.

Service Disruption Time (SDT) - Results

Note: The *SDT - Results* tab is available with *Multi-Channel SDT* test mode.

The Service Disruption Time (SDT) corresponds to the time during which there is a disruption of service due to the network switching from the active channels to the backup channels or vice versa.

Press **TEST**, **SDT** and **Results**.

Channels Above Threshold	<input type="text" value="0"/>	Duration (ms)	<input type="text" value="100.0"/>	Channel	<input type="text" value="1"/>	Time Stamp	<input type="text" value="00:00:00.000.000"/>
Channels Monitored	<input type="text" value="48"/>	Longest Disruption	<input type="text" value="100.0"/>				
Channel	Disruption Count	Shortest (ms)	Longest (ms)	Last (ms)	Average (ms)	Total Duration (ms)	Verdict
1	229	100.0	100.0	100.0	100.0	22900.0	✓
2	229	100.0	100.0	100.0	100.0	22900.0	✓
3	229	100.0	100.0	100.0	100.0	22900.0	✓
4	229	100.0	100.0	100.0	100.0	22900.0	✓
5	229	100.0	100.0	100.0	100.0	22900.0	✓
6	229	100.0	100.0	100.0	100.0	22900.0	✓
7	229	100.0	100.0	100.0	100.0	22900.0	✓
8	229	100.0	100.0	100.0	100.0	22900.0	✓
9	229	100.0	100.0	100.0	100.0	22900.0	✓
10	229	100.0	100.0	100.0	100.0	22900.0	✓
11	229	100.0	100.0	100.0	100.0	22900.0	✓
12	229	100.0	100.0	100.0	100.0	22900.0	✓
13	229	100.0	100.0	100.0	100.0	22900.0	✓
14	229	100.0	100.0	100.0	100.0	22900.0	✓
15	229	100.0	100.0	100.0	100.0	22900.0	✓
16	229	100.0	100.0	100.0	100.0	22900.0	✓
Verdict Threshold (ms)	<input type="text" value="10000.0"/>	Channel	<input type="text" value="48"/>	Time Stamp	<input type="text" value="00:00:00.180.000"/>	Units	<input type="text" value="ms"/>
Channels with Disruptions	<input type="text" value="48"/>	Last Disruption	<input type="text" value="48"/>	Time Stamp	<input type="text" value="None"/>		
<input type="button" value="Monitor"/> <input type="button" value="Results"/>							

Note: Stopping the SDT test will stop the measurement process without clearing the results. However, starting the test again while the STD is still On (enabled) will reset the results.

Note: When the measured disruption is equal or longer than the Test Period, then the disruption time equals the **Test Period time**.

Advanced Tabs

Service Disruption Time (SDT) - Results

Summary



- **Channel Above Threshold:** Indicates the number of channels that experience a disruption time above the defined threshold since the beginning of the SDT test.
- **Channel Monitored:** Indicates the number of channels that are monitored.
- **Longest Disruption:**
 - **Duration** indicates the duration of the longest measured disruption time.
 - **Channel** indicates the channel number on which the longest disruption time happened.
 - **Time Stamp** indicates when the longest disruption time happened.

Table

SDT statistics are displayed for each channel monitored.

- **Channel** indicates the channel number.
- **Disruption Count** indicates the number of disruption events detected.
- **Shortest** indicates the shortest measured disruption time event.
- **Longest** indicates the longest measured disruption time event and time stamp.
- **Last** indicates the duration of the last measured disruption time event and time stamp.
- **Average** indicates the average duration of all measured disruption time events.
- **Total Duration** indicates the total duration of all measured disruption time events.

- **Verdict** indicates the pass/fail verdict when SDT threshold is enabled, otherwise the column is not displayed. The Pass/Fail verdict is represented by the following icons:

Icon	Verdict	Description
	PASS	The measured SDT values is smaller or equal to the configured threshold.
	FAIL	The measured SDT value is bigger than the configured threshold.

Note: The time stamp is also displayed for each channel when enabled. See Time Stamp on page 424.

Note: The table offers sorting capabilities, an arrow next to the column label name, indicates the sorting column field and the sorting order. Pressing again on the selected sort column label will change the sort order. Pressing another column label allows to sort using a different field. Sorting on the **Last** column label will list the events based on their time stamp.

- **Verdict Threshold (ms)** indicates the selected global SDT threshold value when enabled, otherwise this field is not displayed.
- **Channels with Disruptions** indicates the number of channels that experienced disruptions.
- **Last Disruption** indicates the channel that experienced the last disruption.
 - **Channel** indicates the channel number.
 - **Time Stamp** indicates the date/time.

Advanced Tabs

Service Disruption Time (SDT) - Results

Units

Select the unit that will be used for all statistics on the **Results** tab. Choices are **μs**, **ms** (default), **s**, and **min**.

Time Stamp

Displays either the date & time, only the time, or no date & time (None) for each channel statistic in the table. Choices are **None** (default), **Time**, and **Date/Time**. In the table, an extra line will be added for each channel to display the time, and two lines to displayed the time and date. To change the time format refer to *Test Time Display Mode* on page 529.

Channel	Disruption Count	Shortest (ms)	Longest (ms)	Last (ms)	Average (ms)	Total Duration (ms)	Verdict
1	229	100.0	100.0	100.0	100.0	22900.0	✓
Channel	Disruption Count	Shortest (ms)	Longest (ms)	Last (ms)	Average (ms)	Total Duration (ms)	Verdict
1	6129	100.0	100.0	10:26:49.000.000	100.0	612900.0	✓
Channel	Disruption Count	Shortest (ms)	Longest (ms)	Last (ms)	Average (ms)	Total Duration (ms)	Verdict
1	5659	100.0	100.0 2011-09-08 10:26:49.000.002	100.0 2011-09-08 10:26:49.180.001	100.0	565900.0	✓

Time Stamp set to:

- None

- Time

- Date/Time

Round Trip Delay (RTD)

Press **TEST**, and **SDT/RTD**.

The screenshot shows a software interface for Round Trip Delay (RTD) configuration and statistics. It is divided into two main sections: Configuration and Statistics.

Configuration:

- Mode:** A dropdown menu currently set to "Single".
- On/Off:** A green indicator light is turned on.
- Status:** A text field showing "--".

Statistics:

- Delay:** A section with five input fields: Last, Minimum, Maximum, Average, and Units. The Units dropdown is currently set to "ms".
- Count:** A section with two input fields: Successful and Failed, both currently showing "--".
- Reset:** A button located at the bottom right of the statistics section.

Round Trip Delay (RTD) measurements are needed to quantify the time it takes for the signals to reach their destination. Usually, transport delay is due to two factors: long configured paths and transit times through the network elements along the path. Therefore, RTD measurements are significant in systems that require two-way interactive communication, such as voice telephony, or data systems where the round-trip time directly affects the throughput rate.

Note: *To do Round Trip Delay test, the remote NE should be configured to provide a loopback. However a local DS_n test can be configured to use loopback codes allowing RTD testing.*

Note: *Be aware that RTD requires error free operation conditions to provides reliable results. Therefore, RTD results could be affected by error injection or error introduced by the network.*

Configuration

- **Mode:** Allows the selection of the round trip delay test mode. Choices are **Single** and **Continuous**. The default setting is **Single**.

Single allows testing the round trip delay once when pressing **On/Off**.

Continuous allows testing the round trip delay continuously in a repetitive manner (one RTD measurement every 2 seconds) when pressing **On/Off**.

- **On/Off** button: Allows enabling the round trip delay measurement.

For **Single** mode, the test is performed once and stops (the On/Off button turns Off by itself). The On/Off button is only available when the test is running.

For **Continuous** mode, the test is performed continuously until the RTD test or the test case itself is stopped. However, the measurement will only start if the test is running or when it will be started. The On/Off button turns Off by itself when the auto-calibration fails.

Note: *The Round Trip Delay (RTD) auto-calibration generates some bit errors when turning On the RTD while the test is running or when starting the test case while the On/Off button is On. A far end testing equipment will detect those bit errors.*

Status

Indicates the test status of the RTD test. The status is only available when the test case is running.

- **Ready** indicates that the last calibration sequence has been successful and the test is now ready to perform RTD measurement.
- **Running** indicates that the RTD test is running.
- **Cancelled** indicates that the RTD test has been stopped before its completion.
- **Calibration Failed** indicates that the test calibration failed due to at least one of the following conditions:
 - Internal errors.
 - Bit error/alarm injection like Pattern Loss.

Therefore the RTD statistics becomes unavailable since the test does not allow RTD testing.

- **Disabled:** Indicates that the RTD feature is disabled. For example, this condition occurs for DS0/E0 test case having all its timeslots set to Idle/Tone.
- **--:** Indicates the the RTD measurement is not ready.

Advanced Tabs

Round Trip Delay (RTD)

Statistics

- **Delay:** Indicates the time required for a bit to travel from the transmitter back to its receiver after crossing a far-end loopback.
Last indicates the result of the last Round Trip Delay measurement.
Minimum indicates the minimum Round Trip Delay recorded.
Maximum indicates the maximum Round Trip Delay recorded.
Average indicates the average Round Trip Delay value.
Unit measurement selections are **ms** and **μs**. The default setting is **ms**.
- **Count**
Indicates the total number of **Successful** and **Failed** measurements.
A measurement is declared **Successful** when the RTD is smaller or equal to 2 seconds.
A measurement is declared **Failed** when the RTD is > 2 seconds.
- **Reset** button: Resets the RTD results and measurement counts.

18 Next-Generation Tabs

The Next-Generation tabs include GFP, VCAT and LCAS tabs allowing configuration and to view the test status and results.

Note: *The available tabs listed are a function of the test path activated. GFP, VCAT, and LCAS are available with **ODU2**, **ODU1**, and **optical SONET/SDH** interfaces on IQS-8120NG, IQS-8120NGE, IQS-8130NG, and IQS-8130NGE only. Refer to OTN/SONET/DSn Interface Path/Mapping on page 60 and OTN/SDH/PDH Interface Path/Mapping on page 61 for more information. Next-Generation tabs are not available with Decoupled test mode.*

	Tab	Page
GFP (GFP-F) or GFP-T	<i>GFP Overview TX</i>	431
	<i>GFP Frame TX</i>	435
	<i>GFP Channel TX</i>	435
	<i>GFP Channel Stats TX</i>	439
	<i>GFP OH TX</i>	440
	<i>GFP Client TX</i>	444
	<i>GFP Overview RX</i>	447
	<i>GFP Frames RX</i>	449
	<i>GFP Channel RX</i>	451
	<i>GFP Channel Stats RX</i>	454
	<i>GFP OH RX</i>	455
	<i>GFP Client RX</i>	457

Next-Generation Tabs

	Tab	Page
VCAT	<i>VCAT TX - Overview</i>	459
	<i>VCAT TX - Diff Delay</i>	461
	<i>VCAT RX - Overview</i>	463
	<i>VCAT RX - Diff Delay</i>	466
	<i>LCAS - Source</i>	468
	<i>LCAS Sink</i>	481

GFP Overview TX

Press **TEST**, **GFP**, and **Overview** (under **GFP TX**).

Statistics	Count	Rate	Unit
Client Data Frames	--	--	Frames
Client Management Frames	--	--	Frames
Idle Frames	--	--	Frames
Total Frames	--	--	Frames

Transport Layer
Bandwidth Usage (%)
Mapping Efficiency (%)

Superblock Statistic		
Total	Count	Rate
	--	--

Overview | Frame | Channel | OH

Statistics

Indicates the count and the rate of the transmitted **Client Data Frames**, **Client Management Frames**, **Idle Frames**, and **Total Frames**.

Transport Layer

- **Bandwidth Usage (%)**: Indicates the transmitted transport layer bandwidth in the last second, excluding the Idle bytes.
- **Mapping Efficiency (%)**: Indicates the transmitted transport layer mapping efficiency (Client Payload Bytes divided by Client Data Bytes multiplied by 100) in the last second.

Superblock Statistic

Only available when Gb Ethernet is mapped into ODU0 via GFP-T

Total: Indicates the total transmitted valid and invalid superblocks.

GFP Frame TX

Press **TEST**, **GFP**, and **Frame** (under **GFP TX**).

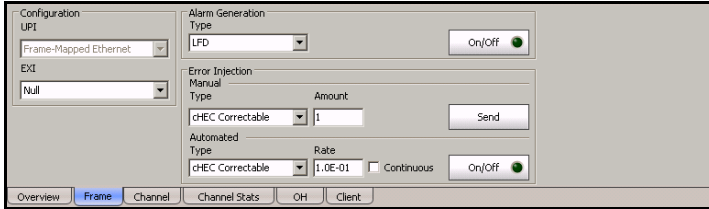

Configuration

- **UPI (User Payload Identifier):** Indicates the type of payload conveyed in the GFP Payload Information field. When not in through mode, the UPI is set to **Framed Ethernet (0000 0001)**, **Transparent GbE (0000 0110)** for Gb Ethernet, or **Framed 64B/66B Ethernet (0001 0011)** for ODU2 to 10G Ethernet test case. In through mode the following UPI choices are available from the test setup only.

UPI	Description for PTI = 000	Description for PTI = 100
0000 0001	Frame-Mapped Ethernet	Client Signal Fail (Loss of Client Signal)
0000 0010	Mapped PPP Frame	Client Signal Fail (Loss of Character Synchronization)

UPI	Description for PTI = 000	Description for PTI = 100
0000 0011	Transparent Fibre Channel	Reserved for future use
0000 0100	Transparent FICON	
0000 0101	Transparent ESCON	
0000 0110	Transparent GbE	
0000 1000	Frame-Mapped Multiple Access Protocol over SDH (MAPOS)	
0000 1001	Transparent DVB ASI	
0000 1010	Framed-Mapped IEEE 802.17 Resilient Packet Ring	
0000 1011	Frame-Mapped Fibre Channel FC-BBW	
0000 1100	Asynchronous Transparent Fibre Channel	
0000 1101	Framed MPLS Unicast	
0000 1110	Framed MPLS Multicast	
0000 1111	Framed IS-IS	
0001 0000	Framed IPv4	
0001 0001	Framed IPv6	
0001 0010	Framed DVD-ASI	
0001 0011	Framed 64B/66B Ethernet	
0001 0100	Framed 64B/66B Ethernet Ordered Set	

- **EXI** (Extension Header Identifier): Allows the selection of the type of GFP Extension Header. Choices are **Null** (0000) and **Linear** (0001). The default setting is **Null**. EXI is not configurable and set to **Null** for ODU2 to 10G Ethernet or Pattern via GFP-F, and Gb Ethernet in OPU0 via GFP-T test cases.

Alarm Generation

- **Type**
 - LFD (Loss of Frame Delineation):** Generates a sufficient number of cHEC uncorrectable errors to avoid synchronization.
- **On/Off button:** The On/Off button is used to activate/deactivate the selected alarm. This setting is disabled (Off) by default.

Error Injection

Allows manual or automated error injection.

- **Type:** The following errors are available with both manual and automated injection modes:
 - cHEC Correctable:** Generates a “Walking 1” pattern to hit all applicable bits covered by the cHEC and PLI.
 - cHEC Uncorrectable:** Generates a “Walking 11” pattern to hit all consecutive 2 bits applicable to the bits covered by the cHEC and PLI.
- **Amount:** Select the amount of manual errors to be generated. Choices are **1** through **50**. The default setting is **1**.
- **Send button:** Click on the Send button to manually generate errors according to the Error Type and the Amount of Errors selected.
- **Rate:** Click on the Rate field to select the injection rate for the automated error. Choices are from **9.9E-6** to **1.0E-1** for correctable cHEC and **9.9E-6** to **1.0E-2** for uncorrectable cHEC.
- **Continuous:** When activated, generates the selected error for each frame to its theoretical maximum. This setting is disabled by default.
- **On/Off button:** The On/Off button is used to activate/deactivate the selected automated error at the rate specified or continuously. This setting is disabled (Off) by default.

GFP Channel TX

Press **TEST**, **GFP**, and **Channel** (under **GFP TX**).

Configuration

- **Client Data Frames FCS** enables the presence of the payload FCS for the client frames. This setting is enabled by default. Not supported with GFP-F over OPU2 and GFP-T over OPU0.
- **Client Management Frames FCS** enables the presence of the payload FCS for the management frames. This setting is disabled by default.
- **CID** (Channel Identifier) selects the communication channel used for the signal transmission. Choices are from **00000000** through **11111111** (0 to 255). The default value is **0** when EXI is set to Linear. CID not available when EXI is set to **Null** (see *GFP Frame TX* on page 432).

Note: *The CID value is the same for both the Client Management and Data Frames. CID is not available with GFP over OPU2.*

Alarm Generation

Allows the generation of client management frames alarms.

Note: *The PTI value will be automatically set to 100 when generating a CMF alarm.*

➤ **Type**

LOCS (CSF-Loss of Client Signal): Generates a LOCS by setting the UPI field to “0000 0001”.

LOCCS (CSF-Loss of Client Character Synchronization): Generates a LOCCS by setting the UPI field to “0000 0010”.

User Defined CMF (Client Management Frame): Allows to set the User-defined UPI for the CMF value. Refer below for more information on User-defined UPI field.

FDI (Forward Defect Indication): Generates a client FDI by setting the UPI field to “0000 0100”. Not available with GFP-T.

RDI (Reverse Defect Indication): Generates a client RDI by setting the UPI field to “0000 0101”. Not available with GFP-T.

DCI (Defect Clear Indication): Generates a client DCI by setting the UPI field to “0000 0011”. Not available with GFP-T.

➤ **Period:** Allows to set the alarm period associated with the client management frames. Choices are from **10 ms** to **1200 ms**. The default setting is **100 ms**.

- **User-defined UPI:** Allows entering the Client Management Frame UPI value when **User Defined CMF** is selected.

UPI	Description for PTI = 100
0000 0000 1111 1111	Reserved
0000 0001	Client Signal Fail (Loss of Client Signal)
0000 0010	Client Signal Fail (Loss of Client Character Synchronization)
0000 0011 through 1111 1110	Reserved for future use

- **On/Off button:** The On/Off button is used to activate/deactivate the selected alarm. This setting is disabled (Off) by default.

Error Injection

- **Type:** The following errors are available with both manual and automated injection modes. The default setting is **tHEC correctable**.

tHEC Correctable: Generates a “Walking 1” pattern to hit all applicable bits covered by the tHEC, PTI, PFI, EXI and UPI

tHEC Uncorrectable: Generates a “Walking 11” pattern to hit all consecutive 2 bits applicable to the bits covered by the tHEC, PTI, PFI, EXI and UPI.

eHEC Correctable: Generates a “Walking 1” pattern to hit all applicable bits covered by the eHEC, CID and Spare. Only available with Linear frames (EXI is set to Linear).

eHEC Uncorrectable: Generates a “Walking 11” pattern to hit all consecutive 2 bits applicable to the bits covered by the eHEC, CID and Spare. Only available with Linear frames (EXI is set to Linear).

pFCS: Generates a “Walking 1” pattern to hit all 32 bits of the pFCS only. Only available when **Client Data Frames FCS** is enabled.

Next-Generation Tabs

GFP Channel TX

Note: *eHEC Correctable and Uncorrectable are only available when EXI from the GFP Frame TX on page 432 is set to Linear.*

Note: *The following error type are only available with GFP-T.*

SB Correctable (Pre): Generates a “Walking 1” pattern to include a single bit error in the CRC-16 word of the superblock.

SB Correctable (Post): Generates in the payload of the superblock, a “Walking 1” pattern to include two separate errors in one superblock separated by 43 bits.

SB Uncorrectable: Generates a “Walking 11” pattern to include two consecutive errors in the CRC-16 word of the superblock.

10B_ERR: Generates a 10B_ERR code over the payload of the superblock as defined in ITU G.7041.

- **Amount:** Select the amount of manual error to be generated. Choices are **1** through **50**. The default setting is **1**.
- **Rate:** Click on the Rate field to select the injection rate for the automated error. Choices are from **9.9E-6** to **1.0E-1**.
- **Continuous:** When activated, generates the selected error for each frame to its theoretical maximum. This setting is disabled by default.
- **On/Off buttons:**

For Manual Error: The On/Off button is used to activate/deactivate the selected manual error for the amount specified. The On/Off button is automatically deactivated once the amount of error has been injected.

For Automated Error: The On/Off button is used to activate/deactivate the selected automated error at the rate specified or continuously when continuous is enabled.

This setting is disabled (Off) by default.

Note: *Error injection is not possible when there is no traffic transmitted.*

GFP Channel Stats TX

Note: This tab is only available for Pattern or External Ethernet in GFP-F over SONET/SDH, and Ethernet in GFP-F over ODUflex test cases.

Press **TEST**, **GFP**, and **Channel Stats** (under **GFP TX**).

Statistics			
	Count	Rate	Unit
Client Data Frames	--	--	<input type="text"/>
Client Management Frames	--	--	<input type="text"/>

Overview | Frame | Channel | **Channel Stats** | OH | Client

Statistics

Indicates the count and rate of the transmitted **Client Data Frames** and **Client Management Frames**. These statistics are calculated before the overwrite function.

Units are **Frames**, **Bytes**, and **Payload Bytes**. The default setting is **Frames**.

GFP OH TX

Press **TEST**, **GFP**, and **OH** (under **GFP TX**).

Frame Type					
Client data frame					
Overwrite					
Type Header					
PTI	PFI	EXI	LPI	Extension Header	
000	1	0000	00000001	CID	Spare
Default					

Overview | Frame | Channel | Channel Stats | **OH** | Client

Frame Type

Allows the selection of the frame type. Choices are **Client data frame** and **Client management frame**. For 10G Ethernet over GFP over OPU2, two types of **Client data frames** are available: **Framed 64B/66B Ethernet** and **Framed 64B/66B Ethernet Ordered Set**.

Overwrite

Allows overwriting fields in the GFP frame type selected (Frame Type Selection). Only the value of the overhead field is overwritten, the frame structure is not changed.

➤ **Type Header**

- **PTI (Payload Type Identifier):** Allows overwriting the Payload Type Identifier for the selected frame type.

PTI	Description
000	Client Data Frame
100	Client Management Frame
001, 010, 011, 101, 110, and 111	Reserved

- **PFI (Payload Frame Check Sequence Identifier):** Allows overwriting the Payload FCS Indicator.

PFI	Description
0	FCS Absent
1	FCS Present

- **EXI (Extension Header Identifier):** Allows overwriting the Extension Header Identifier.

EXI	Description
0000	Null Extension Header
0001	Linear Frame
0010	Ring Frame
From 0011 to 1111	Reserved

Next-Generation Tabs

GFP OH TX

- **UPI (User Payload Identifier):** Allows overwriting the User Payload Identifier.

UPI	Description for PTI = 000	Description for PTI = 100
0000 0000 1111 1111	Reserved and not available	Reserved
0000 0001	Frame-Mapped Ethernet	Client Signal Fail (Loss of Client Signal)
0000 0010	Mapped PPP Frame	Client Signal Fail (Loss of Character Synchronization)
0000 0011	Transparent Fibre Channel	Reserved for future use
0000 0100	Transparent FICON	
0000 0101	Transparent ESCON	
0000 0110	Transparent GbE	
0000 0111	Reserved for future use	
0000 1000	Frame-Mapped Multiple Access Protocol over SDH (MAPOS)	
0000 1001	Transparent DVB ASI	
0000 1010	Framed-Mapped IEEE 802.17 Resilient Packet Ring	
0000 1011	Frame-Mapped Fibre Channel FC-BBW	
0000 1100	Asynchronous Transparent Fibre Channel	
0000 1101	Framed MPLS Unicast	
0000 1110	Framed MPLS Multicast	
0000 1111	Framed IS-IS	
0001 0000	Framed IPv4	
0001 0001	Framed IPv6	

UPI	Description for PTI = 000	Description for PTI = 100
0001 0010	Framed DVD-ASI	Reserved for future use
0001 0011	Framed 64B/66B Ethernet	
0001 0100	Framed 64B/66B Ethernet Ordered Set	
0001 0101 through 1110 1111	Reserved for future standardization	
1111 0000 through 1111 1110	Reserved for proprietary use	

➤ Extension Header

Note: *CID and Spare are only available when EXI from GFP Frame TX on page 432 is set to Linear.*

- **CID** (Channel Identifier) allows to overwrite the communication channel used for the signal transmission set from *GFP Channel TX* on page 435. Choices are from **00000000** through **11111111** (0 to 255). The default setting is **00000000**.
- **Spare** allows to set the extension header Spare field. Choices are from **00000000** through **11111111** (0 to 255).

Default Button

Click on **Default** to return to default configuration defined in the test case for the selected GFP frame type (Frame Type Selection). The Default button is only available when at least one overwrite is active.

Next-Generation Tabs

GFP Client TX

GFP Client TX

Note: *Not supported with 10G Ethernet in GFP over ODU2, Gb Ethernet in GFP over ODU0, and Ethernet in GFP over ODUflex.*

Press **TEST**, **GFP**, and **Client** (under **GFP TX**).

The following tab is available when using internal pattern generator.

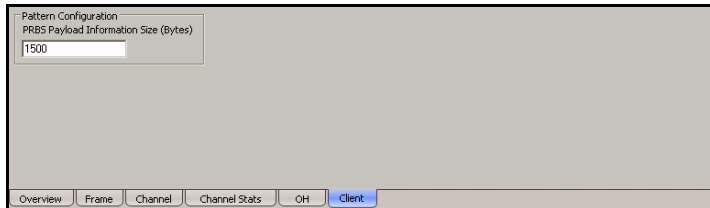

The screenshot shows the 'Pattern Configuration' tab. It features a text input field for 'PRBS Payload Information Size (Bytes)' with the value '1500' entered. Below the input field is a navigation bar with tabs: 'Overview', 'Frame', 'Channel', 'Channel Stats', 'OH', and 'Client'. The 'Client' tab is currently selected and highlighted in blue.

The following tab is available when using External Ethernet.

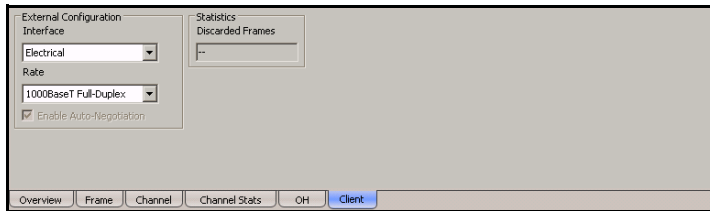

The screenshot shows the 'External Configuration' tab. It is divided into two sections: 'External Configuration' and 'Statistics'. The 'External Configuration' section includes a dropdown menu for 'Interface' set to 'Electrical', a dropdown for 'Rate' set to '1000BaseT Full-Duplex', and a checked checkbox for 'Enable Auto-Negotiation'. The 'Statistics' section has a 'Discarded Frames' field with a '-' sign. A navigation bar at the bottom contains tabs: 'Overview', 'Frame', 'Channel', 'Channel Stats', 'OH', and 'Client'. The 'Client' tab is selected and highlighted in blue.

Note: *Idle frames will be inserted to match the transport layer rate when packets are smaller or equal to 40 bytes, or to adjust the rate when required.*

Pattern Configuration

Note: *Pattern Configuration is only available when Pattern has been selected during test setup.*

Note: *The internal PRBS Generator does not support a full Ethernet frame (no Source Address and Destination Address are configurable) but it allows the creation of a basic frame of configurable size with a fixed pattern that offers the capability to fill the maximum payload value supported by a GFP frame.*

PRBS Payload Information Size (Bytes): Allows the selection of the size of the data structure (payload information size) that carries the PRBS.

Choices	For
1 through 65523 bytes	Linear Extension with pFCS
1 through 65527 bytes	Linear Extension without pFCS, or Null Extension with pFCS
1 through 65531 bytes	Null Extension without pFCS

The default setting is **1500 bytes**.

Note: *The PRBS $2^{31}-1$ pattern will be used. Refer to Pattern TX on page 405 for more information.*

External Configuration

Note: *External Configuration is only available when External Ethernet has been selected during test setup.*

Note: *External Configuration parameters for both GFP Client TX and RX tabs are coupled.*

- **Interface** allows the Ethernet interface type selection. Choices are **Electrical** and **Optical**. The default setting is **Electrical** unless otherwise set during the test setup.

Note: *Selecting the optical interface automatically turn the interface laser On. To turn it off, select the electrical interface.*

- **Rate** allows the interface rate selection. Choices are **1000BaseT Full Duplex**, **100BaseT Full Duplex**, and **10BaseT Full Duplex** for electrical interface and, **1000BaseX Full-Duplex** for optical interface. The default setting is **1000BaseT Full Duplex** for electrical interface and **1000BaseX Full Duplex** for optical interface.
- **Enable Auto-Negotiation:** Allows the auto-negotiation of the port speed when the rate is set to 100BaseT or 10BaseT. Auto-negotiation is always enabled for 1000BaseT.

Statistics

Note: *Statistics is only available when External Ethernet has been selected during test setup.*

- **Discarded Frames** indicates the number of frames that have been discarded for one of the following reasons:
 - when there is an overflow of the Adapter Function buffer.
 - when generating a LOCS alarm or a user defined CMF.

GFP Overview RX

Press **TEST**, **GFP**, and **Overview** (under **GFP RX**).

The screenshot displays the GFP Overview RX interface. It features several sections:

- Frame Statistics:** A table with columns for Count, Rate, and Unit. Rows include Client Data Frames, Client Management Frames, Idle Frames, Reserved PLI Frames (with a dropdown menu), Invalid Frames, Discarded Frames, and Total Frames.
- Alarm Analysis:** Radio buttons for H, C, Frame, and Channel.
- Transport Layer:** Fields for Bandwidth Usage (%) and Mapping Efficiency (%).
- Superblock Statistics:** A table with columns for Count and Rate. Rows include Valid, Invalid, and Total.

At the bottom, there are tabs for Overview, Frame, Channel, and OH.

Statistics

- **Client Data Frames:** Indicates the received Client Data Frames without uncorrectable cHEC, tHEC, and eHEC errors.
- **Client Management Frames:** Indicates the received Client Management Frames without uncorrectable cHEC, tHEC, and eHEC, and pFCS errors.
- **Idle Frames:** Indicates the received Idle frames.
- **Reserved PLI Frames or Reserved PTI Frames**
 - **Reserved PLI Frames:** Indicates the number of reserved control frames (PLI=1, 2, or 3 while in Synchronization state) received.
 - **Reserved PTI Frames:** Indicates the received client data and management frames with a Payload Type Identifier different of 000 and 100 without uncorrectable cHEC, tHEC, and eHEC, and pFCS errors. For PRBS in SONET/SDH via GFP-F, External Ethernet in SONET/SDH via GFP-F, and Ethernet in ODUflex via GFP-F test cases, **Reserved PTI Frames** is available on *GFP Channel Stats RX* on page 454.
- **Invalid Frames:** Indicates the number of frames corresponding at least to one of the following conditions:
 - EXI=0000 while PFI=1 and PLI < 8

Next-Generation Tabs

GFP Overview RX

- EXI=0001 while PFI=0 and PLI <8
- EXI=0001 while PFI=1 and PLI<12
- **Discarded Frames:** Indicates the number of frames with uncorrectable tHEC, eHEC errors, or Invalid Frames.
- **Total Frames:** Indicates the received frames including Idle, Client Data, Client Management, and frames with a reserved PTI.

Alarm Analysis

Indicates **Frame**, **Channel**, or **Client** alarms.

Transport Layer

- **Bandwidth Usage (%):** Indicates the received transport layer bandwidth in the last second, excluding the Idle bytes.
- **Mapping Efficiency (%):** Indicates the received transport layer mapping efficiency (Client Payload Bytes divided by Client Data Bytes multiplied by 100) in the last second.

Superblock Statistic

Only available with ODU0 to Gb Ethernet over GFP.

- **Valid:** Indicates the received superblocks without any uncorrectable error.
- **Invalid:** Indicates the received superblocks with uncorrectable error.
- **Total:** Indicates the total received valid and invalid superblocks.

GFP Frames RX

Press **TEST**, **GFP**, and **Frames** (under **GFP RX**).

Configuration		Mismatch		Alarm Analysis	
UPI	Frame-Mapped Ethernet	EXI	Count	H	C
EXI	Null	UPI	Count	<input checked="" type="radio"/>	LFD
Delta	1			Seconds	
				Count	
				Rate	
				Error Analysis	
				H	C
				<input checked="" type="radio"/>	cHEC Correctable
				<input checked="" type="radio"/>	cHEC Uncorrectable

Configuration

- **UPI** (User Payload Identifier): Indicates the type of payload conveyed in the GFP Payload Information field. UPI is only selectable from the test setup. See *Configuration* on page 432 for more information.

Note: For 10G Ethernet in GFP over OPU2, when through mode is not selected, both Framed 64B/66B Ethernet and Framed 64B/66B Ethernet Ordered Set payload types are used as the expected UPI.

- **EXI** (Extension Header Identifier): Allows the selection of the type of GFP Extension Header. Choices are **Null** (0000) and **Linear** (0001). The default setting is **Null**. EXI is not configurable and set to Null for ODU2 to 10G Ethernet or Pattern over GFP, and ODU0 to Gb Ethernet over GFP test cases.
- **Delta**: Indicates the GFP state machine synchronization parameter. Delta is set to 1.

Next-Generation Tabs

GFP Frames RX

Mismatch

- **EXI (Extension Header Identifier):** Indicates the number of frames with EXI field not matching the expected EXI.
- **UPI (User Payload Identifier):** Indicates the number of frames UPI field not matching the expected UPI.

Alarm Analysis

LFD (Loss of Frame Delineation): Indicates that GFP engine is out of synchronization.

Note: *Refer to Alarm/Error Measurements on page 47 for H/C LEDs and Seconds information.*

Error Analysis

- **cHEC Correctable:** Indicates that only one bit error has been detected on Core header (PLI and cHEC).
- **cHEC Uncorrectable:** Indicates that two or more bit errors have been detected on Core header (cHEC and PLI).

Note: *Refer to Alarm/Error Measurements on page 47 for H/C LEDs, Seconds, Count, and Rate information.*

GFP Channel RX

Press **TEST**, **GFP**, and **Channel** (under **GFP RX**).

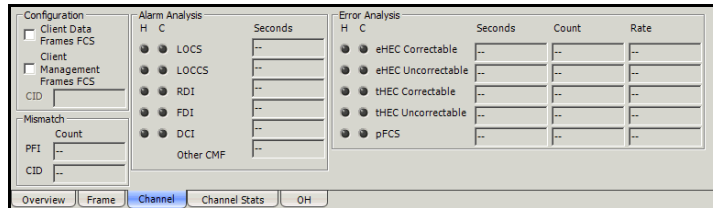

Configuration

- **Client Data Frames FCS** enables detecting the presence of the expected payload FCS for the client frames. This setting is enabled by default. Not supported with GFP-F over OPU2 and GFP-T over OPU0.
- **Client Management Frames FCS** enables detecting the presence of the expected payload FCS for the management frames. This setting is disabled by default.
- **CID** (Channel Identifier) selects the communication channel used for the signal reception. Choices are from **00000000** through **11111111** (0 to 255). Only available when EXI is set to **Linear**.

Note: *The CID value is the same for both the Client Management and Data Frames. CID is not available with GFP over OPU2.*

Mismatch

- **PFI** (Payload FCS Identifier): Indicates the number of frames with PFI field not matching the expected PFI.
- **CID** (Channel Identifier): Indicates the number of frames CID field not matching the expected CID. Only available when EXI is set to **Linear**.

Alarm Analysis

- **LOCS** (CSF-Loss of Client Signal): A LOCS alarm is declared when CMF frame is received while UPI is set to “0000 0001”.
- **LOCCS** (CSF-Loss of Client Character Synchronization): The LOCCS alarm is declared when CMP frame is received with an UPI set to “0000 0010”.
- **FDI** (Forward Defect Indication): The FDI alarm is declared when CMF frame is received with an UPI set to “0000 0100”. Not available with GFP-T.
- **RDI** (Reverse Defect Indication): The RDI alarm is declared when CMF frame is received with an UPI set to “0000 0101”. Not available with GFP-T.
- **DCI** (Defect Clear Indication): The DCI alarm is declared when CMF frame is received with an UPI set to “0000 0011”. Not available with GFP-T.
- **Other CMF** (Client Management Frame): Other CMF alarms other than the ones described above.

Error Analysis

- **eHEC Correctable:** Indicates that only one bit error has been detected in the Extension header (eHEC, CID and Spare). Only available with Linear frames (EXI is set to Linear).
- **eHEC Uncorrectable:** Indicates that two or more bit errors have been detected in the Extension header (eHEC, CID and Spare). Only available with Linear frames (EXI is set to Linear).
- **tHEC Correctable:** Indicates that only one bit error has been detected in the Type header (tHEC, PTI, PFI, EXI and UPI).
- **tHEC Uncorrectable:** Indicates that two or more bit error have been detected in the Type header (tHEC, PTI, PFI, EXI and UPI).
- **pFCS:** Indicates that at least one bit error has been detected in the payload.
- **SB Correctable:** Indicates that bit error has been detected in the CRC-16 word of the superblock. A received **SB Correctable (Pre)** error counts as one error while **SB Correctable (Post)** counts as two errors.
- **SB Uncorrectable:** Indicates that two or more bit errors have been detected in the CRC-16 word of the superblock. Note that if two errors are spaced by exactly 43 bits, they will not be reported as uncorrectable.
- **10B_ERR:** Indicates that a 10B_ERR code has been detected in the payload of the superblock.

GFP Channel Stats RX

Note: This tab is only available for PRBS in SONET/SDH via GFP-F, External Ethernet in SONET/SDH via GFP-F, and Ethernet in ODUflex via GFP-F test cases.

Press **TEST**, **GFP**, and **Channel Stats** (under **GFP RX**).

Statistics	Count	Rate	Unit
Client Data Frames	--	--	[Unit]
Client Management Frames	--	--	[Unit]
Reserved PTI Frames	--	--	[Unit]

Overview | Frame | Channel | **Channel Stats** | OH

Statistics

- **Client Data Frames:** Indicates the count and rate of received Client Data Frames.
- **Client Management Frames:** Indicates the count and rate of received Client Management Frames.
- **Reserved PTI Frames:** Indicates the count and rate of frame having a reserved Payload Type Identifier (PTI is different of **000** and **100**).

Units are **Frames**, **Bytes**, and **Payload Bytes**. The default setting is **Frames**.

GFP OH RX

Press **TEST**, **GFP**, and **OH** (under **GFP RX**).

	Core Header		Type Header				Extension Header			
	PLI	cHEC	PTI	PFI	EXI	UPT	tHEC	CID	Spare	eHEC
Client Data Frames	--	--	--	--	--	--	--	--	--	--
Client Management Frames	--	--	--	--	--	--	--	--	--	--
Reserved PTI Frames	--	--	--	--	--	--	--	--	--	--

Overview Frame Channel Channel Stats **OH**

Note: The following Core, Type and Extension Header values are available for Client Data Frames, Client Management Frames and Reserved PTI Frames.

Core Header

- **PLI** (Payload Length Indicator): Indicates the number of octets in the GFP payload area.
- **cHEC** (Core Header Error Control): Indicates the CRC-16 error control code that protects the integrity of the contents of the core header by enabling both single-bit error correction and Multi-bit error detection.

Type Header

Note: See GFP OH TX on page 440 for **PTI**, **PFI**, **EXI**, and **UPI** possible values.

- **PTI** (Payload Type Identifier): Displays the type of GFP client frame.
- **PFI** (Payload Frame Check Sequence Indicator): Displays the Payload FCS Indicator.
- **EXI** (Extension Header Identifier): Displays the Extension Header Identifier.
- **UPI** (User Payload Identifier): Displays the User Payload Identifier.
- **tHEC** (Type Header Error Control): Indicates the CRC-16 error control code that protects the integrity of the contents of the type field by enabling both single-bit error correction and multi-bit error detection.

Extension Header

Note: *CID*, *Spare*, and *eHEC* are only available when *EXI* from GFP Frame TX on page 432 is set to *Linear*.

- **CID** (Channel Identifier): Displays the communication channel used by the signal. Possible values are **00000000** through **11111111** (0 to 255).
- **Spare**: Displays the extension header Spare field. Possible values are **00000000** through **11111111** (0 to 255).
- **eHEC** (Type Header Error Control): Indicates the CRC-16 error control code that protects the integrity of the contents of the extension header by enabling both single-bit error correction (optional) and multi-bit error detection.

GFP Client RX

Note: This tab is only available when using External Ethernet.

Press **TEST**, **GFP**, and **Client** (under **GFP RX**).

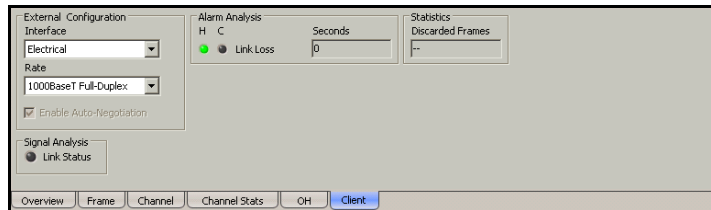

External Configuration

Note: External Configuration parameters for both GFP Client TX and RX tabs are coupled.

- **Interface** allows the Ethernet interface type selection. Choices are **Electrical** and **Optical**. The default setting is **Electrical** unless otherwise set during the test setup.

Note: Selecting the optical interface automatically turn the interface laser On. To turn it off, select the electrical interface.

- **Rate** allows the interface rate selection. Choices are **1000BaseT Full Duplex**, **100BaseT Full Duplex**, and **10BaseT Full Duplex** for electrical interface and, **1000BaseX Full-Duplex** for optical interface. The default setting is **1000BaseT Full Duplex** for electrical interface and **1000BaseX Full Duplex** for optical interface.
- **Enable Auto-Negotiation:** Allows the auto-negotiation of the port speed when the rate is set to 100BaseT or 10BaseT. Auto-negotiation is always enabled for 1000BaseT.

Signal Analysis

Link Status indicates that the Ethernet connection is down. The link status is available regardless if the test is running or not.

Alarm Analysis

Link Loss indicates a loss of connectivity with the externally connected Ethernet interface (Packet Blazer). This alarm is only available when the test is running.

Note: *Refer to Alarm/Error Measurements on page 47 for H/C LEDs and Seconds information.*

Statistics

Discarded Frames indicates the number of frames that have been discarded when there is an overflow of the Adapter Function buffer.

VCAT TX - Overview

Press **TEST**, **VCAT**, and **Overview** (under **VCAT TX**).

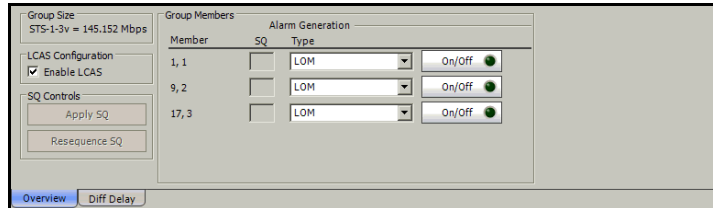

Group Size

Group Size indicates the type and size of the VCG members as well as the bandwidth used by the VCG group. For example **STS-1-21v = 145.152 Mbps** indicates **STS-1** as the VCG type, **21v** for the size, and **145.152 Mbps** for the bandwidth of the VCG group.

LCAS Configuration

Enable LCAS allows enabling LCAS configuration. See *LCAS - Source* on page 468 and *LCAS Sink* on page 481 for more information.

Note: *Enable LCAS from TX and RX tabs are coupled.*

SQ Controls

- **Apply SQ** button: Validates and applies the SQ number for each member. Available only when at least one SQ number has been changed. Not available when **Enable LCAS** is enabled.
- **Resequence SQ** button: Assigns SQ number sequentially following the timeslot order. SQ number starts at 0. Not available when **Enable LCAS** is enabled.

Group Members

- **Member** indicates the timeslot number.
- **SQ** (Sequence Indicator): Indicates the member's selection order from the test setup. The first member bears the sequence indicator "0" by default. The SQ number of each member can be changed when **Enable LCAS** is disabled. Click on a specific member SQ number and enter the new number. Possible values are from **0** to **63**.

Note: *The SQ number(s) changed will only take effect when the Apply SQ button is pressed.*

➤ Alarm Generation

➤ Type for HOP

LOM (Loss of Multiframe): Generates and maintains a corrupted OOM1 alignment process.

OOM1 (Out-Of-Multiframe of stage 1): Generates a continuous error in the MFI1 sequence.

OOM2 (Out-Of-Multiframe of stage 2): Generates a continuous error in the MFI2 sequence.

➤ Type for LOP

LOM (Loss of Multiframe): Generates and maintains a corrupted OOM1 alignment process.

OOM1 (Out-Of-Multiframe of stage 1): Generates an error in the Z7/K4 bit (MFAS).

OOM2 (Out-Of-Multiframe of stage 2): Generates an error in Z7/K4 bit 2 Frame Count.

- **On/Off** button: Click on the On/Off button to enable/disable the alarm generation.

- **Arrows:** Single arrows move one position up or down in the list. Double arrows move one page up or down in the list.

VCAT TX - Diff Delay

Press **TEST**, **VCAT**, and **Diff Delay** (under **VCAT TX**).

Member	SQ	Absolute Delay	Differential Delay	Enable Delay
1, 1	0	0		0 <input type="checkbox"/>
5, 1	1	0		0 <input type="checkbox"/>

Delay Control: On/Off Reset All
Enable All Disable All

Reference Member: 1, 1 Auto

Measurement Unit: μ s

Overview Diff Delay

Group Members

- **Member** indicates the timeslot number.
- **SQ** (Sequence Indicator): Indicates the member sequence indicator.
- **Absolute Delay**: Enter the absolute delay for each required member. Choices are from **0** to **256000 μ s** configurable in steps of **125 μ s** for HOP and **500 μ s** for LOP except for TU-3 which is configurable in steps of **125 μ s**, meaning that the value will be rounded to the closest multiple of 125 (HOP) or 500 (LOP).
- **Differential Delay**: Indicates the differential delay value for each member according to the absolute delay values entered for members. The graphical representation shows the differential positive and negative delays for each member. A delay value bar at the left side of the vertical line represents a negative delay while the one on the right side represents a positive delay. A member having a negative delay compare to another one having a positive delay indicates that this member is faster than the other one. The differential delay is calculated from the reference member.
- **Enable Delay**: Allows enabling the absolute delay for each member.
- **Arrows**: Single arrows move one position up or down in the list. Double arrows move one page up or down in the list.

Next-Generation Tabs

VCAT TX - Diff Delay

Delay Control

- **On/Off** button: The On/Off button is used to activate/deactivate the delay control insertion for all VCG members. This setting is disabled (Off) by default.
- **Reset All**: Resets all members' absolute delay to 0.
- **Enable All**: Allows enabling the absolute delay for all members.
- **Disable All**: Allows disabling the absolute delay for all members.

Reference Member

Allows the selection of the reference member from the list or automatically when **Auto** is enabled.

Auto: Performs automatic selection of the fastest member having the smallest differential delay. The member having the smallest SQ will be selected when more than one member have the smaller differential delay.

The default setting is **Auto** enabled.

Measurement Unit

Allows the selection of unit for both the differential delay threshold. Choices are **ms** and **μs**. The default setting is **μs**.

VCAT RX - Overview

Press **TEST**, **VCAT** and **Overview** (under **VCAT RX**).

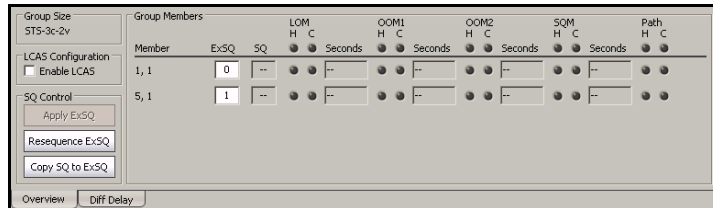

Group Size

Group Size indicates the type and size of the VCG members as well as the bandwidth used by the VCG group. For example **ST5-1-21v = 145.152 Mbps** indicates **ST5-1** as the VCG type, **21v** for the size, and **145.152 Mbps** for the bandwidth of the VCG group.

LCAS Configuration

Allows enabling LCAS configuration. See *LCAS - Source* on page 468 and *LCAS Sink* on page 481 for more information.

Note: *Enable LCAS from TX and RX tabs are coupled.*

SQ Controls

- **Apply ExSQ** button: Validates and applies the ExSQ number for each member. Available only when at least one SQ number has been changed. Not available when **Enable LCAS** is enabled.
- **Resequence ExSQ** button: Assigns SQ number sequentially following the timeslot order. Not available when **Enable LCAS** is enabled.
- **Copy SQ to ExSQ** button: Replaces the ExSQ with the SQ number. Not available when **Enable LCAS** is enabled.

Group Members

- **Member** indicates the timeslot number.
- **ExSQ** (Expected Sequence Indicator): Indicates the member's selection order from the test setup. The first member selected bears the sequence indicator "0". The ExSQ number of each member can be changed when **Enable LCAS** is disabled. Click on a specific member ExSQ number and enter the new number. Possible values are from **0** to **63**.

Note: *The ExSQ number(s) changed will only take effect when the Apply ExSQ button is pressed.*

- **SQ** (Sequence Indicator): Indicates the received member sequence indicator.
- **Alarm Analysis for HOP**
 - **LOM** (Loss Of Multiframe): A LOM is declared when a OOM1 or OOM2 is present while the whole H4 is not recovered within 48 STS-1/STS-3c or VC-3/VC-4 frames. The LOM state is cleared when both multiframe alignment processes are in the in-multiframe state IM1 (Stage 1) and IM2 (Stage 2).
 - **OOM1** (Out-Of-Multiframe of stage 1): A OOM1 is declared when an error is detected in the MF11 sequence. The OOM1 state is cleared when error-free MF11 sequences are found in four consecutive STS-1/STS-3c or VC-3/VC-4 frames, then a IM1 state is declared.
 - **OOM2** (Out-Of-Multiframe of stage 2): A OOM2 is declared when an error is detected in the MF12 sequence or the first multiframe stage is in the OOM1 state. The OOM2 state is cleared when IM1 state is declared while error-free MF12 sequences are found in two consecutive first-stage multiframe, then a IM2 state is declared.

- **SQM** (Sequence Indicator Mismatch): A SQM is declared when the accepted sequence indicator (SQ) does not match the expected sequence indicator (ExSQ). The SQM state is cleared when SQ matches ExSQ.
- **Path**: A Path alarm is declared when there is at least one near-end path type alarm or a B3 error.
- **Alarm Analysis for LOP**
 - **LOM** (Loss Of Multiframe): A LOM is declared when the two multiframe alignment processes is in the out-of-multiframe (OOM1 or OOM2) state and the whole Z7/K4 (bits 1 and 2) two-stage multiframe is not recovered within 256 VT1.5/VT2 or VC-11/12 frames.
 - **OOM1** (Out-Of-Multiframe of stage 1): A OOM1 is declared when two consecutive Frame Alignment Signals (FAS) are detected in error (i.e. one error in each FAS). The OOM1 state is cleared when one non-errored FAS is found.
 - **OOM2** (Out-Of-Multiframe of stage 2): An OOM2 is declared when either the frame alignment process is in out-of-multiframe (OOM1) state or when an error is encountered in the received and expected frame count from bits 1-5 of the Z7/K4 bit 2 sequence. The OOM2 state is cleared when the extended overhead multiframe process is in the IM state and two consecutive error-free frames are recovered.
 - **SQM** (Sequence Indicator Mismatch): A SQM is declared when the accepted sequence indicator (SQ) does not match the expected sequence indicator (ExSQ). The SQM state is cleared when SQ matches ExSQ.
 - **Path**: A Path alarm is declared when there is at least one near-end path type alarm, or a B3 error for TU-3 or BIP-2 for TU-11/TU-12.
- **Arrows**: Single arrows move one position up or down in the list. Double arrows move one page up or down in the list.

VCAT RX - Diff Delay

Press **TEST**, **VCAT** and **Diff Delay** (under **VCAT RX**).

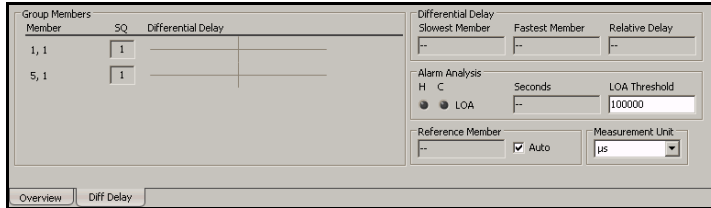

Group Members

- **Member** indicates the timeslot number.
- **SQ (Sequence Indicator)**: Indicates the received member sequence indicator.
- **Differential Delay**: Indicates the differential delay value for each member. The graphical representation shows the differential positive and negative delays for each member. A delay value bar at the left side of the vertical line represents a negative delay while the one on the right side represents a positive delay. A member having a negative delay compare to another one having a positive delay indicates that this member is faster than the other one. The differential delay is measured compared to the reference member.

Note: *The differential delay measurement accuracy is $\pm 125 \mu\text{s}$ for HOP and $\pm 500 \mu\text{s}$ for LOP except for TU-3, which has an accuracy of $\pm 125 \mu\text{s}$.*

- **Arrows**

Single arrows move one position up or down in the list.
Double arrows move one page up or down in the list.

Differential Delay

- **Slowest Member:** Indicates the member having the largest differential delay. The member having the largest SQ will be selected when more than one member has the largest differential delay.
- **Fastest Member:** Indicates the member having the smallest differential delay. The member having the smallest SQ will be selected when more than one member has the smallest differential delay.
- **Relative Delay:** Indicates the differential delay that exists between the slowest and fastest members.

Alarm Analysis

- **LOA (Loss Of Alignment):** The LOA alarm is declared when the alignment process cannot perform the alignment of the individual member within the defined threshold.
- **LOA Threshold (Loss Of Alignment Threshold):** Allows to specify the value at which an LOA alarm will be declared.

Choices are from **125** to **255375 μ s** for HOP and to **254000 μ s** for LOP except for TU-3. The default setting is **100000 μ s**.

Reference Member

Allows the selection of the reference member from the list or automatically when **Auto** is enabled.

Auto: Performs automatic selection of the fastest member having the smallest differential delay. The member having the smallest SQ will be selected when more than one member has the smaller differential delay.

The default setting is **Auto** enabled.

Measurement Unit

Allows the selection of unit for both the differential delay and LOA Threshold. Choices are **ms** and **μ s**. The default setting is **μ s**.

LCAS - Source

Note: The test must be started and Enable LCAS has to be enabled from either VCAT TX - Overview on page 459 or VCAT RX - Overview on page 463 in order to access the LCAS Source functionality. Alternatively, LCAS functionality can be enabled via the test setup, as the test case is being mounted.

Press **TEST** and **LCAS**.

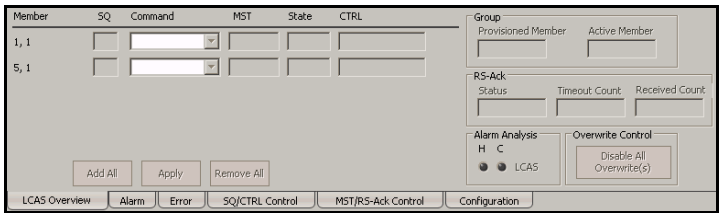

The LCAS Source tab gives access to the following tabs:

- *LCAS Source - LCAS Overview* on page 469
- *LCAS Source - Alarm* on page 471
- *LCAS Source - Error* on page 473
- *LCAS Source - SQ/CTRL Control* on page 475
- *LCAS Source - MST/RS-Ack Control* on page 477
- *LCAS Source - Configuration* on page 479

Note: The default selected tab is **LCAS Overview**.

➤ **Arrows**

Single arrows move one position up or down in the list.

Double arrows move one page up or down in the list.

LCAS Source - LCAS Overview

Press **TEST**, **LCAS** and **LCAS Overview** (under **LCAS Source**).

The screenshot displays the LCAS Overview interface. It features a table with columns for Member, SQ, Command, MST, State, and CTRL. Below the table are buttons for 'Add All', 'Apply', and 'Remove All'. To the right, there are several control panels: 'Group' with 'Provisioned Member' and 'Active Member' fields; 'RS-Ack' with 'Status', 'Timeout Count', and 'Received Count' fields; 'Alarm Analysis' with 'H' and 'C' radio buttons; and 'Overwrite Control' with a 'Disable All Overwrite(s)' button. At the bottom, there is a navigation bar with tabs for 'LCAS Overview', 'Alarm', 'Error', 'SQ/CTRL Control', 'MST/RS-Ack Control', and 'Configuration'.

- **Member** indicates the timeslot number.
- **SQ** (Sequence Indicator): Indicates the member sequence indicator. The SQ for members in IDLE state will be automatically set to 63 for LOP or 255 for HOP.
- **Command**: Allows the selection of the command to be applied to the member. Choices are **None**, **Add**, and **Remove**. The default setting is **None**. The selected command(s) will only take effect once the **Apply** button is pressed.
- **Add All**: Click on the **Add All** button to set the **Add** command for all members. The command(s) will be sent only when **Apply** is pressed.
- **Apply**: Applies the selected command(s). The Apply button is not available while all commands are set to none.
- **Remove All**: Click on the **Remove All** button to set the **Remove** command for all members. The command(s) will be sent only when **Apply** is pressed.
- **MST** (Member Status): Indicates the member status. Possible statuses are **OK** (0) and **Fail** (1).
- **State**: Indicates the status of the source state machine. Possible states are **NORM**, **ADD**, **REMOVE**, **DNU**, and **IDLE**.
- **CTRL** (Control): Indicates the CTRL transmitted by the LCAS state machine. See *CTRL* on page 476 for the list of possible CTRL.

Next-Generation Tabs

LCAS - Source

Group

- **Provisioned Member:** Indicates the members that can be used for payload transmission. For example VT1.5v-4v, 4v indicates that 4 members are available for payload transmission.
- **Active Member:** Indicates the members that are used for payload transmission (not in error). For example VT1.5v-3v indicates that 3 members are used for payload transmission.

RS-Ack (Re-Sequence Acknowledge)

- **Status:** Indicates the status of the re-sequence acknowledge. Possible statuses are **Received** and **Pending**.
- **Timeout Count:** Indicates the RS-Ack timeout count.

Alarm Analysis

LCAS: The LCAS alarm is declared when any related LCAS alarm or error is active.

Overwrite Control

Disable All Overwrite(s): Allows disabling all overwrite settings from the **SQ/CTRL Control** and **MST/RS-Ack Control** tabs. This button is not available when there is no overwrite value applied.

LCAS Source - Alarm

Press **TEST**, **LCAS** and **Alarm** (under **LCAS Source**).

Note: Not available in **Through** mode.

- **Member** indicates the timeslot number.
- **SQ** (Sequence Indicator): Indicates the member sequence indicator. The SQ for members in IDLE state will be automatically set to 63 for LOP or 255 for HOP.
- **Alarm Generation**
 - **Type**

GID Mismatch (Group Identifier Mismatch): Generates an inverted PRBS-15 pattern.
 - **On/Off** button: The On/Off button is used to activate/deactivate the selected alarm. This setting is disabled (Off) by default.

Alarm Analysis

- **TLCT** (Total Loss of Capacity Transmit): The TLCT alarm is declared when the number of active member equal zero while the number of provisioned member is bigger than zero.
- **PLCT** (Partial Loss of Capacity Transmit): The PLCT alarm is declared when the PLCT Threshold is reached while both numbers of active member and provisioned member are bigger than zero.
- **FOPT** (Failure of Protocol Transmit): The FOPT alarm is declared when a UMST alarm is present.
- **UMST** (Unexpected Member Status) The UMST alarm is declared when a persistent detection of the MST (MST=OK), while no RS-Ack is pending, for a member that carries the IDLE Control (CTRL).
- **SQ in UMST** (Sequence Indicator in Unexpected Member Status): Lists the SQ number(s) in the UMST.

Note: *Refer to Alarm/Error Measurements on page 47 for H/C LEDs and Seconds information.*

LCAS Source - Error

Press **TEST**, **LCAS** and **Error** (under **LCAS Source**).

Member	SQ	Type	Manual Amount	Send	Automated Rate	Continuous	On/Off
1, 1	<input type="checkbox"/>	<input type="text" value=""/>	<input type="text" value=""/>	Send	<input type="text" value=""/>	<input type="checkbox"/>	On/Off <input checked="" type="checkbox"/>
5, 1	<input type="checkbox"/>	<input type="text" value=""/>	<input type="text" value=""/>	Send	<input type="text" value=""/>	<input type="checkbox"/>	On/Off <input checked="" type="checkbox"/>

Note: Not available in **Through** mode.

- **Member** indicates the timeslot number.
- **SQ** (Sequence Indicator): Indicates the member sequence indicator. The SQ for members in IDLE state will be automatically set to 63 for LOP or 255 for HOP.
- **Type:** The following error is available with both manual and automated injection modes: **CRC-3** for LOP or **CRC-8** for HOP.
- **Manual**
 - **Amount:** Select the amount of manual error to be generated. Choices are **1** through **50**. The default setting is **1**.
 - **Send** button: Click on the Send button to manually generate error(s) according to the Error Type and the Amount of Errors selected.

Next-Generation Tabs

LCAS - Source

- **Automated**
 - **Rate:** Click on the Rate field to select the injection rate for the automated error. Choices are from **1.0E-03** to **9.9E-01**. The default setting is **1.0E-02**.
 - **Continuous:** When activated, generates a CRC error in all control packets. This setting is disabled by default.
 - **On/Off** button: The On/Off button is used to activate/deactivate the selected automated error at the rate specified or continuously when continuous is enabled. This setting is disabled (Off) by default.

LCAS Source - SQ/CTRL Control

Press **TEST**, **LCAS** and **SQ/CTRL Control** (under **LCAS Source**).

Member	SQ			CTRL		
	SQ	Override Enable	Generated	CTRL	Override Enable	Generated
1, 1	<input type="checkbox"/>	<input type="checkbox"/>	<input type="checkbox"/>	<input type="text"/>	<input type="checkbox"/>	<input type="text"/>
5, 1	<input type="checkbox"/>	<input type="checkbox"/>	<input type="checkbox"/>	<input type="text"/>	<input type="checkbox"/>	<input type="text"/>

Note: *Not available in **Through** mode.*

- **Member** indicates the timeslot number.
- **SQ**

SQ (Sequence Indicator): Indicates the member sequence indicator. The SQ for members in IDLE state will be automatically set to 63 for LOP or 255 for HOP.

Override Enable: Allows overwriting the SQ number. The SQ number of each member having the **Override Enable** checked can be overwritten. Click on a specific member's SQ number and enter the new number. Possible values are from **0** to **63** for LOP and from **0** to **255** for HOP. The number(s) changed will only take effect when the **Apply Overwrite Value(s)** button is pressed.

Generated: The SQ value generated by the state machine.

Enable All: Allows enabling the SQ overwrite for all members.

Next-Generation Tabs

LCAS - Source

► CTRL

CTRL: Indicates the Control value for each VCG member.

Overwrite Enable: Allows overwriting the Control. The CTRL value of each member having the **Overwrite Enable** checked can be overwritten. Click on a specific member CTRL value and select a new value from the list. Possible values are listed below. The value(s) changed will only take effect when the **Apply Overwrite Value(s)** button is pressed.

CTRL	Description	CTRL	Description
ADD (0001)	The member is about to be added to the group	Reserved (0111)	Reserved
NORM (0010)	Normal transmission	Reserved (1000)	Reserved
EOS (0011)	End of Sequence indication and Normal transmission	Reserved (1001)	Reserved
IDLE (0101)	The member is not part of the group or about to be removed	Reserved (1010)	Reserved
DNU (1111)	Do Not Use the payload, the Sink side reported FAIL status	Reserved (1011)	Reserved
FIXED (0000)	This is an indication that this end uses fixed bandwidth (non-LCAS mode)	Reserved (1100)	Reserved
Reserved (0100)	Reserved	Reserved (1101)	Reserved
Reserved (0110)	Reserved	Reserved (1110)	Reserved

- **Generated:** The Control value generated by the state machine.
- **Enable All:** Allows enabling the CTRL overwrite for all members.
- **Apply Overwrite Value(s):** Allows applying the new overwrite value(s) for both SQ and CTRL.

LCAS Source - MST/RX-Ack Control

Press **TEST**, **LCAS** and **MST/RX-Ack Control** (under **LCAS Source**).

Member	SQ	MST		Overwrite Enable	Received
		MST	MST		
1, 1	<input type="text"/>	<input type="text"/>	<input type="text"/>	<input type="checkbox"/>	<input type="text"/>
5, 1	<input type="text"/>	<input type="text"/>	<input type="text"/>	<input type="checkbox"/>	<input type="text"/>

RS-Ack		
Status	Received Value	Received Count
<input type="text"/>	<input type="text"/>	<input type="text"/>
Timeout Count	Unexpected Count	Manual Toggle Count
<input type="text"/>	<input type="text"/>	<input type="text"/>
Manual Control <input type="checkbox"/>	Toggle RS-Ack	

Enable All Apply Overwrite Value(s)

LCAS Overview Alarm Error SQ/CTRL Control MST/RX-Ack Control Configuration

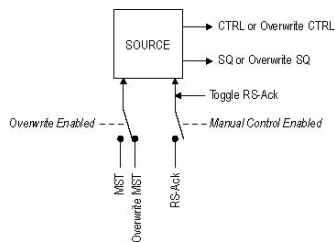

Note: Not available in **Through** mode.

- **Member** indicates the timeslot number.
- **SQ** (Sequence Indicator): Indicates the member sequence indicator. The SQ for members in IDLE state will be automatically set to 63 for LOP or 255 for HOP.

Next-Generation Tabs

LCAS - Source

- **MST**
 - **MST:** Indicates the current MST value that is applied to the state machine. Possible values are **OK** (0) and **Fail** (1).
 - **Overwrite Enable:** Allows overwriting the member status. The status of each member having the **Overwrite Enable** checked can be overwritten. Click on a specific member drop list and select the new status. Possible statuses are **OK** and **Fail**. The status(es) changed will only take effect when the **Apply Overwrite Value(s)** button is pressed.
 - **Enable All:** Allows enabling the MST overwrite for all members.
 - **Apply Overwrite Value(s):** Allows applying the new overwrite value(s).
- **Received:** Indicates the member status received at the source.

RS-Ack (Re-Sequence Acknowledge)

- **Status:** Indicates the status of the RS-Ack. Possible statuses are **Received** and **Pending**.
- **Received Value:** Toggle every time a RS-Ack is received. The value toggle either from **0** to **1** or **1** to **0**.
- **Received Count:** Indicates the number of RS-Ack received.
- **Timeout Count:** Indicates the RS-Ack timeout count based on the configuration of the *RS-Ack Timeout* on page 480.
- **Unexpected Count:** Indicates the number of unexpected RS-Ack.
- **Manual Toggle Count:** Indicates the number of manual toggle.
- **Manual Control:** Allows blocking the RS-Ack received from reaching the state machine.
- **Toggle RS-Ack** button: Allows to forced a received RS-Ack.

LCAS Source - Configuration

Press **TEST**, **LCAS** and **Configuration** (under **LCAS Source**).

Member	Auto Add at Startup	Remote DUT	RS-Ack Timeout
1, 1	<input type="checkbox"/>	<input type="checkbox"/> Non-LCAS	<input type="checkbox"/> Enabled
5, 1	<input type="checkbox"/>	Alarm PLCT Threshold 1	Duration (s) 1

Note: *Not available in **Through** mode.*

- **Member** indicates the timeslot number.
- **Auto Add at Startup:** Allows enabling the members that will be automatically added (applied) when the test is started.

Remote DUT

Non-LCAS: Specifies that the remote device connected to the IQS-8100 Series is LCAS (when disabled) or Non-LCAS (when enabled). Remote DUT, when Non-LCAS is enabled, is used to test the interoperability between an LCAS and a VCAT device that does not support LCAS.

Alarm

Note: *Not available when **Non-LCAS** from the Remote DUT group is enabled.*

PLCT Threshold (Partial Loss of Capacity Transmit Threshold): Allows the selection of the PLCT threshold value. Choices are from **1** to the provisioned member minus 1. The default setting is **1**.

RS-Ack Timeout

Note: *Not available when Non-LCAS from the Remote DUT group is enabled.*

- **Enabled:** Allows enabling the re-sequence acknowledge timeout value. This setting is enabled by default.
- **Duration (s):** Allows selecting the timeout duration. Choices are from **1** to **10** seconds. The default setting is **1** second.

LCAS Sink

Note: The test must be started and Enable LCAS has to be enabled from either VCAT TX - Overview on page 459 or VCAT RX - Overview on page 463 in order to access the LCAS Sink functionality.

Press **TEST** and **LCAS**.

Member	SQ	Command	MST	State	CTRL
1, 1					
5, 1					

Group
 Provisioned Member:
 Active Member:

RS-Ack
 Transmitted Count:

Alarm Analysis
 H: C: LCAS:

Overwrite Control

LCAS Overview | Alarm | Error | MST/RS-Ack Control | Configuration

The LCAS Sink tab gives access to the following tabs:

- *LCAS Sink - LCAS Overview* on page 482
- *LCAS Sink - Alarm* on page 484
- *LCAS Sink - Error* on page 486
- *LCAS Sink - MST/RS-Ack Control* on page 487
- *LCAS Sink - Configuration* on page 489

Note: The default selected tab is **LCAS Overview**.

- **Arrows:** Single arrows move one position up or down in the list. Double arrows move one page up or down in the list.

LCAS Sink - LCAS Overview

Press **TEST**, **LCAS** and **LCAS Overview** (under **LCAS Sink**).

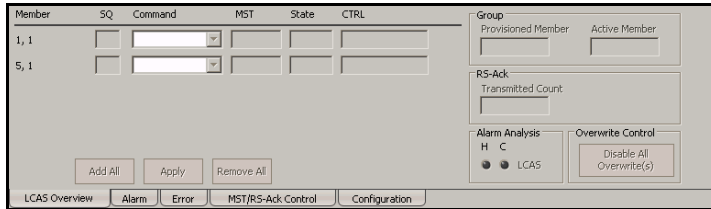

- **Member** indicates the timeslot number.
- **SQ** (Sequence Indicator): Indicates the member sequence indicator. The SQ for members in IDLE state will be automatically set to 63 for LOP or 255 for HOP.
- **Command**: Allows the selection of the command to be applied to the member. Choices are **None**, **Add**, and **Remove**. The default setting is **None**. The selected command(s) will only take effect once the **Apply** button is pressed.
- **Add All**: Click on the **Add All** button to set the **Add** command for all members. The command(s) will be sent only when **Apply** is pressed.
- **Apply**: Applies the selected command(s). The Apply button is not available while all commands are set to none.
- **Remove All**: Click on the **Remove All** button to set the **Remove** command for all members. The command(s) will be sent only when **Apply** is pressed.
- **MST**: Indicates the current member status for each VCG member. Possible statuses are **OK** (0) and **Fail** (1).
- **State**: Indicates the status of the Sink state machine. Possible states are **FAIL**, **OK** and **IDLE**.
- **CTRL** (Control): Indicates the CTRL transmitted by the LCAS state machine. See *CTRL* on page 476 for the list of possible CTRL.

Group

- **Provisioned Member:** Indicates the members that can be used for payload transmission. For example VT1.5-4v, 4v indicates that 4 members are available for payload transmission.
- **Active Member:** Indicates the members that are used for payload transmission (not in error). For example VT1.5-3v indicates that 3 members are used for payload transmission.

RS-Ack

Transmitted Count: Indicates the count of the transmitted RS-Ack.

Alarm Analysis

LCAS (Link Capacity Adjustment Scheme): The LCAS alarm is declared when any related LCAS alarm or error is active.

Overwrite Control

Disable All Overwrite(s): Disables all overwrite settings from the **MST/RS-Ack Control** tab. This button is not available when there is no overwrite value applied.

Next-Generation Tabs

LCAS Sink

LCAS Sink - Alarm

Press **TEST**, **LCAS** and **Alarm** (under **LCAS Sink**).

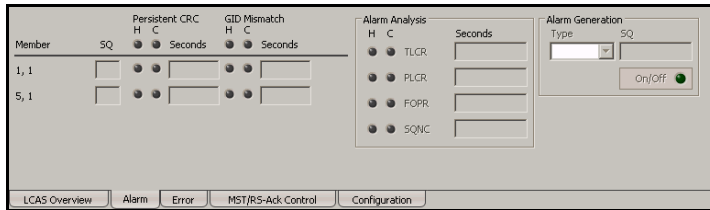

Note: Not available in **Through** mode.

- **Member** indicates the timeslot number.
- **SQ** (Sequence Indicator): Indicates the member sequence indicator. The SQ for members in IDLE state will be automatically set to 63 for LOP or 255 for HOP.
- **Persistent CRC:** Persistent CRC indicates that more than 20% CRC errors are detected in one second in the control packets.
- **GID Mismatch:** Indicates **GID Mismatch** alarm.

Note: Refer to Alarm/Error Measurements on page 47 for H/C LEDs and Seconds information.

Alarm Analysis

- **TLCR** (Total Loss of Capacity Receive): The TLCR alarm is declared when the number of active member equal zero while the number of provisioned member is bigger than zero.
- **PLCR** (Partial Loss of Capacity Receive): The PLCR alarm is declared when the PLCR Threshold is reached while both numbers of active member and provisioned member are bigger than zero.
- **FOPR** (Failure of Protocol Receive): The FOPR alarm is declared when persistent CRC or SQNC is present.
- **SQNC** (Sequence Indicator Non-Consistent): The SQNC alarm is declared when the members that carry the NORM, DNU or EOS message do not have a unique sequence indicator.

Note: Refer to Alarm/Error Measurements on page 47 for H/C LEDs and Seconds information.

Alarm Generation

- **Type**
UMST (Unexpected Member Status): The UMST is generated by constantly forcing a MST = OK for the selected SQ that is not currently used in the VCG.
- **SQ (Sequence Indicator)**: Allows selecting the SQ number for the selected alarm to be generated. Possible values are from **0** to **63** for LOP or **0** to **255** for HOP. The default setting is **1**.

Note: Only SQ members not currently used in the VCG are available.

- **On/Off** button: The On/Off button is used to activate/deactivate the selected alarm. This setting is disabled (Off) by default.

Next-Generation Tabs

LCAS Sink

LCAS Sink - Error

Press **TEST**, **LCAS** and **Error** (under **LCAS Sink**).

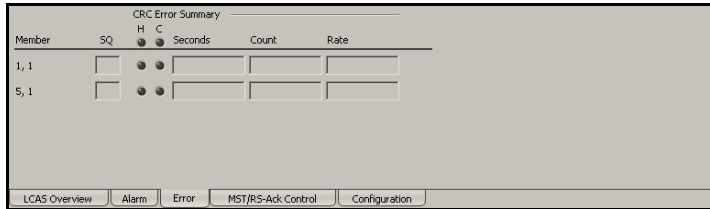

The screenshot shows a table titled "CRC Error Summary" with the following columns: Member, SQ, H, C, Seconds, Count, and Rate. There are two rows of data: "1, 1" and "5, 1". The "H" and "C" columns contain small circular indicators. Below the table is a navigation bar with tabs: "LCAS Overview", "Alarm", "Error", "MST/RS-Ack Control", and "Configuration".

Member	SQ	H	C	Seconds	Count	Rate
1, 1	<input type="text"/>	●	●	<input type="text"/>	<input type="text"/>	<input type="text"/>
5, 1	<input type="text"/>	●	●	<input type="text"/>	<input type="text"/>	<input type="text"/>

Note: Not available in **Through** mode.

- **Member** indicates the timeslot number.
- **SQ** (Sequence Indicator): Indicates the member sequence indicator. The SQ for members in IDLE state will be automatically set to 63 for LOP or 255 for HOP.

CRC-3/CRC-8 Error Analysis

Indicates respectively a **CRC-3** (for LOP) or **CRC-8** (for HOP) error.

Note: Refer to Alarm/Error Measurements on page 47 for H/C LEDs, Seconds, Count, and Rate information.

LCAS Sink - MST/RS-Ack Control

Press **TEST**, **LCAS** and **MST/RS-Ack Control** (under **LCAS Sink**).

Member	SQ	MST	MST	Overwrite Enable	Generated
1, 1	<input type="checkbox"/>	<input type="text"/>	<input type="checkbox"/>	<input type="text"/>	<input type="text"/>
5, 1	<input type="checkbox"/>	<input type="text"/>	<input type="checkbox"/>	<input type="text"/>	<input type="text"/>

Transmitted Value	Transmitted Count
<input type="text"/>	<input type="text"/>
Generated Count	Manual Toggle Count
<input type="text"/>	<input type="text"/>
Manual Control <input type="checkbox"/>	Toggle RS-Ack

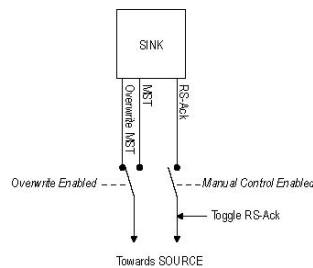

Note: Not available in **Through** mode.

- **Member** indicates the timeslot number.
- **SQ** (Sequence Indicator): Indicates the member sequence indicator. The SQ for members in IDLE state will be automatically set to 63 for LOP or 255 for HOP.

Next-Generation Tabs

LCAS Sink

- **MST**
 - **MST:** Indicates the MST generated by the state machine.
 - **Overwrite Enable:** Allows overwriting the member status. The status of each member having the **Overwrite Enable** checked can be overwritten. Click on a specific member's drop list and select the new status. Possible statuses are **OK** and **Fail**. The status(es) changed will only take effect when the **Apply Overwrite Value(s)** button is pressed.
 - **Enable All:** Allows enabling the MST overwrite for all members.
 - **Apply Overwrite Value(s):** Allows applying the new overwrite value(s). This button is only available when there are overwrite values that have not been applied.
- **Generated:** Indicates the actual value that is sent in the control packets.

RS-Ack (Re-Sequence Acknowledge)

- **Transmitted Value:** Toggle every time a RS-Ack is transmitted. The value toggle either from **0** to **1** or **1** to **0**.
- **Transmitted Count:** Indicates the number of RS-Ack transmitted.
- **Generated Count:** Indicates the number of RS-Ack generated by the LCAS state machine.
- **Manual Toggle Count:** Indicates the number of manual toggle.
- **Manual Control:** Allows blocking the RS-Ack transmitted by the state machine.
- **Toggle RS-Ack button:** Allows sending a RS-Ack.

LCAS Sink - Configuration

Press **TEST**, **LCAS** and **Configuration** (under **LCAS Sink**).

Member	Auto Add at Startup	Remote DUT	Hold-Off Timer
1, 1	<input type="checkbox"/>	<input type="checkbox"/> Non-LCAS	<input type="checkbox"/> Enabled Duration (s)
5, 1	<input type="checkbox"/>	Alarm PLCR Threshold	<input type="checkbox"/> Enabled Duration (s)

- **Member** indicates the timeslot number.
- **Auto Add at Startup:** Allows enabling the members that will be automatically added (applied) when the test is started.

Remote DUT

Note: *Not available in **Through** mode.*

Non-LCAS: Specifies that the remote device connected to the IQS-8100 Series is LCAS (when disabled) or Non-LCAS (when enabled).

Alarm

Note: *Not available when **Non-LCAS** from the **Remote DUT group** is enabled.*

PLCR Threshold (Partial Loss of Capacity Receive Threshold): Allows the selection of the PLCR threshold value. Choices are from **1** to the provisioned member minus 1. The default setting is **1**.

Hold-Off Timer

Note: *Not available when Non-LCAS from the Remote DUT group is enabled.*

- **Enabled:** Allows enabling the Hold-Off Timer. This setting is disabled by default.
- **Duration (s):** Allows selecting the timer duration. Choices are from **0.1** to **10** seconds. The default setting is **1** second.

Wait-to-Restore Timer

- **Enabled:** Allows enabling the Wait-to-Restore Timer. This setting is disabled by default.
- **Duration (s):** Allows selecting the timer duration. Choices are from **1** to **1000** seconds. The default setting is **300** seconds.

19 Common Tabs

Note: The available tabs listed are a function of the test path activated. Common tabs are not available with VCAT, LCAS and GFP.

Tab	Page
<i>HOP/LOP Pointer Adjust TX (SONET/SDH)^a</i>	492
<i>HOP/LOP Pointer Adjust RX (SONET/SDH)^a</i>	495
<i>TCM TX^a</i>	497
<i>TCM RX^a</i>	500
<i>Performance Monitoring (PM)</i>	504
<i>Client Offset TX</i>	513
<i>Client Offset RX</i>	515

a. LOP Pointer Adjust TX is not available on the IQS-8140.

Common Tabs

HOP/LOP Pointer Adjust TX (SONET/SDH)

HOP/LOP Pointer Adjust TX (SONET/SDH)

Note: This tab is not available with VCAT, LCAS and GFP.

Press **TEST**, **HOP/LOP**, and **Ptr Adj** (under **HOP/LOP TX**).

The screenshot shows a configuration window for the HOP/LOP Pointer Adjust TX (SONET/SDH) function. The window is divided into three main sections:

- Pointer:** Contains a text field for "Current Value" with a hyphen "-" entered.
- Pointer Steps:** Contains two input fields: "Increment" with the value "1" and "Decrement" with the value "1". Each field has a "Send" button to its right.
- Pointer Jump:** Contains a text field for "New Pointer Value" with the value "0" and a "Send" button to its right. Below this field is a checkbox labeled "New Data Flag" which is currently unchecked.

At the bottom of the window, there is a tabbed interface with four tabs: "Path", "OH", "Ptr Adj" (which is currently selected and highlighted in blue), and "TCM".

Pointer

Current Value indicates the current pointer value.

Pointer Steps

➤ Increment

For HOP: Select the number of positive pointer adjustment to include into the STS-n (SONET) or AU-n (SDH). For multiple pointer adjustments, the pointer adjustment rate is 1 adjustment at every 4 frames. Choices are **1** to **1000**. The default setting is **1**.

For LOP: Select the number of positive pointer adjustment to include into the VTn (SONET) or TU-n (SDH). For multiple pointer adjustments, the pointer adjustment rate is 1 adjustment at every 4 multiframes. Choices are **1** to **1000**. The default setting is **1**.

➤ Decrement

For HOP: Select the number of negative pointer adjustments to include into the STS-n (SONET) or AU-n (SDH). For multiple pointer adjustments, the pointer adjustment rate is 1 adjustment at every 4 frames. Choices are **1** to **1000**. The default setting is **1**.

For LOP: Select the number of negative pointer adjustments to include into the VTn (SONET) or TU-n (SDH). For multiple pointer adjustments, the pointer adjustment rate is 1 adjustment at every 4 multiframes. Choices are **1** to **1000**. The default setting is **1**.

➤ Send buttons: Press the corresponding **Send** button to send positive or negative pointer adjustments.

Common Tabs

HOP/LOP Pointer Adjust TX (SONET/SDH)

Pointer Jump

- **New Pointer Value:** The default setting is **0**. Choices are:

For high order path: **0 to 782**

For low order path:

Path	Range
VT1.5	0 to 103
VT2	0 to 139
VT6	0 to 427
TU-3	0 to 764
TU-2	0 to 427
TU-12	0 to 139
TU-11	0 to 103

- **Send** button: Allows to send the new pointer value.
- **New Data Flag (NDF):** Allows enabling the New Data Flag.
For HOP: When NDF is enabled, bits 1 to 4 of the pointer word (H1 and H2 bytes) are set to “1001” when executing a pointer jump.
For LOP: When NDF is enabled, bits 1 to 4 of the pointer word (V1 and V2 bytes) are set to “1001” when executing a pointer jump.

HOP/LOP Pointer Adjust RX (SONET/SDH)

Press **TEST**, **HOP/LOP**, and **Ptr Adj** (under **HOP/LOP RX**).

Pointer		Statistics	
Current Value	--	Pointer Increment	Count: --, Seconds: --
Cumulative Offset	--	Pointer Decrement	Count: --, Seconds: --
		NDF	Count: --, Seconds: --
		No NDF	Count: --, Seconds: --

Path OH **Ptr Adj** TCM PM

Pointer

- **Current Value** displays the value of the pointer:
 - For HOP: Displays the value for the pointer, H1 and H2, indicating the offset in bytes between the pointer and the first byte of the STS-n (SONET) or AU-n (SDH).
 - For LOP: Displays the value of the pointer, V1 and V2, indicating the offset in bytes between the pointer and the first byte of the VTn (SONET) or TU-n (SDH) of the high order path. However, TU-3 considered a low order path, uses the H1, H2, H3 bytes for its location.
- **Cumulative Offset** indicates the difference between the pointer increment and the pointer decrement. A pointer jump will reset this value to **0**.

Common Tabs

HOP/LOP Pointer Adjust RX (SONET/SDH)

Statistics

- **Pointer Increment** gives statistics on positive pointer adjustment detected.
- **Pointer Decrement** gives statistics on negative pointer adjustment detected.
- **NDF (New Data Flag)** gives statistics on pointer jumps containing a New Data Flag.

For HOP: Bits 1 to 4 of the pointer word (H1 and H2) detected are “1001”.

For LOP: Bits 1 to 4 of the pointer word (V1 and V2) detected are “1001”.

- **No NDF (No New Data Flag)** gives statistics on normal pointer jumps containing no NDF.

For HOP: Bit 1 to 4 of the pointer word (H1 and H2) detected are “0110”.

For LOP: Bit 1 to 4 of the pointer word (V1 and V2) detected are “0110”.

TCM TX

Press **TEST**, **HOP/LOP**, and **TCM** (under **TCM TX**).

The screenshot shows a configuration window for TCM TX. It is divided into three main sections: Configuration, Error Injection, and Alarm Generation. At the bottom, there are navigation tabs: Path, OH, Ptr Adj, and TCM (which is currently selected).

- Configuration:** Contains a checkbox labeled "Enable TCM" which is checked.
- Error Injection:** Divided into "Manual" and "Automated" sections.
 - Manual:** Includes a "Type" dropdown menu set to "TC-IEC" and an "Amount" input field set to "1". A "Send" button is located to the right.
 - Automated:** Includes a "Type" dropdown menu set to "TC-IEC", a "Rate" input field set to "1.3E-03", a "Continuous" checkbox (unchecked), and an "On/Off" button set to "On".
- Alarm Generation:** Includes a "Type" dropdown menu set to "TC-IAIS" and an "On/Off" button set to "On".
- TC Access Point Identifier Message:** A text input field containing the text "EXFO TCM".

Note: This tab is not available with VCAT, LCAS and GFP.

The TCM Generator tab allows generating alarms and errors for the Tandem Connection sub-layer providing the capability to better identify the source of a problem or of a failure when travelling through more than one independently operated networks.

Configuration

Enable TCM: Allows the activation of the Tandem Connection Monitoring (TCM). This setting is disabled by default.

Error Injection

Allows manual or automated error injection.

- **Type:** The following error types are available with both manual and automated injection modes. The default setting is **TC-IEC** for HOP and **TC-BIP** for LOP.

TC-IEC (Tandem Connection - Incoming Error Count): Available for HOP only. Bits 1 to 4 of the N1 byte.

TC-BIP (Tandem Connection - Bit Interleaved parity): Available for LOP only. Bits 1 and 2 of the Z6/N2 byte contain the BIP-2 computation of the payload.

TC-REI (Tandem Connection - Remote Error Indication): Bit 5 of N1 or Z6/N2 byte is set to **1**.

OEI (Outgoing Error indication): Bit 6 of the N1 or Z6/N2 byte is set to **1**.

- **Amount:** Select the amount of error to be generated. Choices are **1** through **50**. The default setting is **1**.
- **Send** button: Press **Send** to manually generate error(s) according to the Error Type and the Amount of Errors selected.
- **Rate:** Press **Rate** to select the injection rate for the selected error. Choices and default setting depend on the test path.
- **Continuous:** When activated, generates the selected error to its theoretical maximum rate. This setting is disabled by default.
- **On/Off** button: The On/Off button is used to activate/deactivate the selected automated error at the rate specified or continuously when continuous is enabled. This setting is disabled (Off) by default.

Alarm Generation

- **TC-RDI** (Tandem Connection - Remote Defect Indication): Generates a TC-RDI defect. Bit 8 of the N1/Z6/N2 byte multiframe 73 is set to “1”.
- **ODI** (Outgoing Defect Indication): Generates a ODI defect. Bit 7 of the N1/Z6/N2 byte frame 74 is set to “1”.
- **TC-IAIS** (Tandem Connection - Incoming Alarm Indication Signal): Generates an incoming AIS defect.
For HOP: Bits 1 through 4 of the N1 byte are set to “1110”.
For LOP: Bit 4 of the Z6/N2 byte is set to “1”.
- **TC-LTC** (Tandem Connection - Loss of Tandem Connection): Generates a wrong FAS multiframe indicator sequence.
- **TC-UNEQ** (Tandem Connection - Unequipped):
For HOP: Generates an all “0”s pattern in the higher order path signal label byte (C2), the TCM byte (N1) and the path trace byte (J1), and a valid BIP-8 bytes (B3).
For LOP: Generates an all “0”s pattern in the lower order path signal label (bit 5, 6, 7 of byte V5), the TCM byte (Z6/N2) and the path trace byte (J2), and a valid BIP-2 (bits 1, 2 of V5 byte).

TC Access Point Identifier

Message allows the selection of the APId (Access Point Identifier) message to be generated. Up to 15 characters are allowed (a CRC-7 byte will be added in front for a total of 16 bytes). The default setting is **EXFO TCM**.

Note: *The message value should be ACSII suitable characters.*

TCM RX

Press **TEST**, **HOP/LOP**, and **TCM** (under **TCM RX**).

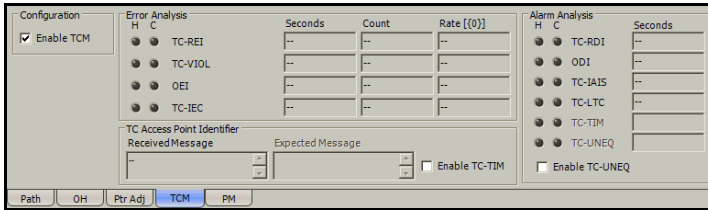

Note: This tab is not available with VCAT, LCAS and GFP.

The TCM Analyzer tab gives alarms and errors status for the Tandem Connection sub-layer.

Configuration

Enable TCM: Allows the activation of the Tandem Connection Monitoring (TCM). This setting is disabled by default.

Error Analysis

- **TC-REI** (Tandem Connection - Remote Error Indication): The TC-REI indicates errored blocks caused within the Tandem Connection (bit 5 of the N1/Z6/N2 byte).
- **TC-VIOL** (Tandem Connection - Violations):
For HOP: TC-VIOL indicates the number of B3 parity violation within the tandem connection for STS-1 SPE/VC-3 and above.
For LOP: TC-VIOL indicates the number of violation within the tandem connection for VT6 SPE/VC-2 and below.

- **OEI (Outgoing Error Indication):** The OEI indicates errored blocks of the outgoing VTn/VC-n (bit 6 of the N1 byte).
- **TC-IEC (Tandem Connection - Incoming Error Count):** The TC-IEC indicates the number of B3 parity violations detected at the TC Source for STS-1 SPE/VC-3 and above (bits 1 to 4 of the N1 byte). Available for HOP only.

Number of BIP-8 violations	Bit 1	Bit 2	Bit 3	Bit 4
0	0	0	0	0
1	0	0	0	1
2	0	0	1	0
3	0	0	1	1
4	0	1	0	0
5	0	1	0	1
6	0	1	1	0
7	0	1	1	1
8	1	0	0	0
0	1	0	0	1
0	1	0	1	0
0	1	0	1	1
0	1	1	0	0
0	1	1	0	1
0 (IAIS)	1	1	1	0
0	1	1	1	1

Alarm Analysis

- **TC-RDI** (Tandem Connection - Remote Defect Indication):
For SONET: The TC-RDI is declared when bit 8 of the N1/Z6 byte frame 73 is set to “1”.
For SDH: The TC-RDI is declared when bit 8 of the N1/N2 byte multiframe 73 is set to “1”.
- **ODI** (Outgoing Defect Indication):
For SONET: The ODI is declared when bit 7 of the N1/Z6 byte frame 74 is set to “1”.
For SDH: The ODI is declared when bit 7 of the N1/N2 byte multiframe 74 is set to “1”.
- **TC-IAIS** (Tandem Connection - Incoming Alarm Indication Signal):
For HOP: The TC-IAIS is declared when bits 1 through 4 of the N1 byte are set to “1110”.
For LOP: The TC-IAIS is declared when bit 4 of the Z6/N2 byte is set to “1”.
- **TC-LTC** (Tandem Connection - Loss of Tandem Connection): The TC-LTC is declared when receiving a wrong FAS multiframe.
- **TC-TIM** (Tandem Connection - Trace Identifier Mismatch): The TC-TIM is declared when the received message differs from the defined expected message. The TC-TIM is also declared when receiving invalid ASCII characters or when errors are detected with CRC-7.
- **TC-UNEQ** (Tandem Connection - Unequipped):
For HOP: TC-UNEQ is declared when receiving an all “0”s pattern in the higher order path signal label byte (C2), the TCM byte (N1) and the path trace byte (J1), and a valid BIP-8 bytes (B3).
For LOP: TC-UNEQ is declared when receiving an all “0”s pattern in the lower order path signal label (bit 5, 6, 7 of byte V5), the TCM byte (Z6/N2) and the path trace byte (J2), and a valid BIP-2 (bits 1, 2 of V5 byte).

Note: *The VT SPE / VC payload and the remaining path overhead bytes are unspecified.*

TC-Access Point Identifier

- **Received Message** displays the APId (Access Point Identifier) message received.

Note: *The <crc7> string represents the CRC-7 byte.*

- **Expected Message** allows the edition of the expected APId (Access Point Identifier) message. Up to 15 characters are allowed (a CRC-7 byte will be added in front for a total of 16 bytes). The default setting is **EXFO TCM**.

Note: *The message value should be ACSII suitable characters.*

- **Enable TC-TIM** has to be enabled to give access to the edition of the expected message and to enable the TC-TIM alarm analysis.

Common Tabs

Performance Monitoring (PM)

Performance Monitoring (PM)

Note: This tab is not available with VCAT, LCAS and GFP.

The Performance Monitoring tab gives error performance events and parameters for the DS_n/PDH or SONET/SDH circuit under test.

For SONET/SDH Section/RS: Press **TEST**, **Sec-Line**, and **Section/RS PM** (under **Sec-Line/RS-MS RX**).

For SONET/SDH Line/MS: Press **TEST**, **Sec-Line**, and **Line/MS PM** (under **Sec-Line/RS-MS RX**).

For SONET/SDH HOP: Press **TEST**, **HOP**, and **PM** (under **HOP RX**).

For SONET/SDH LOP: Press **TEST**, **LOP**, and **PM** (under **LOP RX**).

For DS_n-PDH: Press **TEST**, **DS_n-PDH**, and **DS1/DS3/E1/E2/E3/E4 PM** (under **DS_n-PDH RX**).

For Pattern: Press **TEST**, **Pattern**, and **PM** (under **Pattern RX**).

Near-End		Far-End	
EFS	--	EFS	--
EB	--	EB	--
ES	--	ES	--
SES	--	SES	--
BBE	--	BBE	--
UAS	--	UAS	--
ESR	--	ESR	--
SESR	--	SESR	--
BBER	--	BBER	--

Path OH Ptr Adj TCM **PM**

Standard

Select the desired standard from the list. The default setting is **G.826 ISM** for IQS-8105/15/20/30 and **G.828 ISM** for IQS-8140. Choices are **G.821**, **G.826 ISM¹**, **G.828 ISM**, **G.829 ISM**, **M.2100 ISM¹**, **M.2100 OOSM**, and **M.2101 ISM**.

Note: *G.821 and M.2100 OOSM are only available when receive Live Traffic from the Pattern RX on page 409 is not activated.*

Standard's availability

Analyzed Signal	G.821	G.826 ISM ¹	G.828 ISM	G.829 ISM	M2100 ISM ¹	M2100 OOSM	M2101 ISM
Pattern	X					X	
DS1/DS3 / E1/E2/E3/E4		X			X		
STS-Ne/VTn / STM-Ne/AU-n/ TU-n			X				X
OC-N Section / STM-N RS				X			
OC-N Line / STM-N MS				X			X

1. Not available on the IQS-8140.

Near-End

- **EFS** (Error Free Second) (**G.821**, **G.826**, **G.828**, and **G.829**): Gives the number of seconds within which no error occurred.
- **EC** (Error Count) (**G.821** only): Gives the number of bit errors.
- **EB** (Errored Block) (**G.826**, **G.828**, and **G.829**): Gives the count of blocks in which one or more bits are in error.
- **ES** (Errored Second):

For G.821, and M.2100 OOSM: Gives the number of seconds within which one or more bit error occurred, or during which Loss Of Signal (LOS) or AIS is detected.

For G.826, G.828, G.829, M.2100 ISM, and M.2101: Gives the number of seconds within which one or more anomalies (FAS, EB, etc.) occurred, or at least one defect occurred.

- **SES** (Severely Errored Second)

For G.821, and M.2100 OOSM: Gives the number of seconds within which a bit error ratio is $\geq 10^{-3}$, or during which one defect (LOS/AIS) is detected.

For G.826, G.828, G.829 and M.2101: Gives the number of seconds within which anomalies (FAS, EB, etc.) are $\geq X\%$ or at least one defect occurred. $X = 30\%$ for DS_n/PDH signals; see the following table for SONET/SDH signals SES threshold.

	STS-1 STM-0	OC-3 STM-1	OC-12 STM-4	OC-48 STM-16	OC-192 STM-64	OC-768 STM-256
Path	30%	30%	30%	30%	30%	30%
Line/MS	15%	15%	25%	30%	30%	30%
Section/RS	10%	30%	30%	30%	30%	30%

For **M.2100 ISM**: Gives the count of the seconds within which anomalies (frame bit errors, CRC block errors, etc.) are $\geq Y$ or at least one defect occurred. Y depends on the type of DSn/PDH signal as described in the following table.

Signal	SES Threshold
DS1 (SF)	8 frame bit errors (Near-End)
DS1 (ESF)	320 CRC-6 block errors (Near-End) 320 CRC-6 block errors (Far-End, if FDL enabled)
E1 (Framed without CRC-4)	28 frame bit errors (Near-End)
E1 (Framed with CRC-4)	805 CRC-4 block errors (Near-End) 805 E-bit errors (Far-End)
DS3 (M13)	2444 P-bit errors (Near-End) or 5 F-bit errors (Near-End)
DS3 (C-bit Parity)	2444 P-bit errors (Near-End) or 5 F-bit errors (Near-End) 2444 FEBE errors (Far-End)
E2 (Framed)	41 frame bit errors (Near-End)
E3 (Framed)	52 frame bit errors (Near-End)
E4 (Framed)	69 frame bit errors (Near-End)

Common Tabs

Performance Monitoring (PM)

- **BBE (Background Block Error) (G.826, G.828, G.829, and M.2101):** Gives the count of Errored Block not occurring as part of a SES.
- **UAS (Unavailable Second):** Gives the count of the seconds corresponding to the periods of unavailable time that begins at the onset of 10 consecutive SES events, including these 10 seconds. A period of available time shall begin at the onset of 10 consecutive non-SES events, including these 10 seconds.

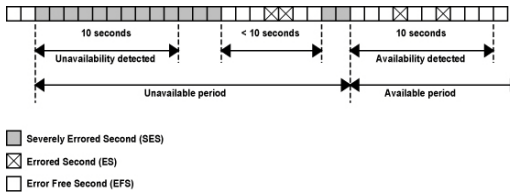

- **ESR (Errored Second Ratio) (G.821, G.826, G.828, and G.829):** Gives the ratio of the number of ES in available time (AS) during a fixed measurement interval.

$$\text{ESR} = \text{ES} \div \text{AS}$$

- **SESR (Severely Errored Second Ratio) (G.821, G.826, G.828, and G.829):** Gives the ratio of the number of SES in available time (AS) during a fixed measurement interval.

$$\text{SESR} = \text{SES} \div \text{AS}$$

- **BBER (Background Block Error Ratio) (G.821, G.826, G.828, and G.829):** Gives the ratio of BBE in available time (AS) to total blocks in available time during a fixed measurement interval. The count of total blocks excludes all blocks during SESs.

- **DM** (Degraded Minutes) (**G.821** only): A Degraded Minute is the number of minutes in which the estimated error rate exceeds 10^{-6} but does not exceed 10^{-3} . DM is determined by collecting all of the Available Seconds, removing any SES grouping the result in 60-second long groups and counting a 60-second long group as degraded if the cumulative errors during the seconds present in the group exceed 10^{-6} .
- **SEP** (Severely Errored Period) (**G.828** only): A sequence between 3 to 9 consecutive SES. The sequence is terminated by a second which is not a SES.
- **SEPI** (Severely Errored Period Intensity) (**G.828** only): Gives the count of SEP events in available time, divided by the total available time in seconds.

Common Tabs

Performance Monitoring (PM)

Far-End

- **EFS** (Error Free Second): Gives the count of the seconds within which no error occurred or when a defect is detected on the near-end.
- **EC** (Error Count) (**G.821** only): Gives the number of bit errors.
- **EB** (Errored Block) (**G.826**, **G.828**, and **G.829**): Gives the count of blocks in which one or more bits are in error.
- **ES** (Errored Second): For **G.826**, **G.828**, **G.829**, **M.2100 ISM**, and **M.2101**: Gives the count of the seconds within which one or more anomalies (FAS, EB, etc.) occurred or at least one defect occurred.
- **SES** (Severely Errored Second):

For **G.826**, **G.828**, **G.829**, and **M.2101**: Gives the count of the seconds within which anomalies (FAS, EB, etc.) is $\geq X\%$ or at least one defect occurred. $X = 30\%$ for DS_n/PDH signals; see the following table for SONET/SDH signals.

	STS-1 STM-0	OC-3 STM-1	OC-12 STM-4	OC-48 STM-16	OC-192 STM-64	OC-768 STM-256
Path	30%	30%	30%	30%	30%	30%
Line/MS	15%	15%	25%	30%	30%	30%
Section/RS	10%	30%	30%	30%	30%	30%

For M.2100 ISM: Gives the count of the seconds within which anomalies (frame bit errors, CRC block errors, etc.) are $\geq Y$ or at least one defect occurred. Y depends on the type of DSn/PDH signal as described in the following table.

Signal	SES Threshold
DS1 (SF)	8 frame bit errors (Near-End)
DS1 (ESF)	320 CRC-6 block errors (Near-End) 320 CRC-6 block errors (Far-End, if FDL enabled)
E1 (Framed without CRC-4)	28 frame bit errors (Near-End)
E1 (Framed with CRC-4)	805 CRC-4 block errors (Near-End) 805 E-bit errors (Far-End)
DS3 (M13)	2444 P-bit errors (Near-End) or 5 F-bit errors (Near-End)
DS3 (C-bit Parity)	2444 P-bit errors (Near-End) or 5 F-bit errors (Near-End) 2444 FEBE errors (Far-End)
E2 (Framed)	41 frame bit errors (Near-End)
E3 (Framed)	52 frame bit errors (Near-End)
E4 (Framed)	69 frame bit errors (Near-End)

- **BBE** (Background Block Error) (G.828 and G.829 Line): Gives the count of Errored Blocks not occurring as part of an SES.

Common Tabs

Performance Monitoring (PM)

- **UAS (Unavailable Second):** Gives the count of the seconds corresponding to the period of unavailable time that begins at the onset of 10 consecutive SES events, including these 10 seconds. A period of available time shall begin at the onset of 10 consecutive non-SES events, including these 10 seconds.

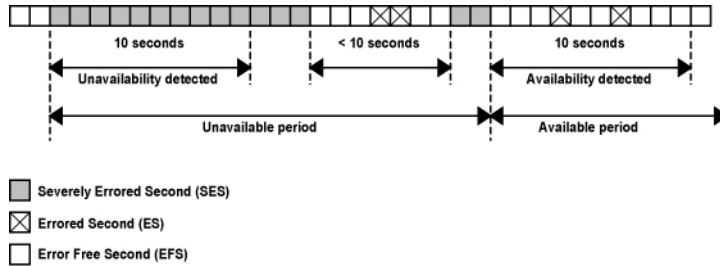

- **ESR (Errored Second Ratio):** Gives the ratio of the number of ES in available time to total seconds in available time during a fixed measurement interval.

$$ESR = ES \div AS$$

- **SESR (Severely Errored Second Ratio):** Gives the ratio of the number of SES in available time to total seconds in available time during a fixed measurement interval.

$$SESR = SES \div AS$$

- **BBER (Background Block Error Ratio):** Gives the ratio of BBE in available time to total blocks in available time during a fixed measurement interval. The count of total blocks excludes all blocks during SESs.

Client Offset TX

Note: Available with ODUflex CBR and Gb Ethernet client. Not available in Through mode.

For ODUflex CBR, press **TEST**, **BERT**, and **Client Offset**.

For Gb Ethernet, press **TEST**, **Gb Ethernet**, and **Client Offset**.

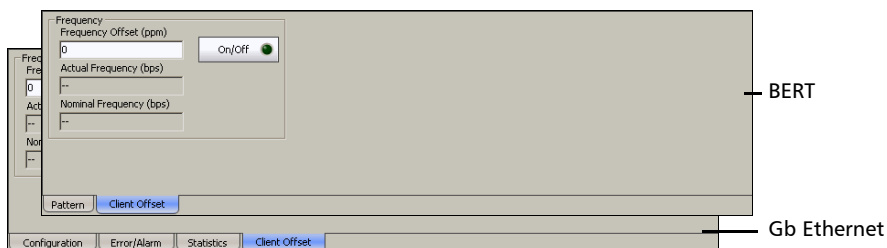

Frequency

- **Frequency Offset (ppm):** Allows entering a positive or a negative client frequency offset in ppm. The default setting is **0**.
On/Off button: Allows enabling the frequency offset generation. This setting is disabled (Off) by default.
- **Actual Frequency (bps):** Indicates the frequency (Nominal frequency + port frequency offset + client frequency offset) used for transmission for the client signal. Refer to *Frequency* on page 149 for the port frequency offset.

Common Tabs

Client Offset TX

- **Nominal Frequency (bps):** Indicates the nominal frequency of the signal.

Client	Frequency Offset ^a	Nominal Frequency
Gb Ethernet	± 115 ppm	1250000000 bps
ODUflex CBR	± 115 ppm ^b	TX Rate configured (Refer to <i>TX Rate</i> on page 407).

- The Client frequency offset range is guaranteed for a clock source signal at 0 ppm offset. In the event that the clock source signal already has an offset then, the output signal may exhibit an offset larger than the range specified. For example, if the clock source signal has an offset of +20 ppm then, the Client frequency offset could be up to 135 ppm (115 ppm + 20 ppm).
- The Client offset function does not allow the generation of a signal with a rate above 100% of the TX rate. For example, if the TX Rate is set to 100%, the allowed offset range will be -115 ppm to 0 ppm.

Client Offset RX

Note: Available with ODUflex CBR and Gb Ethernet client.

For ODUflex CBR, press **TEST**, **BERT**, and **Client Offset**.

For Gb Ethernet, press **TEST**, **Gb Ethernet**, and **Client Offset**.

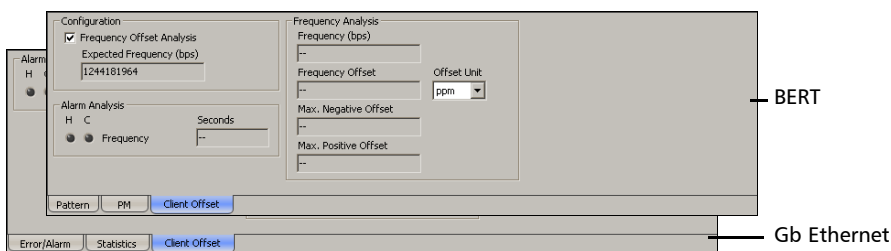

Configuration

Note: The configuration of the expected frequency offset is available with ODUflex CBR test only.

► Frequency Offset Analysis

Allows to enable the frequency offset measurements. This setting is enabled by default for normal mode, and disabled for Through mode.

► Expected Frequency (bps)

For normal mode, the frequency is set to the configured TX Rate (Refer to *TX Rate* on page 407) and the **Frequency Offset Analysis** check box is selected.

For Through mode (refer to *Creating an OTN (OTU1 and OTU2) Test Case* on page 92), enter the expected frequency in bps and then select the **Frequency Offset Analysis** check box.

Common Tabs

Client Offset RX

Alarm Analysis

Frequency alarm indicates that the received client signal rate meets the standard rate specifications (green) or not (red). Not available with ODUflex CBR when **Frequency Offset Analysis** is disabled.

Client	Standard Rate Specification
Gb Ethernet	1250000000 \pm 131875 bps (\pm 105.5 ppm)
ODUflex CBR	Expected RX rate \pm 105.5 ppm (See <i>Expected Frequency (bps)</i> on page 515)

Frequency Analysis

The IQS-8100 Series allows the following frequency monitoring range.

Client	Measurement range
Gb Ethernet	1250000000 \pm 150000 bps (\pm 120 ppm)
ODUflex CBR	Expected RX rate \pm 120 ppm (See <i>Expected Frequency (bps)</i> on page 515)

Frequency (bps) indicates the frequency of the input signal in bps.

Note: *The following frequency measurements are not available with ODUflex CBR when **Frequency Offset Analysis** is disabled.*

Frequency Offset indicates the offset between the expected rate specification and the rate of the input signal.

Max. Negative Offset indicates the offset between the expected rate specification and the smallest rate recorded from the received signal.

Max. Positive Offset indicates the offset between the expected rate specification and the largest rate recorded from the received signal.

Offset Unit allows the selection of the frequency offset unit. Choices are **bps** and **ppm**. The default setting is **ppm**.

20 System Tab

The System tab gives access to tabs containing general functions related to the IQS-8100 Series operation.

	Tab	Page
Clock Synchronization	<i>Clock Synchronization</i>	520
Preferences	<i>Application Preferences</i>	528
	<i>Default Test Preferences</i>	530
Module Information	<i>Module Information</i>	544
Software Options	<i>Software Options</i>	546
Remote Control	<i>Remote Control</i>	549

Clock Synchronization

Press **System** and **Clock Synchronization**.

Clock Synchronization

TX

Configuration
Clock Mode: [None] Interface Type: [None] LBO: []
Line Coding: [] Framing: []

Alarm Analysis
 LOC

Signal Analysis
 Output Presence

RX

Configuration
Interface Type: [None] Termination Mode: []
Line Coding: [] Framing: []

Alarm Analysis
 LOS
 AIS
 LOF
 Frequency

Frequency Analysis
Frequency (bps): []
Frequency Offset: []

Backplane

Configuration
Clock Mode: [Internal] Enable

Alarm Analysis
 LOC

Ref Output

Configuration
Divider Ratio: [16]

Signal Analysis
Frequency (MHz): []
 Output Presence

Note: TX and RX clock configuration is not available when the test mode is set to **Dual RX**. Refer to Test Configuration on page 126 for more information.

TX

Note: TX clock configuration is only possible when the RX clock is set to **None**.

Configuration: Allows the configuration of the clock that will be generated. First select the Interface Type then, the other parameters will become accessible for configuration.

- **Interface Type:** Allows the selection of the clock interface signal (DS1/E1/2M) that will be generated. Choices are: **None**, **DS1**, **E1**, and **2 MHz**. The default setting is **None**.

- **LBO (Line Build Out):** Allows the selection of the interface Line Build Out that meets the interface requirements over the full range of cable lengths. Available with DS1 interface only. Choices are: **+3.0 dBdsx (533-655 ft)**, **+2.4 dBdsx (399-533 ft)**, **+1.8 dBdsx (266-399 ft)**, **+1.2 dBdsx (133-266 ft)**, and **+0.6 dBdsx (0-133 ft)**.
- **Line Coding:** Allows the selection of the interface line coding. Choices are **AMI** and **B8ZS** for DS1; **AMI** and **HDB3** for E1.

Note: *Line Coding is not available with 2 MHz interface.*

- **Framing:** Allows the selection of the interface framing. Choices are **SF** and **ESF** for DS1; **PCM 30**, **PCM 30 CRC-4**, **PCM 31**, and **PCM 31 CRC-4** for E1.

Note: *Framing is not available with 2 MHz interface.*

- **Clock Mode:** Allows the selection of the source clock that will be used to generate the clock on the selected interface type. Choices are:

Internal: Internal clock of the unit (STRATUM 3).

Recovered: Clock from the test optical/electrical port input signal. Not available on the IQS-8140.

Backplane: 8 kHz clock from another module on the IQS-600. Note that the other module must support the backplane clock feature and must be enabled (refer to *Backplane* on page 526 for more information).

System Tab

Clock Synchronization

Signal Analysis

- **Output Presence:** Indicates the presence of a signal at the output interface/port (green) or not (gray).

Alarm Analysis

- **LOC (Loss Of Clock):** Indicates if the module is able to synchronize with the selected clock mode and generates a valid synchronization signal at the AUX output port (green) or not (red; no signal is generated at the AUX output port).

RX

Note: *RX clock configuration is only possible when the TX clock is set to None.*

Configuration: Allows the selection and configuration of the input clock. This clock will be used for test synchronization if External clock has been selected during test setup.

- **Interface Type:** Allows the configuration of the clock that will be received. First select the Interface Type then, the other parameters will become accessible for configuration. Choices are: **None**, **DS1**, **E1**, and **2 MHz**.
- **Termination Mode:** Specifies how the unit is connected to the synchronization signal. Choices are:

For DS1:

Term: Provides an input that terminates the DS1 signal.

Mon: Provides high-input impedance and compensation for resistive loss. This setting is useful for monitoring DS1 signals at DSX monitor points, which are resistor-isolated.

Bridge: Provides high-input impedance for bridging lines that are already terminated. This setting is useful for bridging directly across copper cable pairs.

For E1:

Term: Provides an input that terminates the E1 signal.

Monitor: Provides high-input impedance and compensation for resistive loss. This setting is useful for monitoring E1 signals at monitor points, which are resistor-isolated.

Bridge: Provides high-input impedance for bridging lines that are already terminated. This setting is useful for bridging directly across copper cable pairs.

- **Line Coding:** Allows the selection of the interface line coding. Line Coding is not available with 2 MHz interface. Choices are:

For DS1: AMI and **B8ZS**. The default setting is **B8ZS**.

For E1: AMI and **HDB3**. The default setting is **HDB3**.

- **Framing:** Allows the selection of the interface framing. Framing is not available with 2 MHz interface. Choices are:

For DS1: SF, and ESF. The default setting is SF.

For E1: PCM30, PCM30 CRC-4, PCM31, and PCM31 CRC-4. The default setting is PCM30.

System Tab

Clock Synchronization

Alarm Analysis

Note: *AIS and LOF alarms are not available for 2MHz clock.*

- **LOS** (Loss Of Signal): The LOS alarm indicates absence of an input signal or an all-zeros signal is received.
- **AIS** (Alarm Indication Signal): The AIS alarm is declared when an unframed all-ones signal is received.
- **LOF** (Loss Of Frame):
 - For DS1:** The LOF alarm indicates that there was no valid framing pattern for 40 milliseconds and there was at least one OOF error during this period.
 - With SF Framing: The Loss-of-Frame condition will be assumed when 2 terminal frame and/or signaling frame errors in 5 consecutive frames have been received.
 - With ESF Framing: The Loss-of-Frame condition will be assumed when 2 FPS frame errors in 5 consecutive frames have been received.
 - For E1:** The LOF alarm indicates that three consecutive incorrect frame alignment signals have been received.

- **Frequency:** The Frequency alarm indicates if the received signal rate meets (green) or not (red) the following rate specifications.

Signal	Rate specification
DS1	1544000 ±15 bps (±9.2 ppm)
E1	2048000 ±19 bps (±9.2 ppm)
2MHz	2048000 ±19 Hz (±9.2 ppm)

Frequency Analysis

- **Frequency (bps)** displays the received signal rate in bps for DS1 and E1 interfaces and in Hz for 2 MHz interface.
- **Frequency Offset** displays the positive or negative frequency offset between the standard rate specification and the rate from the received signal. Frequency unit can be set to **bps**, or **ppm** for DS1/E1 and is set to Hz for 2 MHz. The default setting is **bps** for DS1/E1 and **Hz** for 2 MHz.

Backplane

The backplane feature allows sharing the same backplane 8 kHz clock for synchronization group purposes. The other module must support the backplane clock feature to be able to use the generated backplane clock.

Configuration: Allows the selection and configuration of the backplane 8 kHz clock that will be generated when enabled.

- **Clock Mode:** Allows the clock source selection. The default setting is **Internal**.

Internal: Internal clock of the unit (STRATUM 3).

External: Clock received from the connected DS1/E1/2M external clock signal (**AUX** port). See *Clock Synchronization - RX* on page 522 to complete the external clock settings.

Recovered: Clock from the test optical/electrical port input signal. Not available with OTU1e/OTU2e/OTU1f/OTU2f.

- **Enable:** Allows enabling the selected backplane clock.

Alarm Analysis

LOC (Loss Of Clock): Indicates if the module is able (green) or unable (red) to synchronize with the selected test clock.

REF OUT/Ref Output

Note: REF OUT is only available with the IQS-8130, IQS-8130NGI, IQS-8130NGE, and 8140 models. The REF OUT signal is automatically enabled on the REF OUT port (SMA connector) when the laser of the **10G/11.3G** port is turned ON.

Configuration

- **Divider Ratio:** Allows the selection of the transmit test clock divider. Choices are **16**, **32**, and **64**. The following table shows the corresponding output frequency in MHz.

For OC-192/STM-64/OTU2/OTU1e/OTU2e/OTU1f/OTU2f

Clock divider	Output frequency for					
	OC-192/STM-64	OTU2	OTU1e	OTU2e	OTU1f	OTU2f
16	622.08 MHz	669.33 MHz	690.57 MHz	693.48 MHz	704.38 MHz	707.35 MHz
32	311.04 MHz	334.66 MHz	345.29 MHz	346.74 MHz	352.19 MHz	353.68 MHz
64	155.52 MHz	167.33 MHz	172.64 MHz	173.37 MHz	176.10 MHz	176.84 MHz

For OC-768/STM-256/OTU3, there is no clock divider. The clock output frequency is set as follow.

Output frequency for OC-768/STM-256	Output frequency for OTU3
2488.32 MHz	2688.65 MHz

Signal Analysis

- **Frequency (MHz):** Displays the generated signal frequency in MHz.
- **Output Presence:** Indicates the presence of a signal at the REF OUT port (green) or not (gray).

Application Preferences

Press **System**, and **Preferences**.

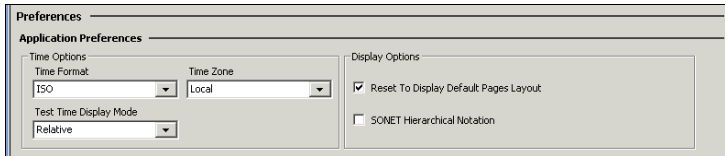

Note: *The application preferences are saved per slot on the IQS-600 meaning that the configuration will not follow the module when changing the module from one slot to another. However, a configuration on a specific slot will remain when replacing a module by another module of the same model.*

Time Options

- **Time Format:** Sets the absolute time format of the GUI (current time and timers). The default setting is **ISO**. Choices are:

ISO displays the time and timers with the yyyy-mm-dd hh:mm:ss format.

USA displays the time and timers with the mm/dd/yy hh:mm:ss AM/PM format.

- **Time Zone:** Allows the selection of the time zone source. The default setting is **Local**.

UTC/GMT displays the time base on the UTC time zone.

Local displays the time from the IQS-600 unit or from the PC when using **Visual Guardian Lite**.

- **Test Time Display Mode:** Allows the selection of the test time mode displayed in the Logger panel. The default setting is **Relative**.

Relative displays the time elapsed since the beginning of the test for a test event.

Absolute displays the date and time of a test event.

Display Options

- **Reset to Display Default Pages Layout** when enabled, resets the page layout to its default layout each time a test is modified.
- **SONET Hierarchical Notation** when enabled sets the test setup grid to present STS-3 and STS-1 [STS-3#,STS-1#] numbers for the OC-n interface. Refer to *Hierarchical Notation* on page 612 for more information.

Default Test Preferences

Press **System** and **Preferences**.

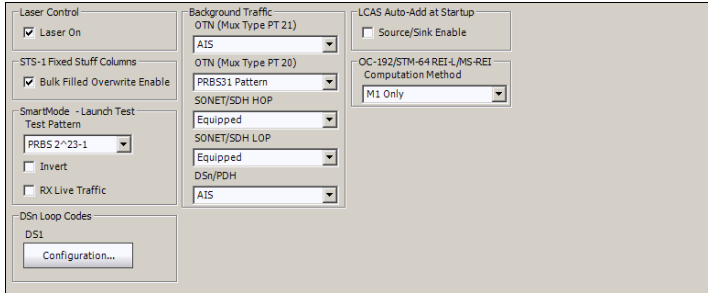

Allows setting the default test parameters that will be applied every time a test is created manually using **Test Setup** or when using SmartMode (not supported on the IQS-8140). Changes to the default test preferences will only apply when a new test case is created.

Note: *The default test preferences are saved per slot on the IQS-600 meaning that the configuration will not follow the module when changing the module from one slot to another. However, a configuration on a specific slot will remain when replacing a module by another module of the same model.*

Configuration

- **Laser On:** Selects **Laser On** every time a test is created manually using the wizard or when using SmartMode. The **Laser On** check box is selected by default.
- **STS-1 Fixed Stuff Columns**

Enable Bulk Filled Override fills up the bytes of the STS-1 SPE's columns 30 and 59 with the selected pattern from the tab *Pattern TX* on page 405 when the **Enable Bulk Filled Override** check box is selected. The **Enable Bulk Filled Override** check box is selected by default.

➤ **SmartMode - Launch Test**

Allows the configuration of the default TX/RX **Test Pattern** that will be used when starting a test case using SmartMode.

Test Pattern: Select the test pattern from the list. Choices are **PRBS 2[^]31-1, PRBS 2[^]23-1, PRBS 2[^]20-1, PRBS 2[^]15-1, PRBS 2[^]11-1, PRBS 2[^]9-1, 1100, 1010, 1111, 0000, 1in8, and 1in16.**

Invert: Allows the inversion of the test pattern. When enabled, every 0 in the pattern will be changed for 1 and every 1 for 0. For example the pattern 1100 will be sent as 0011. This check box is cleared by default.

RX Live Traffic: Analyzes the line traffic without test pattern thus squelching the pattern loss and bit error indication. This check box is cleared by default meaning that the **Test Pattern** and **Invert** configuration will be used as well for the RX direction.

➤ **Background Traffic**

The Background Traffic is used to generate traffic on the channels/paths/timeslots that are not part of the defined test.

➤ **OTN (Mux Type PT 21)**

Allows the selection of the ODU FLEX multiplexed background traffic. Choices are **AIS, NULL Client (All Zeros), PRBS31 pattern and Unallocated.**

System Tab

Default Test Preferences

For ODU2 background traffic (ODUflex client):

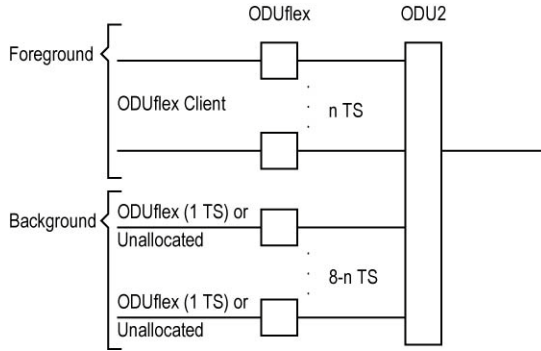

The above example shows that ODU2 that contains ODUflex foreground traffic uses ODUflex (one tributary slot) background or Unallocated traffic.

For ODU2 background traffic (ODU0 client):

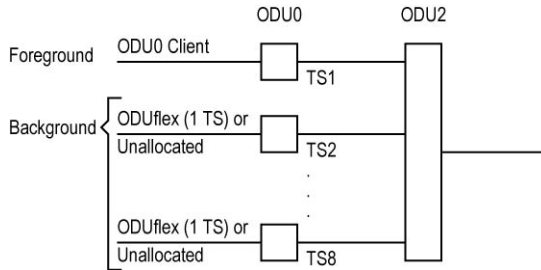

The above example shows that ODU2 that contains ODU0 foreground traffic uses ODUflex (one tributary slot) background or Unallocated traffic.

For ODU3 background traffic (ODUflex client):

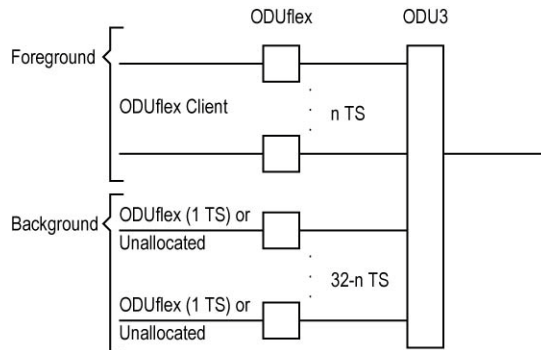

The above example shows that ODU3 that contains ODUflex foreground traffic uses ODUflex (one tributary slot) background or Unallocated traffic.

For ODU3 background traffic (ODU0 client):

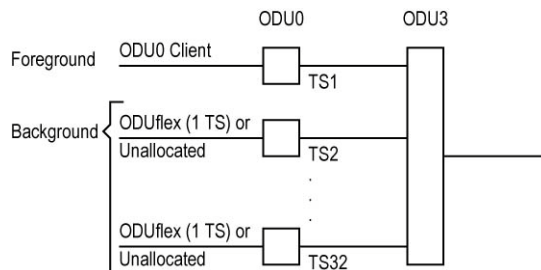

The above example shows that ODU3 that contains ODU0 foreground traffic uses ODUflex (one tributary slot) background or Unallocated traffic.

System Tab

Default Test Preferences

➤ **OTN (Mux Type PT20)**

Allows the selection of the ODU multiplexed background traffic. Choices are **AIS**, **NULL Client (All Zeros)**, and **PRBS31 pattern**.

For ODU1 background traffic (ODU0 client):

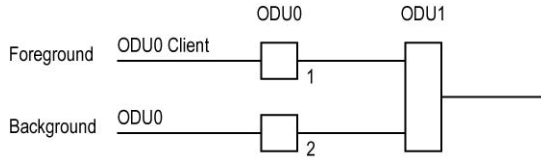

The above example shows that ODU1 that contains ODU0 foreground traffic uses ODU0 background traffic.

For ODU2 background traffic (ODU1 client):

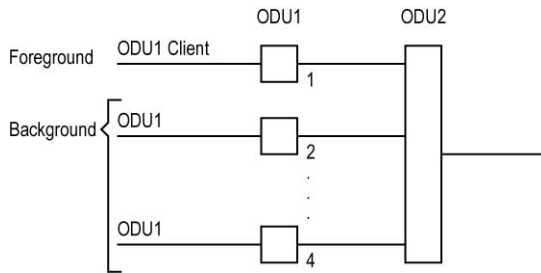

The above example shows that ODU2 that contains ODU1 foreground traffic uses ODU1 background traffic.

For ODU2 background traffic (ODU0 client in ODU1):

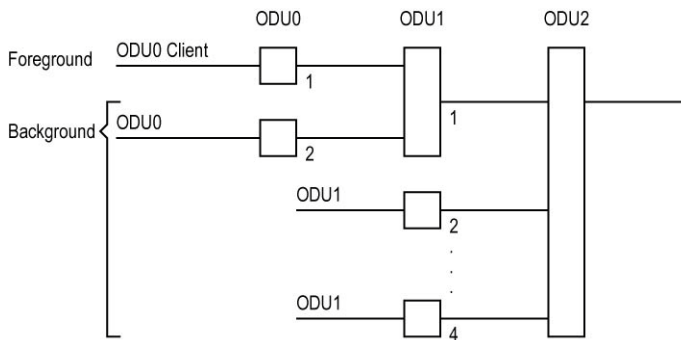

The above example shows that ODU2 that contains ODU0 in ODU1 foreground traffic uses ODU0 background traffic. The remaining tributaries use ODU1 background traffic.

For ODU3 background traffic (ODU1 client):

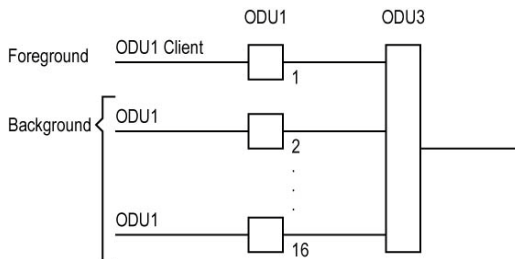

The above example shows that ODU3 that contains ODU1 foreground traffic uses ODU1 background traffic.

System Tab

Default Test Preferences

For ODU3 background traffic (ODU2 client):

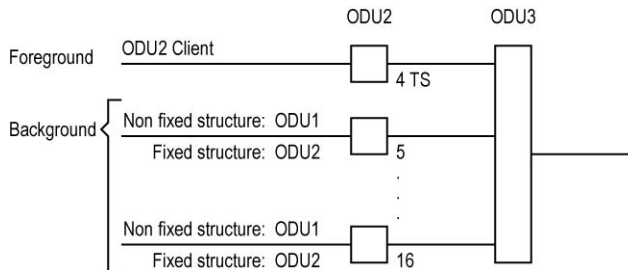

The above example shows that ODU3 that contains ODU2 foreground traffic uses ODU1 or ODU2 background traffic depending on the ODU2 configuration made in the test setup. The foreground structure modulates the background structure.

When the **Fixed Structure** check box is selected, ODU2 background traffic is used.

When the **Fixed Structure** check box is cleared, ODU1 background traffic is used.

For ODU3 background traffic (ODU1 client in ODU2):

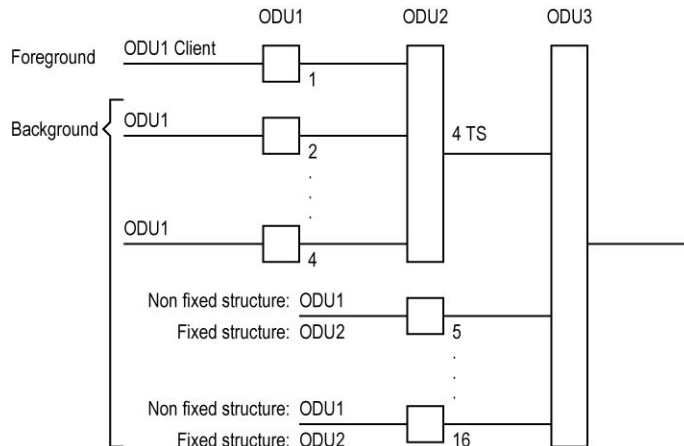

The above example shows that ODU3 that contains ODU1 in ODU2 foreground traffic uses ODU1 background traffic. The remaining tributaries are dependent on the ODU2 configuration made in the test setup. The foreground structure modulates the background structure.

When the **Fixed Structure** check box is selected, ODU2 background traffic is used.

When the **Fixed Structure** check box is cleared, ODU1 background traffic is used.

System Tab

Default Test Preferences

For ODU3 background traffic (ODU0 client in ODU1 in ODU2):

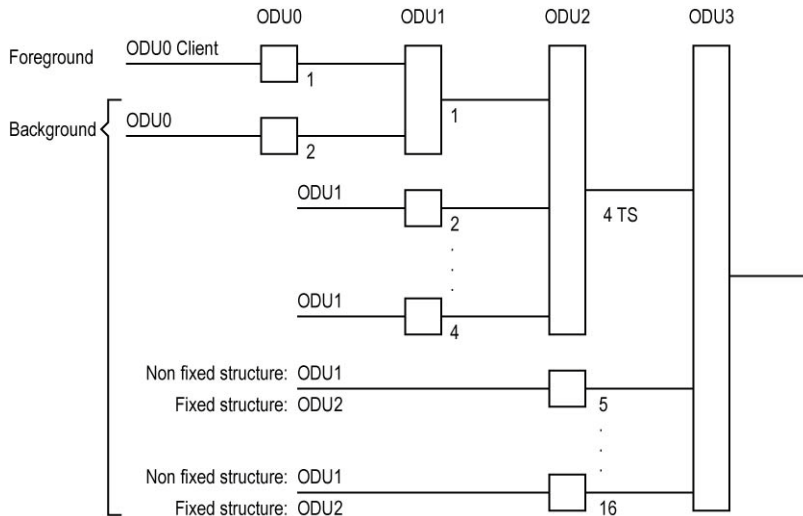

The above example shows that ODU3 that contains ODU0 in ODU1 in ODU2 foreground traffic uses ODU1 background traffic. The remaining tributaries are dependent on the ODU2 configuration made in the test setup:

When the **Fixed Structure** check box is selected, ODU2 background traffic is used.

When the **Fixed Structure** check box is cleared, ODU1 background traffic is used.

► SONET/SDH HOP

Allows the selection of the default high order path background traffic. Choices are **AIS**, **Unequipped**, and **Equipped (PRBS 2^{23-1} pattern)**. The default setting is **Equipped**.

For SONET/SDH rates up to OC-192/STM-64: The following diagram shows a test case data path that is terminated right after SONET/SDH high order path. High order background traffic is automatically adapted to the rate (STS-1, AU-4, or AU-4) signal level for the paths that are not defined in the test case. In the situation where the traffic pattern is replaced by GFP the background traffic remains the same for the STS-1/AU-3/AU-4 that are not involved in the test case data path. In the situation where contiguous concatenation or virtual concatenation is used, the background traffic continues to be applied on the remaining timeslots not involved in the test case data path.

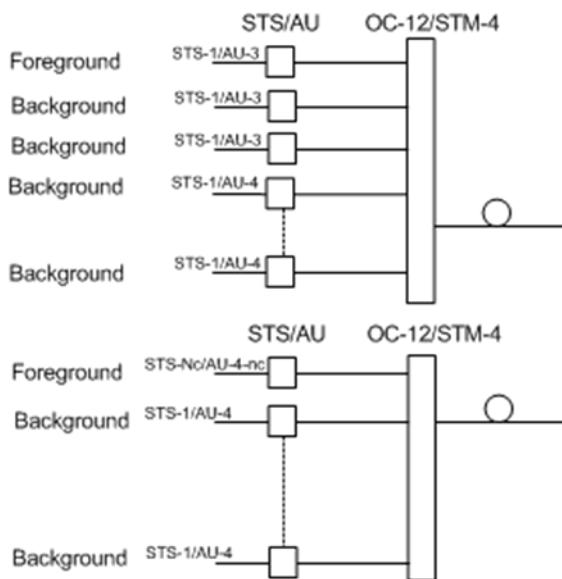

System Tab

Default Test Preferences

For OC-768/STM-256: The following diagrams above show test case data paths that are terminated right after the SONET/SDH high order path using STS-1, AU-3, and AU-4.

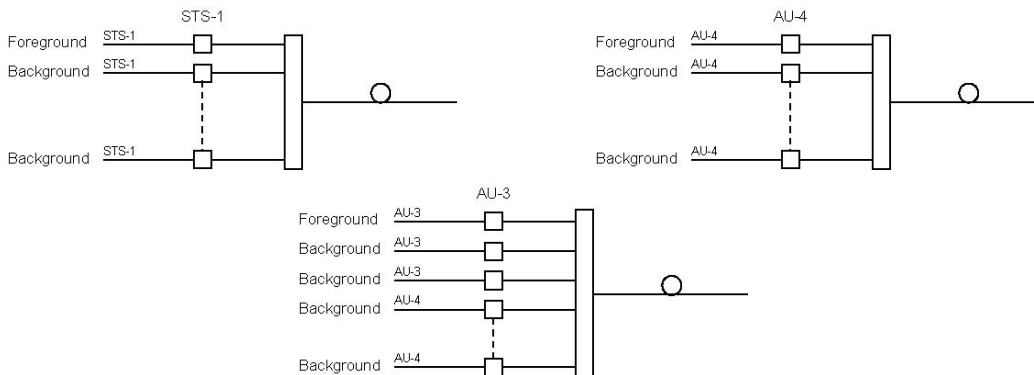

► SONET/SDH LOP

Allows the selection of the default low order path background traffic. Not supported on the IQS-8140. Choices are **AIS**, **Unequipped**, and **Equipped (PRBS 2²³⁻¹ pattern)**. The default setting is **Equipped**.

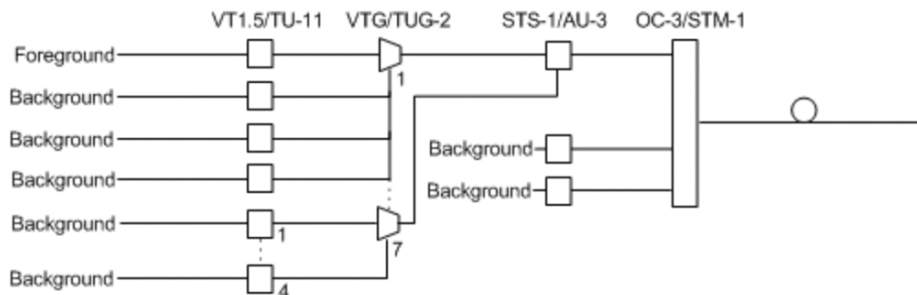

The diagram above shows a test case data path that is terminated at the SONET/SDH low order path. The remaining STS-1 or AU-3 timeslot not involved in the test case are filled with background traffic of STS-1 or AU-3 level depending on the interface being SONET or SDH. At the low order path level, the data path not involved in the data path defined in the test case are filled with a background traffic equivalent to the VT Group (VTG) or Tributary Unit Group (TUG) type defined by the traffic selected in the data path. Further, the remaining VTG or TUG within the high order path, selected in the test case, are respectively filled with traffic of equivalent rate for SONET and SDH data paths.

System Tab

Default Test Preferences

➤ **DSn/PDH**

Allows the selection of the default timeslot background traffic. Not supported on the IQS-8140. Choices are **AIS** and **All zeros**. The default setting is **AIS**.

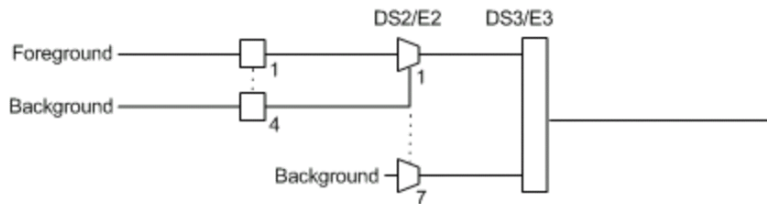

The diagram above shows a test case defined with DSn/PDH traffic where the background traffic is also inserted for the unused timeslots in a test case data path. The insertion is similar to the low order path SONET/SDH terminated signal where the background traffic format inserted uses the same rate as the one defined in the test case data path.

➤ **LCAS Auto-Add at Startup**

Source/Sink Enable: This setting allows to enable by default the **Add Member(s)** at Start for **Source** and **Sink** every time a test is created manually using **Test Setup** or when using **SmartMode**. This setting is disabled by default. Not supported on the IQS-8140.

➤ **OC-192/STM-64 REI-L/MS-REI**

Computation Method: Allows to select the default method used to calculate the REI-L/MS-REI error for OC-192 and STM-64 interfaces. Not supported on the IQS-8140.

Choices are **M1 only** and both **M0 and M1**. The default setting is **M1 only**.

► DS_n Loop Codes

Allows the configuration of 10 DS1 loop code pairs. Press the **Configuration** button to configure each loop code name, Loop-Up and Loop-Down values. The name field allows up to 16 characters long.

Loop-Up and

Loop-Down range is from **000** to **1111111111111111**. The default DS1 loop codes correspond to the DS1 In-Band loop codes (Loop-Up=**10000**, and Loop-Down=**100**).

The **Import** button allows to import loop codes from a previously saved file.

The **Export** button allows to save loop codes to a file.

Name	Loop-Up	Loop-Down
Loop Code 1	10000	100
Loop Code 2	10000	100
Loop Code 3	10000	100
Loop Code 4	10000	100
Loop Code 5	10000	100
Loop Code 6	10000	100
Loop Code 7	10000	100
Loop Code 8	10000	100
Loop Code 9	10000	100
Loop Code 10	10000	100

Module Information

Press **System** and **Module Information**.

The screenshot shows a window titled "Module Information" with three main sections:

- Module Description:** A table with columns "Module ID", "Item", and "Description". The data for Module ID "FTB-8130NGE" includes Location, Slot ID (4), Description, Assembly Hardware Revision (1), Serial Number (AZ90344), and Calibration Date (2006-07-21 03:34:00).
- Installed Software Packages:** A table with columns "Software Product", "Item", and "Description". The data for Software Product "2.6.0.12" includes SUI Version (2.6.0.12), Instrument Version (2.6.0.12), Firmware Version (2.6.0.12), and Boot Version (3.0.0.0).
- Hardware Options:** A table with columns "Device Type", "Item", and "Description". The data for Device Type "SFP" includes Module ID (FTB-8130NGE), Port Number (2), Vendor Name (FINISAR CORP.), Part Number (FTRJ1321P1BTL), Serial Number (PBP014R), Revision Number (A), Connector Type (LC), Speed (OC-3/STM-1, OC-12/STM-4, OC-48/STM-16/OTU1, 1000Base-LX, FC-1X, FC-2X), Type (SONET/SDH: Short Reach, FC: Long Distance), and Wavelength (1310 nm).

➤ **Installed Software Packages:** Indicates the software product version and the **GUI, Instrument, Firmware, and Boot** versions.

➤ **Module Description**

Gives location and description of the IQS-8100 Series module.

➤ **Location**

Slot ID indicates the slot number where the IQS-8100 Series is inserted into. A module description appears after the slot ID when defined in IQS Manager. Refer to **Tools, Remote Control Configuration and Module Description** field from the IQS-600 user guide for more information.

► **Description**

Assembly Hardware Revision: Indicates the product assembly hardware revision.

Serial Number: Indicates the module serial number.

Calibration Date: Indicates the last module's calibration date.

► **Hardware Options**

Gives hardware information related to the SFP/XFP/Transceiver.

- **SFP/XFP/TRN:** The following information is available for the inserted SFP/XFP/Transceiver.

Module ID

Port Number

Vendor Name

Part Number

Serial Number

Revision Number

Connector Type: LC, MT-RJ, SC, ST, FC, etc.

Speed: 100Base-FX/LX, 1000Base-SX, FC-1X, FC-2X, FC-4X, 10G, OC-3/STM-1, OC-12/STM-4, OC-48/STM-16/OTU1, OC-192/STM-64/OTU2, or OC-768/STM-256/OTU3

Type: Reach type: FC: Short Distance, LR/LW, SONET/SDH Short Reach (SR), Intermediate Reach (IR), Long Reach (LR), NRZ, DPSK, etc.

Wavelength: 850nm, 1310nm and 1550nm.

Mode: FC: Multi-Mode(M6) Fiber, SONET/SDH: Single-Mode Fiber (SMF), SONET/SDH Multi-Mode Fiber (MMF), etc.

Software Options

Allows the installation of software options. A software option key will be generated by EXFO for each option bought.

Press **System**, and **Software Option**.

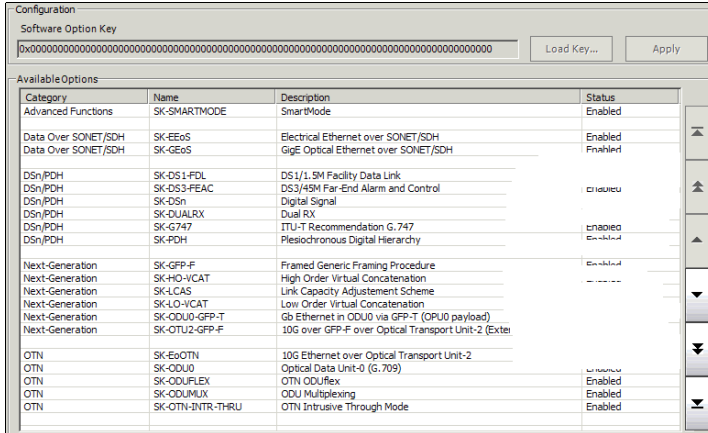

Note: Software option installation is only possible when no test case is created.

Configuration

The software license key can be either entered (typed) or loaded (using the **Load Key** button).

- **Software Option key** allows typing the software option key.
- **Load Key** button allows selecting a file containing the option key.

The default directory is **d:\IQSManager\User Files\SonetSdhAnalyzerG2\Key** under Windows XP and **Documents\User Files\SonetSdhAnalyzerG2\Key** under Windows 8.

- **Apply** button sends the option key to the IQS-8100 Series. A confirmation message will be displayed. The application is automatically closed. The application must be restarted manually.

Available Options

The available software options are listed with the **Status** indicating what software options are installed (enabled) or not (disabled) on the module.0

Category	Name	Description
Advanced Functions	SK-SMARTMODE	SmartMode
	SK-MULTI-CH-SDT ^d	Multi-Channel SDT
Data Over SONET/SDH	SK-EEoS ^a	Electrical Ethernet over SONET/SDH.
	SK-GEoS ^a	GigE Optical Ethernet over SONET/SDH
DSn/PDH	SK-DSn	Digital Signal
	SK-DS1-FDL	DS1/1.5M Facility Data Link
	SK-DS3-FEAC	DS3/45M Far-End Alarm and Control
	SK-DUALRX	Dual DS1/DS3 RX
	SK-G747	ITU-T Recommendation G.747
	SK-PDH	Plesiochronous Digital Hierarchy
Next-Generation	SK-GFP-F ^a	Framed Generic Framing Procedure
	SK-LCAS ^a	Link Capacity Adjustment Scheme
	SK-HO-VCAT ^a	High Order Virtual Concatenation
	SK-LO-VCAT ^a	Lower Order Virtual Concatenation
	SK-ODU0-GFP-T ^d	Gb Ethernet in ODU0 via GFP-T (OPU0 payload)
	SK-OTU2-GFP-F	10G over GFP-F over Optical Transport Unit-2 (Extended OPU2 payload)

System Tab

Software Options

Category	Name	Description
OTN ^b	SK-OTU1	Optical Transport Unit-1 (G.709)
	SK-OTU2 ^c	Optical Transport Unit-2 (G.709)
	SK-EoOTN ^d	10G Ethernet over Optical Transport Unit 2
	SK-OTU2-1e-2e ^c	Optical Transport Unit 2 Overclocked (10G-Ethernet)
	SK-OTU2-1f-2f ^c	Optical Transport Unit 2 Overclocked (10G-Fibre Channel)
	SK-OTU3 ^e	Optical Transport Unit-3 (G.709)
	SK-OTN-INTR-THRU	OTN Intrusive Through Mode
	SK-ODU0 ^e	Optical Data Unit-0 (G.709)
	SK-ODUFLEX ^c	OTN ODUflex
	SK-ODUMUX ^c	ODU Multiplexing
Rate	SK-155M	155 Mbps
	SK-622M	622 Mbps
	SK-2488M	2.488 Gbps
	SK-9953M	9.953 Gbps
	SK-40G ^e	39.81312 Gbps
SONET/SDH	SK-SONET	Synchronous Optical Network
	SK-SDH	Synchronous Digital Hierarchy
	SK-TCM	Tandem Connection Monitoring
	SK-INTR-THRU	Intrusive Through Mode

- a. Only available on the IQS-8120NG, IQS-8120NGE, IQS-8130NG, and IQS-8130NGE models.
- b. Not available on the IQS-8105 and IQS-8115 models.
- c. Only available on the IQS-8130, IQS-8130NG, IQS-8130NGE, and IQS-8140 models.
- d. Only available on the IQS-8120NG, IQS-8130NG, IQS-8120NGE, IQS-8130NGE, and IQS-8140 models.
- e. Only available on the IQS-8140 model.

Remote Control

Note: *Remote Control is not available with IQS-8120NGE and IQS-8130NGE models.*

Press **System**, and **Remote Control**.

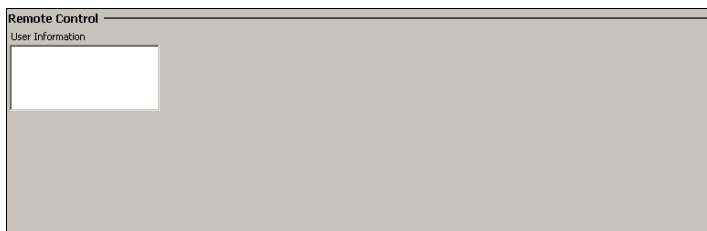

User Information

The User Information field allows a user to leave a message to other users connected on the same module. Up to 80 characters are allowed.

Note: *Refer to the **Visual Guardian Lite** user guide for more information.*

21 Tools Tab

The Tools tab contains a management-scripting tool for the telecom connection.

Script Tab

The scripting tool allows a user to automate test process by creating scripts containing test setup configuration and actions. The scripting tool allows creating, saving, loading, modifying, and running script files. The script creation can be done manually or using the integrated recorder tool (**Script Tool**). Creating and editing a script is only recommended for users with writing knowledge of **Visual Basic .NET (Visual Basic)** programming language.

Press **Tools** and **Script**.

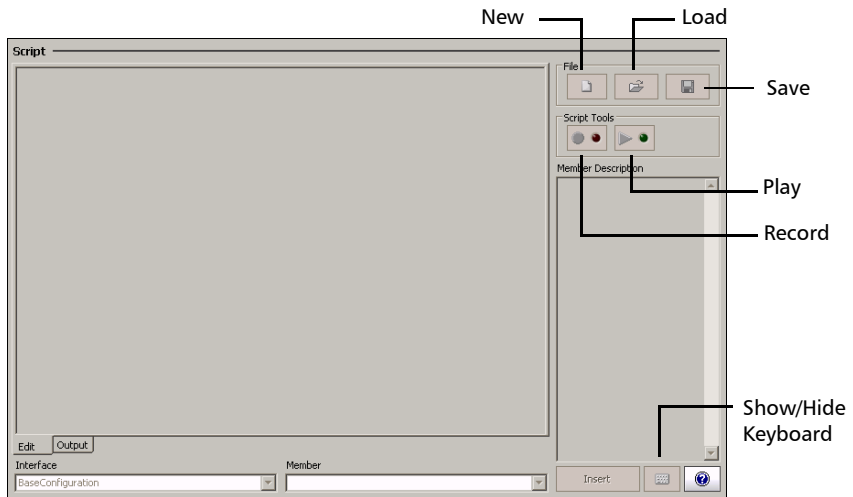

Note: A script is generated to be played for a specific module type in a specific slot. Playing a generated script for a module on a different slot would require manually editing the script file. A script can only be replayed on modules which are the same type as the one on which it was recorded.

Edit

Lists the content of the current script and allows its edition. Users with writing knowledge of **Visual Basic .NET (Visual Basic)** programming language will be able to customize their scripts by inserting delays for example. Note that delays are not automatically inserted during recording.

Output



Gives status of the running script.

File

Allows loading, saving, and generating a new script file.

Note: *The default directory for the script files is:*

d:\IQS Manager\User Files\SonetSdhAnalyzerG2\Scripts under *Windows XP* and **Documents\User Files\SonetSdhAnalyzerG2\Scripts** under *Windows 8*.

-  Press **New** to create a new script and clear the one on the **Edit** tab if exist. Type a new file name in the **File name** field and press **Save**.
-  Press **Load** and select a script file and press **Load**.
-  Press **Save** and select a name for this script file followed by the **scp** extension and press **Save**. The **scp** extension is automatically added when omitted.

Script Tools

Allows automatic generation of scripts by setting step by step the parameters from the Test Setup tab and related test tabs.

-  Press **Record** to start the recording of the script. Press the **File Name** field, a pop-up keyboard is displayed, enter a file name for the new script followed by the **scp** extension, and press **Save**. The **scp** extension is automatically added when omitted. The record button LED is red while recording.

From the **Test Setup** create a test case and set its parameters.

Note: *A test can also be cleared before creating a new one. This is useful to automatically clear the test(s) before creating a new one without having to clear the test manually.*

Once the test is created, the following actions can also be performed and recorded as well.

- From the related test panels, set the parameters for the test.
- Start the test.
- Stop the test.
- Generate a report.
- Save the report.
- Etc.

From the **Script** tab, press **Record** again to end the script recording session and save the script file. The generated script is displayed once the recording ends.

Note: *Only the test case path and its configuration are saved. The GUI settings and results are not saved.*

Tools Tab

Script Tab

Note: *However, for RFC 2544, all selected tests (**Throughput**, **Back-to-Back**, **Frame Loss**, and/or **Latency**) must complete before stopping the recording because tests that didn't run will not be part of the script.*



Press **Play** to run the script that generates the connection and sets the parameters as recorded.

The **Edit** tab automatically switches to the **Output** tab when playing a script allowing to see the script running status.

The script will automatically stop playing when an error occurs or when the script ends.

Pressing **Play** while the script is playing will interrupt (stop) it.

Note: *The **Play** button is not available when there is no script loaded or when a new script is generated and not saved yet.*

Script Line Editing

- **Interface:** Select the **Interface** from the list.
- **Member:** Select the **Member** from the list.
- **Member Description:** Displays the description of the member corresponding to the selected **Interface/Member**.
- **Insert** button: Allows inserting the selected script line. Make sure that the cursor is located where the new script line has to be inserted. Script line insertion is only available when a script is present in the **Edit** tab.
- **Show/Hide Keyboard** button: Allows showing/hiding the keyboard. Press the **show/hide keyboard** button while the keyboard is hidden to pop up the keyboard. Press **show/hide keyboard** button while the keyboard is shown to hide the keyboard.
- **Help** button: Gives help on instrument members and functions.

22 *Maintenance*

To help ensure long, trouble-free operation:

- Always inspect fiber-optic connectors before using them and clean them if necessary.
- Keep the unit free of dust.
- Clean the unit casing and front panel with a cloth slightly dampened with water.
- Store unit at room temperature in a clean and dry area. Keep the unit out of direct sunlight.
- Avoid high humidity or significant temperature fluctuations.
- Avoid unnecessary shocks and vibrations.
- If any liquids are spilled on or into the unit, turn off the power immediately, disconnect from any external power source, remove the batteries and let the unit dry completely.



WARNING

The use of controls, adjustments and procedures, namely for operation and maintenance, other than those specified herein may result in hazardous radiation exposure or impair the protection provided by this unit.

Recalibrating the Unit

EXFO manufacturing and service center calibrations are based on the ISO/IEC 17025 standard (*General Requirements for the Competence of Testing and Calibration Laboratories*). This standard states that calibration documents must not contain a calibration interval and that the user is responsible for determining the re-calibration date according to the actual use of the instrument.

The validity of specifications depends on operating conditions. For example, the calibration validity period can be longer or shorter depending on the intensity of use, environmental conditions and unit maintenance, as well as the specific requirements for your application. All of these elements must be taken into consideration when determining the appropriate calibration interval of this particular EXFO unit.

Under normal use, the recommended interval for your IQS-8100 Series Transport Blazer is: 2 years.

For newly delivered units, EXFO has determined that the storage of this product for up to six months between calibration and shipment does not affect its performance (EXFO Policy PL-03).

To help you with calibration follow-up, EXFO provides a special calibration label that complies with the ISO/IEC 17025 standard and indicates the unit calibration date and provides space to indicate the due date. Unless you have already established a specific calibration interval based on your own empirical data and requirements, EXFO would recommend that the next calibration date be established according to the following equation:

Next calibration date = Date of first usage (if less than six months after the calibration date) + Recommended calibration period (2 years)

To ensure that your unit conforms to the published specifications, calibration may be carried out at an EXFO service center or, depending on the product, at one of EXFO's certified service centers. Calibrations at EXFO are performed using standards traceable to national metrology institutes.

Note: *You may have purchased a FlexCare plan that covers calibrations. See the Service and Repairs section of this user documentation for more information on how to contact the service centers and to see if your plan qualifies.*

Maintenance

Recycling and Disposal (Applies to European Union Only)

Recycling and Disposal (Applies to European Union Only)

For complete recycling/disposal information as per European Directive WEEE 2012/19/UE, visit the EXFO Web site at www.exfo.com/recycle.

23 Troubleshooting

Solving Common Problems

Before calling EXFO's technical support, please read the following usual problems that can occur and their respective solution.

Problem	Possible Cause	Solution
OC-N/STM-N Optical Laser LED is off and the connector is not generating the signal.	<ul style="list-style-type: none">▶ The Laser On option is disabled.▶ The SFP XFP is not compatible with the IQS-8115/20/30.	<ul style="list-style-type: none">▶ Ensure that the Laser button is enabled (On).▶ Ensure to use a compatible SFP/XFP. Refer to <i>OTN/OC-N/STM-N Interface Connections</i> on page 20.
Unable to create a Dual RX test case from a previously save configuration using load configuration.	<ul style="list-style-type: none">▶ The AUX connector is used for synchronization.	<ul style="list-style-type: none">▶ Press System, Clock Synchronization, and select None for RX Interface Type.

Troubleshooting

Contacting the Technical Support Group

Contacting the Technical Support Group

To obtain after-sales service or technical support for this product, contact EXFO at one of the following numbers. The Technical Support Group is available to take your calls from Monday to Friday, 8:00 a.m. to 7:00 p.m. (Eastern Time in North America).

Technical Support Group

400 Godin Avenue
Quebec (Quebec) G1M 2K2
CANADA

1 866 683-0155 (USA and Canada)
Tel.: 1 418 683-5498
Fax: 1 418 683-9224
support@exfo.com

For detailed information about technical support, and for a list of other worldwide locations, visit the EXFO Web site at www.exfo.com.

If you have comments or suggestions about this user documentation, you can send them to customer.feedback.manual@exfo.com.

To accelerate the process, please have information such as the name and the serial number (see the product identification label), as well as a description of your problem, close at hand.

Transportation

Maintain a temperature range within specifications when transporting the unit. Transportation damage can occur from improper handling. The following steps are recommended to minimize the possibility of damage:

- Pack the unit in its original packing material when shipping.
- Avoid high humidity or large temperature fluctuations.
- Keep the unit out of direct sunlight.
- Avoid unnecessary shocks and vibrations.

24 **Warranty**

General Information

EXFO Inc. (EXFO) warrants this equipment against defects in material and workmanship for a period of XX Number of Years XX from the date of original shipment. EXFO also warrants that this equipment will meet applicable specifications under normal use.

During the warranty period, EXFO will, at its discretion, repair, replace, or issue credit for any defective product, as well as verify and adjust the product free of charge should the equipment need to be repaired or if the original calibration is erroneous. If the equipment is sent back for verification of calibration during the warranty period and found to meet all published specifications, EXFO will charge standard calibration fees.

THIS WARRANTY IS IN LIEU OF ALL OTHER WARRANTIES EXPRESSED, IMPLIED, OR STATUTORY, INCLUDING, BUT NOT LIMITED TO, THE IMPLIED WARRANTIES OF MERCHANTABILITY AND FITNESS FOR A PARTICULAR PURPOSE. IN NO EVENT SHALL EXFO BE LIABLE FOR SPECIAL, INCIDENTAL, OR CONSEQUENTIAL DAMAGES.

Liability

EXFO shall not be liable for damages resulting from the use of the product, nor shall be responsible for any failure in the performance of other items to which the product is connected or the operation of any system of which the product may be a part.

EXFO shall not be liable for damages resulting from improper usage or unauthorized modification of the product, its accompanying accessories and software.

Warranty

Exclusions

Exclusions

EXFO reserves the right to make changes in the design or construction of any of its products at any time without incurring obligation to make any changes whatsoever on units purchased. Accessories, including but not limited to fuses, pilot lamps, batteries and universal interfaces (EUI) used with EXFO products are not covered by this warranty.

This warranty excludes failure resulting from: improper use or installation, normal wear and tear, accident, abuse, neglect, fire, water, lightning or other acts of nature, causes external to the product or other factors beyond the control of EXFO.

Certification

EXFO certifies that this equipment met its published specifications at the time of shipment from the factory.

Service and Repairs

EXFO commits to providing product service and repair for five years following the date of purchase.

To send any equipment for service or repair:

1. Call one of EXFO's authorized service centers (see *EXFO Service Centers Worldwide* on page 564). Support personnel will determine if the equipment requires service, repair, or calibration.
2. If equipment must be returned to EXFO or an authorized service center, support personnel will issue a Return Merchandise Authorization (RMA) number and provide an address for return.
3. If possible, back up your data before sending the unit for repair.
4. Pack the equipment in its original shipping material. Be sure to include a statement or report fully detailing the defect and the conditions under which it was observed.
5. Return the equipment, prepaid, to the address given to you by support personnel. Be sure to write the RMA number on the shipping slip. *EXFO will refuse and return any package that does not bear an RMA number.*

Note: *A test setup fee will apply to any returned unit that, after test, is found to meet the applicable specifications.*

After repair, the equipment will be returned with a repair report. If the equipment is not under warranty, you will be invoiced for the cost appearing on this report. EXFO will pay return-to-customer shipping costs for equipment under warranty. Shipping insurance is at your expense.

Routine recalibration is not included in any of the warranty plans. Since calibrations/verifications are not covered by the basic or extended warranties, you may elect to purchase FlexCare Calibration/Verification Packages for a definite period of time. Contact an authorized service center (see *EXFO Service Centers Worldwide* on page 564).

Warranty

EXFO Service Centers Worldwide

EXFO Service Centers Worldwide

If your product requires servicing, contact your nearest authorized service center.

EXFO Headquarters Service Center

400 Godin Avenue
Quebec (Quebec) G1M 2K2
CANADA

1 866 683-0155 (USA and Canada)
Tel.: 1 418 683-5498
Fax: 1 418 683-9224
support@exfo.com

EXFO Europe Service Center

Winchester House, School Lane
Chandlers Ford, Hampshire S053 4DG
ENGLAND

Tel.: +44 2380 246800
Fax: +44 2380 246801
support.europe@exfo.com

EXFO Telecom Equipment (Shenzhen) Ltd.

3rd Floor, Building 10,
Yu Sheng Industrial Park (Gu Shu
Crossing), No. 467,
National Highway 107,
Xixiang, Bao An District,
Shenzhen, China, 518126

Tel: +86 (755) 2955 3100
Fax: +86 (755) 2955 3101
support.asia@exfo.com

To view EXFO's network of partner-operated Certified Service Centers nearest you, please consult EXFO's corporate website for the complete list of service partners:

<http://www.exfo.com/support/services/instrument-services/exfo-service-centers>.

A Specifications

Note: Specifications are subject to change without notice.

Electrical Interfaces for IQS-8105/15/20/30

		DS1	E1/2M	E2/8M	E3/34M	DS3/45M	STS-1e/STM-0e/52M	E4/140M	STS-3e/STM-1e/155M
Tx Pulse Amplitude		2.4 to 3.6 V	3.0 V	2.37 V	2.37 V	1.0 ± 0.1 V	0.36 to 0.85 V	1.0 ± 0.1 Vpp	0.5 V
Tx Pulse Mask		GR-499 Figure 9.5	G.703 Figure 15	G.703 Figure 15	G.703 Figure 16	G.703 Figure 17	DS-3 GR-499 Figure 9.8	G.703 Figure 18/19	STS-3e GR-253 Figure 4-10/4-11
Tx LBO Preamplification		Power dBdsx +0.6 dBdsx (0-133 ft) +1.2 dBdsx (133-266 ft) +1.8 dBdsx (266-399 ft) +2.4 dBdsx (399-533 ft) +3.0 dBdsx (533-655 ft)					0 to 225 ft 225 to 450 ft	0 to 225 ft 255 to 450 ft	0 to 225 ft
Cable Simulation		Power dBdsx -22.5 dBdsx -15.0 dBdsx -7.5 dBdsx 0 dBdsx					450 to 900 (927) ft	450 to 900 (927) ft	
Rx Level Sensitivity		For 772 kHz: TERM: ≤ 26 dB (cable loss only) at 0 dBdsx Tx DSX-MON: ≤ 26 dB (20 dB resistive loss + cable loss ≤ 6 dB) Bridge: ≤ 6 dB (cable loss only) <small>Note: measurement units = dBdsx</small>	For 1024 kHz: TERM: ≤ 6 dB (cable loss only) MON: ≤ 25 dB (20 dB resistive loss + cable loss ≤ 6 dB) Bridge: ≤ 6 dB (cable loss only) <small>Note: measurement units = dBm</small>	For 1024 kHz: TERM: ≤ 6 dB (cable loss only) MON: ≤ 26 dB (20 dB resistive loss + cable loss ≤ 6 dB) Bridge: ≤ 6 dB (cable loss only) <small>Note: measurement units = dBm</small>	For 4224 kHz: TERM: ≤ 6 dB (cable loss only) MON: ≤ 26 dB (20 dB resistive loss + cable loss ≤ 6 dB) <small>Note: measurement units = dBm</small>	For 17184 MHz: TERM: ≤ 12 dB (coaxial cable loss only) MON: ≤ 26 dB (20 dB resistive loss + cable loss ≤ 6 dB) <small>Note: measurement units = dBm</small>	For 22368 MHz: TERM: ≤ 10 dB (cable loss only) DSX-MON: ≤ 26.5 dB (21.5 dB resistive loss + cable loss ≤ 5 dB) <small>Note: measurement units = dBm</small>	For 25.92 MHz: TERM: ≤ 10 dB (coaxial cable loss only) MON: ≤ 25 dB (20 dB resistive loss + cable loss ≤ 5 dB) <small>Note: measurement units = dBm</small>	For 70 MHz: TERM: ≤ 12 dB (coaxial cable loss only) MON: ≤ 26 dB (20 dB resistive loss + cable loss ≤ 6 dB) <small>Note: measurement units = dBm</small>
Transmit Bit Rate		1.544 Mbit/s ± 4.6 ppm	2.048 Mbit/s ± 4.6 ppm	2.048 Mbit/s ± 4.6 ppm	8.448 Mbit/s ± 4.6 ppm	34.368 Mbit/s ± 4.6 ppm	44.736 Mbit/s ± 4.6 ppm	51.84 Mbit/s ± 4.6 ppm	139.264 Mbit/s ± 4.6 ppm
Receive Bit Rate		1.544 Mbit/s ± 140 ppm	2.048 Mbit/s ± 100 ppm	2.048 Mbit/s ± 100 ppm	8.448 Mbit/s ± 100 ppm	34.368 Mbit/s ± 100 ppm	44.736 Mbit/s ± 100 ppm	51.84 Mbit/s ± 100 ppm	139.264 Mbit/s ± 100 ppm
Measurement Accuracy	Frequency	±4.6 ppm	±4.6 ppm	±4.6 ppm	±4.6 ppm	±4.6 ppm	±4.6 ppm	±4.6 ppm	±4.6 ppm
	Electrical Power	DSX range: ±1.0 dB DSX-MON range: ±2.0 dB	NORMAL: ±1.0 dB MONITOR: ±2.0 dB	NORMAL: ±1.0 dB MONITOR: ±2.0 dB	NORMAL: ±1.0 dB MONITOR: ±2.0 dB	NORMAL: ±1.0 dB MONITOR: ±2.0 dB	DSX range: ±1.0 dB DSX-MON range: ±2.0 dB	DSX range: ±1.0 dB DSX-MON range: ±2.0 dB	NORMAL: ±1.0 dB MONITOR: ±2.0 dB
Peak-to-Peak Voltage		±10% down to 500 mVpp	±10% down to 500 mVpp	±10% down to 500 mVpp	±10% down to 400 mVpp	±10% down to 200 mVpp	±10% down to 200 mVpp	±10% down to 200 mVpp	±10% down to 200 mVpp
Frequency Offset Generation		1.544 Mbit/s ± 140 ppm	2.048 Mbit/s ± 70 ppm	2.048 Mbit/s ± 70 ppm	8.448 Mbit/s ± 50 ppm	34.368 Mbit/s ± 50 ppm	44.736 Mbit/s ± 50 ppm	51.84 Mbit/s ± 50 ppm	139.264 Mbit/s ± 50 ppm
Intrinsic Jitter (Tj)		ANSI T1.403 section 6.3 GR-499 section 7.3	G.823 section 5.1	G.823 section 5.1	G.823 section 5.1	G.823 section 5.1 G.751 section 2.3	GR-449 section 7.3 (categories I and II)	GR-253 section 5.6.2.2 (category II)	G.823 section 5.1
Input Jitter Tolerance		AT&T PUB 62411 GR-499 section 7.3	G.823 section 7.1	G.823 section 7.1	G.823 section 7.1	G.823 section 7.1	GR-449 section 7.3 (categories I and II)	GR-253 section 5.6.2.2 (category II)	G.823 section 7.1 G.751 section 3.3
Line Coding		AMI and B8ZS	AMI and HDB3	AMI and HDB3	HDB3	HDB3	B3ZS	B3ZS	CM1
Input Impedance (Resistive Termination)		100 ohms ± 5%, balanced	120 ohms ± 5%, balanced	75 ohms ± 5%, unbalanced	75 ohms ± 5%, unbalanced	75 ohms ± 5%, unbalanced	75 ohms ± 5%, unbalanced	75 ohms ± 5%, unbalanced	75 ohms ± 5%, unbalanced
Connector Type		BANTAM and RJ-48C	BANTAM and RJ-48C	BNC	BNC	BNC	BNC	BNC	BNC

Specifications

Optical Interfaces

Optical Interfaces

Optical Interface for IQS-8105/15/20/30

Refer to page 20 for more information on supported SFP/XFPs.

	OC3/STM1				OC12/STM4				OC48/STM16/OTU1				OC192/STM64/OTU2		
	15 km; 1310 nm	40 km; 1310 nm	40 km; 1550 nm	80 km; 1550 nm	15 km; 1310 nm	40 km; 1310 nm	40 km; 1550 nm	80 km; 1550 nm	15 km; 1310 nm	40 km; 1310 nm	40 km; 1550 nm	80 km; 1550 nm	10 km; 1310 nm	40 km; 1550 nm	80 km; 1550 nm
Level Tx	-5 to 0 dBm	-2 to +3 dBm	-5 to 0 dBm	-2 to +3 dBm	-5 to 0 dBm	-2 to +3 dBm	-5 to 0 dBm	-2 to +3 dBm	-5 to 0 dBm	-2 to +3 dBm	-5 to 0 dBm	-2 to +3 dBm	-6 to -1 dBm	-1 to +3 dBm	0 to +4 dBm
Rx Operating Range	-23 to -10 dBm	-30 to -15 dBm	-23 to -10 dBm	-30 to -15 dBm	-22 to 0 dBm	-27 to -9 dBm	-22 to 0 dBm	-29 to -9 dBm	-18 to 0 dBm	-27 to -9 dBm	-18 to 0 dBm	-28 to -9 dBm	-11 to -1 dBm	-14 to -1 dBm	-24 to -9 dBm
Transmit Bit Rate	155.52 Mbit/s ± 4.6 ppm				622.08 Mbit/s ± 4.6 ppm				2.48832 Gbit/s ± 4.6 ppm 2.66608 Gbit/s ± 4.6 ppm (OTU1)				9.95328 Gbit/s ± 4.6 ppm (OC-192/STM64) 10.70922 Gbit/s ± 4.6 ppm (OTU2) 11.0491 Gbit/s ± 4.6 ppm (OTU1a) 11.0987 Gbit/s ± 4.6 ppm (OTU2a)		
Receive Bit Rate	155.52 Mbit/s ± 100 ppm				622.08 Mbit/s ± 100 ppm				2.48832 Gbit/s ± 100 ppm 2.66608 Gbit/s ± 100 ppm (OTU1)				9.95328 Gbit/s ± 4.6 ppm (OC-192/STM64) 10.70922 Gbit/s ± 4.6 ppm (OTU2) 11.0491 Gbit/s ± 4.6 ppm (OTU1a) 11.0987 Gbit/s ± 4.6 ppm (OTU2a)		
Operational Wavelength Range	1261 to 1360 nm	1263 to 1360 nm	1430 to 1560 nm	1480 to 1560 nm	1270 to 1360 nm	1280 to 1335 nm	1430 to 1560 nm	1480 to 1560 nm	1260 to 1360 nm	1280 to 1335 nm	1430 to 1560 nm	1500 to 1560 nm	1290 to 1330 nm	1530 to 1565 nm	1530 to 1565 nm
Spectral Width	1 nm (-20 dB)				1 nm (-20 dB)				1 nm (-20 dB)				1 nm (-20 dB)		
Frequency Offset Correction	± 50 ppm				± 50 ppm				± 50 ppm				± 50 ppm ¹		
Measurement Accuracy	± 4.6 ppm ± 2 dB				± 4.6 ppm ± 2 dB				± 4.6 ppm ± 2 dB				± 4.6 ppm ± 2 dB		
Maximum Rx before Damage ²	+ 3 dBm				+ 3 dBm				+ 3 dBm				+ 3 dBm		
Filter Compliance	GR-253 (SONET) G.959 (SDH)				GR-253 (SONET) G.959 (SDH)				GR-253 (SONET) G.959 (SDH)				GR-253 (SONET) G.959 (SDH)		
Line Coding	NRZ				NRZ				NRZ				NRZ		
Eye Safety	SFP/XFP transceivers comply with IEC 60825 and 21 CFR 1040.10 (except for deviations pursuant to Laser Notice No. 50, dated July 2001), for Class 1 or 1M lasers.														
Connector ³	Dual LC				Dual LC				Dual LC				Dual LC		
Transceiver Type ⁴	SFP				SFP				SFP				XFP		

Notes

- In order not to exceed the maximum receiver power level before damage, an attenuator must be used.
- External adaptors can be used for other type of connectors. For example FC/PC.
- SFP/XFP Compliance: The IQS-8100 Series selected SFP/XFP shall meet the requirements stated in the "Small Form-factor Pluggable (SFP) Transceiver MultiSource Agreement (MSA)". The IQS-8100 Series selected SFP/XFP shall meet the requirements stated in the "Specification for Diagnostic Monitoring Interface for Optical Xcvrs".

Optical Interface for IQS-8140

OC-768/STM-256/OTU3			
Line coding	NRZ	NRZ-DPSK	
Level Tx (dBm)	0 to 3	4 to 7.5	
Rx operating range (dBm)	-5 to 3	3 to 8	
Transmit bit rate	39.81312 Gbit/s ± 4.6 ppm	39.81312 Gbit/s ± 4.6 ppm	
	43.01841 Gbit/s ± 4.6 ppm (OTU3)	43.01841 Gbit/s ± 4.6 ppm (OTU3)	
Receive bit rate	39.81312 Gbit/s ± 100 ppm	39.81312 Gbit/s ± 100 ppm	
	43.01841 Gbit/s ± 100 ppm (OTU3)	43.01841 Gbit/s ± 100 ppm (OTU3)	
Operational wavelength range (nm)	1530 to 1565	1528.77 to 1563.86	
Frequency offset generation	39.81312 Gbit/s ± 50 ppm	39.81312 Gbit/s ± 50 ppm	
	43.01841 Gbit/s ± 50 ppm	43.01841 Gbit/s ± 50 ppm	
Measurement accuracy (uncertainty)			
	Frequency (ppm)	±4.6	±4.6
	Optical power (dB)	±2	±1.3 (-6 to 5)
Rx overload (dBm)	3	8	
Rx damage level ^a (dBm)	6	10	
Jitter compliance	GR-253 (SONET)	GR-253 (SONET)	
	G.958 (SDH)	G.958 (SDH)	
	G.8251 (OTN)	G.8251 (OTN)	
Line coding compliance	G.693 VSR 2000 compliant	NRZ-DPSK	
Connector	SC, FC, LC, ST	SC, FC, LC, ST	

NOTE

a. In order not to exceed the maximum receiver power level before damage, an attenuator must be used.

Specifications

Synchronization Interfaces for IQS-8105/15/20/30

Synchronization Interfaces for IQS-8105/15/20/30

SYNCHRONISATION INTERFACES				
	External Clock DS1/1.5M	External Clock E1/2M	External Clock E1/2M	Trigger 2 MHz
Tx Pulse Amplitude	2.4 to 3.6 V	3.0 V	2.37 V	0.75 to 1.5 V
Tx Pulse Mask	GR-499 figure 9.5	G.703 figure 15	G.703 figure 15	G.703 figure 20
Tx LBO Preamplification	Typical power dBdtx +0.6 dBdtx (0-133 ft) +1.2 dBdtx (133-266 ft) +1.8 dBdtx (266-399 ft) +2.4 dBdtx (399-533 ft) +3.0 dBdtx (533-655 ft)			
Rx Level Sensitivity	TERM: ≤ 6 dB (cable loss only) (at 772 kHz for T1) DSX/MON: ≤ 26 dB (20 dB resistive loss + cable loss ≤ 6 dB) Bridge: ≤ 6 dB (cable loss only)	TERM: ≤ 6 dB (cable loss only) MON: ≤ 26 dB (20 dB resistive loss + cable loss ≤ 6 dB) Bridge: ≤ 6 dB (cable loss only)	TERM: ≤ 6 dB (cable loss only) MON: ≤ 26 dB (resistive loss + cable loss ≤ 6 dB) Bridge: ≤ 6 dB (cable loss only)	≤ 6 dB (cable loss only)
Transmission Bit Rate	1.544 Mbit/s \pm 4.6 ppm	2.048 Mbit/s \pm 4.6 ppm	2.048 Mbit/s \pm 4.6 ppm	
Reception Bit Rate	1.544 Mbit/s \pm 50 ppm	2.048 Mbit/s \pm 50 ppm	2.048 Mbit/s \pm 50 ppm	
Intrinsic Jitter (Tj)	ANSI T1.403 section 6.3 GR-499 section 7.3	G.823 section 6.1	G.823 section 6.1	G.703 table 11
Input Jitter Tolerance	AT&T PUB 62411 GR-499 SECTION 7.3	G.823 section 7.2 G.813	G.823 section 7.2 G.813	
Line Coding	AMI and B8ZS	AMI and HDB3	AMI and HDB3	
Input Impedance (Resistive Termination)	75 ohms \pm 5%, unbalanced	75 ohms \pm 5%, unbalanced	75 ohms \pm 5%, unbalanced	75 ohms \pm 5%, unbalanced
Connector Type	BNC ^a	BNC ^a	BNC	BNC

NOTES

- Adaptation cable required for BANTAM.
- SFP/XFP transceivers comply with IEC 60825 and 21 CFR 1040.10 (except for deviations pursuant to Laser Notice 50, dated July, 2001), for Class 1 or 1M lasers.

REF-OUT INTERFACE					
Parameter	Value				
Tx pulse amplitude	600 \pm 150 mVpp				
Transmission frequency	SONET/SDH/ 10 GbE WAN	10 GbE LAN	OTU2	OTU1e	OTU2e
Clock divider = 16	622.08 MHz	644.63 MHz	669.33 MHz	690.57 MHz	693.48 MHz
Clock divider = 32	311.04 MHz	322.266 MHz	334.66 MHz	345.29 MHz	346.74 MHz
Clock divider = 64	155.52 MHz	161.133 MHz	167.23 MHz	172.64 MHz	173.37 MHz
Output configuration	AC coupled				
Load impedance	50 ohms				
Maximum cable length	3 meters				
Connector Type	SMA				

Synchronisation Interfaces for IQS-8140

SYNCHRONIZATION INTERFACES				
	External Clock DS1/1.5M	External Clock E1/2M	External Clock E1/2M	2 MHz (Trigger)
Tx pulse amplitude	2.4 to 3.6 V	3.0 V	2.37 V	0.75 to 1.5 V
Tx pulse mask	GR-499 figure 9.5	G.703 figure 15	G.703 figure 15	G.703 figure 20
Tx LBO preamplification	Typical power dBdtx +0.6 dBdtx (0-133 ft) +1.2 dBdtx (133-266 ft) +1.8 dBdtx (266-399 ft) +2.4 dBdtx (399-533 ft) +3.0 dBdtx (533-655 ft)			
Rx level sensitivity	TERM: ≤ 6 dB (cable loss only) (at 772 kHz for T1) DSX-MON: ≤ 26 dB (20 dB resistive loss + cable loss ≤ 6 dB) Bridge: ≤ 6 dB (cable loss only)	TERM: ≤ 6 dB (cable loss only) MON: ≤ 26 dB (20 dB resistive loss + cable loss ≤ 6 dB) Bridge: ≤ 6 dB (cable loss only)	TERM: ≤ 6 dB (cable loss only) MON: ≤ 26 dB (resistive loss + cable loss ≤ 6 dB) Bridge: ≤ 6 dB (cable loss only)	≤ 6 dB (cable loss only)
Transmission bit rate	1.544 Mbit/s \pm 4.6 ppm	2.048 Mbit/s \pm 4.6 ppm	2.048 Mbit/s \pm 4.6 ppm	
Reception bit rate	1.544 Mbit/s \pm 50 ppm	2.048 Mbit/s \pm 50 ppm	2.048 Mbit/s \pm 50 ppm	
Intrinsic jitter (Tx)	ANSI T1.403 section 6.3 GR-499 section 7.3	G.823 section 6.1	G.823 section 6.1	G.703 table 11
Input jitter tolerance	AT&T PUB 62411 GR-499 SECTION 7.3	G.823 section 7.2 G.813	G.823 section 7.2 G.813	
Line coding	AMI and B8ZS	AMI and HDB3	AMI and HDB3	
Input impedance (resistive termination)	75 Ω \pm 5 %, unbalanced	75 Ω \pm 5 %, unbalanced	75 Ω \pm 5 %, unbalanced	75 Ω \pm 5 %, unbalanced
Connector type	BNC ^a	BNC ^a	BNC	BNC

REF-OUT INTERFACE		
	SONET/SDH	OTN
Parameter	Value	Value
Tx pulse amplitude	600 \pm 200 mVpp	600 \pm 200 mVpp
Transmission frequency	2.48932 GHz	2.68865 GHz
Output configuration	AC coupled	AC coupled
Load impedance	50 Ω	50 Ω
Maximum cable length	1 m	1 m
Connector type	SMA	SMA

NOTE

a. Adaptation cable required for BANTAM.

Ethernet Add/Drop Interfaces for IQS-8105/15/20/30

ETHERNET ADD/DROP INTERFACE	
10/100/1000 Base-T (Add/Drop)	
Compliance	10 Mbit/s: IEEE 802.3 section 14
	100 Mbit/s: IEEE 802.3 section 25
	1000 Mbit/s: IEEE 802.3 section 40
Connector	RJ-45 Ethernet
Gigabit Ethernet (Add/Drop)	
Interface/connector	SFP/Dual LC
Compliance	1000 Mbit/s: IEEE 802.3 Section 40 ^b
Wavelength/Max Tx level	850, 1310 nm/-3 dBm
	1550 nm/+5 dBm

Specifications

Ethernet Interfaces

Ethernet Interfaces

ELECTRICAL INTERFACES

	10Base-T	100Base-T	1000Base-T
Tx bit rate	10 Mbit/s	125 Mbit/s	1 Gbit/s
Tx accuracy (ppm)	±100	±100	±100
Rx bit rate	10 Mbit/s	125 Mbit/s	1 Gbit/s
Rx measurement accuracy (ppm)	±4.6	±4.6	±4.6
Duplex mode	Half and full duplex	Half and full duplex	Full duplex
Jitter compliance	IEEE 802.3	IEEE 802.3	IEEE 802.3
Connector	RJ-45	RJ-45	RJ-45
Maximum reach (m)	100	100	100

100 Mbit/s AND GigE OPTICAL INTERFACES

	100Base-FX	100Base-LX	1000Base-SX	1000Base-LX	1000Base-ZX
Wavelength (nm)	1310	1310	850	1310	1550
Tx level (dBm)	-20 to -15	-15 to -8	-9 to -3	-9.5 to -3	0 to +5
Rx level sensitivity (dBm)	-31	-28 to -8	-20	-22	-22
Maximum reach	2 km	15 km	550 m	10 km	80 km
Transmission bit rate (Gbit/s)	0.125	0.125	1.25	1.25	1.25
Reception bit rate (Gbit/s)	0.125	0.125	1.25	1.25	1.25
Tx operational wavelength range (nm)	1280 to 1380	1261 to 1360	830 to 860	1270 to 1360	1540 to 1570
Measurement accuracy					
Frequency (ppm)	±4.6	±4.6	±4.6	±4.6	±4.6
Optical power (dB)	±2	±2	±2	±2	±2
Maximum Rx before damage (dBm)	+3	+3	+6	+6	+6
Jitter compliance	ANSI X3.166	IEEE 802.3	IEEE 802.3	IEEE 802.3	IEEE 802.3
Ethernet classification	ANSI X3.166	IEEE 802.3	IEEE 802.3	IEEE 802.3	IEEE 802.3
Laser type	LED	FP	VCSEL	FP	DFB
Eye safety	CLASS 1	CLASS 1	CLASS 1	CLASS 1	CLASS 1
Connector	LC	LC	LC	LC	LC
Transceiver type	SFP	SFP	SFP	SFP	SFP

10 GigE OPTICAL INTERFACES

	10GBASE-SW	10GBASE-SR	10GBASE-LW	10GBASE-LR	10GBASE-EW	10GBASE-ER
Wavelength (nm)	850	850	1310	1310	1550	1550
Multimode	Multimode	Multimode	Singlemode	Singlemode	Singlemode	Singlemode
Tx level (802.3ae-compliant) (dBm)	-7.3 to -1	-7.3 to -1	-8.2 to +0.5	-8.2 to +0.5	-4.7 to +4.0	-4.7 to +4.0
Rx level sensitivity (dBm)	-9.9 to -1.0	-9.9 to -1.0	-14.4 to +0.5	-14.4 to +0.5	-15.8 to -1.0	-15.8 to -1.0
Transmission bit rate	9.95328 Gbit/s ± 4.6 ppm ^a	10.3125 Gbit/s ± 4.6 ppm ^a	9.95328 Gbit/s ± 4.6 ppm ^a	10.3125 Gbit/s ± 4.6 ppm ^a	9.95328 Gbit/s ± 4.6 ppm ^a	10.3125 Gbit/s ± 4.6 ppm ^a
Reception bit rate	9.95328 Gbit/s ± 135 ppm	10.3125 Gbit/s ± 135 ppm	9.95328 Gbit/s ± 135 ppm	10.3125 Gbit/s ± 135 ppm	9.95328 Gbit/s ± 135 ppm	10.3125 Gbit/s ± 135 ppm
Tx operational wavelength range (802.3ae-compliant) (nm)	840 to 860	840 to 860	1260 to 1355	1260 to 1355	1530 to 1565	1530 to 1565
Measurement accuracy						
Frequency (ppm)	±4.6	±4.6	±4.6	±4.6	±4.6	±4.6
Optical power (dB)	±2	±2	±2	±2	±2	±2
Maximum Rx before damage (dBm)	0	0	+1.5	+1.5	+4.0	+4.0
Jitter compliance	IEEE 802.3ae	IEEE 802.3ae	IEEE 802.3ae	IEEE 802.3ae	IEEE 802.3ae	IEEE 802.3ae
Ethernet classification	IEEE 802.3ae	IEEE 802.3ae	IEEE 802.3ae	IEEE 802.3ae	IEEE 802.3ae	IEEE 802.3ae
Laser type	VCSEL	VCSEL	DFB	DFB	EML	EML
Eye safety	Class 1 laser; complies with 21 CFR 1040.10 and IEC 60825-1	Class 1 laser; complies with 21 CFR 1040.10 and IEC 60825-1	Class 1 laser; complies with 21 CFR 1040.10 and IEC 60825-1	Class 1 laser; complies with 21 CFR 1040.10 and IEC 60825-1	Class 1M laser; complies with 21 CFR 1040.10 and IEC 60825-1	Class 1M laser; complies with 21 CFR 1040.10 and IEC 60825-1
Connector	Duplex LC	Duplex LC	Duplex LC	Duplex LC	Duplex LC	Duplex LC
Transceiver type (compliant with XFP MSA)	XFP	XFP	XFP	XFP	XFP	XFP

NOTE

a. When clocking is in internal mode.

General Specifications

For IQS-8105/15/20/30

	IQS-8115, IQS-8120, IQS-8120NG, IQS-8130, IQS-8130NG	IQS-8105
Size (H x W x D)	51 x 96 x 288 mm (2" x 3 3/4" x 11 3/8")	25 x 96 x 288 mm (1" x 3 3/4" x 11 3/8")
Weight (without transceiver)	0.9 kg (2.0 lb)	0.5 kg (1.1 lb)
Temperature - operating - storing	0 °C to 40 °C (32 °F to 104 °F) -40 °C to 60 °C (-40 °F to 140 °F)	

For IQS-8140

GENERAL SPECIFICATIONS	
Typical weight	2.5 kg (5.5 lb)
Size (H x W x D)	96 mm x 152 mm x 292 mm (3 3/4 in x 6 in x 11 1/2 in)
Temperature	operating 0 °C to 40 °C (32 °F to 104 °F)
	storage -40 °C to 60 °C (-40 °F to 140 °F)

B *Glossary*

SONET/DSn/SDH/PDH Nomenclature

The GUI will use the International or European nomenclature based on the SONET and SDH software options installed on the IQS-8100 Series.

Software option	Nomenclature
SONET only	International
SDH only	European
SONET and SDH	International

Signal Rates

Rate	SONET/DSn	SDH/PDH	
		International	European
1.544 Mbps	DS1	-	1.5M
2.048 Mbps	-	E1	2M
8.448 Mbps	-	E2	8M
34.368 Mbps	-	E3	34M
44.736 Mbps	DS3	-	45M
51.84 Mbps	STS-1e	STM-0e	52M
139.264 Mbps	-	E4	140M
155.52 Mbps	STS-3e / OC-3	STM-1e / STM-1	155M / STM-1
622.08 Mbps	OC-12	STM-4	STM-4
2.48832 Gbps	OC-48	STM-16	STM-16
2.666057143 Gbps	OTU1	OTU1	OTU1
9.95328 Gbps	OC-192	STM-64	STM-64

Glossary

SONET/SDH High and LowOrder Path Nomenclature

Rate	Signal
10.709225316 Gbps	OTU2
11.0491 Gbps	OTU1e
11.0957 Gbps	OTU2e
11.2701 Gbps	OTU1f
11.3176 Gbps	OTU2f
39.81312 Gbps	OC-768
43.018413559 Gbps	OTU3

SONET/SDH High and LowOrder Path Nomenclature

Path Type	SDH	SONET
High Order	AU-3	STS-1
	AU-4	STS-3c
	AU-4-4c	STS-12c
	AU-4-16c	STS-48c
	AU-4-64c	STS-192c
	AU-4-256c	STS-768c
Low Order	TUG-3	-
	TUG-2	VTG
	TU-11	VT1.5
	TU-12	VT2
	TU-2	VT6
	TU-3	-

SONET/SDH Alarms and Errors Nomenclature

Layer	SONET	SDH
Physical	BPV	CV
Section / Regenerator Section	LOF	LOF
	SEF	OOF
	TIM-S	RS-TIM
	B1	B1
Line / Multiplex Section	AIS-L	MS-AIS
	RDI-L	MS-RDI
	B2	B2
	REI-L	MS-REI
High Order Path	AIS-P	AU-AIS
	LOP-P	AU-LOP
	LOM	H4-LOM
	PDI-P	-
	RDI-P	HP-RDI
	ERDI-PCD	ERDI-CD
	ERDI-PPD	ERDI-PD
	ERDI-PSD	ERDI-SD
	PLM-P	HP-PLM
	UNEQ-P	HP-UNEQ
	TIM-P	HP-TIM
	B3	B3
	REI-P	HP-REI

Glossary

SONET/SDH Alarms and Errors Nomenclature

Layer	SONET	SDH
Low Order Path	AIS-V	TU-AIS
	LOP-V	TU-LOP
	RDI-V	LP-RDI
	ERDI-VCD	ERDI-CD
	ERDI-VPD	ERDI-PD
	ERDI-VSD	ERDI-SD
	RFI-V	LP-RFI
	UNEQ-V	LP-UNEQ
	TIM-V	LP-TIM
	PLM-V	LP-PLM
	BIP-2	BIP-2
	REI-V	LP-REI

Acronym List

140M	Digital signal (139.264 Mbps)
155M	Digital signal (155.52 Mbps)
2M	Digital signal (2.048 Mbps)
34M	Digital signal (34.368 Mbps)
45M	Digital signal (44.736 Mbps)
52M	Digital signal (51.84 Mbps)
8M	Digital signal (8.448 Mbps)
?	Help
_	Minimize

A

A	Ampere
AC	Alternating Current
AcPT	Accepted Payload Type
AcSTAT	Accepted STAT information in the TCMi
AIS	Alarm Indication Signal
AIS-L	Alarm Indication Signal - Line
AIS-P	Alarm Indication Signal - Path
AIS-V	Alarm Indication Signal - VT
AMI	Alternate Mark Inversion
ANSI	American National Standards Institute
APId	Access Point Identifier
APS	Automatic Protection Switching

Glossary

Acronym List

AS	Available Second
ASCII	American Standard Code for Information Interchange
ATM	Asynchronous Transfer Mode
AU-AIS	Administrative Unit - Alarm Indication Signal
AU-LOP	Administrative Unit - Loss of Pointer
AU-n	Administrative Unit-n
AUG	Administrative Unit Group
AUX	Auxiliary
AWG	American Wire Gage

B

B1	BIP-8 - Section
B2	BIP-8 - Line
B3	BIP-8 - Path
B3ZS	Bipolar with 3 zero substitution
B8ZS	Bipolar with 8 zero substitution
BBE	Background Block Error
BBER	Background Block Error Ratio
BDI	Backward Defect Indication
BEI	Backward Error Indication
BER	Bit Error Rate
BIAE	Backward Incoming Alignment Error
BIP	Bit-Interleaved Parity
BIP-2	Bit-Interleaved Parity - 2 bits
BIP-8	Bit-Interleaved Parity - 8 bits

BNC	bayonet-Neill-Concelman
BOM	Bit-Oriented Messages
bps	Bit Per Second
Bps	Byte Per Second
BPV	Bipolar Violation
BSD	Backward Signal Degrade
BSF	Backward Signal Fail

C

C	Current
C-bit	Control bit
CAGE	Commerce And Government Entities
CBR	Constant Bit Rate
CD	Compact Disk
CE	European Conformity
CFR	Code of Federal Regulations
cHEC	Core Header Error Check
CID	Channel Identifier
CMF	Client Management Frame
CMI	Coded Mark Inversion
CORR	Correctable
<C _R >	Carriage Return
CRC	Cyclic Redundancy Check
CRC-4	Cyclic Redundancy Check (a four-bit word that detects bit errors)

Glossary

Acronym List

CRC-6	Cyclic Redundancy Check (a six-bit word that detects bit errors)
CRC-7	Cyclic Redundancy Check (a seven-bit word that detects bit errors)
CRC LOMF	Cyclic Redundancy Check Loss Of Multiframe
CSF	Client Signal Fail
CSU	Customer Service Unit
CTRL	Control
CV	Code Violation
CW	Codeword

D

DAPI	Destination Access Point Identifier
dB	Decibel
dBdsx	Decibel DSX1
dBm	Decibel - milliwatts
DCC	Data Communication Channel
DCI	Defect Clear Indication
DM	Degraded Minutes
DNU	Do Not Use
DPSK	Differential Phase Shift Keying
DQDB	Distributed Queue Dual Bus
DS0	Digital Signal-level 0 (64 kbps)
DS1	Digital Signal-level 1 (1.544 Mbps)
DS3	Digital Signal-level 3 (44.736 Mbps)
DSn	Digital Signal-level n

DSX1	Digital Signal Level 1 Cross Connect
DUT	Device Under Test
DVB ASI	Digital Video Broadcast - A Synchronous Interface

E

E-bit	CRC-4 Error Signal
E0	European standard for digital transmission-level 0 (64 Kbps).
E1	European standard for digital transmission-level 1 (2.048 Mbps).
E2	European standard for digital transmission-level 2 (8.448 Mbps).
E3	European standard for digital transmission-level 3 (34.368 Mbps).
E4	European standard for digital transmission-level 4 (139.264 Mbps).
EB	Errored Block
EC	Error Count
EFS	Error Free Second
eHEC	Extension Header Error Check
EMC	Electromagnetic Compatibility
EOS	End Of Sequence
ERDI-CD	Enhanced Remote Defect Indication - Connectivity Defect
ERDI-PCD	Enhanced Remote Defect Indication - Path Connectivity Defect
ERDI-PD	Enhanced Remote Defect Indication - Payload Defect

Glossary

Acronym List

ERDI-PPD	Enhanced Remote Defect Indication - Path Payload Defect
ERDI-PSD	Enhanced Remote Defect Indication - Path Server Defect
ERDI-SD	Enhanced Remote Defect Indication - Server Defect
ERDI-VCD	Enhanced Remote Defect Indication - VT Connectivity Defect
ERDI-VPD	Enhanced Remote Defect Indication - VT Payload Defect
ERDI-VSD	Enhanced Remote Defect Indication - VT Server Defect
ES	Errored Second
ESCON	Enterprise System Connection
ESD	Electrostatic Discharge
ESF	Extended Superframe
ESR	Errored Second Ratio
EUI	EXFO Universal Interfaces
EXI	Extension Header Identifier
EXP	Experimental
ExSQ	Expected Sequence Indicator
EXZ	Excessive Zeros

F

F-bit	Framing bit
FAS	Frame Alignment Signal
FC	Fibre Channel
FCC	Federal Communications Commission

FCS	Frame Check Sequence
FDDI	Fiber Distributed Data Interface
FDI	Forward Defect Indication
FDL	Facility Data Link
FEAC	Far End Alarm and Control
FEBE	Far-End Block Error
FEC	Forward Error Correction
FICON	Fiber Connection
FIF	Fault Indication Field
FOPR	Failure of Protocol Receive
FOPT	Failure of Protocol Transmit
fps	frame per second
FSD	Forward Signal Degrade
FSF	Forward Signal Fail
ft	Feet
FTFL	Fault Type Fault Location

G

GCC	General Communication Channel
Gbps	Gigabit per second
GBps	Gigabyte per second
GCCx	General Communication Channel-x
GFP	Generic Framing Procedure
GFP-F	Generic Framing Procedure - framed
GFP-T	Generic Framing Procedure - transparent

Glossary

Acronym List

GID	Group Identifier
GMP	Generic Mapping Procedure
GMP OOS	GMP Out of Synchronization
GMT	Greenwich Mean Time
GUI	Graphical User Interface

H

H	History
H4-LOM	H4 - Loss Of Multiframe
HDB3	High Density Bipolar 3 Code
HDLC	High-Level Data Link Control
HO	High Order
HOP	High Order Path
HP-PLM	High Order Path - Payload Label Mismatch
HP-POH	Higher-Order Path Overhead
HP-RDI	High Order path - Remote Defect Indication
HP-REI	High Order path - Remote Error Indicator
HP-TIM	High Order Path - Trace Identifier Mismatch
HP-UNEQ	High Order Path - Unequipped

I

IAE	Incoming Alignment Error
IC	Industry Canada
ID	Identification
IEEE	Institute of Electrical & Electronics Engineers

IFG	Inter Frame Gap
IN	INput
IR	Intermediate Reach
ISDN	Integrated Services Digital Network
ISM	In-Service Monitoring
ISO	International Organization for Standardization
ITU	International Telecommunication Union

J

JC	Justification Control
----	-----------------------

K

Kbps	Kilobit per second
KBps	Kilobyte per second

L

LAPS	Link Access Procedure for SDH
LBO	Line Build Out
LCAS	Link Capacity Adjustment Scheme
LED	Light-Emitting Diode
LCK	Locked
lf	Line Feed
LFD	Loss of Frame Delineation
LO	Low Order

Glossary

Acronym List

LOA	Loss Of Alignment
LOC	Loss Of Clock
LOCCS	Loss of Client Character Synchronization
LOCS	Loss Of Client Signal
LOF	Loss Of Frame
LOFLOM	Loss of Frame Loss Of Multiframe
LOH	Line Overhead
LOM	Loss Of Multiframe
LOMF	Loss Of Multiframe
LOP	Loss Of Pointer
LOP	Low Order Path
LOP-P	Loss Of Pointer - Path
LOP-V	Loss Of Pointer - VT
LOS	Loss Of Signal
LP-PLM	Low Order Path - Payload Label Mismatch
LP-RDI	Low Order Path - Remote Defect Indication
LP-REI	Low Order Path - Remote Error Indicator
LP-RFI	Low Order Path - Remote Failure Indication
LP-TIM	Low Order Path - Trace Identifier Mismatch
LP-UNEQ	Low Order Path - Unequipped
LR	Long Reach
LSB	Least-Significant Bit
LSS	Loss of Sequence Synchronization
LTC	Loss of Tandem Connection

M

MAC	Media Access Control
MAPOS	Multiple Access Protocol Over SONET/SDH
Mbps	Megabit per second
MBps	Megabyte per second
MFAS	Multiframe Alignment Signal
MMF	Multi-Mode Fiber
MS	Multiplex Section
MS-AIS	Multiplex Section - Alarm Indication Signal
MS-RDI	Multiplex Section - Remote Defect Indication
MS-REI	Multiplex Section - Remote Error Indicator
MSB	Most-Significant Bit
MSIM	Multiplex Structure Identifier Mismatch
MSOH	Multiplex Section Overhead
MST	Member Status
MUX	Multiplexer
MUX/DEMUX	Multiplexer/Demultiplexer

N

NATO	North Atlantic Treaty Organization
NDF	New Data Flag
NE	Network Element
NI/CSU	Network Interface/Customer Service Unit
NJO	Negative Justification Opportunity

Glossary

Acronym List

nm	Nanometer
NORM	Normal

O

OC-3	Optical Carrier for 3rd level (155.52 Mbps)
OC-12	Optical Carrier for 12th level (622.08 Mbps)
OC-48	Optical Carrier for 48th level (2488.32 Mbps)
OC-192	Optical Carrier for 192th level (9.95328 Gbps)
OC-768	Optical Carrier for 768th level (39.81312 Gbps)
OCI	Open Connection Indication
ODU	Optical Data Unit
ODI	Outgoing Defect Indication
OEI	Outgoing Error indication
OH	Overhead
OOF	Out-Of-Frame
OOM	Out-Of-Multiframe
OOM1	Out-Of-Multiframe of stage 1
OOM2	Out-Of-Multiframe of stage 2
OOSM	Out-Of-Service Monitoring
OPU	Optical Payload Unit
OTN	Optical Transport Network
OTU	Optical Transport Unit
OTU1	Optical Transport Unit 2.666 Gbps
OTU1e	Optical Transport Unit 11.049 Gbps
OTU1f	Optical Transport Unit 11.270 Gbps

OTU2	Optical Transport Unit 10.709 Gbps
OTU2e	Optical Transport Unit 11.096 Gbps
OTU2f	Optical Transport Unit 11.317 Gbps
OTU3	Optical Transport Unit 43.018 Gbps
OUT	OUTput

P

P-bit	Parity bit
PC	Personal Computer
PCC	Protection Communication Channel
PCM	Pulse Code Modulation
PDH	Plesiochronous Digital Hierarchy
PDI-P	Payload Defect Indication - Path
pFCS	payload Frame Check Sequence
PFI	Payload Frame check sequence Identifier
PLCR	Partial Loss of Capacity Receive
PLCT	Partial Loss of Capacity Transmit
PLI	Payload Length Indicator
PLM	Payload Label Mismatch
PLM-P	Payload Label Mismatch - Path
PLM-V	Payload Label Mismatch - VT
PM	Path Monitoring
PM	Performance Monitoring
PN-11	Polynomial Number 11
POH	Path Overhead

Glossary

Acronym List

ppm	Parts Per Million
PPP	Point-to-Point Protocol
PRBS	Pseudo Random Bit Sequence
PRM	Performance Report Messages
PSI	Payload Structure Identifier
PT	Payload Type
PTE	Path Terminating Equipment
PTI	Payload Type Identifier

Q

QRSS	Quasi-Random Signal Source
------	----------------------------

R

RAI	Remote Alarm Indication
RAI MF	Remote Alarm Indication MultiFrame
RAM	Random-Access Memory
RDI	Reverse Defect Indication
RDI	Remote Defect Indication test (replaces the former names FERF and RAI)
RDI-L	Remote Defect Indication - Line
RDI-P	Remote Defect Indication - Path
RDI-V	Remote Defect Indication - VT
REF OUT	Reference Output
REI	Remote Error Indication
REI-L	Remote Error Indication - Line

REI-P	Remote Error Indication - Path
REI-V	Remote Error Indication - VT
RES	Reserved
RFI	Remote Failure Indication
RFI-V	Remote Failure Indication - VT
RMA	Return Merchandise Authorization
RS	Regenerator Section
RS-Ack	Re-Sequence Acknowledge
RS-TIM	Regenerator Section - Trace Identifier Mismatch
RSOH	Regenerator Section Overhead
RTD	Round Trip Delay
RX	Receive

S

SAPI	Source Access Point Identifier
SDH	Synchronous Digital Hierarchy
SDT	Service Disruption Time
SEF	Severely Errored Framing
SELV	Safety Extra Low Voltage
SEP	Severely Errored Period
SEPI	Severely Errored Period Intensity
SES	Severely Errored Second
SESR	Severely Errored Second Ratio
SF	Superframe
SFP	Small Form Factor Pluggable

Glossary

Acronym List

SI	International System
SK	Software Key
SM	Section Monitoring
SMA	Sub-Miniature A connector
SMF	Single Mode Fiber
SOH	Section Overhead
SONET	Synchronous Optical NETWORK
SPE	Synchronous Payload Envelope
SQ	Sequence indicator
SQM	Sequence Indicator Mismatch
SQNC	Sequence Indicator Non-Consistent
SR	Short Reach
SSA	SONET SDH Analyzer
SSMB	Synchronization Status Message Byte
STM-0e	Electrical Synchronous Transport Module (51 Mbps)
STM-1	Synchronous Transport Module for 1st level (155.52 Mbps)
STM-1e	Electrical Synchronous Transport Module for 1st level (155.52 Mbps)
STM-4	Synchronous Transport Module for 4th level (622.08 Mbps)
STM-16	Synchronous Transport Module for 16th level (2.48832 Gbps)
STM-64	Optical Carrier for 64th level (9.95328 Gbps)
STM-256	Optical Carrier for 256th level (39.81312 Gbps)
STS-1	Synchronous Transport Signal-Level 1 (51.84 Mbps)
STS-3	Synchronous Transport Signal-Level 3 (155.52 Mbps)

STS-12	Synchronous Transport Signal-Level 12 (622.08 Mbps)
STS-48	Synchronous Transport Signal-Level 48 (2.48832 Gbps)
STS-192	Synchronous Transport Signal-Level 192 (9.95328 Gbps)
STS-768	Synchronous Transport Signal-Level 768 (39.81312 Gbps)
SYMB	Symbol

T

TC	Tandem Connection
TC-BIP	Tandem Connection - Bit Interleaved parity
TC-IAIS	Tandem Connection - Incoming Alarm Indication Signal
TC-IEC	Tandem Connection - Incoming Error Count
TC-LTC	Tandem Connection - Loss of Tandem Connection
TC-RDI	Tandem Connection - Remote Defect Indication
TC-REI	Tandem Connection - Remote Error Indication
TC-TIM	Tandem Connection - Trace Identifier Mismatch
TC-VIOL	Tandem Connection - Violations
TCM	Tandem Connection Monitoring
TCM ACT	Tandem Connection Monitoring Activation
TERM	Terminal
tHEC	type Header Error Check
TIM	Trace Identifier Mismatch
TIM-P	Trace Identifier Mismatch - Path
TIM-S	Trace Identifier Mismatch - Section
TIM-V	Trace Identifier Mismatch - VT

Glossary

Acronym List

TLCR	Total Loss of Capacity Receive
TLCT	Total Loss of Capacity Transmit
TNC	Transmit Node Clock
TRN	Transceiver
TS16 AIS	TimeSlot 16 Alarm Indication Signal
TTI	Trail Trace Identifier
TU	Tributary Unit
TU-11	Tributary Unit - 11
TU-12	Tributary Unit - 12
TU-AIS	Tributary Unit - Alarm Indication Signal
TU-LOP	Tributary Unit - Loss Of Pointer
TUG	Tributary Unit Group
TX	Transmit

U

UAS	Unavailable Second
UMST	Unexpected Member Status
UNCORR	Uncorrectable
UNEQ-P	Unequipped - Path
UNEQ-V	Unequipped - VT
UPI	User Payload Identifier
μs	microsecond
USA	United States of America
USB	Universal Serial Bus
UTC	Universal Time Coordinated

V

V	Volt
VC	Virtual Container
VC-11	Virtual Container-11
VC-12	Virtual Container-12
VC-AIS	Virtual Container - Alarm Indication Signal
VC-3	Virtual Container-3
VC-4	Virtual Container-4
VC-n	Virtual Container-n
VCAT	Virtual Concatenation
VCG	Virtual Concatenated Group
VLAN	Virtual Local Area Network
Vpp	Volt peak-to-peak
VT	Virtual Tributary
VTG	Virtual Tributary Group
VT1.5	Virtual Tributary-1.5
VT2	Virtual Tributary-2
VT3	Virtual Tributary-3
VT6	Virtual Tributary-6

Glossary

Acronym List

X

X	Exit application
XFP	10G Small Form Factor Pluggable

Z

ZCS	Zero Code Suppression
-----	-----------------------

G.709 Optical Transport Network (OTN)

Overview

The optical transport network (OTN) combines the benefits of SONET/SDH technology with the bandwidth expansion capabilities offered by dense wavelength-division multiplexing (DWDM) technology.

The OTN consists of the following layers:

- Optical Transport Section (OTS)
- Optical Multiplex Section (OMS)
- Optical Channel (OCh)
- Optical Transport Unit (OTU)
- Optical Data Unit (ODU)
- Optical Channel Payload Unit (OPU)

Glossary

G.709 Optical Transport Network (OTN)

Each of these layers and their functions are distributed along the network and activated when they reach their termination points, which are illustrated in the following figure.

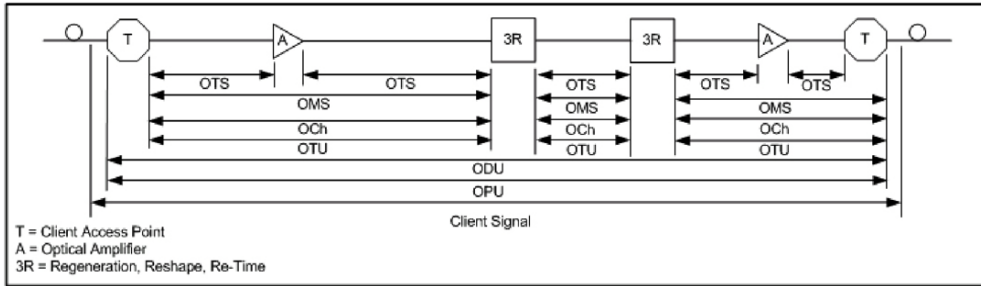

OTN Layer Termination Points

The termination of the OTS, OMS and OCh layers is performed at the optical level of the OTN. It is at the termination of the OTU layer that further functionality can be added. This layer is the digital layer—also known as the “digital wrapper”—and offers specific overhead to manage the OTN’s digital functions. The OTU also introduces a new dimension to optical networking by adding forward error correction (FEC) to the network elements, allowing operators to limit the number of required regenerators used in the network which, in turn, lowers its cost.

FEC allows an increase in the optical link budget by providing a new method to correct errors, thereby reducing the impact of network noise and other optical phenomena experienced by the client signal traveling through the network.

The OTU also encapsulates two additional layers—the ODU and the OPU—which provide access to the payload (SONET, SDH, etc.). These layers are normally terminated at the same location.

The OTU, ODU (including the ODU tandem connection) and OPU layers can all be analyzed and monitored. As per ITU G.709, current test solutions offer these possibilities using three line rates:

- OTU1 (255/238 x 2.488 320 Gbps ~ 2.666057143 Gbps) also referred to as 2.7 Gbps
- OTU2 (255/237 x 9.953280 Gbps ~ 10.709225316 Gbps) also referred to as 10.7 Gbps
- OTU3 (255/236 x 39.813120 Gbps ~ 43.018413559 Gbps) also referred to as 43 Gbps

Each line rate is adapted to service different client signals:

- OC-48/STM-16 is transported via OTU1
- OC-192/STM-64 is transported via OTU2
- OC-768/STM-256 is transported via OTU3
- Null Client (All 0s) is transported via OTUk (k = 1, 2, 3)
- PRBS 231-1 is transported via OTUk (k = 1, 2, 3)

In order to map client signals via ITU G.709, they are encapsulated using the structure illustrated in the following figure.

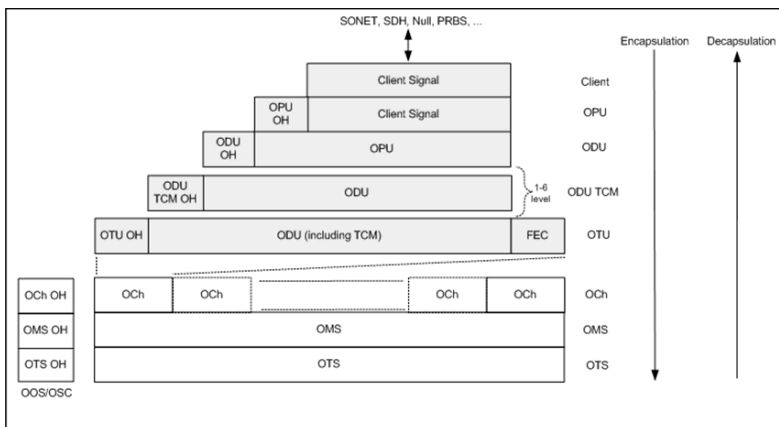

Basic OTN Transport Structure

Glossary

G.709 Optical Transport Network (OTN)

As depicted above, to create an OTU frame, a client signal rate is first adapted at the OPU layer. The adaptation consists of adjusting the client signal rate to the OPU rate. Its overhead contains information to support the adaptation of the client signal. Once adapted, the OPU is mapped into the ODU. The ODU maps the OPU and adds the overhead necessary to ensure end-to-end supervision and tandem connection monitoring (up to six levels). Finally, the ODU is mapped into an OTU, which provides framing as well as section monitoring and FEC.

Following the OTN structure presented in figure *Basic OTN Transport Structure* on page 599, OTUks ($k = 1, 2, 3$) are transported using the OCh; each unit is assigned a specific wavelength of the ITU grid. Several channels can be mapped into the OMS and then transported via the OTS layer. The OCh, OMS and OTS layers each have their own overhead for management purposes at the optical level. The overhead of these optical layers is transported outside of the ITU grid in an out-of-band channel called the optical supervisory channel (OSC).

When the OTU frame structure is complete (OPU, ODU and OTU), ITU G.709 provides OAM&P functions that are supported by the overhead.

OTU Frame Structure and Overhead

As shown in the figure below, the OTU frame is broken down into the following components:

- Framing
- OTU, ODU, OPU overhead
- OTU FEC

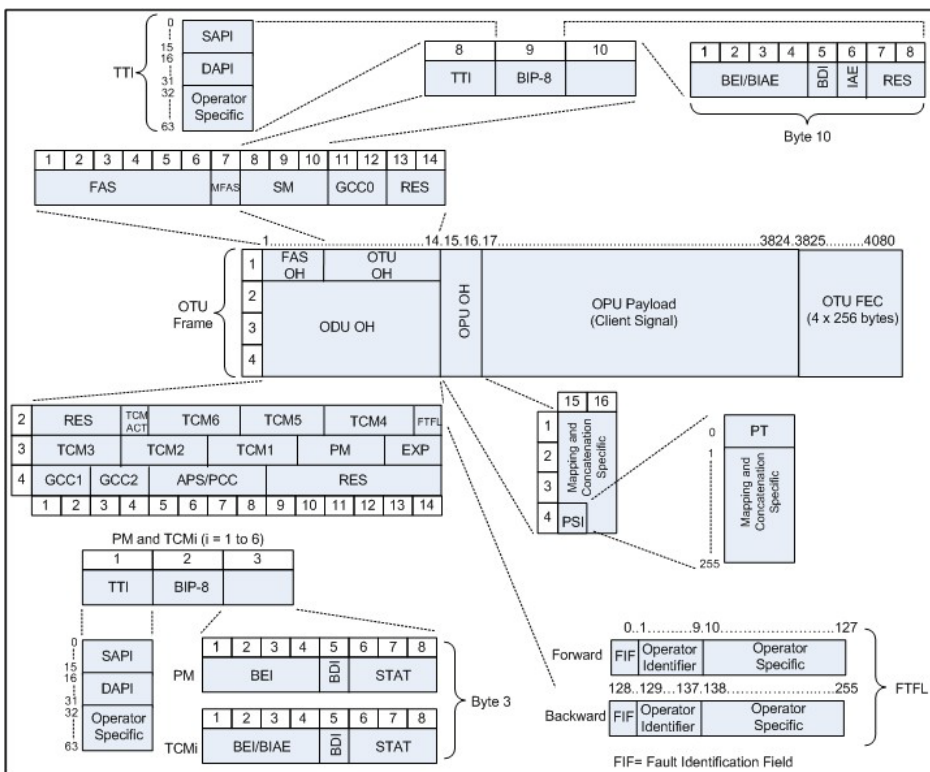

OTU Frame Description

Glossary

G.709 Optical Transport Network (OTN)

► Framing

The OTU framing is divided into two portions: FAS and MFAS.

The frame alignment signal (FAS) uses the first six bytes and, similarly to SONET/SDH, it is used to provide framing for the entire signal. In order to provide enough 1/0 transitions for synchronization, scrambling is used over the entire OTU frame, except for the FAS bytes.

The multiframe alignment signal (MFAS) byte is used to extend command and management functions over several frames. The MFAS counts from 0 to 255, providing a 256 multiframe structure.

► Overhead

Each portion of the OTU frame has its own specific overhead functions. They are displayed in figure *OTU Frame Description* on page 601, and are briefly described below. Further details can be found about these overhead fields in the ITU G.709 standard.

► Optical Transport Unit (OTU)

The OTU overhead is comprised of the SM, GCC0 and RES bytes.

The section monitoring (SM) bytes are used for the trail trace identifier (TTI), parity (BIP-8) and the backward error indicator (BEI), or backward incoming alignment error (BIAE), backward defect indicator (BDI), and incoming alignment error (IAE). The TTI is distributed over the multiframe and is 64 bytes in length. It is repeated four times over the multiframe.

General communication channel 0 (GCC0) is a clear channel used for transmission of information between OTU termination points.

The reserved (RES) bytes are currently undefined in the standard.

➤ **Optical Data Unit (ODU)**

The ODU overhead is broken into several fields: RES, PM, TCMi, TCM ACT, FTFL, EXP, GCC1/GCC2 and APS/PCC.

The reserved (RES) bytes are undefined and are set aside for future applications.

The path monitoring (PM) field is similar to the SM field described above. It contains the TTI, BIP-8, BEI, BDI and Status (STAT) field.

There are six tandem connection monitoring (TCMi) fields, which contain the BEI/BIAE, BDI and STAT fields. The STAT field is used in the PM and TCMi fields to provide an indication of the presence or absence of maintenance signals.

The tandem connection monitoring activation/deactivation (TCM ACT) field is currently undefined in the standards.

The fault type and fault location reporting communication channel (FTFL) is a message spread over a 256-byte multiframe that provides the ability to send forward and backward path-level fault indications.

The experimental (EXP) field is a field that is not subject to standards and is available for network operator applications.

General communication channels 1 and 2 (GCC1/GCC2) fields are very similar to the GCC0 field except that each channel is available in the ODU.

The automatic protection switching and protection communication channel (APS/PCC) supports up to eight levels of nested APS/PCC signals, which are associated to a dedicated-connection monitoring level depending on the value of the multiframe.

Glossary

G.709 Optical Transport Network (OTN)

➤ **Optical Payload Unit (OPU)**

The primary overhead field associated to the OPU is the Payload Structure Identifier (PSI). This is a 256 bytes multi-frame where its first byte is defined as the Payload Type (PT). The remaining 255 bytes are currently reserved.

The other fields in the OPU overhead are dependent on the mapping and concatenation capabilities associated to the OPU. For an asynchronous mapping (the client signal and OPU clock are different) Justification Control (JC) bytes are available to compensate for clock rate differences, two methods are supported Asynchronous Mapping Procedure (AMP) and Generic Mapping Procedure (GMP). For a purely Bit-Synchronous Mapping Procedure (BMP) (client source and OPU clock are the same), the JC bytes become reserved (set to 0). Concatenation bytes are also available as described in ITU G.709.

Tandem Connection Monitoring (TCM)

TCM enables the user and its signal carriers to monitor the quality of the traffic that is transported between segments or connections in the network. SONET/SDH allowed a single level of TCM to be configured, while ITU G.709 allows six levels of tandem connection monitoring to be configured. The assignment of monitored connections is currently a manual process that involves an understanding between the different parties. There are various types of monitored connection topologies: cascaded, nested and overlapping. Examples of these topologies are provided in the following figure.

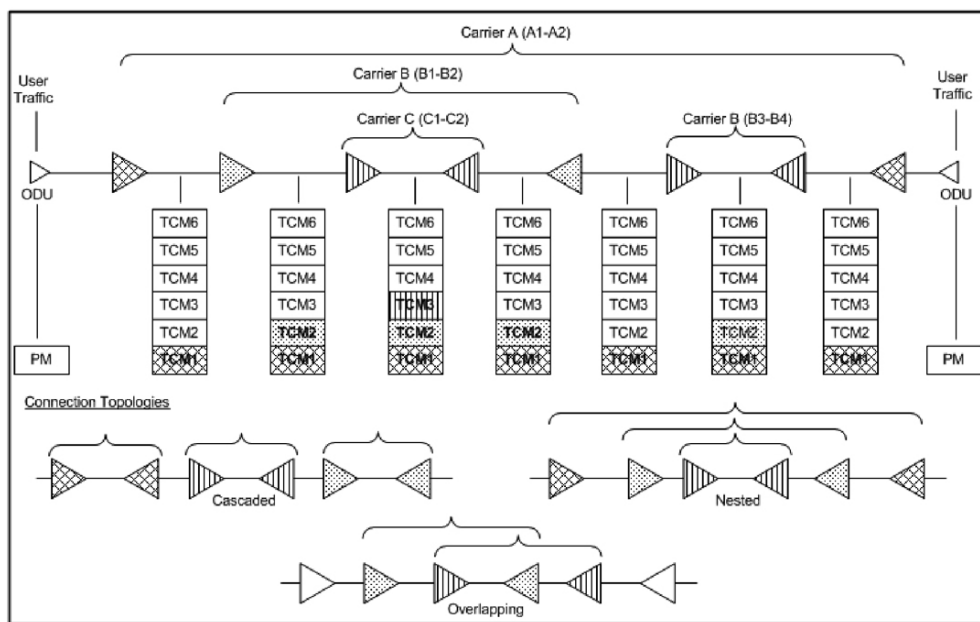

Tandem Connection Monitoring

Glossary

G.709 Optical Transport Network (OTN)

Each of the six TCMi fields in the ODU overhead is assigned to a monitored connection. There can be from zero to six connections that can be configured for each connection. In the figure *Tandem Connection Monitoring* on page 605, there are three different connections that are actually monitored. Carrier C, due to its location, can monitor three TCM levels as the ODU passes through its portion of the network.

In addition to monitoring maintenance signals, using the STAT field associated with each TCM level, the TCM connection also monitors the BIP-8 and BEI errors for each connection level. Maintenance signals are used to advertise upstream maintenance conditions affecting the traffic and errors provide an indication of the quality of service offered at each segment of the network, which provides a valuable tool for the user and carrier to isolate faulty sections of the network.

Forward Error Correction (FEC)

The ITU G.709 standard supports forward error correction (FEC) in the OTU frame and is the last part added to the frame before the frame is scrambled. FEC provides a method to significantly reduce the number of transmitted errors due to noise, as well as other optical phenomena that occur at high transmission speeds. This enables providers to support longer spans in between optical repeaters.

An OTU frame is divided into four rows. Each row is broken down into 16 sub-rows comprised of 255 bytes each, as shown in figure *Forward Error Correction* on page 608. A sub-row is composed of interleaved bytes. The interleave is executed so that the first sub-row contains the first overhead (OH) byte, the first payload byte and the first FEC byte, and so on for the remaining sub-rows of each row in the frame. The first FEC byte starts at position 240 for all sub-rows.

Glossary

G.709 Optical Transport Network (OTN)

The FEC uses a Reed-Solomon RS (255/239) coding technique. This means that 239 bytes are required to compute a 16-byte parity check. The FEC can correct up to eight (bytes) errors per sub-row (codeword) or detect up to 16 byte errors without correcting any. Combined with the byte interleave capability included in ITU G.709 implementation, the FEC is more resilient in regards to error burst, where up to 128 consecutive bytes can be corrected per OTU frame row.

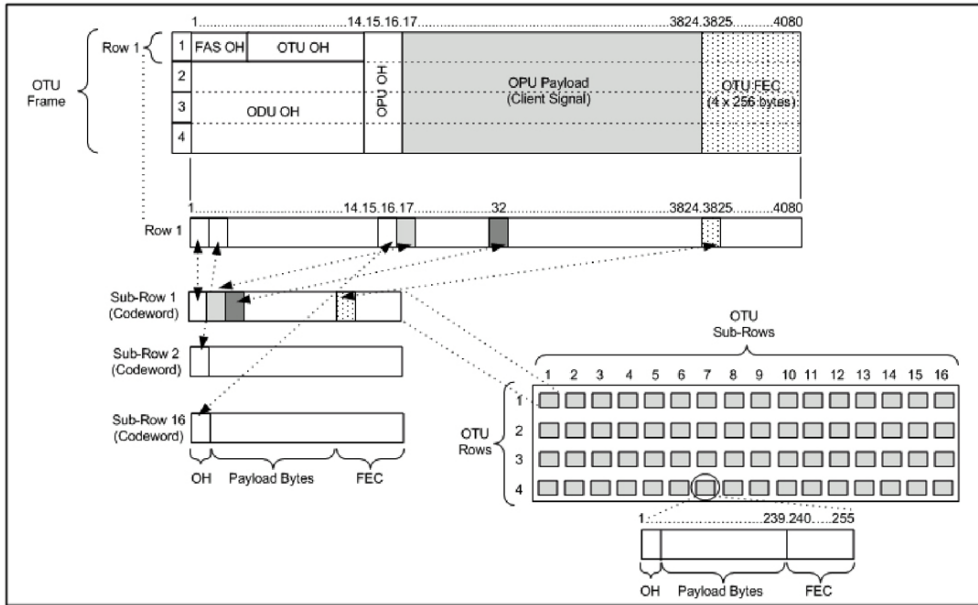

Forward Error Correction

ODU Multiplexing

The ODU multiplexer is a function that allows the multiplexing of ODU tributary signals into higher OTN signal rates. The G.709 standard supports 2 types of ODU multiplexer which can be classified as follows:

- Legacy architecture is based on multi-stage architecture to bring an ODUk client to a higher OTN interface rate. This multiplexer is identified by Payload Type 20 (PT 20).
- New architecture uses a single stage architecture to bring an ODUk client to any higher OTN interface rate. This method supports the ODUflex client signal. The multiplexer is identified by Payload Type 21 (PT 21). The ODUflex function is only supported on IQS-8130, IQS-8130NG, IQS-8130NGE, and IQS-8140 modules.

Note: Refer to the *Supported Paths/Mappings* on page 59 for the ODU multiplexing capabilities.

The multiplexing strategy is based on the concept of tributary slots, which is similar in concept to the SONET timeslot. The multiplexing of 4 ODU1 in one ODU2 is made by distributing the ODU1 structure in a repetitive sequence of 4 ODU2 Tributary slots, a similar strategy is used for ODU3 multiplexing where the repetitive sequence is made of 16 ODU3 tributary slots, refer to G.709 standard for detailed information.

Glossary

G.709 Optical Transport Network (OTN)

The main attributes of the ODU multiplexer functionality are as follows:

- The Asynchronous Mapping Procedure (AMP) is used for multiplexing the tributary signals; this method uses a modified Justification Control mechanism which has 2 positive Justification Control bytes and one negative Justification Control byte.
- The new multiplex method also supports the Generic Mapping Procedure as the Justification Control mechanism is still using the OPU OH JC bytes.
- The Multiplex Structure Identifier (MSI) provides information that is specific to each type of multiplexer provided.
- Can handle multiplex signals with frequency offset of +/- 20 ppm on every layer for the legacy architecture while the new architecture (using GMP) can handle frequency offset of +/-100 ppm.

ODUflex

ODUflex provides the capability to carry client payload of variable size with a container size of 1.244 Gb/s granularity. An ODUflex (L) signal can be transported once multiplexed in an ODUk (H) signal, the multiplexer in this case handles tributary slots of 1.244 Gb/s and has a Payload Type 21. The ODUflex function can be used to transport 2 signal categories mapped in ODTUk.ts using GMP:

➤ Ethernet in ODUflex over GFP-F signal

The Ethernet packets are mapped in GFP-F as specified in G.7041, the packets are processed as follows:

- The Start of Frame Delineation bytes are terminated
- Inter Frame Gaps bytes are terminated
- PCS coding is terminated
- GFP overhead bytes added

Since the PCS coding is terminated, it is not possible to transport the Ethernet Link status transparently but it is accommodated by the Forward Defect Indication (FDI) and Remote Defect Indication (RDI) alarms over GFP. The RDI is used to carry the Remote Fault alarm while the FDI is used to carry the Local Fault.

GFP-F provides rate adaptation between the incoming Ethernet signal and the outgoing OPUflex transport signal. This brings the fact that GMP is operated at a fixed Cm value close to the maximum server capacity.

➤ CBR over ODUflex signal

ODUflex can transport Constant Bit Rate signal (bulk filled Test pattern) as Client of the ODUflex CBR function. This CBR function needs a Pattern generator that can operate at a data rate specified by the user, the range of the available data rates is qualified by the Bandwidth management function.

Glossary

SONET Numbering Convention

SONET Numbering Convention

The IQS-8100 Series supports the Timeslot (default) and hierarchical two-level numbering conventions as per GR-253.

Hierarchical Notation

The IQS-8100 Series supports numbering SONET high order path STS-1s and STS-3c using the two-level “STS-3#,STS-1#” convention in an OC-N. For example: STS-1 [2,3].

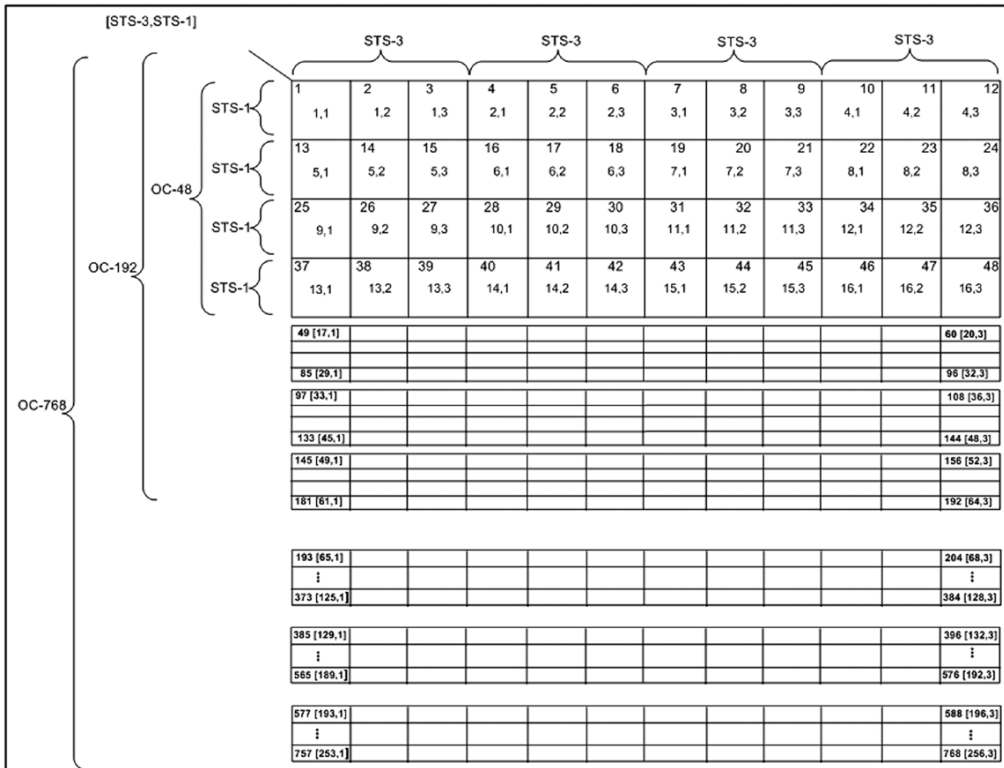

The IQS-8100 Series supports numbering SONET low order path using the two-level “VTGroup#,VT#” convention for numbering VTs within an STS-1. For example: VT1.5 [1,3], VT2 [3,2], VT6 [6,1].

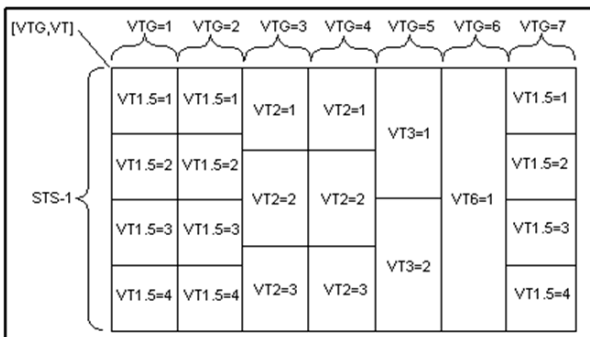

The IQS-8100 Series supports numbering SONET high order path STS-nc within an OC-N using the two-level “STS-3#,STS-1#”. For example: STS-12c [5,1].

Note: For STS-1e the numbering is limited to the A value as only one STS-1 exists.

SDH Numbering Convention

As per ITU G.707, the high order paths are defined using a 2 to 5 level convention E,D,C,B,A depending on the rate of the STM-n used.

- E: the AUG-64 are numbered 1 to 4
- D: the AUG-16 are numbered 1 to 4
- C: the AUG-4 are numbered 1 to 4
- B: the AUG-1 are numbered 1 to 4
- A: the AU-3 are numbered 1 to 3

So for the naming is as follows for each of the following rate:

- [E,D,C,B,A] for STM-256
- [D,C,B,A] for STM-64
- [C,B,A] for STM-16
- [B,A] for STM-4
- [0] for AU-4 in STM-1
- [A] for AU-3 in STM-1
- [A] for the AU-3 in STM-0e, A=0.

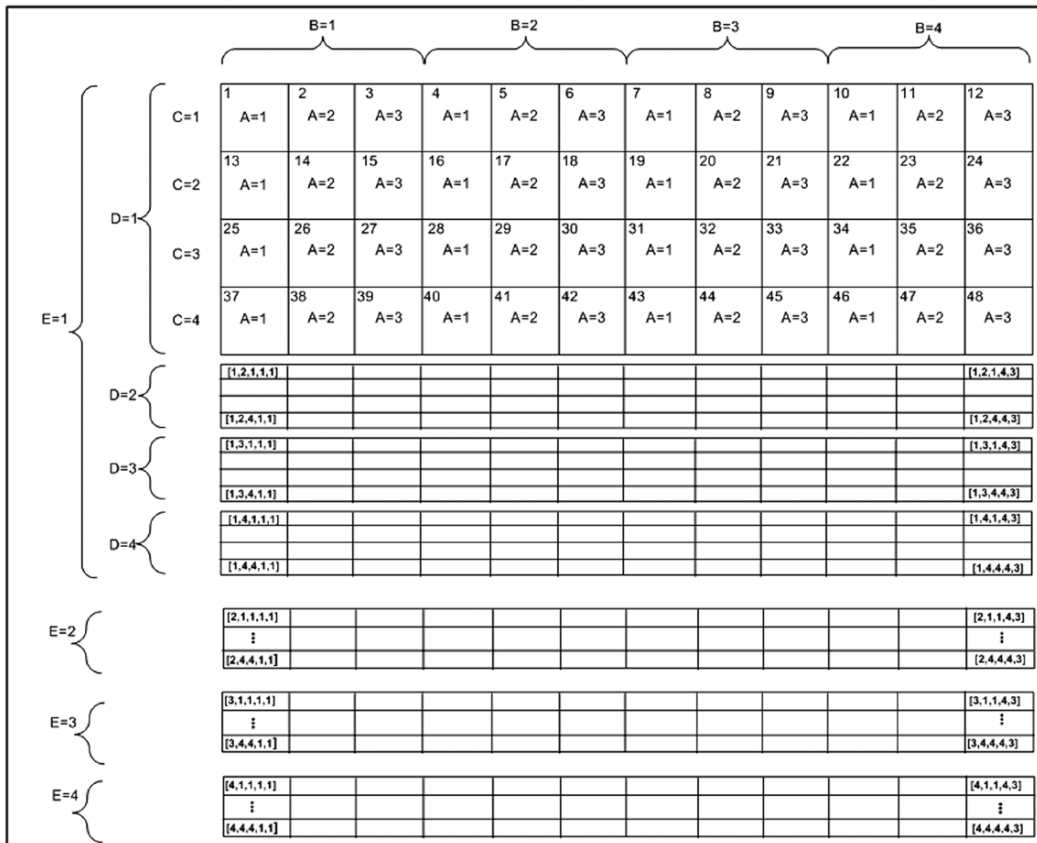

The low order paths are defined using a 2 or 3 level convention K,L,M depending on the rate of the AU-4 or AU-3 used to multiplex the low order signals.

- K: the TUG-3 are numbered 1 to 3
- L: the TUG-2 are numbered within the TUG-3 0 or from 1 to 7
- M: the TU-2, TU-12, TU-11 are numbered within the TUG-2 1, 1 to 3, 1 to 4 respectively

Glossary

SDH Numbering Convention

Examples for AU-4 (3 level convention)

TU-3: [K,0,0]

TU-2: [K,L,0]

TU-12:[K,L,M] where M = 1 to 3

TU-11:[K,L,M] where M = 1 to 4

Example for AU-3 (2 level convention)

TU-2: [L,0]

TU-12: [L,M] M is numbered 1 to 3

TU-11: [L,M] M is numbered 1 to 4

The GUI Grid indicates the TUG-2 [x] and TUG-3 [x] values.

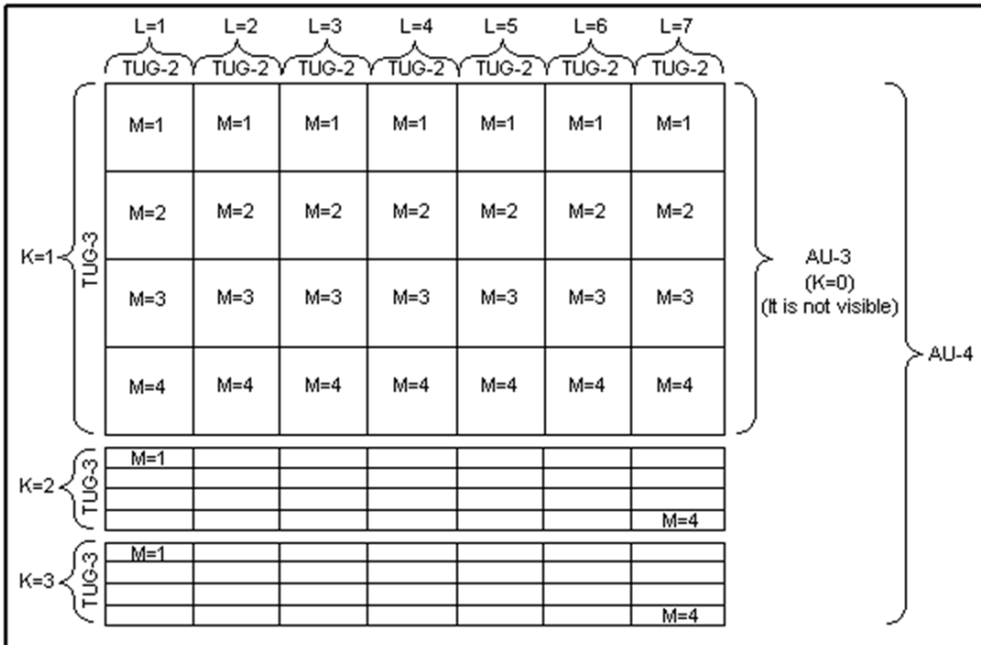

DSn/PDH Numbering Convention

The DS1 numbering in DS3 shall be numbered with respect to the DS2 muxing [DS2,DS1]. For example a DS3 has 7 DS2 and a DS2 has 4 DS1, so an example would be for a DS1 number [3,2]. The DS3 shall have a single number to represent its position. That is [1] all the time whether it is used in an STS-1 or it is the DS3 electrical interface.

The PDH do not have special grouping of the E1, E2, E3 or E4. This means that the PDH has a single number. For example E1 number 2 shall be number [2].

The E1 in DS3 via G.747 numbering uses the naming [DS2,E1]. However in the grid the label shall adapt itself to DS2 [x] or 6.3M [x] (where x = 1 to 7) with respect to the interface standard used: European or International.

Glossary

SONET - Section Overhead (SOH)

SONET - Section Overhead (SOH)

The section contains overhead information (SOH) used by all SONET equipment along a network path, including signal regenerators.

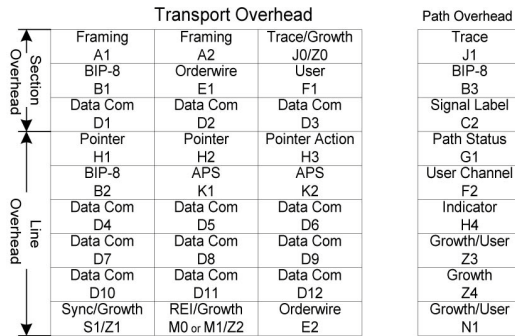

A1 and A2: Framing

A1 and A2 provide frame alignment of each STS-1 frame within a composite signal (STS-1 to STS-n). They must appear in every STS-1 of a composite signal. The value is hexadecimal F628.

J0: Trace

The J0 (Trace) byte is used to trace the origin of an STS-1 frame as it travels across the SONET network. This byte is only defined for the first STS-1 frame of a composite signal STS-1 to STS-n (STS-1 of an electrical or OC-N signal).

Z0: Growth

The Z0 (Growth) byte was used to uniquely identify the STS in question. This byte had to be defined in every STS-1 to STS-n frame of a composite signal. For speed reasons, a Section Trace is a much better use of this byte.

B1: BIP-8

The BIP-8 (Bit-Interleaved Parity) byte provides section error monitoring. The byte is calculated by performing a routine even-parity check over all bits of the previous frame of a composite signal (STS-1 to STS-n). This byte is only defined for the first STS-1 frame of a composite signal.

E1: Orderwire

The Orderwire provides a 64 Kbps voice channel for communication between two STEs (Section Terminating Equipment). This byte is only defined for the first STS-1 frame of a composite signal.

F1: User

The User byte is reserved for user purposes. This byte is only defined for the first STS-1 frame of a composite signal.

D1, D2 and D3: Data Communications Channel (DCC)

The Data Communication Channel (D1, D2 and D3) provides a 192 Kbps data communication between two STEs for operation functions such as OAM&P. This byte is only defined for the first STS-1 frame of a composite signal.

Glossary

SONET - Line Overhead (LOH)

SONET - Line Overhead (LOH)

This section contains overhead information (LOH) processed by all SONET equipment along a network path, excluding signal regenerators.

Transport Overhead			Path Overhead	
Section Overhead	Framing A1	Framing A2	Trace/Growth J0/Z0	Trace J1
	BIP-8 B1	Orderwire E1	User F1	BIP-8 B3
	Data Com D1	Data Com D2	Data Com D3	Signal Label C2
	Pointer H1	Pointer H2	Pointer Action H3	Path Status G1
	BIP-8 B2	APS K1	APS K2	User Channel F2
	Data Com D4	Data Com D5	Data Com D6	Indicator H4
	Data Com D7	Data Com D8	Data Com D9	Growth/User Z3
	Data Com D10	Data Com D11	Data Com D12	Growth Z4
	Sync/Growth S1/Z1	REI/Growth M0 or M1/Z2	Orderwire E2	Growth/User N1

H1 and H2: Pointer

H1 and H2 bytes are combined to form a pointer indicating where the path overhead begins within each SPE.

H3: Pointer Action

H3 is an extra byte used to compensate for the SPE timing variation. The H1 and H2 pointer tell the receiver when the H3 pointer is used. This byte must be defined in every STS-1 to STS-n frame of a composite signal.

B2: BIP-8

The BIP-8 (Bit-Interleaved Parity) byte provides line error monitoring. The byte is calculated by performing a routine even-parity check over all bits of the LOH and the STS-1 frame capacity of the previous frame of a composite signal (STS-1 to STS-n). Note that the SOH is not used to calculate the parity check. This byte must be defined in every STS-1 to STS-n frame of a composite signal.

K1 and K2: Automatic Protection Switching (APS)

The K1 and K2 bytes communicate APS between two LTE. This byte is only defined for the first STS-1 frame of a composite signal.

D4 - D12: Data Communications Channel (DCC)

The D4 through D12 bytes provides a 576 Kbps data communications channel between two LTEs for administration, monitoring and other communications. These bytes are only defined for the first STS-1 frame of a composite signal.

S1: Synchronization Status

The S1 byte is used to carry the synchronization status of the SONET device. This byte is only defined for the first STS-1 frame of a composite signal (STS-1 of an electrical or OC-N signal).

Z1: Growth

The Z1 byte is allocated for future growth. This byte is located in the second STS-1 through STS-n frame of a composite signal (STS-1 #2, STS-1 #3, up to STS-1 #N of a OC-N (N>3) signal).

M0: STS-1 REI-L

Bits 5 through 8 of M0 byte are used for line Remote Error Indication (REI-L). Bits 1 through 4 are currently undefined. The M0 byte is defined only for the STS-1 in an STS-1 electrical signal.

M1: STS-n REI-L

The M1 byte is used for line Remote Error Indication (REI-L). This byte is located in the third STS-1 of an STS-n signal ($n > 3$).

Glossary

SONET - Line Overhead (LOH)

Z2: Growth/FEBE (Far-End Block Error)

The Z2 byte is allocated for future growth. This byte is located in the first and second STS-1s of an STS-3, and the first, second, and fourth through n of a STS-n signal ($12 \leq n \leq 48$).

E2: Orderwire

The Orderwire provides a 64 Kbps voice channel for communication between LTEs. This byte is only defined for the first STS-1 frame of a composite signal.

SONET - Path Overhead (POH)

This section contains overhead information (POH) processed by SONET STS-1 terminating equipment.

Transport Overhead			Path Overhead
Section Overhead	Framing A1	Framing A2	Trace J1
	BIP-8 B1	Orderwire E1	BIP-8 B3
	Data Com D1	Data Com D2	Signal Label C2
	Pointer H1	Pointer H2	Path Status G1
	BIP-8 B2	APS K1	User Channel F2
	Data Com D4	Data Com D5	Indicator H4
	Data Com D7	Data Com D8	Growth/User Z3
	Data Com D10	Data Com D11	Growth Z4
	Sync/Growth S1/Z1	REI/Growth M0 or M1/Z2	Growth/User N1
Line Overhead	Trace/Growth J0/Z0	User F1	
	Pointer Action H3		
	APS K2		
	Data Com D6		
	Data Com D9		
	Data Com D12		
	Orderwire E2		

J1: Trace

The J1 Trace byte provides a 16 or 64 byte fixed string to verify connection between path transmitting equipment and path receiving equipment.

B3: BIP-8

The BIP-8 (Bit-Interleaved Parity) byte provides path error monitoring. The byte is calculated by performing a even-parity check over all bits of the previous SPE.

C2: Signal Label

C2 provides an identification byte for the STS SPE.

➤ STS Path Signal Label Assignments:

C2 (Hex.)	Description
00	Unequipped
01	Equipped - Non-Specific
02	Floating VT Mode
03	Locked VT Mode
04	Asynchronous Mapping for DS3
05	Mapping under development
12	Asynchronous Mapping for 140M (DS4NA)
13	Mapping for ATM
14	Mapping for DQDB
15	Asynchronous Mapping for FDDI
16	Mapping of HDLC over SONET
17	SDL with self-synchronization scrambler
18	Mapping of HDLC/LAPS
19	SDL with use of a set-reset scrambler
1A	10 Gbps Ethernet (IEEE 802.3)
1B	GFP
CF	Reserved (Obsolete HDLC/PPP framed)
E1 to FC	STS-1 w/1 VTx Payload Defects, STS-1 w/2 VTx Payload Defects, ... STS-1 w/28 VTx or STS-n/nc with Payload Defects
FE	Test Signal, ITU-T 0.181 specific mapping

G1: Status

The G1 byte provides a method to communicate the far-end path status back to the path originating equipment.

F2: User Channel

The User Channel provides a 64 Kbps channel for communication between two PTEs. This byte is only defined for the first STS-1 frame of a composite signal.

H4: Multiframe Indicator

The H4 byte provides a multiframe phase indication of a VT payload to identify phases of a SF as well as to convey the control packet information in VCAT.

Z3 and Z4: Growth

The Z3 and Z4 bytes are allocated for future growth.

N1: Tandem Connection

The N1 byte (formerly referred to as the Z5 byte) is allocated for Tandem Connection Maintenance and the Path Data Channel.

Glossary

SONET - VT Path Overhead

SONET - VT Path Overhead

V5: VT Path overhead

The V5 byte provides the same functions for VT paths that the B3, C2, and G1 bytes provide for STS paths.

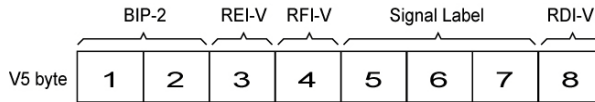

Note: If the signal label in V5 (bits 5, 6, and 7) is 101 the contents of the extended signal label is valid and contains in a 32 bit frame multiframe as shown below. See Z7 Structure shown below.

Z7 Structure

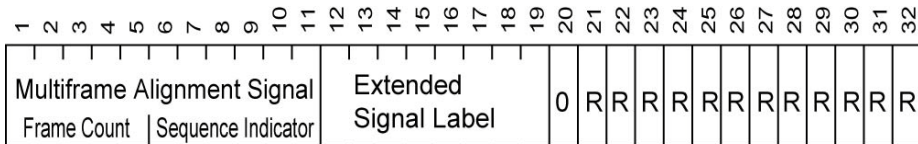

R = Reserved

J2: VT Path Trace

The J2 Trace byte provides a 16 byte fixed string allowing the receiving VT PTE to verify its continued connection to the intended transmitting VT PTE.

Z6: VT Path Growth

The Z6 byte is allocated for future growth.

Z7: VT Path Growth

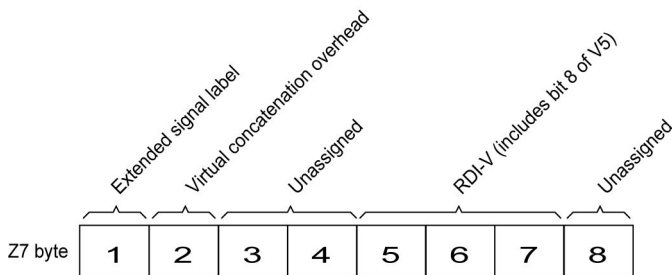

Bit 1 of the Z7 byte is allocated for an extended signal label. Bits 12 to 19 of the 32 bit frame multiframe (see *Z7 Structure* on page 626) contain the extended signal label.

Bit 2 of the Z7 byte is allocated for virtual concatenation. Bits 1 to 5 of the 32 bit frame multiframe (see *Z7 Structure* on page 626) contain the LO virtual concatenation frame count while bits 6 to 11 contain the LO virtual concatenation sequence indicator.

Bits 3, and 4 of the Z7 byte are unassigned and reserved for APS signaling for protection at the lower order path level.

Bits 5 through 7 of the Z7 byte in combination with bit 8 of V5 are allocated for RDI -V/ERDI-V signal.

Bit 8 of the Z7 byte is unassigned and reserved for a lower order path data link.

Glossary

SONET - VT Path Overhead

VT Payload Pointer

The VT Payload Pointer provides a method of allowing flexible and dynamic alignment of the VT SPE within the VT Superframe.

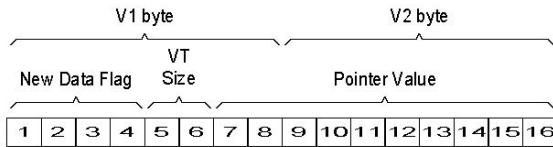

Normal Values

VT6	0	1	1	0	0	0	10 Bit Pointer Value								
VT3	0	1	1	0	0	1	10 Bit Pointer Value								
VT2	0	1	1	0	1	0	10 Bit Pointer Value								
VT1.5	0	1	1	0	1	1	10 Bit Pointer Value								

► New Data Flag

NDF is enabled when at least 3 out of 4 bits match “1001”.

NDF is disabled (normal value) when at least 3 out of 4 bits match “0110”.

► Pointer Value

The pointer value indicates the offset between the pointer word and the first byte for the VT SPE. The V1 through V4 bytes are not counted in the offset calculation. The pointer is a binary number with the following range:

Path	Range	
VT1.5	0	103
VT2	0	139
VT3	0	211
VT6	0	427

Glossary

SDH - Regenerator Section Overhead (RSOH)

SDH - Regenerator Section Overhead (RSOH)

The section contains regenerator section overhead information (RSOH) used by all SDH equipment along a network path, including signal regenerators.



A1 and A2: Framing

A1 and A2 indicate the beginning of the STM-N frame. They must appear in every STM-1 of a composite signal. The value in hexadecimal is F628.

J0: RS Trace Message

The J0 (Trace) byte is used to trace the origin of an STM-1 frame as it travels across the SDH network. This byte is only defined for the first STM-1 of an STM-N signal.

Z0: Growth

These bytes are reserved for future international standardization. They are located at positions S[1,6N+2] to S[1,7N] of an STM-N signal (N > 1).

B1: RS BIP-8

The BIP-8 (Bit-Interleaved Parity) byte provides section error monitoring. The byte is calculated by performing a routine even-parity check over all bits of the previous STM-N frame. This byte is only defined for the first STM-1 frame of a composite signal.

E1: RS Orderwire

The Orderwire provides a 64 kbps voice channel for communication between two STEs. This byte is only defined for the first STM-1 frame of a composite signal.

F1: RS User Channel

The User Channel byte is reserved for user purposes. This byte is only defined for the first STM-1 frame of a composite signal.

D1, D2 and D3: RS DCC (Data Communications Channel)

The Data Communication Channel (D1, D2 and D3) provides a 192 kbps data communication between two STEs for operation functions such as OAM&P. This byte is only defined for the first STM-1 frame of a composite signal.

Glossary

SDH - Multiplex Section Overhead (MSOH)

SDH - Multiplex Section Overhead (MSOH)

This section contains multiplex section overhead information (MSOH) processed by all SDH equipment along a network path, excluding signal regenerators.

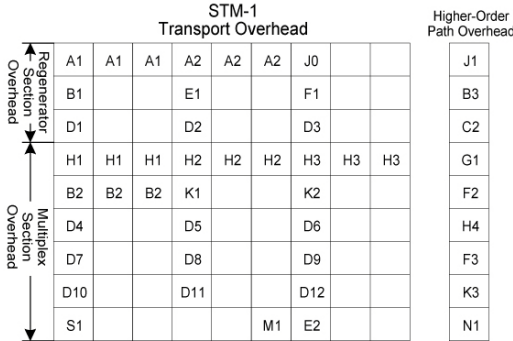

H1 and H2: Pointer

H1 and H2 bytes are combined to form a pointer indicating where the VC (Virtual Container) framed begins within each SPE.

H3: Pointer Action

H3 is an extra byte used to compensate for the SPE timing variation. The H1 and H2 pointer tell the receiver when the H3 pointer is used. This byte must be defined in every STM-1 of an STM-N signal in the event of negative justification, otherwise it is not defined.

B2: MS BIP-N*24

The MS BIP-N*24 (Bit-Interleaved Parity) byte provides line error monitoring. The byte is calculated by performing a routine even-parity check over all bits of the MSOH and the STM-N frame of the previous STM-N frame. Note that the RSOH is not used to calculate the parity check. This byte must be defined in every STM-1 of an STM-N signal.

K1 and K2: APS Channel (Automatic Protection Switching)

The K1 and K2 bytes communicate APS between two LTEs. This byte is only defined for the first STM-1 frame of an STM-N signal.

D4 through D12: MS DCC (Data Communications Channel)

The D4 through D12 bytes provides a 576 kbps data communications channel between two LTEs for administration, monitoring and other communications. These bytes are only defined for the first STM-1 frame of an STM-N signal.

S1: SSMB (Synchronization Status Message Byte)

Bits 5 to 8 of the S1 byte are used to carry the synchronization messages of the SDH device. This byte is only defined for the first STM-1 frame of an STM-N signal.

M1: MS-REI (Remote Error Indicator)

The M1 byte of a STM-1 or the first STM-1 of an STM-N signal is used for MS layer Remote Error Indication (MS-REI). This byte is located in the third STM-1 of an STS-N signal ($N > 1$).

E2: MS Orderwire

The MS Orderwire provides a 64 kbps voice channel for communication between LTEs. This byte is only defined for the first STM-1 frame of an STM-N signal.

Glossary

SDH - Higher-Order Path Overhead (HP-POH)

SDH - Higher-Order Path Overhead (HP-POH)

This section contains higher-order path overhead information (HPOH) processed by SDH STM-1 terminating equipment.

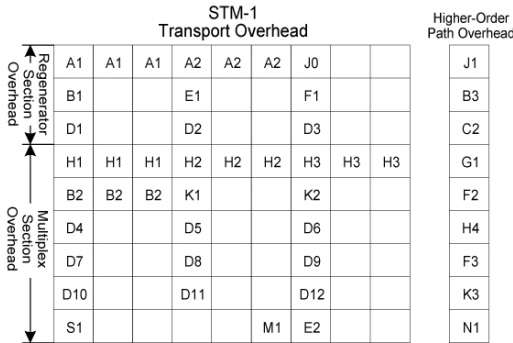

J1: Higher-Order VC-N Path Trace

The higher-order VC-N path trace byte provides a 64 byte fixed string to verify connection between path transmitting equipment and path receiving equipment.

B3: Path BIP-8

The path BIP-8 (Bit-Interleaved Parity) byte provides path error monitoring. The byte is calculated by performing a routine even-parity check over all bits of the previous SPE.

C2: Path Signal Label

C2 specifies the mapping type in the VC-N.

C2 (Hex.)	Description
00	Unequipped or supervisory-unequipped
01	Reserved (Equipped - Non-Specific)
02	TUG Structure
03	Locked TU-n
04	Asynchronous Mapping of 34M/45M in C-3
05	Experimental Mapping
12	Asynchronous Mapping of 140M in C-4
13	ATM Mapping
14	MAN DQDB
15	FDDI [3]-[11] Mapping
16	Mapping of HDLC/PPP
17	Reserved (SDL self-synch scrambler)
18	Mapping of HDLC/LAPS
19	Reserved (SDL set-reset scrambler)
1A	Mapping of 10 Gbps Ethernet (IEEE 802.3)
1B	GFP
1C	Mapping 10 Gbps FC
20	Asynchronous Mapping of ODUk
CF	Reserved (obsolete HDLC/PPP framed)
FE	Test Signal, ITU-T 0.181 specific mapping
FF	VC-AIS (TCM)

Glossary

SDH - Higher-Order Path Overhead (HP-POH)

G1: Path Status

The G1 byte provides a method to communicate the far-end path status back to the path originating equipment.

F2: Path User Channel

The Path User Channel provides a 64 kbps channel for communication between two PTEs. This byte is only defined for the first STM-1 frame of an STM-N signal.

H4: Position and Sequence Indicator

The H4 byte provides a multiframe phase indication of a VC-3/4 payload to identify phases of a SF as well as to convey the control packet information in VCAT.

F3: Path User Channel

The Path User Channel provides a channel for communication purposes between path elements and is payload dependent.

K3: APS Signaling

Bits 1 to 4 of the K3 byte are used for APS signaling. K3 bits 5 to 8 are reserved for future use.

N1: Network Operator (TCM)

The N1 byte is allocated to provide a Higher-Order Tandem Connection Monitoring (HO-TCM) function.

SDH - Lower-Order Path Overhead

V5: VC Path Overhead

The V5 byte provides the same functions for VC paths overhead that the B3, C2, and G1 bytes provide for STM paths.



Note: If the signal label in V5 (bits 5, 6, and 7) is 101 the contents of the extended signal label is valid and contains in a 32 bit frame multiframe. See K4 Structure shown below.

K4 Structure

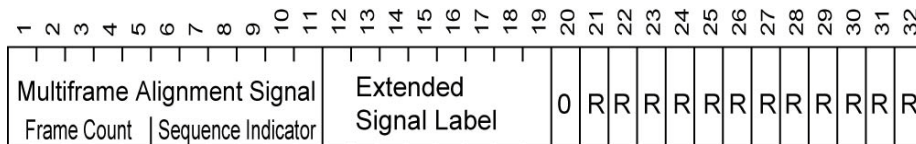

R = Reserved

J2: Path Trace

The J2 byte is used to repetitively transmit a Lower-Order Access Path Identifier so that a path receiving terminal can verify its continued connection to the intended transmitter.

N2: Network Operator Byte

The N2 byte is allocated for Tandem Connection Monitoring for the VC2, VC-12, and VC-11 level.

Glossary

SDH - Lower-Order Path Overhead

K4: Extended Signal Label

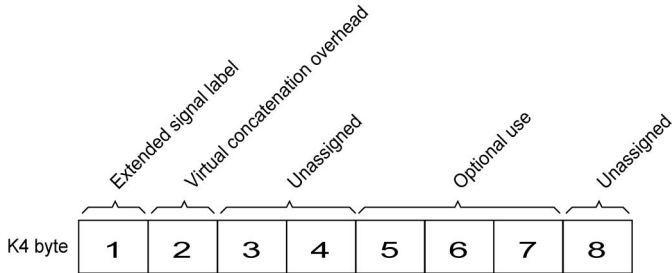

Bit 1 of the K4 byte is allocated for an extended signal label. Bits 12 to 19 of the 32 bit frame multiframe (see *K4 Structure* on page 637) contain the extended signal label.

Bit 2 of the K4 byte is allocated for virtual concatenation. Bits 1 to 5 of the 32 bit frame multiframe (see *K4 Structure* on page 637) contain the LO virtual concatenation frame count while bits 6 to 11 contain the LO virtual concatenation sequence indicator.

Bits 3, and 4 of the K4 byte are unassigned and reserved for APS signaling for protection at the lower order path level.

Bits 5 through 7 of the K4 byte are allocated for optional use.

Bit 8 of the K4 byte is unassigned and reserved for a lower order path data link.

VT Payload Pointer

The VT Payload Pointer provides a method of allowing flexible and dynamic alignment of the VT SPE within the VT Superframe.

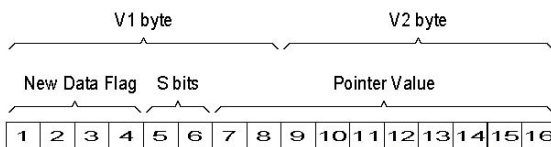

TU-2

0	1	1	0	0	0
---	---	---	---	---	---

 10 Bit Pointer Value

TU-12

0	1	1	0	1	0
---	---	---	---	---	---

 10 Bit Pointer Value

TU-11

0	1	1	0	1	1
---	---	---	---	---	---

 10 Bit Pointer Value

► New Data Flag

NDF is enabled when at least 3 out of 4 bits match “1001”. NDF is disabled when at least 3 out of 4 bits match “0110”.

► Pointer Value

The pointer value indicates the offset between the V2 byte and the first byte of the VC-2/VC-1. The pointer bytes are not counted in the offset calculation. The pointer is a binary number with the following range:

Path	Range	
TU-2	0	427
TU-12	0	139
TU-11	0	103

10G Ethernet

The OTN Overclocked technology provides the capability to transparently transport 10G base-R Ethernet signals into OPU2 as specified in ITU-T. Two optical rates are provided:

- 11.0957 Gbits/s, +/- 100 ppm, designated OTU2e
- 11.0491 Gbits/s, +/- 100 ppm, designated OTU1e

The OTU2e uses the mapping scheme of CBR10G into OPU2 as defined in G.709. The client signal, 10GbE LAN and the OPU fixed stuff bytes are accommodated into an OPU-like signal designated OPU2e. This signal is then wrapped in an ODU2e and then in an OTU2e signal.

The OTU1e uses the mapping scheme of CBR2G5 into OPU1 as defined in G.709. The client signal, 10GbE LAN is accommodated into an OPU-like signal designated OPU1e (note that the fixed stuff bytes are not left free) this is why the 10GbE signal can be transported at a lower rate than OTU2e. This signal is then wrapped in an ODU1e and then in an OTU1e signal.

The transparent transport of the 10G base-R means that the full 10G Ethernet data rate i.e. 10.3125 Gb/s is transported over OTN. This means that the following information is transported:

- PCS 64B/66B coded information
- IPG (inter-frame filler), MAC FCS, Preamble and SFD (start of frame delimiter) and Ordered Sets (Remote Fault indication)

The OTN clocking is derived from the Ethernet client signal which is +/- 100 ppm, this is outside the clock tolerance allocated by the G.709 standard which translates in unspecified jitter performance thus limiting the application to Point to Point data path.

The following figure presents a typical network application

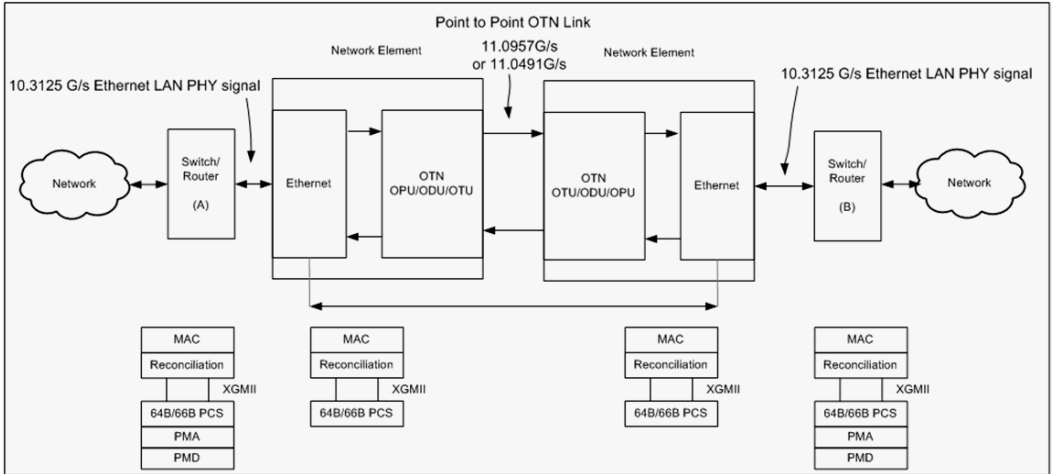

The following figure presents a typical test application.

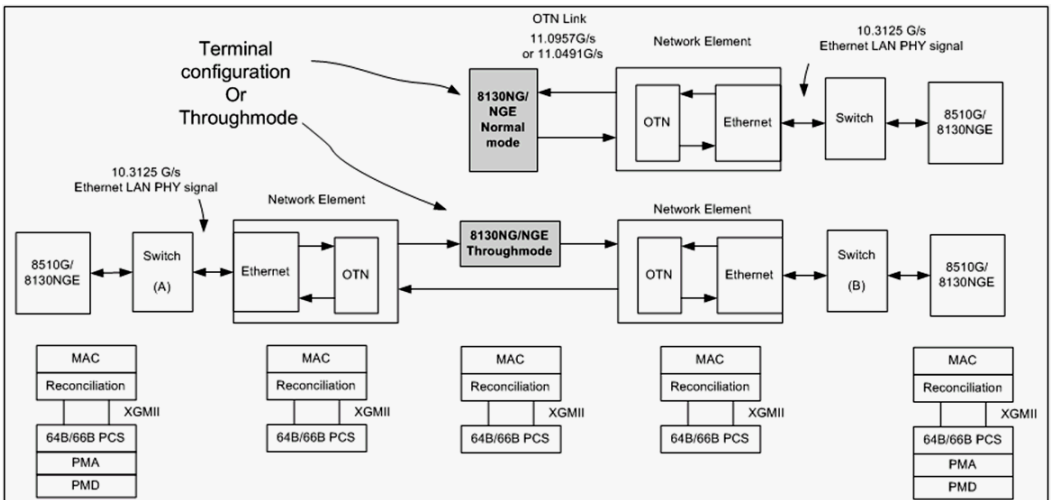

Glossary

10G Ethernet

The Ethernet layer provides the equivalent functionality of the BERT Framed Layer 2 Test application supported on EXFO's Datacom product family with the particularity that there is no Ethernet Physical port as such. The Ethernet frame has its Ethertype field set to 0x88B7.

VLAN

Special VID/B-VID values (IEEE Std 802.1Q-1998)

ID	Description
0	The null VLAN ID. Indicates that the tag header contains only user priority information; no VLAN identifier is present in the frame. This VID value must not be configured as a PVID, configured in any Filtering Database entry, or used in any Management operation.
1	The default PVID value used for classifying frames on ingress through a Bridge Port. The PVID value can be changed on a per-Port basis.
4095	Reserved for implementation use. This VID value shall not be configured as a PVID, configured in any Filtering Database entry, used in any Management operation, or transmitted in a tag header.

VLAN/B-VLAN Priority

0	000 - Low Priority	4	100 - High Priority
1	001 - Low Priority	5	101 - High Priority
2	010 - Low Priority	6	110 - High Priority
3	011 - Low Priority	7	111 - High Priority

Next-Gen - Generic Framing Procedure (GFP)

Generic framing procedure (GFP), defined in ITU recommendation G.7041/Y.1303, is a framing mechanism to transport packet-based client signals, such as Ethernet, Fibre Channel, ESCON, FICON, over fixed-data-rate optical channels. As such, GFP provides a single, flexible mechanism to map these client signals into SONET/SDH and OTN networks, as shown in figure below.

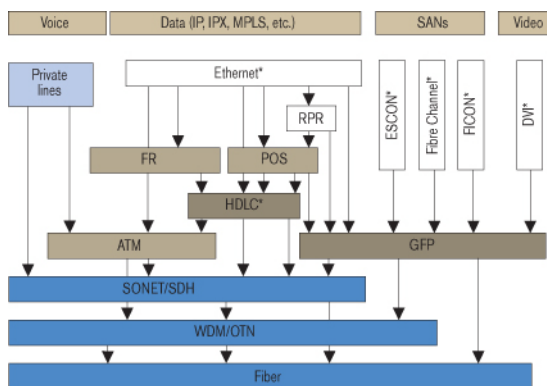

Client Signal Mapping over GFP

Prior to the introduction of GFP, several methods had been used to transport packet services over SONET/SDH networks. The first method was Asynchronous Transfer Mode (ATM) Adaptation Layer 5 (AAL 5) over SONET/SDH. ATM is a very efficient switching and multiplexing technology, whose transfer rates scale with SONET/SDH rates. However, ATM does not make the most efficient use of bandwidth because the payload data is separated into groups of 48 bytes, called cells, with an additional 5-byte header of software overhead. It became immediately apparent that almost 10% of the bandwidth would be lost. In addition, certain types of data required even more ATM overhead.

Glossary

Next-Gen - Generic Framing Procedure (GFP)

Other methods have focused on using point-to-point protocol (PPP). The IP traffic coming to an Ethernet port is encapsulated over a PPP link and multiple ports can be encapsulated over multilink PPP (ML-PPP) links. By using an HDLC framing, the PPP traffic is transported over the SONET/SDH payload. These methods have been standardized within the IETF through the following Requests for Comments (RFC): RFC 1662, RFC 1990 and RFC 2615. The ITU-T expanded this work by specifying the use of LAPS (very similar protocol to PPP/HDLC) and specifying IP over LAPS in X.85/Y.1321 and Ethernet over LAPS in X.86/Y.1323. All these methods for encapsulating traffic suffer from the weaknesses of HDLC framing; i.e., limited protection from frame corruption and the introduction of variable packet sizes because of its trailer.

GFP has been standardized to better optimize the transport of Ethernet and other data services over SONET/SDH networks, taking into account both the pros and cons of ATM and PPP/HDLC and leveraging two new emerging SONET/SDH capabilities, VCAT and LCAS, that will be discussed later in this document.

GFP Mapping

Two types of mapping are currently available for GFP: framed-mapped (GFP-F) and transparent-mapped (GFP-T), whose mappings keep the same basic frame structure, as will be shown in the next sections. The decision on which mode to use is dependent on the underlying service to be transported.

- **Frame-Mapped GFP (GFP-F):** mapping mechanism in which one client signal frame is received and mapped in its entirety into one GFP frame. Therefore, with this adaptation mode, the GFP-F frame size is variable as it is directly related to the incoming client payload. In fact, with GFP-F, the entire client frame must be buffered in order to determine its length. GFP-F is usually used to support Layer 2 frames like Ethernet MAC that are tolerant to some latency. The ITU G.7041 defines the following frame-mapped user payloads supported through GFP-F:
 - Frame-Mapped Ethernet
 - Frame-Mapped PPP
 - Frame-Mapped Multiple Access Protocol over SDH (MAPOS)
 - Frame-Mapped IEEE 802.17 Resilient Packet Ring
 - Frame-Mapped Fibre Channel FC-BBW
- **Transparent-Mapped GFP (GFP-T):** mapping mechanism that facilitates the transport of 8B/10B block-coded client signals like Gigabit Ethernet (GbE), Fibre Channel, ESCON, FICON, and DVB-ASI. With GFP-T, individual characters of a client signal are decoded from the client signal and then mapped into fixed-size GFP frames (64B/65 coded superblocks). This approach avoids the buffering of an entire client frame before it can be mapped into a GFP frame, which reduces latency and in turn makes it ideally suited for SAN applications that require very low transmission latency.

Glossary

Next-Gen - Generic Framing Procedure (GFP)

The figure *GFP-T vs GFP-F Features* below provides a functional comparison between GFP-F and GFP-T, while figure *GFP-T vs. GFP-F Frames* below provides a comparison of the GFP frames for both modes.

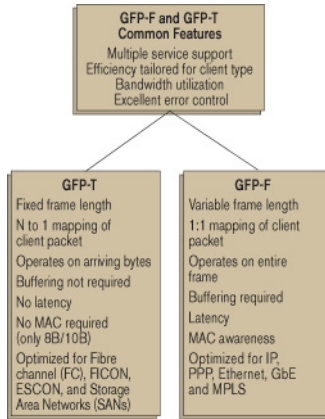

GFP-T vs GFP-F Features

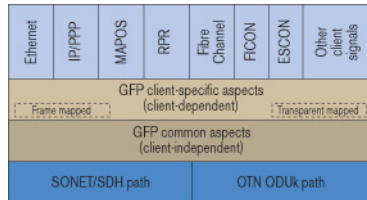

GFP-T vs. GFP-F Frames

Functionally, GFP consists of both common and client-specific aspects. Common GFP aspects apply to all GFP-adapted traffic (i.e., both GFP-F and GFP-T) and cover functions such as packet data unit (PDU) delineation, data link synchronization and scrambling, client PDU multiplexing, and client-independent performance monitoring. Client-specific aspects of GFP cover issues such as mapping of the client PDU into the GFP payload, client-specific performance monitoring, as well as operations, administration, and maintenance (OA&M). This is illustrated in figure *Client Signal Mapping over GFP* on page 643.

GFP Frame Structure

As illustrated in figure below, Two basic GFP frame types have been defined: GFP client frames and GFP control frames. GFP client frames are categorized into two types: client data frames (CDFs) and client management frames (CMFs). CDFs are used to transport the client data, while CMFs are used to transport information associated with the management of the client signal or GFP connection.

As for GFP control frames, at this time, only one category has been defined by the standard so far; i.e., GFP idle frames.

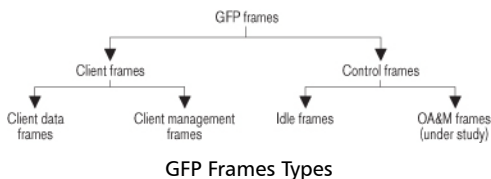

Glossary

Next-Gen - Generic Framing Procedure (GFP)

The GFP generic frame structure is presented in figure below.

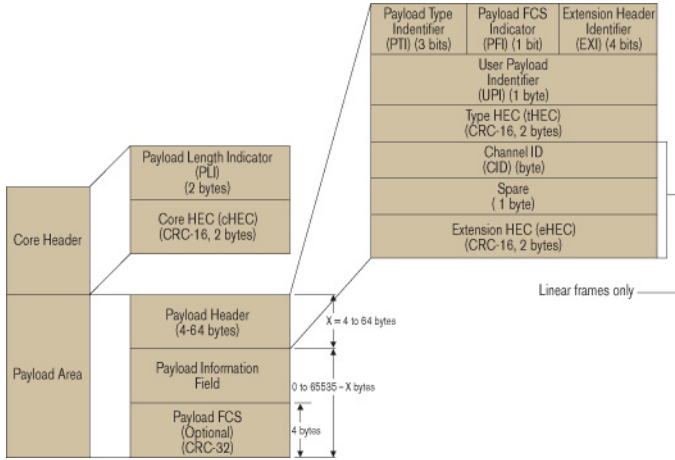

GFP Generic Frame Structure

Each GFP frame type consists of three main components: the core header, the payload header, and the payload information field.

The core and payload headers form the GFP header, whereas the payload information field represents the customer traffic carrying the data services. The payload header carries information about the payload type (i.e., Ethernet, Fibre Channel, etc.) that it is carrying, while the core header carries information about the size of the GFP frame itself.

Each header contains a header error correction (HEC) calculation, allowing for the correction of single errors; that is, any errors that occur in the core header or in the payload header can potentially be corrected by the HEC, through the network element. This creates a very robust mapping scheme, which ensures that GFP frames can get transported across a network without customer traffic loss.

➤ **Core Header**

The GFP core header consists of a two-octet length field, specifying the length of the GFP frame's payload area in octets, and a two-octet field containing a CRC-16 error-check code.

- **Payload Length Indicator (PLI):** The PLI is a two-byte field indicating the size in bytes of the GFP payload area. It indicates the beginning of the next GFP frame in the incoming bit-stream as an offset from the last byte in the current GFP core header. PLI values in the range of 0 to 3 are reserved for GFP internal use and are referred to as GFP control frames. All other frames are referred to as GFP client frames.
- **Core HEC (cHEC):** The cHEC is a two-byte field containing a cyclic redundancy check (CRC-16) sequence that protects the integrity of the core header. The cHEC sequence is computed over the core header bytes using standard CRC-16. The CRC-16 enables both single-bit error correction and multibit error detection.

➤ **Payload Header**

The payload header is a variable-length area, 4 to 64 octets long, intended to support data-link management procedures specific to the transported client signal. The payload header contains two mandatory fields, the Type field and Type Header Error Correction (tHEC) field. The payload header also supports an additional variable number of subfields referred to, as a group, as the extension header.

- **Payload Type Identifier (PTI):** A three-bit subfield that identifies the type of GFP client frame. The following table lists the currently defined user frames.

PTI	Description
000	Client Data Frame
100	Client Management Frame
Others	Reserved

Glossary

Next-Gen - Generic Framing Procedure (GFP)

- **Payload FCS Indicator (PFI):** A one-bit subfield indicating the presence (1) or absence (0) of the payload FCS field. The following table lists the currently defined PFI values.

PFI	Description
0	FCS Absent
1	FCS Present

- **Extension Header Identifier (EXI):** A four-bit subfield identifying the type of GFP extension header. Three kinds of extension headers are currently defined:

EXI	Description	Function
0000	Null Extension Header	Indicates that no extension header is present.
0001	Linear Extension Header	A two-octet extension header that supports sharing of the GFP payload across multiple clients in a point-to-point configuration. The linear extension header consists of an eight-bit channel ID (CID) field, used to indicate one of 256 communication channels (i.e. clients) at a GFP termination point, and an eight-bit spare field reserved for future use.
0010	Ring Extension Header	The use of this field is under consideration. Similar to linear, the current proposal being considered is to allow the sharing of the GFP payload across multiple clients; however, this would only apply to ring configurations.
0011 to 1111	Reserved	

- **User Payload Identifier (UPI):** An eight-bit field identifying the type of payload conveyed in the GFP payload information field:

UPI	Client Data	Client Management
0000 0000 1111 1111	Reserved and not available	Reserved
0000 0001	Mapped Ethernet Frame	Client Signal Fail (Loss of Client Signal)
0000 0010	Mapped PPP Frame	Client Signal Fail (Loss of Character Synchronization)

Glossary

Next-Gen - Generic Framing Procedure (GFP)

UPI	Client Data	Client Management
0000 0011	Transparent Fibre Channel	Reserved for future use
0000 0100	Transparent FICON	
0000 0101	Transparent ESCON	
0000 0110	Transparent GbE	
0000 0111	Reserved for future use	
0000 1000	Frame-Mapped IEEE 802.17 Resilient Packet Ring	
0000 1011	Frame-Mapped Fibre Channel FC-BBW	
0000 1100	Asynchronous Transparent Fibre Channel	
0000 1101	Framed MPLS Unicast	
0000 1110	Framed MPLS Multicast	
0000 1111	Framed IS-IS	
0001 0000	Framed IPv4	
0001 0001	Framed IPv6	
0001 0010	Framed DVD-ASI	
0001 0011	Framed 64B/66B Ethernet	
0001 0100	Framed 64B/66B Ethernet Ordered Set	
0001 0101 through 1110 1111	Reserved for future standardization	
1111 0000 through 1111 1110	Reserved for proprietary use	

- **Type HEC (tHEC) Field:** A two-octet field that contains a CRC-16 sequence to protect the integrity of the type field. The tHEC sequence is computed over the core header bytes using standard CRC-16. As with the cHEC, CRC-16 enables both single-bit error correction and multibit error detection.
- **Channel Identifier (CID):** A one-byte field that is only available when the EXI field is configured to Linear. The CID byte is used to indicate one of 256 communication channels at a GFP termination point.
- **Spare:** A one-byte field that is only available when the EXI field is configured to Linear. This field is reserved for future use.
- **Extension HEC (eHEC):** A two-byte field that contains a CRC-16 check sequence that protects the integrity of the contents of the extension. CRC-16 enables both single-bit correction and multibit error detection.

The figure below explains how (in GFP-F) the transmitter encapsulates one entire frame of the client data.

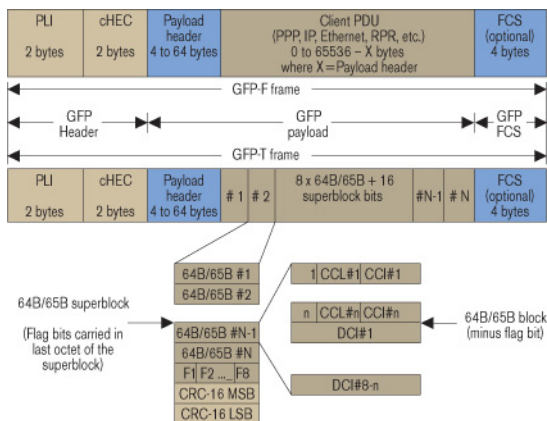

GFP-F vs. GFP-T Frame Structure

Glossary

Next-Gen - Generic Framing Procedure (GFP)

► **Payload Information Field**

The payload area (also referred to as payload information field) contains the framed client signal. This variable-length field may include from 0 to 65,535 – X octets, where X is the size of the payload header (including the extension header, if present) and the payload FCS field (if present).

Figure *GFP-T vs. GFP-F Frames* on page 646 shows the GFP-T and GFP-F frame structures. As shown, Both GFP-T and GFP-F frame types share a common core header, payload header, and payload FCS (optional), and they differ in the way in which the client is mapped into this payload area.

► **Payload FCS (pFCS)**

This is an optional four-octet-long frame-check sequence. It contains a CRC-32 check sequence that is designed to validate the entire content of the payload area. The FCS field presence is signalled by the PFI bit located in the Type field of the payload header. The FCS does not correct any errors; it just indicates the presence of error(s).

In GFP-F, the transmitter encapsulates one entire frame of the client data into one GFP frame. In this case, the basic frame structure of a GFP client frame is used, including the required payload header.

In GFP-T, however, rather than buffering an entire client-data frame, the individual characters of the client signal are demapped from the client block codes and then mapped into periodic fixed-length GFP frames. The transparent GFP client frame uses the same structure as the frame-mapped GFP, including the required payload header.

GFP Summary

GFP has been standardized to better optimize the transport of Ethernet and other data services over SONET, taking into account both the pros and cons of ATM and PPP/HDLC framing mechanisms. As described in this section, GFP represents a robust mapping mechanism that allows for the mapping of multiple client-data types into SONET/SDH payload (SPEs). This technology has been embraced by network equipment and service providers as it provides an efficient way of providing interoperable data-services transport over the existing SONET/SDH install base. The versatility provided by GFP allows SONET/SDH networks to offer transport services for a multiple of services, as shown in figure below.

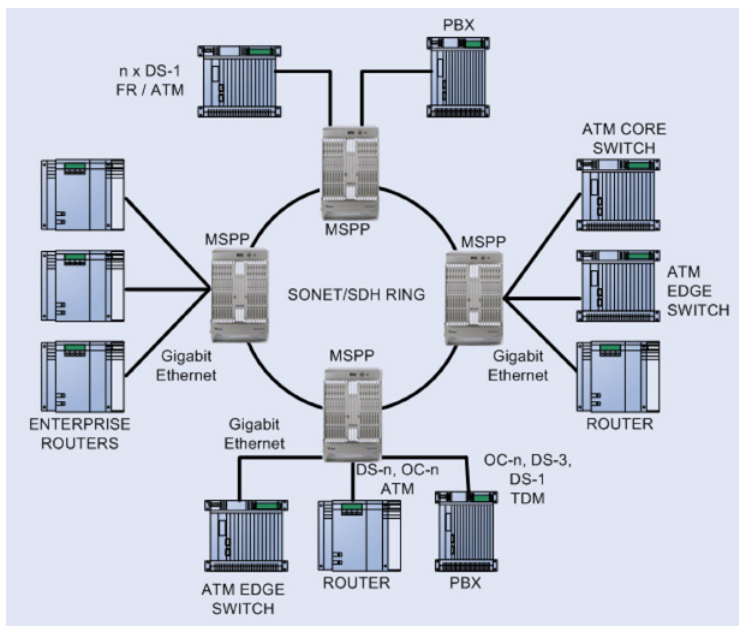

Multiservice SONET/SDH Network

That being said, the answer to a truly efficient packet-transport mechanism comes via the combination of GFP and a bandwidth-optimizing technology such as VCAT or LCAS, as we will see in the next sections.

Glossary

Next-Gen - Virtual Concatenation (VCAT)

Next-Gen - Virtual Concatenation (VCAT)

SONET/SDH multiplexing combines low-speed digital signals (DS1, DS2, DS3 for SONET; E1, E3, and E4 for SDH) with the required overhead to form building-block frames called STS-1 SPE (SONET) and STM-1 (SDH). To enable higher-bandwidth transport than these basic rates allow individually, multiple SPEs can be combined and transported across the SONET/SDH network as a single connection, with the first SONET container payload pointer set to normal mode and the subsequent payload pointers set to concatenation mode, thus linking all the units together.

The following table outlines supported contiguous concatenation for both SONET and SDH. For the SONET standard, these are denoted as STS-Xc, and for SDH as VC-4-Xc.

SONET	SDH	Payload Capacity (Mb/s)
STS-1	VC-3	48.38
STS-3c	VC-4	149.76
STS-6c	VC-4-2c	299.52
STS-9c	VC-4-3c	449.28
STS-12c	VC-4-4c	599.04
STS-24c	VC-4-8c	1198.08
STS-48c	VC-4-16c	2396.16
STS-192c	VC-4-64c	9584.64

Lower-rate virtual tributary signals have also been defined for both SONET and SDH, as shown in the table below:

SONET	SDH	Payload Capacity (Mb/s)
VT 1.5	VC-11	1.6
VT 2	VC-12	2.17
VT 6	VC-2	6.78

Although contiguous concatenation has been successfully introduced and deployed for years, it poses some major deficiencies when attempting to transport packet-based signals. First, in contiguous concatenation, the concatenated bandwidth requires the timeslots to be consecutive. Second, it also requires that the network elements involved in the transport of the traffic support this function from the source to the destination node, including every intermediate node. Third, data-service rates are not well matched to these defined containers, hence using GFP with current contiguous concatenation schemes results in sub-optimal use of the bandwidth, as Ethernet and Fibre Channel data rates are not properly matched to these channels (e.g., 100M Ethernet service mapped over an STS-3c or VC4 results in approximately 33% of wasted bandwidth).

To address these limitations, a complementary technology — virtual concatenation (VCAT) — was developed and later defined in ANSI T1.105, ITU G.707, and ITU G.783 recommendations. Two forms of virtual concatenation were defined; i.e., high-order and low-order VCAT. This introduced additional flexibility to SONET/SDH by allowing for the non-contiguous concatenation of high-order or low-order payload frames to better scale the requirements for incremental client-data streams. This means that the concatenated payload does not need to be formed by consecutive timeslots in the transport path. In addition, this new concatenation capability allows the network element involved in the

Glossary

Next-Gen - Virtual Concatenation (VCAT)

transport of the traffic to be unaware of concatenated nature of the signal. As such, only the termination points in the transport path must support the VCAT functionality.

In essence, virtual concatenation is an inverse multiplexing procedure whereby the contiguous bandwidth is broken into individual SPEs at the source transmitter and logically represents them in a virtual concatenation group (VCG). Control packets, which contain the necessary information for reassembling the original data stream at its destination PTE, are inserted in some of the currently unused SONET/SDH overhead bytes (H4 byte for high-order, and Z7 (SONET) and K4 (SDH) for low-order). This information contains the sequence order of the channels and a frame number, which is used as a time stamp. The VCG members are transported as individual SPEs across the SONET/SDH network with all the intelligence required to handle virtual concatenation located at the end points of the connections (i.e., at the path termination equipment, or PTE). The receiving end-point (PTE) is responsible for reassembling the original byte stream. This allows SONET/SDH channels to be routed independently through the network without requiring any acknowledgement of the virtual concatenation. In this manner, virtually concatenated channels may be deployed on the existing SONET/SDH network with a simple end-point node upgrade.

As presented in the table below, VCAT provides a much more efficient use of the transport bandwidth for data user interfaces. With VCAT, an OC-48 link can carry two full Gigabit Ethernet signals with 95% of the link used through seven virtual STS-3c/VC-4s each, instead of just one Gigabit Ethernet signal with 42% of the link used through an STS-48c/AU-4-16c.

Service	Bit Rate	Utilization	Utilization with VCAT
Ethernet	10 Mb/s	STS-1/VC-3 (20%)	VT1-5-7v (89%)/VC12-12v (92%)
Fast Ethernet	100 Mb/s	STS-3c/VC-4 (67%)	STS-1-2v/VC-3-2v (100%)
Gigabit Ethernet	1000 Mb/s	STS-48c/VC-4-16c (42%)	STS-3c-27v/VC-4-7v (95%)
Fibre Channel	200 Mb/s	STS-12c/VC-4-4c (33%)	STS-1-4v/VC-3-4v (100%)
Fibre Channel	1000 Mb/s	STS-48c/VC-4-16 (42%)	STS-3c-27v/VC-4-7v (95%)
ESCON	200 Mb/s	STS-12c/VC-4-4c (33%)	STS-1-4v/VC-3-4v (100%)

In summary, virtual concatenation enables SONET/SDH transport pipes to be filled more efficiently with data services by grouping individual SONET/SDH containers into a virtual high-bandwidth “link”, matched to the required service bandwidth. The following sections will provide a more in-depth look at the inner workings of high-order and low-order VCAT frame structures.

High-Order Virtual Concatenation (HO VCAT)

HO VCAT provides bandwidth for links that require speeds greater than 51.84 Mb/s, but do not lend themselves to one of the standard contiguous concatenation bandwidth configurations. HO VCAT is realized under SONET and SDH by the PTE, which combines either multiple STS-1/STS-3c SPEs (for SONET) or VC-3/VC-4s (for SDH), therefore making it ideally suited for transport of 100M, Gigabit Ethernet, and Fibre Channel rates.

HO VCAT rates are designated by STS-m-nv or VC-m-nv, where the nv indicates a multiple n of the STS-m/VC-m base rate.

► HO VCAT Frame Structure

As mentioned, a HO VCG super-container can be formed by using STS-1 or STS-3c in SONET and VC-3 (AU-3) or VC-4 (AU-4) in SDH. This means that a SONET virtually concatenated payload STS-1/3c-Xv or an SDH VC-3/4-Xv can transport $X \cdot 48384/149760$ kb/s, as shown respectively in figure *STS-1/3c-Xv VCG* on page 661 and figure *VC-3/4-Xv VCG* on page 661, assuming the stuff bytes remain untouched.

In either case, the value of X can be between 1 and 256. Each SONET SPE or SDH VC used to create a VC contains its individual path overhead (POH). Among these bytes is the H4 byte, used to specify the virtual concatenation multiframe indicator (MFI) and sequence indicator (SQ).

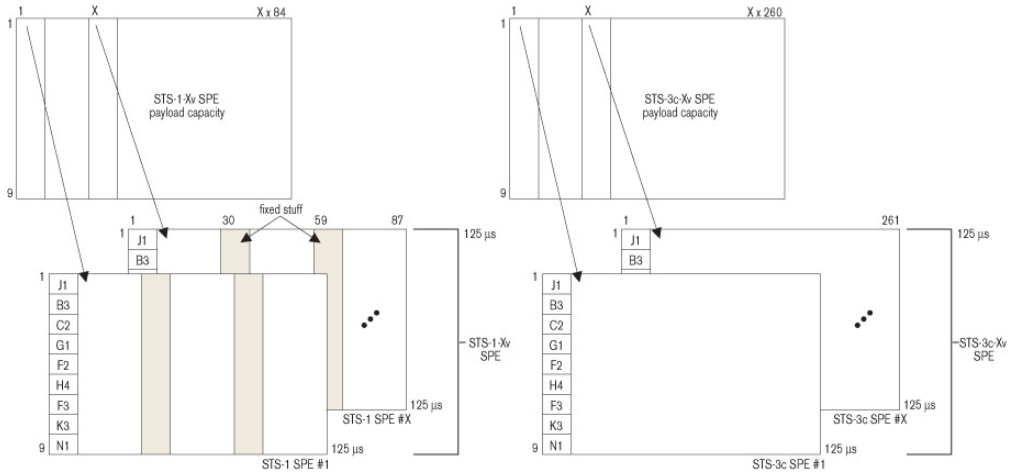

STS-1/3c-Xv VCG

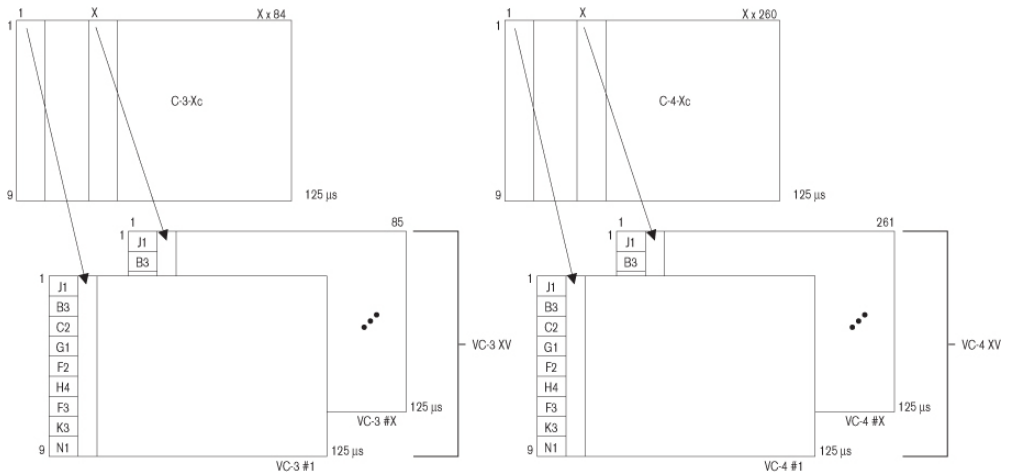

VC-3/4-Xv VCG

Glossary

Next-Gen - Virtual Concatenation (VCAT)

➤ HO VCAT Multiframe Indicator (MFI)

As illustrated in figure below, A two-stage multiframe mechanism is used to cover differential delays of 0 μ s to 256 ms. The two stages can be functionally represented by a 12-bit counter. In the H4 structure, Bits 5 to 8 of H4 bytes are used to form Multiframe Indicator Stage 1 (MFI1). MFI1 is incremented for every basic frame and counts from 0 to 15. Multiframe Indicator Stage 2 (MFI2) is an eight-bit counter based on Frame 0 (bits 1 to 4) and Frame 1 (bits 5 to 8). MFI2 is incremented once every time MFI1 completes a cycle from 0 to 15. MFI2 counts from 0 to 255. The result is a two-stage multiframe process that yields a total of 4096 frames (16 x 256 = 4096) per 512-ms cycle (4096 x 125 μ s = 512 ms).

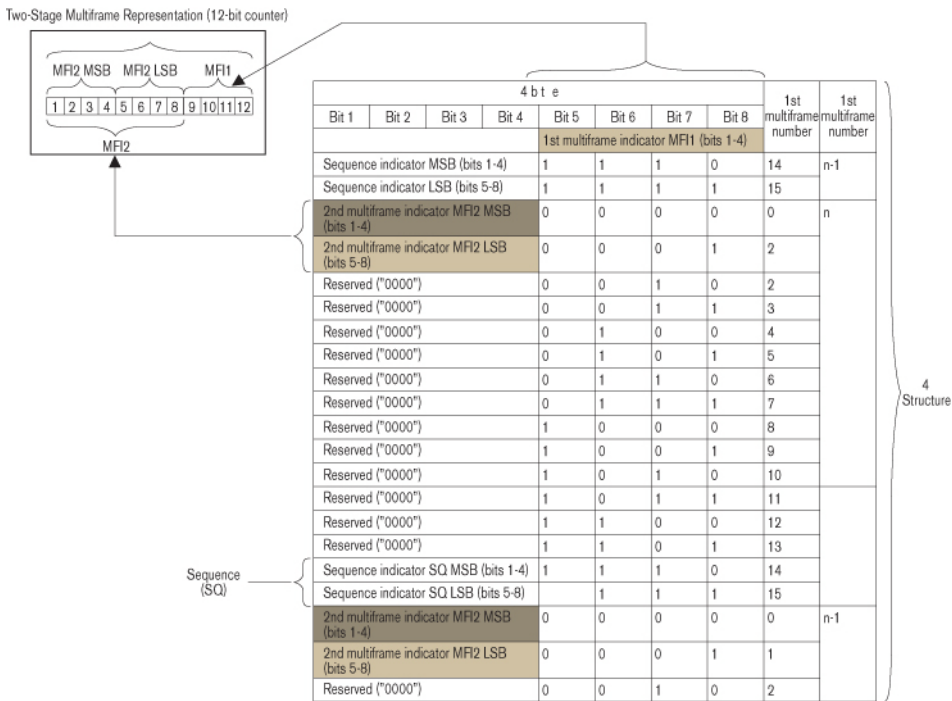

H4 High-Order Path Multiframe Structure

► High-Order Path Sequence Indicator

In addition to the MFI, the H4 byte also carries the sequence indicator information. The sequence indicators are assigned by the source node (PTE) and interpreted by destination node (PTE). The sequence indicator (SQ) identifies the order in which the STS-1/STS-3c of a SONET STS-1/STS-3c-Xv is assembled to create the contiguous container (STS-1/STS-3c-Xc), as demonstrated in figure below. Similarly, SQs are used to identify the order of VC-3/VC-4s used to create the VC-3/4-Xc in SDH.

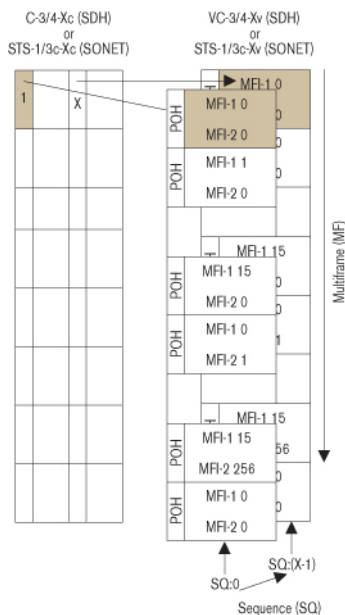

Sequence Indicator in High-Order Path VCAT Multiframe

The eight-bit SQ, supporting a range from 0 to 255, is formed by using the H4 bytes (bits 1 to 4 of frame 14 and 15) in the first multiframe stage (MFI1), as shown in figure *H4 High-Order Path Multiframe Structure* on page 662. Each VCG member is assigned an SQ. Normally, the first timeslot associated to a VCG, composed of STS-1/3c-Xv or VC-3/4-Xv, is

Glossary

Next-Gen - Virtual Concatenation (VCAT)

assigned number 0, the second one is assigned number 1, and so on for the remainder of the VCG, up to X-1. So, for a STS-1-21v the sequence indicator would go from 0 to 20.

In the event that the terminating equipment is unable to recover the frame or the sequence, or if there is too much differential delay, the system is equipped to generate alarms (LOA and LOS) to the management system to highlight these conditions.

Low-Order Virtual Concatenation (LO VCAT)

LO VCAT provides bandwidth for links that require speeds greater than 1.6 Mb/s (VT 1.5/VC-12), but less than 51.84 Mb/s. LO VCATs are designated by VT-1.5/2/6-nv for SONET and VC-11/12-nv for SDH.

LO VCAT is typically used for sub-rate 10M, sub-rate 100M, and 100 Mb/s Ethernet data services.

➤ LO VCAT Frame Structure

As described above, low-order paths are used to form VCGs to transport payloads that do not efficiently fit into HO VCAT STS-1/3c or SDH VC-3/VC-4 containers. These LO VCAT payloads are defined in the following table.

SONET	SDH	Rate	Capacity
VT1.5	VC-11	1600 kb/s	1600 to 102400 kb/s
VT2	VC-12	2176 kb/s	2176 to 139264 kb/s
VT3	-	3328 kb/s	3328 to 212992 kb/s
VT6	VC-2	6784 kb/s	6784 to 434176 kb/s

A VCG can be created by using the SONET VTn-Xv or the SDH VC-11/12-Xv, where the value of X can range between 1 and 64 (see figure *SONET VTn-Xv* on page 665 and *SDH VCn-Xv* on page 665).

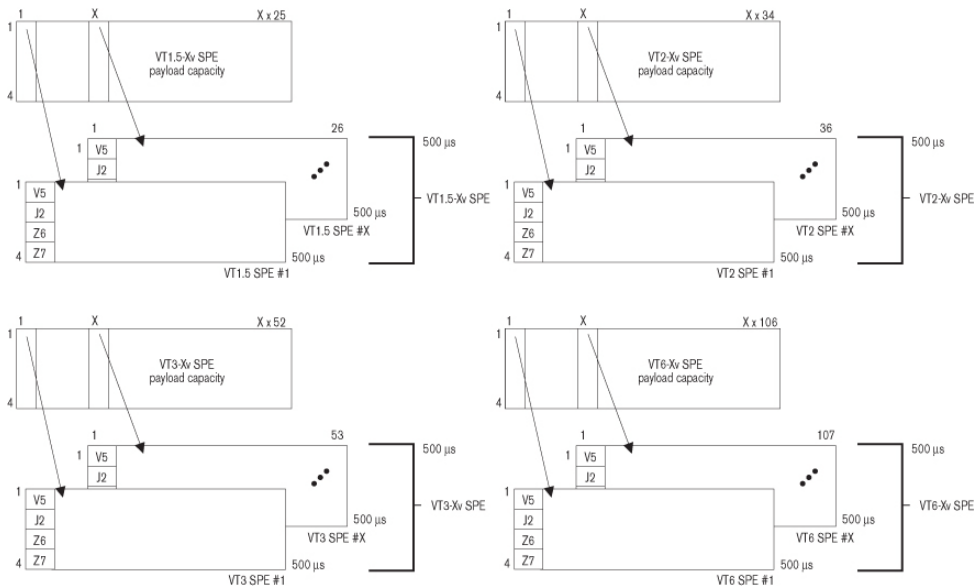

SONET VTn-Xv

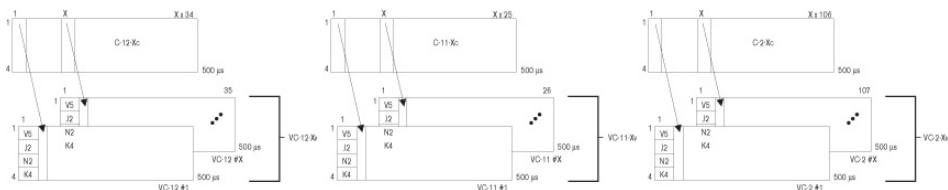

SDH VCn-Xv

To define its multiframe, LO VCAT uses a similar concept as that described above for HO VCAT groups. For the LO VCGs, low-order path overhead bytes Z7 (bit 2) [SONET] and K4 (bit 2) [SDH] are used to support the multiframe structure and specify the MFI and SQ values.

► LO VCAT Multiframe and Sequence Indicator (SQ)

Bit 2 of Z7/K4 is used to convey LO VCAT information. It forms a serial string of 32 bits (over 32 four-frame multiframes), as defined in ANSI T1.105 [19] and ITU G.707 (see figure *LOP Z7/K4 Bit 2 Multiframe Structure* on page 667). This string is repeated every 16 ms (32 bits x 4 x 125 s/bit) or every 128 frames. This process is repeated until the frame count reaches 32. This means that the total number of frames for a full cycle is 128 frames x 32 = 4096 frames.

The following fields define the frame:

- Frame count is contained in Bits 1 to 5 of the 32-bit string.
- Sequence indicator is contained in Bits 6 to 11 of the 32-bit string.
- Remaining bits (12 to 32) are reserved for other applications. These bits must be set to 0 and must be ignored by the receiver when VCAT is activated without LCAS.

The entire cycle is provided by a frame count that is divided into 32 steps of 16 ms, yielding a total of 512 ms for the length of the multiframe.

The sequence indicator identifies the sequence or the order in which the individual VT_n or VC-_n of the VT_n-X_v or VC-_n-X_v is assembled to form the contiguous container VT_n-X_c or VC-_n-X_c, as displayed in figure *SONET VT_n-X_v* on page 665 and figure *SDH VC_n-X_v* on page 665, respectively. Each member of the VCG has a fixed unique sequence indicator in the range of 0 to (X-1). The sequence indicator for the first VT_n or VC-_n within the VCG is 0, while the second VT_n or VC-_n uses sequence indicator 1, and so on up to the last member (SQ = X-1).

In the event that the terminating equipment is unable to recover the frame or the sequence, or if there is too much differential delay, the system is equipped to generate alarms to the management system to highlight these conditions.



LOP Z7/K4 Bit 2 Multiframe Structure

VCAT Differential Delay

VCAT payload can be split and sent along different paths through the network. Therefore, it is entirely possible that these different paths will not cover the same distance and may contain a different number of network elements along their route. This would mean that members of the VCG do not reach the termination point (end PTE) at the same time. In order for the terminating equipment to reassemble the payload, it must be able to compensate for the difference in payload arrival times. This arrival time difference is known as the differential delay.

Differential delay is the relative arrival time measurement between the members of a VCG. This means that in a next-generation SONET/SDH network, buffering is required at the terminating end of a VCG connection in order to realign the data stream. For high-order VCAT paths, the differential delay is measured by examining the multiframe indicator (MFI) present in the path overhead of each VCG member. For low-order VCAT paths, the frame-count information is used to determine differential delay.

The VCAT standards define the maximum differential delay between members of a VCG to be 256 ms. However, given the amount of buffering required at the terminating points, it is often the case that next-generation SONET/SDH PTEs support less than this maximum, hence making VCAT testing an important consideration when verifying the performance of these network elements.

Glossary

Next-Gen - Virtual Concatenation (VCAT)

VCAT Summary

In short, virtual concatenation provides a means of creating “right-sized” SONET/SDH containers that better match the bandwidth requirements of data client signals such as Ethernet and Fibre Channel. In addition, the flexible nature of VCAT allows service providers to create these right-sized pipes from the unused bandwidth/timeslots present in their network.

All the intelligence needed to create and handle a virtual concatenation is located at the end points of the connections (i.e., at the PTEs). The receiving end-point PTE is responsible for reassembling the original byte stream. This allows SONET/SDH channels to be routed independently through the network without requiring any acknowledgement of the virtual concatenation. In this manner, virtually concatenated channels may be deployed on the existing SONET/SDH network with a simple end-point upgrade.

Next-Gen - Link-Capacity Adjustment Scheme (LCAS)

LCAS, as defined per ITU-T recommendation G.7042, is a complementary technology to virtual concatenation. LCAS allows for the dynamic changing of the size of a VCAT group. To do so, signaling messages are exchanged within the same SONET/SDH overhead bytes used for VCAT (H4 for HO VCAT and Z7/K4 for LO VCAT) between the source PTE to the end-point PTE in order to change the number of tributaries being used by a virtually concatenated group (VCG). For example, the number of tributaries can be increased or decreased in response to an identified change in service-bandwidth requirement, or in response to a fault condition of an existing VCG member.

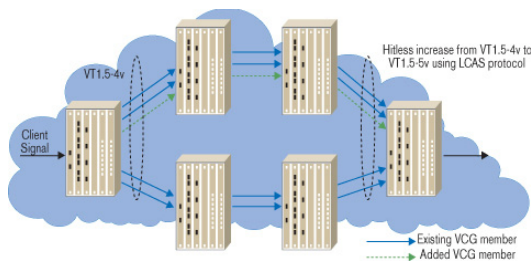

Increasing VCG Size Using LCAS

LCAS works by ensuring synchronization between the sender (PTE), referred to as the source node, and receiver (PTE), referred to as the sink node, during the increase/decrease of the size of a virtually concatenated circuit, in such a way that it doesn't interfere with the underlying client data service. Should failures occur on an individual member of a group, the size of the group can be reduced temporarily, instead of taking the entire group out of service (which would be the case if LCAS were not enabled – the entire VCG would be declared as “failed” in the event of a failure of one VCG members). With LCAS, once the defect is repaired, the group size can be restored to full bandwidth without affecting the underlying service.

Glossary

Next-Gen - Link-Capacity Adjustment Scheme (LCAS)

In addition to providing a resiliency mechanism for VCAT, LCAS gives service providers the flexibility to tailor service bandwidth as required. For example, if a certain customer requires additional bandwidth in the late evenings for file transfers (i.e., banking institutions), the service provider can provide a value-added service by provisioning increased bandwidth for a predefined period. Therefore, by dynamically altering the bandwidth of SONET/SDH transport pipes, LCAS allows network designers to adjust bandwidth based on quality of service (QoS) or other priority considerations.

As with VCAT, LCAS is only required at the terminating points of a circuit and the remainder of the network is oblivious to its presence. In order for LCAS to operate, two transmission paths in opposite directions must be established in order to terminate the protocol (see figure below).

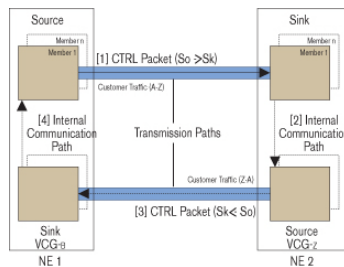

LCAS Protocol Transmission

Each of these transmission paths link the network elements (NE) located at each end of the circuit. In the LCAS protocol, one NE is designated as the Source and one is designated as the Sink. This defines an origination path. Another source/sink pair, in the opposite direction, must also be created to serve as a return path. Between two NEs, the LCAS information exchange always proceeds from the Source (So) to the Sink (Sk). The information is packaged in a control packet (CTRL) that contains data about the source members, as well as transferred information from the sink.

Figure *LCAS Protocol Transmission* on page 670 represents a NE1 source that sends a CTRL packet [1] to the NE2 sink. The NE2 sink receives the CTRL packet and processes it. In addition to the result of this processing, the detected status of its own members is shared with the NE2 source via an internal communication path [2]. At this point, using the return path, the NE2 source sends its own CTRL packet [3], which contains its own CTRL information as well as the NE2 sink information. The LCAS protocol loop is closed when the NE1 sink shares the information that is received from the NE2 sink to the NE1 source via the internal communication path [4]. This information transfer is also done in the same manner if the described scenario originates from the NE2 Source.

LCAS Control Packets

Below is the list of ITU-defined control packets for both directions of an LCAS signaling link.

ITU-Defined LCAS Control Packets

FIXED	Indicates that this end uses fixed bandwidth (non-LCAS mode).
ADD	Indicates that this member is about to be added to the group.
NORM	Indicates that there is no change; steady state.
IDLE	Indicates that this member is not part of the group or about to be removed.
EOS	Indicates the end of sequence; normal transmission.
DNU	Means do not use payload; indicates that the Sk side reported FAIL status.

Glossary

Next-Gen - Link-Capacity Adjustment Scheme (LCAS)

Sink to Source: Depicted as Message [3] in figure *LCAS Protocol Transmission* on page 670

MST	Information from Sk to So about the status of all members of the same VCG. It reports the member status from Sk to So with two states: OK or FAIL (1 status bit per member). OK = 0, FAIL = 1. Since each control packet contains only a limited number of bits for communicating the MST field, this information is spread across multiple control packets; i.e., an MST multiframe.
RS-Ack	When a renumbering of the sequence numbers of the members sending in CTRL field NORM, DNU, EOS, or when a change of the number of these members is detected at the Sk, a notification to the So per VCG has to be performed by toggling (i.e., change from 0 to 1 or from 1 to 0) the RS-Ack bit.

Common LCAS Messages for Path [1] and [3]

CRC-8	To simplify the variation of the changes in the virtual concatenation overhead, a CRC is used to protect each control packet. The CRC check is performed on every control packet after it has been received, and the content is rejected if the test fails. If the control packet passes the CRC test, then its content is used immediately.
-------	--

LCAS Example 1: Capacity Increase

The bandwidth of a VCG can be increased through the LCAS' ability to enable in-service addition of one or more members in a VCG. This bandwidth increase is typically controlled by the user via a network management system. The steps detailed in figure below are used to perform this bandwidth increase.

LCAS Bandwidth Increase, OC-12/STM-4 example

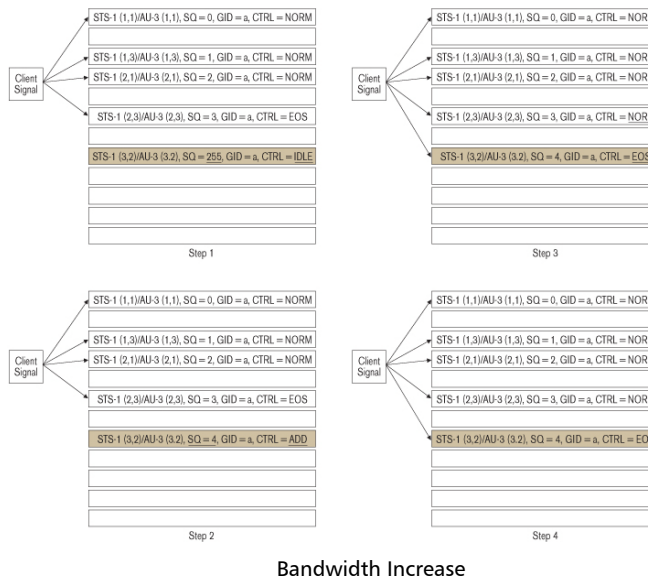

- **Step 0:** A member needs to be added to an existing VCG that is LCAS-enabled. In this example, the member to add is STS-1[3,2], or AU-3[3,2].

Glossary

Next-Gen - Link-Capacity Adjustment Scheme (LCAS)

- Step 1: The management system is used to configure the member at the source and sink NE.
 - The source automatically sets the SQ to 255, the highest possible number at the source and the sink NE. (based on VCAT standard)
 - The sink sets the MST to FAIL.
- Step 2: The management system configures LCAS state machine to ADD.
 - In the source, the SQ is automatically set to 4, the next highest SQ available, and the CTRL is set to ADD.
 - The source waits for the sink to send MST = OK for the member with SQ = 4. While waiting for this MST = OK message, the source will continue to send a CTRL = ADD for this member.
- Step 3: The source receives MST = OK for member SQ = 4.
 - The source sends EOS to the last member added, indicating to the sink that this is indeed the last member of the VCG, and sends NORM for the previously defined last member (of course, this is assuming that no fault occurs on this member during that time).
 - The new member begins to carry traffic in the first frame after the last byte in the frame transporting CTRL = NORM/EOS change.

Note: *If multiple members were added, all members would be set to NORM, except for the last one in the sequence, which would be set to EOS.*

- Step 4: The sink detects the transition from ADD to NORM/EOS for the new member
 - The sink sends RS-ACK to the source to acknowledge the new sequence.
 - The sink sets the MST to be consistent with the new sequence.
 - Following the proper delay compensation, the source is allowed to evaluate the new member status when it receives the RS-Ack.

LCAS Example 2: Capacity Reduction

There are two methods for LCAS to support the capacity reduction of a VCG: automatic temporary removal of one or more member(s) due to a network fault, or manual deprovisioning of one or more member(s) to permanently reduce the bandwidth supported by the VCG.

► Automatic Temporary Removal

The temporary removal of a member is automatically handled by the LCAS protocol, as presented in figure below and associated steps. This capability provides VCAT with its resiliency mechanism as the size of the group can be reduced temporarily, instead of taking the entire group out of service (which would be the case for VCGs without LCAS enabled). Once the defect is repaired, the group size can be restored to full bandwidth without affecting the underlying service.

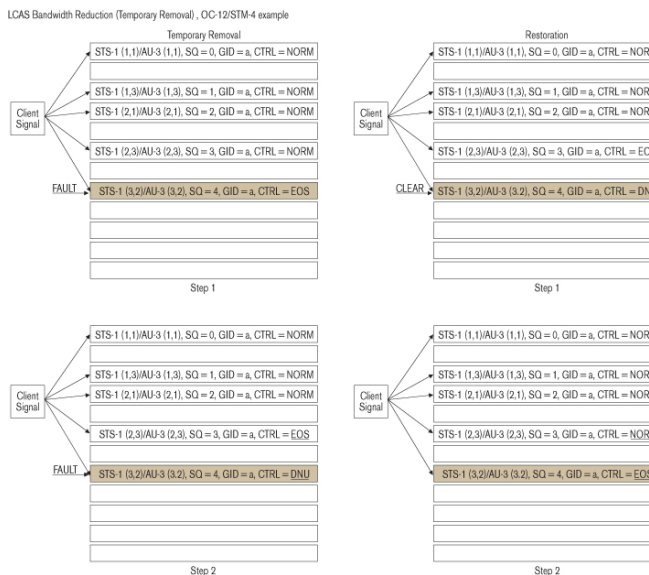

Bandwidth Reduction (Temporary Removal)

Glossary

Next-Gen - Link-Capacity Adjustment Scheme (LCAS)

► **Temporary Removal**

- **Step 1:** A fault is detected at the sink for a member (i.e., STS-1 [3,2], AU-3 [3,2]).

At the sink, the fault can take the form of a member status unavailable (MSU) or transport signal degraded (TSD). An MSU would be generated by an AIS or LOP for example. The TSD would be errors detected on the path crossing a certain threshold.

If the source of these members was sending a NORM or EOS in this condition, the sink would start sending a MST = FAIL for the specific SQ.

Typically, a hold-off timer can be configured to delay the reporting of MST = FAIL to avoid transient error occurrences.

- **Step 2:** Member removal

At the sink NE and upon the detection of the MSU, the member would be removed immediately. However, if the failure is related to a TSD, the member would be removed only when the sink NE receives the DNU from the source NE.

At the originating source NE a detection of the MST = FAIL will trigger the replacement of the NORM/EOS by a DNU condition. Within the remaining active member, the member with the highest SQ will send EOS in the CTRL field.

➤ **Restoration**

➤ Step 1: Fault clears

When the defect that caused the temporary removal is terminated and is detected at the sink, the sink will start sending a MST = OK for that member.

Upon detection of the MST = OK, the source will either replace the DNU condition by an NORM condition, or replace the DNU condition with an EOS condition, and the preceding member, which was sending CTRL code EOS, will send NORM in the CTRL field.

➤ Step 2: Payload activation

The final step after recovering from a temporary removal is to start using the payload area of that member again. The first container frame to contain payload data for the member is the container frame immediately following the container frame that contained the last bit(s) of the control packet containing the first CTRL code (NORM or EOS) in the CTRL field for that member.

Glossary

Next-Gen - Link-Capacity Adjustment Scheme (LCAS)

➤ Member Permanent Removal

The bandwidth of a VCG can be permanently reduced using the LCAS' ability to enable in-service removal of one or more member(s) from the VCG. This bandwidth reduction is controlled by the user via a network management system. The steps detailed in figure below are used to perform this reduction of bandwidth.

LCAS Bandwidth Reduction (Permanent Removal) , OC-12/STM-4 example

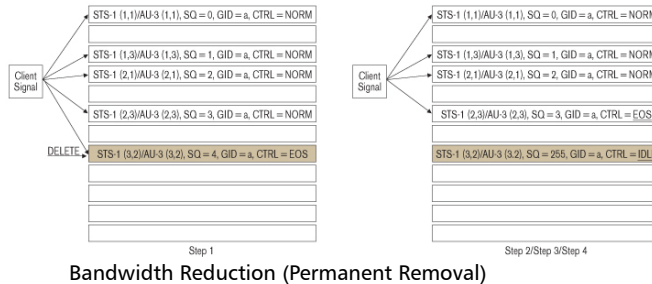

Note: The removal of a member must be done at the source in order for the operation to be hitless. If it is done at the sink first, the traffic will be corrupted from the time the member is removed (sink generates MST = FAIL) and the sink receives a DNU generated from the source.

- Step 1: One or more member(s) need to be removed from an existing VCG. In this example, again we are using STS-1 [3,2], AU-3 [3,2].

This operation must be initiated from a management system.

- **Step 2:** At the source, the management system deletes the member from the VCG.

The CTRL field is set to IDLE, while the SQ is automatically set to 255.

Depending on which member is deleted in the VCG, the SQ for the remaining members may be renumbered. For example, if the member that is removed is the highest number in the VCG, the members' SQs will not be renumbered. However, if a member other than the last is removed, then SQ renumbering will occur in line with the new order.

The source will send a new CTRL word (changed from NORM to EOS) for the last member of the VCG.

- **Step 3:** At the sink, the CTRL word and SQ are received.

When the CTRL = IDLE signal is detected, the MST for the member is set to FAIL and the RS-Ack is toggled.

- **Step 4:** At the sink, the management system deletes the member from the VCG.

Index

- 10B_ERR..... 438, 453
 56K..... 270, 273, 370
 64K..... 270, 273, 370
- A**
- A1 222, 314, 618, 630
 A2 222, 314, 618, 630
 absolute 529
 AC power 39
 acronym 577
 active member 470, 483
 actual frequency (bps)..... 141
 add all 469, 482
 add member(s) at start..... 105, 106
 advanced tabs 411
 after-sales service 560
 AIS.... 275, 279, 293, 296, 375, 379, 381, 384,
 385, 388, 389, 392, 524
 AIS-L..... 117, 226, 233
 AIS-P 248, 252
 AIS-V 260, 263
 alarm analysis..... 118, 120
 alarm measurement 47
 alarm monitoring 115
 alarm scan 114
 alarm scan in-progress 113
 alphanumeric values..... 47
 AMI 138, 144
 Amount.... 214, 224, 246, 258, 306, 316, 336,
 348, 359
 Amplitude 145
 ANSI TI-403 288
 Application Preferences 528
 apply 469, 482
 Apply ExSQ..... 463
 apply overwrite value(s) 476, 478, 488
 apply to bottom page 51
 apply to top page..... 51
 APS 236, 328, 621
 APS channel..... 633
 APS signaling..... 636
 APS/Advanced Line OH TX/RX (SONET) 236
 APS/PCC..... 185
 architecture 240, 329
 architecture/bridge request 240
 arrow
 down 47
 end 47
 left 48
 page down..... 47
 page up 47
 right..... 48
 top 47
 up 47
 arrow buttons
 description 47
 assembly hardware revision..... 545
 AU-AIS 338, 342
 AU-LOP 338, 342
 auto..... 467
 auto add at startup 106, 479
 automatic protection switching..... 621, 633
 AUX 23, 559
 available options 547
 average..... 428
- B**
- B1117, 213, 219, 222, 305, 311, 314, 619, 631
 B2117, 223, 228, 235, 315, 321, 327, 620, 632
 B3245, 251, 255, 335, 341, 345, 358, 364, 368,
 623, 634
 B3ZS 138
 B8ZS 138, 144
 background traffic..... 531
 Backplane 129, 521

Index

backplane..... 526
backward..... 187, 196
bandwidth..... 403
bandwidth usage (%)..... 431, 448
bantam..... 67, 71
BBE..... 508, 511
BBER..... 508, 512
Bell..... 271
BERT tabs..... 405
Binary..... 160, 166, 182, 200, 406
binary 187, 196, 199, 204, 266, 272, 356, 395
BIP-2..... 257, 263, 347, 353
BIP-8..... 619, 620, 623, 631, 634
BIP-N*24..... 632
BIT..... 156
Bit Error..... 408
bit error..... 410
Bit-Oriented Messages..... 286
bit-oriented messages..... 281
Bits 1-4..... 244, 334
Bits 5-8 (Sync. Status Message)..... 244, 334
block..... 400
BNC..... xi, 67, 71
bottom page..... 50
BPV..... 140, 144
bridge..... 142, 522, 523
bridge request..... 329
Broadcast..... 401, 402
Burst 215, 217, 225, 227, 247, 249, 259, 261,
307, 309, 317, 319, 337, 339, 349,
351, 360, 362
button
 Apply..... 547
 Apply ExSQ..... 463
 Apply SQ..... 459
 Back..... 63
 Cancel..... 52
 Copy SQ to ExSQ..... 463
 Default..... 52
 Delete..... 63
 Finish63, 70, 74, 78, 82, 86, 90, 91, 96, 102,
 107, 110

Generate..... 44
help..... 52
Next..... 63
OK..... 52
Resequence ExSQ..... 463
Resequence SQ..... 459
Send ... 155, 158, 172, 180, 214, 224, 246,
258, 306, 316, 336, 348, 359
 send..... 276, 299, 300
 Setup..... 63
 Toggle RS-Ack..... 478, 488
B-VID..... 642
B-VLAN Priority..... 642

C

C..... 46, 414
C2..... 255, 256, 345, 346, 367, 368, 624, 635
calibration date..... 545
calibration failed..... 427
Cancel..... 52
cancelled..... 427
caution
 of personal hazard..... 5
 of product hazard..... 5
C-bit..... 294, 295
CE..... x, xii
channel..... 238, 448
Channel Codeword..... 300
channel ID..... 329
channel identifier..... 653
channel/destination node id..... 238
cHEC..... 455
cHEC correctable..... 434, 450
cHEC uncorrectable..... 434, 450
CID..... 86, 107, 435, 443, 451, 456
circuit..... 288, 290
class 1..... xi
class 1M..... xi
cleaning
 front panel..... 555
client..... 448

- client data frames 447, 454
 client data frames FCS 435, 451
 client management frames 447, 454
 client management frames FCS 435, 451
 Client Offset RX 515
 Client Offset TX 513
 Clock Configuration 129
 Clock Mode 129, 526
 External 526
 Internal 526
 Recovered 526
 clock mode 521
 internal 521
 recovered 521
 Clock Synchronization 520
 CMF 436, 452
 CMI 138
 code 199, 204
 Codeword 298
 Command 286, 287
 command 277, 469, 482
 common problems 559
 common tabs 491
 computation method 542
 Configuration 393
 configuration 546
 configuration section 62
 connection
 clock signal 23
 DCC/GCC/UC 26
 Electrical SONET/DSn/SDH/PDH 22
 Ethernet 10/100/1000Base-T 24
 Gig-E 25
 OTN/OC-N/STM-N 20
 connection 1000Base-X 25
 connector 64
 Continuous 216, 226, 248, 261, 308, 318, 339,
 351, 362, 408
 continuous 140, 155, 158, 172, 180, 214, 224,
 246, 258, 276, 288, 294, 306, 316,
 336, 348, 359, 376, 382, 386, 390,
 396, 398, 426, 434, 438, 474, 498
 Control Codeword 299
 conventions, safety 5
 Copy SQ to ExSQ 463
 core header 455, 649
 Count 47
 count 136, 289, 428
 Coupled 127
 CRC LOMF 375, 379
 CRC-3 486
 CRC-4 376, 378
 CRC-6 276, 278
 CRC-8 486
 CSF-Loss of client signal 436, 452
 CTRL 469, 476, 482
 cumulative offset 495
 Current 286
 current 286
 current performance report message 291
 current value 492, 495
 customer service 563
 CV 140, 144
 CW 156
- ## D
- D1 222, 314, 619, 631
 D2 222, 314, 619, 631
 D3 222, 314, 619, 631
 D4 through D12 235, 327, 621, 633
 DAPI . 162, 168, 169, 174, 178, 179, 186, 194,
 195
 data communication channel 619
 data communications channel... 621, 631, 633
 data path 136
 data path selector 62
 date 39, 136
 DCC 619, 621, 631, 633
 DCI 436, 452
 decoupled 67, 80, 84, 88, 93, 98
 decrement 493
 Default 52, 161, 185, 202
 default 443

Index

Default Test Preferences 530
defect selection 412, 418
defined tab 51
delay 428
delay control 462
delta 449
description 545
Destination MAC Address 395
destination node ID 329
differential delay 461, 466, 467
disable all 462
disable all overwrite(s) 470, 483
discarded frames 446, 448, 458
disruption count 413
Divider Ratio 527
DM 509
DS0 mode 270, 273
DS0/64K 269
DS0/64K RX 273
DS0/64K TX 270
DS1 68
DS1 RX 278
DS1 TX 275
DS1/1.5M 269
DS3 68
DS3 FEAC RX 301
DS3 FEAC TX 297
DS3 RX 295
DS3 TX 293
DS3/45M 269
DSn tabs 269
DSn/PDH 133, 542
Dual RX 126
Duration... 130, 136, 215, 217, 225, 227, 247,
249, 259, 261, 307, 309, 317, 319,
337, 339, 349, 351, 360, 362
duration (s) 480, 490

E

E0 mode 370
E0/64 RX 373

E0/64K 369
E0/64K TX 370
E1 68, 222, 314, 619, 631
E1 TX 375
E1/2M 369
E1/2M RX 378
E2 68, 235, 327, 622, 633
E2/8M 369
E2/8M RX 383
E2/8M TX 381
E3 68
E3/34M 369
E3/34M TX 385, 387
E4 68
E4 TX 389
E4/140M 369
E4/140M RX 391
EB 506, 510
E-bit 376, 378
EC 506, 510
edit 552
EFS 506, 510
eHEC 456
eHEC correctable 437, 453
eHEC uncorrectable 437, 453
enable 273
enable all 462, 475, 476, 478, 488
enable auto-negotiation 446, 457
enable bulk filled override 530
enable delay 461
Enable DS0 68, 69, 72, 73, 81, 85, 270
Enable E0 68, 69, 72, 73, 81, 85
enable E0 370
enable FDL 280
enable FEC 94, 98, 109, 154
enable HP-PLM 346
enable HP-TIM 343
enable HP-UNEQ 346
enable LCAS 105
enable LP-PLM 357, 367
enable LP-TIM 355, 366
enable LP-UNEQ 357, 367

- enable OPU-MSIM 203
 enable OPU-PLM 204
 enable PLM-P 256
 enable PLM-V 267
 enable RS-TIM 312
 enable scrambler 94, 98, 109, 157
 Enable stream 394
 enable TCM 497, 500
 enable TC-TIM 503
 enable TIM 169, 179, 195
 enable TIM-P 253
 enable TIM-S 220
 enable TIM-V 265
 enable trace218, 250, 262, 310, 340, 352, 363
 enable UNEQ-P 256
 Enable UNEQ-V 267
 enabled 480, 490
 equipment returns 563
 ERDI-CD 338, 343, 350, 361, 366
 ERDI-PCD 248, 253
 ERDI-PD 338, 343, 350, 355, 361, 366
 ERDI-PPD 248, 253
 ERDI-PSD 248, 253
 ERDI-SD 338, 342, 350, 354, 355, 361, 365
 ERDI-VCD 260, 264
 ERDI-VPD 260, 264
 ERDI-VSD 260, 264
 error analysis 118, 120
 error measurement 47
 error monitoring 115
 Error/Alarm RX 399
 Error/Alarm TX 396
 ES 506, 510
 ESD 9
 ESR 508, 512
 Ethernet 134
 event 136
 EXI. 86, 95, 101, 107, 433, 441, 449, 450, 456
 exit 28, 34
 EXP 184
 expected format220, 253, 265, 312, 343, 355,
 366
 expected message 220, 253, 265, 312, 343,
 355, 366, 503
 expected path signal label 256, 267, 346, 357,
 367
 expected payload type..... 204
 ExSQ 106, 464
 extended signal label..... 121, 638
 extension header 443, 456
 extension header identifier 650
 extension HEC..... 653
 External 129, 526
 external configuration 446, 457
 EXZ 140, 144
- ## F
- F1 222, 314, 619, 631
 F2 255, 345, 368, 625, 636
 F3 345, 368, 636
 FAIL 423
 failed 428
 False Carrier 400
 far-end 510
 far-end block error 622
 FAS ... 160, 165, 166, 213, 219, 305, 311, 376,
 378, 382, 383, 386, 387, 390, 391
 fastest member 467
 fault indication 187, 196
 fault indication code..... 187, 196
 Favorites 40, 59
 F-bit 294, 295
 FCC x
 FCS 400, 451
 FDI 436, 452
 FDL PRM Current RX 291
 FDL PRM RX 290
 FDL PRM TX 288
 FDL RX 285
 FDL TX 280
 FEAC 297
 FEBE 294, 295, 622
 FEC RX 156

Index

FEC TX	154
FEC-CORR	156
FEC-CORR-BIT	155
FEC-CORR-CW	155
FEC-CORR-SYMB	155
FEC-STRESS-CW	155
FEC-UNCORR	156
FEC-UNCORR-CW	155
file	552
Finish 70, 74, 78, 82, 86, 90, 91, 96, 102, 107, 110	
FOPR	485
FOPT	472
format..... 218, 250, 262, 310, 340, 352, 363	
forward	187, 196
frame	448
Frame Configuration	394
frame rate	403
Frame Size	394
frame size	403
Frame Size Count	403
frame type.....	440
frame-mapped GFP	645
framing .. 68, 69, 72, 73, 76, 81, 85, 275, 293, 375, 381, 385, 389, 521, 523, 618, 630	
framing bit.....	276, 278
Frequency	516
frequency . 115, 116, 143, 146, 151, 152, 516, 525	
frequency (bps)	149, 513
Frequency (MHz)	527
Frequency Offset	517
frequency offset	146, 152, 525
frequency offset (ppm).....	141, 149, 513
front panel, cleaning	555
FTFL.....	183, 187, 196

G

G1	255, 345, 368, 625, 636
GCC0	161, 167

GCC1	185
GCC2	185
Generate.....	44
generated	475, 476
generated count.....	488
generic framing procedure	643
GFP	429, 643
GFP Channel RX	451
GFP Channel Stats RX	454
GFP Channel Stats TX	439
GFP Channel TX	435
GFP Client RX	457
GFP Client TX	444
GFP frame structure.....	647
GFP Frames RX.....	449
GFP Frames Stats RX	447
GFP Frames TX	432
GFP mapping	645
GFP OH RX	455
GFP OH TX	440
GFP Overview TX	431
GID mismatch	471, 484
Global.....	133
global configuration.....	530
glossary	573
GMP RX	209
GMP TX	208
GMT	528
grid view	62
group member	461, 466
group members	460, 464
group size	459, 463
GTE.....	271

H

H	36, 46, 414
H1	235, 243, 327, 333, 620, 632
H2	235, 327, 620, 632
H3	235, 327, 620, 632
H4	255, 345, 368, 625, 636
H4-LOM	338, 342

Hardware Options 545
HDB3 138
help 33, 52, 554
hide keyboard 554
higher-order path overhead 634
higher-order VC-N path trace 634
HO VCAT 660
hold-off timer 490
HOP 211, 303
HOP OH TX/RX (SDH) 344
HOP OH TX/RX (SONET) 254
HOP pointer adjust RX (SONET/SDH) 495
HOP pointer adjust TX (SONET/SDH) 492
HOP RX (SDH) 341
HOP RX (SONET) 251
HOP TX (SDH) 335
HOP TX (SONET) 245
HP-PLM 342
HP-POH 634
HP-RDI 338, 342
HP-REI 335, 341
HP-TIM 342
HP-UNEQ 338, 342

I

IC x
ID 395
id 136
identification label 560
Idle 287, 293, 296, 400
idle 272, 372
idle frames 447
inactive 113
increment 493
information 42
injected payload type 197
input presence 145
insert 554
inserting a module 11
installed software packages 544
interface 113, 446, 457, 554

interface type 520, 522
Internal 129, 526
internal 521
Invalid 448
invalid frames 447
Invert 406
invert 531
Invert Polarity 148
ISO 528

J

J0 222, 314
J0 Trace 117
J0 trace 218, 220, 310, 312, 618, 630
J1 255, 345, 368
J1 Trace 119
J1 trace 250, 253, 340, 343, 363, 366, 623, 634
J2 266, 356
J2 Trace 121
J2 trace 262, 265, 352, 355, 626, 637
Jabber/Giant 400
jammed bit 8 271, 371
JC 201
JC1 to JC3 201, 206
JC1 to JC6 201, 206
job information 42

K

K1 235, 237, 327, 329, 621, 633
K2 235, 239, 327, 329, 621, 633
K3 345, 368, 636
K4 356, 638
K4 structure 637
keyboard 53

L

label, identification 560
laser xi
laser on 530, 559
laser, safety 7

Index

- last 428
- last alarm scan date 119, 120
- last trib scan 121
- launch test 114
- layer 412, 418
- LBO 68, 72, 76, 139, 521
- LCAS 470, 483, 669
- LCAS configuration 459, 463
- LCAS control packets 671
- LCAS Sink 481
- LCAS Sink Alarm 484
- LCAS Sink Configuration 489
- LCAS Sink MST/RS-Ack Control 487
- LCAS Sink Overview 482
- LCAS Source 468
- LCAS Source Alarm 471
- LCAS Source Configuration 479
- LCAS Source Error 473
- LCAS Source MST/RS-Ack Control 477
- LCAS Source Overview 469
- LCAS Source SQ/CTRL Control 475
- LED
 - C 46
 - Ethernet 134
 - Global 133
 - H 46, 414
 - LASER 21
 - Log Full 133
 - Other 134
 - Pattern 134
 - Port 133
 - RX 21
 - Status 46
 - status 26
- Level (Vref = 1.21 Vpp) 145
- Level (Vref = 6.00 Vpp) 145
- LFD 434, 450
- line 116, 211
- line coding 68, 72, 76, 138, 521, 523
- Line OH TX/RX (SONET) 234
- line overhead 234, 620
- Line TX (SONET) 223
- linear 433, 449
- Link Activity 287
- Link Down 399
- link down 397
- link loss 458
- link status 458
- live traffic 409
- LO VCAT 664
- LOA 467
- LOA threshold 467
- load 41, 552
- Load Configuration 59
- load key 546
- LOC 129, 522, 526
- local 528
- Local Fault 397
- local fault 399
- location 544
- LOCS 436, 452
- LOF ... 117, 159, 163, 216, 219, 308, 311, 375, 379, 381, 384, 385, 388, 389, 392, 524
- Log Full 133
- LOH 620
- LOM 159, 163, 248, 252, 460, 464, 465
- LOMF 375, 379
- loopback 277
- LOP OH TX/RX (SDH, TU-3 path) 367
- LOP OH TX/RX (SDH) 356
- LOP OH TX/RX (SONET) 266
- LOP pointer adjust RX (SONET/SDH) 495
- LOP pointer adjust TX (SONET/SDH) 492
- LOP RX (SDH, TU-3 path) 364
- LOP RX (SDH) 353
- LOP RX (SONET) 263
- LOP TX (SDH, TU-3 path) 358
- LOP TX (SDH) 347
- LOP TX (SONET) 257
- LOP-P 248, 252
- LOP-V 260, 263
- LOS 115, 139, 143, 148, 151, 524
- lower-order path overhead 637

LP_TIM 365
 LP-PLM 354, 365
 LP-RDI..... 350, 354, 361, 365
 LP-REI 347, 353, 358, 364
 LP-RFI 350, 354
 LP-TIM 354
 LP-UNEQ..... 350, 354, 361, 365

M

M0 235, 327, 621
 M1 235, 327, 621, 633
 main window 29
 maintenance 555
 front panel..... 555
 general information..... 555
 Manual214, 224, 246, 258, 306, 316, 336, 348,
 359
 manual..... 288
 manual control..... 478, 488
 manual toggle count..... 478, 488
 mapping..... 69, 73, 81, 85, 89, 94, 99, 104
 SDH 61
 SONET..... 60
 mapping efficiency (%)..... 431, 448
 Max. Negative Offset..... 517
 max. negative offset..... 146, 152
 Max. Positive Offset..... 517
 max. positive offset..... 146, 152
 maximum 428
 measurement unit..... 462, 467
 member.... 460, 461, 464, 466, 469, 471, 473,
 475, 477, 479, 482, 484, 486, 487,
 489, 554
 member description 554
 message218, 250, 262, 310, 340, 352, 363, 499
 MFAS..... 160, 165, 166
 minimize 32
 minimum..... 428
 mismatch 450, 451
 mismatch '0' 410
 mismatch '1' 410

Mode 215, 217, 225, 227, 247, 249, 259, 261,
 307, 309, 317, 319, 337, 339, 349,
 351, 360, 362
 mode..... 426
 module
 insertion..... 11
 removal..... 11
 module description..... 544
 Module Information 544
 Mon..... 522
 mon..... 142
 Monitor 415
 monitor 523
 MS..... 116, 303
 MS BIP-N*24..... 632
 MS DCC 633
 MS orderwire..... 633
 MS-AIS..... 318, 320
 MSOH 632
 MS-RDI 318, 320
 MS-REI 315, 321, 633
 MST 469, 478, 482, 488
 Multicast 401, 402
 Multi-Channel SDT..... 127
 multiframe indicator..... 625
 Multiplex Section APS/Adv OH TX/RX (SDH)328
 Multiplex Section OH TX/RX (SDH) 326
 multiplex section overhead..... 632
 Multiplex Section RX (SDH)..... 320
 Multiplex Section TX (SDH) 315

N

N1 255, 345, 368, 625, 636
 N2 356, 637
 NDF 494, 496
 near-end 506
 network operator 636
 network operator byte 637
 new 552
 New Data Flab (NDF) 494
 New Data Flag 496

Index

new data flag.....	628, 639
new pointer value	494
next generation.....	133
next-generation tabs.....	429
NI/CSU Emulation.....	127
NJO	201
no defect time.....	412, 419
No NDF.....	496
No New Data Flag	496
nominal frequency (bps)	141, 149, 514
none.....	271, 274, 371, 374
Non-LCAS	479, 489
Normal	126
null.....	433, 449
N-Unicast	401, 402

O

OC-12.....	84, 91, 104
OC-192.....	84, 91, 104
OC-3.....	84, 91, 104
OC-48.....	84, 91, 104
OC-768.....	88, 91
ODI.....	499, 502
ODU multiplexing.....	548
ODU OH RX	191
ODU OH TX	182
ODU RX	189
ODU TCM RX	175
ODU TCM TTI RX	178
ODU TCM TTI TX.....	173
ODU TCM TX	170
ODU TTI/FTFL RX.....	194
ODU TTI/FTFL TX	186
ODU TX	180
ODU-AIS.....	181, 190
ODU-BDI.....	181, 190
ODU-BEI	189
ODU-BIP-8	189
ODU-BSD	181, 190
ODU-BSF.....	181, 190
ODU-FSD	181, 190
ODU-FSF	181, 190
ODU-LCK	181, 190
ODU-LOFLOM	181, 190
ODU-OCI.....	181, 190
ODU-TIM	190
OEI	498, 501
offset unit.....	146, 152
OK	52
OOF ...	159, 163, 275, 279, 293, 296, 308, 311
OOM.....	159, 163
OOM1.....	460, 464, 465
OOM2.....	460, 464, 465
operation mode.....	240, 330
operator identifier	188, 196
operator specific	162, 168, 178, 186, 188, 194, 196
OPU OH RX.....	205
OPU OH TX	200
OPU RX.....	203
OPU TX	197
OPU-AIS	199, 204
OPU-CSF	199, 204
OPU-MSIM.....	199, 203
OPU-PLM	203
orderwire.....	619, 622, 631, 633
Other	134
Other CMF.....	452
OTN	133
OTN Intrusive.....	66, 92, 97, 108, 128
OTN tabs	153
OTU OH RX.....	166
OTU OH TX	160
OTU RX.....	163
OTU TTI RX	168
OTU TTI TX.....	162
OTU TX	157
OTU_IAE	159, 164
OTU1	91, 94, 104, 153
OTU1e (11.049G).....	109
OTU1f (11.27G)	109
OTU2	91, 94, 104
OTU2e (11.096G).....	109

OTU2f (11.317G).....	109
OTU-3.....	98
OTU3.....	91
OTU-AIS.....	159, 163
OTU-BDI.....	159, 164
OTU-BEI.....	165
OTU-BIAE.....	159, 164
OTU-BIP-8.....	165
OTU-TIM.....	164
output.....	552
Output Presence.....	527
output presence.....	139, 147, 522
oversize.....	400
Overwrite . 162, 186, 188, 199, 218, 244, 250, 310, 334, 340, 405	
overwrite.....	440
overwrite control.....	470, 483
overwrite enable.....	475, 476, 478, 488
overwrite selected favorite content.....	41
P	
page selection.....	51
page up.....	47
PASS.....	423
path .. 51, 69, 73, 81, 85, 89, 94, 99, 104, 465	
path overhead.....	254, 266, 623
path signal label.....	267, 357, 635
path signal label (C2).....	119, 256, 346, 367
path signal label (V5).....	120
path status.....	636
path trace.....	637
path user channel.....	636
Pattern.....	134
pattern . 69, 73, 82, 86, 90, 96, 102, 107, 110, 272, 274, 372, 374	
Pattern #.....	406
pattern configuration.....	445
Pattern Loss.....	409
Pattern RX.....	409
pattern tabs.....	393
Pattern TX.....	405
payload.....	64
payload content.....	272, 274, 372, 374
payload FCS.....	654
payload FCS indicator.....	650
payload header.....	649
payload information field.....	654
payload type.....	197, 204
payload type identifier.....	649
P-bit.....	294, 295
PDH tabs.....	369
PDI-P.....	248, 252
Performance Monitoring (PM).....	504
performance report message.....	290
performance report messages.....	288
Period215, 217, 225, 227, 247, 249, 259, 261, 307, 309, 317, 319, 337, 339, 349, 351, 360, 362	
period.....	436
persistent CRC.....	484
pFCS.....	437, 453
PFI.....	441, 456
PFI mismatch.....	451
PHY alarm generation.....	397
PHY error injection.....	396
play.....	554
PLCR.....	485
PLCR threshold.....	489
PLCT.....	472
PLCT threshold.....	479
PLI.....	455
PLM-P.....	252
PLM-V.....	264
PM.....	504
PM TTI trace.....	186, 194
PM&TCM.....	183, 192
POH.....	623
pointer.....	492, 495, 620, 632
pointer action.....	620, 632
pointer decrement.....	496
pointer increment.....	496
pointer jump.....	494
pointer step.....	493

Index

pointer value	629, 639	ready	427
Port	133	received	478
Port RX (Electrical Interfaces).....	142	received count	478
Port RX (Optical Interfaces)	150	received message.....	220, 253, 265, 312, 343, 355, 366, 503
Port TX (Electrical Interfaces).....	138	received payload type.....	204
Port TX (Optical Interfaces).....	147	received value	478
Port TX (optical interfaces).....	147	record	553
position and sequence indicator	636	Recovered	129, 526
Power	116	recovered.....	521
Power (dBm)	150	REF OUT.....	23, 527
Power Level	145	reference member	462, 467
pre-defined selection.....	44	Regenerator Section OH TX/RX (SDH)	313
Previous.....	286	regenerator section overhead	630
Priority	286, 287	Regenerator Section RX (SDH)	311
PRM.....	287	Regenerator Section TX (SDH)	305
PRM bit event counts	290	REI-L	117, 223, 229
PRM bit events	289	REI-P	245, 251
problems.....	559	REI-V.....	257, 263
product		relative	529
identification label.....	560	relative delay	467
protected channel	239, 329	Remote Control	549
provisioned member	470, 483	remote DUT	105, 479, 489
PSI	201, 202	remote error indicator	633
PTI.....	441, 454, 456	Remote Fault	399
		remote status	39
		remove all.....	469, 482
		removing a module	11
		Report Format	43
		Report Header	43
		report settings	43
		Report Title.....	43
		request	237, 329
		RES	161, 167, 183, 185, 201, 206
		Resequencing ExSQ.....	463
		Reserved PLI Frames.....	447
		Reserved PTI Frames	447, 454
		reset	428
		reset all.....	462
		reset to display default pages layout	529
		Response	286, 287

R

RAI ...	275, 279, 375, 379, 381, 384, 385, 388, 389, 392
RAI MF	375, 379
Range.....	116, 150
Rate....	47, 214, 224, 246, 258, 306, 316, 336, 348, 359, 408
rate ..	136, 140, 155, 158, 172, 180, 214, 224, 246, 258, 276, 294, 306, 316, 336, 348, 359, 376, 382, 386, 390, 396, 397, 434, 438, 446, 457, 474, 498
rates	573
RDI	293, 296, 436, 452
RDI-L	117, 226, 233
RDI-P	248, 252
RDI-V.....	260, 263

Results	
SDT	421
return merchandise authorization (RMA) ..	563
RFI-V.....	260, 264
RJ-48c.....	67, 71
Round Trip Delay.....	426
round trip delay	425
Round Trip Delay (RTD)	425
RS.....	116, 303
RS BIP-8.....	631
RS DCC	631
RS orderwire.....	631
RS trace message	630
RS user channel.....	631
RS-Ack.....	470, 478, 483, 488
RSOH	630
RS-TIM.....	311
RTD	425
running	427
runt.....	400
RX	522
RX Live Traffic.....	531
RX Tuning.....	151
S	
S1.....	235, 244, 327, 334, 621, 633
safety	
caution	5
conventions	5
laser.....	7
warning	5
SAPI..	162, 168, 169, 174, 178, 179, 186, 194, 195
save.....	552
SB Correctable.....	453
SB Correctable (Post).....	438
SB Correctable (Pre).....	438
SB Uncorrectable.....	438, 453
Script.....	59
script line editing	554
script tools	553
SDH tabs.....	303
SDT	411
SDT - Monitor	415
SDT - Results.....	421
Seconds.....	47
section.....	116, 211
Section OH TX/RX (SONET).....	221
section overhead (SONET).....	618
Section RX (SONET)	219
Section TX (SONET).....	213
sections	44
SEF.....	117, 216, 219
selected logo	43
SEP	509
SEPI	509
serial number	545
service and repairs.....	563
service centers	564
Service Disruption.....	414
Service Disruption Time (SDT).....	411
Service Disruption Time (SDT) - Monitor	415
Service Disruption Time (SDT) - Results.....	421
SES	506, 510
SESR	508, 512
set all.....	272, 274, 372, 374
SFP.....	25, 545
shipping to EXFO.....	563
show keyboard	554
signal.....	64
signal label	624
signal rates	573
single.....	426
slot ID.....	544
slowest member	467
SM.....	161, 167
SM TTI trace.....	162, 168
Smart Mode	111
smart scan	112, 113
smart scan in-progress	113
SmartMode	59, 113, 115
legend.....	123
SmartMode Report	45

Index

software option key	546
SONET tabs	211
SONET/SDH.....	133
SONET/SDH HOP.....	539
SONET/SDH Intrusive	66, 83, 87, 103, 128
SONET/SDH LOP.....	541
sort.....	48
Source MAC Address	395
source node ID	329
source node id	239
spare	443, 456, 653
spare bit.....	384
spare bits ..	377, 380, 382, 386, 388, 390, 392
special VID values.....	642
specification	
electrical interfaces	565
Ethernet Add/Drop Interfaces	569
Ethernet interfaces	570
optical interfaces	566
synchronization interfaces	568
specifications	565
SQ106, 460, 461, 464, 466, 469, 471, 473, 475, 477, 482, 484, 485, 486, 487	
SQ controls.....	459
SQ in UMST.....	472
SQM	465
SQNC.....	485
SS Bits	243
SSMB.....	633
standard.....	505
Start application.....	27
Start Time.....	126, 130
state.....	469, 482
Statistics RX.....	402
Statistics TX.....	401
Status	46
status	113, 427, 470, 478, 625, 636
STM-0e.....	80
STM-1.....	84, 91, 104
STM-1 Channel.....	313, 326
STM-16.....	84, 91, 104
STM-1e.....	80

STM-256.....	88, 91
STM-4.....	84, 91, 104
STM-64.....	84, 91, 104
Stop Time	130
stopped.....	113
storage requirements	555
Stream.....	394
STS-1 fixed stuff columns	530
STS-1 REI-L.....	621
STS-1e	80
STS-3e	80
STS-n REI-L.....	621
successful	428
summary report.....	44
summary tabs.....	125
Superblock Statistic	431, 448
switching mode.....	236, 328
SYMB.....	156
Symbol	400
symbols, safety.....	5
synchronization status.....	621
synchronization status message	117
synchronization status message byte	633
System Tab	519

T

tab

alarm summary	132
Application Preferences	528
APS/Advanced Line OH TX/RX (SONET)	236
Client Offset RX.....	515
Client Offset TX.....	513
Clock Synchronization.....	520
Configuration	393
Default Test Preferences.....	530
DS0/64K RX.....	273
DS0/64K TX	270
DS1 RX.....	278
DS1 TX.....	275
DS3 FEAC RX.....	301
DS3 FEAC TX	297

DS3 RX.....	295	LCAS Sink.....	481
DS3 TX.....	293	LCAS Sink Alarm.....	484
E0/64 RX.....	373	LCAS Sink Configuration.....	489
E0/64K TX.....	370	LCAS Sink MST/RS-Ack Control.....	487
E1 TX.....	375	LCAS Sink Overview.....	482
E1/2M RX.....	378	LCAS Source.....	468
E2/8M RX.....	383	LCAS Source Configuration.....	479
E2/8M TX.....	381	LCAS Source Error.....	473
E3/34M TX.....	385, 387	LCAS Source MST/RS-Ack Control.....	477
E4 TX.....	389	LCAS Source Overview.....	469
E4/140M RX.....	391	LCAS Source SQ/CTRL Control.....	475
Error/Alarm RX.....	399	Line OH TX/RX (SONET).....	234
Error/ALarm TX.....	396	Line TX (SONET).....	223
FDL PRM Current RX.....	291	LOP OH TX/RX (SDH, TU-3 path).....	367
FDL PRM RX.....	290	LOP OH TX/RX (SDH).....	356
FDL PRM TX.....	288	LOP OH TX/RX (SONET).....	266
FDL RX.....	285	LOP pointer adjust RX (SONET/SDH).....	495
FDL TX.....	280	LOP pointer adjust TX (SONET/SDH).....	492
FEC RX.....	156	LOP RX (SDH, TU-3 path).....	364
FEC TX.....	154	LOP RX (SDH).....	353
GFP Channel RX.....	451	LOP RX (SONET).....	263
GFP Channel Stats RX.....	454	LOP TX (SDH, TU-3 path).....	358
GFP Channel Stats TX.....	439	LOP TX (SDH).....	347
GFP Channel TX.....	435	LOP TX (SONET).....	257
GFP Client RX.....	457	Module Information.....	544
GFP Client TX.....	444	Multiplex Section APS/Adv OH TX/RX (SDH)	
GFP Frames RX.....	449	328	
GFP Frames Stats RX.....	447	Multiplex Section OH TX/RX (SDH).....	326
GFP Frames TX.....	432	Multiplex Section RX (SDH).....	320
GFP OH RX.....	455	Multiplex Section TX (SDH).....	315
GFP OH TX.....	440	ODU OH RX.....	191
GFP Overview TX.....	431	ODU OH TX.....	182
GMP RX.....	209	ODU RX.....	189
GMP TX.....	208	ODU TCM RX.....	175
HOP OH TX/RX (SDH).....	344	ODU TCM TTI RX.....	178
HOP OH TX/RX (SONET).....	254	ODU TCM TTI TX.....	173
HOP pointer adjust RX (SONET/SDH).....	495	ODU TCM TX.....	170
HOP pointer adjust TX (SONET/SDH).....	492	ODU TTI/FTFL RX.....	194
HOP RX (SDH).....	341	ODU TTI/FTFL TX.....	186
HOP RX (SONET).....	251	ODU TX.....	180
HOP TX (SDH).....	335	OPU OH RX.....	205
HOP TX (SONET).....	245	OPU OH TX.....	200

Index

OPI RX	203	tab configuration	49
OPI TX	197	tab name	50
OTU OH RX	166	tabs	30, 31
OTU OH TX	160	TC access point identifier	499
OTU RX	163	TC-access point identifier	503
OTU TTI RX	168	TC-BIP	498
OTU TTI TX	162	TC-IAIS	499, 502
OTU TX	157	TC-IEC	498, 501
Pattern RX	409	TC-LTC	499, 502
Pattern TX	405	TCM	183, 184, 636
Performance Monitoring (PM)	504	TCM ACT	183
port	137	TCM level	170, 173, 175, 178
Port RX (Electrical Interfaces)	142	TCM RX	500
Port RX (Optical Interfaces)	150	TCM TX	497
Port RX (Electrical Interfaces)	138	TCMi	170, 175
Port TX (Optical Interfaces)	147	TCMi TTI trace	178
Port TX (optical interfaces)	147	TCMi-BDI	171, 177
Regenerator Section OH TX/RX (SDH) ..	313	TCMi-BEI	176
Regenerator Section RX (SDH)	311	TCMi-BIAE	171, 177
Regenerator Section TX (SDH)	305	TCMi-BIP-8	176
Remote Control	549	TCMi-IAE	171, 177
Round Trip Delay (RTD)	425	TCMi-LTC	171, 177
RTD	425	TCMi-TIM	177
Section OH TX/RX (SONET)	221	TC-RDI	499, 502
Section RX (SONET)	219	TC-REI	498, 500
Section TX (SONET)	213	TC-TIM	502
Service Disruption Time (SDT)	411	TC-UNEQ	499, 502
Service Disruption Time (SDT) - Monitor	415	TC-VIOL	500
Service Disruption Time (SDT) - Results	421	technical support	560
Software Options	546	Temote fault	397
Statistics RX	402	temperature for storage	555
Statistics TX	401	term	142, 522, 523
Summary	125	termination mode	68, 72, 142, 522
TCM RX	500	bridge	522, 523
TCM TX	497	Mon	522
test logger	135	monitor	523
test summary	125	term	522, 523
Tools	551	test	64, 133
VCAT RX Diff Delay	466	test case report	45
VCAT RX Overview	463	test configuration	126
VCAT TX Diff Delay	461	Test controls	37
VCAT TX Overview	459	Test Description	128

Test global status	35
Test Mode	126
test mode... 66, 71, 75, 79, 83, 87, 91, 92, 97, 103, 108	
Test Name	126
test name	62
Test Pattern	406
test pattern	531
test period	413, 419
test report	42
Test Setup	59
test setup	62
Test Status	126
test time display mode	529
tHEC	456
tHEC correctable.....	437, 453
tHEC uncorrectable	437, 453
Through	128
throughput	403
time.....	39, 136, 291
time format	528
time options.....	528
time zone	528
timeout count	470, 478
Timer Configuration	130
timeslot.....	118, 221, 234
TIM-P.....	252
TIM-S.....	219
TIM-V	264
TLCR	485
TLCT	472
Toggle RS-Ack	478, 488
tone	272, 372
Tools	551
top page	50
Total.....	431, 448
total	401, 402
Total Count.....	401, 403
total error count.....	400
total events	135
total frames.....	448
trace.....	618, 623, 626, 634, 637
trace message.....	630
traffic.....	64
transmitted count.....	483, 488
transmitted value	488
transparent-mapped GFP.....	645
transport layer	431, 448
transportation requirements.....	555, 560
tree view.....	62
trib scan	114
trib scan in-progress.....	113
tributary	120
TRN.....	545
troubleshooting.....	559
TS16 AIS	375, 379
TU-AIS	350, 354, 361, 365
TU-LOP.....	350, 354, 361, 365
TX.....	520
TX Rate	394
Type.....	407, 408
type51, 148, 155, 158, 159, 171, 172, 180, 181, 213, 223, 305, 335, 395, 396, 397	
type header	441, 456
type HEC field	653
U	
UAS	508, 512
UMST.....	472, 485
Unassigned.....	287
undersize.....	400
UNEQ-P.....	248, 252
UNEQ-V	260, 264
unexpected count.....	478
UniCast.....	401, 402
Unit	517
unit.....	428
UPI 86, 95, 101, 107, 432, 437, 442, 449, 450, 456	
USA	528
user	619
user channel	625, 631
user defined CMF	436

Index

User Duration	130
user information	549
User Pattern	406
user payload identifier	651
user-defined UPI	437
UTC	528
utilization	403

V

V5	266, 356, 357, 626, 637
Valid	448
valid count	290, 292
Value	406
VC path overhead	637
VCAT	430, 656
VCAT differential delay	667
VCAT RX Diff Delay	466
VCAT RX Overview	463
VCAT TX Diff Delay	461
VCAT TX Overview	459
Verdict	
FAIL	423
PASS	423
VID	642
view report after generation	43
virtual concatenation	656
VLAN	395, 642
VLAN Priority	642
VLAN, priority	395, 642
VT path overhead	626
VT path trace	626
VT payload pointer	628, 639

W

wait-to-restore timer	490
warranty	561
certification	562
exclusions	562
general	561
liability	561
wavelength	148

X

X	28, 34
XFP	545, 559

Z

Z0	222, 314, 618, 630
Z1	235, 621
Z2	235, 622
Z3	255, 625
Z4	255, 625
Z5	625
Z6	266, 626
Z7	266, 627
Z7 Structure	626
zero code suppression	271, 371

NOTICE

通告

CHINESE REGULATION ON RESTRICTION OF HAZARDOUS SUBSTANCES

中国关于有害物质限制的规定

NAMES AND CONTENTS OF THE TOXIC OR HAZARDOUS SUBSTANCES OR ELEMENTS CONTAINED IN THIS EXFO PRODUCT

包含在本 **EXFO** 产品中的有毒有害物质或元素的名称和含量



O	Indicates that this toxic or hazardous substance contained in all of the homogeneous materials for this part is below the limit requirement in SJ/T11363-2006 表示该有毒有害物质在该部件所有均质材料中的含量均在 SJ/T11363-2006 标准规定的限量要求以下。
X	Indicates that this toxic or hazardous substance contained in at least one of the homogeneous materials used for this part is above the limit requirement in SJ/T11363-2006 表示该有毒有害物质至少在该部件的某一均质材料中的含量超出 SJ/T11363-2006 标准规定的限量要求。

Part Name 部件名称	Toxic or hazardous Substances and Elements 有毒有害物质和元素					
	Lead 铅 (Pb)	Mercury 汞 (Hg)	Cadmium 镉 (Cd)	Hexavalent Chromium 六价铬 (Cr VI)	Polybrominated biphenyls 多溴联苯 (PBB)	Polybrominated diphenyl ethers 多溴二苯醚 (PBDE)
Enclosure 外壳	O	O	O	O	O	O
Electronic and electrical sub-assembly 电子和电子组件	X	O	X	O	X	X
Optical sub-assembly ^a 光学组件 ^a	X	O	O	O	O	O
Mechanical sub-assembly ^a 机械组件 ^a	O	O	O	O	O	O

a. If applicable.
如果适用。

MARKING REQUIREMENTS

标注要求

Product 产品	Environmental protection use period (years) 环境保护使用期限 (年)	Logo 标志
This EXFO product 本 EXFO 产品	10	
Battery ^a 电池 ^a	5	

- a. If applicable.
如果适用。

P/N: 1067438

www.EXFO.com · info@exfo.com

CORPORATE HEADQUARTERS	400 Godin Avenue	Quebec (Quebec) G1M 2K2 CANADA Tel.: 1 418 683-0211 · Fax: 1 418 683-2170
EXFO AMERICA	3400 Waterview Parkway Suite 100	Richardson, TX 75080 USA Tel.: 1 972-761-9271 · Fax: 1 972-761-9067
EXFO EUROPE	Winchester House, School Lane	Chandlers Ford, Hampshire S053 4DG ENGLAND Tel.: +44 2380 246 800 · Fax: +44 2380 246 801
EXFO ASIA-PACIFIC	62 Ubi Road 1, #09-01/02 Oxley Bizhub 2	SINGAPORE 408734 Tel.: +65 6333 8241 · Fax: +65 6333 8242
EXFO CHINA	Beijing Global Trade Center, Tower C, Room 1207, 36 North Third Ring Road East, Dongcheng District	Beijing 100013 P. R. CHINA Tel.: +86 (10) 5825 7755 · Fax: +86 (10) 5825 7722
EXFO SERVICE ASSURANCE	270 Billerica Road	Chelmsford MA, 01824 USA Tel.: 1 978 367-5600 · Fax: 1 978 367-5700
EXFO FINLAND	Elektroniikkatie 2	FI-90590 Oulu, FINLAND Tel.: +358 (0) 403 010 300 · Fax: +358 (0) 8 564 5203
TOLL-FREE	(USA and Canada)	1 800 663-3936

© 2014 EXFO Inc. All rights reserved.
Printed in Canada (2014-12)

