

LTB Series



Copyright © 2016–2023 EXFO Inc. All rights reserved. No part of this publication may be reproduced, stored in a retrieval system or transmitted in any form, be it electronically, mechanically, or by any other means such as photocopying, recording or otherwise, without the prior written permission of EXFO Inc. (EXFO).

Information provided by EXFO is believed to be accurate and reliable. However, no responsibility is assumed by EXFO for its use nor for any infringements of patents or other rights of third parties that may result from its use. No license is granted by implication or otherwise under any patent rights of EXFO.

EXFO's Commerce And Government Entities (CAGE) code under the North Atlantic Treaty Organization (NATO) is 0L8C3.

The information contained in this publication is subject to change without notice.

Trademarks

EXFO's trademarks have been identified as such. However, the presence or absence of such identification does not affect the legal status of any trademark.

Where applicable, the Bluetooth[®] word mark and logos are registered trademarks owned by Bluetooth SIG, Inc. and any use of such marks by EXFO Inc. is under license. Where applicable, the MTP[®] mark is a registered trademark of US Conec Ltd. Other third party trademarks and trade names are those of their respective owners.

Units of Measurement

Units of measurement in this publication conform to SI standards and practices.

Patents

The exhaustive list of patents is available at EXFO.com/patent.

Version number: 4.0.1.1

Contents

Regulatory Information	vii
1 Introducing the LTB Series Unit	1
Main Features	1
LTB-2	3
LTB-8	5
LTB-12	8
LED Indicators Description	10
Function Buttons Description	13
Product Registration	14
Technical Specifications	14
Conventions	15
2 Safety Information	17
Other Safety Symbols on Your Unit	19
Laser Safety Information	20
Electrical Safety Information	21
Automatic Fan Speed Management	25
3 Getting Started with Your Unit	27
Using Your Unit as a Benchtop Unit	27
Installing Your Unit in a Rack	31
Grounding Your Unit	39
Connecting a Monitoring Device to the Dry Contact Relays (LTB-2 and LTB-8 Only)	42
Locating the Synchronization Ports (LTB-8 Only)	47
Inserting and Removing Test Modules	48
Connecting Your LTB-2 Unit to a Power Source	53
Turning on Your Unit	61
Turning off Your Unit	64
Configuring Your Unit At First Startup	66
Accessing and Exiting Toolbox X	71
Starting Module Applications	72
Understanding Module Statuses	73
Installing or Upgrading EXFO Applications	75
Activating Software Options	77
Installing Third-Party Software on Your Unit	80
Protecting your Unit with an Antivirus Software	80

Contents

4	Setting Up Your Unit	81
	Enabling or Disabling the Automatic Logon	81
	Selecting the Startup Applications	85
	Selecting the Language of Operation	87
	Setting Date and Time Formats	96
	Adjusting the Date, Time and Time Zone	98
	Setting Toolbox X Behavior	101
	Configuring the Internet Options	103
	Reconfiguring the Local Access Ports in LAN/WAN Ports	106
	Setting Other Parameters	106
5	Working with Your Unit	107
	Printing Documents	107
	Viewing PDF Files	108
	Browsing the Web	109
	Managing Favorites	110
	Using the Calculator	117
	Using the Text Editor	118
	Accessing Other Tools	118
6	Working with Intel Active Management Technology	119
	Installing the AMT Remote Access Application on a Computer	120
	Connecting to Your Unit Remotely With AMT Remote Access	121
	Modifying the IP Address of the Local Access (Management) Ports	129
	Changing the AMT Administrator Password	131
	Managing the AMT User Accounts	133
	Turning the Unit On or Off Remotely	138
	Performing Other Operations	139
7	Inspecting Fibers with a Probe	141
8	Managing Data	143
	Viewing Disk Space and Managing Files	144
	Freeing Up Disk Space with the Disk Cleanup Utility	145
	Connecting to a VPN from Your Unit	149
9	Accessing Your Unit Remotely	155
	Working with Remote Desktop	157
	Working With VNC	167
	Adding Exceptions to the Firewall	174

10 Preparing for Automation	179
Preparing Hardware for GPIB Control	181
Linking Units with the GPIB Port	183
Linking Units with an Ethernet Port	183
Linking Units with the Serial Port	185
Getting Optimum Performance from Your Unit	186
Enabling or Disabling Compatibility With Legacy IQS Programs	188
Changing Communication Settings	190
Configuring DCOM Access to Your Unit	196
Configuring Your Instruments	219
11 Using Your Unit and Modules in an Automated Test Environment	227
Standard Status Data Structure	228
SCPI Command Structure	232
Consulting Data Types	235
Writing Remote Control Code	236
Error Message Format	238
Monitoring Remote Commands	239
12 Maintenance	243
Connecting Remotely to Your Unit for Maintenance or Troubleshooting	243
Managing Windows Updates	244
Replacing Hard Disks (LTB-8 and LTB-12 Only)	248
Replacing Fuses (LTB-2 Only)	258
Recycling and Disposal	260
13 Troubleshooting	261
Solving Common Problems	261
Restoring Your Unit to Normal Operation	266
Accessing the Online Documentation	297
Contacting the Technical Support Group	298
Retrieving the Hardware Version of Your Unit	298
Viewing System Information	299
Transportation	303
14 Warranty	305
General Information	305
Gray Market and Gray Market Products	306
Liability	307
Exclusions	307
Certification	307
Service and Repairs	308
EXFO Service Centers Worldwide	309

Contents

A Data Types	311
Applicable Data Types for Input—IEEE 488.2	312
Applicable Data Types for Output —IEEE 488.2	321
Applicable Data Types for Input—SCPI	331
Special Numeric Values Received on Output	332
B IEEE 488.2 and Specific Command Reference	333
IEEE 488.2 Commands—Quick Reference	333
IEEE 488.2 Required Commands	334
Specific Commands—Quick Reference	354
Specific Commands	355
C SCPI-Based Errors	377
D COM Properties and Events	393
ActiveX (COM/DCOM)—Quick Reference	394
Properties	395
Events	402
E Communicating Through TCP/IP Over Telnet	403
Executing SCPI Commands Over Telnet	403
Accessing Modules	409
Internal Commands of the TCP/IP over Telnet Protocol	411
Index	423

Regulatory Information

USA Electromagnetic Interference Regulatory Statement

Electronic test and measurement equipment is exempt from FCC part 15, subpart B compliance in the United States of America. However, EXFO Inc. makes reasonable efforts to ensure compliance to the applicable standards.

The limits set by these standards are designed to provide reasonable protection against harmful interference when the equipment is operated in a commercial environment. This equipment generates, uses, and can radiate radio frequency energy and, if not installed and used in accordance with the user documentation, may cause harmful interference to radio communications. Operation of this equipment in a residential area is likely to cause harmful interference in which case the user will be required to correct the interference at his own expense.

Modifications not expressly approved by the manufacturer could void the user's authority to operate the equipment.

Canada Electromagnetic Interference Regulatory Statement

This equipment generates, uses, and can radiate radio frequency energy and, if not installed and used in accordance with the instruction manual, may cause harmful interference to radio communications. Operation of this equipment in a residential area is likely to cause harmful interference.

Cet équipement génère, utilise et peut émettre de l'énergie radio-fréquence et, s'il n'est pas installé et utilisé conformément à la documentation de l'utilisateur, il peut occasionner une interférence néfaste aux communications radio. L'utilisation de cet équipement dans une zone résidentielle est susceptible d'occasionner une interférence néfaste.

Regulatory Information

Caution: This equipment is not intended for use in residential environments and may not provide adequate protection to radio reception in such environments.

Attention : Cet appareil n'est pas destiné à être utilisé dans des environnements résidentiels et peut ne pas assurer la protection adéquate à la réception radioélectrique dans ce type d'environnements.

This is a class A, group 1 product.

Ceci est un produit de classe A, groupe 1.

- **Class A equipment:** Equipment that is, by virtue of its characteristics, highly unlikely to be used in a residential environment, including a home business shall be classified as class A and shall comply with the class A limits specified in the applicable ICES standard. Characteristics considered in this assessment include price, marketing and advertising methodology, the degree to which the functional design inhibits applications suitable to residential environments, or any combination of features that would effectively preclude the use of such equipment in a residential environment.

Classe A : Matériel qui, en raison de ses caractéristiques, ne sera fort probablement pas utilisé dans un milieu domiciliaire ni par des entreprises établies à domicile. Parmi les caractéristiques considérées dans cette évaluation, il y a le prix, les méthodes de commercialisation et de publicité, la mesure dans laquelle les fonctions de l'appareil font qu'il ne se prête pas à des applications convenant au milieu domiciliaire ou toute combinaison de ces caractéristiques qui aurait pour conséquence d'en prévenir effectivement l'utilisation à domicile. Utilisé également pour indiquer les limites d'émission correspondantes qui s'appliquent à un tel matériel.

- **Class B equipment:** Equipment that cannot be classified as Class A shall comply with the Class B limits specified in the applicable ICES standard.

Classe B : Matériel qui ne peut pas être inclus dans la classe A. Utilisé également pour indiquer les limites d'émission correspondantes qui s'appliquent à un tel matériel.

- Group 1 equipment: group 1 contains all equipment which is not classified as group 2 equipment, and includes equipment such as laboratory and scientific equipment, industrial process, measurement and control equipment.

Group 2 equipment: group 2 contains all ISM RF equipment in which radio-frequency energy in the frequency range 9 kHz to 400 GHz is intentionally generated and used or only used locally, in the form of electromagnetic radiation, inductive and/or capacitive coupling, for the treatment of material for inspection/analysis purposes, or for transfer of electromagnetic energy.

Appareils du groupe 1 : le groupe 1 réunit tous les appareils compris dans le domaine d'application de la présente Norme, qui ne sont pas classés comme étant des appareils du groupe 2. Le groupe 1 inclut les appareils scientifiques et de laboratoire, les processus industriels, appareils de mesure ou de contrôle.

Appareils du groupe 2 : le groupe 2 réunit tous les appareils ISM à fréquences radioélectriques dans lesquels de l'énergie à fréquences radioélectriques dans la plage de fréquences comprises entre 9 kHz et 400 GHz est produite et utilisée volontairement ou uniquement utilisée localement sous forme de rayonnement électromagnétique, de couplage inductif et/ou capacitif, pour le traitement de la matière, à des fins d'examen ou d'analyse ou pour le transfert d'énergie électromagnétique.

Supplier's Declaration of Conformity (SDoC)

The SDoC for your product is as follows:

CAN ICES-001 (A) / NMB-001 (A)

EU and UK Electromagnetic Compatibility Regulatory Statement

Warning: This is a class A product. In a domestic environment, this product may cause radio interference in which case the user may be required to take adequate measures. Your product is suitable for use in industrial electromagnetic environments.

Simplified EU and UK Declaration of Conformity

The full text of the declaration of conformity is available at the following Internet address: *www.exfo.com/en/resources/legal-documentation*.

EU Economic Operator

EXFO Solutions SAS
2, rue Jacqueline Auriol,
Saint-Jacques-de-la-Lande,
35091 Rennes Cedex 9
FRANCE

1 Introducing the LTB Series Unit

Main Features

Your unit includes the following:

- Two, eight, or twelve module slots, depending on the model
- Two separated network controllers (one can be used for extended remote management with Intel Active Management Technology – AMT)
- Possibility to use as a benchtop or rack-mounted unit.
- Six USB 3.0 host ports
- Ethernet ports (10/100/1000 Base-T):
 - LTB-2 and LTB-8: Three ports
 - LTB-12: Two ports
- Two different external monitor ports (LTB-8 and LTB-12):
 - LTB-8: for monitors supporting the VGA or DVI interfaces, OR monitors supporting the HDMI or DisplayPort interfaces, depending on the hardware version of your unit (for more information, see *Retrieving the Hardware Version of Your Unit* on page 298).
 - LTB-12: for monitors supporting the VGA or HDMI interfaces
- Main stream operating system:
 - LTB-2 and LTB-12: Windows 10 IoT Enterprise
 - LTB-8: Windows 10 IoT Enterprise or Windows 8.1 Pro, depending on the time of purchase of your unit. Units running Windows 8.1 Pro can be upgraded to Windows 10 IoT Enterprise by purchasing a license from EXFO.
- Insertion and removal of the modules without turning off the unit (hot swap).
- Multitasking possibilities

Introducing the LTB Series Unit

Main Features

- Remote access to your unit (via Intel AMT, TightVNC or Remote Desktop)
- Modules and instruments can be controlled locally via the Toolbox X software or remotely through GPIB (USB to GPIB adapter, sold by EXFO, required), RS-232 or Ethernet TCP/IP (using SCPI commands).
- Direct Web access from your unit
- PDF file viewer available from your unit
- Easy software updates

Note: *For information about the LTB-1, refer to its dedicated user guide.*

Note: *Depending on the version of operating system that your unit is running, the appearance of the applications may vary slightly from the illustrations presented in this documentation.*

Note: *In many procedures, the illustrations show the LTB-8 unit. However, unless otherwise specified, the information applies to all models of the LTB Series.*

LTB-2

Front panel

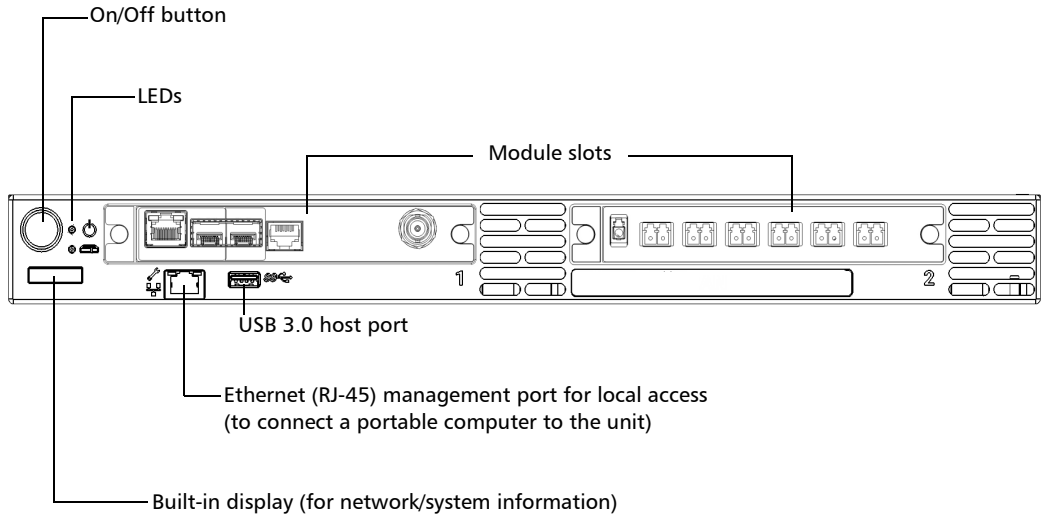

Introducing the LTB Series Unit

LTB-2

Back panel

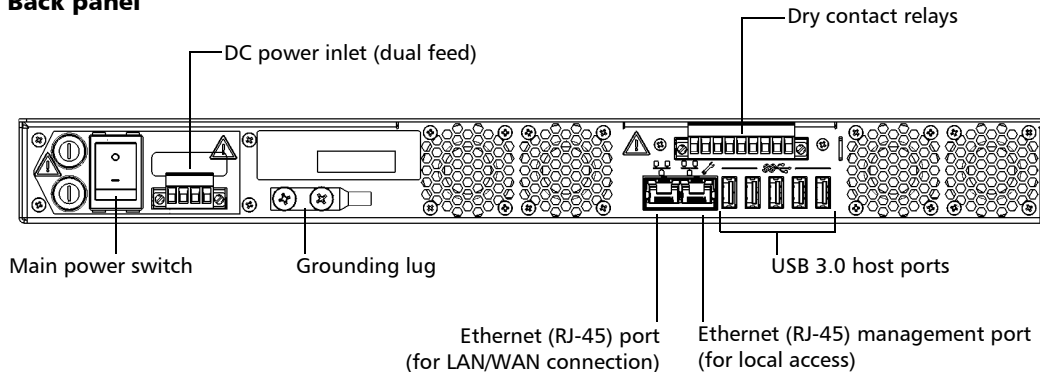

Note: You can also connect the unit to AC power with the AC/DC power adapter sold by EXFO.

LTB-8

Front panel

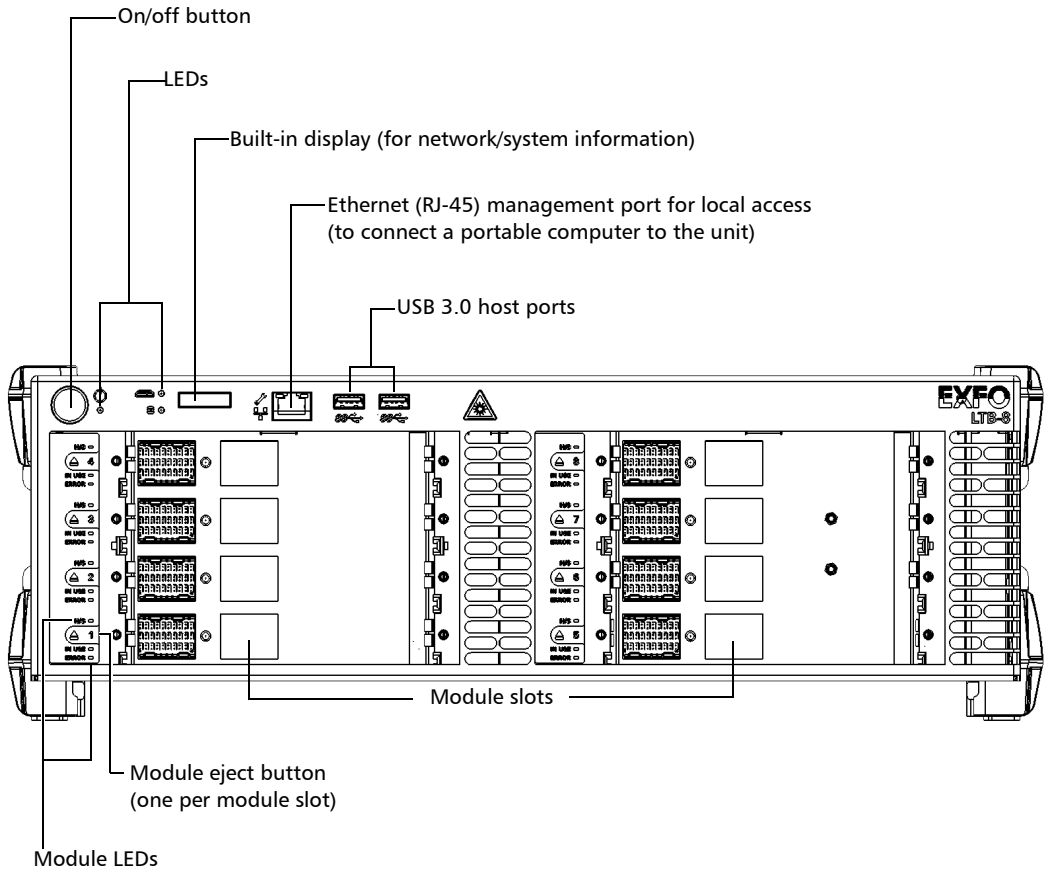

Introducing the LTB Series Unit

LTB-8

Back panel

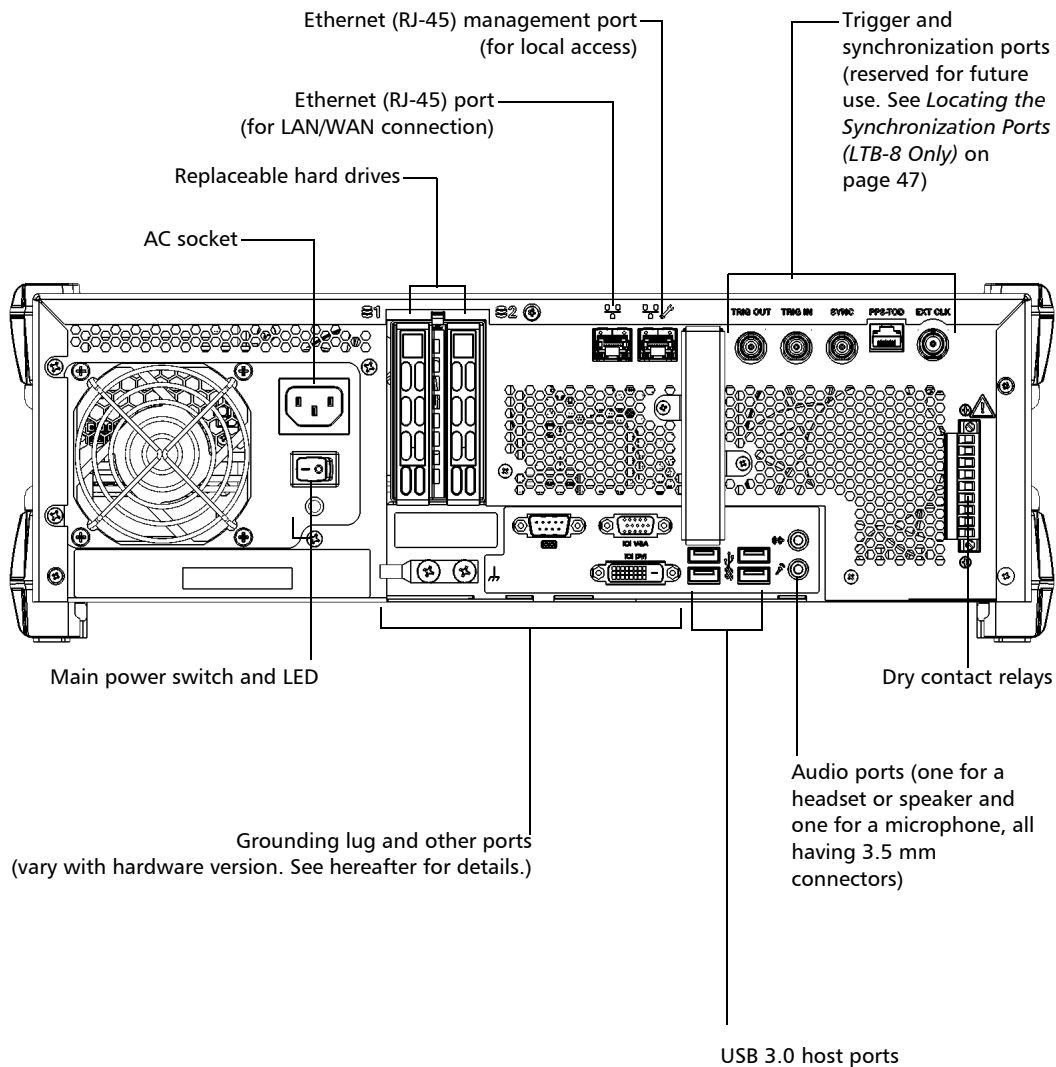

Back panel (continued)

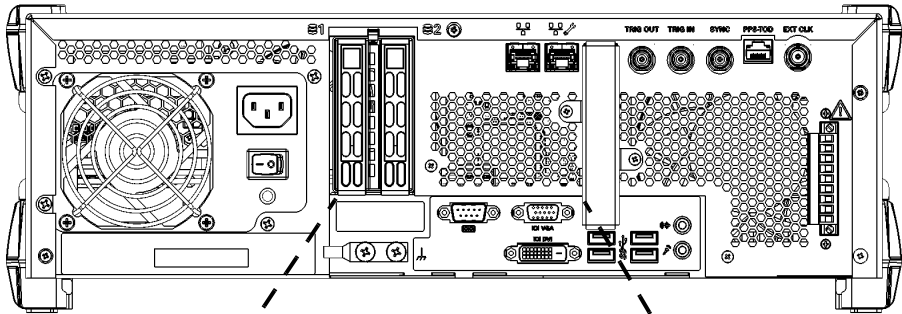

Single-letter hardware version (such as C)

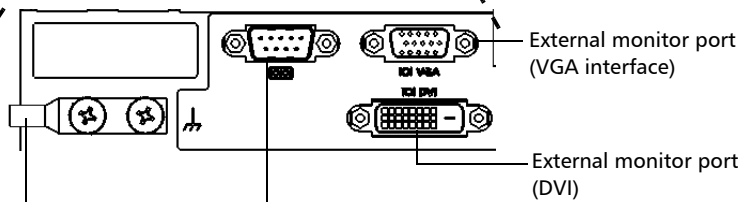

Double-letter hardware version (such as AA)

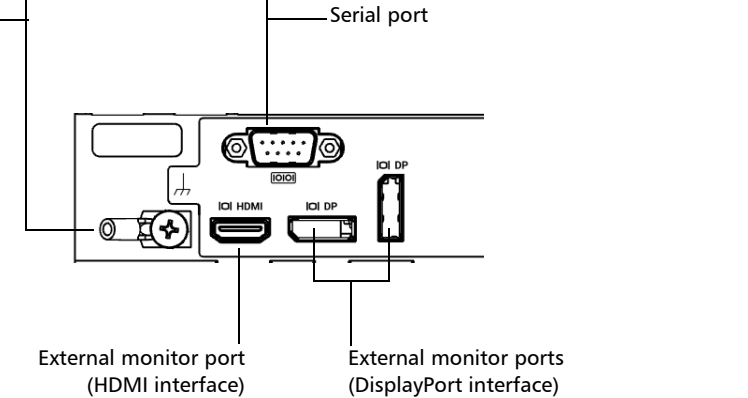

Note: For more information on how to determine the hardware version of your unit, see Retrieving the Hardware Version of Your Unit on page 298.

Introducing the LTB Series Unit

LTB-12

LTB-12

Front panel

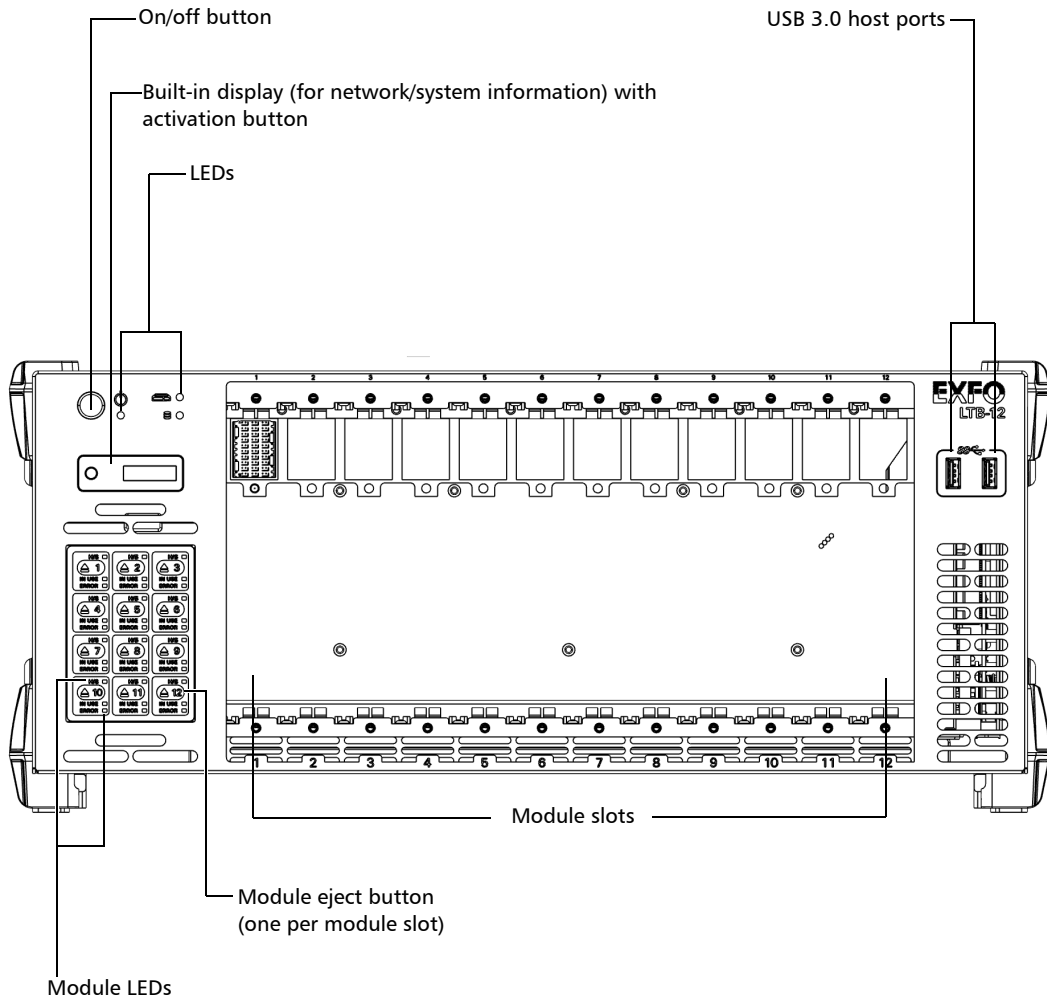

Back panel

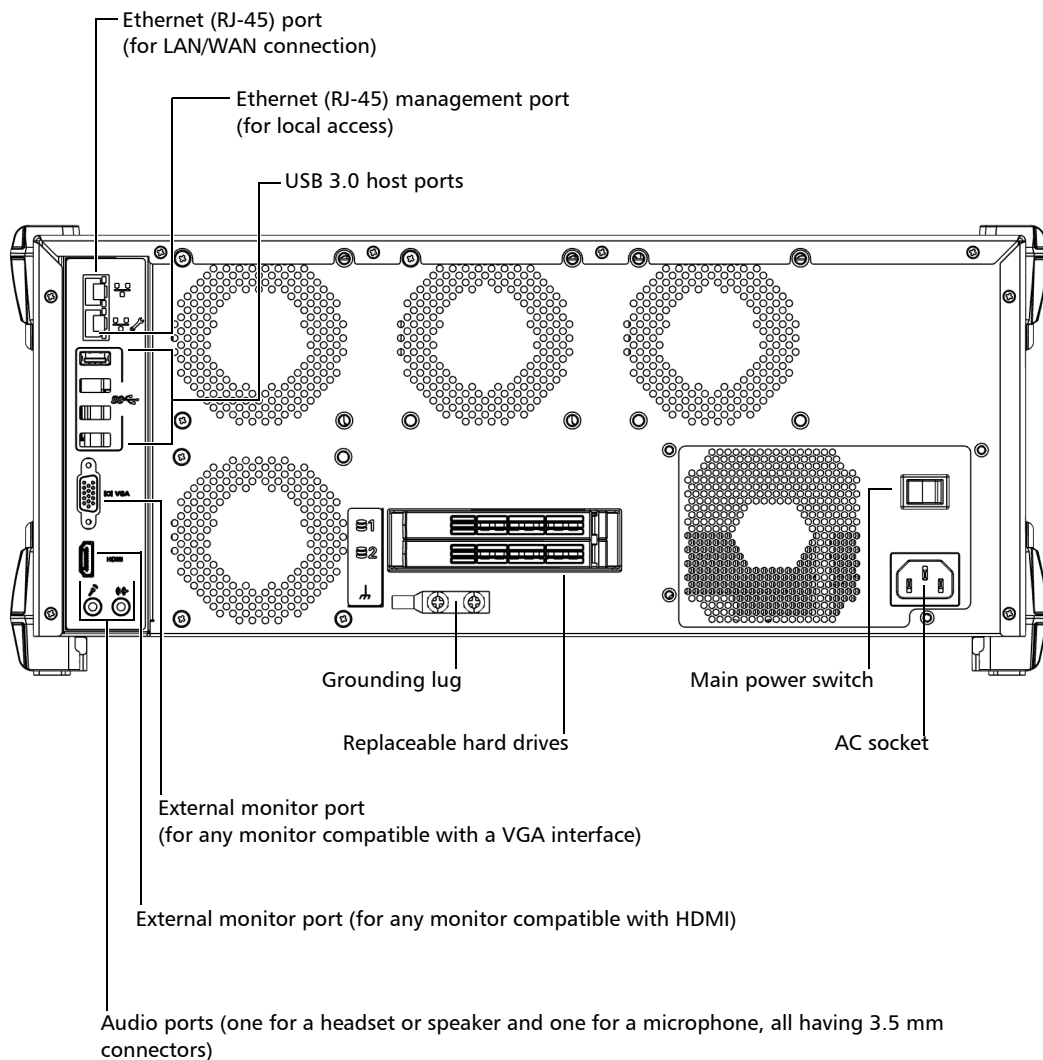



Introducing the LTB Series Unit

LED Indicators Description

There are several LED indicators located on the front panel of your unit, providing you with information about the power, system, and module statuses (module LEDs available on LTB-8 and LTB-12 only).

The table below presents the possible statuses once the initial startup sequence is complete.

LED	Status	Meaning
 Power	Green	Unit is on.
	Green, blinking	Unit is in Sleep or Hibernation mode ^a .
	Yellow	One of the unit's fuse is blown ^b .
	Off	Unit is off.
 System ^c	Green	The unit is working properly and is ready.
	Green, blinking	The initialization of the unit is underway.
	Yellow	Non-critical hardware error detected. The temperature of the room where the unit is located could be slightly too high. Ensure that the temperature falls within the specified operating temperature range (see <i>Electrical Safety Information</i> on page 21). If the problem persists, contact EXFO.
	Red	Critical hardware error detected. The temperature of the room where the unit is located is critically too high. Ensure that the temperature falls within the specified operating temperature range (see <i>Electrical Safety Information</i> on page 21). If the problem persists, contact EXFO.
	Off	Unit is off.

LED	Status	Meaning
 Hard disk ^d	Lit	Reading or writing operations are currently performed on the hard disk.
	Off	Unit is off, or no reading or writing operations are currently performed on the hard disk.
H/S – Hot Swap (one LED per module slot) ^d	Blue, blinking	The corresponding module is in a transition state. The module is either being prepared for removal, or being detected by the system.
	Blue	The corresponding module can now be removed safely from the unit.
	Off	<ul style="list-style-type: none"> ▶ Unit is off. ▶ No module is inserted in the corresponding module slot. ▶ A module is inserted in the corresponding slot, but no removal of this module has been requested.
IN USE (one LED per module slot) ^d	Green	The corresponding module is in use.
	Green, blinking	A test or a measurement, using the corresponding module, is underway.
	Off	<ul style="list-style-type: none"> ▶ Unit is off. ▶ The module is not in use. ▶ No module is inserted in the corresponding module slot.

Introducing the LTB Series Unit

LED Indicators Description



LED	Status	Meaning
ERROR (one LED per module slot) ^d	Red	<ul style="list-style-type: none">▶ The detected temperature of the corresponding module is too high. This could lead to a thermal shutdown of the module if no action is taken to reduce the temperature.▶ The corresponding module uses more power than what is available from the unit.
	Off	<ul style="list-style-type: none">▶ Unit is off.▶ The module is working properly.▶ No module is inserted in the corresponding module slot.

- On the LTB-8, the LED will blink rapidly when the unit is in Sleep mode, and will blink slowly when the unit is in Hibernation mode.
- Applies only to the LTB-2 unit.
- If more than one error is detected at the same time, the color of the LED will be set according to the most severe error (red as the most severe, followed by yellow).
- Not available on the LTB-2 unit.

Function Buttons Description

Your unit is equipped with function buttons that give you access to features at all times.

The table below shows an overview of their purpose.

Button	Meaning
	Turns your unit on and off. Press for one second to turn the unit on. For more information on the various ways to turn off your unit, see <i>Turning off Your Unit</i> on page 64.
 ^a	Press to safely remove the module from the corresponding slot. Wait for the blue H/S led to stop flashing and turn steady blue before removing the module (see <i>LED Indicators Description</i> on page 10).
Display activation button (located next to the built-in display) ^b	Press to display the IP address information when the built-in display is off.

- a. Not available on the LTB-2 unit.
- b. Available on the LTB-12 unit only.

Product Registration

You can now register your new EXFO products online and benefit from every possible opportunity to optimize their performance. By doing so, you will always be notified of the latest software updates, key product enhancements and up-to-date support information related to your products.

To register your product online:

- 1.** Open a Web browser and go to www.exfo.com.
- 2.** Log in to your EXFO account.
- 3.** Click **Support** > **Product registration**.
- 4.** Under **My Products**, click **Register**.
- 5.** Follow the on-screen instructions.

Technical Specifications

To obtain this product's technical specifications, visit the EXFO Web site at www.exfo.com.

Conventions

Before using the product described in this guide, you should understand the following conventions:



WARNING

Indicates a potentially hazardous situation which, if not avoided, could result in *death or serious injury*. Do not proceed unless you understand and meet the required conditions.



CAUTION

Indicates a potentially hazardous situation which, if not avoided, may result in *minor or moderate injury*. Do not proceed unless you understand and meet the required conditions.



CAUTION

Indicates a potentially hazardous situation which, if not avoided, may result in *component damage*. Do not proceed unless you understand and meet the required conditions.



IMPORTANT

Refers to information about this product you should not overlook.

2 **Safety Information**



WARNING

Do not install or terminate fibers while a light source is active. Never look directly into a live fiber and ensure that your eyes are protected at all times.



WARNING

The use of controls, adjustments and procedures, namely for operation and maintenance, other than those specified herein may result in hazardous radiation exposure or impair the protection provided by this unit.



WARNING

If the equipment is used in a manner not specified by the manufacturer, the protection provided by the equipment may be impaired.



WARNING

Use only accessories designed for your unit and approved by EXFO. For a complete list of accessories available for your unit, refer to its technical specifications or contact EXFO.



IMPORTANT

Refer to the documentation provided by the manufacturers of any accessories used with your EXFO product. It may contain environmental and/or operating conditions limiting their use.



IMPORTANT

When you see the following symbol on your unit , make sure that you refer to the instructions provided in your user documentation. Ensure that you understand and meet the required conditions before using your product.



IMPORTANT

When you see the following symbol on your unit , it indicates that the unit is equipped with a laser source, or that it can be used with instruments equipped with a laser source. These instruments include, but are not limited to, modules and external optical units.













IMPORTANT

Other safety instructions relevant for your product are located throughout this documentation, depending on the action to perform. Make sure to read them carefully when they apply to your situation.

Other Safety Symbols on Your Unit

One or more of the following symbols may also appear on your unit.

Symbol	Meaning
	Direct current
	Alternating current
	The unit is equipped with an earth (ground) terminal.
	The unit is equipped with a protective conductor terminal.
	The unit is equipped with a frame or chassis terminal.
	On (Power)
	Off (Power)
 OR 	On/off (Power)
	Fuse

Laser Safety Information

Your instrument is in compliance with standard IEC 60825-1: 2014.



WARNING

Viewing the laser output with telescopic optical instruments (for example, telescopes and binoculars) may pose an eye hazard and thus the user should not direct the beam into an area where such instruments are likely to be used.

The following label indicates that a product contains a Class 1M source:



Laser radiation may be encountered at the optical output port of the modules or instruments that you use with your unit.

Refer to the user documentation of the different modules for the relevant laser safety information.

The modules and instruments that you use with your unit may have different laser classes. Refer to their user documentation for the exact information.

Electrical Safety Information

The information presented hereafter applies to all LTB Series units, unless otherwise specified.



WARNING

- **LTB-2:** A readily accessible disconnect device must be installed on the mains (AC or DC circuits). The power cord of the AC/DC power adapter can be considered the disconnect device to the main power.
- **LTB-2:** If you intend to connect your unit to AC power, use only the listed and certified AC/DC power adapter provided by EXFO with your unit. It provides reinforced insulation between primary and secondary, and is suitably rated for the country where the unit is sold.
- **LTB-8/LTB-12:** If you need to ensure that the unit is completely turned off, disconnect the power cable.
- Use only the certified power cord that is suitably rated for the country where the unit is used.
- Replacing detachable MAINS supply cords by inadequately RATED cords may result in overheating of the cord and create a risk of fire.

Safety Information

Electrical Safety Information



WARNING

- Use this unit indoors only.
- Do not remove unit covers during operation.
- Operation of any electrical instrument around flammable gases or fumes constitutes a major safety hazard.
- To avoid electrical shock, do not operate the unit if any part of the outer surface (covers, panels, etc.) is damaged.
- LTB-2: Make sure both disconnect devices are turned off before servicing the unit.
- Only authorized personnel should carry out adjustments, maintenance or repair of opened units under voltage. A person qualified in first aid must also be present. Do not replace any components of the LTB-8/LTB-12 while the power cable is connected. Do not replace any components of the LTB-2 while the disconnect devices are turned on.
- LTB-2: Use only fuses with the required rated current and specified type (F10A L, 5 mm x 20 mm (0.197 in x 0.787 in), fast-acting, 250 V). Do not use repaired fuses or short-circuited fuse holders. For more information, see the section about replacing the fuses in this user documentation.
- Unless otherwise specified, all interfaces are intended for connection to ES1 circuits only.
- Capacitors inside the unit may be charged even if the unit has been disconnected from its electrical supply.



CAUTION

Position the unit so that the air can circulate freely around it.

LTB-2

Equipment Ratings	
Temperature	
➤ Operation	<ul style="list-style-type: none"> ➤ unit connected to DC power: -5 °C to 40 °C (23 °F to 104 °F) ➤ unit connected to AC power (with AC/DC power adapter): 0 °C to 40 °C (32 °F to 104 °F)
➤ Storage	<ul style="list-style-type: none"> ➤ -40 °C to 70 °C (-40 °F to 158 °F)
Relative humidity ^a	0 % to 95 % non-condensing
Maximum operation altitude	3000 m (9843 ft)
Pollution degree	2
Overvoltage category	I
Measurement category	Not rated for measurement categories II, III, or IV
Input power ^b	<ul style="list-style-type: none"> ➤ unit: -48 V ---; 10 A^c ➤ AC/DC power adapter (units connected to AC power only): 100 - 240 V ~; 50/60 Hz; 5 - 2.5 A

- a. Measured in 0 °C to 31 °C (32 °F to 87.8 °F) range, decreasing linearly to 50 % at 40 °C (104 °F).
- b. Not exceeding ± 10 % of the nominal voltage.
- c. Range: -38.5 - -70 V.

Safety Information

Electrical Safety Information

LTB-8/LTB-12

Equipment Ratings	
Temperature	
➤ Operation	➤ 0 °C to 40 °C (32 °F to 104 °F)
➤ Storage	➤ -40 °C to 70 °C (-40 °F to 158 °F)
Relative humidity ^a	0 % to 95 % non-condensing
Maximum operation altitude	2000 m (6562 ft)
Pollution degree	2
Overvoltage category	II
Measurement category	Not rated for measurement categories II, III, or IV
Input power ^b	unit: 100 - 240 V ~ ; 50/60 Hz; 10 - 4.2 A

a. Measured in 0 °C to 31 °C (32 °F to 87.8 °F) range, decreasing linearly to 50 % at 40 °C (104 °F).

b. Not exceeding ± 10 % of the nominal voltage.



CAUTION

- The use of voltages higher than those indicated on the label affixed to your unit may damage the unit.
- The operation and storage temperatures, as well as the altitude and relative humidity values of some modules may differ from those specified for your unit. In this case, always ensure that you comply with the most restrictive conditions (either module or unit).

Automatic Fan Speed Management

Your unit will determine the most appropriate fan speed, depending on the power requirements and the type of modules you are using.



IMPORTANT

Fan speed is always determined to cool down the most heat-generating modules.

If the temperature keeps rising and reaches the limit, your unit will turn off. This safety feature protects the unit and its modules against overheating.



CAUTION

Make sure to use protective covers over empty slots of your unit to avoid overheating.

3 Getting Started with Your Unit

Depending on your needs, you can either use your unit as a benchtop unit (*Using Your Unit as a Benchtop Unit* on page 27) or mount it in a rack (see *Installing Your Unit in a Rack* on page 31).

Using Your Unit as a Benchtop Unit

The LTB-8 units come with bumpers already installed, so that they are ready for benchtop usage. However, you must install the rubber feet on the LTB-2 and the bumpers on the LTB-12 if you intend to use them as a benchtop units.



WARNING

- If you are using your unit as a benchtop unit, do not turn it on its side. The unit was not designed to be used in this position and, therefore, could either fall and cause injury, or be damaged.
- To avoid serious injury or irreparable damage to your units, **NEVER STACK MORE THAN FOUR (4) UNITS** on top of each other.

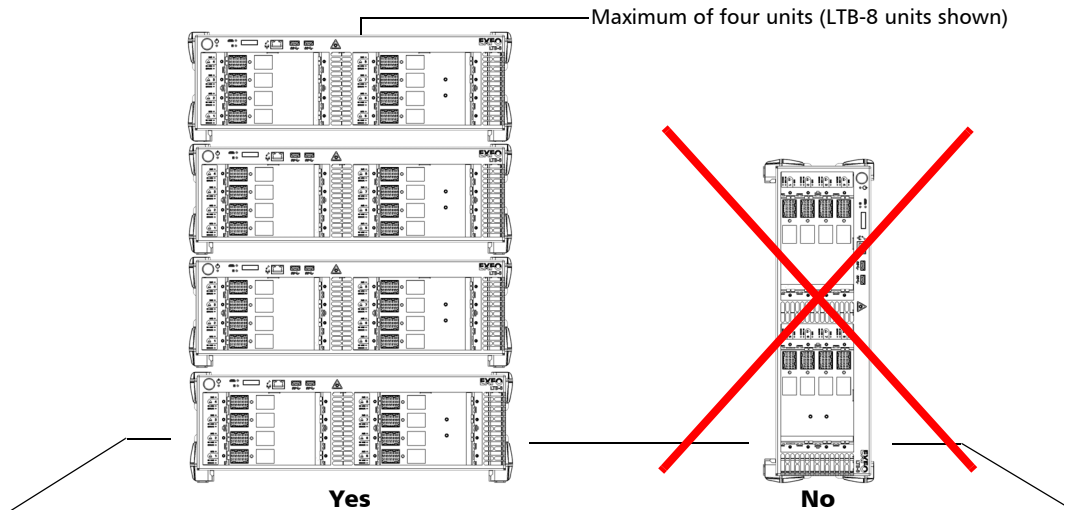

Getting Started with Your Unit

Using Your Unit as a Benchtop Unit



WARNING

- ▶ The bumpers of the LTB-8 and LTB-12 units are designed to allow stacking units on top of each other correctly when they are used as benchtop units. If you want, you can stack a mix of LTB-8 and LTB-12 units (maximum of four units in total). Ensure that their front panels are flush.
- ▶ The LTB-2 units have not been especially designed to be stacked on top of each other. If you choose to stack LTB-2 units (maximum of four units), always ensure that they are stable and that they cannot fall causing injuries or damage. **DO NOT** stack a mix of LTB-2 units and other type of LTB Series units.
- ▶ For your safety and to avoid damaging the units, regardless of the model of your units, always ensure that the bumpers (or feet) are affixed to your units before stacking them.



CAUTION

You should remove all your modules from the unit before installing the bumpers (or the feet). Otherwise, they could be damaged or their calibration could be affected when you turn the unit upside down.

Note: *If you need to stack more than four units or to mix LTB-2 units with other types of units, simply mount the units in a rack or a shelf. For more information, see *Installing Your Unit in a Rack* on page 31.*

Getting Started with Your Unit

Using Your Unit as a Benchtop Unit

To install the rubber feet on your LTB-2 unit:

1. Position the unit so that its top panel rests on a flat surface such as a table.
2. Attach the four feet with the provided screws.

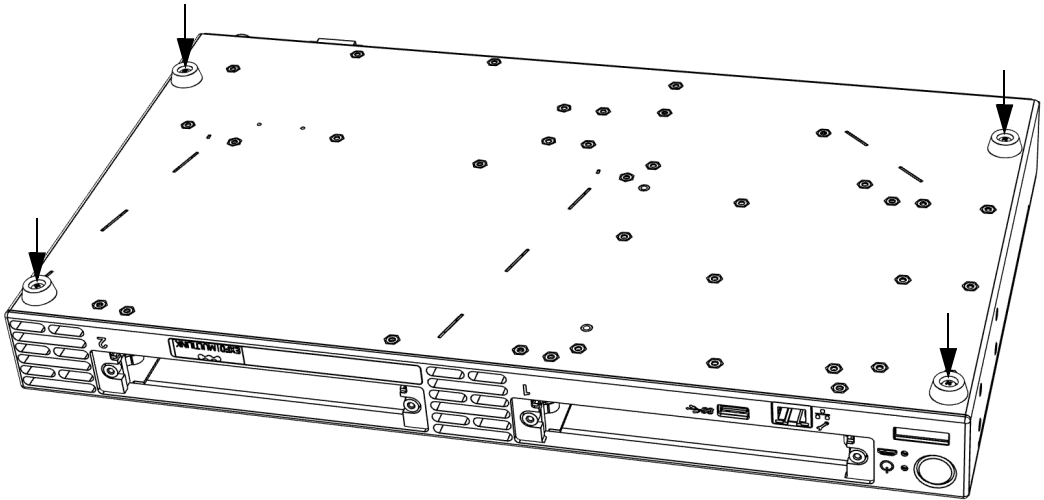

Getting Started with Your Unit

Using Your Unit as a Benchtop Unit

To install the bumpers on your LTB-8 or LTB-12 unit:

1. Ensure that four of the bumpers have foam pieces attached to them. These are the bumpers that will go on the bottom panel of the unit. If necessary, stick the provided foam pieces to the four thicker bumpers (peel the protector sheet at the back of the foam pieces).
2. Attach the eight bumpers to the unit using the provided screws (the four bumpers with foam pieces go on the bottom panel).

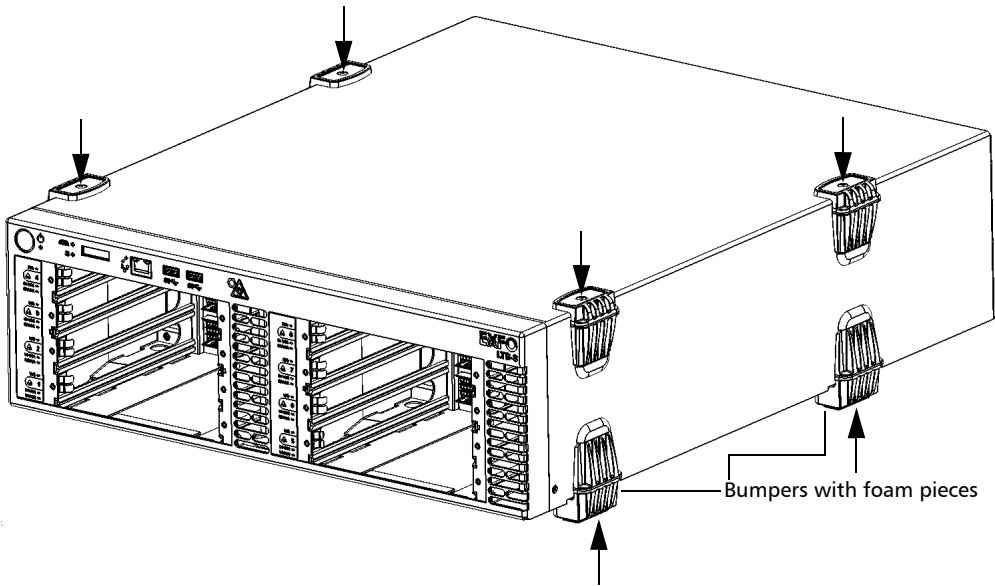

Installing Your Unit in a Rack

The table below gives you the installation requirements for your specific model of LTB Series.

Unit	Supported rack widths	Minimum vertical clearance in the rack to insert the unit	Minimum clearance for unit's front and rear exhausts	Minimum clearance for unit's left intake
LTB-2	19 inches; with the provided mounting brackets ^a	The height of the unit is one rack unit (1U) high or 44,45 mm (1.75 in.).	<ul style="list-style-type: none"> ➤ 75 mm (3 in.) of front clearance ➤ 75 mm (3 in.) of back clearance 	N/A
LTB-8	<ul style="list-style-type: none"> ➤ 19 inches; with the provided mounting brackets^a ➤ 23 inches; with the optional rack shelf 	The height of the unit is three rack units (3U) high or 133,35 mm (5.25 in.).	<ul style="list-style-type: none"> ➤ 75 mm (3 in.) of front clearance ➤ 75 mm (3 in.) of back clearance 	N/A

Getting Started with Your Unit

Installing Your Unit in a Rack

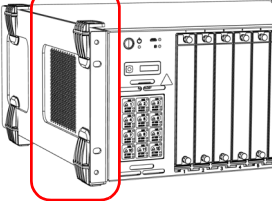
Unit	Supported rack widths	Minimum vertical clearance in the rack to insert the unit	Minimum clearance for unit's front and rear exhausts	Minimum clearance for unit's left intake
LTB-12	<ul style="list-style-type: none"> ➤ 19 inches; with the optional mounting brackets^a ➤ 23 inches; with the optional rack shelf 	The height of the unit is four rack units (4U) high or 177.8 mm (7 in.).	<ul style="list-style-type: none"> ➤ 75 mm (3 in.) of front clearance ➤ 75 mm (3 in.) of back clearance 	<p>15 mm (9/16 in.) of left clearance. The openings in the unit's case are located on its left panel (when you are facing the unit).</p>  <p>To ensure sufficient cooling, there should be openings at the front, the left, or the bottom of the rack allowing the air to circulate outside the rack.</p> <p>Special care should be taken to ensure that the nearby cabling does not restrict the airflow.</p>

a. The installation in racks having other widths could be possible with the right adapters.



CAUTION

Failure to provide adequate cooling clearance may result in an excessive internal temperature, thus reducing the reliability of your unit.

Note: *There is no need to leave an empty slot between units when you stack them one on top of the other inside a rack.*

Note: *For information about the installation of the optional rack shelf for your LTB-8 or LTB-12 unit, refer to the notice that comes with the rack shelf.*



WARNING

- The equipment rack must be anchored to an unmovable support to prevent it from falling over when one or more units are extended in front of the rack on slides. You must also consider the weight of any other device installed in the rack. A crush hazard exists if the rack tilts forward, which could cause serious injury.
- Mounting of the unit in a rack or cabinet should be such that a hazardous condition is not achieved due to uneven mechanical loading. The fully-configured unit is heavy. Use caution when manipulating the unit. A lifting mechanism may be required for installation.



IMPORTANT

To let the front USB and management ports free for potential maintenance, EXFO recommends to keep all non-optical connections to the back of the unit.

Getting Started with Your Unit

Installing Your Unit in a Rack

To install your LTB-2 unit in a rack:

1. Ensure that your unit is turned off.



CAUTION

You should remove all your modules from the unit before installing it into a rack. Otherwise, they could be damaged or their calibration could be affected.

2. Ensure that no USB or electrical cables are connected to the unit.
3. Position the unit so that its bottom panel rests on a flat surface such as a table.
4. Align the holes of the first bracket with the holes of the unit's casing at the position that best suits your installation needs. You can even invert position of the mounting bracket if necessary.

Brackets in standard position

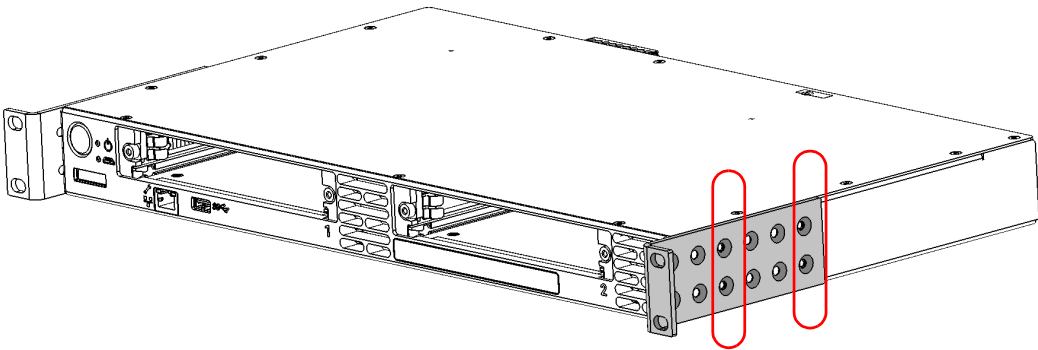

Brackets in inverted position

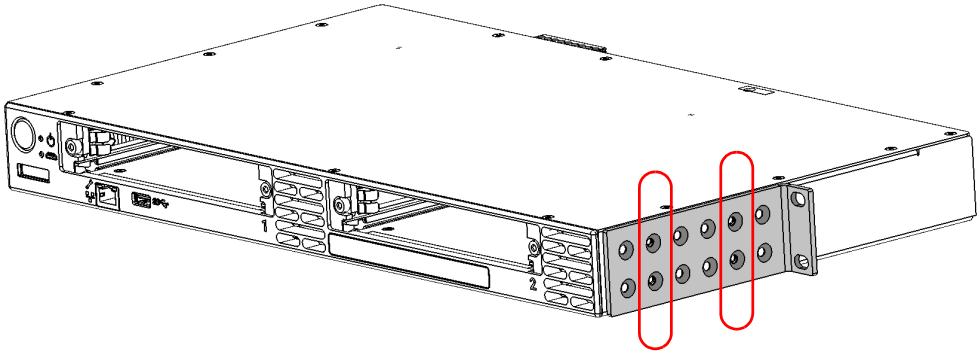

5. Fix the first bracket on the unit with the supplied screws (four screws per bracket).
6. Repeat steps 4 and 5 with the other bracket, ensuring that you place the bracket at the exact same position (orientation of the bracket, set of holes on the bracket and on the unit's casing).
7. Place the unit in the rack at the desired height.
8. Fix the unit in place using the hardware supplied with the rack. Use two screws per side.

To ground your unit properly, you must ensure that there is a metal-to-metal contact between the rack and the mounting hardware. For this reason, EXFO recommends to use thread-forming screws, star (tooth) lock washers, or similar hardware that remove any paint or non-conductive coatings. For more information, see *Grounding Your Unit* on page 39.

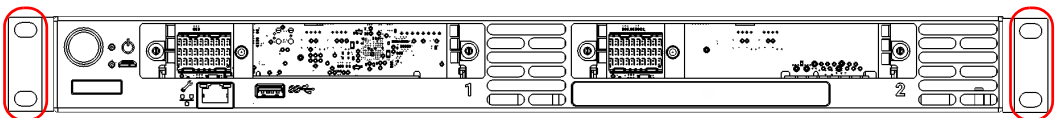

Getting Started with Your Unit

Installing Your Unit in a Rack

To install your LTB-8/LTB-12 unit in a rack:

1. Ensure that your unit is turned off.
2. Remove the bumpers of your unit by unscrewing the top and bottom screws.



CAUTION

You should remove all your modules before installing your unit into a rack. Otherwise, they could be damaged or their calibration could be affected.

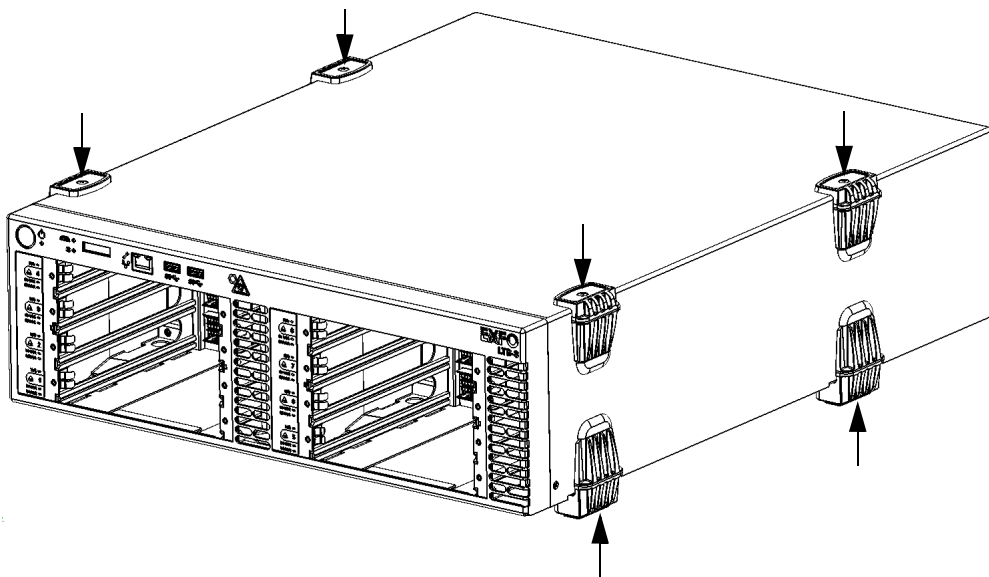

Getting Started with Your Unit

Installing Your Unit in a Rack

- 3. Position the first mounting panel against one of the side of the unit so that its protruding edge does not cover the air intake, and that you see the screw holes on the side panel. Ensure that the mounting panel is flush with the front panel of the unit.

Front

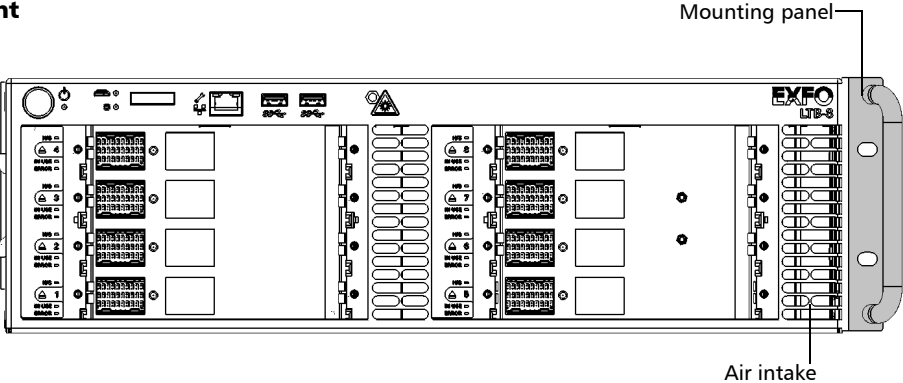

Left panel

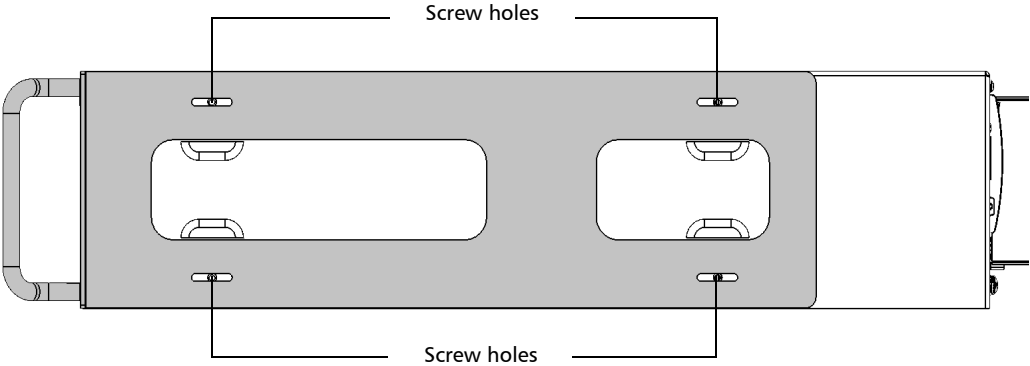

Getting Started with Your Unit

Installing Your Unit in a Rack

- Secure the mounting panel with four screws that came with the mounting panel kit.



CAUTION

The screws used for the bumpers will not work to secure the mounting panels. You must use the screws supplied with the mounting kit.

- Repeat steps 3 and 4 with the other mounting panel.
- Place the unit in the rack at the desired height.
- Fix the unit in place using the hardware supplied with the rack (two screws per side).

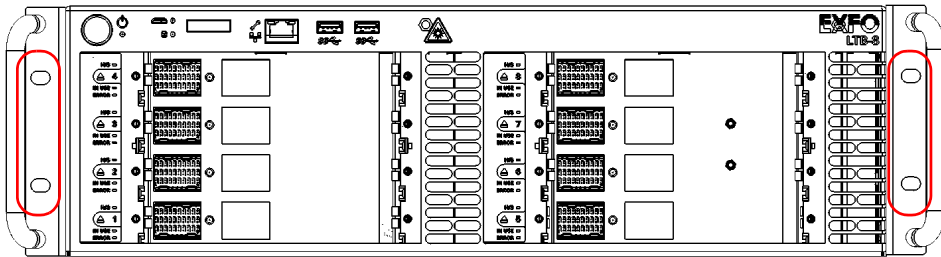

Grounding Your Unit

This section presents information that applies to all models of the LTB Series as well as information specific to each of the models.



WARNING

All wiring and installation must be in accordance with local building and electrical codes acceptable to the authorities in the countries where the equipment is installed and used.

If you are not sure on how to proceed, consult a certified electrician.



WARNING

Never connect a hazardous live voltage to the frame (chassis) terminal.

- For the LTB-2: To avoid the potential for an electrical shock hazard, you must reliably connect an earth grounding conductor to the unit.
- For the LTB-8/LTB-12: Your unit uses an international safety standard three-wire power cable. This cable serves as a ground when connected to an appropriate AC power outlet. Depending on your setup, you may also want to ground your unit with the grounding lug that serves as a frame (chassis) terminal.

Getting Started with Your Unit

Grounding Your Unit

To ground your unit:

1. Remove the two Phillips screws (one screw on some LTB-8 units, depending on hardware version) and the grounding lug from the back panel of your unit.

LTB-2

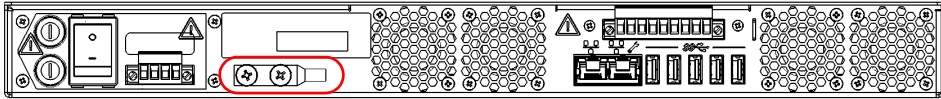

LTB-8

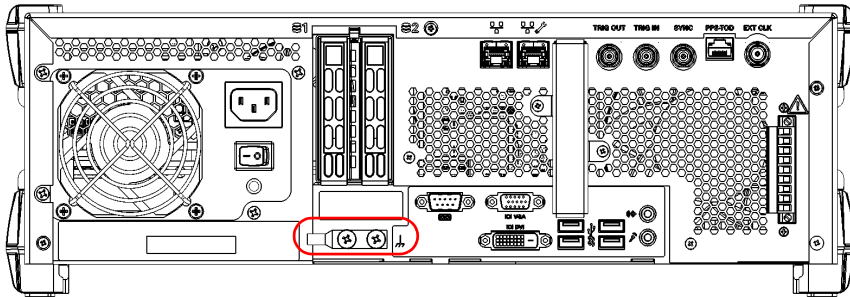

LTB-12

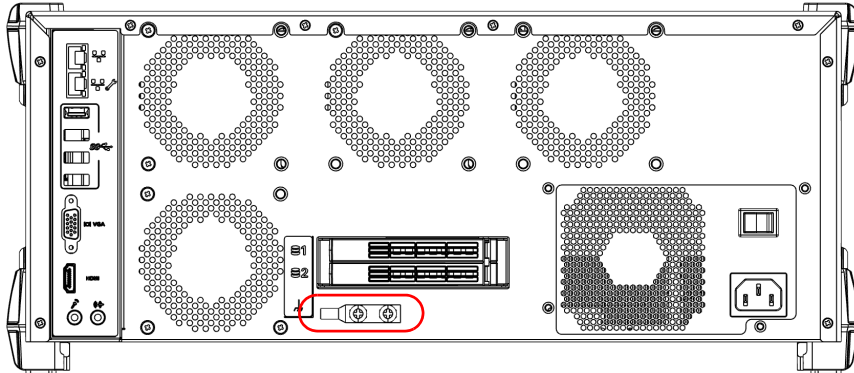

2. Prepare the ground wire (for LTB-2: #6 AWG, green; for LTB-8/LTB-12: minimum 12 AWG, green), and attach one of its ends to the unit's grounding lug using a crimping tool.
3. Use the two Phillips screws (one screw on some LTB-8 units, depending on hardware version) to attach the grounding lug and wire assembly to the back panel of your unit.
4. Ground the other end of the wire as per your local regulation.

Your unit is now grounded properly.

Getting Started with Your Unit

Connecting a Monitoring Device to the Dry Contact Relays (LTB-2 and LTB-8 Only)

Connecting a Monitoring Device to the Dry Contact Relays (LTB-2 and LTB-8 Only)

Your unit is equipped with dry contact relays that enable you to connect your own monitoring device if you wish to do so.

There are three dry contact relays (max. \approx 60 V; 0.46 A) on the back panel of the unit:

- Power relay: Activated when all components related to the unit are powered on (the power LED is green and does not blink).
- System relay: Activated when all the system components are working normally (the system LED is green).
- Application relay: Configurable by an application for a specific task.

Note: *The application relay is reserved for future use.*



CAUTION

For optimum performance and safety, you must either crimp a terminal (ferrule) onto the stranded conductors, or tin them before installing them in the terminal block.

Getting Started with Your Unit

Connecting a Monitoring Device to the Dry Contact Relays (LTB-2 and LTB-8 Only)

To connect a monitoring device to the dry contact relays of your unit:

1. Unscrew the two screws holding the terminal block for dry contact relays in place.

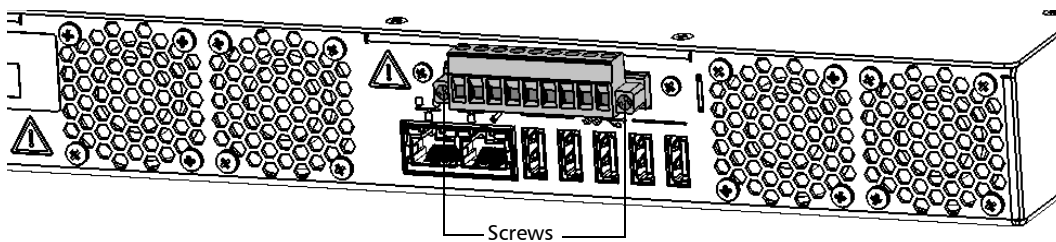

2. When the terminal block is loose, gently pull it toward you to remove it, exposing the pins.

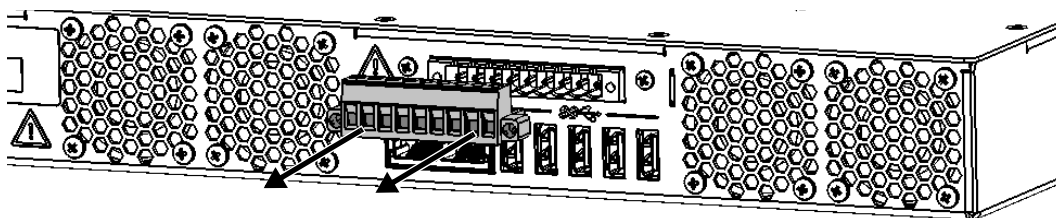

3. Crimp each wire with a terminal (ferrule) or tin each of them.
4. Unscrew the screws (shown in grey) located at the top of the terminal block.

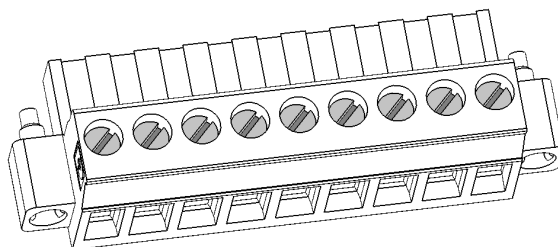

Getting Started with Your Unit

Connecting a Monitoring Device to the Dry Contact Relays (LTB-2 and LTB-8 Only)

5. Connect the wires using the diagram below as a guide.

LTB-2

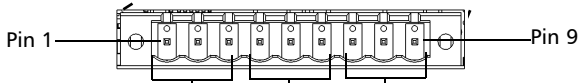
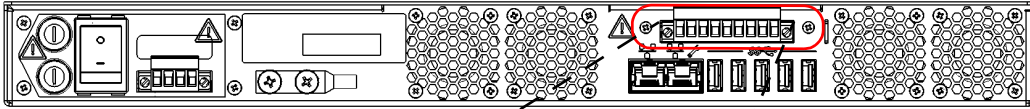

Power relay

- Pin 1 - NO = Normally open
- Pin 2 - C = Common
- Pin 3 - NC = Normally closed

Application relay

- Pin 7 - NO = Normally open
- Pin 8 - C = Common
- Pin 9 - NC = Normally closed

System relay

- Pin 4 - NO = Normally open
- Pin 5 - C = Common
- Pin 6 - NC = Normally closed

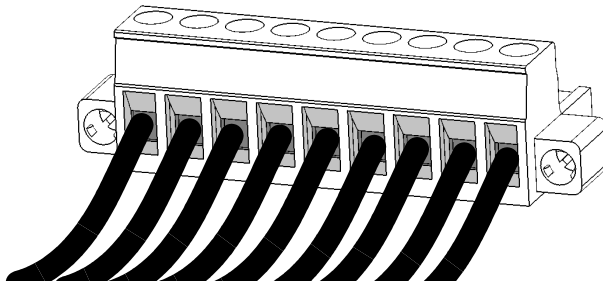

Getting Started with Your Unit

Connecting a Monitoring Device to the Dry Contact Relays (LTB-2 and LTB-8 Only)

LTB-8

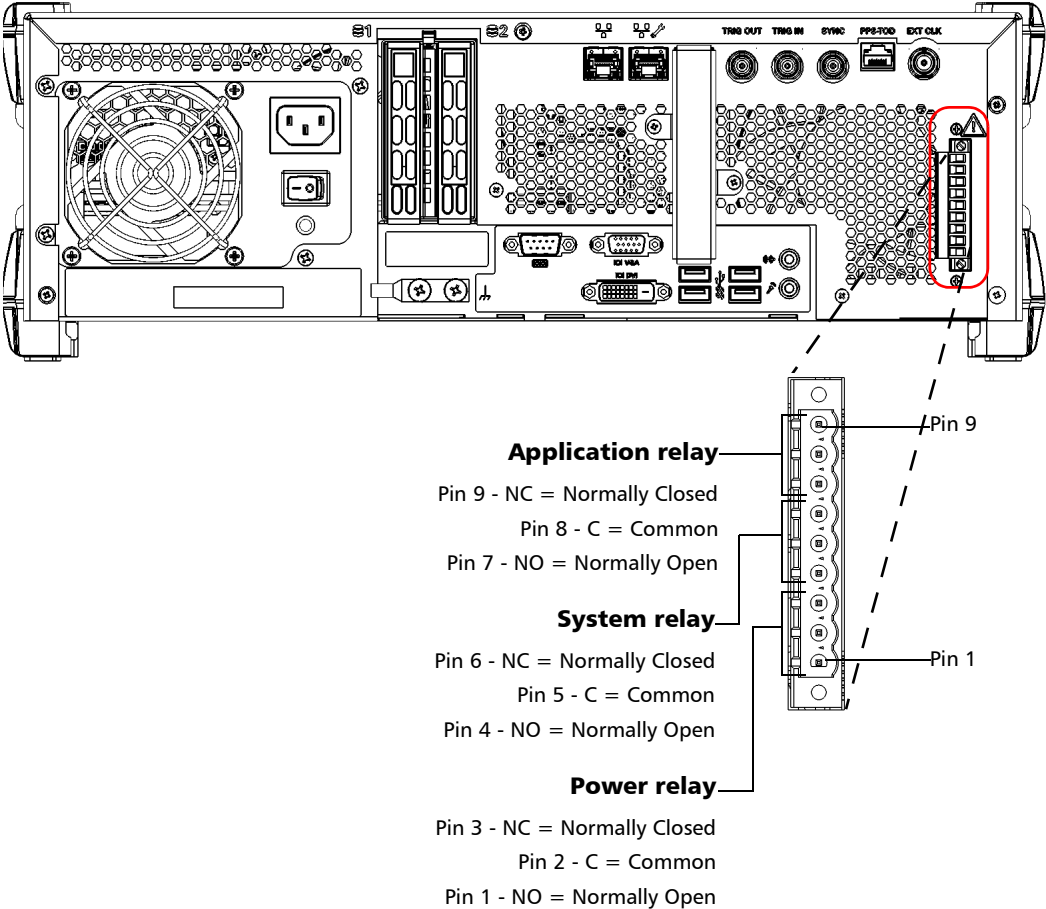

6. Tighten the screws located at the top of the terminal block to secure the wires in place.

Getting Started with Your Unit

Connecting a Monitoring Device to the Dry Contact Relays (LTB-2 and LTB-8 Only)

7. Ensure that the terminal block is aligned properly with the bay containing the pins.

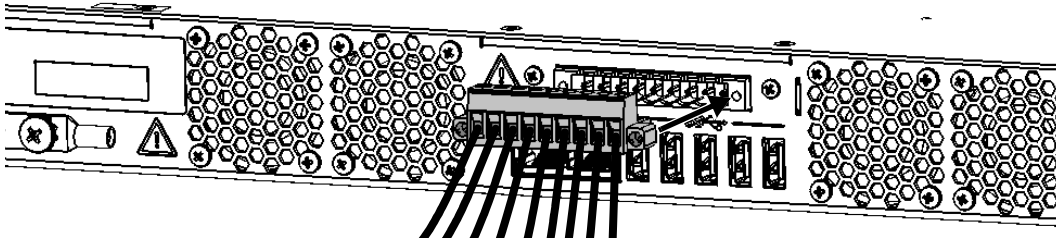

8. Slide the terminal block all the way into the bay until it stops.
9. Screw the two screws to secure the terminal block in place.

The dry contact relays are now installed properly.

Locating the Synchronization Ports (LTB-8 Only)

The synchronization and trigger ports are not currently supported by your unit. They are reserved for future use only.

Back

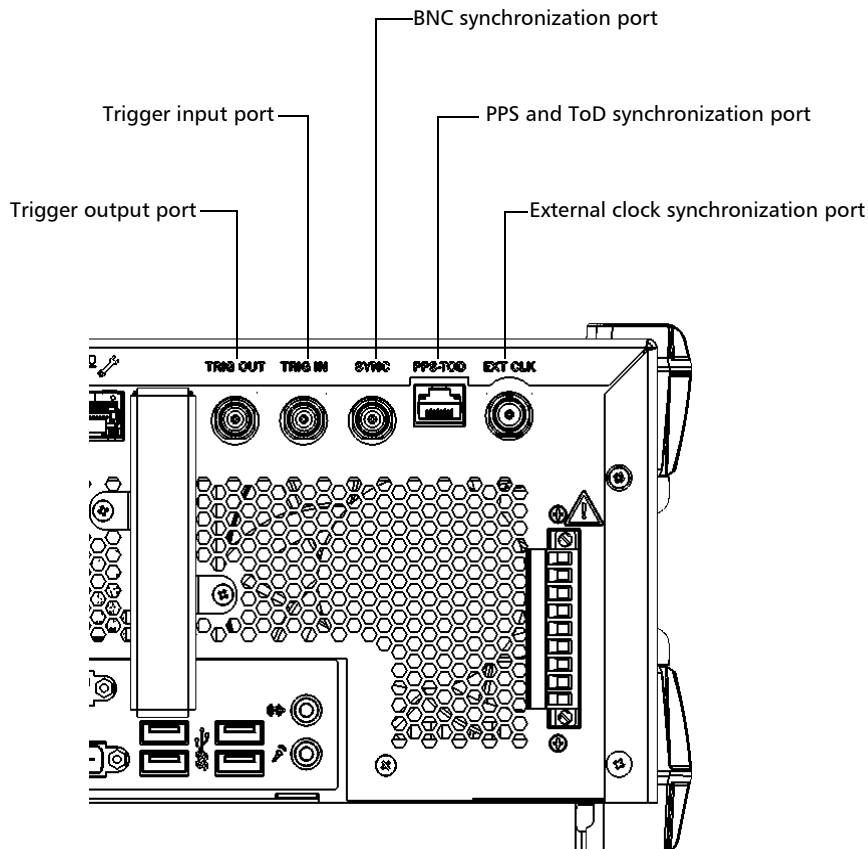

Inserting and Removing Test Modules



CAUTION

- There is no need to turn off your unit before inserting or removing test modules. However, removing modules without following the instructions provided in this user documentation could have unfortunate consequences. Doing so could result in unexpected behavior of the test applications, instability of the system, or even cause irreparable damage to your modules, depending on the operation underway when the modules are removed.
- To avoid damaging your unit, use it only with modules approved by EXFO.

To insert a module into the unit:

1. If you work with an LTB-2 or an LTB-8 unit: Take the module and place it horizontally so that the connector pins are at the back, and the protruding edges are facing downwards.

LTB-8 shown

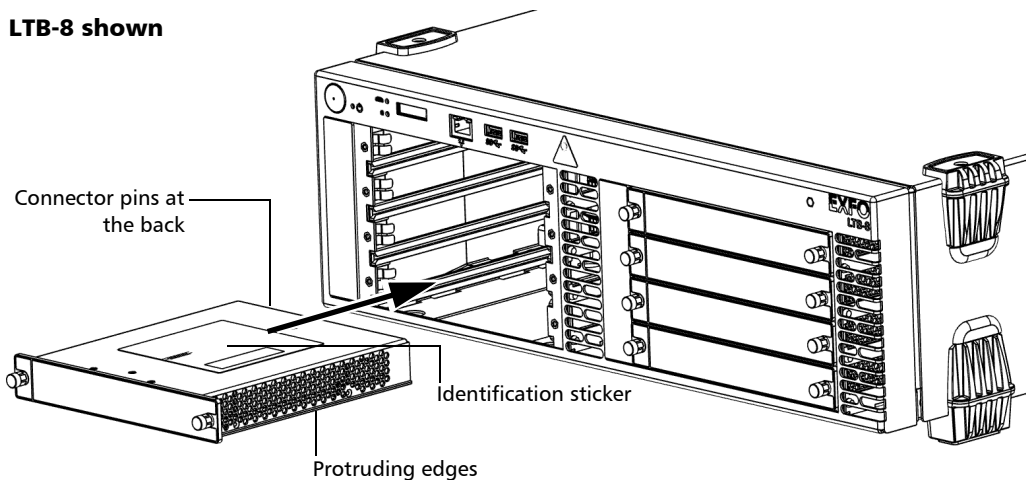

Getting Started with Your Unit

Inserting and Removing Test Modules

If you work with an LTB-12 unit: Take the module and place it vertically so that the connector pins are at the back. The identification sticker must be on the right side and the protruding edges on the left side.

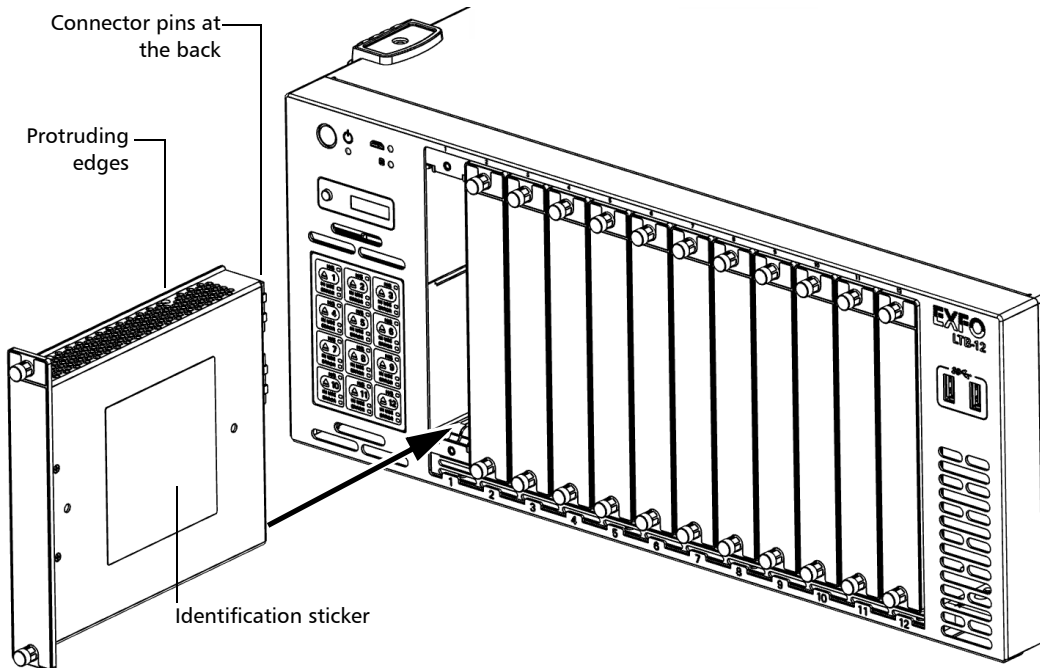

- 2.** Insert the protruding edges of the module into the grooves of the receptacle's module slot.
- 3.** Push the module all the way to the back of the slot, until it stops.

Getting Started with Your Unit

Inserting and Removing Test Modules

4. Turn the two retaining screws clockwise until they are tightened to secure the module into its “seated” position. The faceplate of the module should be flush with the front panel of the unit.

LTB-8 shown

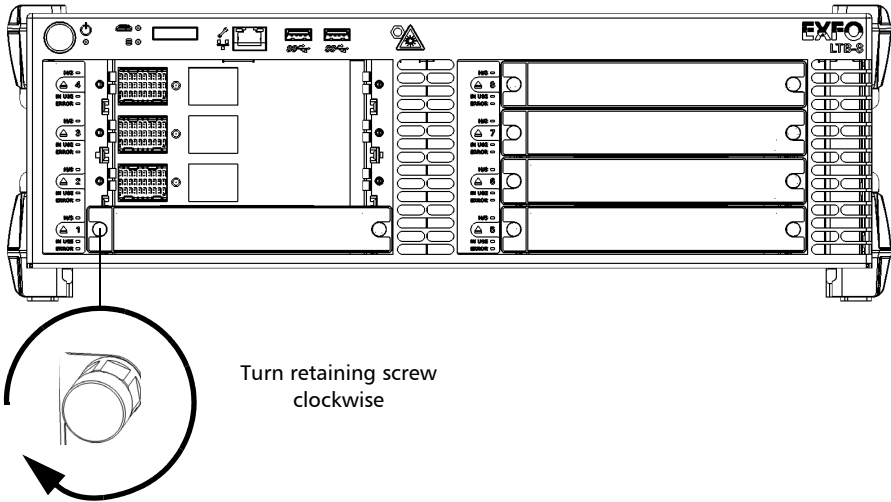

The module is detected automatically after the insertion (no need to restart the unit).

To remove a module from the unit:

1. From ToolBox X, click the  button.
OR

If you are working with an LTB-8 or an LTB-12 unit, on its front panel, press the  button corresponding to the module that you wish to remove.



CAUTION

Wait until the status of the module switches to “Safe to Remove” in ToolBox X. If you are working with an LTB-8 or an LTB-12 unit, you can also wait until the H/S LED turns steady blue on its front panel.

2. Turn the two retaining screws counterclockwise until they are loose (do not remove them completely).

LTB-8 shown

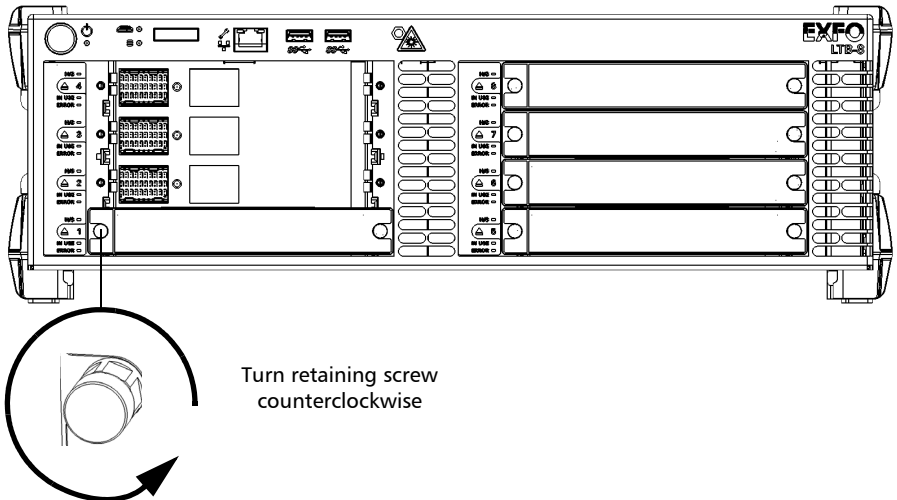

Getting Started with Your Unit

Inserting and Removing Test Modules

3. Hold the module by its sides or by the retaining screws (*NOT by the optical connectors*) and pull it out.

Note: *The retaining screws can be used as handles to pull out the module safely.*

LTB-8 shown

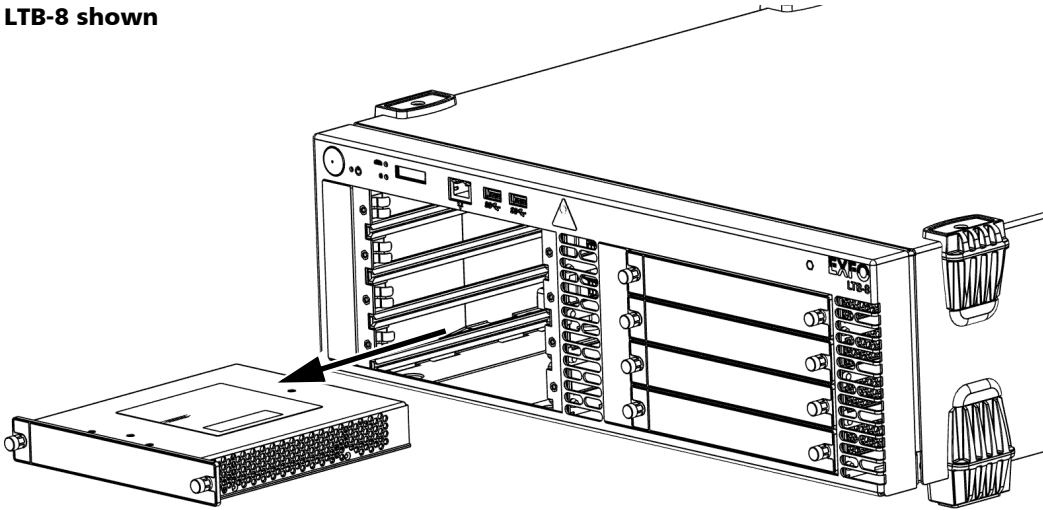

CAUTION

Pulling out a module by its optical connectors could seriously damage both the module and connectors. Always pull out a module by its casing or the retaining screws.

4. Cover empty slots with the supplied protective covers.



CAUTION

Failure to reinstall protective covers over empty slots will result in ventilation problems.

Connecting Your LTB-2 Unit to a Power Source

Before starting to work with your LTB-2 unit, you must connect it to a power source (AC or DC). There is a specific procedure for each of these types of power sources.



WARNING

- A certified over-current protecting device that is suitably rated must be installed at the source.
- All electrical installation and accessories must be done and selected as per local electrical code and regulation.
- To avoid fire hazards and ensure your safety, when you intend to connect your unit to DC power, always select a wire gauge according to the unit's ratings, cable length, and local electrical code.



CAUTION

- For optimum performance and safety, you must either crimp a terminal (ferrule) onto the stranded conductors, or tin them before installing them in the terminal block.
- To avoid damaging your unit, always ensure that the unit's main power switch (located on the back panel) is in the off position before connecting the unit to DC or AC power.

Getting Started with Your Unit

Connecting Your LTB-2 Unit to a Power Source

To connect your unit to DC power:

1. Ensure that the unit's main power switch is in the off position.

Back panel

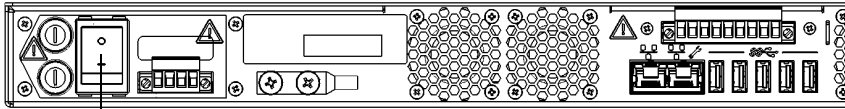

Main power switch in off position

2. Ensure all power is off or disconnected at the source.

Note: A certified over-current protection of 10 A must be installed at the power secondary distribution.

3. Ensure that the unit is grounded properly. For more information, see *Grounding Your Unit* on page 39.
4. Unscrew the two screws holding the terminal block in place.

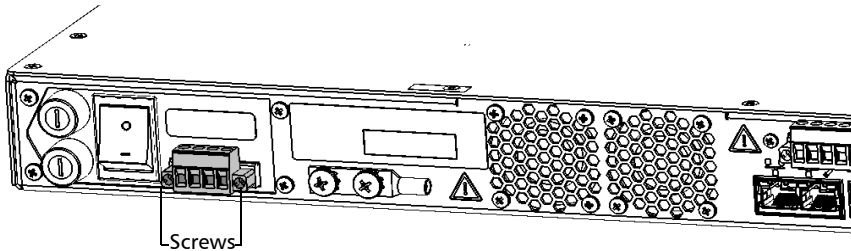

Screws

Getting Started with Your Unit

Connecting Your LTB-2 Unit to a Power Source

5. When the terminal block is loose, gently pull it toward you to remove it, exposing the electrical connectors.

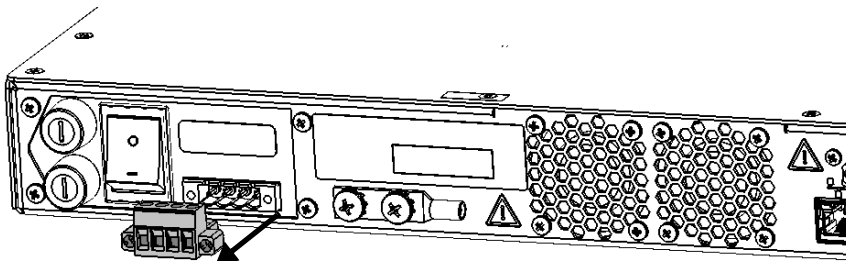

6. Crimp each power lead (maximum 14 AWG) with a terminal (ferrule) or tin each of them. Unscrew the four screws (shown in grey) located at the top of the terminal block.

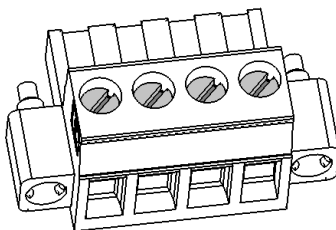

Getting Started with Your Unit

Connecting Your LTB-2 Unit to a Power Source

7. Pair the power leads with the appropriate power terminal for each of the feed, respecting the polarity as indicated just above the terminal block.

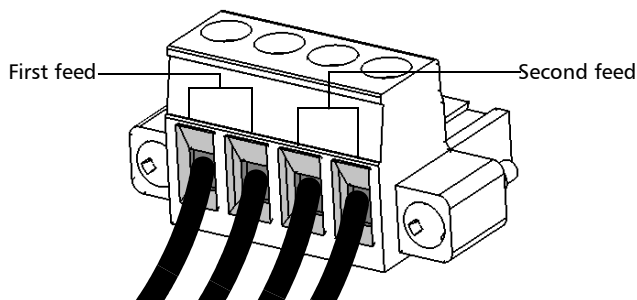
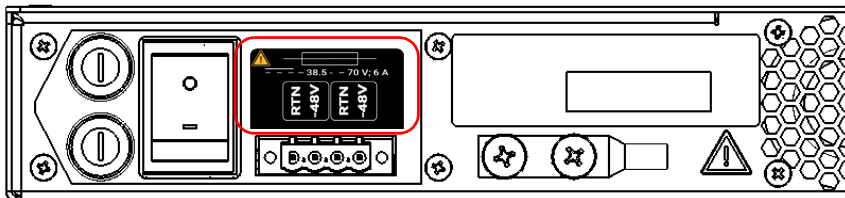

8. Tighten the four screws located at the top of the terminal block to secure the wires in place.

Getting Started with Your Unit

Connecting Your LTB-2 Unit to a Power Source

9. Ensure that the terminal block is aligned properly with the bay containing the electrical connectors.

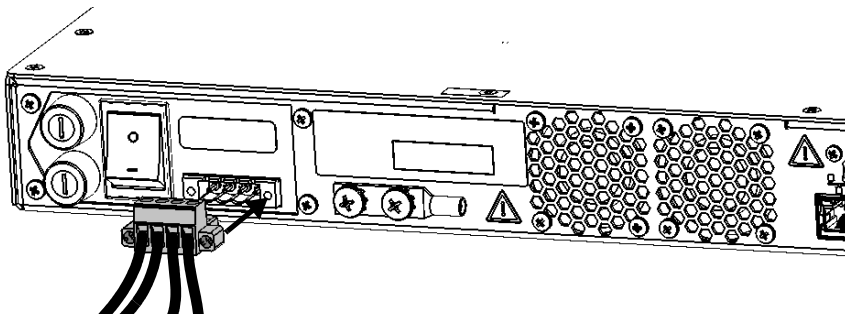

10. Slide the terminal block all the way into the bay until it stops.
11. Screw the two screws to secure the terminal block in place.
12. Turn on the disconnect device that is connected to the unit.
13. Flip the unit's main power switch to the on position.

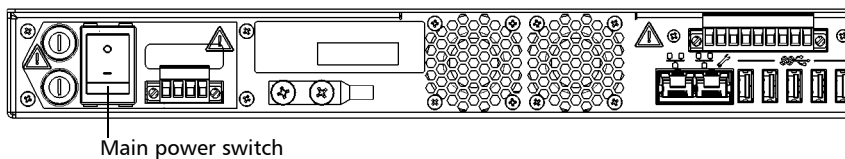

You are now ready to turn on the unit (see *Turning on Your Unit* on page 61).

Getting Started with Your Unit

Connecting Your LTB-2 Unit to a Power Source

To connect your unit to AC power:

1. Ensure that the unit's main power switch is in the off position.

Back panel

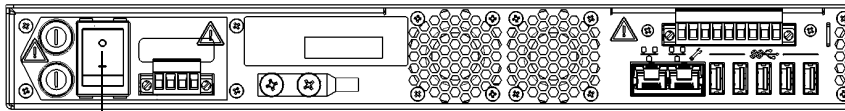

Main power switch in off position

2. Ensure all power is off or disconnected at the source.
3. Ensure that the unit is grounded properly. For more information, see *Grounding Your Unit* on page 39.
4. Position your unit so that you can access its back panel.

If a terminal block is installed on the back of your unit (shown in grey below), you will need to remove it before being able to connect the AC/DC power adapter.

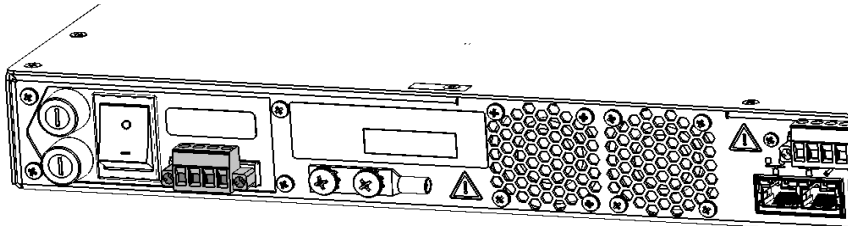

Getting Started with Your Unit

Connecting Your LTB-2 Unit to a Power Source

5. If necessary, remove the block terminal as follows:

5a. Unscrew the two screws holding the terminal block in place.

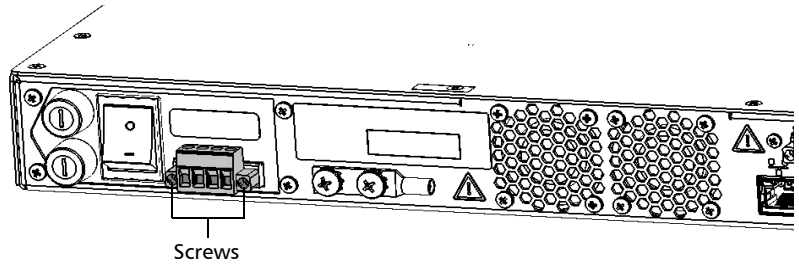

5b. When the terminal block is loose, gently pull it toward you to remove it, exposing the electrical connectors.

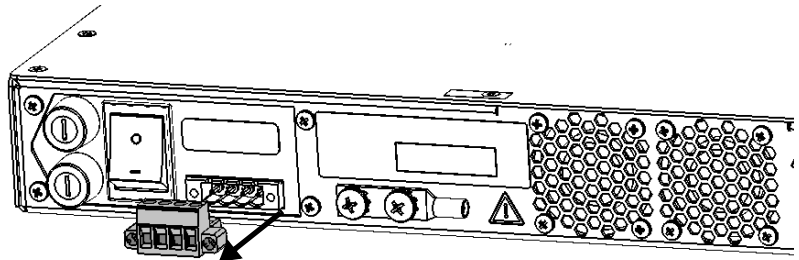

Getting Started with Your Unit

Connecting Your LTB-2 Unit to a Power Source

6. Ensure that the connector of the AC/DC power adapter is aligned properly with the bay containing the electrical connectors.

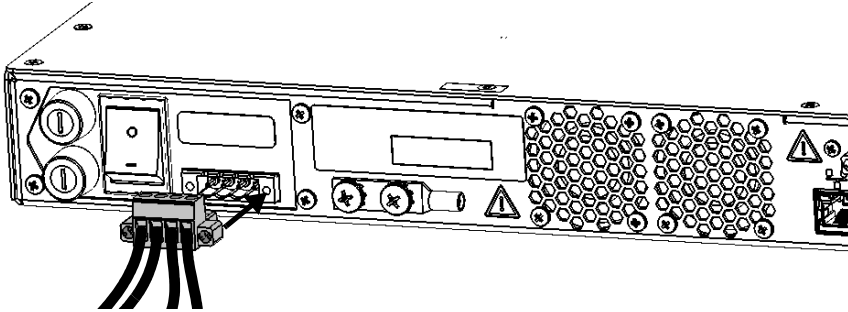

7. Slide the connector of the AC/DC power adapter all the way into the bay until it stops.
8. Screw the two screws to secure the connector of the AC/DC power adapter in place.
9. Ensure that the removable power cord is connected to the other end of the AC/DC power adapter, and then connect the adapter to the power outlet.
10. If necessary, turn on the disconnect device.
11. Flip the unit's main power switch to the on position.

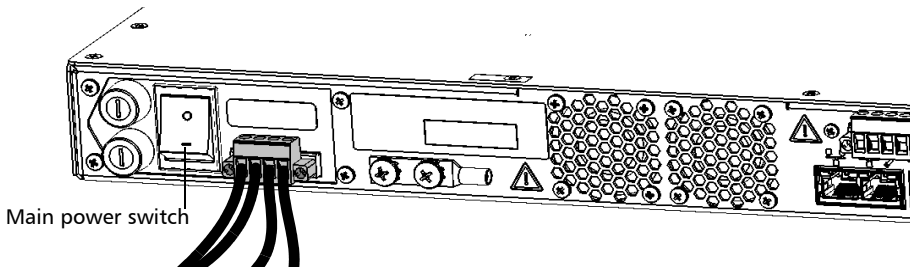

You are now ready to turn on the unit (see *Turning on Your Unit* on page 61).

Turning on Your Unit

When you turn on the unit for the very first time, a wizard for license agreements and safety instructions is displayed (see the corresponding section for more information).

Once you have accepted all the license agreements and confirmed the reading of safety instructions, the main window is displayed.

To turn on the unit:

1. LTB-2: If it is not already done, connect your unit to an AC or a DC power source (see the corresponding section for safety information and detailed instructions). LTB-8 and LTB-12: If it is not already done, connect your unit to the AC power using the provided cord.
2. If it is not already done, ensure that the main power switch, located at the back of your unit is set to the on position (on the LTB-8, the LED just below the switch should be lit).

LTB-2

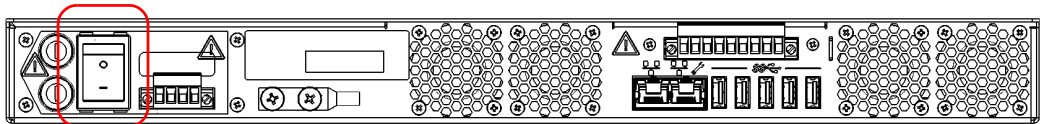

LTB-8

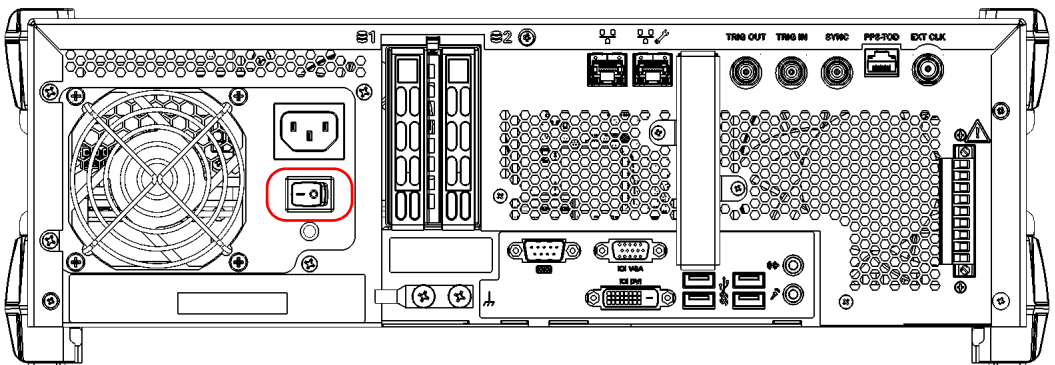

Getting Started with Your Unit

Turning on Your Unit

LTB-12

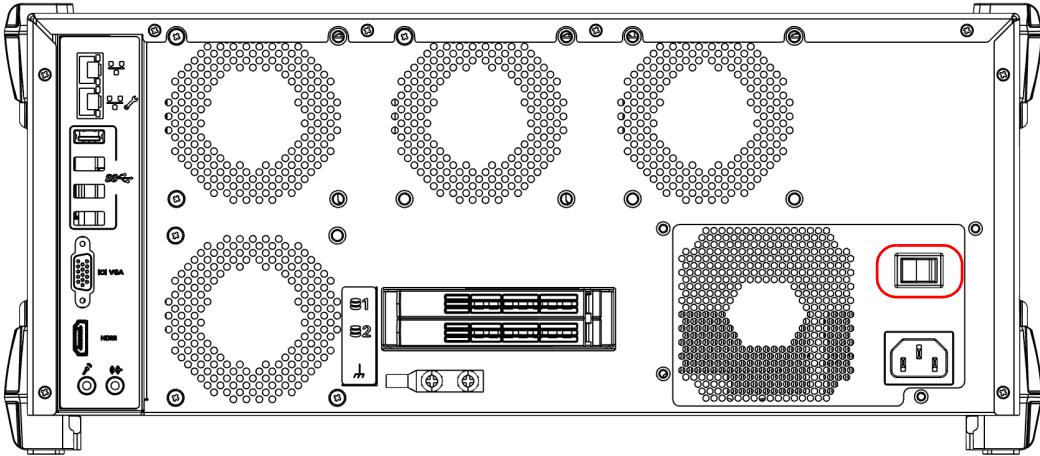

3. Press the on/off button. For more information about working with your unit for the very first time, see the corresponding section in this documentation.

LTB-2

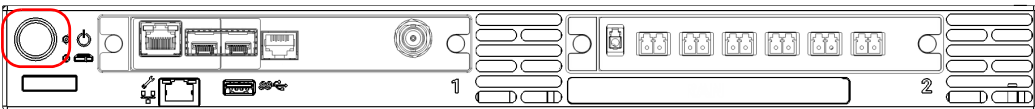

LTB-8

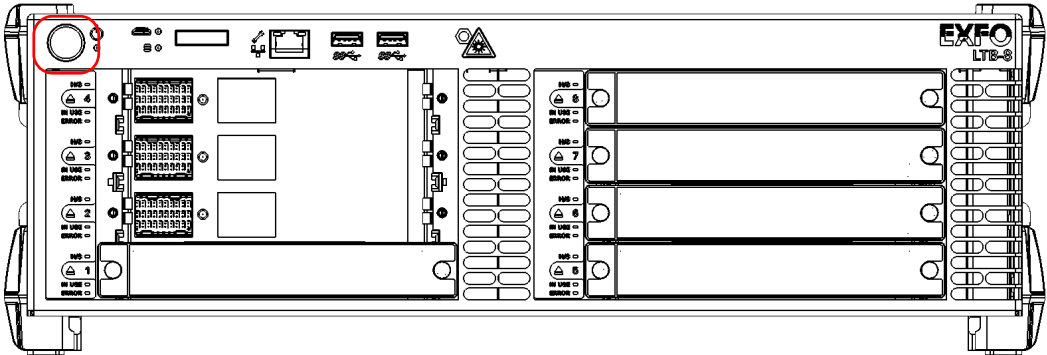

LTB-12

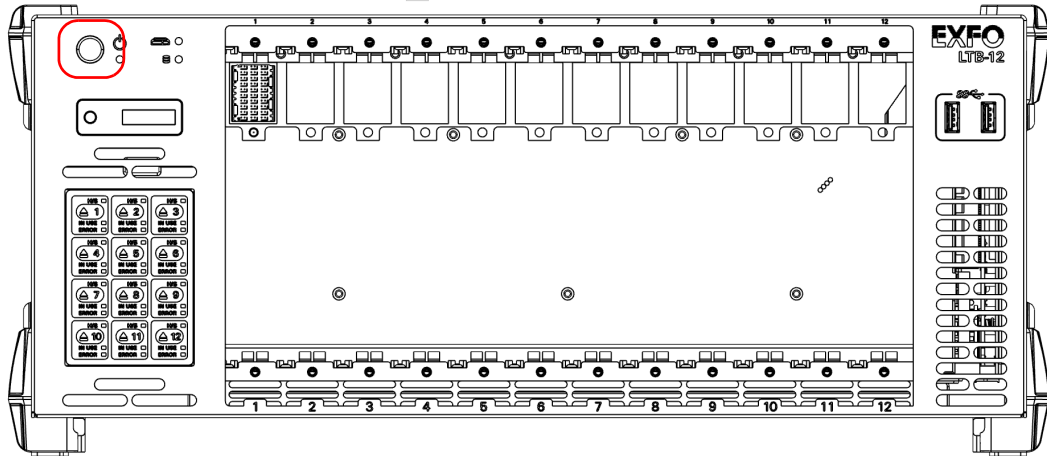

Note: Once you have performed the very first startup of the unit, you will also be able to turn on and turn off the unit by using the Intel Active Management Technology – AMT (see the section explaining how to work with Intel AMT).

Turning off Your Unit

Your unit will shut down when you press the power button. It will perform a complete restart routine the next time you use it, and start in Toolbox X or in the application you defined as the startup application.

Note: *Should the unit ever stop responding, first try to turn it off normally. If this does not work, flip the main power switch (located at the back of the unit) to the off position, and then flip it back to the on position.*





CAUTION

To avoid damaging your unit when you need to disconnect it from its external power source, first turn the unit off. Then, ensure that its main power switch (located on the back panel) is in the off position before proceeding with the disconnection.



To turn off the unit completely from the unit itself:

Press the on/off button.

To turn off the unit completely from Windows 10:

1. From the lower left corner of the screen, click the **Start** button (.
2. From the **Start** menu, click .
3. Click **Shut down**.

To turn off the unit completely from Windows 8.1 Pro (some LTB-8 units only):

1. From the lower left corner of the screen, click the **Start** button (.
2. On the upper right corner of the screen, click .
3. Click **Shut down**.

Note: *Once you have performed the very first startup of the unit, you will also be able to turn on and turn off the unit by using the Intel AMT (see the section explaining how to work with Intel AMT).*

Configuring Your Unit At First Startup

When you turn on the unit for the first time, a Windows configuration wizard may be displayed, enabling you to set all the regional and language settings such as the country and operation language.



IMPORTANT

If you have a language choice at the first startup, the operation language that you select at that time (labelled "App language") becomes the default system language, that is the language that will be available at logon.

During the Windows configuration process, you will also be asked to read and accept the Microsoft end-user license agreement (EULA).

Note: *If no Windows configuration wizard is displayed, it means that the settings have been pre-configured before the shipment of your unit. In this case, you can always modify the various settings later to better suit your needs, if necessary (see [Selecting the Language of Operation on page 87](#) and [Adjusting the Date, Time and Time Zone on page 98](#)).*

In all cases, an EXFO wizard will be displayed, allowing you to read the user documentation for important safety information, and to read and accept the EULA related to your unit and instruments.

Note: *To be able to work with the unit, you must accept all the EULA (from Microsoft (when displayed) and EXFO), and confirm that you have read the security information.*

To configure your unit at first startup:

1. If it is not already done, turn on the unit (see *Turning off Your Unit* on page 64).
2. Connect to your unit using the AMT Remote Access application.

Note: *With an LTB-8 or an LTB-12, if you intend to use your unit in local mode only as a benchtop unit, you can also access your unit directly without using the AMT Remote Access application. You will then need to connect a monitor, a keyboard, and a mouse to your unit.*

- 2a.** Install the AMT Remote Access application on a computer (laptop). For more information, see *Installing the AMT Remote Access Application on a Computer* on page 120.
- 2b.** Connect one end of a network cable to the management port of your unit and the other end to an Ethernet port on the computer.

LTB-2

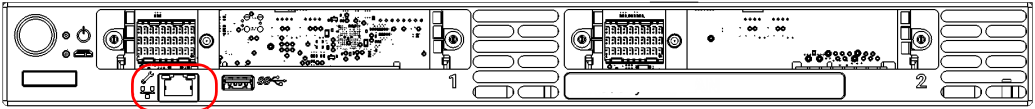

- 2c.** From your computer, start the AMT Remote Access application.
- 2d.** Enter the connection information.

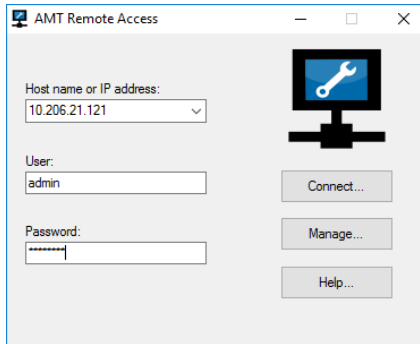

- The default static IP address is: 192.168.200.1
- The default user name is: admin
- The default password is: !Exfo123

For security reasons, EXFO recommends that you change the default password for a password of your choice after the first connection.

Note: You may have to modify the IP address of the computer to make sure that the computer and unit can “see” each other. The IP address of the computer must be within the same range of addresses as the IP address of the unit (ex.: 192.168.200.20).

For more information, see *Connecting to Your Unit Remotely With AMT Remote Access* on page 121.

- 2e.** Click **Connect** to access Windows and ToolBox X.
- 3.** If the Windows wizard is displayed, set the parameters according to your needs.
- 4.** If the Microsoft EULA is displayed, read and accept it.
The configuration of Windows parameters may take several minutes.

Getting Started with Your Unit

Configuring Your Unit At First Startup

5. When the EXFO wizard is displayed, follow the on-screen instructions.

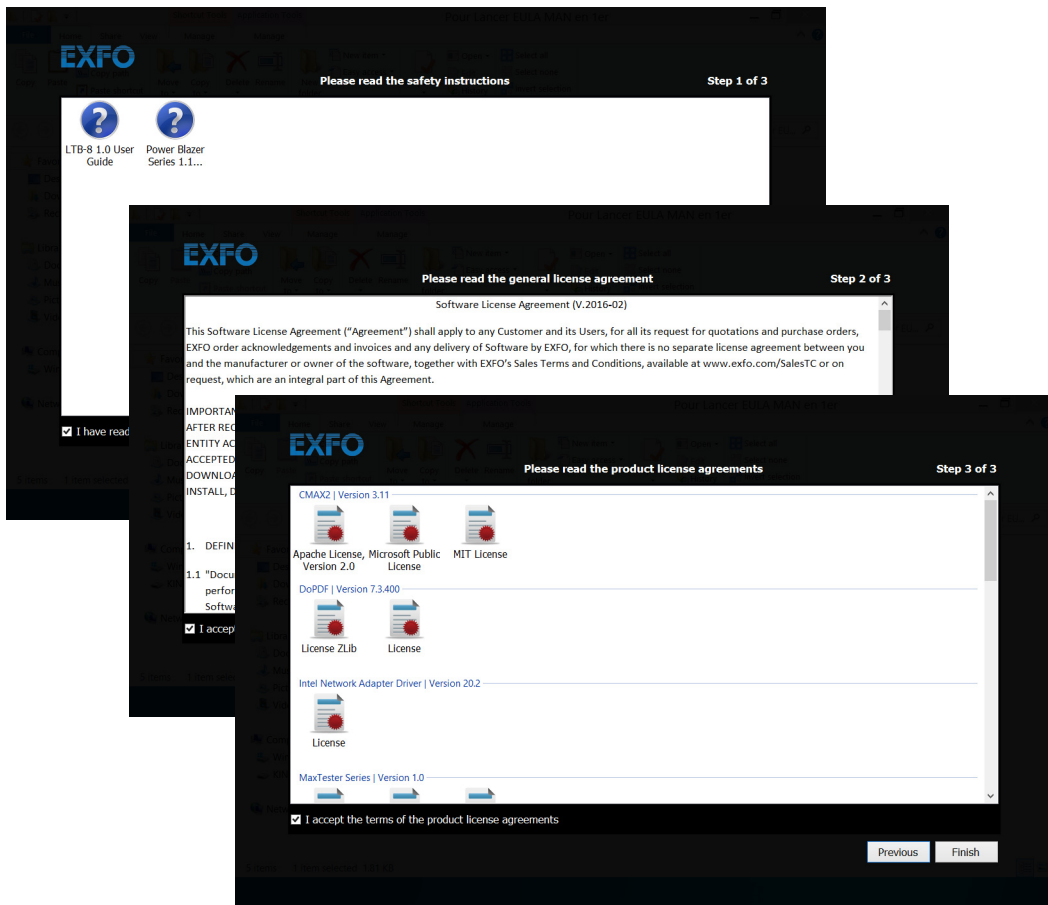

6. Click **Finish** to close the wizard and start working.

Accessing and Exiting Toolbox X

By default, Toolbox X is displayed automatically when you turn on the unit.

However, you can configure your unit to send Toolbox X to the notification area (see *Setting Toolbox X Behavior* on page 101). This could be useful, for example, if you prefer to start working in Windows. You can also configure your unit to start any of the available applications as soon as Toolbox X is started (see *Selecting the Startup Applications* on page 85).

To access Toolbox X from the Windows environment:

Double-click the  icon on your desktop.

ToolBox X

Note: *If ToolBox X has been sent to the notification area, from this location, right-click the  icon, and then select **Restore ToolBox X**.*

To exit Toolbox X:

Click .

Getting Started with Your Unit

Starting Module Applications

Starting Module Applications

Your modules can be configured and controlled from their dedicated applications in Toolbox X.

To start a module application:

1. If necessary, click the **Modules** button to display the modules window.

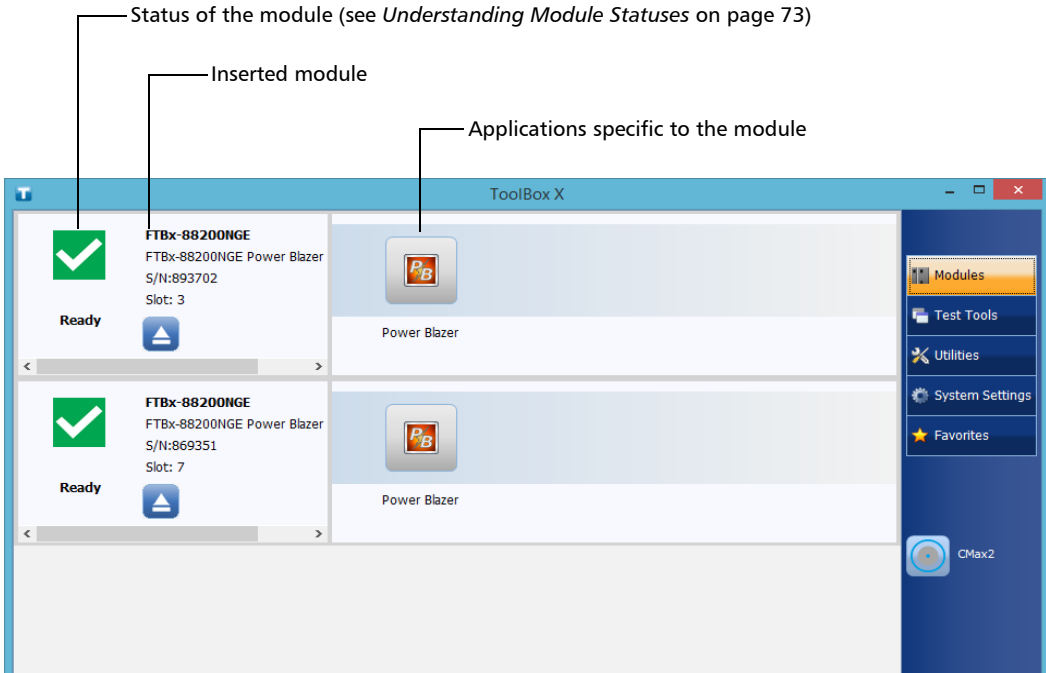

Note: The slots are identified by numbers (first slot identified by 1), both on the unit and in Toolbox X.



2. On the row corresponding to the desired module, click the icon of the application with which you want to work.

Understanding Module Statuses

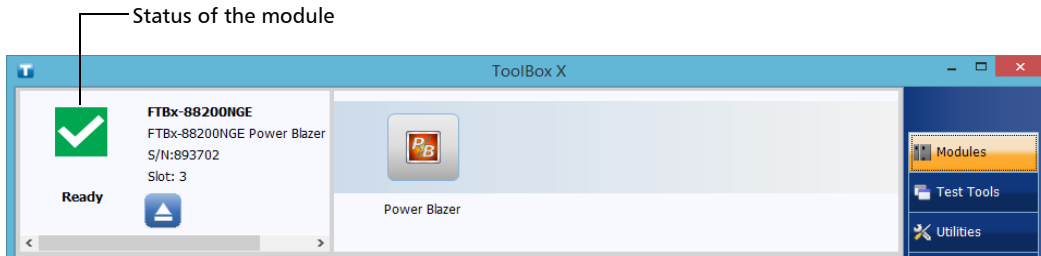
In addition to the module error and status LEDs (see *LED Indicators Description* on page 10), the different statuses of the modules are visible from Toolbox X.





The table below lists the possible statuses.

Status	Meaning
 Ready	The module is available for tests.
 In use	The module is currently in use. The module switches to this status in the following cases: <ul style="list-style-type: none"> ➤ At startup of the corresponding module application. ➤ When remote control is activated on this module from the <i>Remote Control Configuration</i> tool. ➤ When the module is controlled from external applications such as EXFO Remote Toolbox. <p>Note: When a test or a measurement using the module is underway, its IN USE LED is blinking green.</p>

Getting Started with Your Unit

Understanding Module Statuses

Status	Meaning
 Ejecting	<p>The module is being prepared for safe removal from the unit.</p> <p>Once the corresponding eject button is pressed (on the unit or in Toolbox X), the applications that were using the module start preparing it for safe removal.</p> <p>When the module is ready for removal, its status switches to “Safe to remove”.</p>
 Safe to remove	<p>The module can now be safely removed from the unit.</p> <p>The applications have finished preparing the module for removal.</p> <p>If you wish to continue working with a module having this status, you can either:</p> <ul style="list-style-type: none">➤ Remove it from the unit, and then reinsert it. <p style="text-align: center;">OR</p> <ul style="list-style-type: none">➤ Press the eject button again (on the unit or in Toolbox X) to reconnect it.
 Error	<p>The module cannot be used at this time because it had to protect itself from a critical problem.</p> <p>Press the eject button (on the unit or in Toolbox X).</p> <p>The applications will prepare the module for removal and the module’s status will change to “Safe to remove”. You will then have the choice to either remove this module from the unit or reconnect it.</p>

Installing or Upgrading EXFO Applications

All the necessary applications have been preinstalled and configured at the factory. However, you may have to upgrade some applications when new versions become available.

Each time you purchase a new module, it could be a good idea to verify that the most recent version of its dedicated application is installed on your unit.

EXFO Software Update allows you to check for updates, download these updates and install them on your unit. It replaces the former Update Manager application. If EXFO Software Update is not already available on your unit (shortcut not present on the Windows desktop), you can download it from the EXFO Web site and install it on your unit.

In addition to managing the updates of module and instrument applications, EXFO Software Update also manages its own updates when new versions become available (no need to download subsequent versions of this application yourself from EXFO Apps).

Note: *Your unit must have access to an Internet connection to be able to use EXFO Software Update.*

Note: *If you want to update Microsoft applications or Windows features, see the section about Managing Windows Updates in this user documentation.*

Getting Started with Your Unit

Installing or Upgrading EXFO Applications

To install EXFO Software Update:

1. If it is not already done, turn on your unit.
2. Retrieve the EXFO Software Update installation file from EXFO Apps at <http://www.exfo.com/software/exfo-apps> (in the page corresponding to your unit).

Note: *If you do not intend to download the installation file directly to your unit, you can download it to your computer, and then transfer it to your unit.*

3. Double-click the file you have just downloaded to start the installation.
4. Follow the on-screen instructions.

To install or upgrade applications:

1. Ensure that your unit has access to the Internet.
2. If it is not already done, turn on your unit.
3. Exit Toolbox X and the modules' applications.
4. On your unit, from Windows desktop, double-click the **EXFO Software Update** icon to start the corresponding application.
5. From the EXFO Software Update tool, click the button to start the process.
6. Follow the on-screen instructions.

Activating Software Options

The software options purchased at the same time as your unit have been activated for you already. However, if you purchase options afterwards, you will have to activate them yourself.

Before being able to activate options, you need to contact EXFO with the following information:

- Purchase order number of the newly purchased options
- Module or platform serial number (depending on whether the software options were purchased for a module or the platform)
- Customer's name
- Customer's company name
- Customer's phone number
- Customer's e-mail address
- Module or platform on which the option will be installed

You will receive a single key (.key) file with which you will be able to unlock all the new options that you have purchased.

Getting Started with Your Unit

Activating Software Options

To activate software options for your unit or module:

1. If you prefer to activate the options while being connected locally to your unit, prepare a USB key as follows:
 - 1a. Connect a USB memory key to one of the USB ports of your computer.
 - 1b. Copy the key file to the USB memory key.
 - 1c. Disconnect the USB key from the computer and connect it to your unit.
2. From the main window, click the **System Settings** button, and then click **Options Activation**.

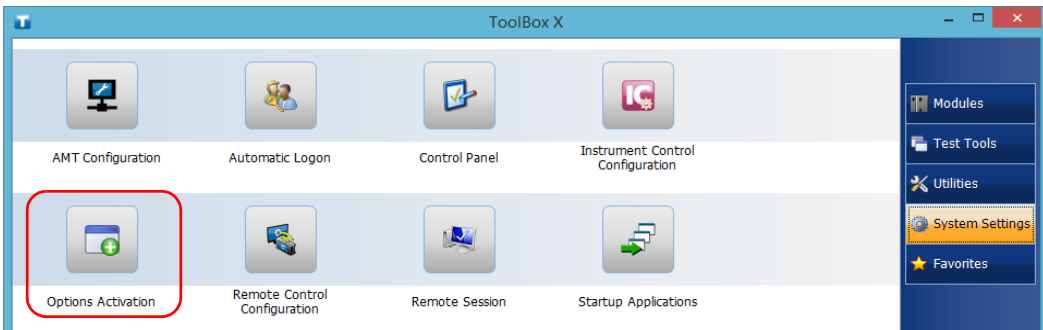

3. Click the **Platform Options** tab or the **Module Options** tab, depending on the type of options that you want to activate.

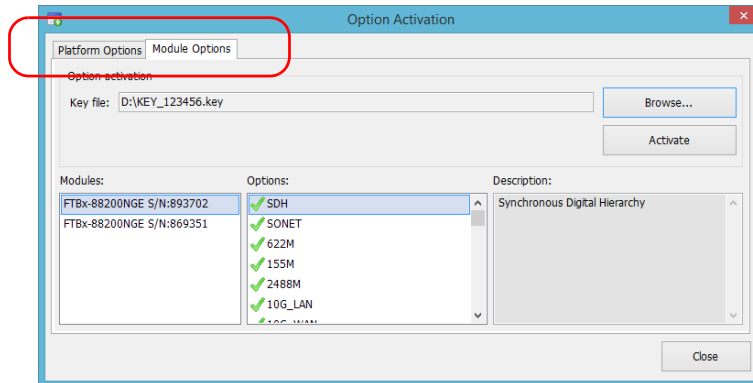

4. Use the **Browse** button to locate the key file that you want to use.
5. Click **Activate**.

The option indicator will turn into a green check mark to confirm that the option is now active.

Note: You can see the supported options in the **Options** list.

6. Click **OK** to close the confirmation message, and then **Close** to exit.

Note: At this point, if you have used a USB key to copy your key file, you can remove it as it is not required to use your new options.

Installing Third-Party Software on Your Unit

Since your unit is equipped as a conventional computer would be, you can install third-party software on it.



IMPORTANT

- ▶ If your unit runs Microsoft Windows 10 IoT Enterprise: You can install any third-party software, as long as it is used as a complementary tool to help you perform tests and measurements with your unit, or provides system utilities, resource management, or anti-virus or similar protection.
- ▶ If your unit runs Microsoft Windows 8.1 Pro (some LTB-8 units only): You can install any third-party software, as long as it is compatible with this operating system.

In all cases, EXFO does not provide any support for the installation, use or troubleshooting of third-party software. Should you need help, refer to the corresponding third-party software documentation or technical support.

Protecting your Unit with an Antivirus Software

By default, your unit is protected with the Windows Defender antivirus software. However, you can apply your own security standards and antivirus strategy.

4 **Setting Up Your Unit**

Enabling or Disabling the Automatic Logon

Note: *Only administrator-level users can enable or disable the automatic logon feature.*

You can configure your unit to automatically log on to Windows at startup (no need to select a user and enter a password). You can also disable this feature if you prefer to define separate user accounts with different user access rights and passwords.

Note: *For security reasons, when the unit comes back from sleep mode, the application will prompt you to select a user and enter a password, even if you have enabled the automatic logon feature.*

Also for security reasons, by default, the automatic logon is not enabled. Once it is enabled, if you want to modify the password of the user account for which the automatic logon is enabled, you will have to disable the feature first, and then enable it again once the new password is defined.

If you want to modify the account used for the automatic logon, you will also have to disable the feature first, and then enable it again for the new account.



IMPORTANT

The user name and password that you specify for the automatic logon must correspond to those of an existing user account. You can create user accounts or modify passwords from the Accounts window.

In Windows 10: Start button > Settings > Accounts.

In Windows 8.1 Pro (some LTB-8 units only): Charm bar > Settings > Change PC settings > Accounts.

Setting Up Your Unit

Enabling or Disabling the Automatic Logon

To enable the automatic logon:

1. From the main window, click the **System Settings** button.
2. Click **Automatic Logon**.

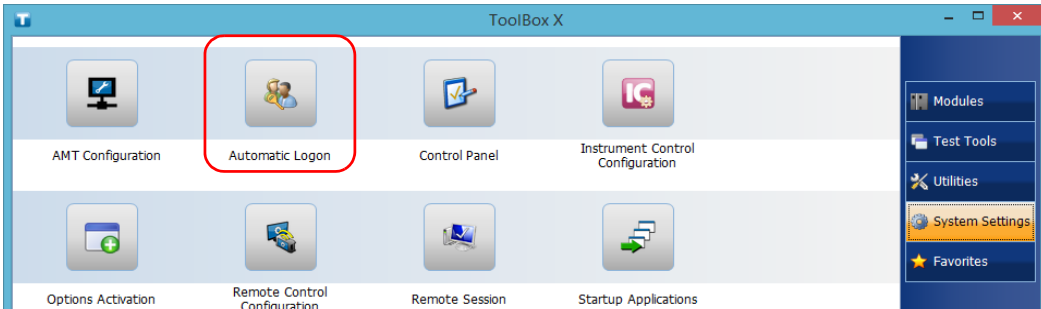

3. From the User Accounts window, clear the **Users must enter a user name and password to use this computer** check box.

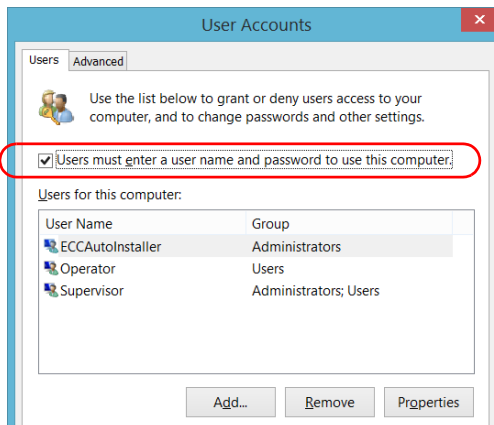

4. Click **OK** to confirm.

5. Enter the desired user name (account) and the corresponding password.

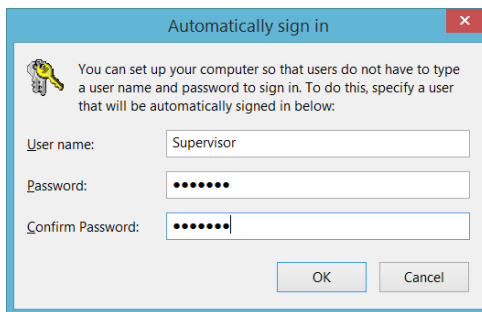

6. Click **OK** to confirm and to return the **System Settings** window.

At next startup, you will no longer need to specify a user name and password (except if the unit comes back from sleep mode).

To disable the automatic logon:

1. From the main window, click the **System Settings** button.
2. Click **Automatic Logon**.

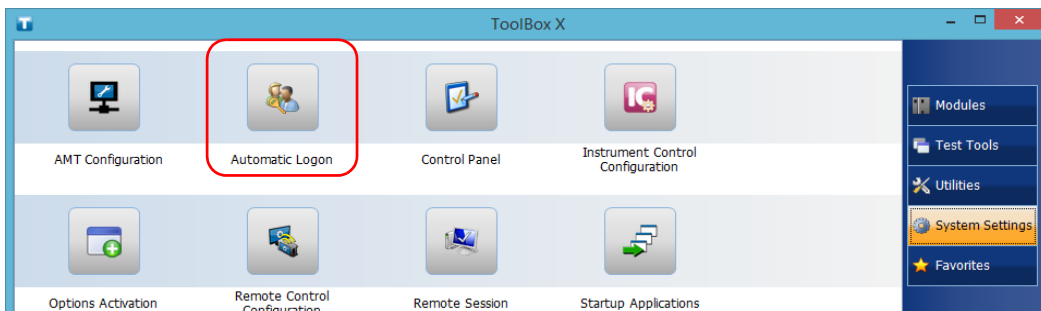

Setting Up Your Unit

Enabling or Disabling the Automatic Logon

3. From the User Accounts window, select the **Users must enter a user name and password to use this computer** check box.

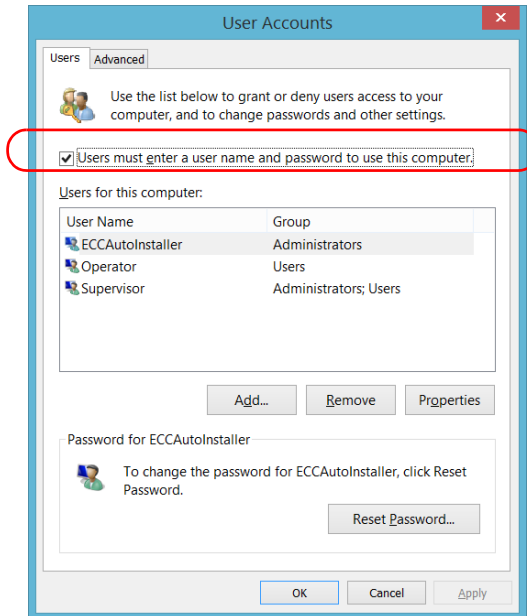

4. Click **OK** to confirm and to return the **System Settings** window.
At next startup, you will have to specify the user name and password.

Selecting the Startup Applications

The first time you start your unit, Toolbox X is displayed. You can configure your unit to automatically start any of the available applications as soon as ToolBox X is started. This can save you time, as you do not need to ensure that they are already running before starting your tests.

If the required module is not present in the unit, the specified applications will simply not be started. In some cases, you may have to select the applications again the next time the module is inserted into the unit.

To set applications to start automatically at ToolBox X startup:

- 1.** From the main window, click the **System Settings** button.
- 2.** Click **Startup Applications**.

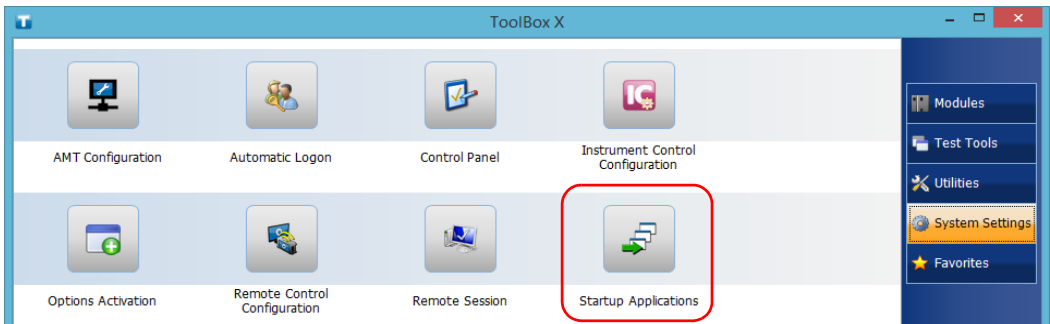

Setting Up Your Unit

Selecting the Startup Applications

- Under **Module Applications** or **Other Applications**, select the applications you want to start automatically by selecting the corresponding check boxes.

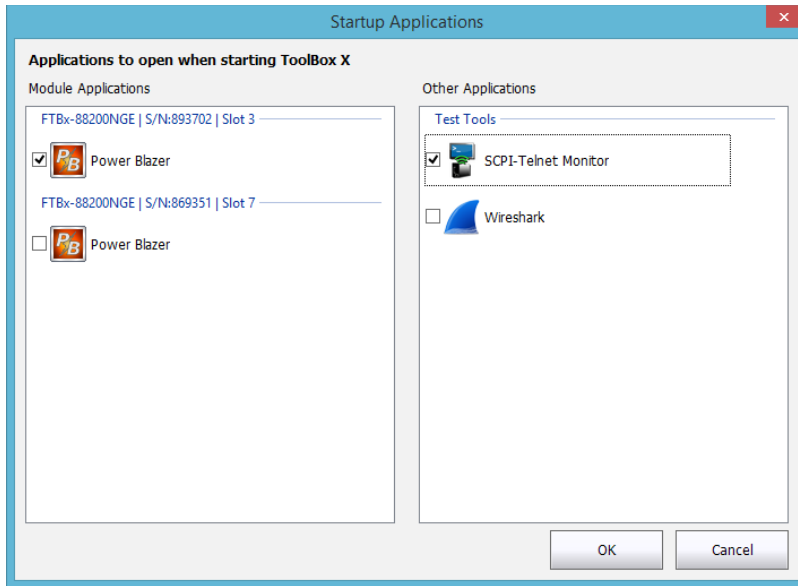

- Click **OK** to use the new settings. Click **Cancel** to exit without using the new settings.

Note: *The new settings will be taken into account the next time ToolBox X is started.*

Selecting the Language of Operation

You may display the user interface in one of the available languages.

The availability of the languages is function of the language group that was installed on your unit at time of purchase. It is possible to download language packs from the Microsoft Website to add extra languages if necessary.

The ToolBox X application is offered in several languages. This means that if ToolBox X supports the language currently selected in Windows, it will automatically be displayed in this language. If the selected language is not supported, the English version will be used.

When you change the interface language, the corresponding keyboard is automatically added to the list of available keyboards. You can then enter text in a specific language. Once the keyboards are added, you can switch easily from one input language to another.

Values are kept in memory even when you turn the unit off.

To select a new interface language:

1. From the main window, click the **System Settings** button.
2. Click **Control Panel**.

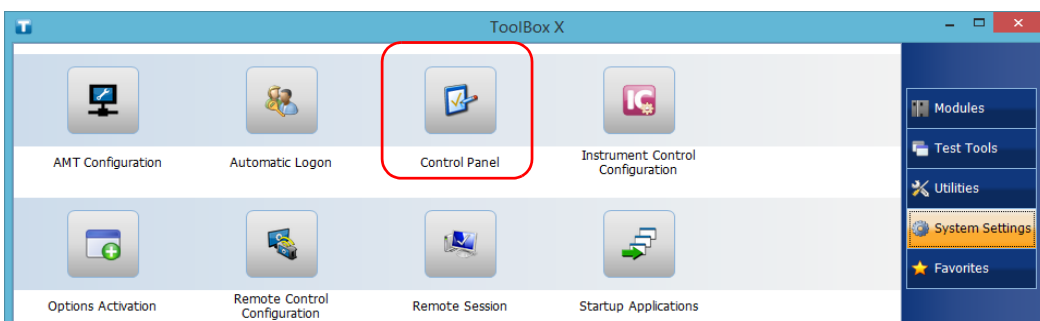

Setting Up Your Unit

Selecting the Language of Operation

3. Under **Clock, Language, and Region**, click **Add a language**.

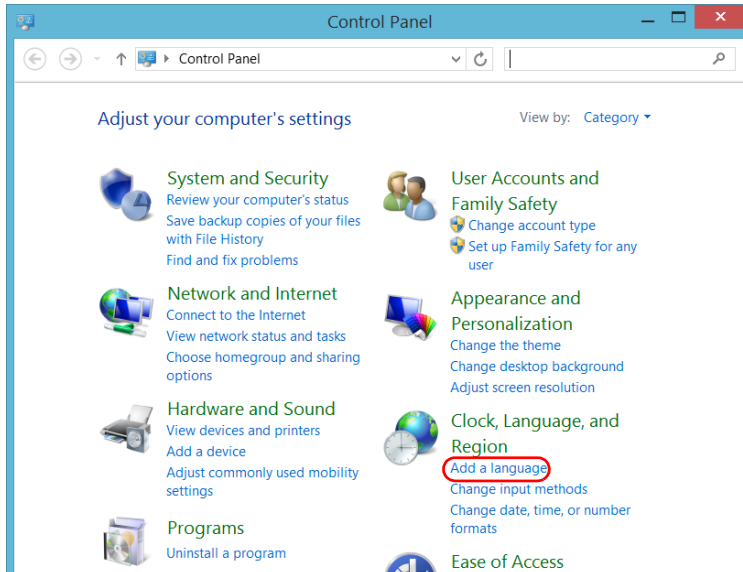

4. Select the desired language from the list.

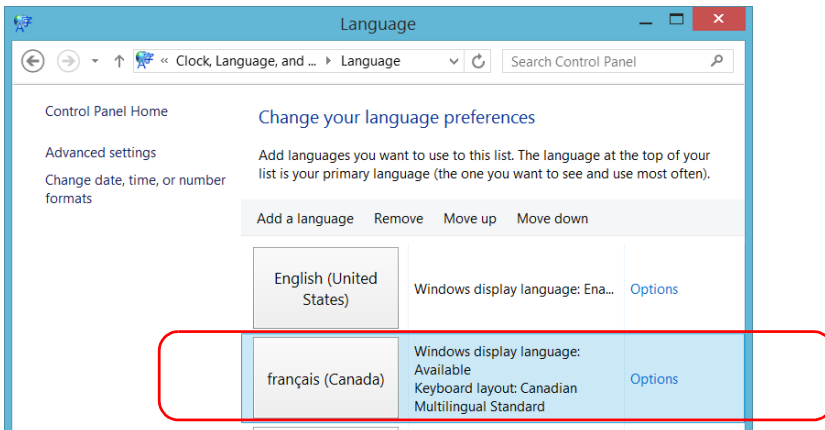

5. Click **Options**.

6. If you want to select another keyboard layout than the one that has been added by default, proceed as follows.

6a. Under **Input method**, click **Add an input method**.

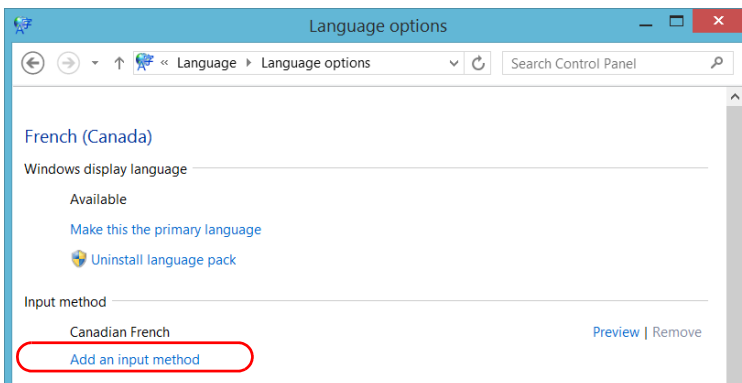

6b. Select the desired keyboard layout, and then click **Add**.

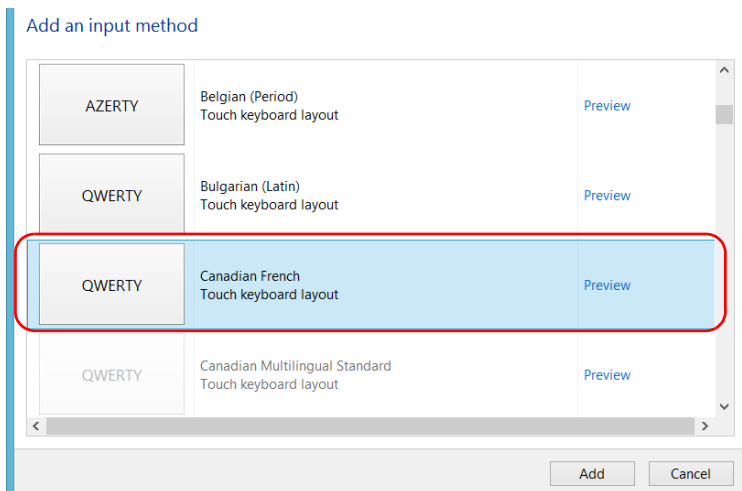

Setting Up Your Unit

Selecting the Language of Operation

7. Under **Windows display language**, click **Make this the primary language**.

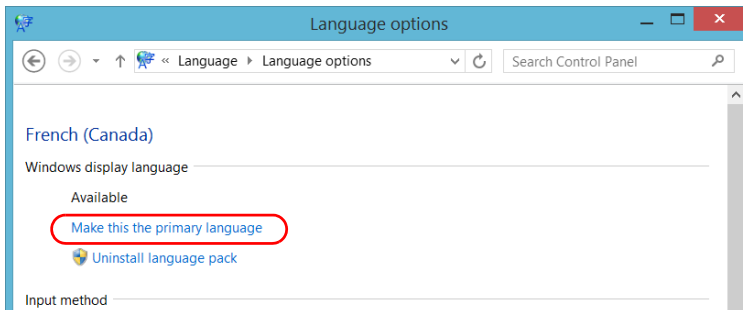

8. When the application prompts you to log off, click **Log off now**.
9. Once you see the lock screen, drag it down with your mouse to reveal the user accounts.
10. Log to your user account.

The new language is now selected and you are able to switch from one input language to another.

To switch from one of the available input languages to another:

1. From the taskbar, click the language code to display the list of available input languages.

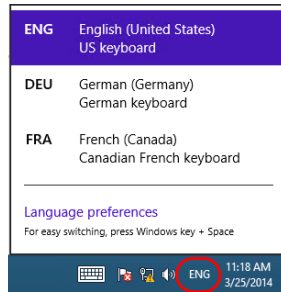

Language code

2. From the list of languages, select the desired one.

You are now ready to start entering text in the selected input language.

Note: *Modifying the input language does not modify the language of the interface.*

Setting Up Your Unit

Selecting the Language of Operation

To download language packs:

1. Ensure that your unit has access to the Internet.
2. From the main window, click the **System Settings** button.
3. Click **Control Panel**.

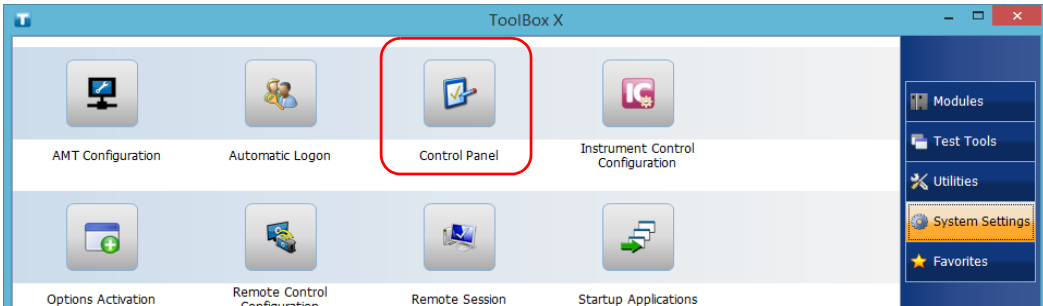

4. Under **Clock, Language, and Region**, click **Add a language**.

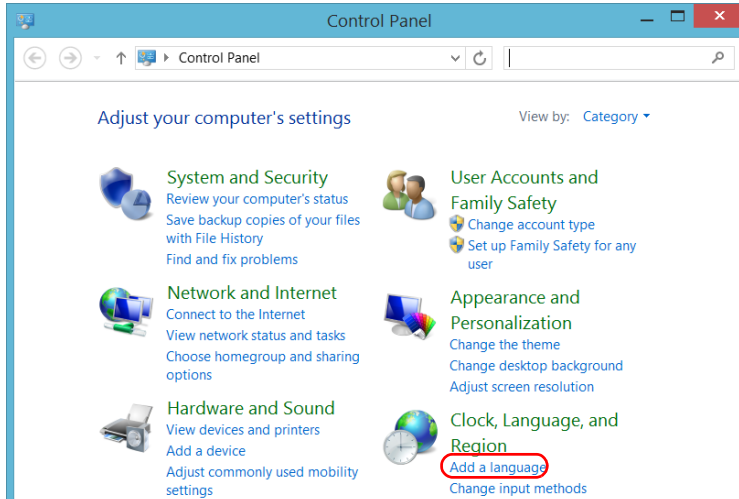

5. Click Add a language.

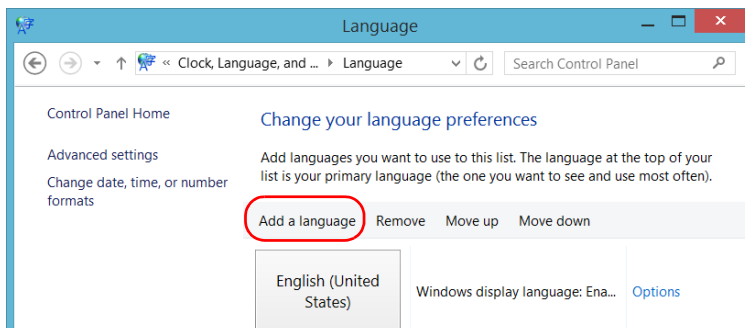

6. Browse the list of languages, and then select the one that you want to use.

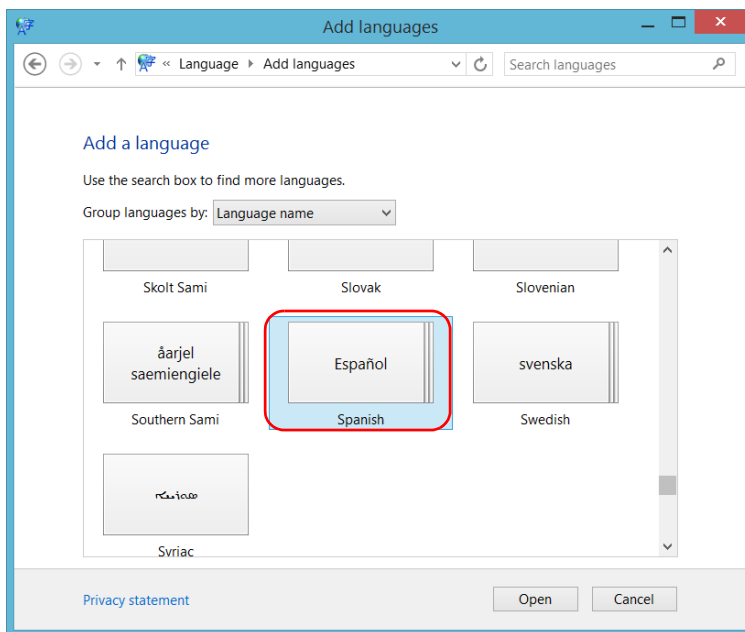

7. Click Open to access the list of sub-languages.

Setting Up Your Unit

Selecting the Language of Operation

8. Select the desired sub-language, and then click **Add**.

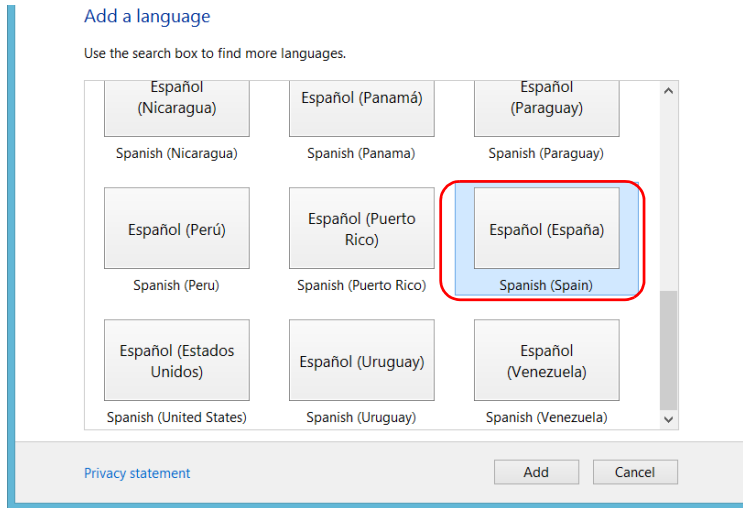

9. Select the desired language from the list.

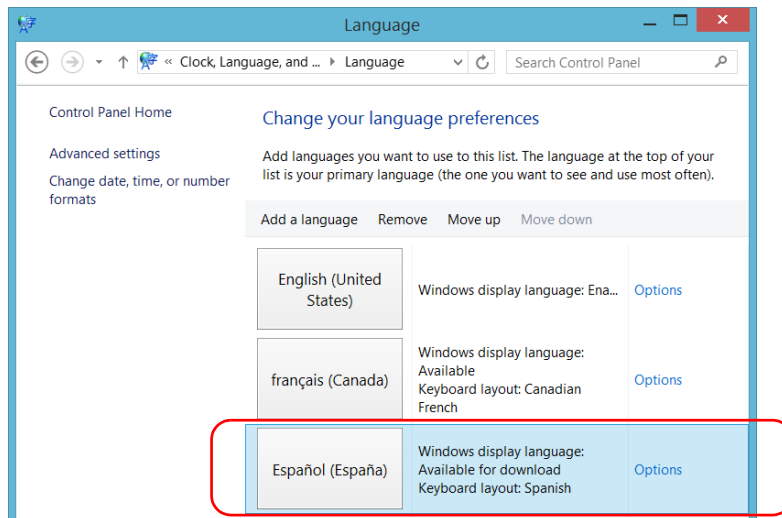

10. Click **Options**.

11. Click Download and install language pack.

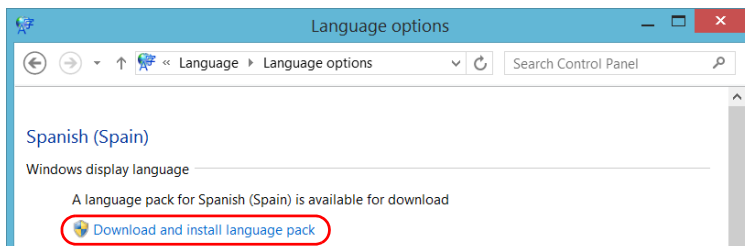

12. When the application prompts you to allow the installation, click Yes.
The installation may take a few minutes.

13. When the installation is complete, restart your unit.

Setting Up Your Unit

Setting Date and Time Formats

Setting Date and Time Formats

By default, the dates (short and long) and time are displayed in the formats associated with the global language format (locale). The time can be expressed with a 12- or a 24-hour notation. You can modify the way dates and time are displayed if the default values do not suit your needs.

For information on how to adjust the date, the time, and the time zone, see *Adjusting the Date, Time and Time Zone* on page 98.

To set date and time formats:

1. From the main window, click the **System Settings** button.
2. Click **Control Panel**.

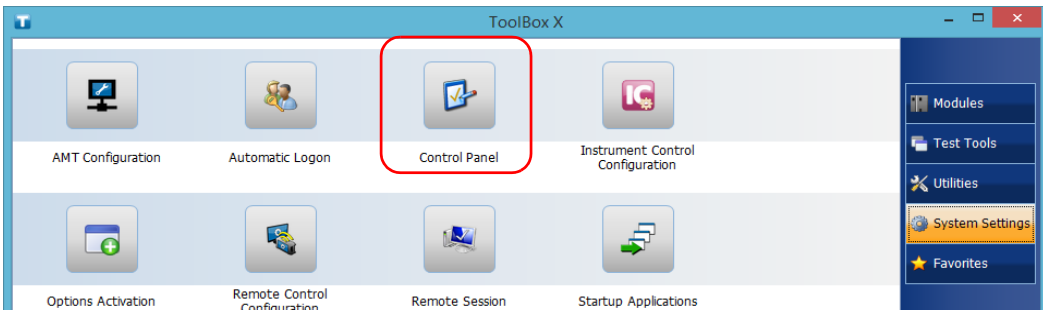

- 3. Under **Clock, Language, and Region**, click **Change date, time, or number formats**.**

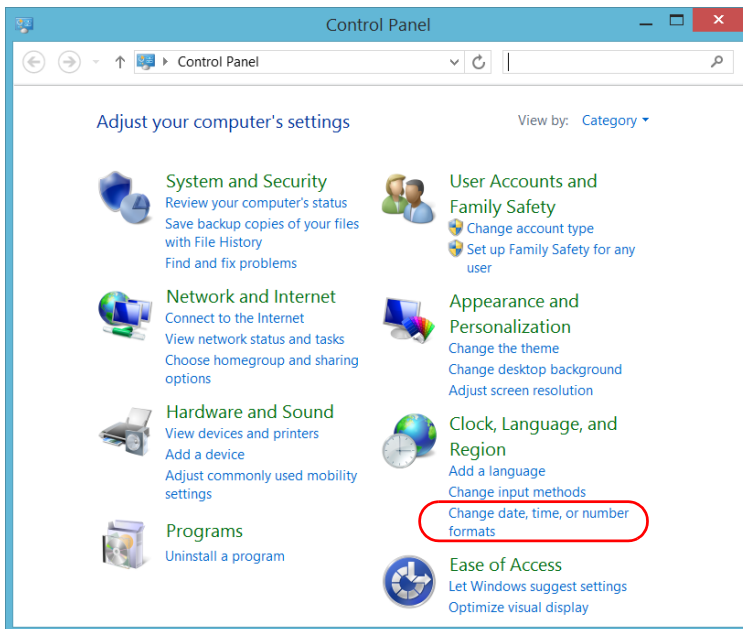

- 4. Refine the settings according to your needs.**
 - 5. Click **Apply** to confirm, and then **OK** to close the window.**
- The new values are taken into account immediately.

Setting Up Your Unit

Adjusting the Date, Time and Time Zone

Adjusting the Date, Time and Time Zone

Note: Only administrator-level users can adjust the date and time. All users can modify the time zone.

The current date and time are displayed at the bottom of the main window. When saving results, the unit also saves the corresponding date and time.

For information on how to modify the format in which the date and time are displayed, see *Setting Date and Time Formats* on page 96.

To adjust the date, time or time zone:

1. From the main window, tap the **System Settings** button.
2. Tap **Control Panel**.

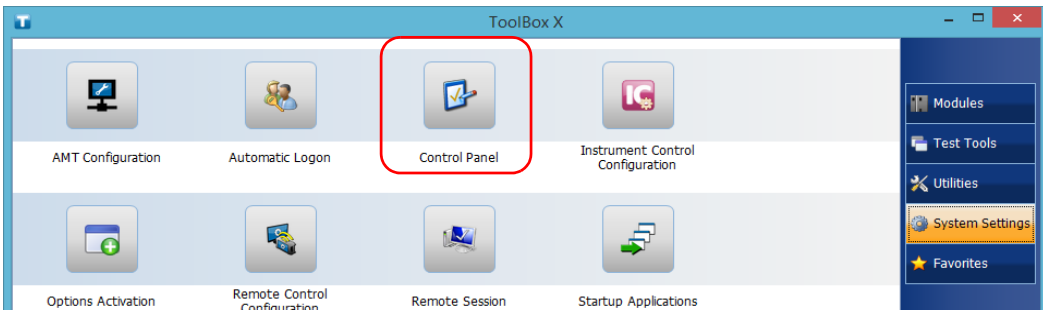

3. Tap Clock, Language, and Region.

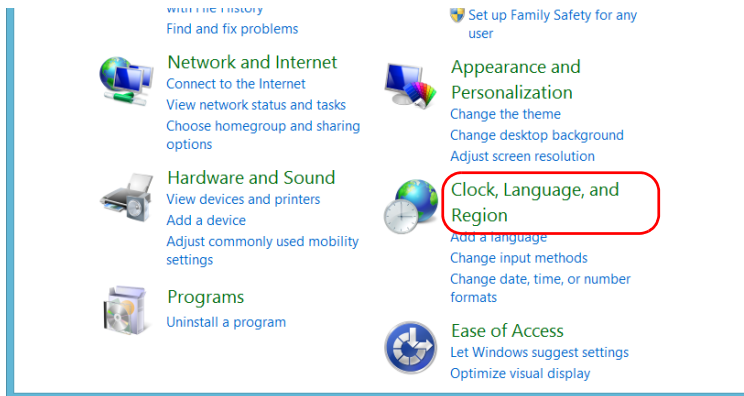

4. Under **Date and Time**, tap **Set the time and date**.

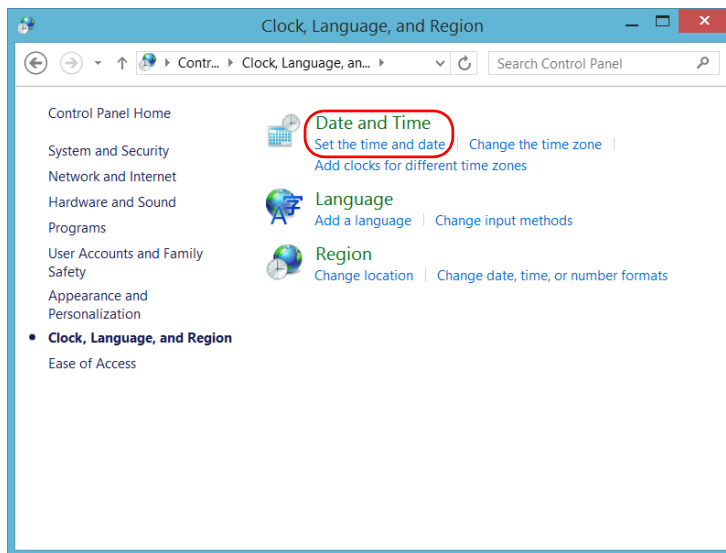

Setting Up Your Unit

Adjusting the Date, Time and Time Zone

5. Tap **Change date and time** or **Change time zone**, depending on the settings that you want to modify.

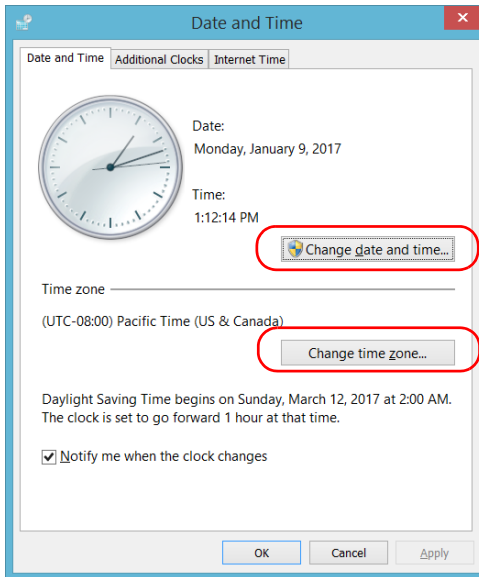

6. Modify the settings according to your needs, and then tap **OK**.
 7. Tap **Apply** to confirm, and then **OK** to close the window.
- The new values are taken into account immediately.

Setting Toolbox X Behavior

You can specify how Toolbox X behaves when the application is started, minimized or closed.

To set the Toolbox X behavior:

1. From the main window, click the **System Settings** button.
2. Click **ToolBox X Setup**.

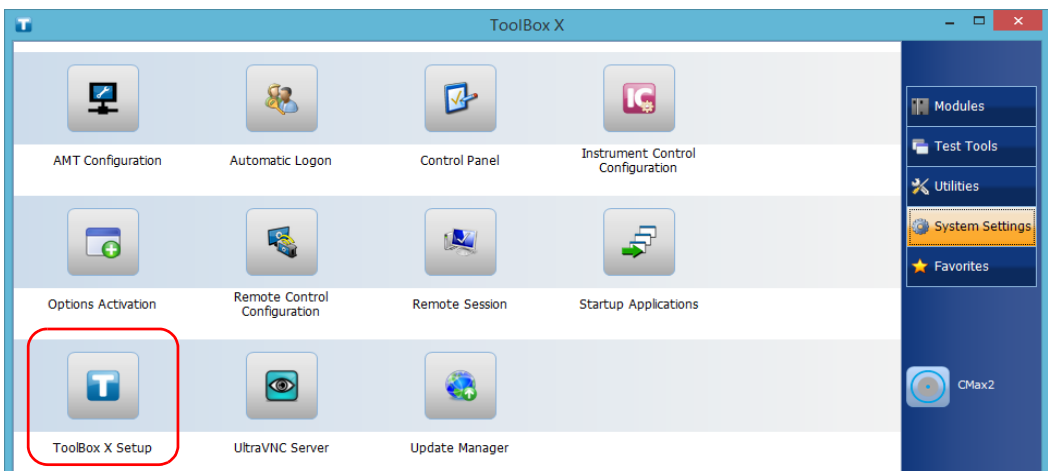

Setting Up Your Unit

Setting Toolbox X Behavior

3. Select the items corresponding to the desired behavior.

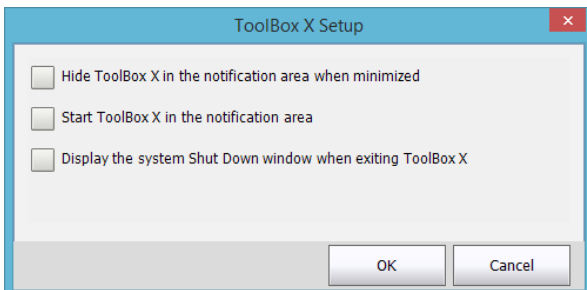

- **Hide ToolBox X in the notification area when minimized:** If this option is selected, the Toolbox X icon appears in the notification area (where the clock is located) when you minimize the window.
 - **Start ToolBox X in the notification area:** If this option is selected, Toolbox X is automatically started, then minimized to the notification area (system tray).
 - **Display the system Shut Down window when exiting ToolBox X:** If this option is selected, the standard system Shut Down window appears to let you shut down the unit directly instead of closing the Toolbox X application, then shutting down the unit from Windows. For more information on the different ways to turn off your unit, see *Turning off Your Unit* on page 64.
4. Click **OK** to confirm your settings and close the window.

Configuring the Internet Options

You can browse the Web directly from your unit, provided that you have access to an Internet connection and that the Internet options are configured properly.

If you are not sure about how you should configure your Internet access, contact your network administrator.

To configure the Internet options:

- 1.** From the main window, click the **System Settings** button.
- 2.** Click **Control Panel**.

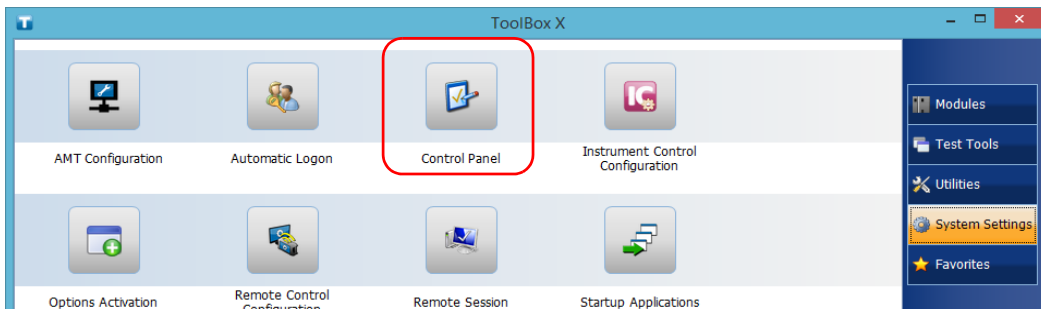

Setting Up Your Unit

Configuring the Internet Options

3. Click **Network and Internet**.

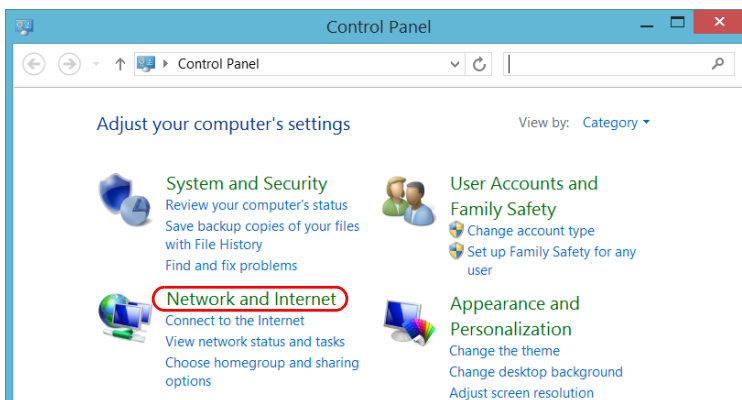

4. Click **Internet Options**.

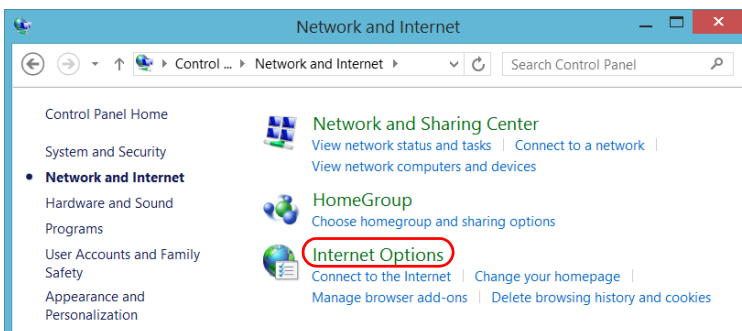

5. Go to the **Connections** tab.

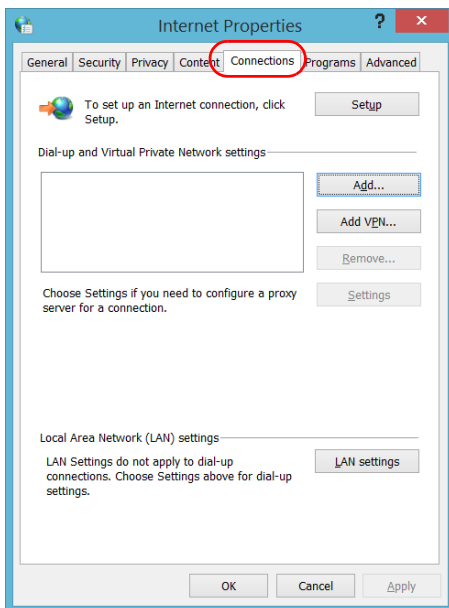

6. Modify the settings using the information provided by your network administrator.
7. Click **OK** to return to the **Control Panel** window.

Setting Up Your Unit

Reconfiguring the Local Access Ports in LAN/WAN Ports

Reconfiguring the Local Access Ports in LAN/WAN Ports

By default, the local access ports (one on the front panel of the unit, and one on the back panel), have a static IP address (192.168.200.1), but you can reconfigure this address. For more information, see *Modifying the IP Address of the Local Access (Management) Ports* on page 129.

Note: *If the unit is connected to a network via its local access (management) ports, Windows will automatically assign them a dynamic IP address. However, this has no impact on the static IP address used by AMT (two separate entities), which means that you will still be able to access AMT using the static IP address.*

Setting Other Parameters

You can also configure many other parameters via the **Control Panel** window. Refer to Microsoft Windows documentation for details.

5 Working with Your Unit

Printing Documents

You can print documents and images directly from your unit by using the provided PDF creation tool.

You can view the PDF files from your unit, using the provided PDF reader. For more information, see *Viewing PDF Files* on page 108.

Note: *Some applications may not offer print functions.*

To print documents:

1. Open the document that you want to print.
2. From the application in which you have opened your file, access the print function.

Note: *In most applications, you can access the print function by the **File** menu or by a **Print** button.*

3. Select the desired printer (PDF creation tool by default).
4. If necessary, adjust the printer's parameters to your needs.
5. Click **Print** to start the printing process, and follow the on-screen instructions.

Working with Your Unit

Viewing PDF Files

Viewing PDF Files

You can view PDF files directly from your unit using the provided PDF file viewer. For more information on the available features for this viewer, refer to the PDF viewer online help.

Note: *You may need a connection to the Internet to access the PDF viewer online help.*

To view PDF files:

1. From the main window, click the **Utilities** button.
2. Click **File Manager**.

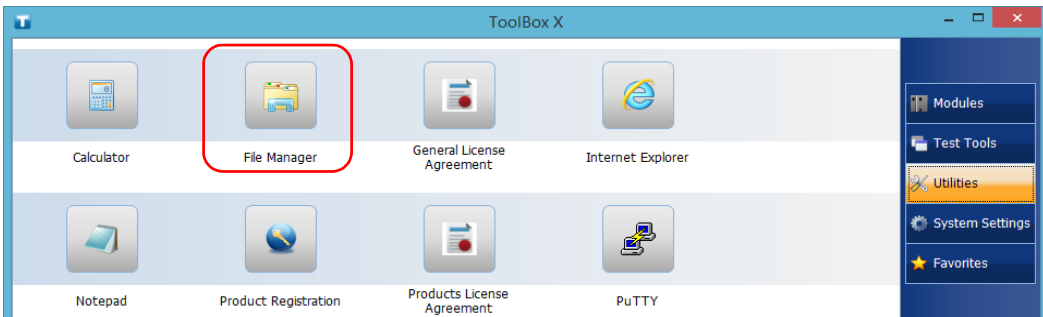

3. Browse through the folders to find the desired PDF file.
4. Double-click the file.
5. The file opens automatically in the PDF viewer.

Browsing the Web

You can browse the Web directly from your unit, provided that you have access to an Internet connection.

If you need to modify the Internet options, see *Configuring the Internet Options* on page 103.

To browse the Web:

1. Open a Web browser as follows:
 - 1a.** From the main window, tap the **Utilities** button.
 - 1b.** Tap the **Edge** (Windows 10) or the **Internet Explorer** (Windows 8.1 Pro) icon to open the browser.
2. Enter the desired Web address in the address bar and click the  button (located at the right of the address bar) to start browsing.

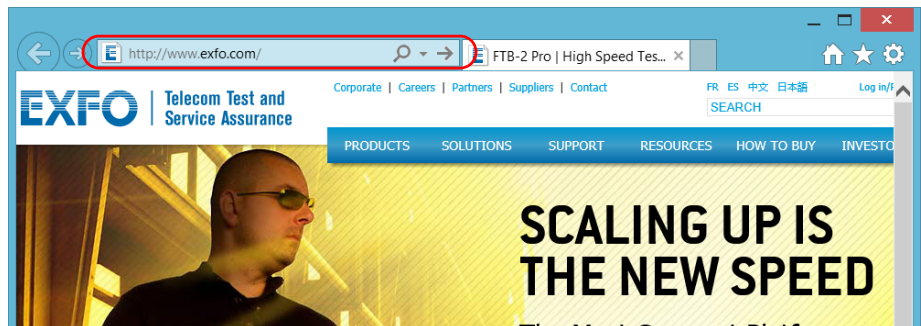

- 3.** Close the window to return to the **Utilities** window.

Managing Favorites

For a quicker access to the applications that you use most often, you may want to build your own list of favorite applications (Favorites).

You can add and remove Favorites from the list. You can also import and export lists of Favorites, which could be useful for backup and recovery purposes, or to share the same Favorites among several units.

Note: *To have access to the same Favorites on several units, the corresponding applications must be available on all units.*

To add Favorites:

1. From the main window, click the **Favorites** button.
2. Click **Favorites Management**.

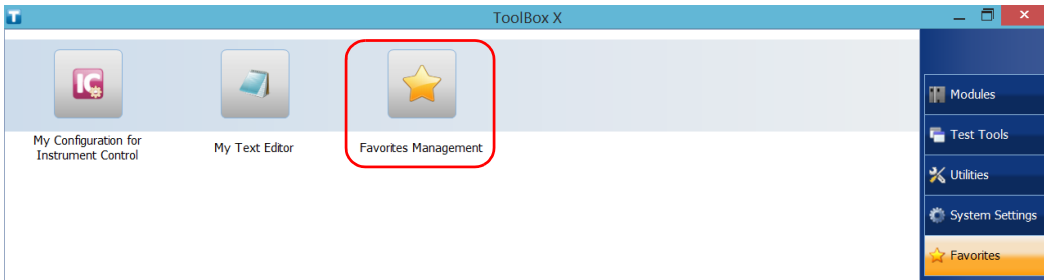

3. Click **Add**.

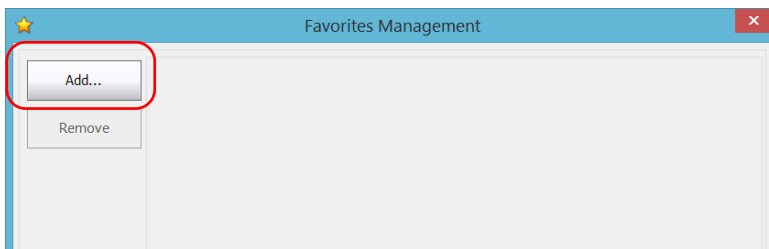

4. Click **Browse** to locate the desired application.

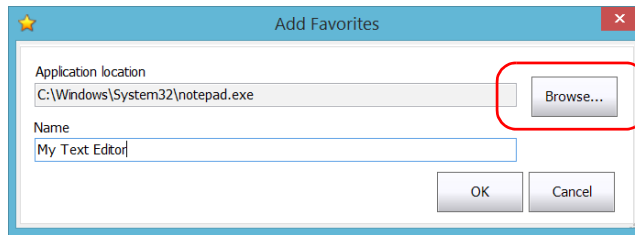

5. Type a name for the new Favorite.
6. Click **OK** to confirm the location and name.
7. Repeat the previous steps with all the Favorites that you want to add.
8. Click **OK** to apply the changes and close the window.

To remove Favorites:

1. From the main window, click the **Favorites** button.
2. Click **Favorites Management**.

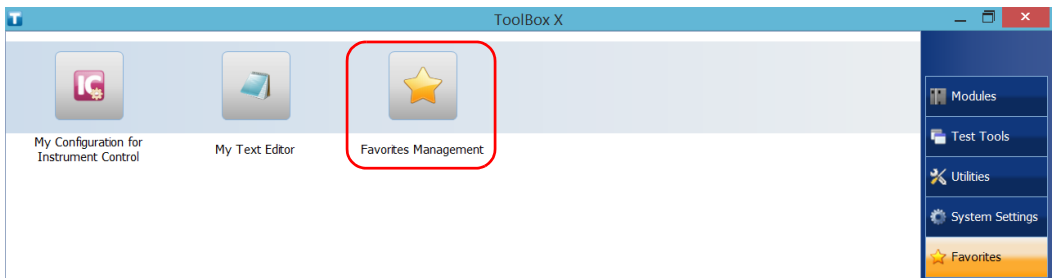

Working with Your Unit

Managing Favorites

3. Click the icon corresponding to the Favorite that you want to remove from the list.

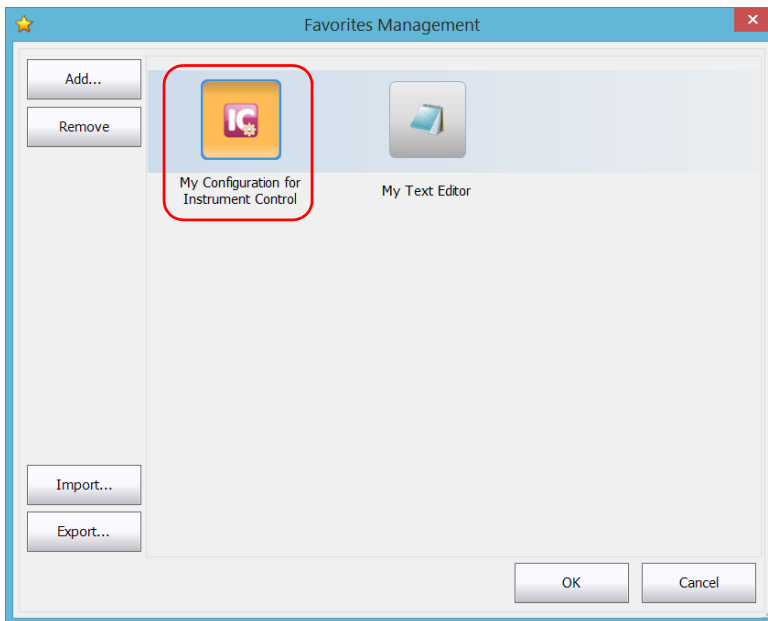

4. Click **Remove**.

Note: *The application will not prompt you to confirm the removal of the Favorite from the list. Removing a Favorite from the list does not uninstall the application from the unit.*

5. Click **OK** to apply the changes and close the window.

To work with Favorites:

1. From the main window, click the **Favorites** button.
2. Click the icon corresponding to the application that you want to use.

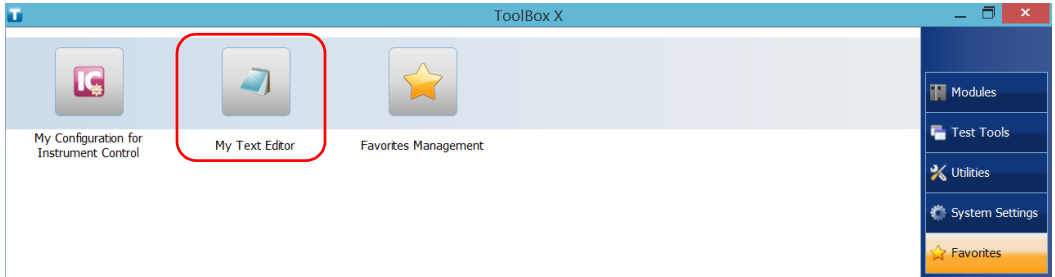

Working with Your Unit

Managing Favorites

To export the list of Favorites:

1. From the main window, click the **Favorites** button.
2. Click **Favorites Management**.

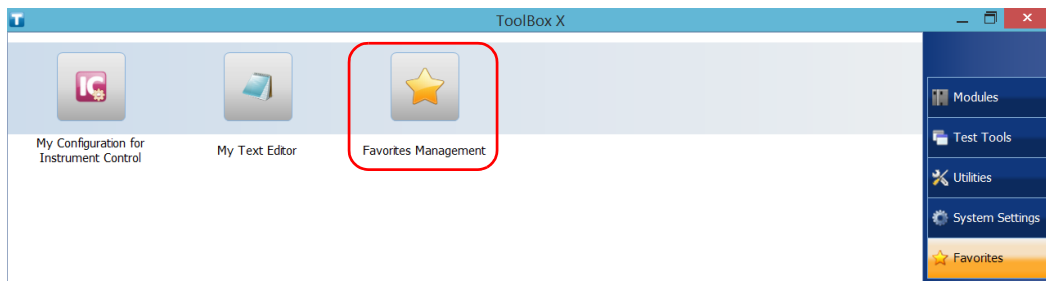

3. Click **Export**.

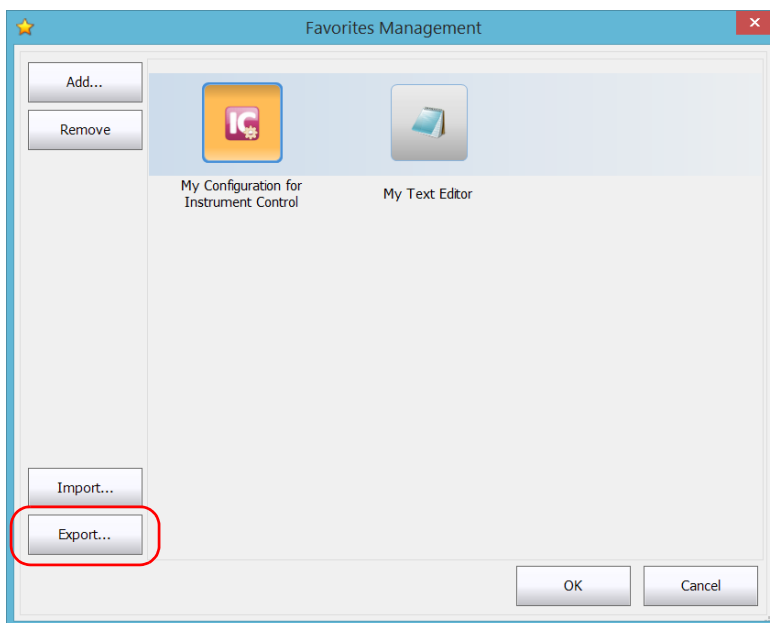

4. Select a location and type a name for the Favorites list.

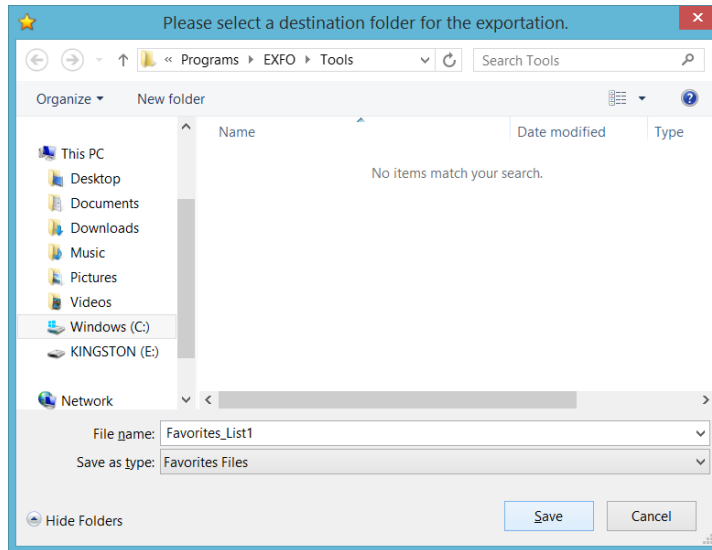

5. Click **Save**.
6. Click **OK** to apply the changes and close the window.

Working with Your Unit

Managing Favorites

To import a list of Favorites:

1. From the main window, click the **Favorites** button.
2. Click **Favorites Management**.

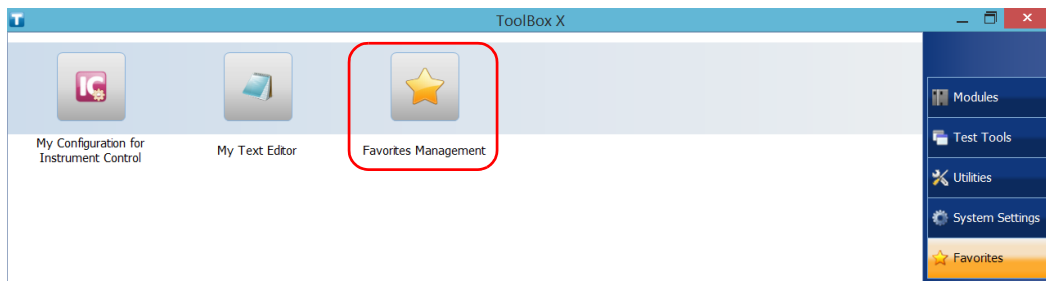

3. Click **Import**.

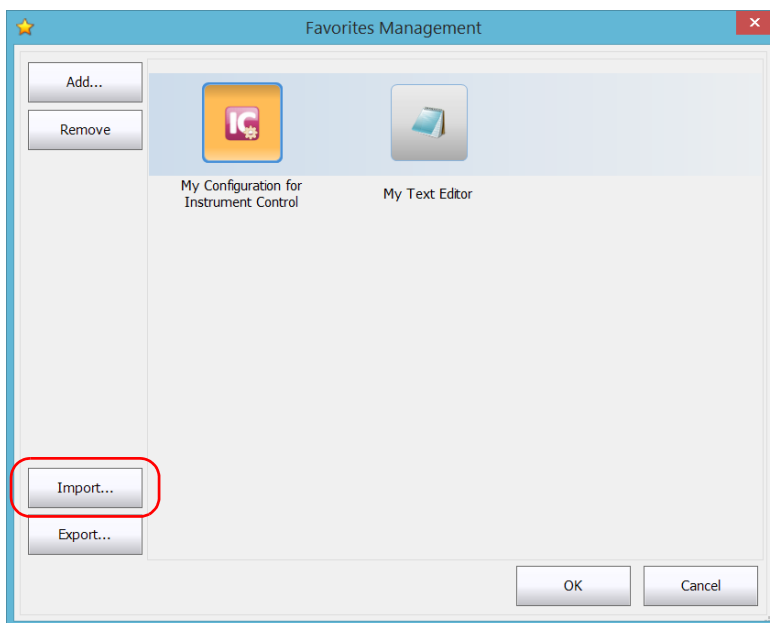

4. Select the desired Favorites list.

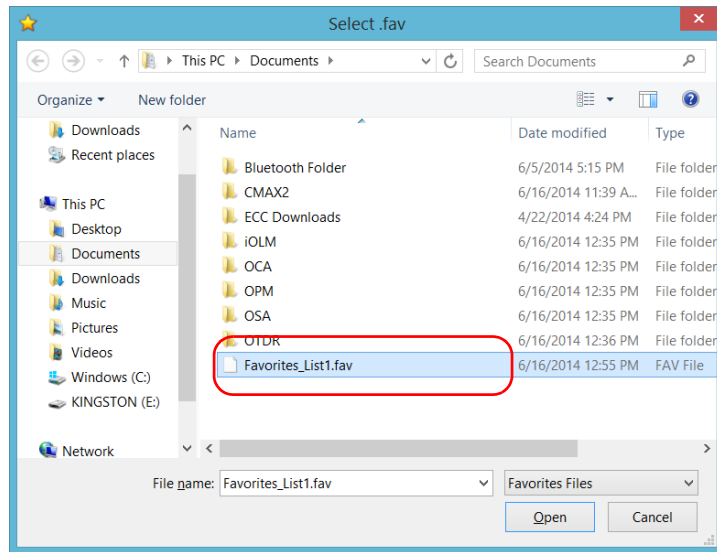

5. Click **Open**.
6. Click **OK** to apply the changes and close the window.

Using the Calculator

You can use Microsoft Calculator directly from your unit.

To use the Calculator:

1. From the main window, click the **Utilities** button.
2. Click **Calculator**.

Using the Text Editor

You can use Microsoft Notepad directly from your unit.

To use the text editor:

1. From the main window, click the **Utilities** button.
2. Click **Notepad**.

Accessing Other Tools

Your unit comes with various tools that can help you better analyze or manage your data.

You have also access to free tools such as Wireshark to help you troubleshoot networks. For more information, refer to the online help provided with these tools, when applicable.

To access the applications:

1. From the main window, click the **Test Tools** button.

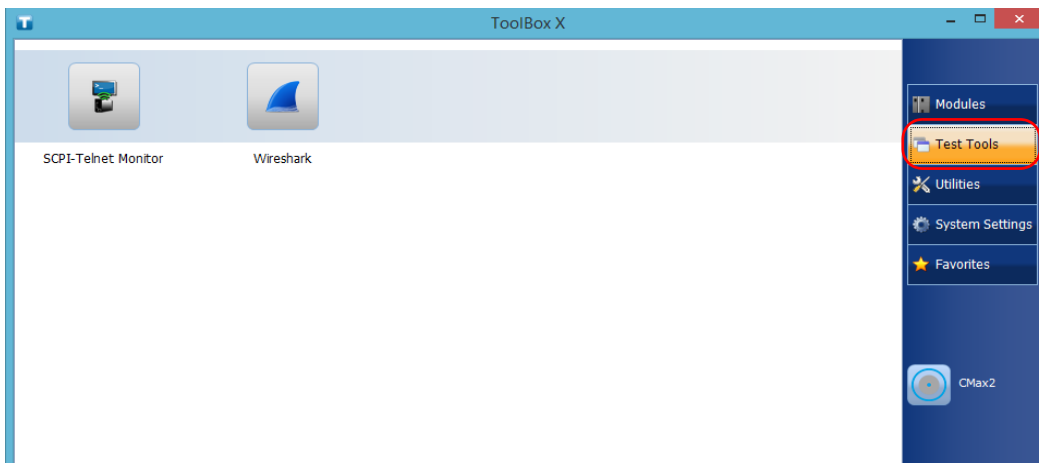

2. Click the icon corresponding to the application that you want to start.

6 ***Working with Intel Active Management Technology***

Your unit supports the Intel Active Management Technology (AMT), which enables you to manage your unit remotely without being dependent on the operating system or on the state of the unit (out-of-band management).

To manage your unit out of band, you can install the AMT Remote Access application, provided by EXFO, on a computer (laptop). This application will serve as an entry point to the AMT Web-based application from which you can configure settings, and retrieve information related to your unit. You can also perform operations such as turning the unit on or off remotely.

Note: *You could also use other third-party AMT tools such as Intel Manageability Commander, as long as they support Intel AMT version 9.0.*

Note: *Your unit comes with an already-defined default AMT configuration to help you with the out-of-the-box (OOBE) experience.*

Installing the AMT Remote Access Application on a Computer

The AMT Remote Access application, that you can use to connect to your unit remotely, is available from EXFO's Web site.

To install the AMT Remote Access application on your computer:

1. Open a Web browser and go to <http://www.exfo.com/software/exfo-apps>.
2. Under **EXFO Apps**, click the **PC Software** category.
3. Look for the AMT Remote Access application for your unit.
4. Download the application.
5. Double-click the file that you have just downloaded to start the installation.
6. Follow the on-screen instructions.

Once the installation is complete, you are ready to use this application to connect to your unit remotely.

Connecting to Your Unit Remotely With AMT Remote Access

With the AMT Remote Access application, you can connect to the unit in two ways, depending on the type of tasks that you need to perform:

- **Connection mode:** You have access to the unit and the applications exactly as if you were in front of the unit with a monitor, a keyboard, and a mouse connected to it. This could be particularly useful when you turn on your unit for the first time to configure the basic Windows parameters and read the safety information. For day-to-day operation, EXFO recommends that you use Remote Desktop or VNC (see *Working with Remote Desktop* on page 157 and *Working With VNC* on page 167).
- **Management mode:** You have access to the maintenance or troubleshooting parameters (current state of the unit (on/off), configuration of IP address, user management for AMT, modification of the default AMT administrator password, etc.).

Working with Intel Active Management Technology

Connecting to Your Unit Remotely With AMT Remote Access

To be able to connect to the unit using the AMT Remote Access application, you must:

- Know the IP address of the unit and provide it in the connection settings on the computer.
By default, the maintenance front and rear ports are configured with the following static IP address: *192.168.200.1*

LTB-2

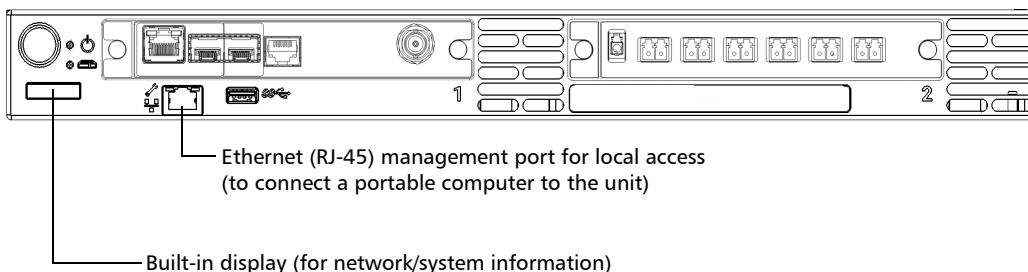

LTB-8

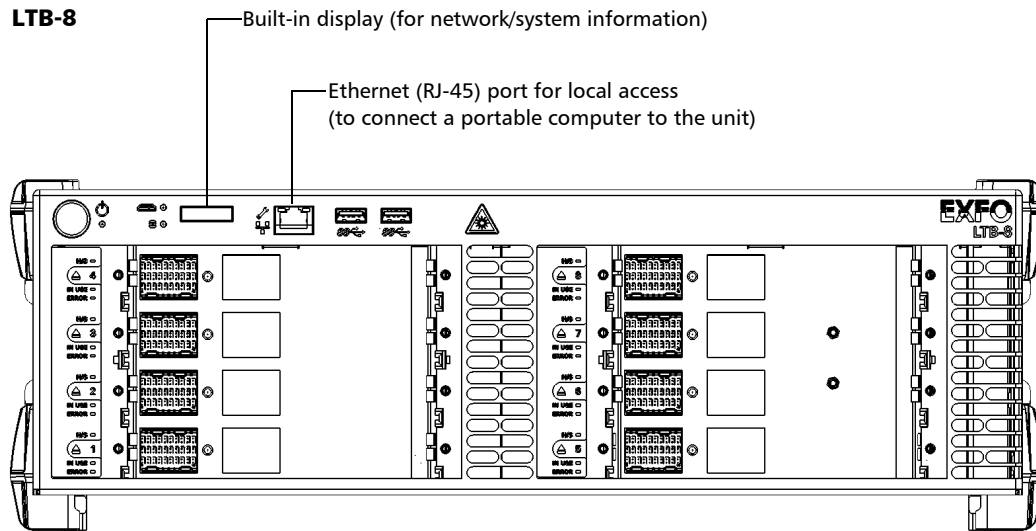

Working with Intel Active Management Technology

Connecting to Your Unit Remotely With AMT Remote Access

LTB-12 – Front panel

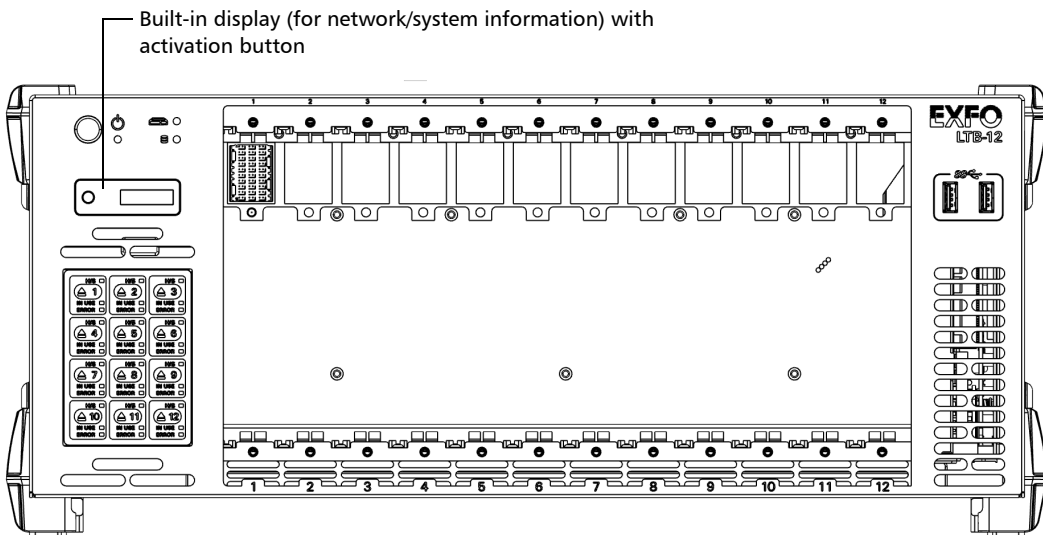

Working with Intel Active Management Technology

Connecting to Your Unit Remotely With AMT Remote Access

LTB-12 – Back panel

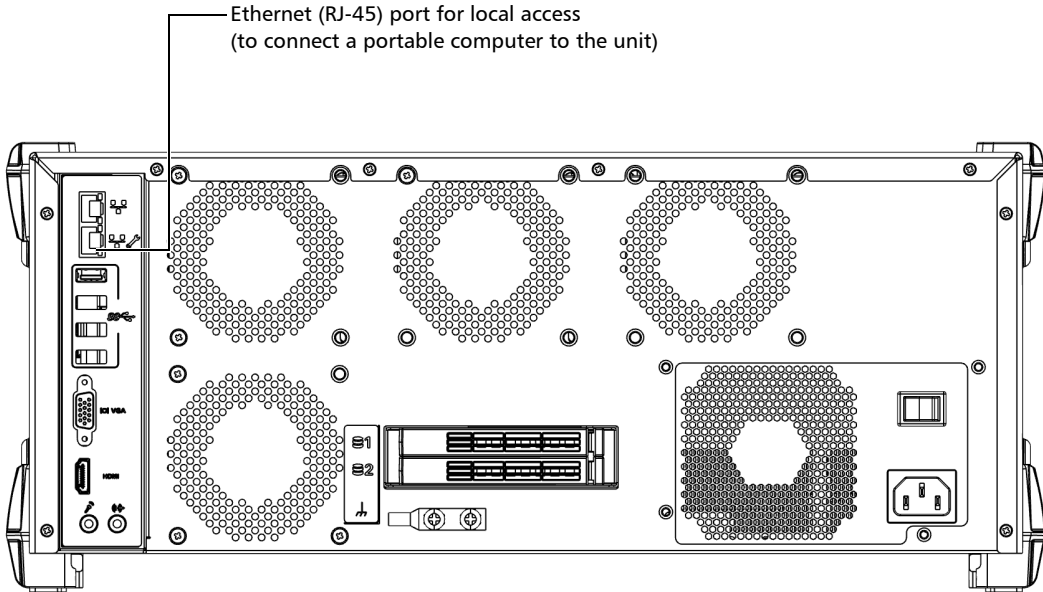

Note: You can view the current IP address on the built-in display located on the front panel of the unit.

- Know the AMT user name and associated password.
 - The default user name is: *admin*
 - The default password is: *!Exfo123*

Note: The application is case-sensitive for both the user name and password.

Note: The AMT user accounts are completely independent of Windows user accounts. For this reason, you cannot connect to AMT Web-based application using Windows user accounts.

Working with Intel Active Management Technology

Connecting to Your Unit Remotely With AMT Remote Access

To connect to your unit (Connection mode):

1. Depending on your setup, connect a network cable between your computer and the front Ethernet port (LTB-2 and LTB-8) or the rear Ethernet port (LTB-12).

OR

Connect your computer and unit to the same network.

Note: *You may have to modify the IP address of the computer to make sure that the computer and unit can “see” each other. The IP address of the computer must be within the same range of addresses as the IP address of the unit (ex.: 192.168.200.20).*

Note: *If several units are connected to the same network with the default static IP address, you may have to modify the IP addresses of these units to avoid connection problems (not accessing the right unit).*

2. From your computer, start the AMT Remote Access application.

Working with Intel Active Management Technology

Connecting to Your Unit Remotely With AMT Remote Access

3. Enter the connection information.

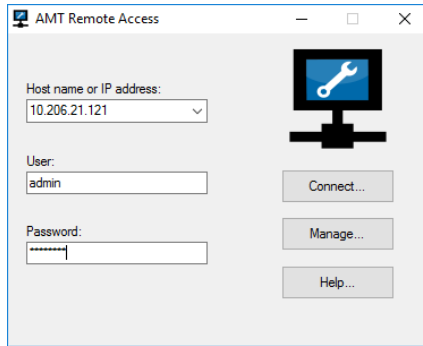

Note: *The connection information could correspond to the default values as mentioned above, or to your own values if you have reconfigured the IP address of the Ethernet port, or modified the password. If you prefer, you could also connect using another user account previously defined.*

Note: *The application only allows one connection at a time with a given user account.*

4. Click **Connect** to access Windows and ToolBox X.
5. Once the connection is established, if Windows prompts you, select the desired Windows user, and then enter the associated password.

Working with Intel Active Management Technology

Connecting to Your Unit Remotely With AMT Remote Access

To connect to your unit (Management mode):

1. Depending on your setup, connect a network cable between your computer and the front Ethernet port (LTB-2 and LTB-8) or the rear Ethernet port (LTB-12).

OR

Connect your computer and unit to the same network.

Note: You may have to modify the IP address of the computer to make sure that the computer and unit can “see” each other. The IP address of the computer must be within the same range of addresses as the IP address of the unit (ex.: 192.168.200.20).

Note: If several units are connected to the same network with the default static IP address, you may have to modify the IP addresses of these units to avoid connection problems (not accessing the right unit).

2. From your computer, start the AMT Remote Access application.
3. Enter the host name or IP address of your unit (default or your own).

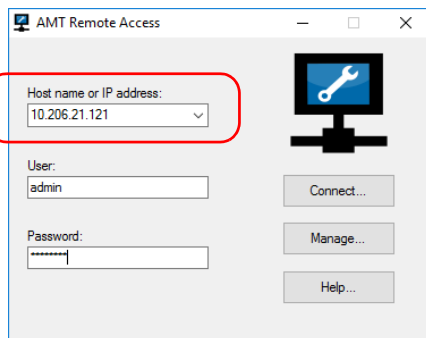

4. Click **Manage**.

Note: If you are already connected to your unit via Remote Desktop, and wish to access the AMT Web-based application, from ToolBox X, click **System Settings > AMT Configuration**.

Working with Intel Active Management Technology

Connecting to Your Unit Remotely With AMT Remote Access

5. Click Log On.



6. Enter the AMT user name and password (default values or your own), and then click **OK**.

Note: *If you do not want to connect with the admin account, you can connect using any other user account previously defined.*

Once the connection is established, the **System Status** window is displayed and you are ready to configure the unit.

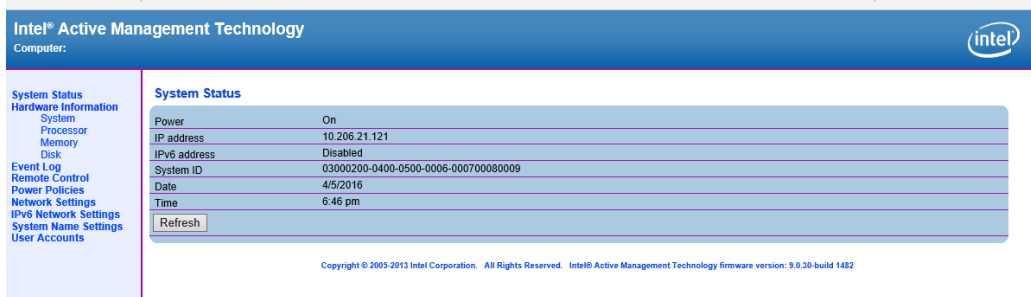

Modifying the IP Address of the Local Access (Management) Ports

By default, the local access ports (one on the front panel of the unit, and one on the back panel), have a static IP address: *192.168.200.1*.

If you prefer, you can reconfigure this address for another IP address of your choice. You can either enter a specific static address, or configure your unit so that your network infrastructure (DHCP server) provides a new one automatically each time the unit is started.



IMPORTANT

The new IP address will only be visible on the built-in display after you have restarted the unit.

Working with Intel Active Management Technology

Modifying the IP Address of the Local Access (Management) Ports

To modify the IP address of the local access ports:

1. Connect to your unit in management mode (see *Connecting to Your Unit Remotely With AMT Remote Access* on page 121).
2. From the main window, click **Network Settings** to set an IPv4 address or **IPv6 Network Settings** to set an IPv6 address.

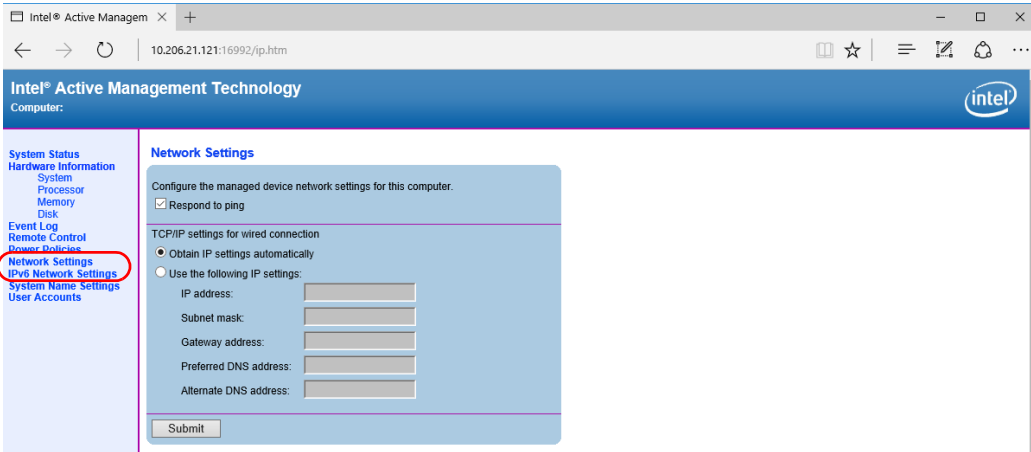

3. Set the parameters as needed.
4. Click the **Submit** button to apply your changes.
5. Restart the unit to refresh the IP address shown on the built-in display.

Changing the AMT Administrator Password

By default, the administrator user account (user name: admin), is protected with the *!Exfo123* password.

For security reasons, EXFO recommends that you change the default password for a password of your choice.

To change the AMT administrator password:

1. Connect to your unit in management mode (see *Connecting to Your Unit Remotely With AMT Remote Access* on page 121).
2. From the main window, click **User Accounts**.

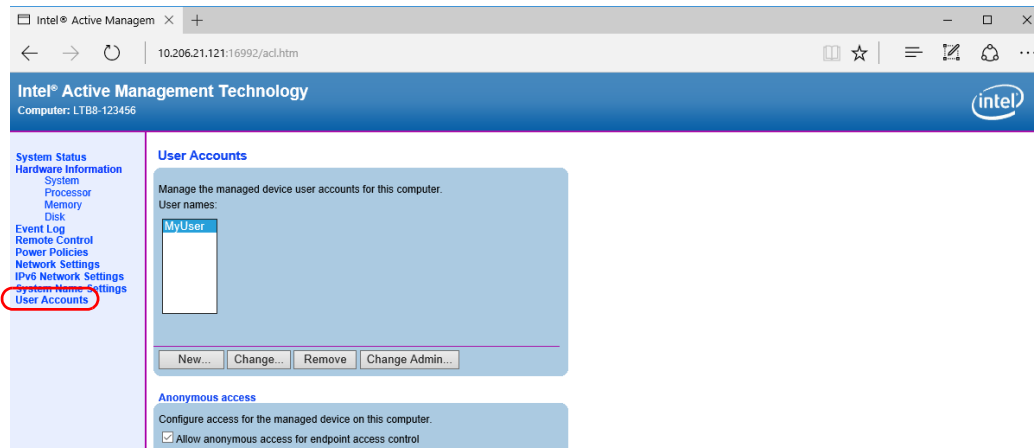

3. Click the **Change Admin** button.

Working with Intel Active Management Technology

Changing the AMT Administrator Password

4. Enter the new password, and then confirm it.

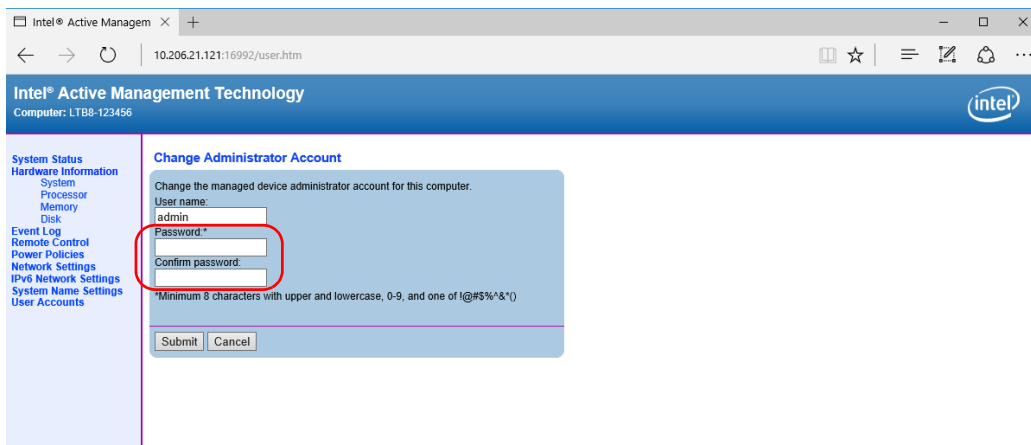

The screenshot shows a web browser window with the URL `10.206.21.121:16992/user.htm`. The page title is "Intel® Active Management Technology" and the computer ID is "LTB8-123456". On the left is a navigation menu with categories like "System Status", "Hardware Information", "Event Log", "Remote Control", "Power Policies", "Network Settings", "IPv6 Network Settings", "System Name Settings", and "User Accounts". The main content area is titled "Change Administrator Account" and contains the following text and form fields:

Change the managed device administrator account for this computer.

User name:

Password.*

Confirm password:

Minimum 8 characters with upper and lowercase, 0-9, and one of !@#%&'&()

At the bottom of the form are "Submit" and "Cancel" buttons. The "Password" and "Confirm password" input fields are circled in red in the original image.

5. Click the **Submit** button to apply your changes.

Managing the AMT User Accounts

By default, there is only one user account defined for the AMT application (*admin*). This user account allows you to connect as an administrator of the system.

As an AMT administrator of the system, you can create user accounts, modify them, or even remove them if you no longer want anybody to use these accounts for connection.

Note: *If you want to modify the administrator user account, see Changing the AMT Administrator Password on page 131.*

Note: *The AMT user accounts are completely independent of Windows user accounts.*

To create a user account:

1. Connect to your unit in management mode (see *Connecting to Your Unit Remotely With AMT Remote Access* on page 121).
2. From the main window, click **User Accounts**.

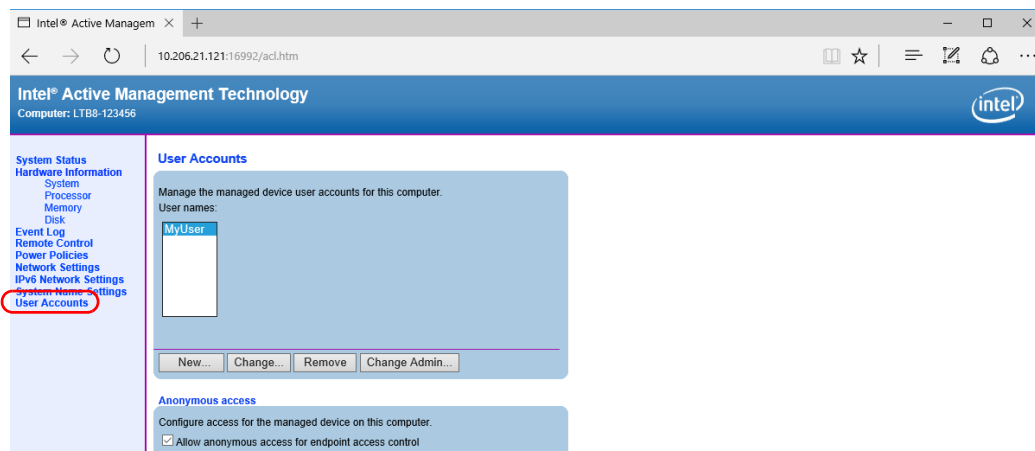

3. Click the **New** button.

Working with Intel Active Management Technology

Managing the AMT User Accounts

4. Enter a name and a password for the account, and grant the desired user rights.

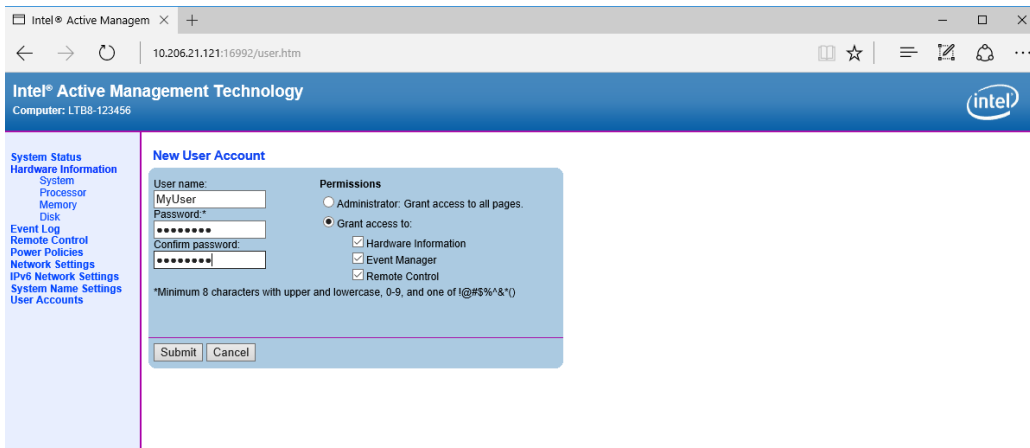

5. Click the **Submit** button to apply your changes.

To modify a user account:

1. Connect to your unit in management mode (see *Connecting to Your Unit Remotely With AMT Remote Access* on page 121).
2. From the main window, click **User Accounts**.

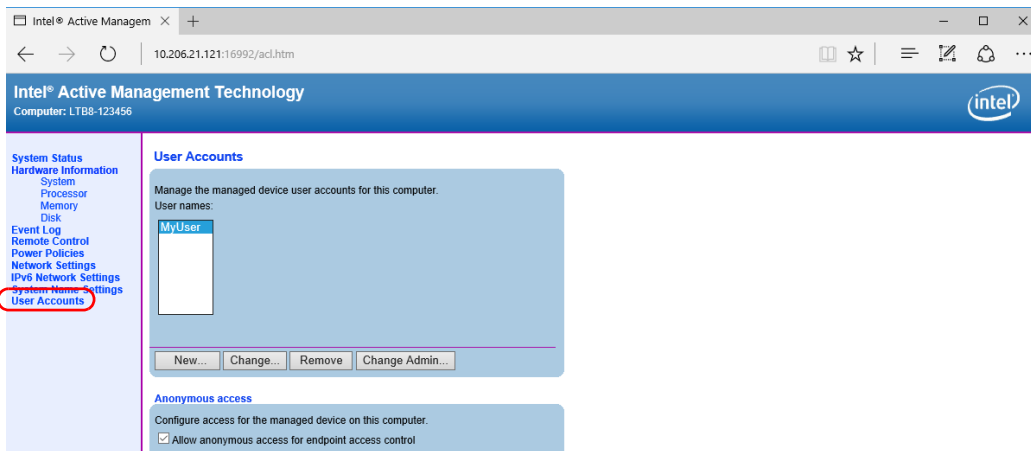

3. Under **User names**, select the account that you want to modify.

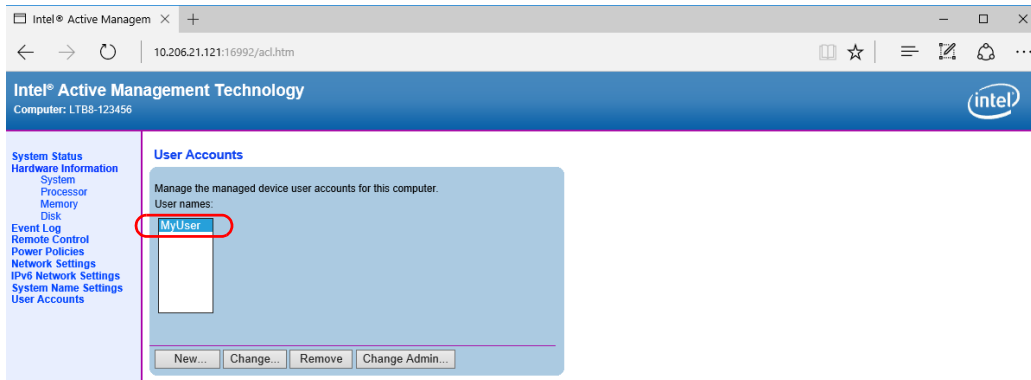

Working with Intel Active Management Technology

Managing the AMT User Accounts

4. Click the **Change** button.
5. Modify the settings as needed.

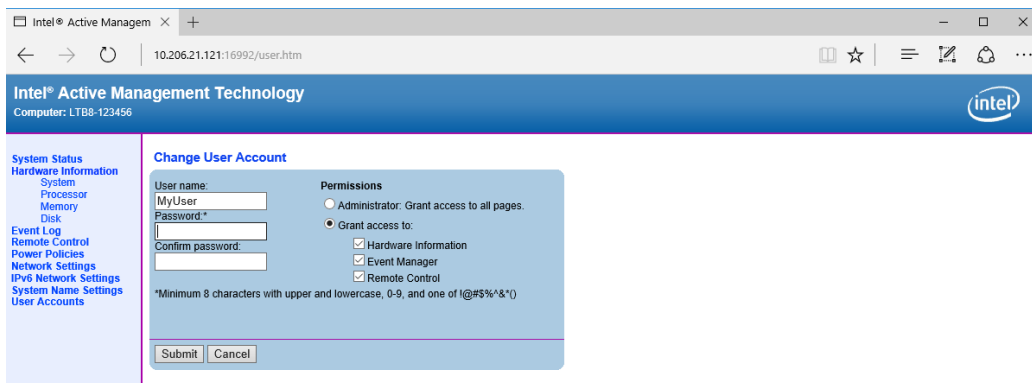

6. Click the **Submit** button to apply your changes.

To delete a user account:

1. Connect to your unit in management mode (see *Connecting to Your Unit Remotely With AMT Remote Access* on page 121).
2. From the main window, click **User Accounts**.

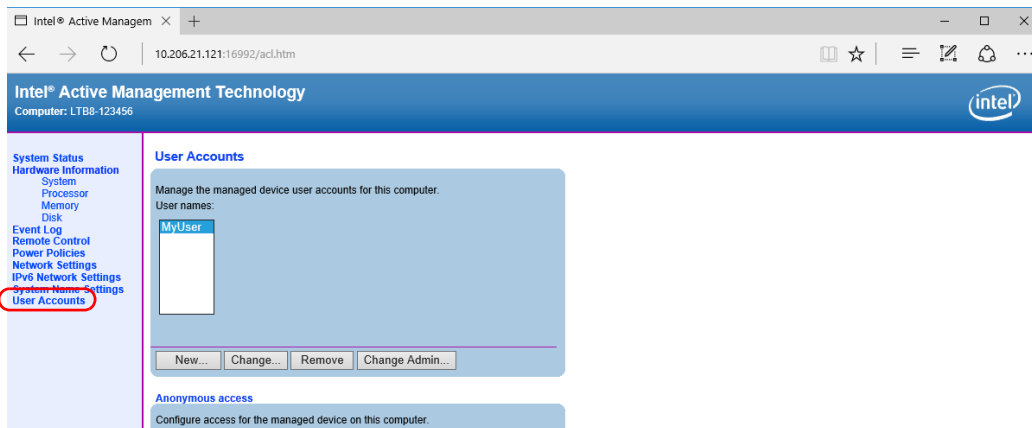

3. Under **User names**, select the account that you want to delete.

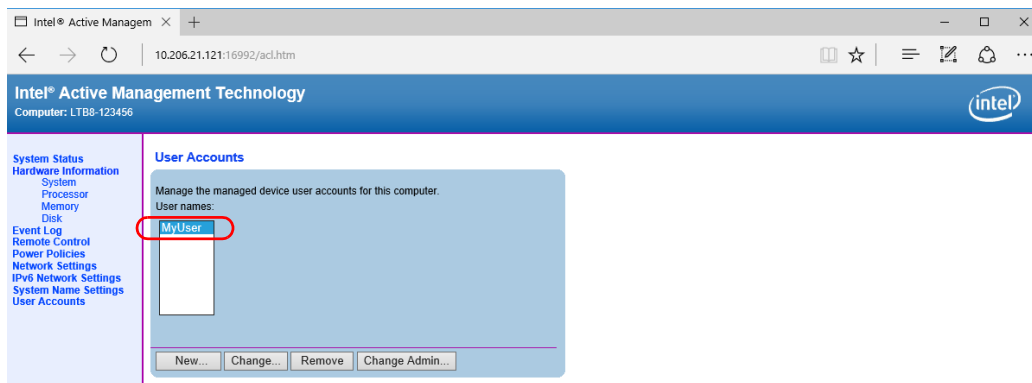

4. Click the **Remove** button.
5. When the application prompts you to confirm the deletion, click the **Remove** button.

Turning the Unit On or Off Remotely

You can turn the unit on or off remotely by using the AMT application.

To turn the unit on or off remotely:

1. Connect to your unit in management mode (see *Connecting to Your Unit Remotely With AMT Remote Access* on page 121).
2. From the main window, click **Remote Control**.

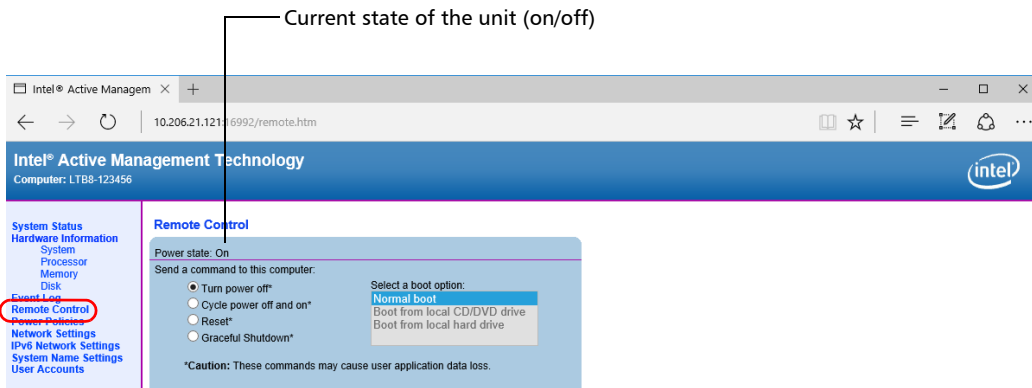

Note: The displayed values reflect the current settings.



IMPORTANT

No warning message will be sent to the users currently working with the unit before turning it off. If tests are underway, important data could be loss.

3. Select the desired action, and then click the **Send Command** button.

Performing Other Operations

You can also configure other parameters from AMT such as the system name settings, and have access to information such as the system status and the log of events. All these items are accessible from the main window of the AMT Web-based application.

7 *Inspecting Fibers with a Probe*

The fiber inspection probe (FIP) is used to find dirty or damaged connectors by displaying an enlarged view of the connector surface. You can connect an FIP to your unit to view fiber ends.



IMPORTANT

Only the probes of the FIP-400B series are supported on your unit.

Fiber inspections are made using the ConnectorMax2 application. For more information, refer to the ConnectorMax2 online help.

To inspect fibers with a probe:

1. Connect the probe to one of the USB ports of your unit (front or back panel).
2. From Toolbox X, click the **CMax2** button to open the application.



Note: You can access the online help by clicking the  button from the ConnectorMax2 application.

8 ***Managing Data***

You can copy, move, rename, delete files and folders directly on your unit.

You can transfer files from your unit to a USB memory key or a computer.

You can also transfer data from a storage device or a computer to your unit.

Your unit is equipped with the following ports and devices for data transfer:

- Six USB 3.0 port to connect a memory key
- An Ethernet port to connect to a network (for transfer via VNC or Remote Desktop - see *Accessing Your Unit Remotely* on page 155)

Managing Data

Viewing Disk Space and Managing Files

Viewing Disk Space and Managing Files

To help you manage the data that is stored on your unit, you can easily view the remaining disk space. You can also copy, move, rename, delete files and folders directly from your unit.

To view the free disk space, and manage files and folders:

1. From the main window, click the **Utilities** button.
2. Click **File Manager**.

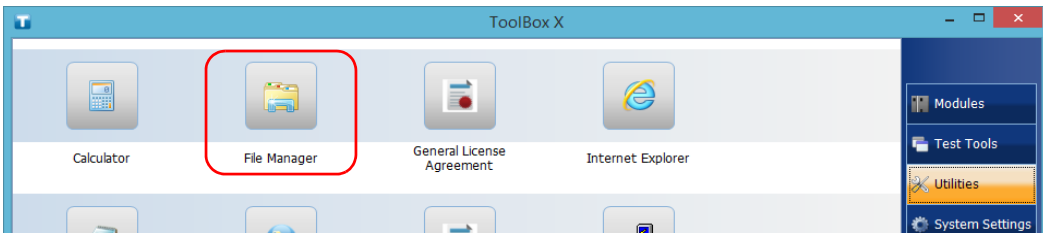

The file explorer is displayed.

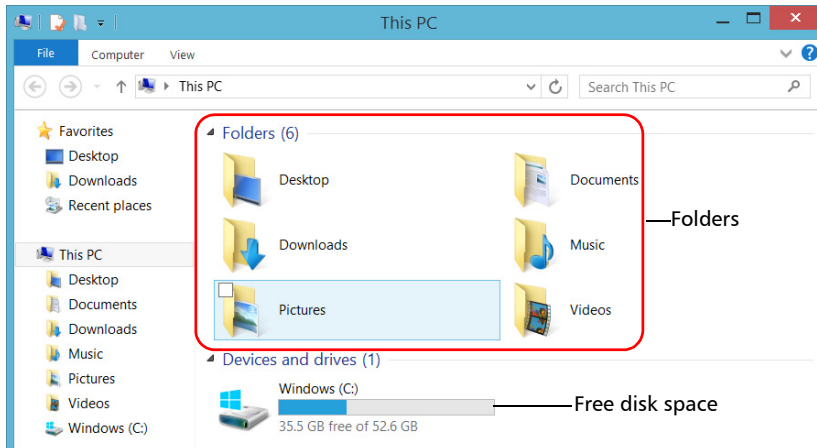

Note: The free disk space is also visible from the **Platform** tab (click  in the lower right corner of the main window).

Freeing Up Disk Space with the Disk Cleanup Utility

If you need to free up disk space on your unit, you can use the Windows Disk Cleanup utility.

With this utility, you can clear files such as the Internet temporary files, files from the Recycle bin, or even files that you no longer need from the previous installation. The files from the previous installation are stored in the *Windows.old* folder that Windows creates automatically when you perform a refresh operation. To avoid losing data, you may want to back up files from this folder before removing it.

To free up disk space with the Disk Cleanup utility:

1. If desired, back up your data.

Note: *If you want to have a look at the content of the Windows.old folder containing files of the previous installation, go to the root of the C drive (Windows (C:)). If you do not see the Windows.old folder, it means no refresh operation has ever been performed on your unit.*

2. From the main window, click the **System Settings** button.

Managing Data

Freeing Up Disk Space with the Disk Cleanup Utility

3. Click **Control Panel**.

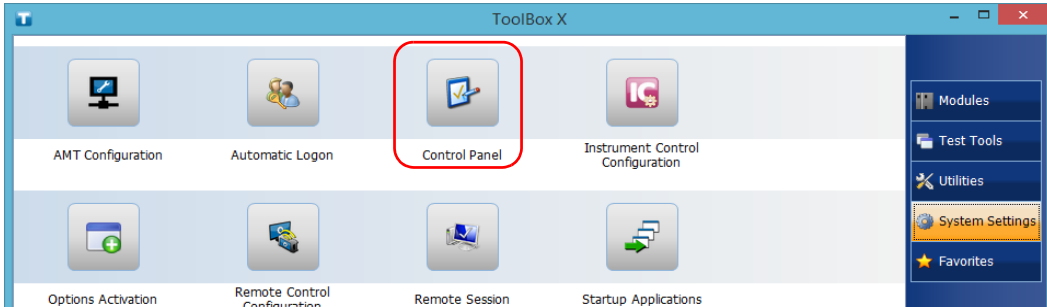

4. Click **System and Security**.

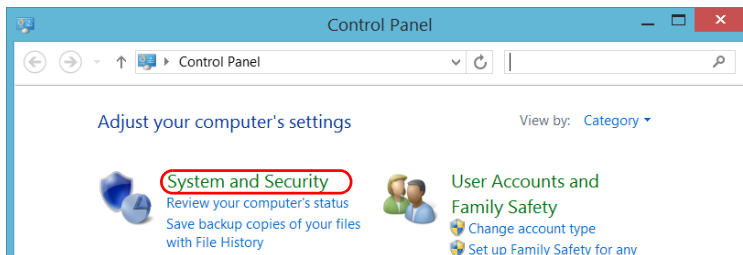

5. Click Administrative Tools, and then double-click Disk Cleanup.

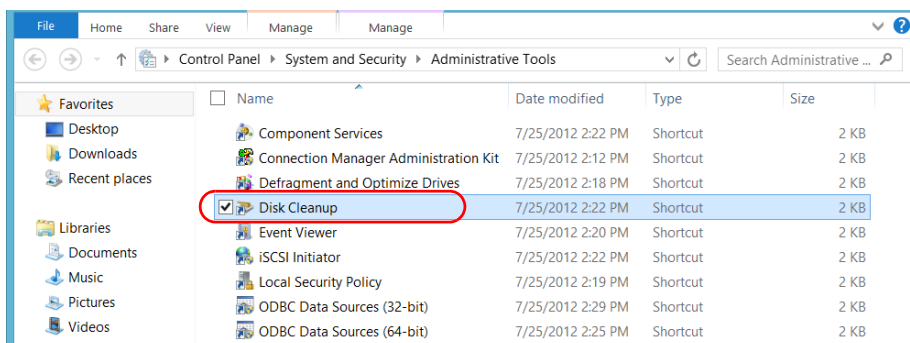

6. If you want to remove system files such as the files from the Windows.old folder, click Clean up system files.

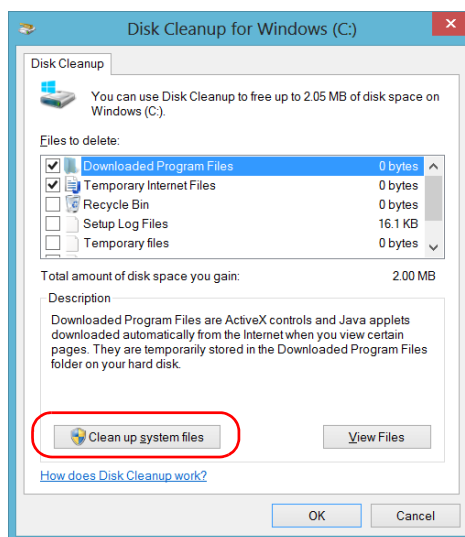

Managing Data

Freeing Up Disk Space with the Disk Cleanup Utility

- When the folders are displayed, select the check box corresponding to the desired item. If you want to clear the Windows.old folder, select the **Previous Windows installation(s)** check box. Ensure that all the other check boxes are cleared.

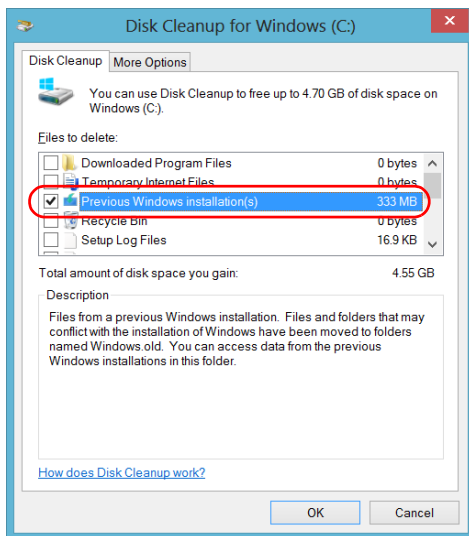

Note: If you cannot see the **Previous Windows installation(s)** check box, this means that no refresh operation has been made on your unit yet.

- Click **OK**.
- When the application prompts you to confirm the deletion of the folder, click **Delete Files**.

Connecting to a VPN from Your Unit

Note: *Only administrator-level users can install software under Windows. However, when the installation is complete, all users have the possibility to connect to the newly installed VPN from the unit.*

You can connect to a Virtual Private Network (VPN) from your unit if you use one of the VPN clients (applications) that are part of Windows, or provide your own compatible VPN client. Such clients allow you to connect to the VPN of your company from anywhere in the world and have access to network resources as if your unit was connected locally to the network. This could be useful if you need to transfer data to a centralized folder on the company's private network, for example.

To establish the communication between the VPN client and the VPN server, you can use a standard Ethernet connection.

Note: *Since all networks are different, the parameters that you need to configure before being able to connect to the VPN may vary. For information on the configuration specific to your network, contact your network administrator.*



IMPORTANT

EXFO does not provide any VPN clients. You must either use one of the VPN clients available directly in Windows or provide the installation files for another VPN client yourself.

EXFO will not provide any support regarding the VPN clients or connection.



IMPORTANT

To avoid communication problems between the VPN client and the VPN server, ensure that the date set on your unit corresponds to the current date.

Managing Data

Connecting to a VPN from Your Unit

To add a VPN connection:

1. From the main window, tap the **System Settings** button.
2. Click **Control Panel**.
3. Click **Network and Internet**.

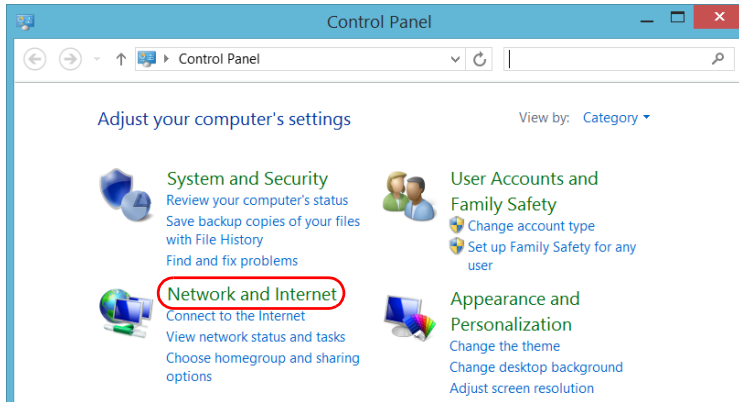

4. Under **Network and Sharing Center**, click **View network status and tasks**.

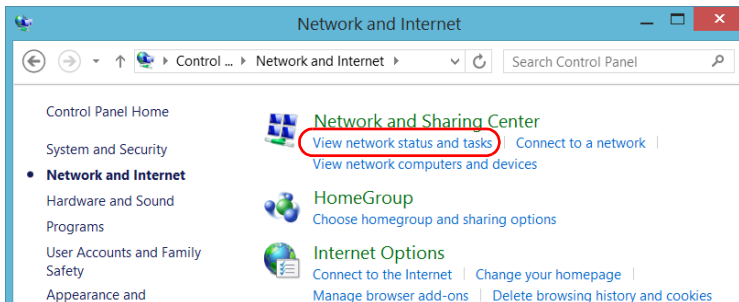

5. Click *Set up a new connection or network*.

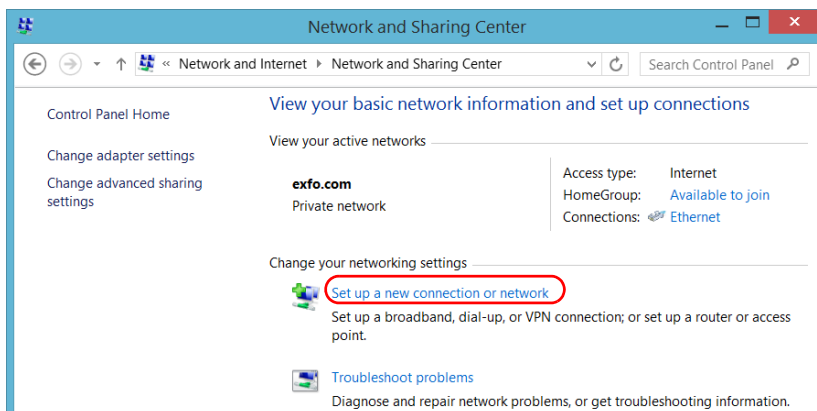

6. Click *Connect to a workplace*, and then tap *Next*.

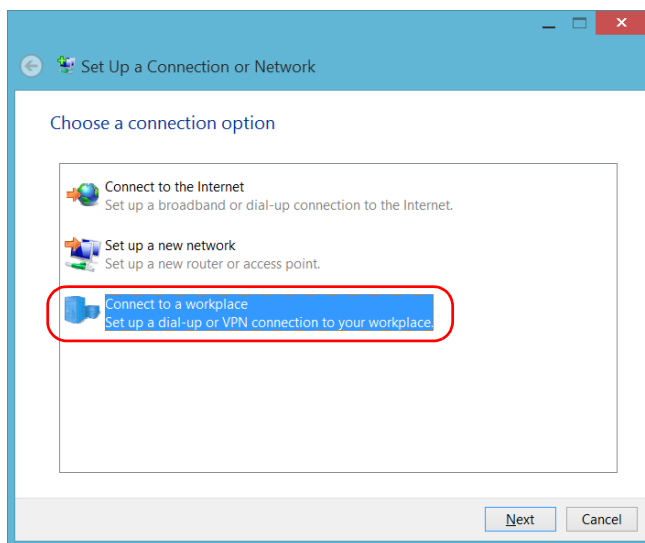

7. Follow the on-screen instructions.

Managing Data

Connecting to a VPN from Your Unit

To install a VPN client on your unit:

1. Start the installation of the VPN client using the files and settings provided by your network administrator.
2. Follow the on-screen instructions.

Once the installation is complete, all users will now be able to connect to a VPN from the unit.

To connect to a VPN from your unit:

1. From the main window, click the **System Settings** button.
2. Click **Control Panel**.

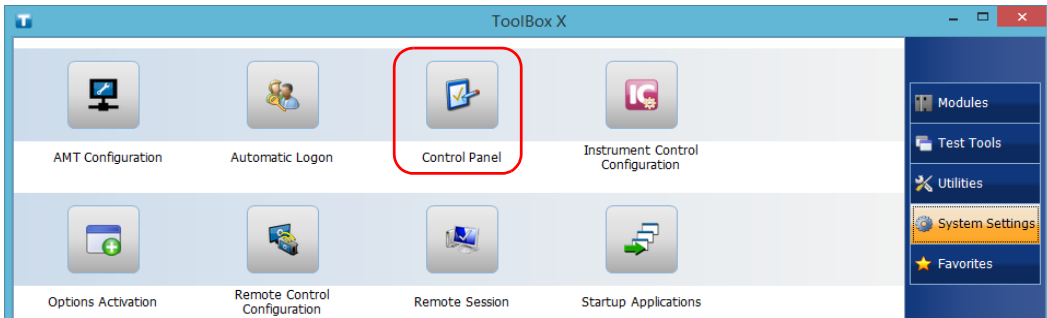

3. Click **Network and Internet**.

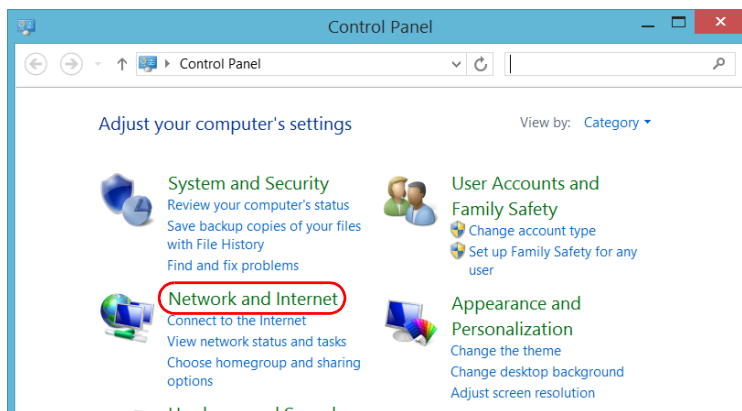

4. Under **Network and Sharing Center**, click **Connect to a network**.

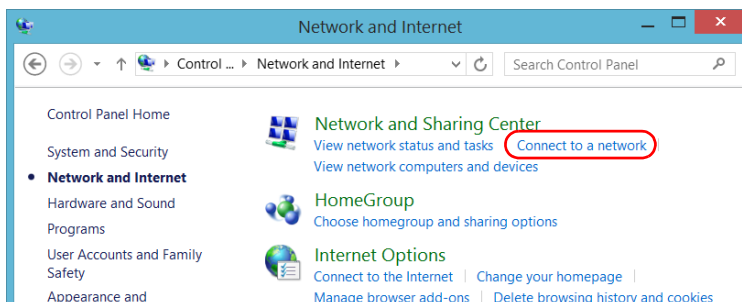

Managing Data

Connecting to a VPN from Your Unit

5. From the list displayed at the right of the screen, select the desired VPN connection.

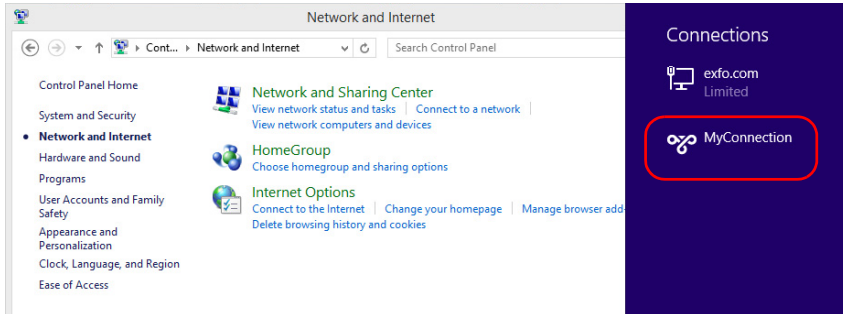

6. If your unit is running Windows 10, a new window will open. Select the desired VPN connection from the list.
7. Click **Connect**.
8. Enter your sign-in information to the VPN, and then click **OK**.

If you are not sure about the information that you should provide, contact your network administrator.

9 **Accessing Your Unit Remotely**

You can access your unit remotely from a computer using either the Remote Desktop Connection application or a VNC viewer.

This could be particularly useful if you do not intend to perform automation tasks on your platform. If you prefer to perform automation tasks on your platform and modules, see *Preparing for Automation* on page 179, *Using Your Unit and Modules in an Automated Test Environment* on page 227, or *Configuring Your Instruments* on page 219.

If you want to access your modules from a multiuser and multiplatform environment, refer to the user documentation of EXFO Multilink.

If you want to access your unit for maintenance or troubleshooting purposes, see *Working with Intel Active Management Technology* on page 119.

Accessing Your Unit Remotely

The table below presents the differences between the Remote Desktop Connection application and a VNC viewer.

Characteristic	Remote Desktop Connection	VNC Viewer
Type of connection	Direct between the unit and the computer; only one user can be connected to the unit at a time. Usually, the connection is made with the user name of the person currently logged on the unit. Otherwise, this person will be automatically disconnected.	Not exclusive; several users can be connected to the unit at the same time (sharing the same session).
Windows user rights	Taken into account.	Not taken into account.
Password-protected	Yes; mandatory. The user name and password are the same as those used to connect to the unit. By default, all the accounts with administrator rights can use Remote Desktop Connection. If you want accounts with limited rights to be able to use Remote Desktop as well, you must specifically grant them access.	Yes; mandatory. You must define a password on the UltraVNC Server the first time you start the server. By default, all people that use the UltraVNC Viewer (or another VNC viewer) will enter the same password (as defined on the server). Each user to whom you provide the password will be able to connect to the unit via VNC.

Working with Remote Desktop

By default, the remote access to your unit with Remote Desktop is not enabled. However, once you enable it, all the accounts with administrator rights can use Remote Desktop. If you want accounts with limited rights to be able to use it as well, you must specifically grant them access.

You can also configure the unit to prevent users from accessing it remotely.

Accessing Your Unit with Remote Desktop

To be able to connect to the unit using Remote Desktop, you must:

- Allow the remote access to your unit (only necessary the first time that you access your unit with Remote Desktop).
- Know the IP address of the unit and provide it in the connection settings on the computer.

Note: *If your unit and the computer are on the same network, you can even use the computer name of your unit, followed by its serial number. You can view the computer name of your unit from **System Settings > Remote Session > Computer Name**.*

- Use an account that is secured by a password. Remote Desktop will not allow any connection with empty passwords.
- Enter the appropriate user name when Remote Desktop application prompts you. Usually, this user name must correspond to the user name of the person currently logged on the unit. Otherwise, you will disconnect the person that was already connected.

Accessing Your Unit Remotely

Working with Remote Desktop

To allow the remote access to your unit with Remote Desktop:

1. From the main window, click the **System Settings** button.
2. Click **Remote Session**.

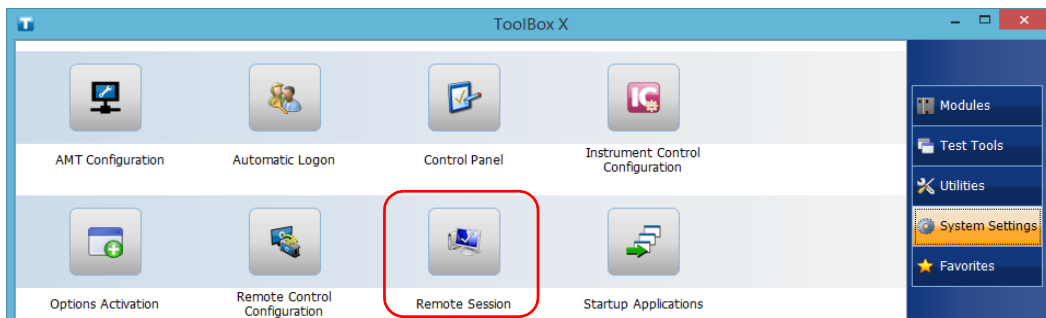

3. Under **Remote Desktop**, select **Allow remote connections to this computer**.

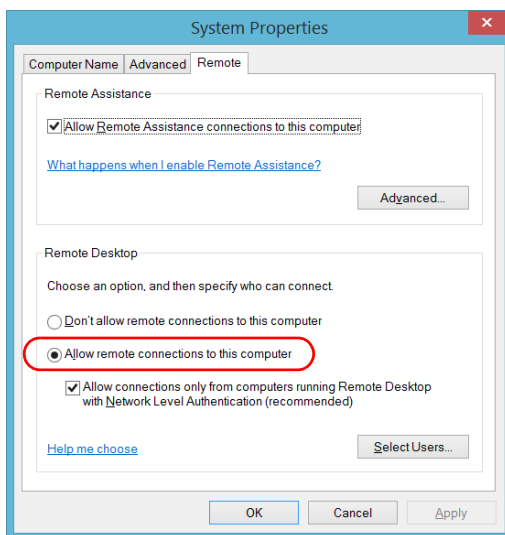

4. Click **OK** to confirm the changes and return to the **System Settings** window.

To access your unit remotely with Remote Desktop:

1. Connect both the computer and your unit to the same network and make sure they can “see” each other as network restrictions might prevent them from communicating.
2. Turn on both the computer and the unit.
3. On your unit, from Toolbox X, click the  button (located at the bottom of the button bar).
4. Select the **Platform** tab, write down the IP address, and then close the window.

Note: *It may take a few seconds before you see the IP address on the list.*

5. From the computer, open the Remote Desktop Connection window.
 - If your computer runs Windows Vista or Windows 7: On the taskbar, click **Start**, then select **All Programs > Accessories > Remote Desktop Connection**.
 - If your computer runs Windows 8: On the taskbar, point the lower left corner, and then click the **Start** screen icon. Right-click the bottom of the screen, and then click **All apps**. Under **Windows Accessories**, select **Remote Desktop Connection**.
 - If your computer runs Windows 8.1 or Windows 10: On the taskbar, click the **Start** button () , then under **Windows Accessories**, select **Remote Desktop Connection**.

Accessing Your Unit Remotely

Working with Remote Desktop

6. In the **Connecting to Remote Desktop** window, in the **Computer** list, type the IP address of the unit that you wrote down at step 4.

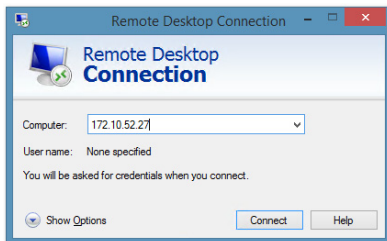

7. Click **Connect**.
8. When the application prompts you, enter your user name and password.
9. Click **OK** to open the session.

Allowing Users with Limited Accounts to Use Remote Desktop

By default, only the accounts with administrator rights can use Remote Desktop. However, you can assign extra user rights to accounts with limited rights so that they can also use Remote Desktop.

To allow a user with limited accounts to use Remote Desktop:

1. From the main window, click the **System Settings** button.
2. Click **Remote Session**.

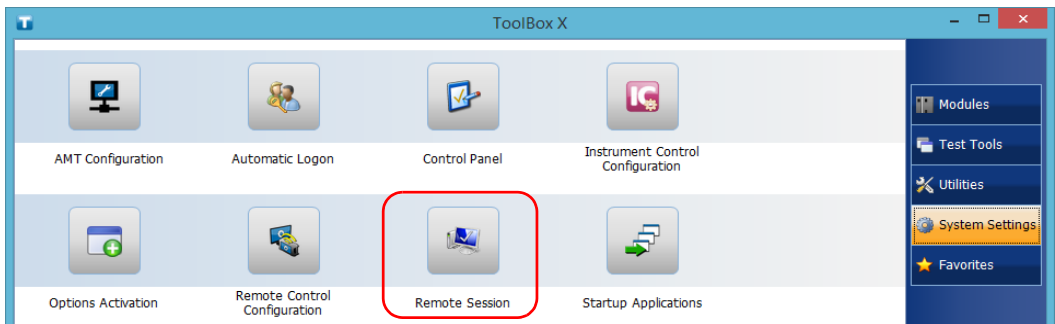

Accessing Your Unit Remotely

Working with Remote Desktop

3. Under **Remote Desktop**, select **Allow remote connections to this computer**.

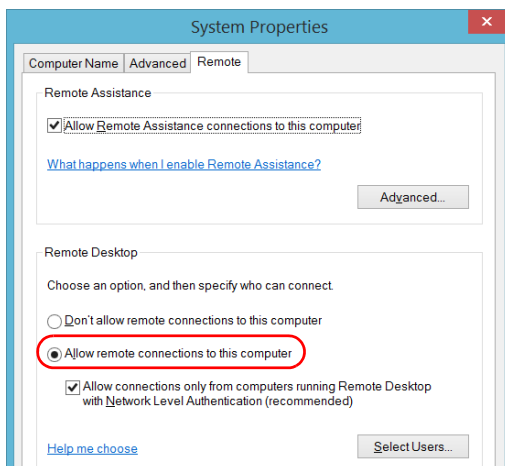

4. Click **Select Users**.

5. From the **Remote Desktop Users** dialog box, click **Add**.

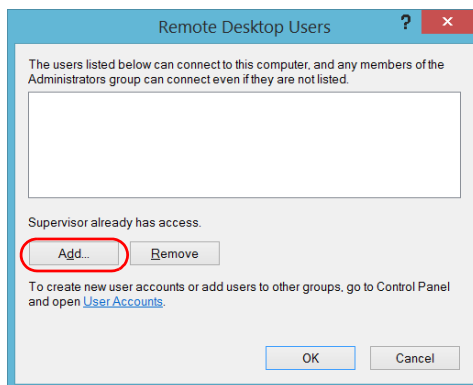

6. From the **Select Users** dialog box, click **Advanced**.

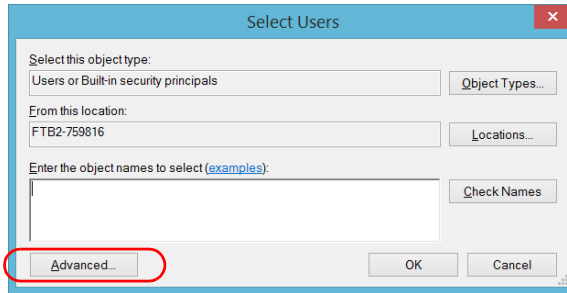

7. Click **Find Now** to let the system find and display the list of users.

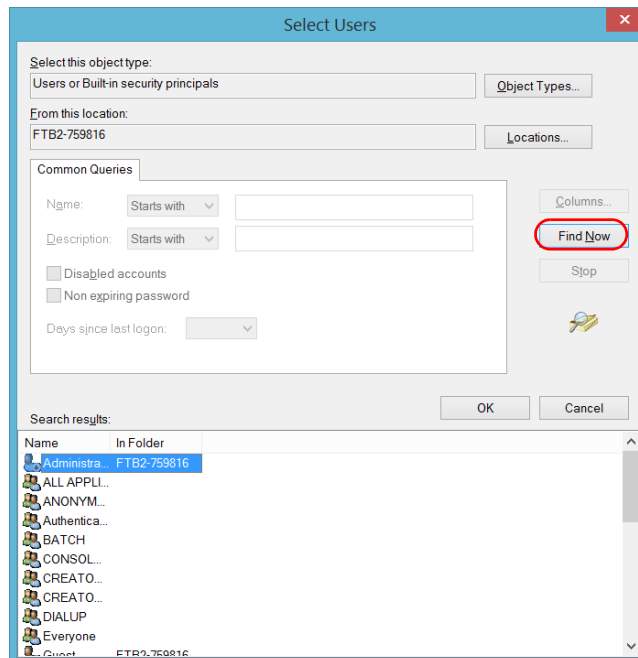

8. Select the user to which you want to grant access rights, and then click **OK**.

Accessing Your Unit Remotely

Working with Remote Desktop

9. From the list of users, select the user that you have just added, and then click **OK**.

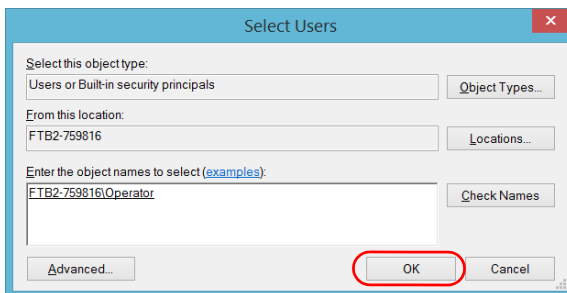

10. Repeat steps 7 to 9 with all the users to which you want to grant access rights.
11. From the **Remote Desktop Users** dialog box, click **OK**.
12. From the **System Properties** dialog box, click **OK** to confirm the changes and return to the **System Settings** window.

Preventing Users from Connecting with Remote Desktop

You can also configure the unit to prevent users to access it using Remote Desktop. However, all users having administrator user rights will be able to modify this setting at any time.

To prevent users from connecting to the unit using Remote Desktop:

1. From the main window, click the **System Settings** button.
2. Click **Remote Session**.

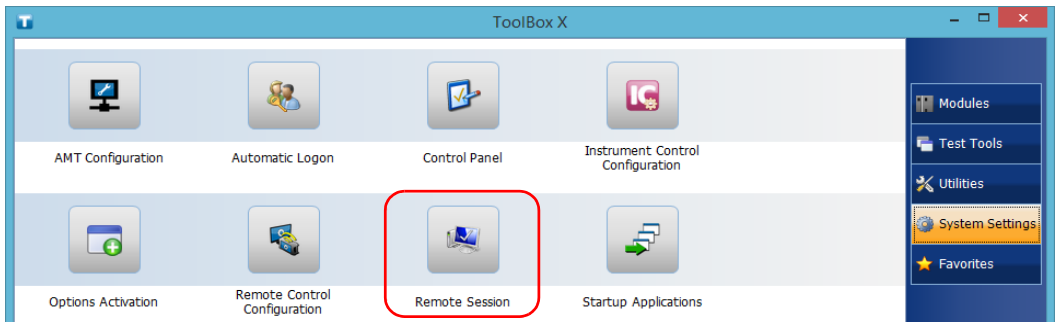

Accessing Your Unit Remotely

Working with Remote Desktop

3. Under **Remote Desktop**, select **Don't allow remote connections to this computer**.

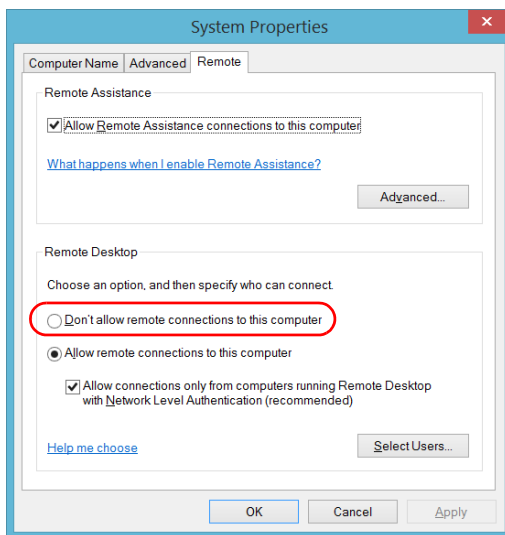

4. Click **OK** to confirm the changes and return to the **System Settings** window.

Working With VNC

The control of your unit with VNC requires the UltraVNC Server (already installed on your unit) and a VNC viewer (that you must install on your computer).

To be able to connect to the unit using VNC, you must:

- Know the IP address of the unit and provide it in the connection settings on the computer.
- Know the password (same for all users by default).

This section provides you with the basic information to control your unit with VNC.

Accessing Your Unit Remotely

Working With VNC

Configuring the VNC Server

The UltraVNC Server is already installed on your unit. By default, the server is configured to accept secured connections only. This means that you must configure a password before establishing a connection between a computer and your unit.

You can modify various connection settings to better suit your needs.

To configure the VNC Server:

1. From the main window, click the **System Settings** button.
2. Click **UltraVNC Server**.

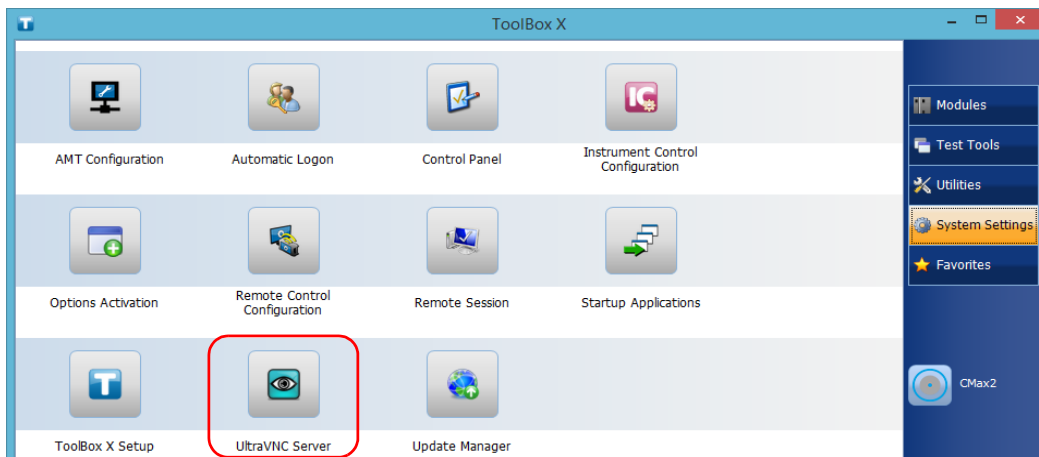

3. From the notification area, right-click the UltraVNC icon.



4. From the shortcut menu, click **Admin Properties**.
5. Depending on the type of connection that you want, under **Authentication**, enter a value in the **VNC Password** or **View-Only Password** box.

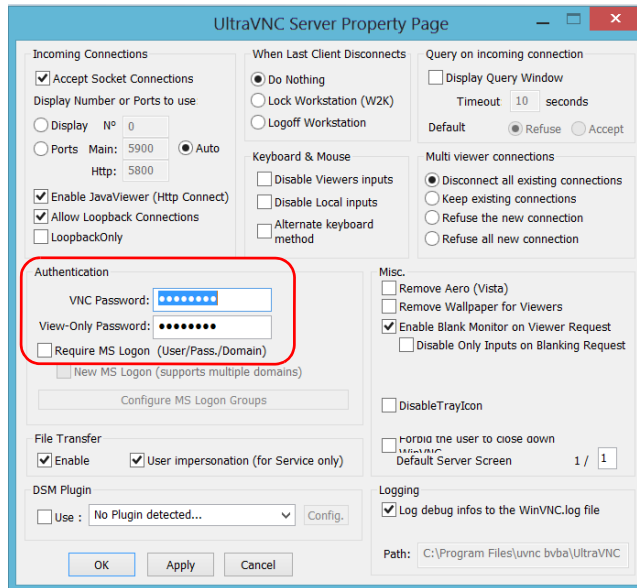

Note: The VNC and view-only passwords are independent of each other. They do not have to be identical.

6. Click **Apply**, and then **OK**.

Installing the VNC Viewer on a Client Computer

If no VNC viewer is already installed on your computer, you can download the UltraVNC Viewer from the Web for free.



IMPORTANT

EXFO does not provide licenses for UltraVNC Viewer. Always ensure that you are entitled to install it on your computer.

To install the UltraVNC Viewer on your computer:

1. Open a Web browser and go to <http://www.uvnc.com/downloads/ultravnc.html>.
2. Download the version of the viewer that corresponds to the operating system that your computer is running.
3. Double-click the file that you have just downloaded to start the installation.
4. Follow the on-screen instructions.

Connecting to Your Unit with VNC

Once the UltraVNC Viewer is installed on your computer, you are ready to access your unit remotely.

To connect to your unit with UltraVNC:

1. Connect both the computer and your unit to the same network and make sure they can “see” each other as network restrictions might prevent them from communicating.
2. Turn on both the computer and the unit.
3. On your unit, ensure that ToolBox X is open.
4. At the bottom of the button bar, click .
5. Click **Platform**.

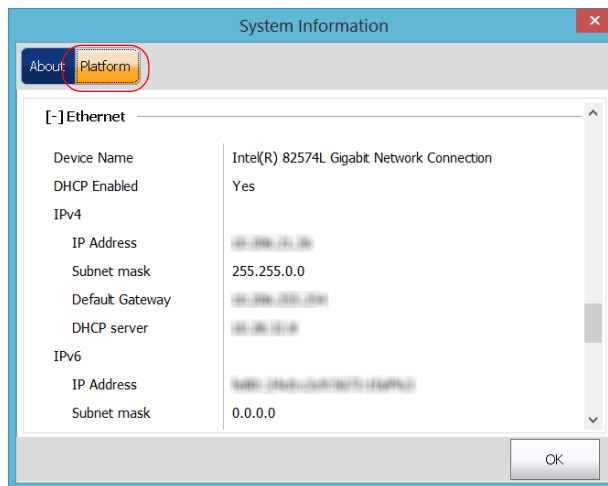

6. Scroll down until you can see the IP address.
7. Write down the IP address, and then close the window.

Note: It may take a few seconds before you see the IP address on the list.

Accessing Your Unit Remotely

Working With VNC

- From the main window, click the **System Settings** button.
- Click **UltraVNC Server** to start the server.

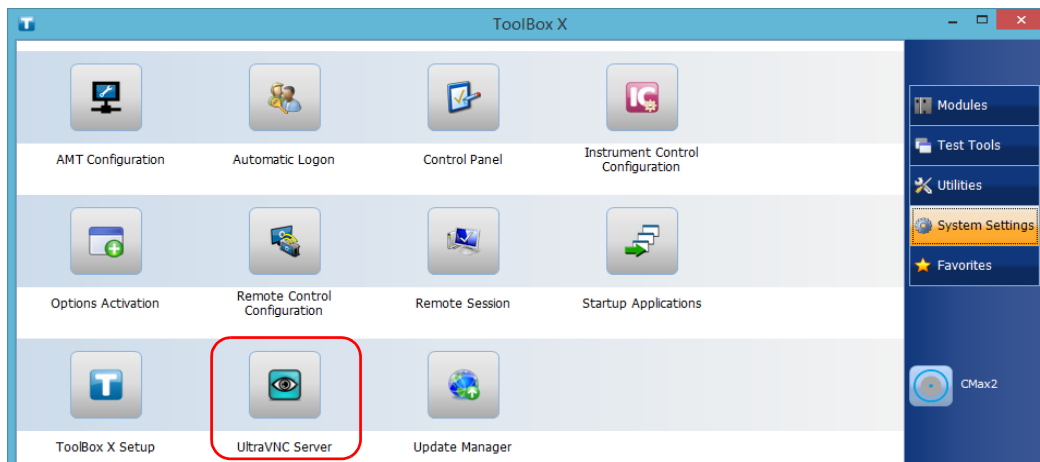

Note: For security reasons, the UltraVNC Server is not started automatically. However, if you prefer that your unit remains ready for remote connections at all times, you can install the corresponding service (right-click the UltraVNC icon, and then click **Install Service**). Refer to the Web site of UltraVNC (<http://www.uvnc.com>) for more information.

- From your computer, start the UltraVNC Viewer.

- 11.** In the **VNC Server** list, type the IP address of your unit that you wrote down at step 7.

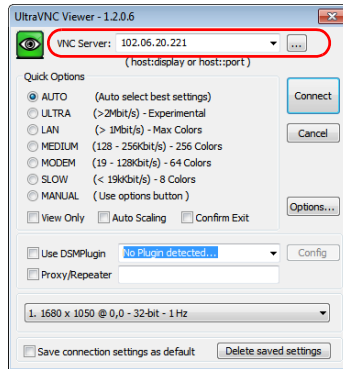

Note: *The appearance of the UltraVNC Viewer window may vary depending on the version of the viewer that you have.*

- 12.** Click **Connect**.
- 13.** When the application prompts you for a password, enter it and click **OK** to confirm.

Accessing Your Unit Remotely

Adding Exceptions to the Firewall

Adding Exceptions to the Firewall

Note: Only administrator-level users can add exceptions to the firewall.

Your unit is protected by the Microsoft firewall to prevent unauthorized access when it is connected to a network or to the Internet. The firewall has been preconfigured so that all the applications that come with your unit work properly. However, you can allow other applications to access the network or the Internet by adding exceptions.

If you are not sure about how to configure the firewall, contact your network administrator.

To add exceptions to the firewall:

1. From the main window, click the **System Settings** button.
2. Click **Control Panel**.

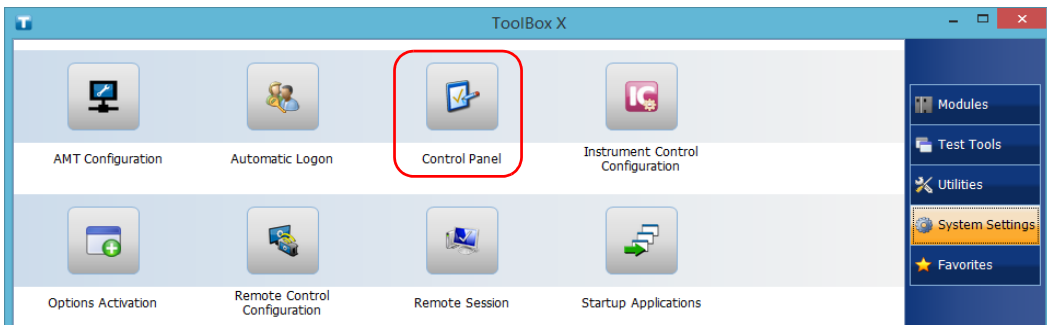

3. Click **System and Security**.

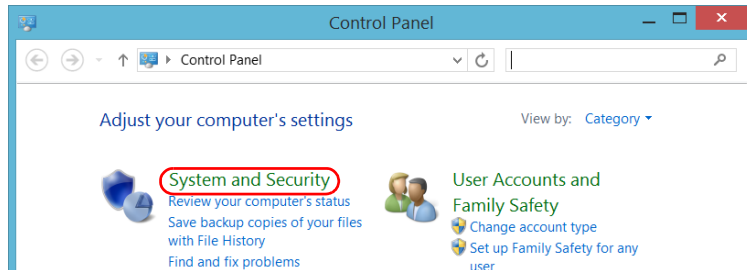

4. Under **Windows Firewall**, click **Allow an app through Windows Firewall**.

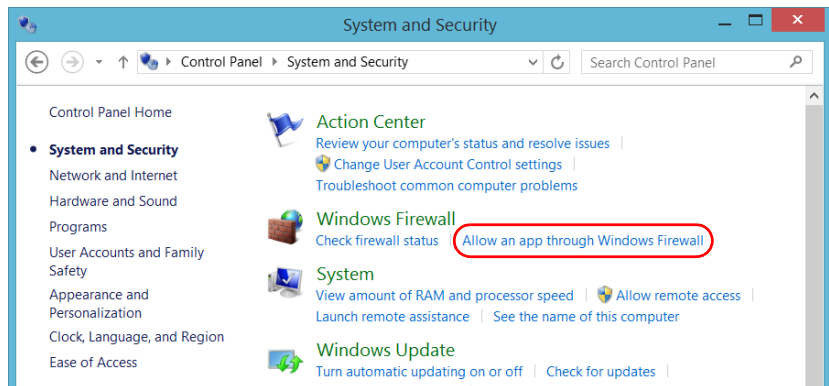

5. Click the **Change settings** button.

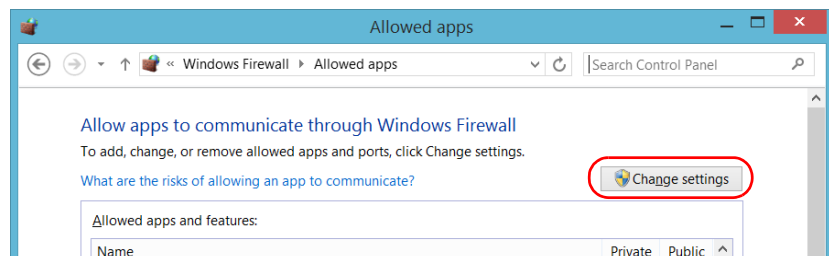

Accessing Your Unit Remotely

Adding Exceptions to the Firewall

- Click the **Allow another app** button.

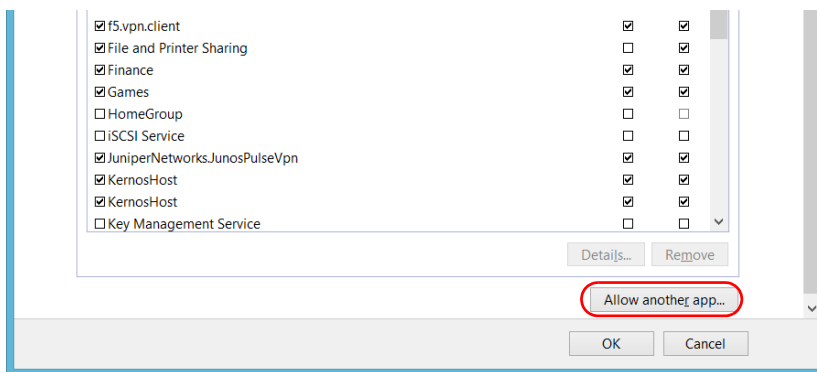

- Select the desired application from the list, and then click **Add**.

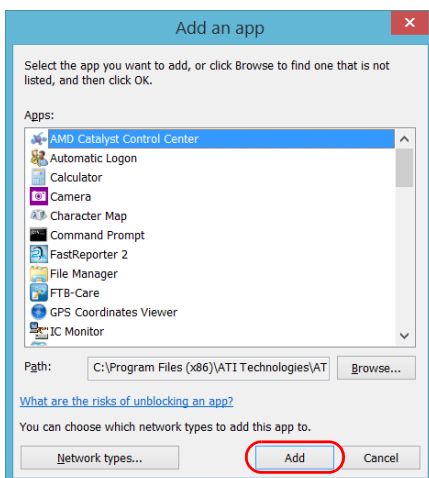

8. Ensure that the **Private** and **Public** settings of the added application suit your needs.

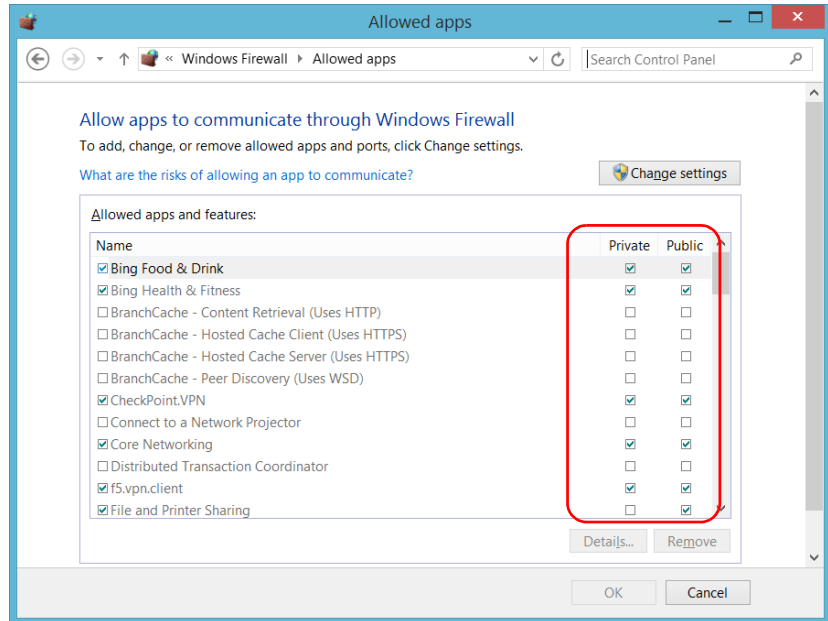

9. When you have finished, click **OK** to confirm the changes and return to the **Control Panel** window.

10 Preparing for Automation

Your unit was designed to meet the requirements of automation and to facilitate its integration with your test environment.

EXFO supplies commands that follow the guidelines determined by the SCPI consortium for many instruments. EXFO also supplies COM properties and events allowing you to build your own application. The instruments can be controlled either locally or remotely via the following technologies:

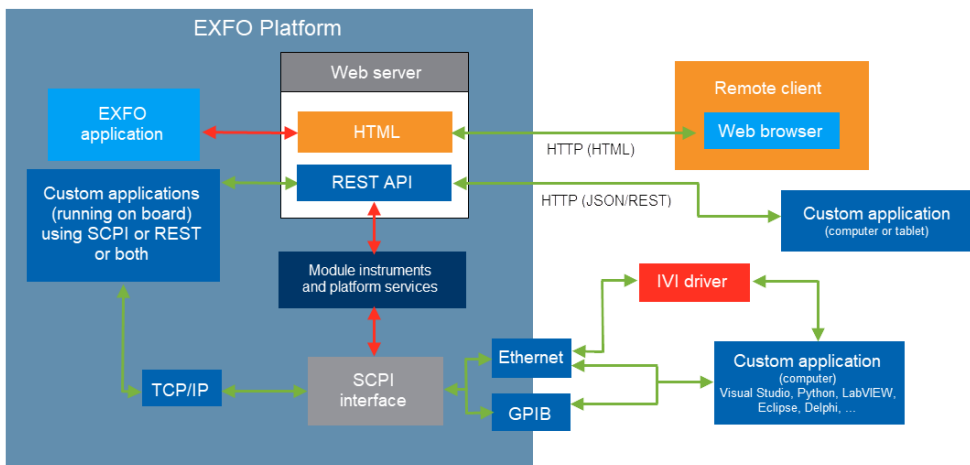

The choice of a technology depends on your particular needs.

Communication	Characteristics
ActiveX (COM)	<ul style="list-style-type: none"> ➤ Allows you to develop an application that will run locally on your unit within Windows. ➤ Best approach when speed is your top priority (no physical connection that slows down the process). ➤ Supported by most development software. ➤ Lower cost.
ActiveX (DCOM) (Ethernet, TCP/IP)	<ul style="list-style-type: none"> ➤ Allows the sharing of network resources. ➤ Allows you to develop computer-based applications to directly communicate with your unit.

Preparing for Automation

Communication	Characteristics
GPIB	<ul style="list-style-type: none">➤ The optional USB/GPIB adapter must be connected to the unit.➤ The unit can be used as a device in a GPIB chain (it meets the IEEE 488.2 standard).➤ A single GPIB address allows you to control up to 100 logical instruments.➤ Most commonly used interface to simultaneously control many instruments.
RS-232	<ul style="list-style-type: none">➤ For LTB-8: Null-modem cable or USB to RS-232 adapter required to establish connection between the computer and your unit. For LTB-2/LTB-12: USB to RS-232 adapter (purchased from EXFO) required to establish connection between the computer and your unit.➤ For increased speed and performance, run the application locally on your unit through ActiveX instead of using RS-232.
Telnet and Socket (Ethernet, TCP/IP)	<ul style="list-style-type: none">➤ Your unit can be directly connected to a Local Area Network (LAN) or Wide Area Network (WAN) via its 10/100/1000 Base-T interface.➤ Allows the sharing of network resources.➤ Allows you to develop computer-based applications very easily to directly communicate with your unit.➤ Telnet allows you to send SCPI commands using a Telnet terminal window.➤ Socket allows you to send the same SCPI commands as you would in Telnet, but without any formatting (raw communication). The socket communication is similar to a communication by GPIB or RS-232.

For more information on programming aspects, see the section on using your product in an automated test environment.

Preparing Hardware for GPIB Control

If you intend to use GPIB to remotely control your instruments, you must first connect the optional USB/GPIB adapter sold by EXFO.

To ensure the optimum efficiency of your system, EXFO recommends that you follow these restrictions:

For the IEEE 488.1 protocol:

- Maximum of 15 devices physically connected to each GPIB bus.
- Maximum separation of 4 m between two devices and an average separation of 2 m over the entire range (bus).
- Maximum total cable length used in the system is 20 m.
- At least two-thirds of the connected devices must be turned on.

For the HS488 protocol:

- Maximum of 15 devices physically connected to each GPIB bus.
- Maximum total cable length used in the system is 15 m (that is, 1 m per device physically connected to the GPIB bus).
- All connected devices must be turned on.
- For each meter of cable used in the system, there must be a device connected to it or an equivalent device load.

Preparing for Automation

Preparing Hardware for GPIB Control

The unit's configuration complies with the IEEE 488.1 (also known as IEC60625.1) and the IEEE 488.2 (also known as IEC60625.2) standards to the extent shown in the following table.

Mnemonic	Function
SHE1 ^a	Complete source handshake extended capability
AHE1 ^b	Complete acceptor handshake extended capability
T6	Basic talker with serial poll; unaddressed to talk if addressed to listen
L4	Basic listener; unaddressed to listen if addressed to talk
SR1	Complete service request capability
RL2	No local lockout capability
PP0	No parallel poll capability
DC1	Complete Device Clear capability
DT0	No Device Trigger capability
C0	No controller capability
E2	Three-state driver capability

- a. SHE1 corresponds to the extended capability of SH1, defined in the IEEE 488.1 standard. This extended capability is made possible by the device capability to use the HS488 high-speed protocol.
- b. AHE1 corresponds to the extended capability of AH1, defined in the IEEE 488.1 standard. This extended capability is made possible by the device capability to use the HS488 high-speed protocol.

Linking Units with the GPIB Port

Your unit is not equipped with a GPIB port, but you can connect a USB to GPIB adapter (sold by EXFO) to one of the USB ports of your unit if you wish to send and receive data via GPIB.

Linking Units with an Ethernet Port

Your unit is equipped with Ethernet ports (10/100/1000) to send and receive data. Refer to the Windows documentation for information about Ethernet port settings and possibilities.

LTB-2

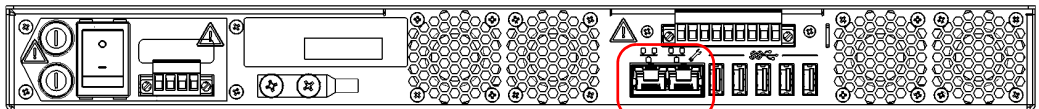

Ethernet (RJ-45) ports

LTB-8

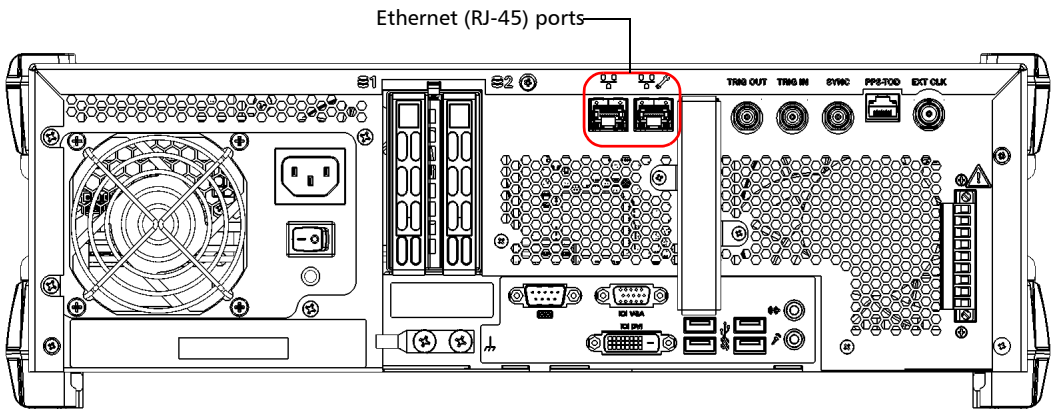

Ethernet (RJ-45) ports

Preparing for Automation

Linking Units with an Ethernet Port

LTB-12

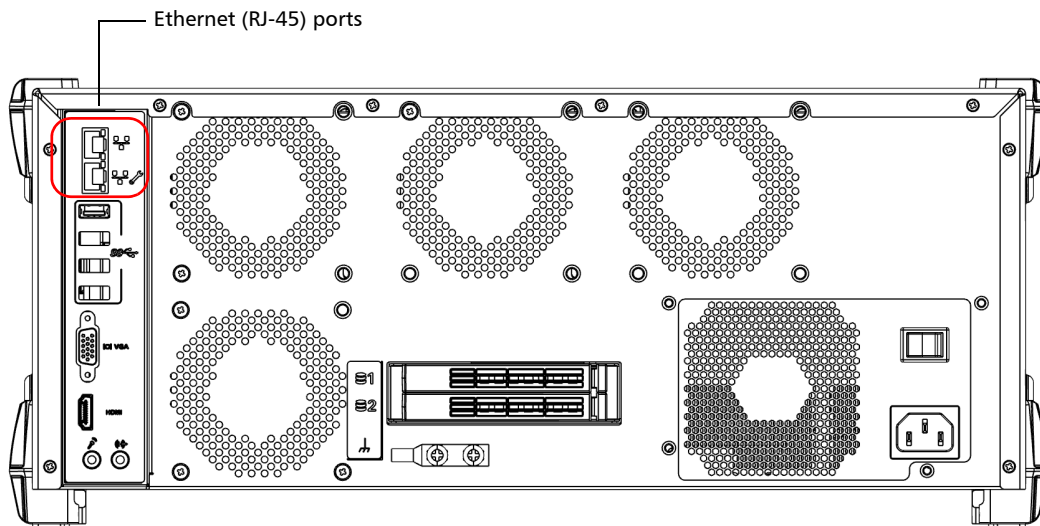

Linking Units with the Serial Port

Your LTB-8 unit is equipped with a serial (RS-232) port to send and receive data. Even though your LTB-2/LTB-12 unit is not equipped with a serial (RS-232) port, you can connect a USB to RS-232 adapter (sold by EXFO) to your one of the USB ports of your unit if you wish to send and receive data via RS-232. Refer to the Microsoft Windows documentation for information about serial port settings and possibilities.

LTB-8

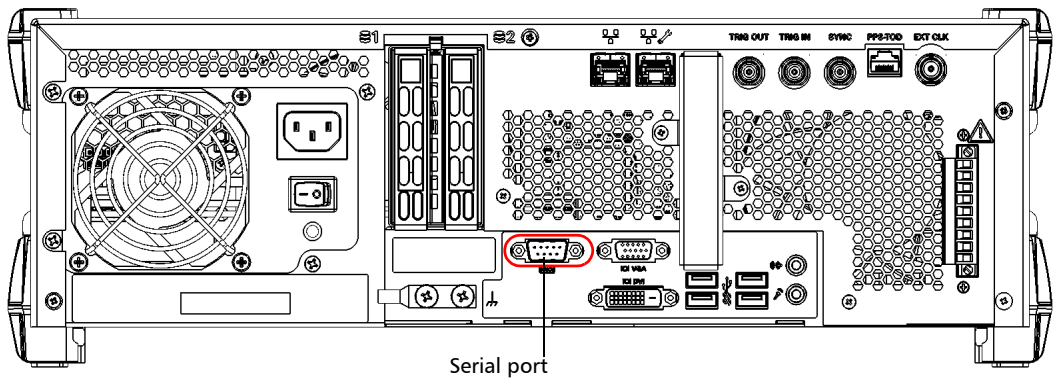

Getting Optimum Performance from Your Unit

Several factors influence the data transfer rate of your unit. The information presented hereafter will help you get the best transfer rate possible.

- *Protocol (GPIB control only):* You can use the IEEE 488.1 (standard) or the HS488 (high-speed) protocol. Both protocols can co-exist in the same system; communication between devices can then be achieved using the IEEE 488.1 protocol.

HS488 is a non-interlocked handshake protocol that allows data transmission between devices at higher rates (six to seven times faster for small systems) than those possible with the IEEE 488.1 protocol. Higher transfer rates are particularly interesting in systems containing devices that return long data blocks. However, the transfer rate is affected by the physical limitations of the cables used in the system.

For information on cabling, see *Preparing Hardware for GPIB Control* on page 181.

- *Bus timing (GPIB control only):* Required if you intend to work with IEEE 488.1, for it affects the handshake rate of this protocol. It indicates the minimum amount of time a GPIB controller waits, once data is placed on the bus, before setting the data valid bus line (DAV) to true.

The possible bus timings are:

Mode	Bus timing delay
Normal	1100 ns
High speed	500 ns
Very high speed	350 ns

If your setup supports it, select the very-high-speed timing to get the best performance.

- *Output unit (GPIB, RS-232, ActiveX and TCP/IP):* Your unit can return results in
 - linear units (for example, watts)
 - log units (for example, dBm)

Since internal units are linear, you will get optimal performance by using linear units for output (no need for an internal conversion to log).

Note: *You must make the choice of output unit for each instrument offering such a feature. Refer to the user guide of each optical instrument for a list of available commands and queries.*

- *Output format (GPIB, RS-232, ActiveX and TCP/IP):* Your unit provides the measurement results in ASCII format.

Note: *The configuration of data format cannot be made directly via the ToolBox X software.*

For more information on how to set the output format and data types, see *:FORMat[:DATA]* (IEEE 488.2 and specific commands appendix), *Read* and *ReadBinary* (COM properties and events appendix), and the data types appendix.

Preparing for Automation

Enabling or Disabling Compatibility With Legacy IQS Programs

Enabling or Disabling Compatibility With Legacy IQS Programs

To better suit your testing needs, you can make your unit compatible with automation programs that were developed on IQS legacy platforms.

When you enable this feature, the Legacy Compatibility application automatically sets the following parameters to the appropriate values:

Parameter	Value
LINS offset value	10
Remote control	Activated on all modules
Automation	Allowed on all modules
Communication type	TCP/IP

Note: *The LINS value that you would use to reach a specific module corresponds to the LINS offset value (10, in compatibility mode)+ the slot number into which the module is inserted. For example, if the module that you want to use is in the first slot (slot 0, in this case), you would use 10 (10+ 0). For the module in the second slot, you would use 11 (10 +1), and so on.*

Note: *If you disable the feature, the LINS offset value will be reverted to 0. The other parameters listed above will remain as they are.*

Note: *When you enable the feature, the identification of the FTBx modules in the system will change to “IQS” if these modules support it. If you disable the feature, the identification of the modules will be reverted to “FTBx”.*

By default, the compatibility feature is not enabled on your unit.

To enable or disable compatibility with legacy IQS programs:

1. From ToolBox X, click the **System Settings** button, then click **Legacy Compatibility**.
2. Select the **Enable legacy compatibility mode** check box to enable the feature. Clear the check box if you want to disable the feature.

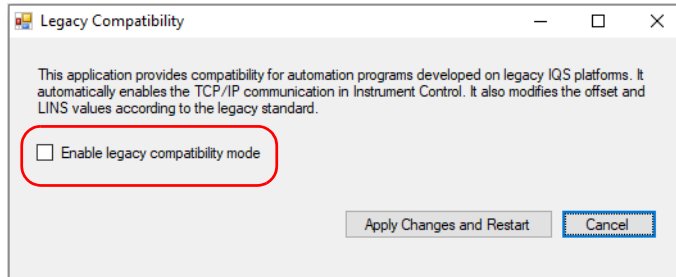

3. Click the **Apply Changes and Restart** button to confirm the operation. Your unit will restart to complete the configuration.

Preparing for Automation

Changing Communication Settings

Changing Communication Settings

Communication settings cannot be modified without turning on your unit and starting ToolBox X.

To change communication settings:

1. Click the **System Settings** button, then click **Instrument Control Configuration**.

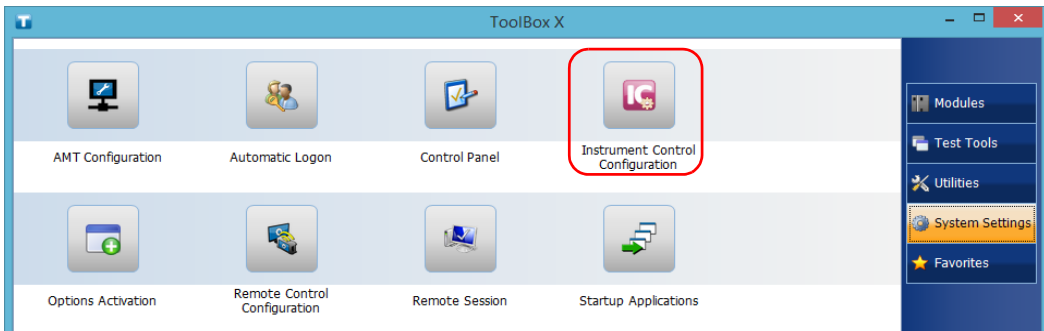

2. Click **Change settings**, and then, when the application prompts you to authorize the changes to your unit, click **Yes**.

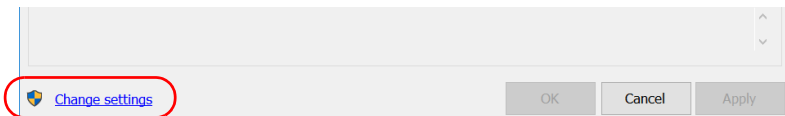

3. If you want to send SCPI commands to your modules, select the **Allow automation on instruments** check box. Clear the check box if you prefer to block automation on your unit.

Note: *If you allow automation, all modules in your unit will be initialized upon startup so you are ready to send remote commands.*



IMPORTANT

Before being able to control instruments with SCPI commands, you must also allow remote access to these instruments. For more information, see *Configuring Your Instruments* on page 219.

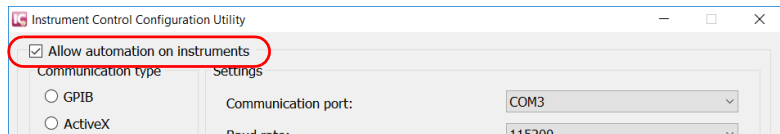

If you cleared the check box because you prefer to block automation, you can go directly to step 6.

Preparing for Automation

Changing Communication Settings

4. Under **Communication Type**, select **GPIB**, **ActiveX**, **RS-232**, or **TCP/IP**.

For more information on the choice of a particular type, see the table on page 179.

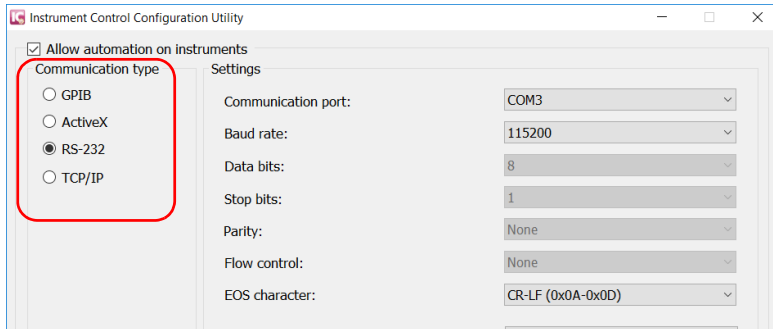

Note: The GPIB option is only visible if the USB to GPIB adapter is connected to one of the USB ports of your unit.

Note: If the selected communication type does not match the protocol that will actually be used, an error message is displayed when attempting to control the instruments.

5. According to the communication type you have selected, if necessary, customize the corresponding parameters.

➤ For GPIB

The selected address must not already be used by the GPIB bus controller or any other device connected to the GPIB bus. Default value is 12.

Bus timing (in nanoseconds)

Default value is GPIB0.

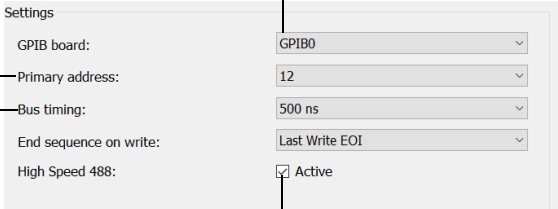

Select the check box to enable the high-speed mode.

Setting	Value
GPIB board:	GPIB0
Primary address:	12
Bus timing:	500 ns
End sequence on write:	Last Write EOI
High Speed 488:	<input checked="" type="checkbox"/> Active

For information on bus timing or on high-speed mode, see the section pertaining to obtaining an optimum performance from your unit.

➤ For RS-232

Serial port—used to connect the RS-232 cable.

Determines the speed at which data is sent between the unit and a computer, in bits per second (b/s).

End-of-string (EOS) character—used to indicate the end of a data string (when sending or receiving data).

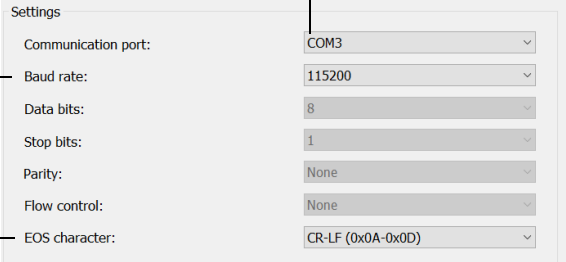

Setting	Value
Communication port:	COM3
Baud rate:	115200
Data bits:	8
Stop bits:	1
Parity:	None
Flow control:	None
EOS character:	CR-LF (0x0A-0x0D)

Preparing for Automation

Changing Communication Settings

- For TCP/IP (configuration set automatically for you)

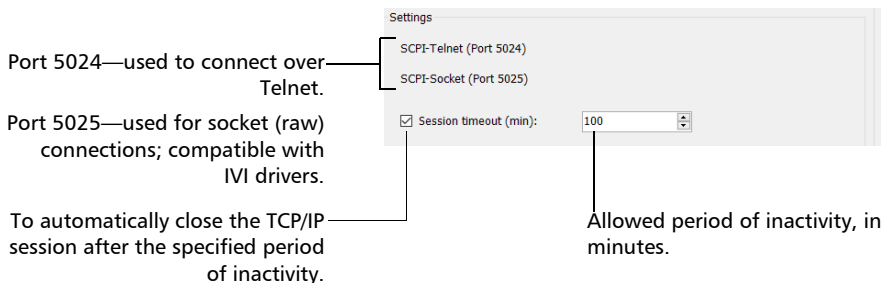

Note: When you select TCP/IP, you can send SCPI commands on both ports (Telnet and Socket) simultaneously.

Note: Each session manages its timeout independently of the other sessions. Its stopwatch (measuring the time elapsed since the last command) is reset every time a new command is executed. The session timeout value that you define will be taken into account in future sessions. This means that changing the timeout value while a session is already underway has no impact on that session.

Note: With socket (raw) connections, if you are working with a Virtual Instrument Software Architecture (VISA) driver or SDK, or with a third-party VISA tool, you need to ensure that a timeout value is defined in your application or in the third-party VISA tool. You must also ensure that the termination character is enabled (typically `\n`). Do not forget to apply the changes (some tools require you to specifically press the Apply button first - not just confirm with OK).

For information on communicating with TCP/IP over Telnet, see the section pertaining to communication through TCP/IP over Telnet.

6. Click **Apply** to confirm your changes.

To revert to default GPIB settings:

1. Click the **Default Settings** button.

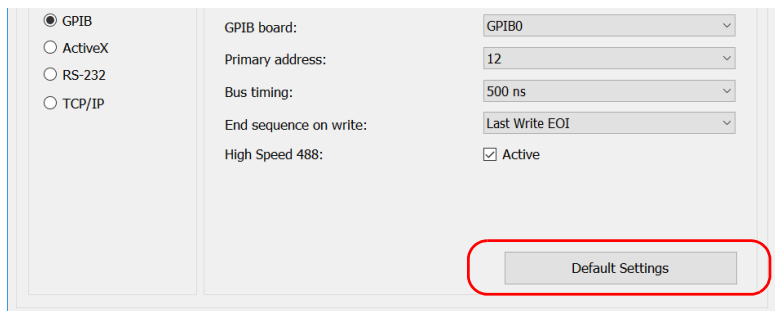

The screenshot shows a dialog box for GPIB settings. On the left, under "Communication type", the "GPIB" radio button is selected. The right side of the dialog lists several settings: "GPIB board:" is set to "GPIB0", "Primary address:" is "12", "Bus timing:" is "500 ns", "End sequence on write:" is "Last Write EOI", and "High Speed 488:" is checked and set to "Active". A red rounded rectangle highlights the "Default Settings" button at the bottom right of the dialog.

2. Click **Apply** to confirm your changes.

To revert to default RS-232 settings:

1. Click the **Default Settings** button.

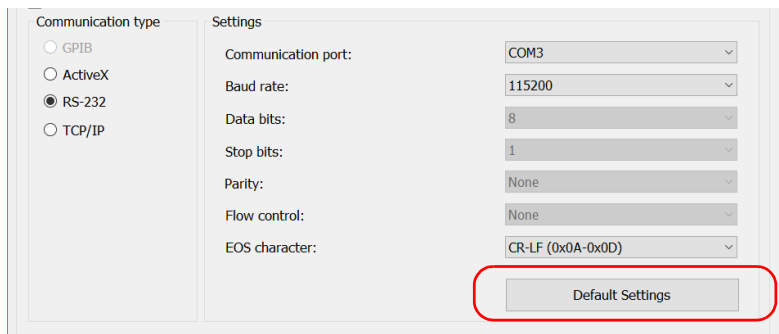

The screenshot shows a dialog box for RS-232 settings. On the left, under "Communication type", the "RS-232" radio button is selected. The right side of the dialog lists several settings: "Communication port:" is set to "COM3", "Baud rate:" is "115200", "Data bits:" is "8", "Stop bits:" is "1", "Parity:" is "None", "Flow control:" is "None", and "EOS character:" is "CR-LF (0x0A-0x0D)". A red rounded rectangle highlights the "Default Settings" button at the bottom right of the dialog.

2. Click **Apply** to confirm your changes.

Configuring DCOM Access to Your Unit

DCOM technology allows to control devices and optical instruments via Ethernet. The EXFO IcSCPIAccess Class component provided with your unit acts as a communication link between a client application and EXFO's Instrument Control. For more information, refer to the Manufacturing Automation SDK available in EXFO Apps, at <http://www.exfo.com/en/exfo-apps/software/exfo-manufacturing-automation-sdk>.

DCOM ensures communication between the client application and Instrument Control via your local network. Since each network has its own configuration, you need to be familiar with network security, users, groups, domain management, etc. Basic programming skills are also required to work with DCOM. For more information, you can refer to the Microsoft MSDN Help feature, which provides exhaustive technical documentation on all DCOM issues.

The example presented in the following pages illustrates how to make the EXFO IcSCPIAccess Class component available to all users of a local network. The example provided below is for guidance only; it may not work properly with all networks and interfaces may slightly differ depending on the operating system used.

To enable DCOM access to your unit, you must:

- set the general security parameters
- customize the specific security parameters
- register callback events.

Setting the General Security Parameters

To enable DCOM access to your unit, you must first set the general security parameters.

Note: *To modify the security parameters, you need administrator access rights.*

To set the general security parameters:

1. From the main window, click the **System Settings** button.
2. Click **Control Panel**.
3. Click **System and Security > Administrative Tools**.
4. Double-click **Component Services**.
5. In the **Component Services** dialog box, go to **Console Root > Component Services > Computers**.

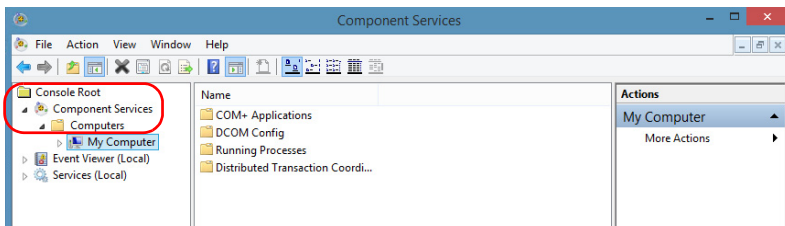

6. Right-click **My Computer**, and then select **Properties**.

Preparing for Automation

Configuring DCOM Access to Your Unit

7. In the **My Computer Properties** dialog box, click the **COM Security** tab.
8. Under **Access Permissions**, click **Edit Limits**.

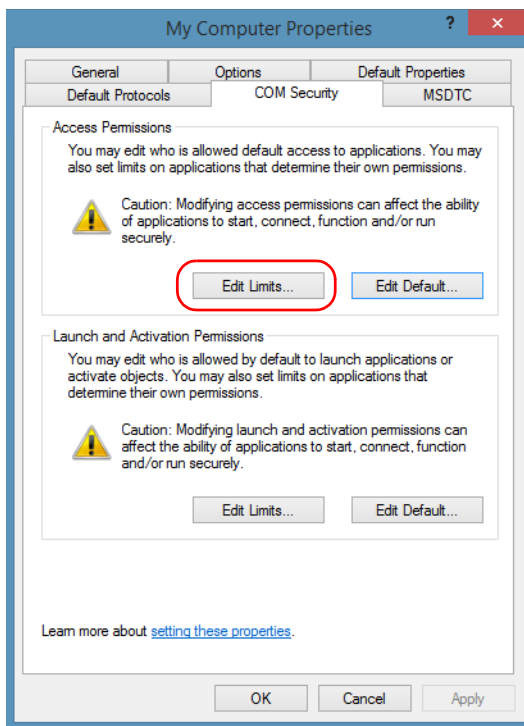

9. In the **Access Permission** dialog box, ensure that the **Distributed COM Users** appears in the **Group or user names** list.

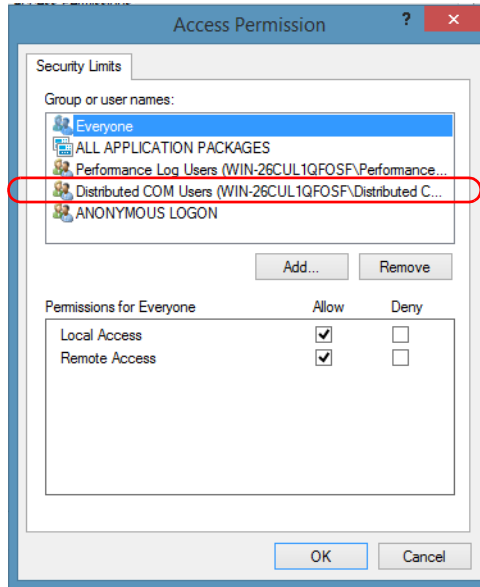

10. Click **OK**.
11. In the **My Computer Properties** dialog box, click the **COM Security** tab.

Preparing for Automation

Configuring DCOM Access to Your Unit

12. Under Launch and Activation Permissions, click Edit Limits.

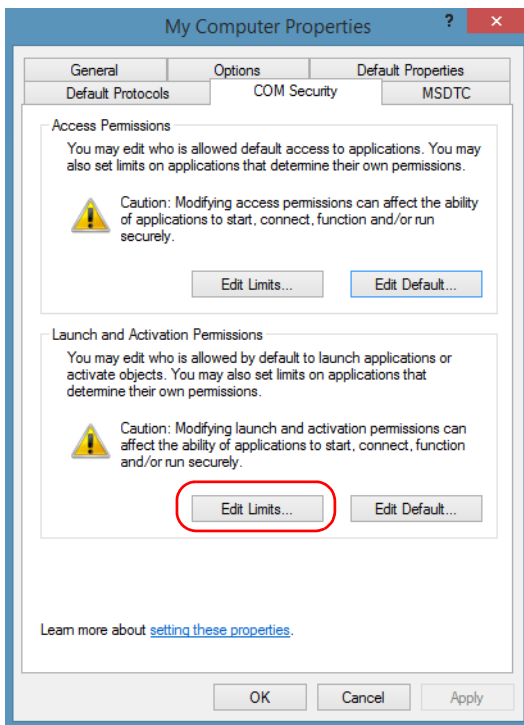

- 13.** In the **Launch and Activation Permission** dialog box, ensure that the **Distributed COM Users** group appears in the **Group or user names** list.

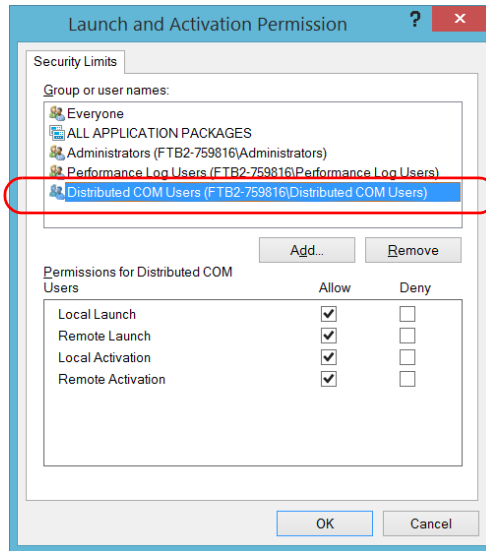

You can now allow users to access general DCOM services on your unit. You can either:

- Add a user to the **Distributed COM Users** group (refer to Microsoft help).

OR

- Add a user explicitly and define both, access and launch permissions (see procedure below).

Note: *If you add a user explicitly, ensure to give remote access rights to the new user.*

Preparing for Automation

Configuring DCOM Access to Your Unit

To add a user explicitly:

- 1.** In the **My Computer Properties** dialog box, click the **COM Security** tab.
- 2.** Under **Access Permission**, click **Edit Limits**.
- 3.** In the **Access Permission** dialog box, click **Add**.

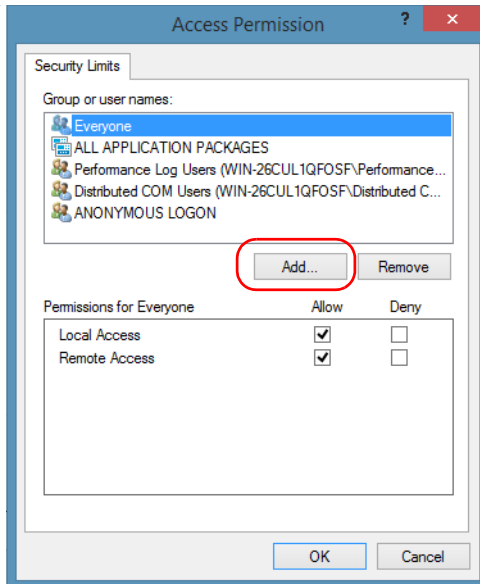

4. In the **Select Users or Groups** dialog box, under **Enter the object names to select**, type the name of the user to whom you want to give access rights.

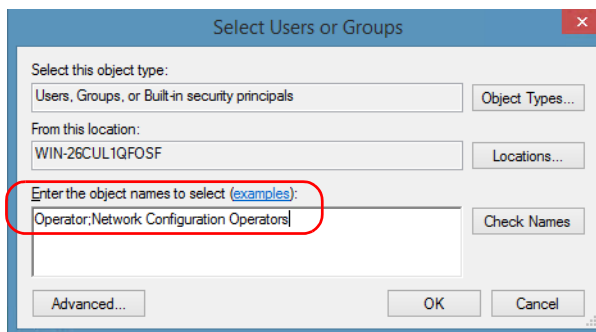

5. Click **OK**.

Preparing for Automation

Configuring DCOM Access to Your Unit

6. Confirm the newly added user has remote access permission as follows:
 - 6a. In the **Access Permission** dialog box, select the name of the new user.

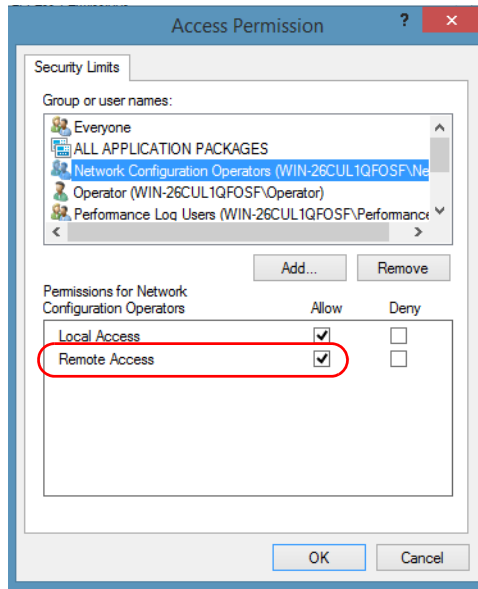

- 6b. Under **Permissions for** (new user), ensure **Allow** is selected for **Remote Access**.
 - 6c. Click **OK**.
7. In the **My Computer Properties** dialog box, click the **COM Security** tab.
8. Under **Launch and Activation Permissions**, click **Edit Limits**.

- 9.** In the **Launch and Activation Permission** dialog box, click **Add**.

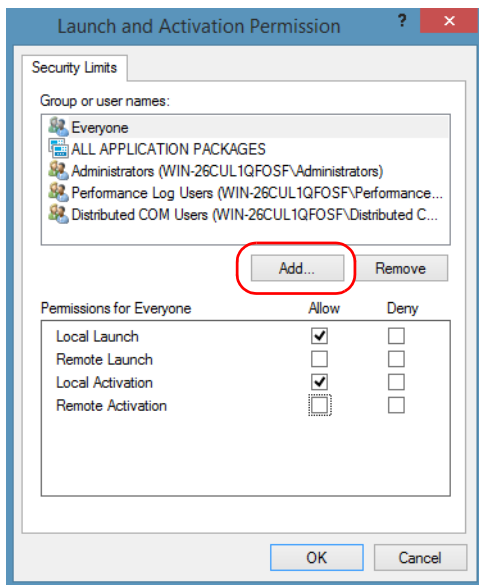

- 10.** In the **Select Users or Groups** dialog box, under **Enter the object names to select**, type the name of the user to whom you want to give start and activation access rights.

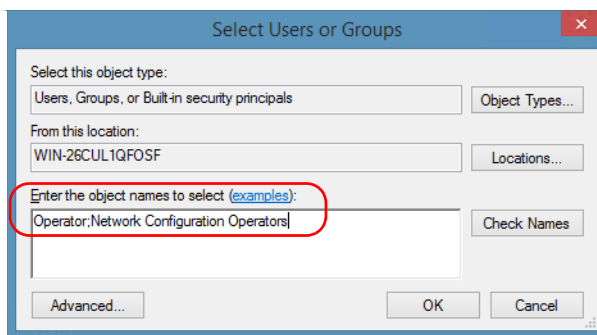

- 11.** Click **OK**.

Preparing for Automation

Configuring DCOM Access to Your Unit

12. Confirm the newly added user has **Remote Launch** and **Remote Activation** permissions as follows:

12a. In the **Launch and Activation Permission** dialog box, select the name of the new user.

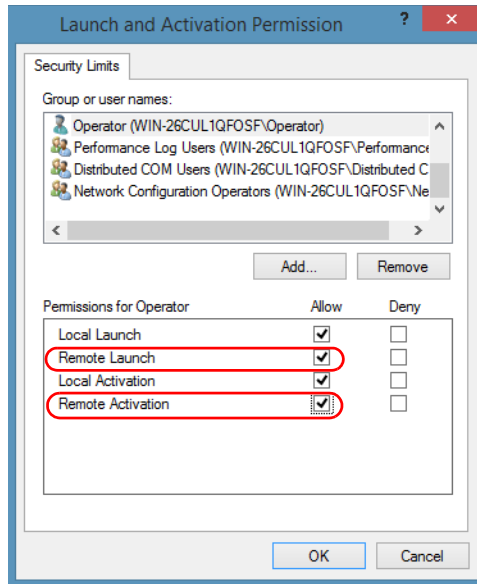

12b. Under **Permissions for** (new user), ensure **Allow** is selected for both **Remote Launch** and **Remote Activation**.

12c. Click **OK**.

Customizing the Specific Security Parameters

Once you have defined the general security parameters, you can define the specific security parameters.



IMPORTANT

Customizing access rights sets both remote AND local permissions. As a result, you will have to specify every user who must have local access to the system (see *Setting the General Security Parameters* on page 197).

If you do not specify local access rights, no user will be able to access EXFO KernosHost and, therefore, no user will be able to start ToolBox X.

To customize the specific security parameters:

1. From the **Component Services** window, select: **Console Root > Component Services > Computers > My Computer > DCOM Config** to show the contents of the **DCOM Config** folder.

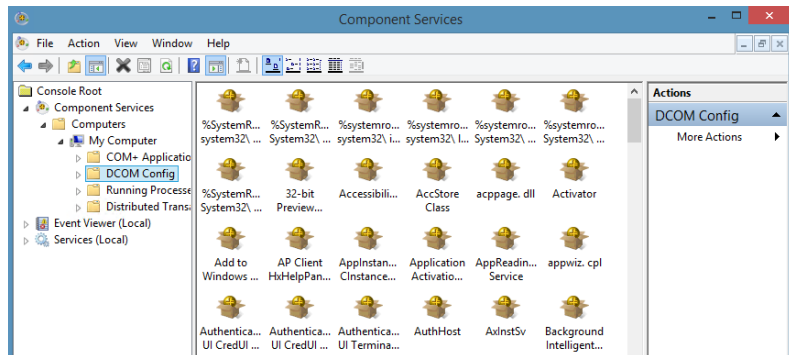

2. From **DCOM Config**, right-click **EXFO KernosHost**, and select **Properties**.

Preparing for Automation

Configuring DCOM Access to Your Unit

3. Click the **General** tab.
4. In the **Authentication Level** list, select **Default**.

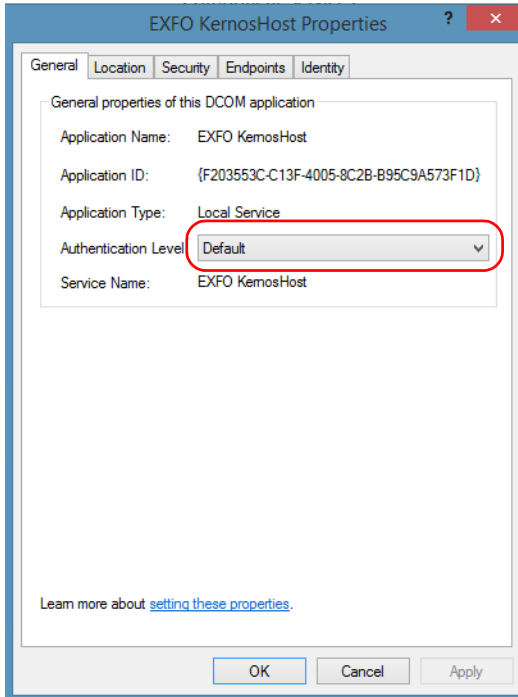

5. In the **EXFO KernosHost Properties** dialog box, click the **Security** tab.
6. Under **Launch and Activation Permissions**, select **Customize**, and then click **Edit** to edit the list of allowed users.

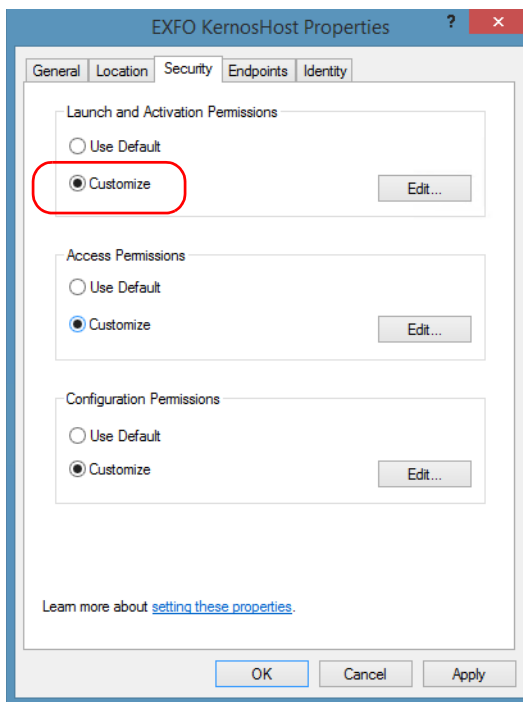

Preparing for Automation

Configuring DCOM Access to Your Unit

7. In the **Launch and Activation Permission** dialog box, click **Add**.

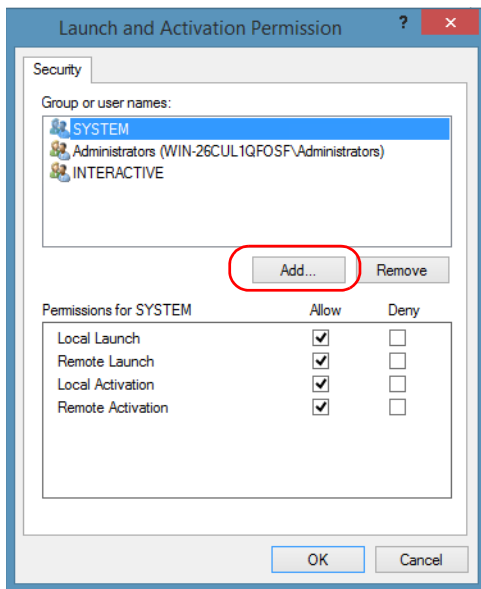

8. In the **Select Users or Groups** dialog box, under **Enter the object names to select**, type the name of the user to whom you want to give start and activation permissions for remote access.

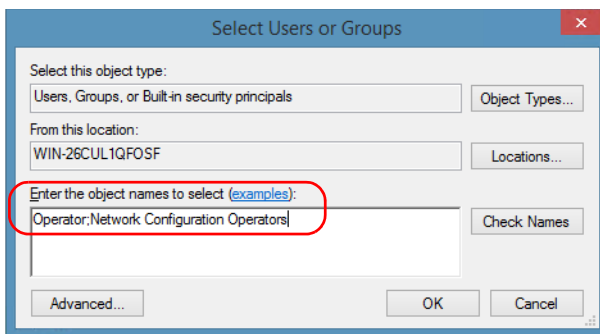

9. Click **OK**.

- 10.** In the **Launch and Activation Permission** dialog box, select a user.
- 11.** To allow this user to start and activate the unit remotely, select **Allow** for all four permission choices.

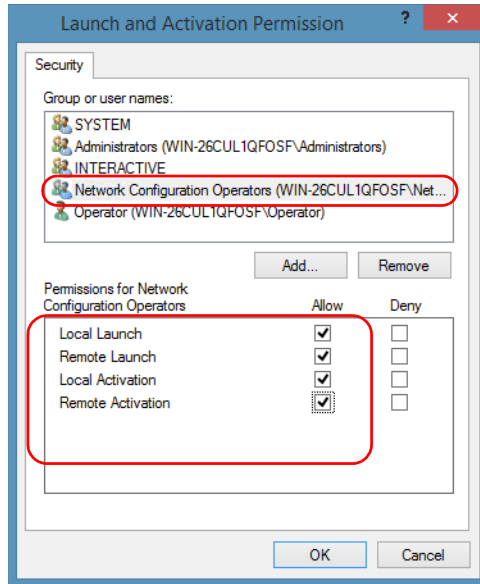

- 12.** Repeat steps 10 and 11 for each newly added user.
- 13.** Click **OK**.

Preparing for Automation

Configuring DCOM Access to Your Unit

14. In the **EXFO KernosHost Properties** dialog box, click the **Security** tab.
15. Under **Access Permissions**, select **Customize**, and click **Edit** to edit the list of allowed users.

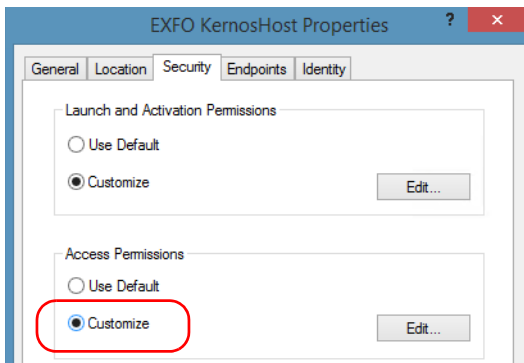

16. In the **Access Permission** dialog box, click **Add**.
17. In the **Select Users or Groups** dialog box, under **Enter the object names to select**, type the name of the user to whom you want to give access permissions for remote access.

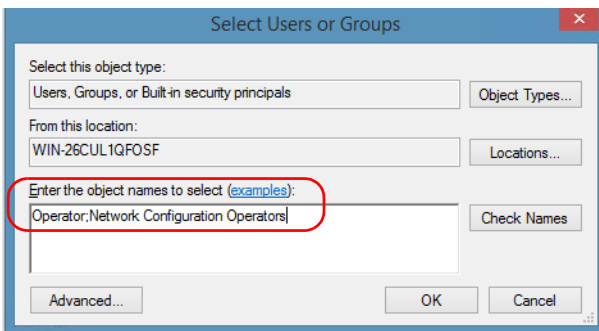

18. Click **OK**.
19. In the **Access Permission** dialog box, select a user.

- 20.** To allow this user to access the unit remotely, select **Allow** for both permission choices.

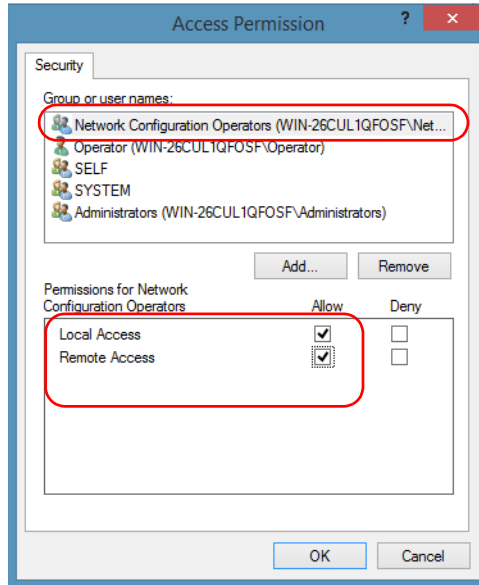

Note: You can also deny connection permission for specific users.

- 21.** Repeat steps 19 and 20 for each newly added user.
- 22.** Click **OK** to close the **Access Permission** dialog box.
- 23.** Click **OK** to close the **EXFO KernosHost Properties** dialog box.
- 24.** Restart your unit.

The EXFO IcSCPIAccess Class component, located on your unit, can now be accessed with DCOM.

Preparing for Automation

Configuring DCOM Access to Your Unit

Enabling DCOM on Client Computer

Note: To run *DCOMCNFG.EXE*, you need Administrator access rights.

If you want to subscribe to EXFO ICSPIAccess Class component events, you need to set security parameters on the client computer.

To enable DCOM on the client computer:

1. Start Windows, on the taskbar, click **Start** (Start button ()) under Windows 8.1 and Windows 10) and select **Run**.
2. In the **Open** box, type “DCOMCNFG.EXE” and click **OK**.
3. In the **Component Services** dialog box, select: **Console Root > Component Services > Computers** to show available computers.

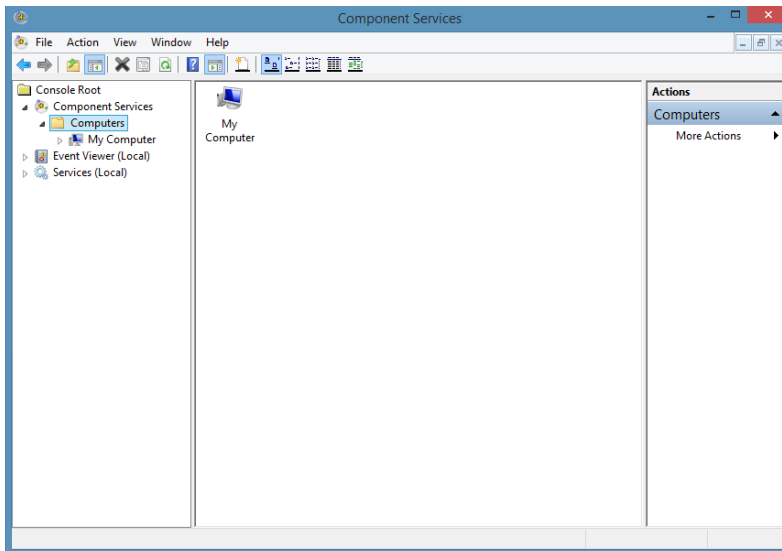

4. Right-click **My Computer**, and then select **Properties**.
5. In the **My Computer Properties** dialog box, click the **Default Properties** tab.
6. Select **Enable Distributed COM on this computer**.

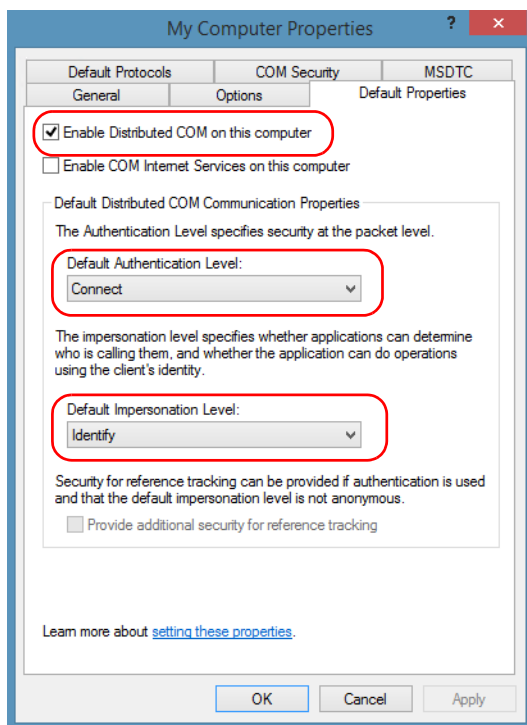

7. Under **Default Distributed COM Communication Properties**, in the **Default Authentication Level** list, select **Connect**.
8. In the **Default Impersonation Level** list, select **Identify**.
9. Click **Apply**.

Preparing for Automation

Configuring DCOM Access to Your Unit

10. Click the **COM Security** tab and, under **Access Permissions**, clicktap **Edit Limits**.

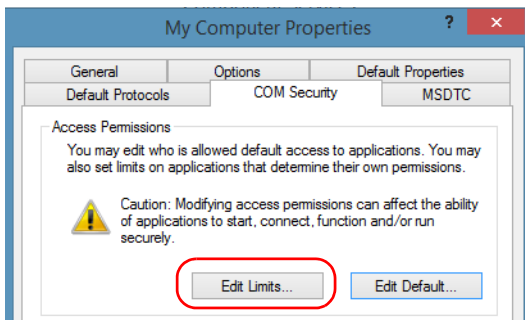

11. In the Access Permission dialog box, ensure that, for **ANONYMOUS LOGON**, local and remote accesses are allowed.

If **ANONYMOUS LOGON** is not listed under Group or user names, click **Add** to add it.

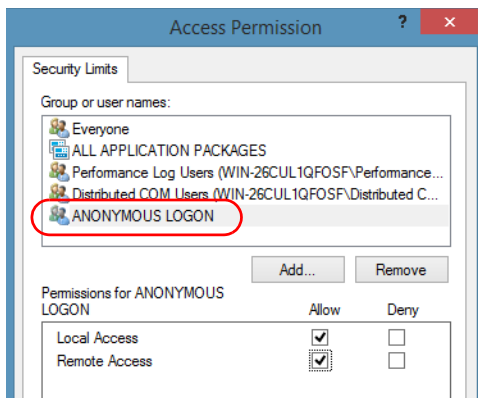

For more information on enabling events with DCOM, refer to *AppId Key* in MSDN Documentation.

Disabling DCOM Access to Your Unit

Note: To change the DCOM access to your unit, you need Administrator access rights.

If you no longer want client computers to access your unit using DCOM, you can disable this access.

To disable DCOM access to your unit:

1. From the main window, click the **System Settings** button.
2. Click **Control Panel**.
3. Click **System and Security > Administrative Tools**.
4. Double-click **Component Services**.
5. From the **Component Services** window, select: **Console Root > Component Services > Computers > My Computer > DCOM Config** to show the contents of the **DCOM Config** folder.

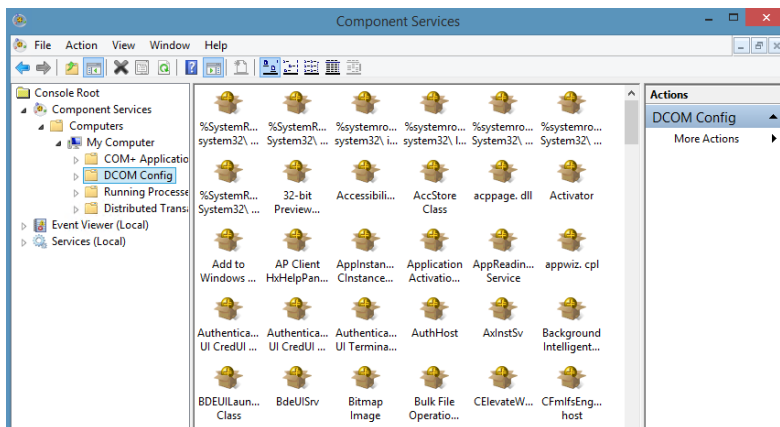

6. From **DCOM Config**, right-click **EXFO KernosHost**, and select **Properties**.

Preparing for Automation

Configuring DCOM Access to Your Unit

7. In the **EXFO KernosHost Properties** dialog box, click the **Security** tab.
8. Under **Launch and Activation Permissions** and **Access Permissions**, select **Use Default**.

This ensures the EXFO IcSCPIAccess Class component uses the default lists instead of the customized lists.

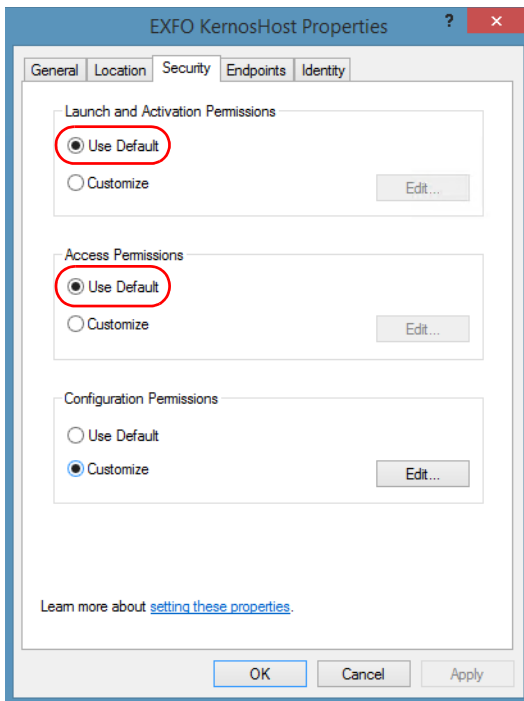

9. Click **OK**.
10. Restart your unit.

The EXFO IcSCPIAccess Class component, located on your unit, *cannot* be accessed with DCOM.

Configuring Your Instruments

You can control the instruments in various ways such as writing your own scripts to send SCPI commands, or using dedicated applications provided by EXFO (when available).



IMPORTANT

Before being able to control instruments with SCPI commands, or control them remotely using a dedicated application such as EXFO Remote ToolBox, you must first allow remote access to these instruments.

Regardless of how you intend to control your instruments, you can configure the following parameters for each of them:

- Enable or disable remote access.
- Enable or disable the use as a standalone instrument. Setting an instrument as standalone allows to keep the instrument active even if all users close their dedicated applications.
- Enter a description to help you identify the instrument.
- Modify the logical instrument number (LINS) that the system assigns by default to each instrument for identification and access purposes.

If you are working with several units housing modules, you may also find useful to select a distinct offset value for each of these units. The offset value will be used when assigning the LINS, allowing you to identify a specific instrument more easily. For example, if the basic LINS is 1 and you have selected an offset of 10, you will be able to access the instrument at logical position 11 (offset + LINS).

Each LINS is associated with a specific instrument as long as this instrument remains in use in the system. When the instrument is removed, the LINS can then be assigned to another instrument.

Preparing for Automation

Configuring Your Instruments

Each user who wants to control the instrument from a computer using a dedicated application must install this application (for more information on the installation, refer to the application documentation).

- The instrument can be controlled both remotely and locally at the same time.
- You will have to configure remote control again in the following cases:
 - you inserted the module in another slot
 - you applied changes to applications while the module was not inserted in its slot.

Note: *Some instruments do not support remote control.*

To activate or deactivate remote control:

1. From the main window, tapclick the **System Settings** button.
2. Click **Remote Control Configuration**.



3. If necessary, click **Change Settings**, and then, when the application prompts you to authorize the changes to your unit, select **Yes**.

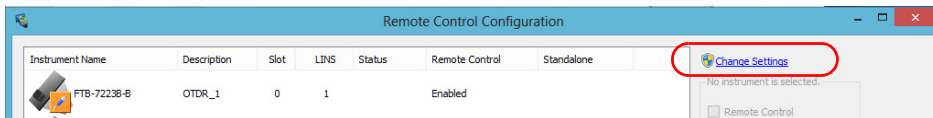

4. From the **Remote Control Configuration** window you will see all the instruments present in the system. Select the instrument for which you want to have a remote access.

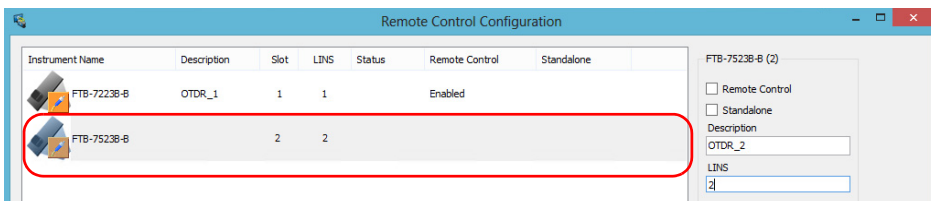

5. Set the parameters:
 - Select **Remote control** to be able to access the instrument remotely (via TCP/IP over Telnet or other).
 - Select **Standalone** to leave the instrument active even if all users close their dedicated applications.

Note: When a standalone instrument is no longer used, you can simply release it. See the corresponding procedure below to know how to proceed.

6. If desired, under **Description**, type a description that will help you identify the instrument.

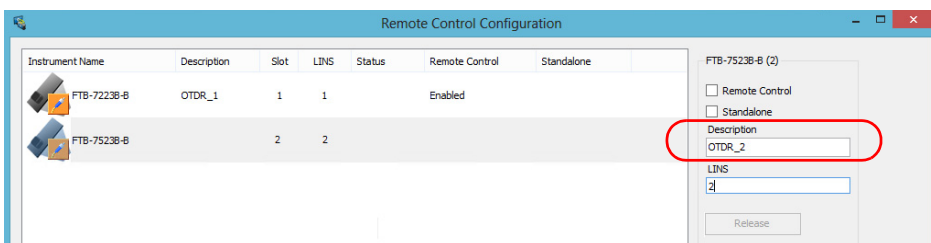

Note: You can enter up to 10 characters. The description can correspond to the test interface ID or to any other short text of your choice.

Preparing for Automation

Configuring Your Instruments

7. If necessary, under **LINS**, modify the logical instrument number that you will use to access the instrument remotely.

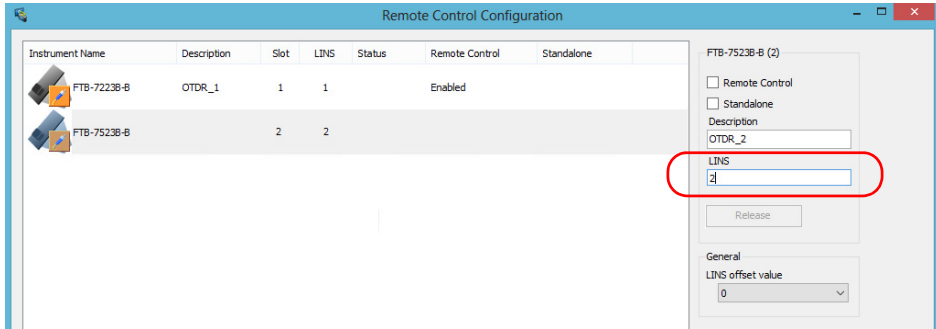

Note: If the **LINS** column is empty, it means that the corresponding instrument cannot be controlled using SCPI commands.

8. Click **Apply** to confirm your changes or **OK** to apply your changes and close the window.

Note: This information will be updated the next time you start the instrument application and will appear in the title bar if the instrument application allows it. Refer to the corresponding instrument documentation for more details.

To define a LINS offset value:

1. From the main window, click the **System Settings** button.
2. Click **Remote Control Configuration**.



3. If necessary, click **Change Settings**, and then, when the application prompts you to authorize the changes to your unit, select **Yes**.

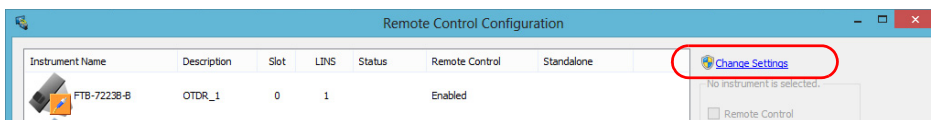

Preparing for Automation

Configuring Your Instruments

- From the **LINS offset value** list, select a value that will be used when assigning the LINS that will help you identify the instruments more easily if you are working with several units housing modules. If you prefer to access the instruments using the LINS as is, leave the offset value to 0.

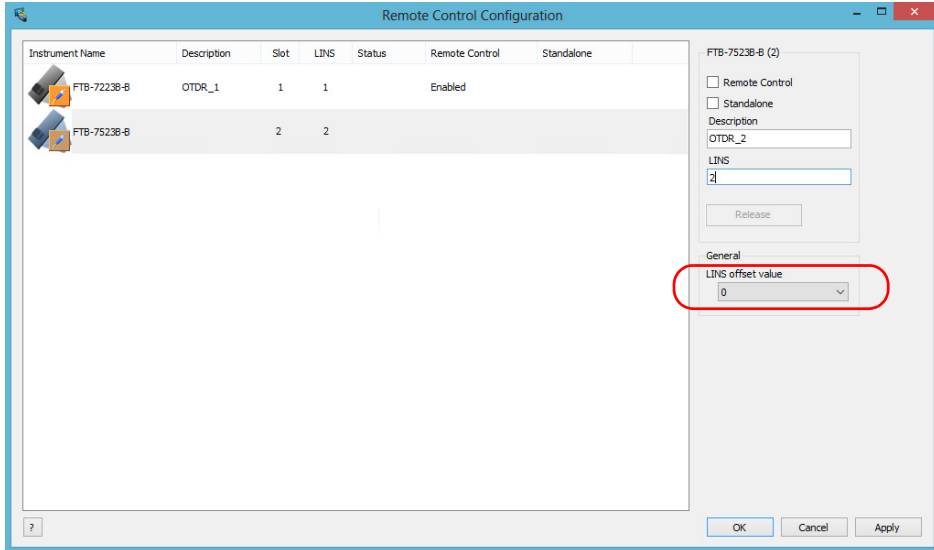

Note: The LINS offset value that you select applies only to the unit on which you configure the parameters.

Note: The LINS offset value that you select will be used when assigning the LINS of the next instruments that you will insert in the unit. The LINS of the instruments that were already in the system when you selected the LINS offset value will not be updated.

To release the remotely-controlled instrument:

Click **Release**.

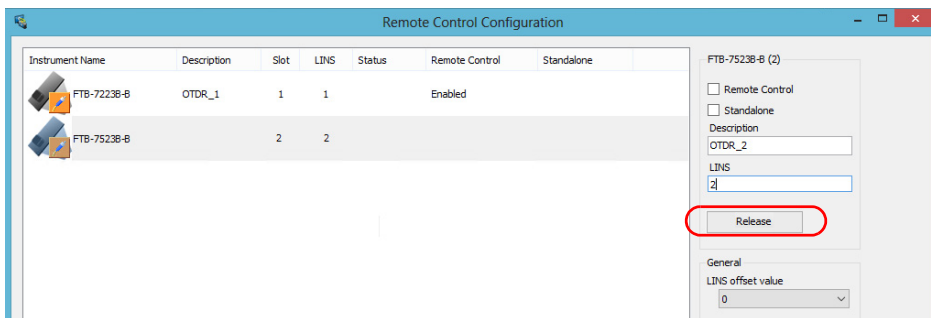

11 *Using Your Unit and Modules in an Automated Test Environment*

EXFO supplies commands that follow the guidelines determined by the SCPI consortium for all available instruments. EXFO also supplies COM properties and events allowing you to build your own application.

The present chapter gives you information to help you use the provided commands, as well as COM properties and events to remotely control your instruments.

If you need information on how to prepare your unit for remote control, see the corresponding section in this documentation.

Standard Status Data Structure

Each device that is physically connected to the remote bus has four status registers with a structure complying with the IEEE 488.2 standard. These registers allow the controller to monitor events and get useful information on the status of the devices it controls.

- Standard Event Status Register (ESR)
- Standard Event Status Enable Register (ESE)
- Status Byte Register (STB)
- Service Request Enable Register (SRE)

ESR and ESE

The standard event status register and status enable register information is presented in the following table.

Bits	Mnemonics	Bit Value
7	Power On (PON)	128
6	User Request (URQ)	64
5	Command Error (CME)	32
4	Execution Error (EXE)	16
3	Device-Dependent Error (DDE)	8
2	Query Error (QYE)	4
1	Not Used (N.U.)	0
0	Operation Complete (OPC)	1

Using Your Unit and Modules in an Automated Test Environment

Standard Status Data Structure

The following table presents a summary of the possible operations on ESR and ESE registers.

Register	Read	Write	Clear
ESR	Use *ESR?.	Impossible to write.	<ul style="list-style-type: none">▶ Use *CLS.▶ Read the register.
ESE	Use *ESE?.	Use *ESE.	Use *ESE with a value equal to 0.

STB and SRE

The status byte register and service request enable register information is presented in the following table.

Bits	Mnemonics	Bit Value
7	Not Used (N.U.)	0
6	Master Summary Status (MSS)/ Service Request (RQS)	64
5	Event Summary Bit (ESB)	32
4	Message Available (MAV)	16
3	Not Used (N.U.)	0
2	Error Available (EAV)	4
1	Not Used (N.U.)	0
0	Not Used (N.U.)	0

Using Your Unit and Modules in an Automated Test Environment

Standard Status Data Structure

The following table presents a summary of the possible operations on STB and SRE registers.

Register	Read	Write	Clear
STB	<ul style="list-style-type: none">▶ Use *STB?.▶ Use serial poll (GPIB bus sequence that allows retrieval of the value without interrupting the current process).	Impossible to write; the register content is only modified when the Event registers or Queues are modified.	Use *CLS before sending a query (to clear the Event registers and Queues and by the same token clear the STB register).
SRE	Use *SRE?.	Use *SRE with a value equal to 0 to disable the register or with a value equal to 1 to enable it.	<ul style="list-style-type: none">▶ Use *SRE with a value equal to 0.▶ At startup, the register is set to 0.

The diagram displayed on the next page is a useful aid in understanding the general commands and how a service request (SRQ) is generated.

Using a service request, a device notifies the controller that an event requiring special attention occurred. The controller will then find which device generated a SRQ (its RQS bit is set) and the causes of it.

Using Your Unit and Modules in an Automated Test Environment

Standard Status Data Structure

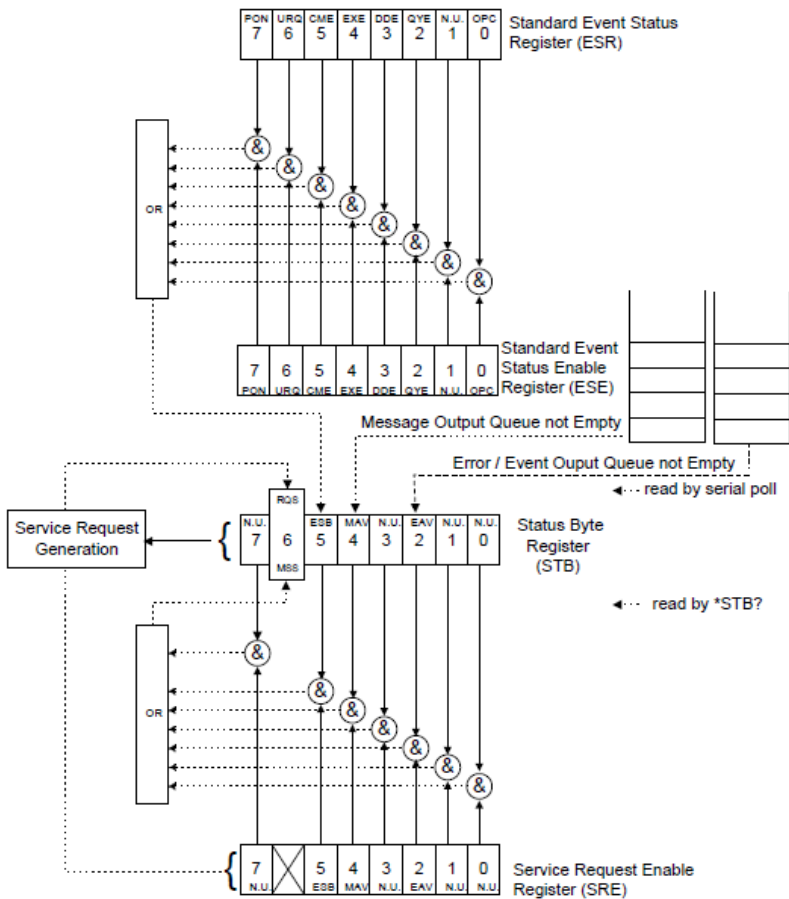

SCPI Command Structure

The information presented in this section provides an overview of SCPI programming. If you need detailed information, refer to:

- The International Institute of Electrical and Electronics Engineers. *IEEE Standard 488.2-1992, IEEE Standard Codes, Formats, Protocols and Common Commands For Use with ANSI/IEEE Std. 488.1-1987*. New York, 1992.
- *Standard Commands for Programmable Instruments (SCPI). Volume 1: Syntax and Style*. Vers. 1999.0 May, U.S.A, 1999.

The provided commands follow the guidelines determined by the Standard Commands for Programmable Instruments (SCPI) consortium. A *program message* consists of one or more commands (and/or queries) with their appropriate parameters.

For example, a program message could contain a command used to activate or deactivate a source. The corresponding command syntax would be:

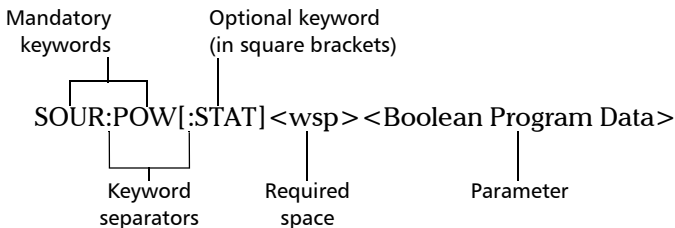

When sending a message containing the previous command, you would actually type: `SOUR:POW ON`.

The following table shows elements that are commonly used in the commands or queries syntax.

Item	Meaning
[]	Enclose optional keywords or parameters. <i>Do not include square brackets in your program message.</i>
[1..n]	Indicates that the instrument provides multiple capabilities and that you have to specify which one you want to use. If you omit the value, the command will take effect on the first capability. Multiple capabilities can be found at any branch of the command tree (root, intermediate node or terminal node). Example: If the command is :SENSe[1..n]:CORRection:COLLect:ZERO and you want it to take effect on the second SENSE (sensor) capability of the instrument, you may send this: :SENSe2:CORRection:COLLect:ZERO. <i>Do not include square brackets in your program message; simply enter the number.</i>
<wsp>	Indicates that a space is required (“wsp” stands for “white space”). Corresponds to ASCII character codes (0 to 9 and 11 to 32, in decimal). <i>Do not include “<wsp>” in your program message; simply type a space.</i>
<digit>	Element used in the construction of various numeric data types. Can take any value between 0 and 9 inclusively (corresponds to ASCII character codes 48 to 57, in decimal).

Using Your Unit and Modules in an Automated Test Environment

SCPI Command Structure

Item	Meaning
<mnemonic>	<p>Element used in the construction of certain data types and program messages.</p> <div data-bbox="444 354 982 574" data-label="Diagram"> </div> <p>In the diagram above,</p> <ul style="list-style-type: none"> ➤ “<Upper/lower case alpha>” corresponds to ASCII character codes (65 to 90 and 97 to 122, in decimal). ➤ “_” corresponds to an underscore character (code 95, in decimal).
< >	<p>Text appearing between angled brackets specifies the command parameter to be sent or the response you will receive from an instrument.</p> <p><i>Do not include angled brackets in your program message.</i></p>
	<p>Indicates that one, and only one, value must be selected from the available choices.</p> <p>Example: If the list is 0 1, you can only select 0 or 1.</p> <p><i>Do not include the pipe character in your program message.</i></p>
{ }	<p>Indicate that the enclosed parameters can appear 0 to n times when the command is used.</p> <p><i>Do not include braces in your program message.</i></p>
:	<p>Mandatory to separate keywords. Can be omitted at the beginning of a program message. For example, you can use either :SYST:ERR or SYST:ERR.</p>

Item	Meaning
;	<ul style="list-style-type: none"> ➤ Mandatory to separate the different commands of a program message when more than one command is sent at a time. In this case, it is called <i><PROGRAM MESSAGE UNIT SEPARATOR></i>. ➤ Also used to separate responses when multiple queries were sent in a single program message. In this case, it is called <i><RESPONSE MESSAGE UNIT SEPARATOR></i>.
,	<ul style="list-style-type: none"> ➤ Mandatory to separate parameters in a command or a query. In this case, it is called <i><PROGRAM DATA SEPARATOR></i>. ➤ Also used to separate the various responses from a query. In this case, it is called <i><RESPONSE DATA SEPARATOR></i>.

There are also several conventions regarding command syntax:

- Spelling errors will cancel the command or query.
- Commands and queries are not case-sensitive. You can type your program messages using either lower-case or upper-case letters.
- The command or query can be written using only the three- or four-letter shortcuts, only full words, or a combination of both.

The example below shows the long and the short forms of a same query.

:SYSTem:ERRor?	_____	Long form
:SYST:ERR?	} _____	Short form (small words represented by the capital letters of the long form)
:syst:err?		

Consulting Data Types

If you need information about data types used in EXFO's documentation, see the appendix on data types.

Writing Remote Control Code

Your unit offers many commands permitting complete remote control of all the supported components. These commands adhere to the SCPI standard.

You can find all the commands and queries supported by your unit in the *IEEE 488.2 and Specific Commands* appendix. For information on commands specific to particular instruments, refer to each instrument's user guide.

When you write code, you must follow these rules on message reception and transmission:

- The controller must have sent a complete message to the instrument (including the message terminator) before retrieving a response.
- The controller must retrieve all the responses from previous queries (including the response terminator) before sending a new message to an instrument.
- The controller must not try to retrieve a response from an instrument if the corresponding query has not been previously sent to the instrument.

- You must pay special attention to queries that return an indefinite ASCII response. To avoid any confusion, the IEEE 488.2 standard requires that this data type be immediately followed by a response termination character. For this reason, when working with compound queries, you must ensure that a query sending an indefinite ASCII response is the last query of the series.
- Be careful when sending program messages containing multiple queries that return large amounts of data. Since the controller can only retrieve data when the instrument has finished processing the queries, it could result in problems ranging from a saturation of the output queue to the complete blocking of the whole system.

Error Message Format

System and device-specific errors are managed by your unit. The generic format for error messages is illustrated in the following figure.

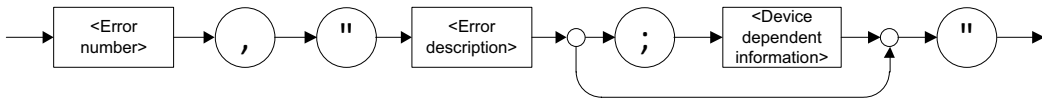

As shown in the above figure, the message contains three parts:

- error number
- error description
- device-dependent information

Error messages ending in a negative number are SCPI-based errors.

For a complete list of possible errors, see the appendix on SCPI-based errors.

Monitoring Remote Commands

ToolBox X allows you to monitor remote commands sent to your units, if desired.

To monitor remote commands:

1. From the main window, click the **Test Tools** button.
2. Select **SCPI-Telnet Monitor**.

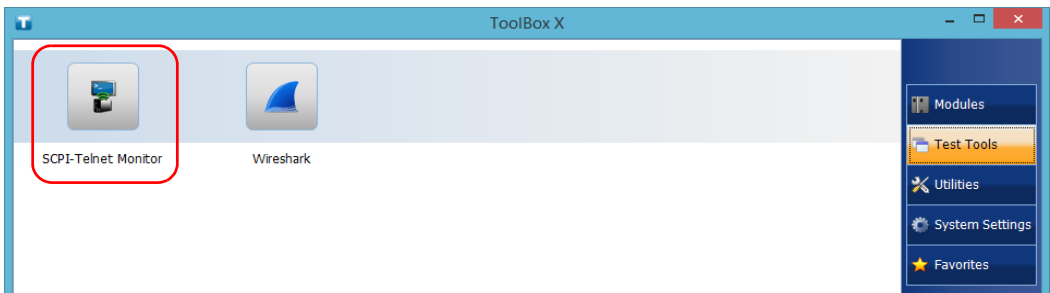

Using Your Unit and Modules in an Automated Test Environment

Monitoring Remote Commands

When you send SCPI commands over TCP/IP through Telnet or Socket from the EXFO Instrument Control, you are automatically connected to the monitoring system.

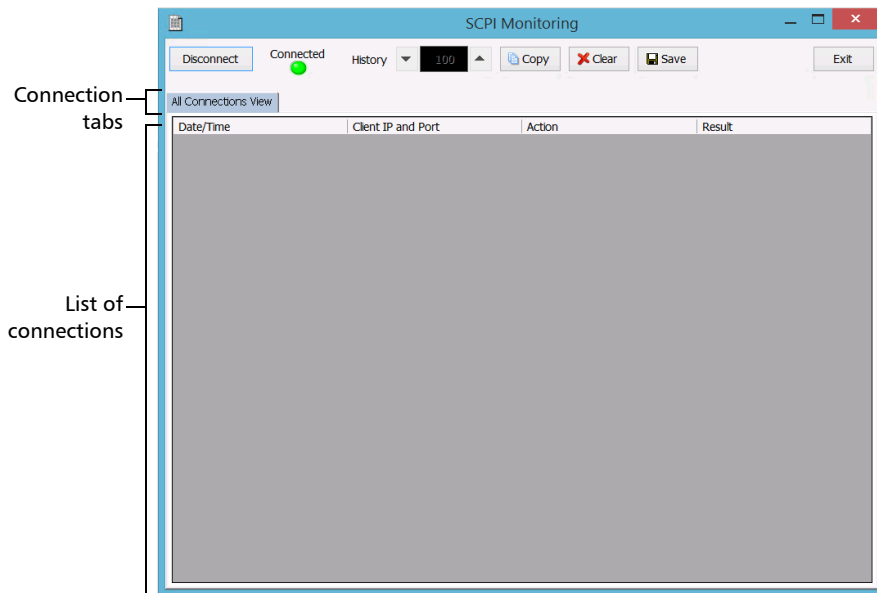

Once connected, your current connection information will appear in the **All Connections View** tab, and the commands will appear as a list in the lower part of the window.

The **Disconnect** button becomes available for you to click when you are ready to disconnect.

Connection information is also displayed in a separate tab, identified by its IP address, from where you can monitor the commands and other actions sent through TCP/IP over Telnet, as well as the results.

With the **History** parameter, you determine how many commands you want to keep in the list. You can increase or decrease the number by using the arrow buttons on each side of the list.

To clear the history, click **Clear**.

To view the list in any word processor, click **Copy** to copy it to the clipboard, and then paste it in your document. You can use any program, as the list is copied in text format.

To save the list as a file, click **Save**.

To exit the monitoring utility, click **Exit**.

For more information, refer to the user documentation about communication through TCP/IP over Telnet.

12 **Maintenance**

To help ensure long, trouble-free operation:

- Always inspect fiber-optic connectors before using them and clean them if necessary.
- Keep the unit free of dust.
- Clean the unit casing and front panel with a cloth slightly dampened with water.
- Store unit at room temperature in a clean and dry area. Keep the unit out of direct sunlight.
- Avoid high humidity or significant temperature fluctuations.
- Avoid unnecessary shocks and vibrations.
- If any liquids are spilled on or into the unit, turn off the power immediately, disconnect from any external power source and let the unit dry completely.



WARNING

The use of controls, adjustments and procedures, namely for operation and maintenance, other than those specified herein may result in hazardous radiation exposure or impair the protection provided by this unit.

Connecting Remotely to Your Unit for Maintenance or Troubleshooting

You can use the AMT Remote Access application to connect remotely to your unit if you ever need to perform maintenance or troubleshooting tasks. For more information, see *Working with Intel Active Management Technology* on page 119.

Managing Windows Updates

The parameters that are available to configure the updates depend on the operating system that your unit is running.

In all cases, only the applications from Microsoft will be updated with the automatic Windows update feature. If you want to update EXFO applications, see *Installing or Upgrading EXFO Applications* on page 75. The third-party applications will need to be updated manually.

Windows 10

By default, your unit is configured to check for updates, but to let you choose whether you want to download and install them or not.

If you prefer, you can manually check for updates.

You can also pause the updates for a maximum of 35 days, after which they will be automatically installed. Refer to Microsoft documentation for more information.

To manually check for updates:

1. From the task bar, click the **Start** button (), and then **Settings** ().
2. Click **Update & security**.

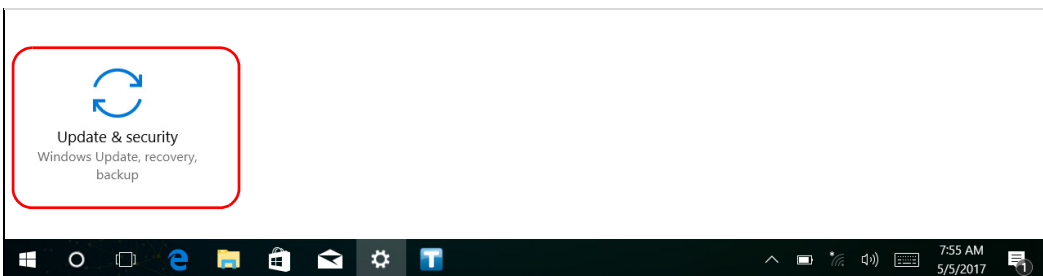

3. Select Windows Update.

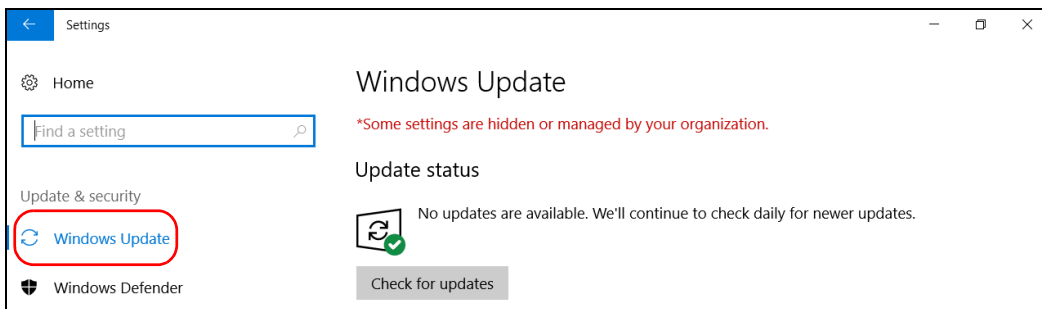

4. Under Update status, click Check for updates.

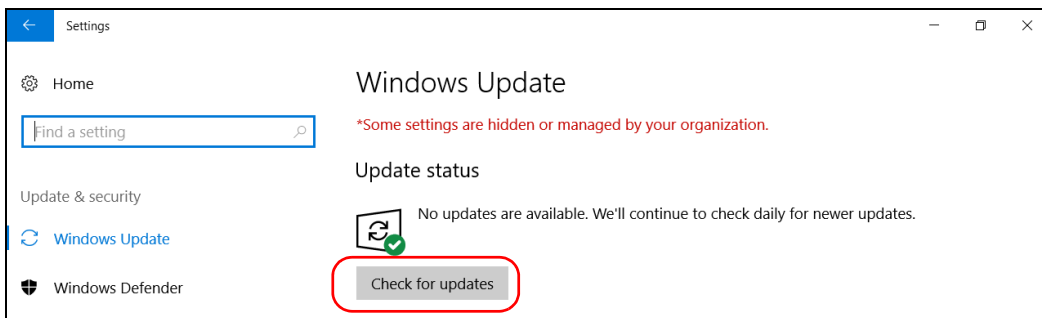

5. Follow the on-screen instructions.

Maintenance

Managing Windows Updates

Windows 8.1 Pro (Some LTB-8 Units Only)

By default, your unit is configured to check for updates, but to let you choose whether you want to download and install them or not.

However, if you prefer, you can configure your unit to automatically search and install Windows updates to ensure that you benefit from the latest versions of the Windows applications. Your unit will need an Internet access for the updates.

To manage the updates for Windows applications:

1. From the main window, click the **System Settings** button.
2. Click **Control Panel**.



3. Click **System and Security**.

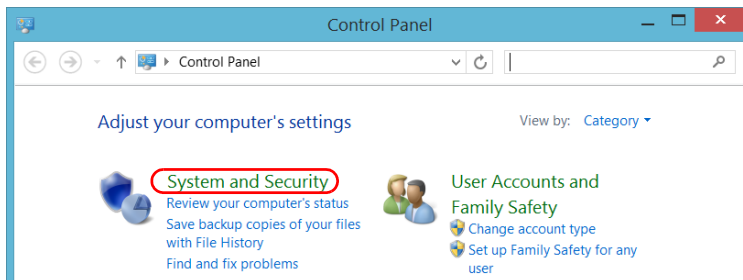

4. Under **Windows Update**, click **Turn automatic updating on or off**.

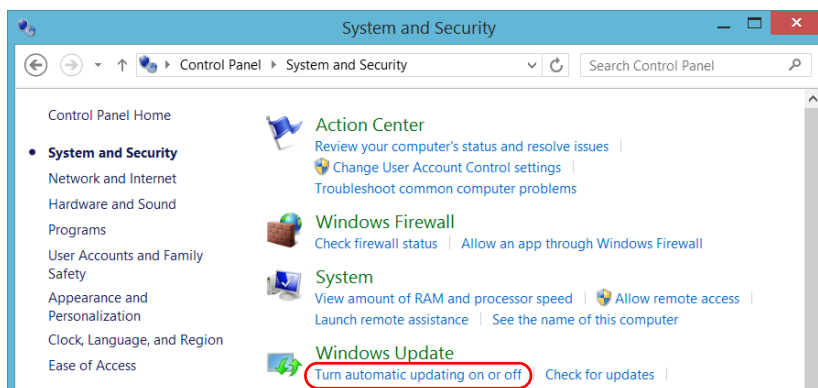

5. Select the update options that best suit your needs.

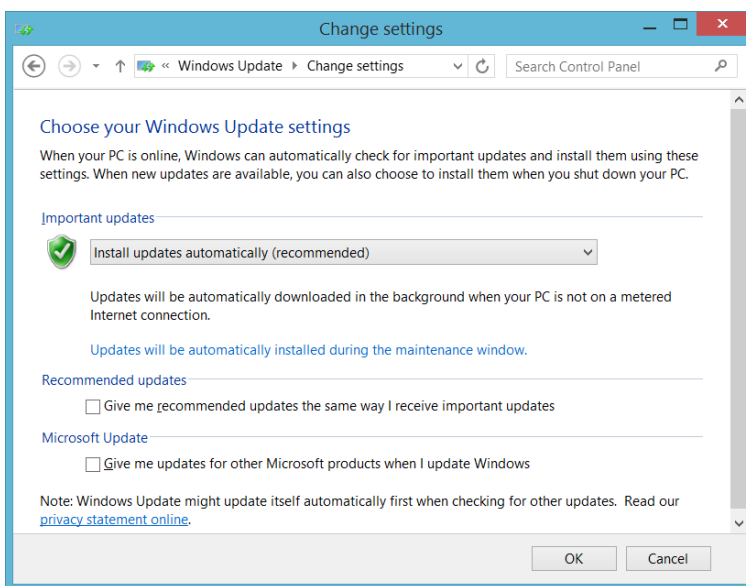

6. Click **OK** to confirm your changes and return to Control Panel.

Maintenance

Replacing Hard Disks (LTB-8 and LTB-12 Only)

Replacing Hard Disks (LTB-8 and LTB-12 Only)

If you have purchased the RAID option, your LTB-8 or LTB-12 unit is equipped with hard disks that you can replace yourself should the need arise. Carefully read the information presented in this section before proceeding.

If you have not purchased the RAID option, you will need to send your unit back to EXFO for repair (see *Contacting the Technical Support Group* on page 298).



WARNING

Be careful not to drop metal objects such as screws inside the unit. These could cause a short-circuit leading to a fire or an explosion.



CAUTION

Electrostatic discharge (ESD) damage can cause complete or intermittent equipment failures.

- Always use an ESD-preventive wrist or ankle strap when handling hard disks. Ensure that the antistatic strap makes good skin contact and that the end of its wire is grounded properly.
- Always handle the hard disk by its case and never touch the circuit board.
- Never touch any component inside the unit either with tools or your fingers.
- Only place the hard disk on antistatic surfaces such as an antistatic mat.



CAUTION

- Never remove both disks at the same time when the unit is powered on. This **WILL** result in irreparable damage to the disks and the unit. Damaged units will need to be sent to EXFO for repair.
- Use only hard disks designed for your unit and approved by EXFO.
- Be careful not to drop the hard disk and to avoid shocks.

To replace hard disks on your unit:

- 1.** To help you identify which disk needs to be replaced, from the Windows notification area, select **Intel Rapid Storage Technology > Open Application**.
- 2.** Put on a wrist (or an ankle) antistatic strap and ensure that the end of its wire is grounded properly.
- 3.** Place the unit so that its back panel is facing you.

Maintenance

Replacing Hard Disks (LTB-8 and LTB-12 Only)

4. Use the markings on the back panel to locate the disk that you want to replace.

LTB-8

Replaceable hard drives

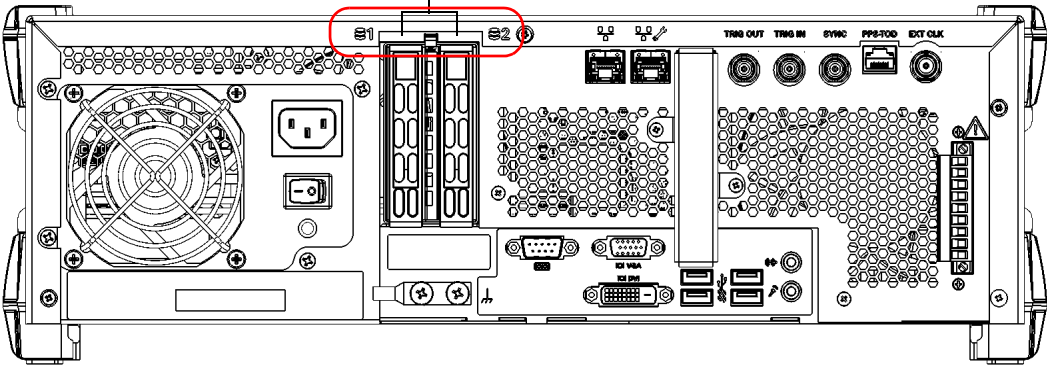

LTB-12

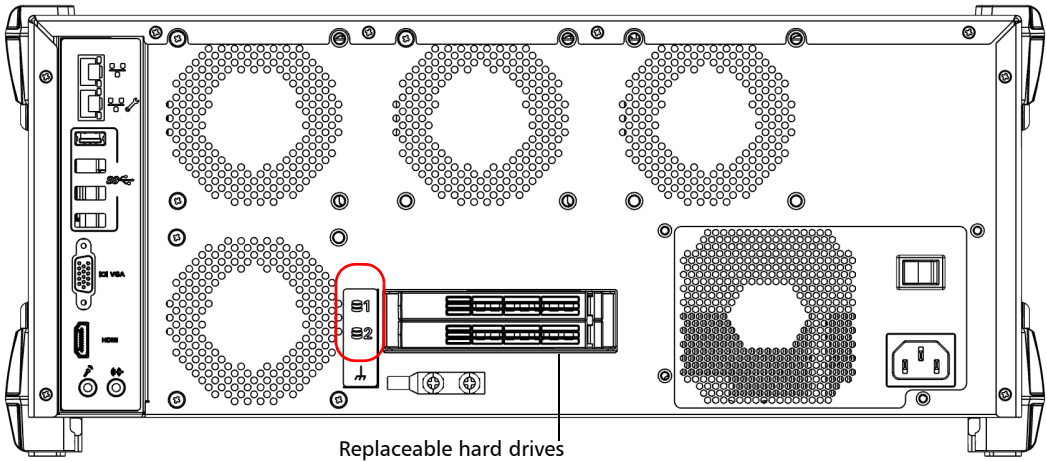

5. Remove the hard disk as follows (there is no need to turn off your unit before proceeding):

- 5a. If you are working with an LTB-8 unit, press the red button (shown in dark grey below) to release the lever.

OR

If you are working with an LTB-12 unit, press the end of the lever towards the left to release the lever.

LTB-8

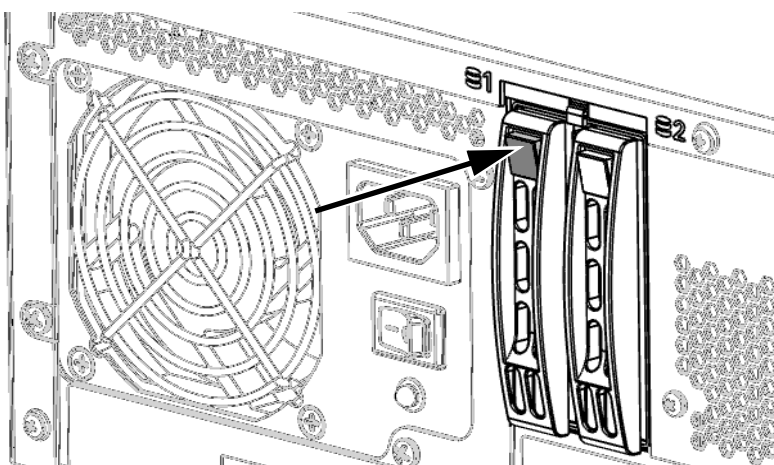

LTB-12

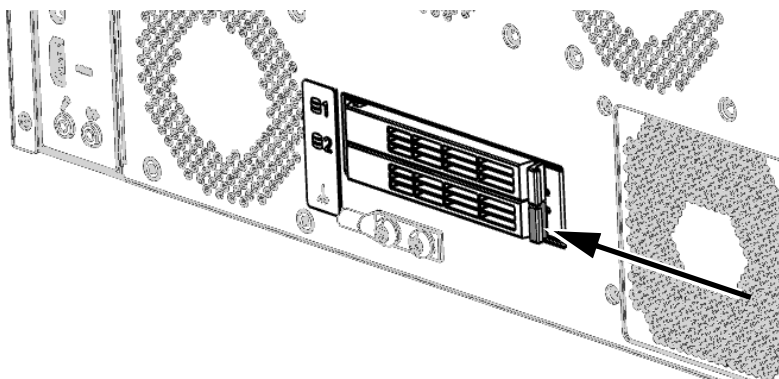

Maintenance

Replacing Hard Disks (LTB-8 and LTB-12 Only)

- 5b.** Once the lever is released from its lock, gently flip the lever away with your finger (down for the LTB-8 and to the left for the LTB-12). The disk will come out of its bay.

LTB-8

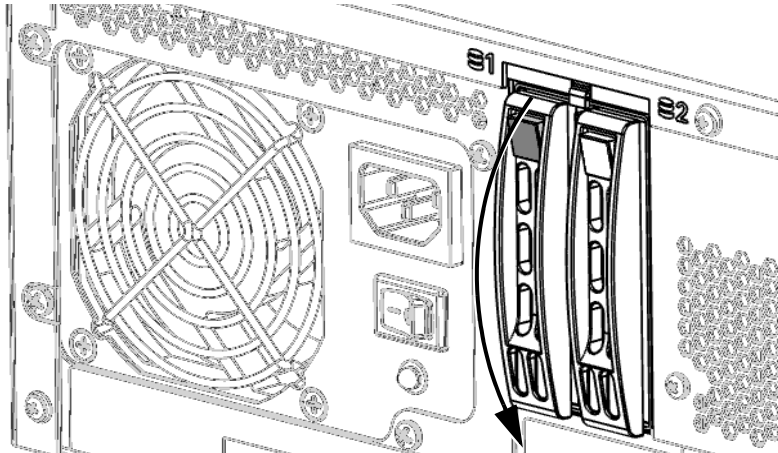

LTB-12

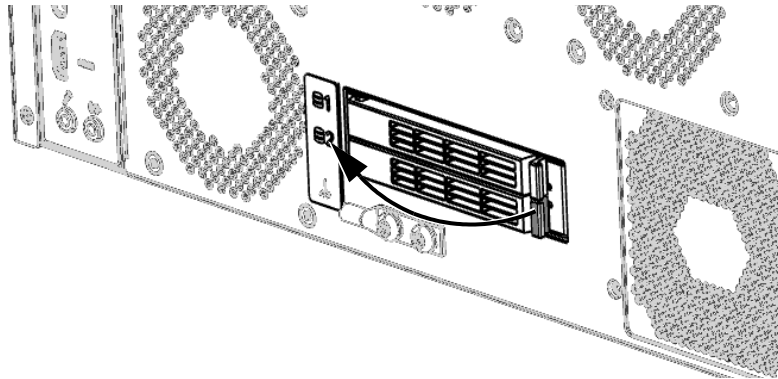

6. Remove the disk completely from your unit and place it on a flat surface as a table as shown below.

LTB-8



LTB-12

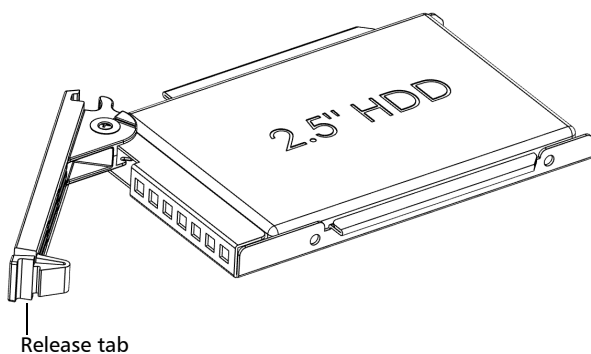

Maintenance

Replacing Hard Disks (LTB-8 and LTB-12 Only)

7. Using a screwdriver, remove the four screws holding the disk in its support.

Note: *Keep the screws close at hand because you will need them to secure the new disk in place later.*

LTB-8

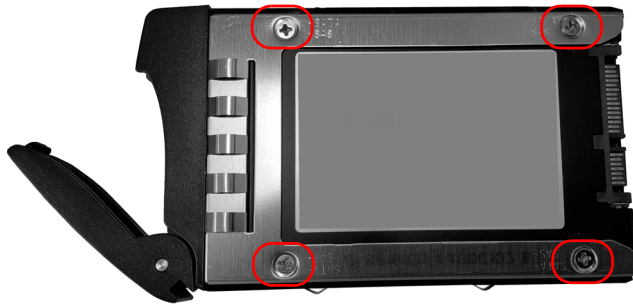

LTB-12

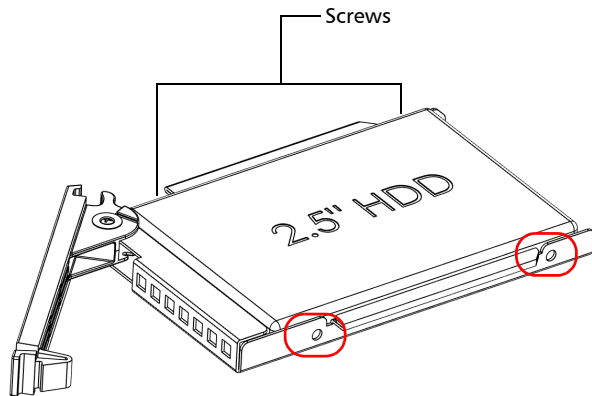

8. Remove the disk by sliding it completely out of its support.

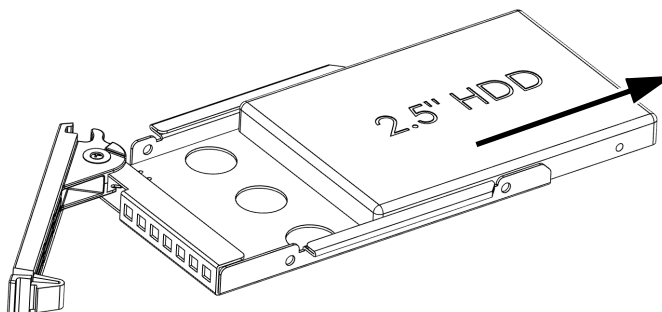

9. Position the new disk so that the circuit board is on the right side. If you are working with an LTB-8 unit, the circuit board should be facing upwards. If you are working with an LTB-12 unit, the circuit board should be facing downwards.

LTB-8

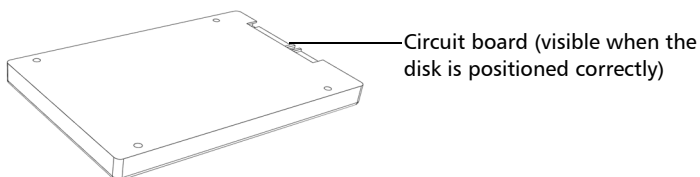

LTB-12

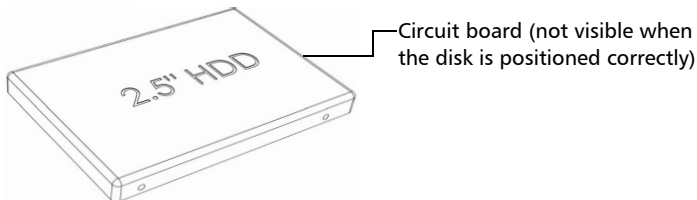

Maintenance

Replacing Hard Disks (LTB-8 and LTB-12 Only)



CAUTION

To avoid damaging the hard disk, always handle it by its case and never touch its circuit board.

10. Slide the disk back in its support, respecting the orientation of the circuit board (upwards for an LTB-8 unit and downwards for an LTB-12 unit).

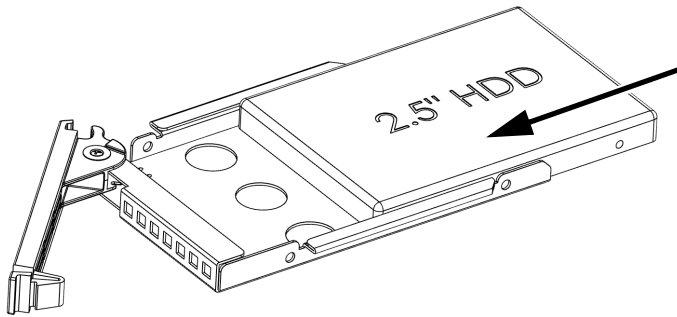

11. Secure the disk in place using the four screws that you removed at step 7.
12. If you are working with an LTB-8 unit, place the disk vertically, ensuring that the red button will be at the top when the disk is back in the unit. If you are working with an LTB-12 unit, place the disk horizontally, ensuring that the release tab will be on the right when the disk is back in the unit.
13. Carefully align the disk with the corresponding bay.

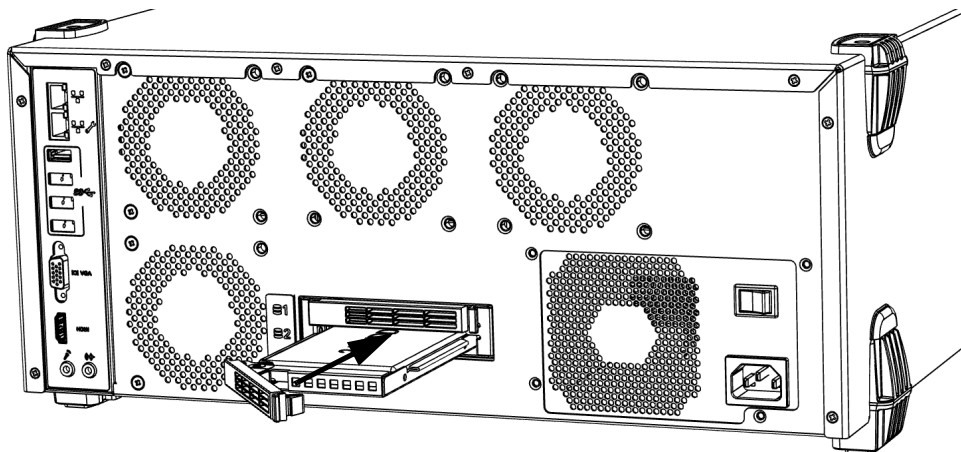

- 14.** Using the lever, gently slide the disk into the bay until it stops.
- 15.** If you are working with an LTB-8 unit, slightly push on the lever until you hear the lock click into place. If you are working with an LTB-12 unit, slightly push on the release tab toward the unit to clip the tab in place and lock the disk.
- 16.** Remove your antistatic strap.

As soon as the new disk is detected, the RAID manager will start rebuilding the corresponding volume. For more information or to access RAID-related parameters, from the Windows notification area, select **Intel Rapid Storage Technology**.

Maintenance

Replacing Fuses (LTB-2 Only)

Replacing Fuses (LTB-2 Only)

The unit contains two F10A L type fuses (5 mm x 20 mm (0.197 in x 0.787 in), fast-acting, 250 V). The fuse carriers are located at the back of the unit, to the left of the main power switch.

To replace a fuse:

1. Turn off the unit and disconnect it from the power source.
2. With a flat-head screwdriver, slightly push in the cap of the fuse carrier while turning counterclockwise until the fuse carrier is released from the unit.

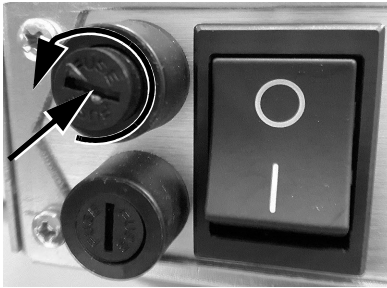

3. Gently pull on the fuse carrier to remove it.



4. Repeat with the second fuse carrier.
5. Check and replace the fuses, if necessary.

6. Insert the new fuse into the fuse carrier.

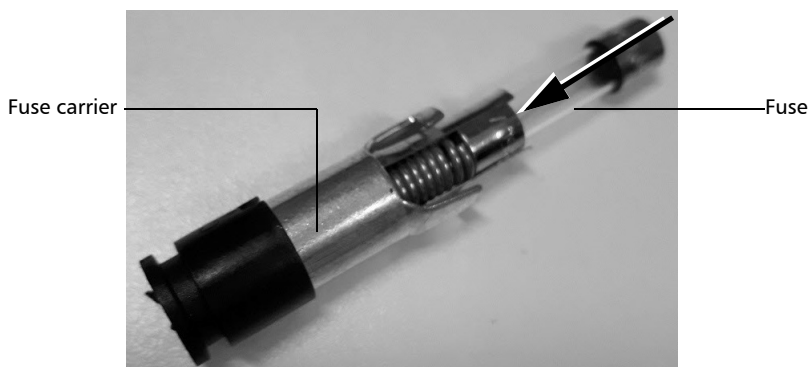

7. Make sure the fuses are placed firmly in the carrier prior to reinsertion.
8. Slide back the first fuse carrier into the unit.
9. With a flat-head screwdriver, slightly push in the cap of the fuse carrier while turning clockwise until the fuse carrier is secured in place.

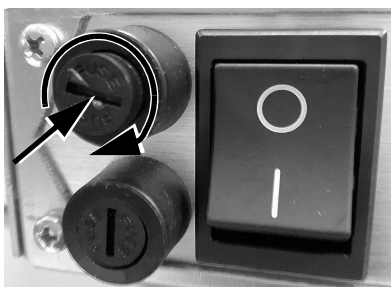

10. Repeat with the second fuse carrier.
11. Connect the unit to the power source and turn on the unit.

Maintenance

Recycling and Disposal

Recycling and Disposal



This symbol on the product means that you should recycle or dispose of your product (including electric and electronic accessories) properly, in accordance with local regulations. Do not dispose of it in ordinary garbage receptacles.

For complete recycling/disposal information, visit the EXFO Web site at www.exfo.com/recycle.

13 Troubleshooting

Solving Common Problems

Before calling EXFO's technical support, you may want to consider the following solutions to problems that could occur.

Problem	Possible Cause	Solution
My unit does not start. Its power LED (🔌) remains off when I press the on/off button.	There is a problem related to electrical power.	<p>LTB-2:</p> <ul style="list-style-type: none">➤ If your unit is connected to DC power, make sure that the disconnect device is turned on.➤ If your unit is connected to AC power, make sure that the external power supply is connected at both ends, and that the disconnect device is turned on.➤ Ensure that the main power switch, located at the back of your unit, is in the on position.➤ Check the fuses (see <i>Replacing Fuses (LTB-2 Only)</i> on page 258).➤ If the unit is connected to DC power, ensure that the wires are connected properly, respecting polarity (see <i>Connecting Your LTB-2 Unit to a Power Source</i> on page 53). <p>LTB-8/LTB-12: Make sure that the external power supply is connected at both ends.</p>

Troubleshooting

Solving Common Problems

Problem	Possible Cause	Solution
My unit does not start (continued)	The system has encountered a problem.	Flip the main power switch (located at the back of the unit) to the off position, and then flip it back to the on position.
	Windows startup files have been corrupted.	Contact EXFO.
My unit is running slower than expected.	The configuration of some of the Windows components is underway in the background.	The first few times that you start your unit, after a reset operation, or after certain updates, you may notice that the performance of your unit is not optimum. If this is the case, you may want to leave your unit idle for about an hour to give Windows the time to complete its configuration tasks.
My unit is not responding.	The system has encountered a problem.	Try to turn off the unit (see <i>Turning off Your Unit</i> on page 64), and then turn it on again. If you cannot turn off the unit, flip the main power switch (located at the back of the unit) to the off position, and then flip it back to the on position.
The USB device I have just connected is not working.	The device has not been detected.	Disconnect, then reconnect the device. Turn off the unit, then turn it on again.
	You do not have the proper driver for this device.	Ensure that you have the right driver (can be provided with the device itself).

Problem	Possible Cause	Solution
The unit does not recognize a test module.	Module application is not installed.	Install the corresponding application using EXFO Software Update (see <i>Installing or Upgrading EXFO Applications</i> on page 75).
	Module is not supported on your unit.	Refer to the unit's technical specifications for the complete list of supported modules.
	Defective module.	If the unit recognizes other modules, the faulty module could be defective. Return it to EXFO for repairs.
The module that I want to use is identified as "Safe to remove" and I do not have the unit close at hand.	The module has been ejected.	From ToolBox X, click the  button corresponding to the module that you want to reconnect.
An error message warns me that there is not enough disk space to perform a refresh operation on my unit.	<ul style="list-style-type: none"> ➤ When you perform a refresh operation, Windows creates a folder (<i>Windows.old</i>) in which the files from the previous installation are stored. This folder now uses too much disk space. ➤ The disk needs a cleanup. 	Remove the <i>Windows.old</i> folder or the unused files with the Disk Cleanup utility. For more information, see <i>Freeing Up Disk Space with the Disk Cleanup Utility</i> on page 145.
I am experiencing communication problems between the VPN client and the VPN server.	The date on your unit may not be properly configured.	Ensure that the date set on your unit corresponds to the current date.

Troubleshooting

Solving Common Problems

Problem	Possible Cause	Solution
I have performed a recovery operation on my unit and I no longer see my EXFO applications.	The unit is running Windows 10 and the recovery operation was performed using the recovery tools from Microsoft instead of the wizard provided by EXFO.	Reset your unit to its factory settings. For more information, see the corresponding procedure in <i>Restoring Your Unit to Normal Operation</i> on page 266.
I need to connect to the AMT Web-based application, but I do not have the IP address of the maintenance ports.	---	<ul style="list-style-type: none">➤ Connect to your unit by using the host (computer) name of your unit. For the LTB-2 and LTB-8, the host name corresponds to: LTB<model>-<serial_number> (Ex.: LTB2-123456). For the LTB-12, it corresponds to LTB-<serial_number>.➤ If the IP address is not visible on the built-in display of the unit, you can also restart the unit. The IP address should be visible after a restart.

Problem	Possible Cause	Solution
I cannot connect remotely to my unit.	Wrong IP address.	Check if the IP address that you have specified for your unit is valid.
	No network cable is connected to your unit.	Ensure that a network cable is properly connected to your unit.
	The unit is restarting.	Wait for the unit to complete the restart operation.
	The unit is not reachable.	Contact your network administrator for network-related troubleshooting.
On the built-in display of the unit, I do not see the IP address that I have configured in the AMT Web-based application.	No network cable is connected to the maintenance port of the unit.	Ensure that a network cable is properly connected to the maintenance port of the unit.

Troubleshooting

Restoring Your Unit to Normal Operation

Restoring Your Unit to Normal Operation

If you ever encounter major problems with your unit (for example, the unit does not behave the way it used to), you can revert it to a previous state. You can revert your unit either to its initial state (as it was at time of purchase), or to a specific state with a backup image (WIM file) created previously.

Note: *For current updates, use EXFO Software Update.*

You can create your own WIM files directly from your unit and store them on a USB key for future use.



IMPORTANT

The WIM files that you create are based on the serial number of your unit. This means that the WIM files created on one unit are only valid to restore this particular unit.



IMPORTANT

The creation of a WIM file implies a compression of the files that are currently installed on your unit. The size of the files after compression cannot be estimated beforehand.

For this reason, the application **WILL NOT PROMPT YOU AT THE BEGINNING** of the operation if the storage capacity (or the file system) of your USB key is not appropriate.



CAUTION

- Before starting one of the recovery operations, connect your unit to a power outlet using the provided AC adapter/charger or power cord.
- **DO NOT TURN OFF** your unit while the recovery operation is underway. Doing so may severely damage your unit. Damaged units will need to be sent back to EXFO for repair.

The recovery operations that are offered for your unit depend on the operating system that it is running.

Troubleshooting

Restoring Your Unit to Normal Operation

Windows 10

When you want to restore your unit, there are several options. The table below gives an overview of the possibilities.

Method	Description
Restore	<ul style="list-style-type: none">➤ The unit will be reverted to the state in which it was when the WIM file was created.➤ All data files will be lost once the operation is complete.➤ If you have installed products and updates since the WIM file was created, you will have to reinstall them.
Reset to factory settings	<ul style="list-style-type: none">➤ The unit will be reverted to its initial state.➤ All data files will be lost once the operation is complete.➤ If you have installed products and updates since you purchased your unit, you will have to reinstall them.



IMPORTANT

To avoid problems, always use the wizard provided by EXFO to revert your unit to a previous state, not the recovery tools provided by Microsoft.



IMPORTANT

The size of the WIM will depend on the disk space that is currently used on your unit.

To avoid problems, always use a USB key with an NTFS file system, and a minimum of 16 GB of free disk space.

To create a WIM file for your unit:

1. From the task bar, click the **Start** button () , and then **Settings** ().
2. Click **Update & security**.

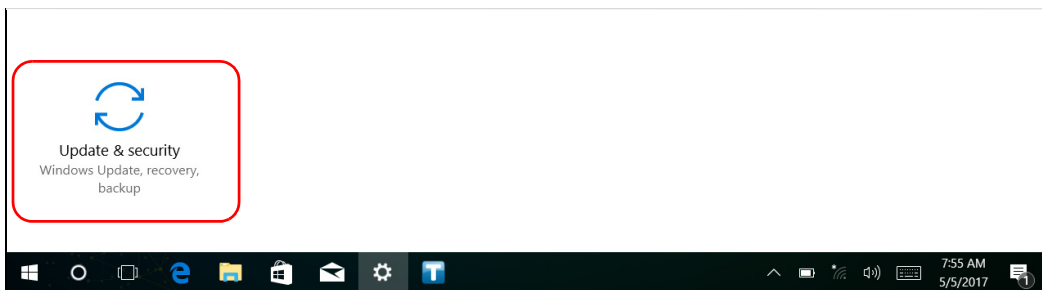

Troubleshooting

Restoring Your Unit to Normal Operation

3. Select **Recovery**.

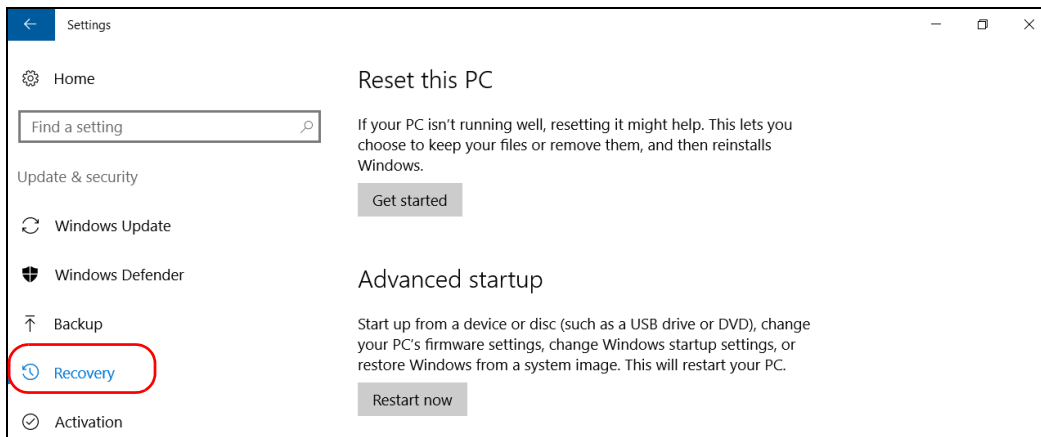

4. Under **Advanced Startup**, click **Restart now**.

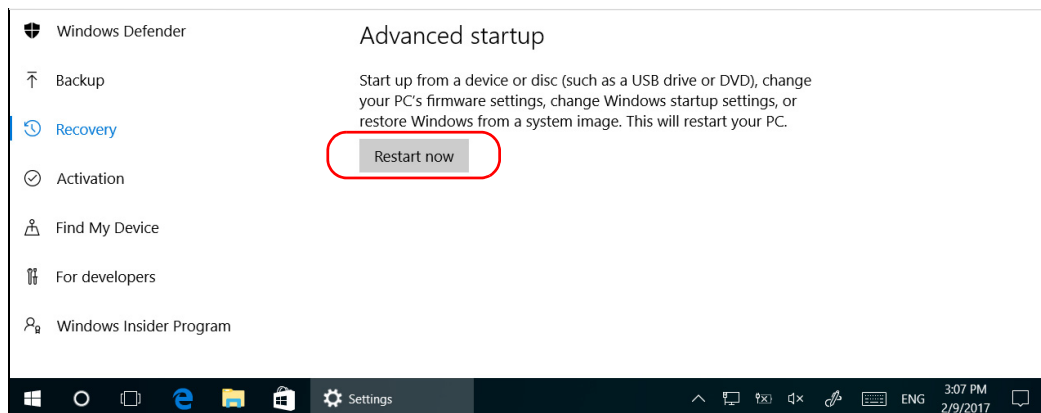

5. Under **Choose an option**, click **Troubleshoot**.

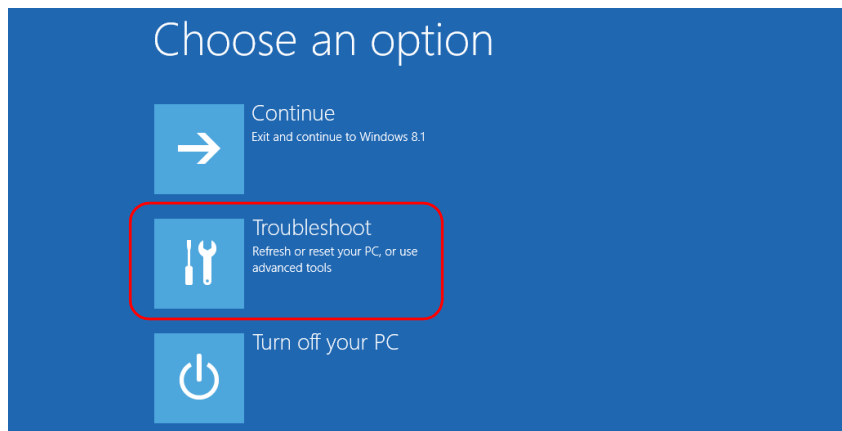

6. Click **Platform Imaging Utility** to display the corresponding application.

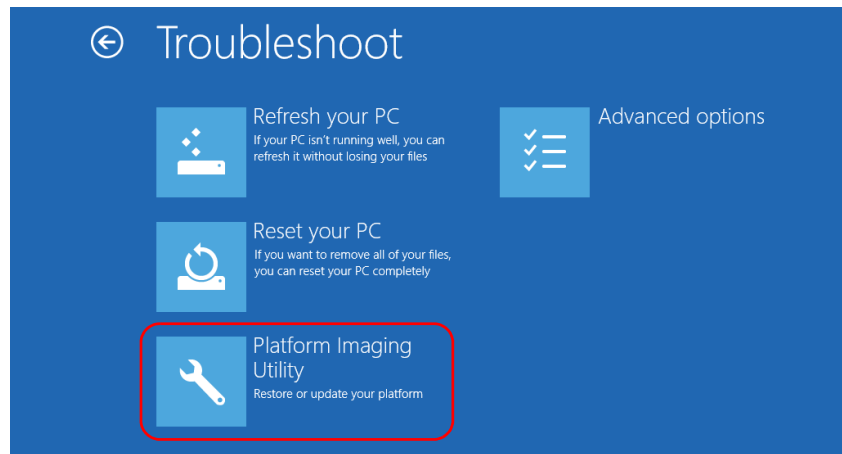

7. Connect a USB key to your unit.

Troubleshooting

Restoring Your Unit to Normal Operation

- From the Platform Servicing and Imaging Utility wizard, select **Create a WIM file**, and then click **Next**.

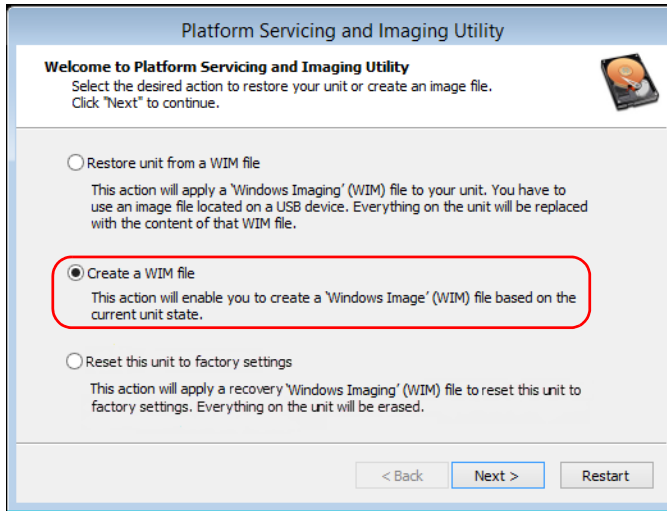

- Click **Browse**.

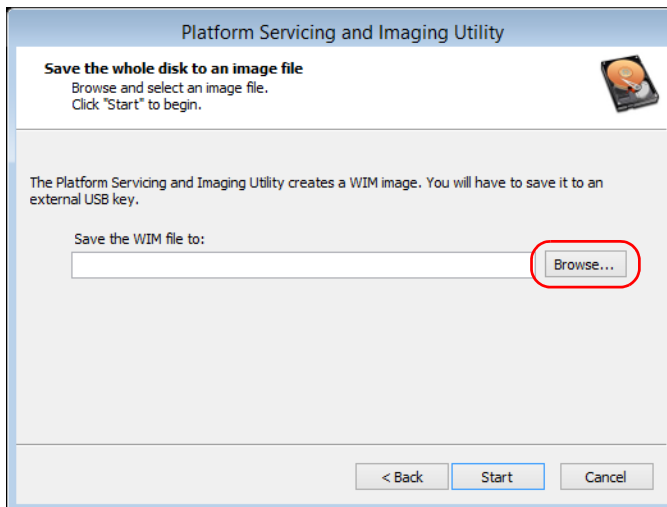

- 10.** Locate the USB key, and then double-click its identifier to access the contents.
- 11.** Select the desired folder.
- 12.** Enter a file name, and then click **Save**.
- 13.** Click **Start**.

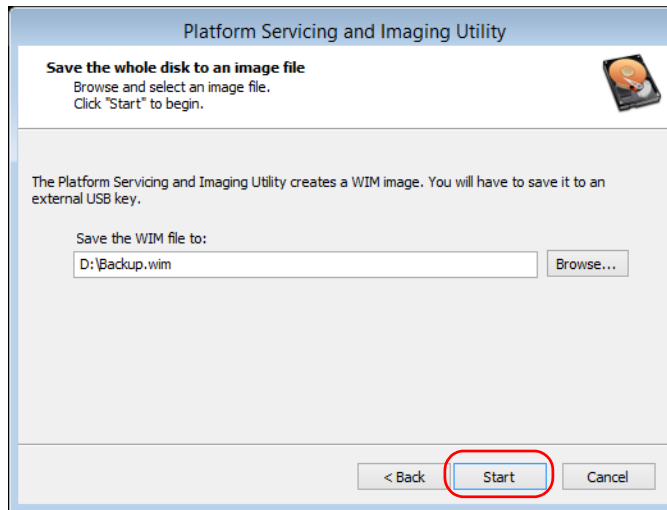

Note: *The time required to create the image varies with the configuration of your unit.*

- 14.** When the operation is complete and the application prompts you, click **OK**.
- 15.** Disconnect the USB key.

Troubleshooting

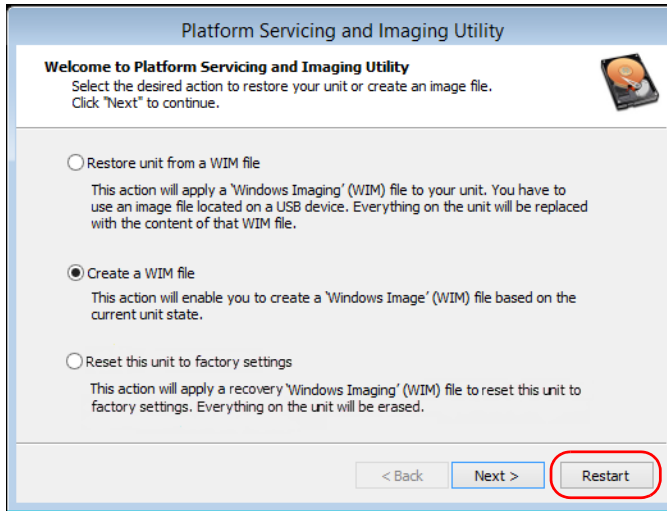

Restoring Your Unit to Normal Operation

16. Click **Cancel** to return to the Welcome window of the utility.
17. Click **Restart**.



The WIM file is ready for future use.

To revert your unit to a previous state with a WIM file:

1. Ensure that your unit will remain powered on during the operation.
2. If desired, back up your data.
3. From the task bar, click the **Start** button (), and then **Settings** ().
4. Click **Update & security**.

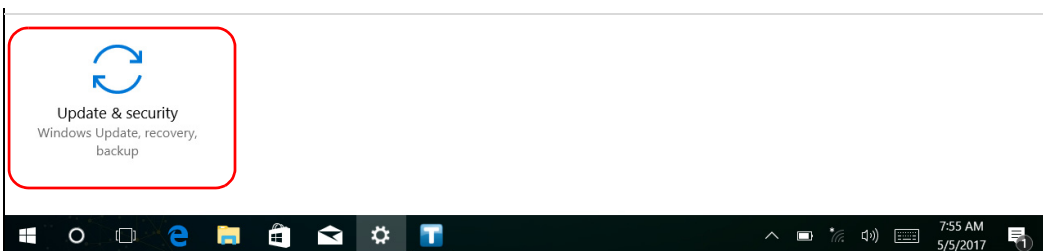

5. Select **Recovery**.

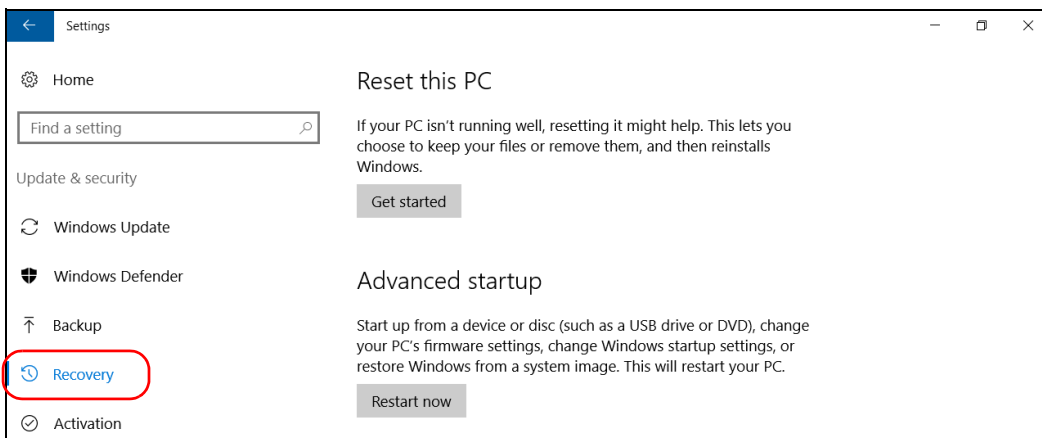

6. Under **Advanced Startup**, click **Restart now**.

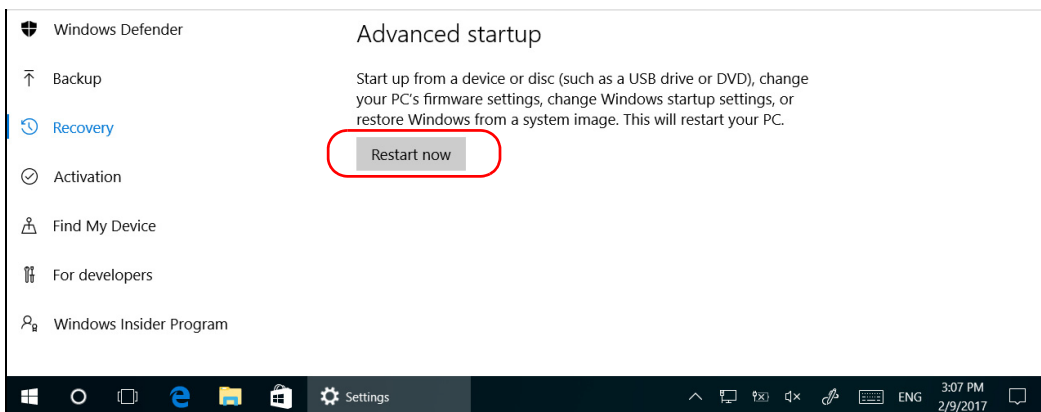

Troubleshooting

Restoring Your Unit to Normal Operation

- Under **Choose an option**, click **Troubleshoot**.

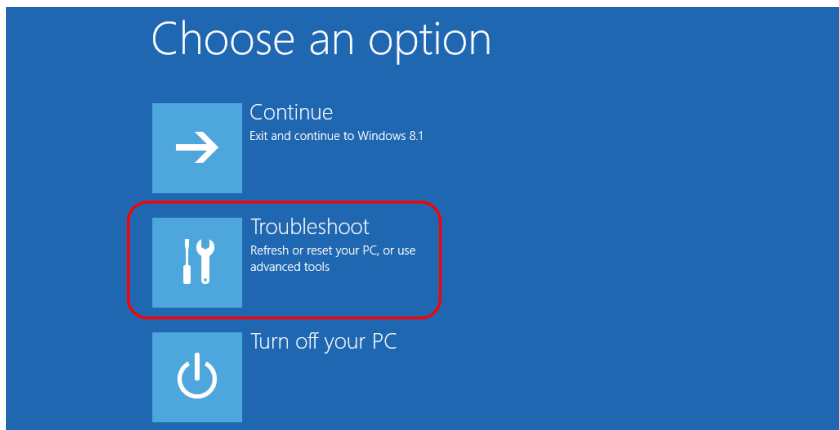

- Click **Platform Imaging Utility** to display the corresponding application.

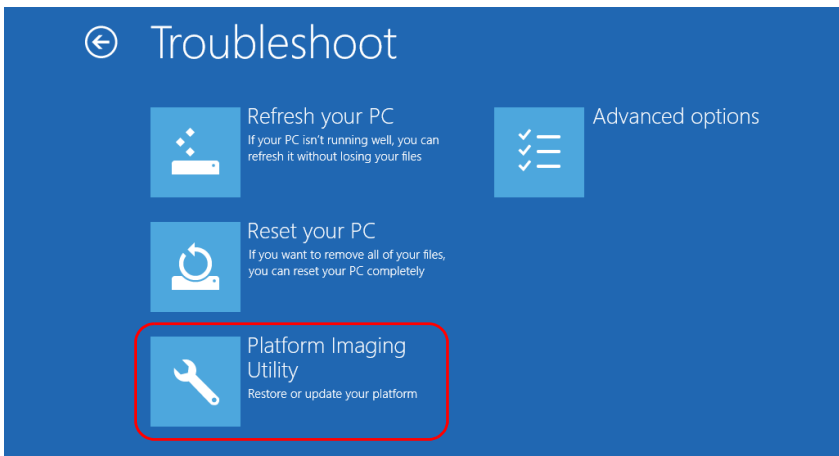

- Connect the USB key with the desired WIM file to your unit.

10. From the Platform Servicing and Imaging Utility wizard, select **Restore unit from a WIM file**, and then click **Next**.

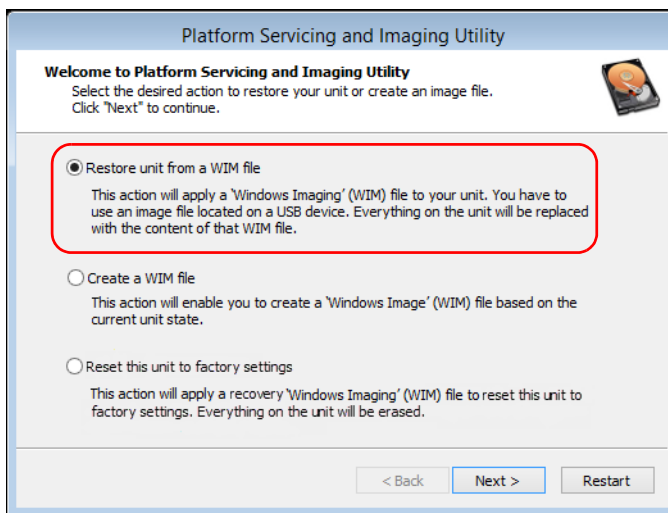

11. Click **Browse**.

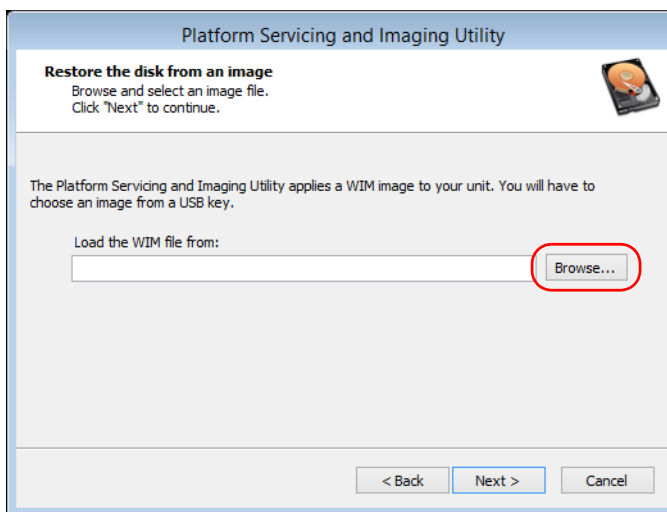

Troubleshooting

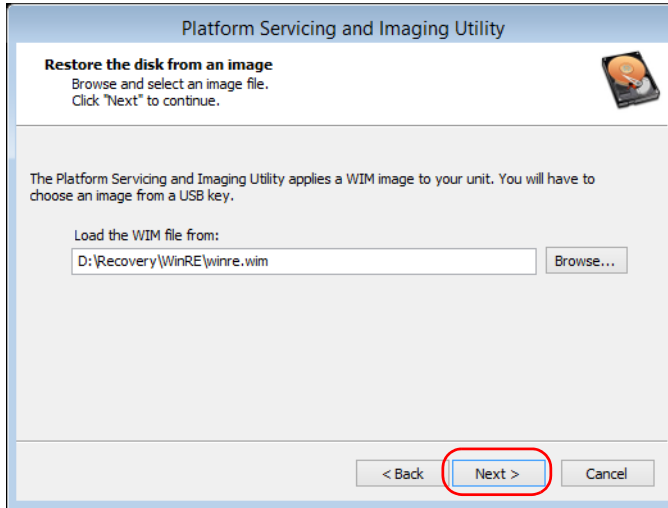

Restoring Your Unit to Normal Operation

- 12.** Locate the USB key, and then double-click its identifier to access the contents.
- 13.** Select the desired WIM file.
- 14.** Click **Next**.



- 15.** Read the warning, and then click **Start** to restore the unit with the selected image.
 - 16.** When the operation is complete and the application prompts you, disconnect the USB key, and then click **OK**.
- The unit will restart.

To reset your unit to its factory settings:

1. Ensure that your unit will remain powered on during the operation.
2. If desired, back up your data.
3. From the task bar, tap the **Start** button (), and then **Settings** ().
4. Tap **Update & security**.

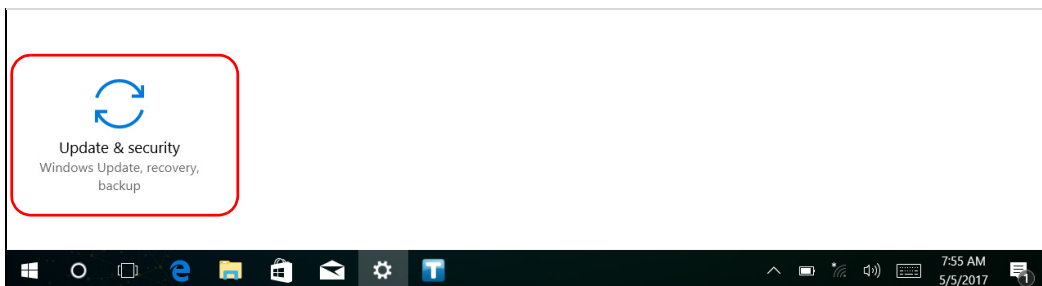

Troubleshooting

Restoring Your Unit to Normal Operation

5. Select **Recovery**.

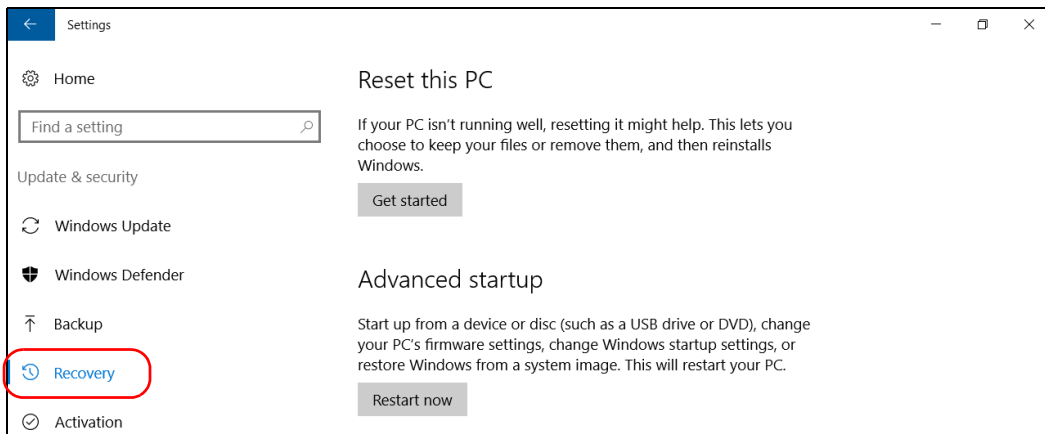

6. Under **Advanced Startup**, tap **Restart now**.

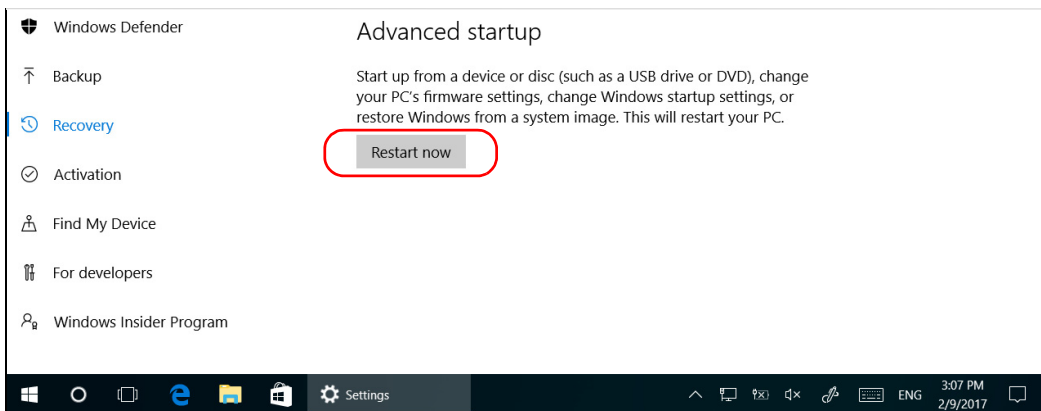

7. Under **Choose an option**, tap **Troubleshoot**.

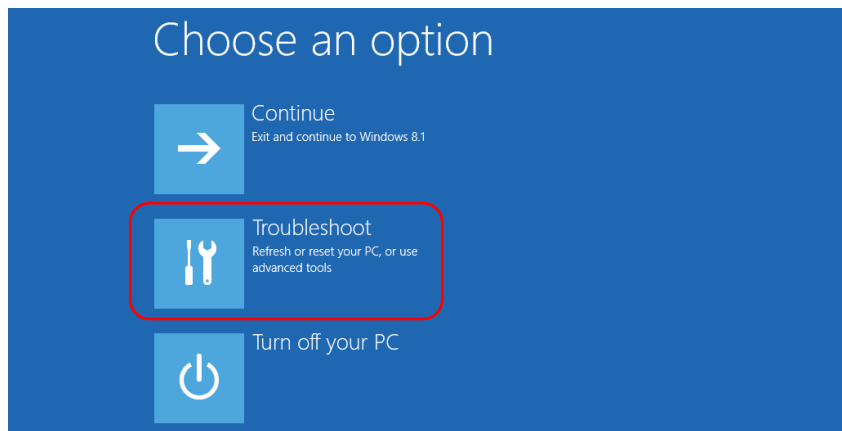

8. Tap **Platform Imaging Utility** to display the corresponding application.

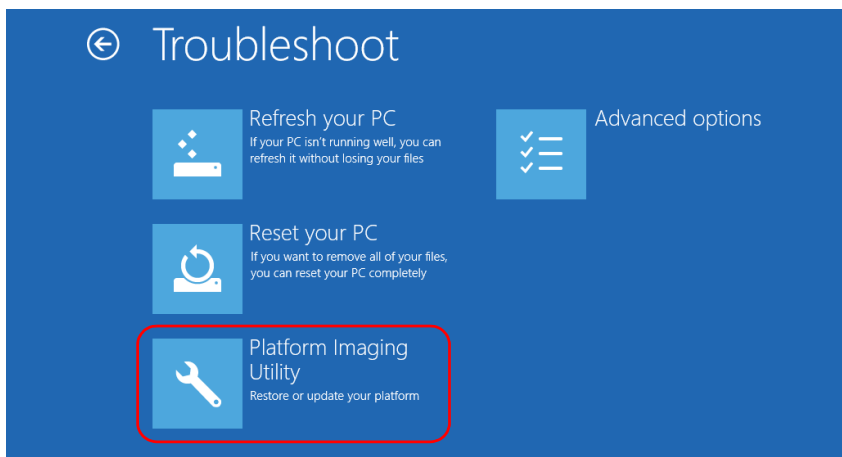

Troubleshooting

Restoring Your Unit to Normal Operation

9. From the Platform Servicing and Imaging Utility wizard, select **Reset this unit to factory settings**, and then tap **Next**.

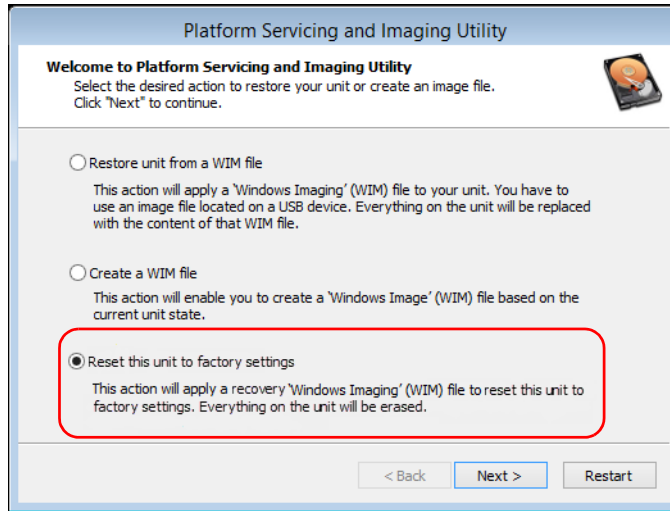

10. Read the warning, and then tap **Start** to restore the unit with the selected image.
11. When the operation is complete and the application prompts you, tap **OK**.
The unit will restart.
12. Configure the regional parameters, and accept the license agreements as you did when you first received your unit (see *Configuring Your Unit At First Startup* on page 66).

Windows 8.1 Pro (Some LTB-8 Units Only)

When you want to restore your unit, there are several options. The table below gives an overview of the possibilities.

Method	Description
Refresh	<ul style="list-style-type: none"> ➤ The unit will be reverted to its initial state. ➤ All data files that were saved to the default personal folders (Documents, Pictures, etc.) will still be available once the operation is complete. ➤ If you have installed products and updates since you purchased your unit, you will have to reinstall them. ➤ Refer to Microsoft documentation for more information.
Reset	<ul style="list-style-type: none"> ➤ The unit will be reverted to its initial state. ➤ All data files will be lost once the operation is complete. ➤ If you have installed products and updates since you purchased your unit, you will have to reinstall them. ➤ Refer to Microsoft documentation for more information.
Restore	<ul style="list-style-type: none"> ➤ The unit will be reverted to the state in which it was when the WIM file was created. ➤ All data files will be lost once the operation is complete. ➤ If you have installed products and updates since the WIM file was created, you will have to reinstall them.

Troubleshooting

Restoring Your Unit to Normal Operation



IMPORTANT

- ▶ **Refresh operation:** All the data that is stored in the default personal folders will still be available once the operation is complete. However, any data stored in other folders will be lost. You may want to back up this data before refreshing your unit.
- ▶ **Reset and restore operations:** To avoid losing the data that is stored on your unit, you may want to back it up before resetting or restoring your unit. Otherwise, all your files will be lost.



IMPORTANT

The size of the WIM will depend on the disk space that is currently used on your unit.

To avoid problems, always use a USB key with an NTFS file system, and a minimum of 16 GB of free disk space.

To create a WIM file for your unit:

1. On your unit, from the right side of the screen, swipe left to display the Charm bar.
2. Click **Settings** > **Change PC settings**.

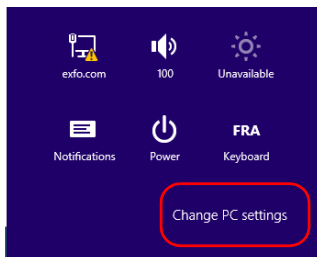

3. Click **Update and recovery**.

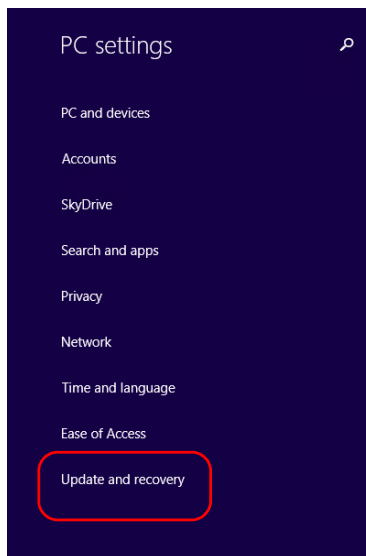

Personalize

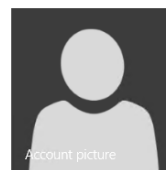

[View recently used settings](#)

4. Click **Recovery**.

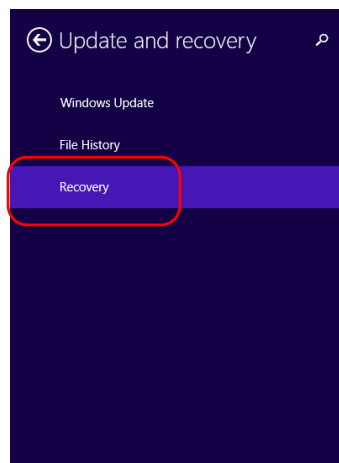

Refresh your PC without affecting your files

If your PC isn't running well, you can refresh it without losing your photos, music, videos or other personal files.

[Get started](#)

Remove everything and reinstall Windows

If you want to recycle your PC or start over completely, you can reset it to its factory settings.

[Get started](#)

Advanced startup

Start up from a device or disc (such as a USB drive or DVD), change your PC's firmware settings, change Windows startup settings, or restore Windows from a system image. This will refresh your PC.

[Restart now](#)

Troubleshooting

Restoring Your Unit to Normal Operation

5. Under **Advanced Startup**, click **Restart now**.

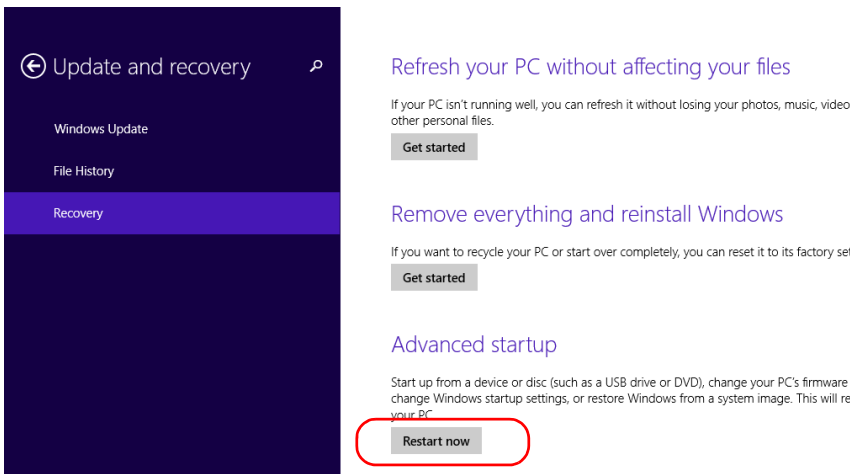

Update and recovery

- Windows Update
- File History
- Recovery

Refresh your PC without affecting your files

If your PC isn't running well, you can refresh it without losing your photos, music, video or other personal files.

Get started

Remove everything and reinstall Windows

If you want to recycle your PC or start over completely, you can reset it to its factory set

Get started

Advanced startup

Start up from a device or disc (such as a USB drive or DVD), change your PC's firmware, change Windows startup settings, or restore Windows from a system image. This will re your PC.

Restart now

6. Under **Choose an option**, click **Troubleshoot**.

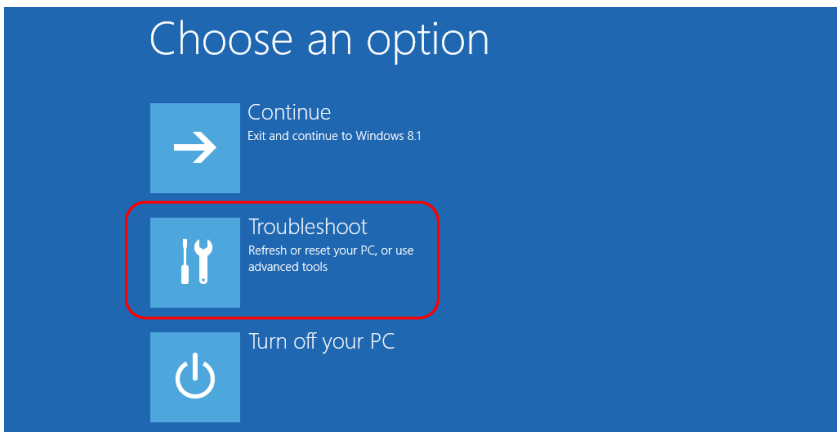

Choose an option

- Continue
Exit and continue to Windows 8.1
- Troubleshoot
Refresh or reset your PC, or use advanced tools
- Turn off your PC

7. Click **Platform Imaging Utility** to display the corresponding application.

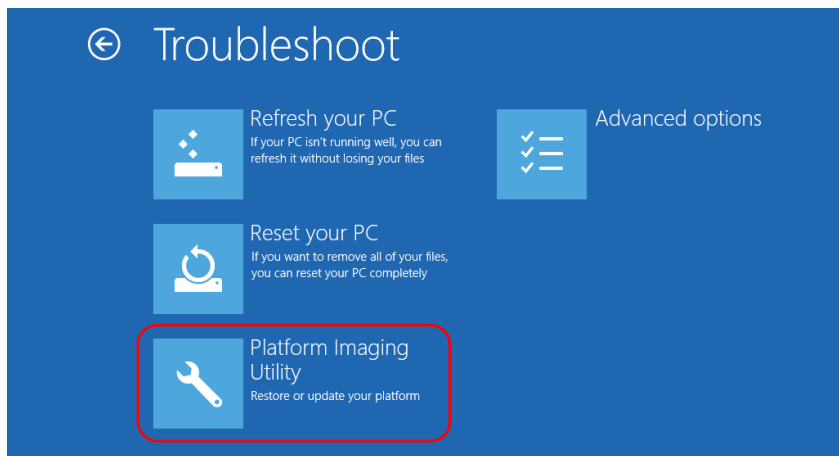

8. Connect a USB key to your unit.

Troubleshooting

Restoring Your Unit to Normal Operation

- From the Platform Servicing and Imaging Utility wizard, select **Create a WIM file**, and then click **Next**.

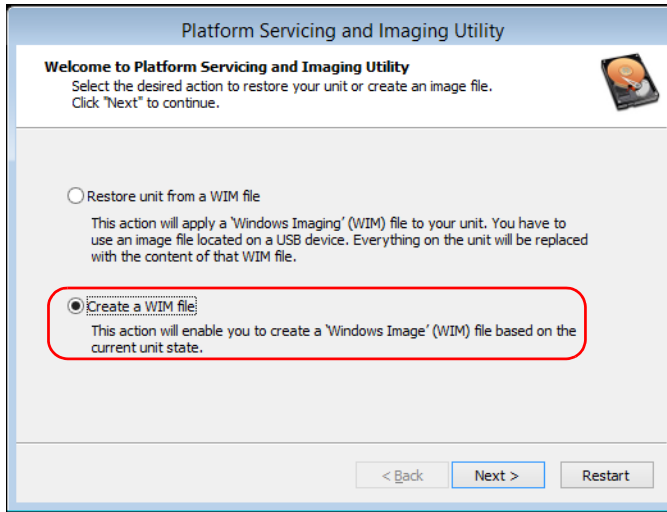

- Click **Browse**.

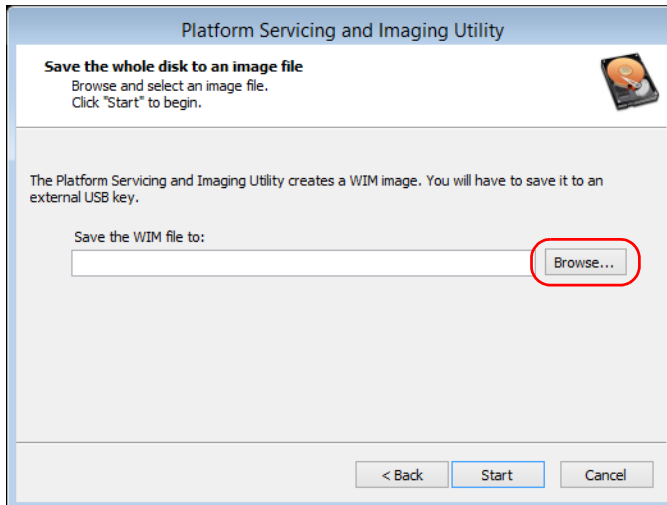

- 11.** Locate the USB key, and then double-click its identifier to access the contents.
- 12.** Select the desired folder.
- 13.** Enter a file name, and then click **Save**.
- 14.** Click **Start**.

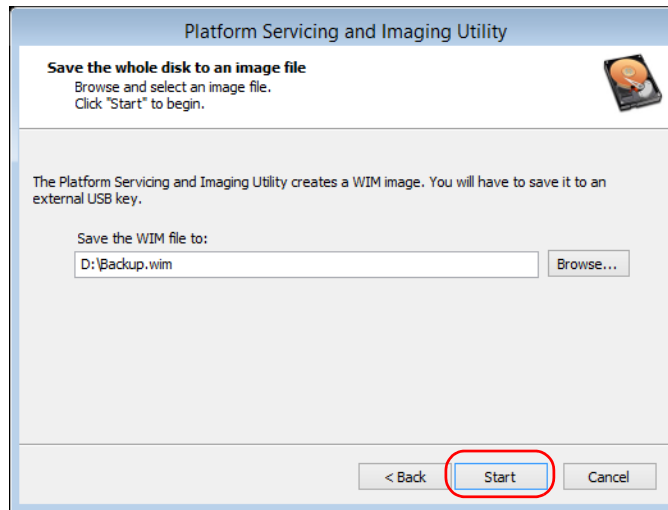

Note: *The time required to create the image varies with the configuration of your unit.*

- 15.** When the operation is complete and the application prompts you, click **OK**.
- 16.** Disconnect the USB key.

Troubleshooting

Restoring Your Unit to Normal Operation

17. Click **Cancel** to return to the Welcome window of the utility.

18. Click **Restart**.

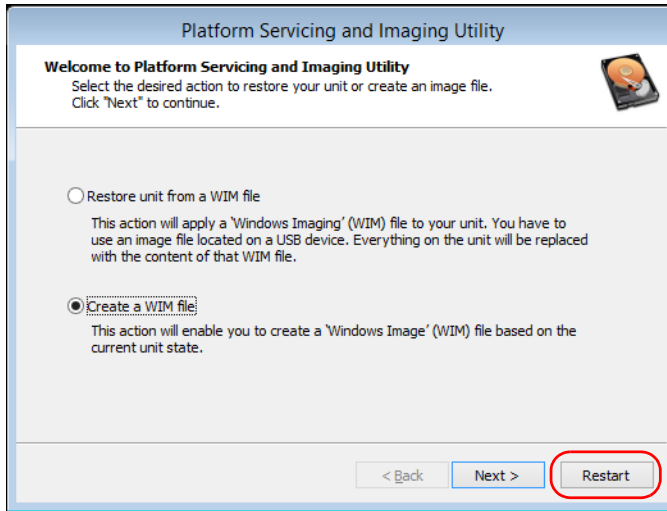

The WIM file is ready for future use.

To revert your unit to a previous state:

- 1.** Ensure that your unit will remain powered on during the operation.
- 2.** If desired, back up your data.
- 3.** On your unit, from the right side of the screen, swipe left to display the Charm bar.

4. Click **Settings** > **Change PC settings**.

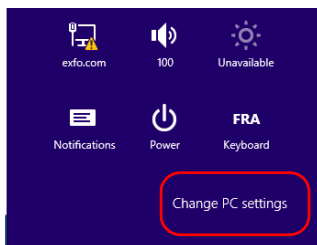

5. Click **Update and recovery**.

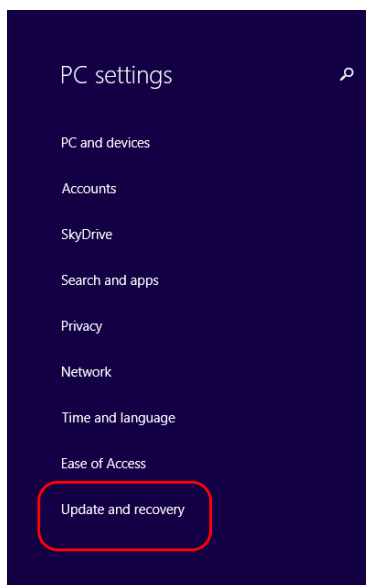

Personalize

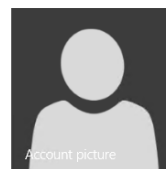

[View recently used settings](#)

Troubleshooting

Restoring Your Unit to Normal Operation

6. Click **Recovery**.

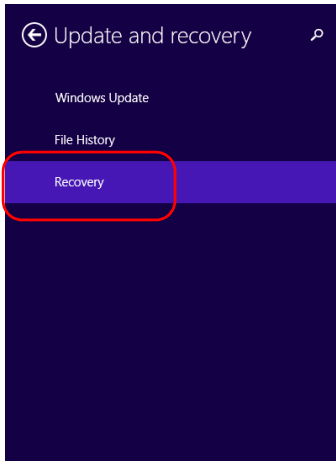

Refresh your PC without affecting your files

If your PC isn't running well, you can refresh it without losing your photos, music, video or other personal files.

[Get started](#)

Remove everything and reinstall Windows

If you want to recycle your PC or start over completely, you can reset it to its factory se

[Get started](#)

Advanced startup

Start up from a device or disc (such as a USB drive or DVD), change your PC's firmware change Windows startup settings, or restore Windows from a system image. This will n your PC.

[Restart now](#)

7. If you want to refresh or reset your unit, proceed as follows:

7a. Click the **Get started** button corresponding to your choice.

A diagram showing the 'Get started' buttons for 'Refresh your PC without affecting your files' and 'Remove everything and reinstall Windows'. The diagram is enclosed in a red rounded rectangle. On the left, there are two labels: 'To refresh your unit' and 'To reset your unit'. Lines connect these labels to the 'Get started' buttons. The 'Refresh your PC without affecting your files' section includes a description: 'If your PC isn't running well, you can refresh it without losing your photos, music, videos, and other personal files.' The 'Remove everything and reinstall Windows' section includes a description: 'If you want to recycle your PC or start over completely, you can reset it to its factory settings.' Below this diagram, the 'Advanced startup' section is also visible, with a description: 'Start up from a device or disc (such as a USB drive or DVD), change your PC's firmware settings, change Windows startup settings, or restore Windows from a system image. This will restart your PC.' and a 'Restart now' button.

7b. Follow the on-screen instructions.

8. If you want to restore your unit (with a WIM file), proceed as follows:

8a. Under **Advanced Startup**, click **Restart now**.

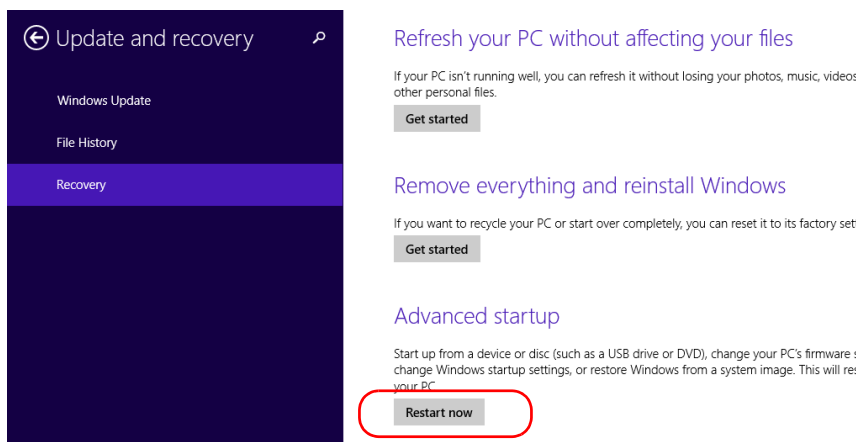

8b. Under **Choose an option**, click **Troubleshoot**.

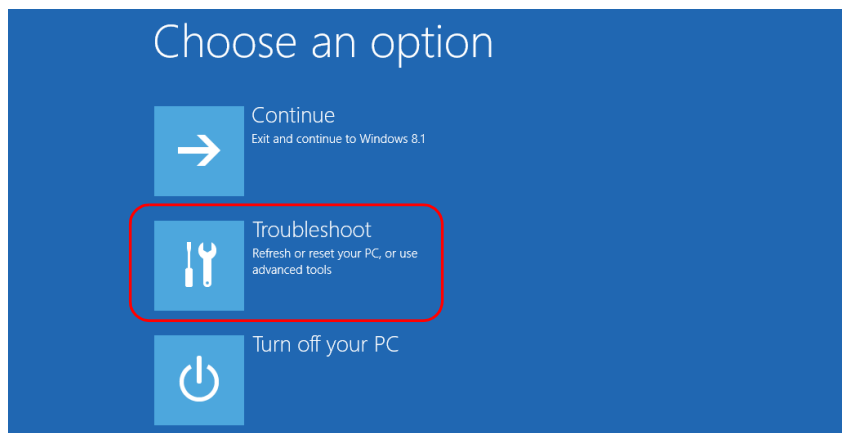

Troubleshooting

Restoring Your Unit to Normal Operation

- 8c.** Click **Platform Imaging Utility** to display the corresponding application.

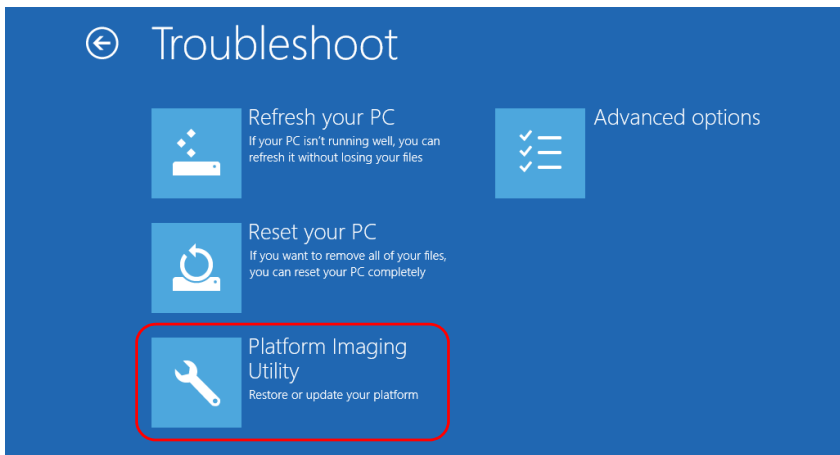

- 8d.** Connect the USB key with the desired WIM file to your unit.

- 8e.** From the Platform Servicing and Imaging Utility wizard, select **Restore unit from a WIM file**, and then click **Next**.

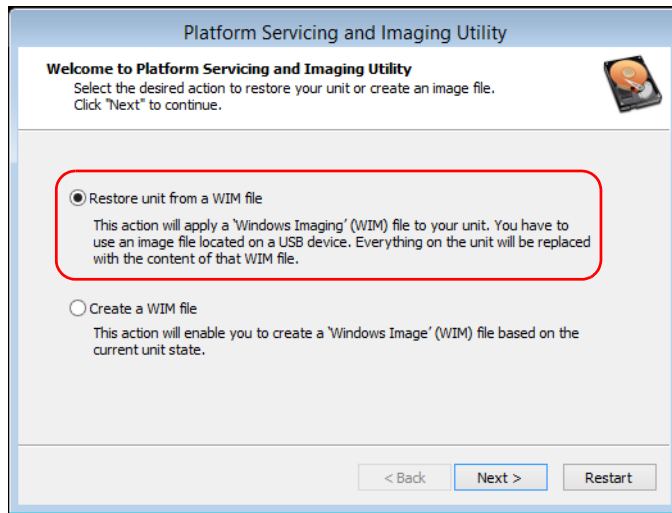

- 8f.** Click **Browse**.

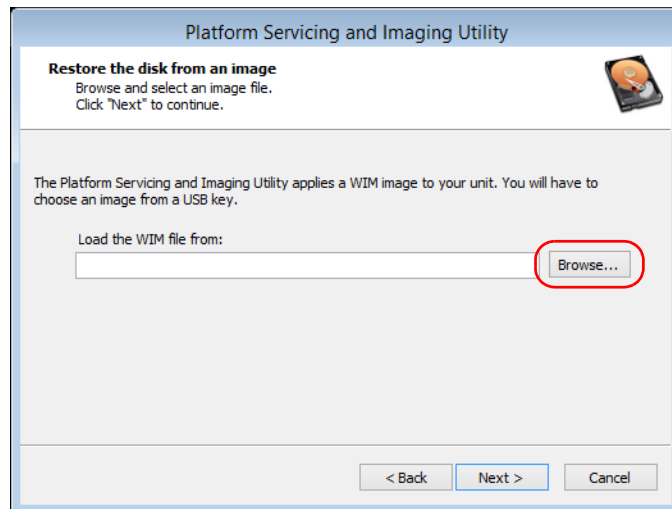

Troubleshooting

Restoring Your Unit to Normal Operation

- 8g.** Locate the USB key, and then double-click its identifier to access the contents.
- 8h.** Select the desired WIM file.
- 8i.** Click **Next**.

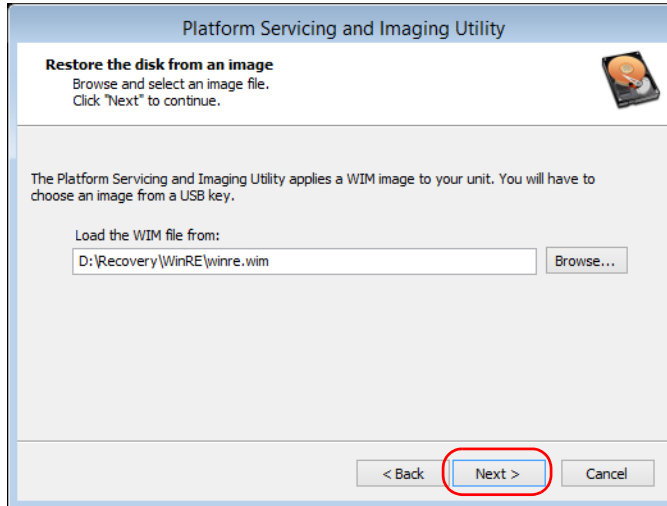

- 8j.** Read the warning, and then click **Start** to restore the unit with the selected image.
- 8k.** When the operation is complete and the application prompts you, disconnect the USB key, and then click **OK**.

The unit will restart.

Accessing the Online Documentation

You can access the user documentation as well as the license agreements at all times from your unit.

There are two formats of user documentation provided on your unit: online help and complete user guides (for products having safety instructions). When you open user documentation in PDF format from ToolBox X (or the configuration wizard), the files are displayed automatically in the provided PDF viewer.

Note: *The user guides of all products are available from the EXFO Web site (www.exfo.com) for download in PDF format.*

To view the online help:

From ToolBox X or an instrument application, click  (or the equivalent).

To view the documentation in PDF format:

1. From the main window, click the **Utilities** button.
2. Click the icon corresponding to the type of document that you want to view.

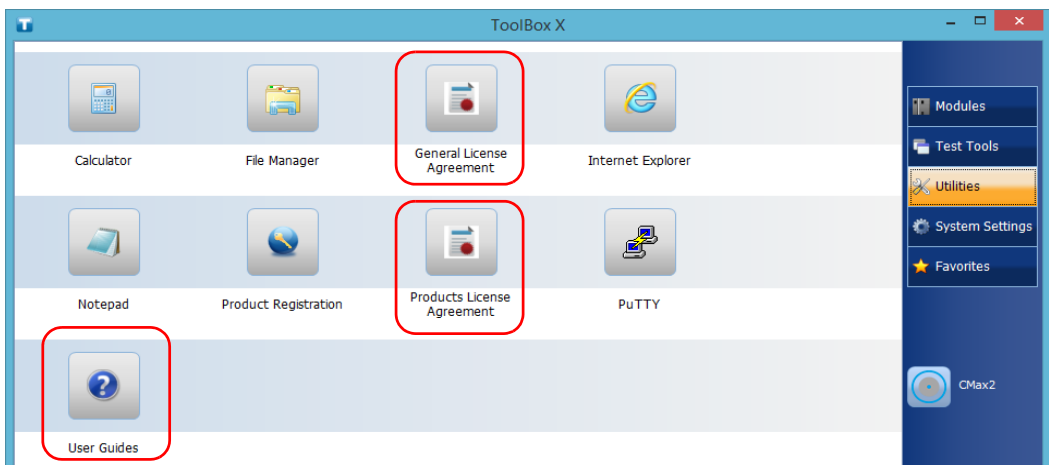

Troubleshooting

Contacting the Technical Support Group

Contacting the Technical Support Group

To obtain after-sales service or technical support for this product, contact EXFO at one of the following numbers. The Technical Support Group is available to take your calls from Monday to Friday, 8:00 a.m. to 7:00 p.m. (Eastern Time in North America).

Technical Support Group

400 Godin Avenue
Quebec (Quebec) G1M 2K2
CANADA

1 866 683-0155 (USA and Canada)
Tel.: 1 418 683-5498
Fax: 1 418 683-9224
support@exfo.com

For detailed information about technical support, and for a list of other worldwide locations, visit the EXFO Web site at www.exfo.com.

If you have comments or suggestions about this user documentation, you can send them to customer.feedback.manual@exfo.com.

To accelerate the process, please have information such as the name and the serial number (see the product identification label), as well as a description of your problem, close at hand.

Retrieving the Hardware Version of Your Unit

Some features of your unit may vary according to its hardware version, as identified in this documentation. You can view the hardware version of your unit on the label affixed to the back of your unit.



Viewing System Information

You can easily access important information such as the serial number, version number for ToolBox X, or network interfaces information directly from your unit. You can also find the contact information if you ever need to reach EXFO.

Retrieving the Serial Number of Your Unit

The serial number of your unit is easily accessible from ToolBox X.

Note: *You can also view the serial number on the label affixed to the back of your unit.*

To retrieve the serial number of your unit:

1. In the lower right corner of the main window, click .
2. Click the **Platform** tab.

The serial number is displayed.

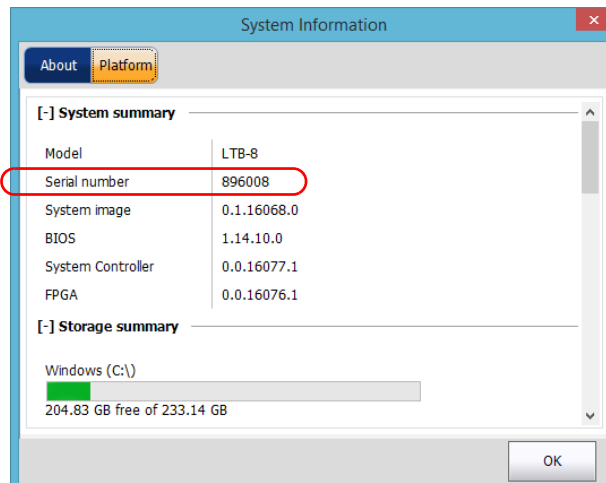

Note: *The serial numbers of your modules are visible from the **Modules** window.*

Troubleshooting

Viewing System Information

Retrieving the Toolbox X Version

You can view the version of ToolBox X that is installed on your unit.

To retrieve the ToolBox X version:

1. In the lower right corner of the main window, click .
2. Click the **About** tab.

The version number is displayed.



Retrieving Network Interfaces Information

You can view the information related to the network interfaces (adapters) such as the status of the interfaces, the IP address, etc.

To retrieve network interfaces information:

1. In the lower right corner of the main window, click .
2. Click the **Platform** tab.

The information is displayed (one section per network interface).

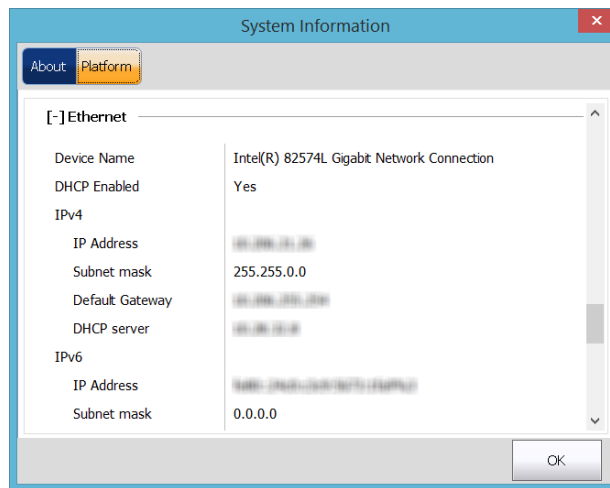

Note: The IP address that you need to access AMT is not visible from Windows, and thus not visible from ToolBox X either. It is visible from the built-in display on the front panel of your unit. For more information on AMT, see Connecting to Your Unit Remotely With AMT Remote Access on page 121.

Troubleshooting

Viewing System Information

Retrieving the Contact Information

All the information necessary to contact EXFO is available from your unit.

To retrieve the contact information:

1. In the lower right corner of the main window, click .
2. Click the **About** tab.

The contact information is displayed.



Transportation

Maintain a temperature range within specifications when transporting the unit. Transportation damage can occur from improper handling. The following steps are recommended to minimize the possibility of damage:

- Pack the unit in its original packing material when shipping.
- Avoid high humidity or large temperature fluctuations.
- Keep the unit out of direct sunlight.
- Avoid unnecessary shocks and vibrations.

14 **Warranty**

General Information

EXFO Inc. (EXFO) warrants this equipment against defects in material and workmanship for a period of two years from the date of original shipment. EXFO also warrants that this equipment will meet applicable specifications under normal use.

During the warranty period, EXFO will, at its discretion, repair, replace, or issue credit for any defective product, as well as verify and adjust the product free of charge should the equipment need to be repaired or if the original calibration is erroneous. If the equipment is sent back for verification of calibration during the warranty period and found to meet all published specifications, EXFO will charge standard calibration fees.



IMPORTANT

The warranty can become null and void if:

- **unit has been tampered with, repaired, or worked upon by unauthorized individuals or non-EXFO personnel.**
- **warranty sticker has been removed.**
- **case screws, other than those specified in this guide, have been removed.**
- **case has been opened, other than as explained in this guide.**
- **unit serial number has been altered, erased, or removed.**
- **unit has been misused, neglected, or damaged by accident.**

THIS WARRANTY IS IN LIEU OF ALL OTHER WARRANTIES EXPRESSED, IMPLIED, OR STATUTORY, INCLUDING, BUT NOT LIMITED TO, THE IMPLIED WARRANTIES OF MERCHANTABILITY AND FITNESS FOR A PARTICULAR PURPOSE. IN NO EVENT SHALL EXFO BE LIABLE FOR SPECIAL, INCIDENTAL, OR CONSEQUENTIAL DAMAGES.

Warranty

Gray Market and Gray Market Products

Gray Market and Gray Market Products

Gray market is a market where products are traded through distribution channels that are legal but remain unofficial, unauthorized, or unintended by the original manufacturer. Intermediaries using such channels to distribute products are considered to be part of the gray market (hereafter unauthorized intermediary).

EXFO considers that a product originates from the gray market (hereafter gray market product) in the following situations:

- A product is sold by an unauthorized intermediary.
- A product is designed and destined for a particular market and sold on a second market.
- A product is resold, despite being reported lost or stolen.

When products are purchased on the gray market, rather than through an authorized EXFO distribution channel, EXFO is unable to guarantee the source and quality of those products nor the local safety regulations and certifications (CE, UL, etc.).

EXFO will not honor warranty, install, maintain, repair, calibrate, provide technical support nor make any support contracts available for gray market products.

For complete information, refer to EXFO's policy regarding gray market products at www.exfo.com/en/how-to-buy/sales-terms-conditions/gray-market/

Liability

EXFO shall not be liable for damages resulting from the use of the product, nor shall be responsible for any failure in the performance of other items to which the product is connected or the operation of any system of which the product may be a part.

EXFO shall not be liable for damages resulting from improper usage or unauthorized modification of the product, its accompanying accessories and software.

Exclusions

EXFO reserves the right to make changes in the design or construction of any of its products at any time without incurring obligation to make any changes whatsoever on units purchased. Accessories, including but not limited to fuses, pilot lamps, batteries and universal interfaces (EUI) used with EXFO products are not covered by this warranty.

This warranty excludes failure resulting from: improper use or installation, normal wear and tear, accident, abuse, neglect, fire, water, lightning or other acts of nature, causes external to the product or other factors beyond the control of EXFO.



IMPORTANT

In the case of products equipped with optical connectors, EXFO will charge a fee for replacing connectors that were damaged due to misuse or bad cleaning.

Certification

EXFO certifies that this equipment met its published specifications at the time of shipment from the factory.

Service and Repairs

EXFO commits to providing product service and repair for five years following the date of purchase.

To send any equipment for service or repair:

1. Call one of EXFO's authorized service centers (see *EXFO Service Centers Worldwide* on page 309). Support personnel will determine if the equipment requires service, repair, or calibration.
2. If equipment must be returned to EXFO or an authorized service center, support personnel will issue a Return Merchandise Authorization (RMA) number and provide an address for return.
3. If possible, back up your data before sending the unit for repair.
4. Pack the equipment in its original shipping material. Be sure to include a statement or report fully detailing the defect and the conditions under which it was observed.
5. Return the equipment, prepaid, to the address given to you by support personnel. Be sure to write the RMA number on the shipping slip. *EXFO will refuse and return any package that does not bear an RMA number.*

Note: *A test setup fee will apply to any returned unit that, after test, is found to meet the applicable specifications.*

After repair, the equipment will be returned with a repair report. If the equipment is not under warranty, you will be invoiced for the cost appearing on this report. EXFO will pay return-to-customer shipping costs for equipment under warranty. Shipping insurance is at your expense.

Routine recalibration is not included in any of the warranty plans. Since calibrations/verifications are not covered by the basic or extended warranties, you may elect to purchase FlexCare Calibration/Verification Packages for a definite period of time. Contact an authorized service center (see *EXFO Service Centers Worldwide* on page 309).

EXFO Service Centers Worldwide

If your product requires servicing, contact your nearest authorized service center.

EXFO Headquarters Service Center

400 Godin Avenue
Quebec (Quebec) G1M 2K2
CANADA

1 866 683-0155 (USA and Canada)
Tel.: 1 418 683-5498
Fax: 1 418 683-9224
support@exfo.com

EXFO Europe Service Center

Winchester House, School Lane
Chandlers Ford, Hampshire S053 4DG
ENGLAND

Tel.: +44 2380 246800
Fax: +44 2380 246801
support.europe@exfo.com

EXFO Telecom Equipment (Shenzhen) Ltd.

3rd Floor, Building C,
FuNing Hi-Tech Industrial Park, No. 71-3,
Xintian Avenue,
Fuhai, Bao'An District,
Shenzhen, China, 518103

Tel: +86 (755) 2955 3100
Fax: +86 (755) 2955 3101
support.asia@exfo.com

To view EXFO's network of partner-operated Certified Service Centers nearest you, please consult EXFO's corporate website for the complete list of service partners:

<http://www.exfo.com/support/services/instrument-services/exfo-service-centers>.

A Data Types

The following section provides an overview of the most common data types that may appear in EXFO's documentation on commands and queries. The information is supplied for guidance only.

For more detailed information, please refer to IEEE 488.2 and SCPI standards.

Data types are divided into two groups: <PROGRAM DATA> for the types that are used when you want to send messages to a device and <RESPONSE DATA> for the types that are used when a device sends responses to the controller.

The data types are presented in graphics often referred to as "railroad diagrams". The following example illustrates how to interpret such diagrams.

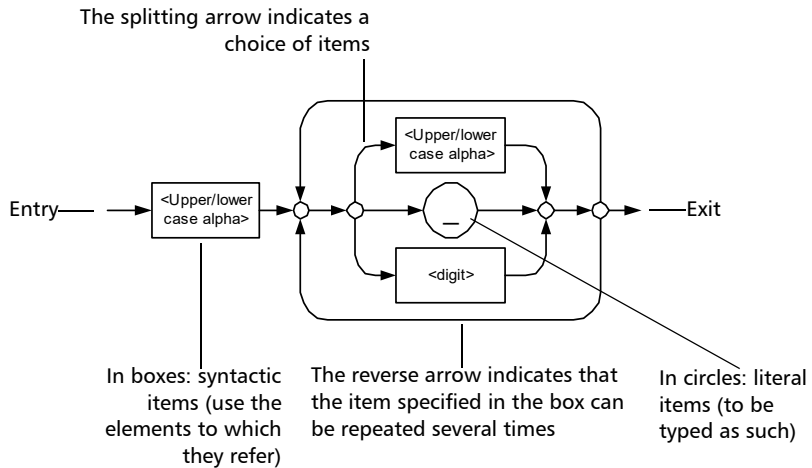

Data Types

Applicable Data Types for Input—IEEE 488.2

Applicable Data Types for Input—IEEE 488.2

- <PROGRAM MESSAGE TERMINATOR>

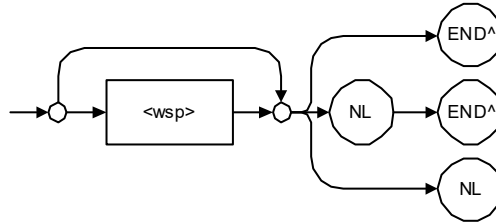

In the diagram above,

- “NL” corresponds to ASCII character code 10, in decimal (0A in binary)
- “END ^” corresponds to the last data byte of the message sent with EOI = True and ATN = False

➤ **<CHARACTER PROGRAM DATA>**

This data type will be used to send short mnemonics when a *<DECIMAL NUMERIC PROGRAM DATA>* cannot be used.

Examples: TRIANGLEWAVE, NCONTINUOUS

➤ **<DECIMAL NUMERIC PROGRAM DATA>** (or **<NRf>**)

This data type includes **<NR1>**, **<NR2>** and **<NR3>** data types. It will be used for decimal fractions with or without an exponent. Instruments will adapt the values they receive to fit their degree of precision. For example, if an instrument has a precision of two digits after the decimal point and the incoming value is 12.048, this value will be rounded off to 12.05.

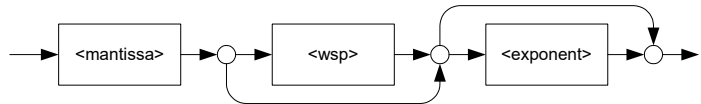

The second diagram below illustrates the **<mantissa>** syntax.

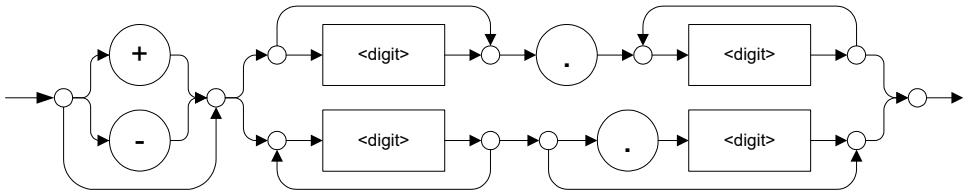

The third diagram illustrates the **<exponent>** syntax.

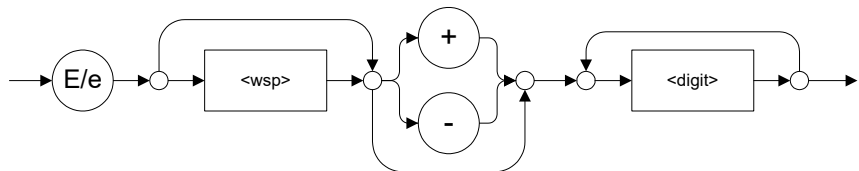

Examples: +2.0 e5, -.56E+4, 6.5e-10

Data Types

Applicable Data Types for Input—IEEE 488.2

➤ <NON-DECIMAL NUMERIC PROGRAM DATA>

This data type will be used for integer representation in hexadecimal (base 16), octal (base 8) or binary (base 2). The numeric representations will begin with “#H” for hexadecimal, “#Q” for octal and “#B” for binary.

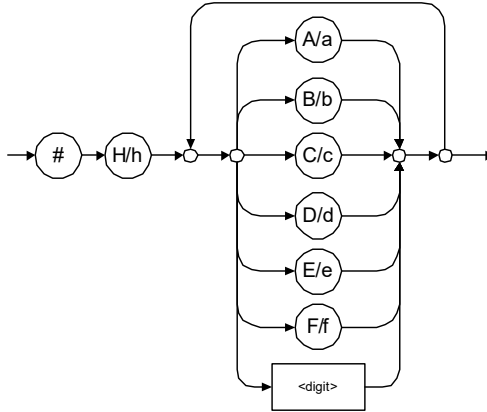

Examples: #Hf3bc015d, #h01a4, #hfe

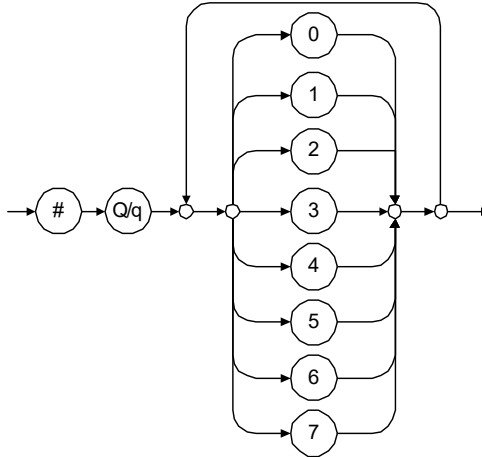

Examples: #Q1234567, #q1275, #q07

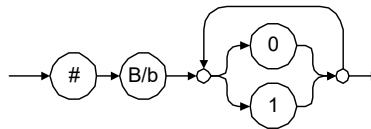

Examples: #B10010111, #b10110, #b1100

Data Types

Applicable Data Types for Input—IEEE 488.2

➤ <STRING PROGRAM DATA>

This data type will be used for strings containing 7-bit ASCII characters that have to be enclosed in either single- or double-quotes delimiters.

If a string needs to contain a character that is exactly the same as the delimiter, make sure to double the character to avoid syntax errors.

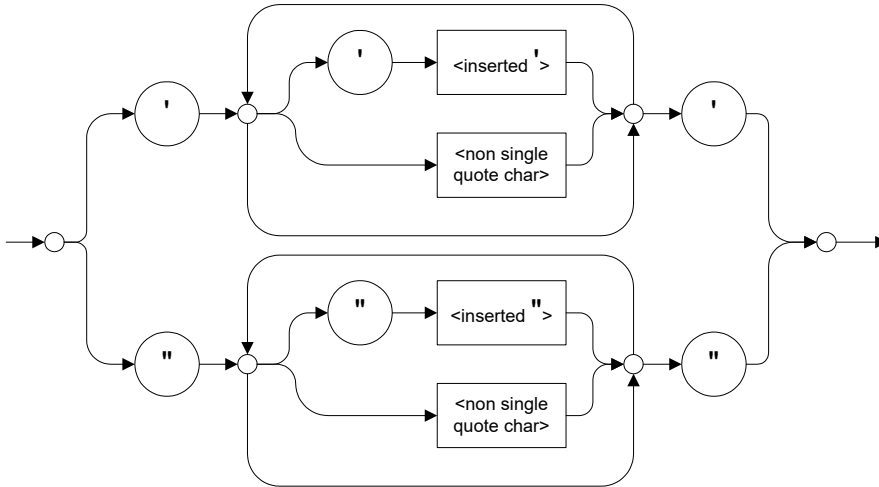

Examples: "SCPI Commands", 'SCPI Commands', "SCPI 'Commands'",
'SCPI "Commands"', "SCPI ""Commands""", 'SCPI '''Commands'''

➤ <ARBITRARY BLOCK PROGRAM DATA>

This data type is used to send blocks of arbitrary 8-bit information when you need to work with large amounts of data.

The actual length of the data that you send has the following structure:

- The first byte contains the # character.
- The byte that immediately follows contains the number of subsequent bytes that you have to check to obtain the total length.

Note: *If you use a zero as the first digit (#0), it has to be followed by a <PROGRAM MESSAGE TERMINATOR > so that the device will detect the end of the <ARBITRARY BLOCK PROGRAM DATA>. This will also force immediate termination of the message.*

For example, if you send the following data (here, values are expressed in decimal instead of binary for easier readability):

2 1 3 7 6 8 9 2 ...

The byte that immediately follows the # contains 2, which means that you would have to read the two following bytes to know the length (in bytes) of the retrieved data. The bytes indicate 1 and 3. The length will then be 13 bytes. The actual response will begin at byte number 5, in this case.

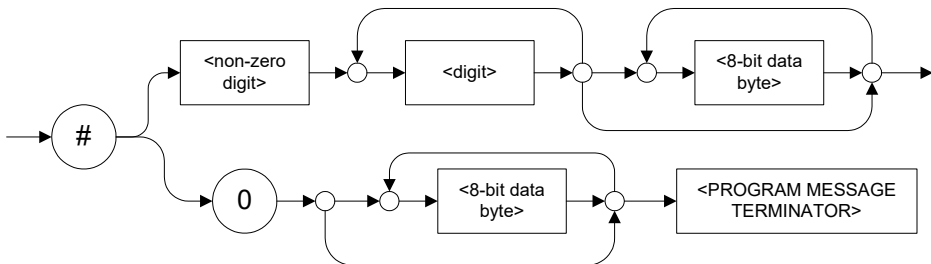

Data Types

Applicable Data Types for Input—IEEE 488.2

► <SUFFIX PROGRAM DATA>

This data type is used when units and multipliers have to be sent.

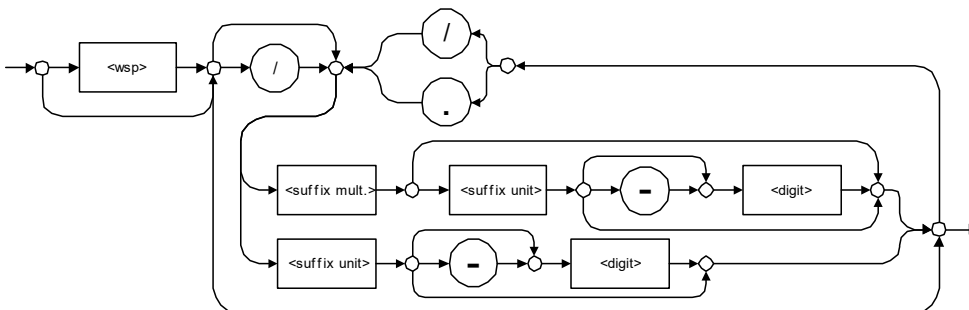

Examples: nm, kHz, km/s², uW

A relative unit (dB) can be referenced to an absolute level, as shown on the following diagram.

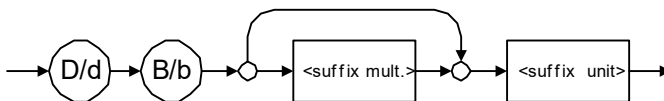

Examples: db, dbm, dBW

The following table illustrates the possible forms for <suffix mult.>:

Name	Value	Mnemonic
Exa	1E18	EX
Peta	1E15	PE
Tera	1E12	T
Giga	1E9	G
Mega	1E6	MA
Kilo	1E3	K
Milli	1E-3	M
Micro	1E-6	U
Nano	1E-9	N
Pico	1E-12	P
Femto	1E-15	F
Atto	1E-18	A

Data Types

Applicable Data Types for Input—IEEE 488.2

The table below gives the possible forms for <suffix unit> :

Reference Unit	Suffix Unit
Degrees	DEG
Radians	RAD
Amperes	A
Volts	V
Hertz	HZ
Meters	M
Watts	W
DBs ref to 1mW	DBM
Decibels	DB
Degrees Celsius	CEL
Degrees Fahrenheit	FAR
Kelvins	K
Seconds	S
Hours	HR
Minutes	MIN

Applicable Data Types for Output —IEEE 488.2

- <RESPONSE MESSAGE TERMINATOR>

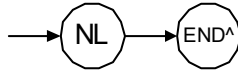

In the diagram above,

- “NL” corresponds to ASCII character code 10, in decimal (0A in binary)
- “END ^” corresponds to the last data byte of the message sent with EOI = True and ATN = False
- <CHARACTER RESPONSE DATA>

This data type will be used by a device to return short mnemonics when a <DECIMAL NUMERIC PROGRAM DATA> cannot be used. The returned information is sent in the long form and in upper case.

Examples: TRIANGLEWAVE, NCONTINUOUS

Data Types

Applicable Data Types for Output —IEEE 488.2

- <NR1 NUMERIC RESPONSE DATA> (or <NR1>)

This data type will be used by a device to return positive or negative integers.

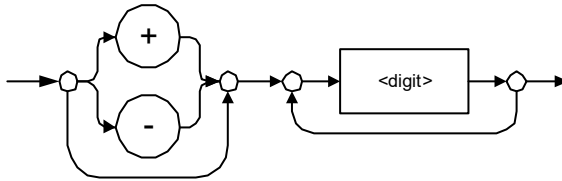

Examples: 4, -23, 90

- <NR2 NUMERIC RESPONSE DATA> (or <NR2>)

This data type will be used by a device to return positive or negative real numbers (fixed-point numbers).

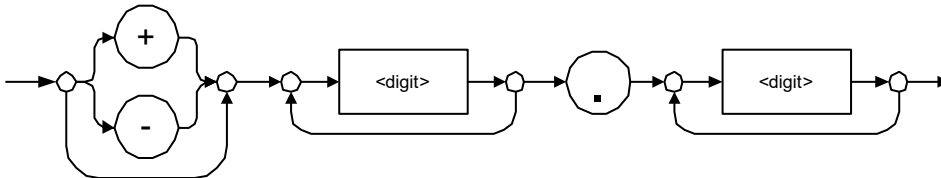

Examples: 23.45, 1.22, -4.55

➤ **<NR3 NUMERIC RESPONSE DATA> (or <NR3>)**

This data type will be used by a device to return positive or negative exponential numbers (floating-point numbers).

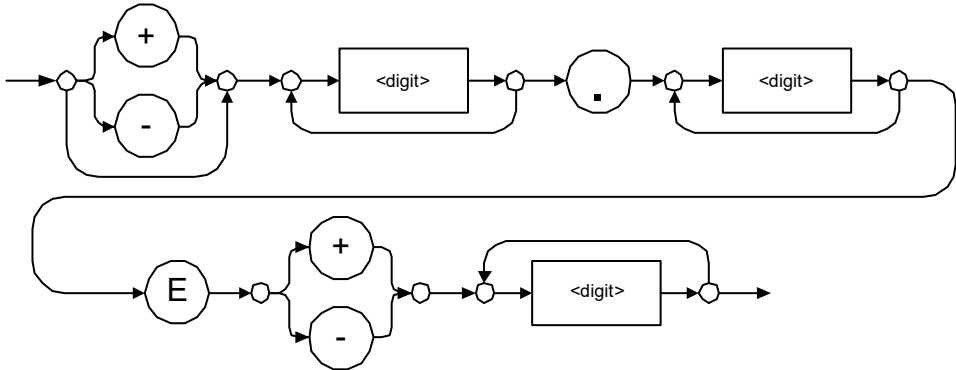

Examples: 4.3E-3, -8.9456E8, 123E-5

Data Types

Applicable Data Types for Output —IEEE 488.2

➤ **Special Numeric Values Received on Output**

In some cases, an instrument may send values indicating that an unusual event has occurred. The following tables present the possible values.

Value is	ASCII 4 bytes
Under range	2143289345.000000
Over range	2143289346.000000
Invalid	2143289347.000000
Inactive	2143289348.000000

Value is	ASCII 8 bytes
Under range	9221120237577961472
Over range	9221120238114832384
Invalid	9221120238651703296
Inactive	9221120239188574208

➤ <HEXADECIMAL NUMERIC RESPONSE DATA>

This data type will be used by a device to return integer representations in hexadecimal (base 16).

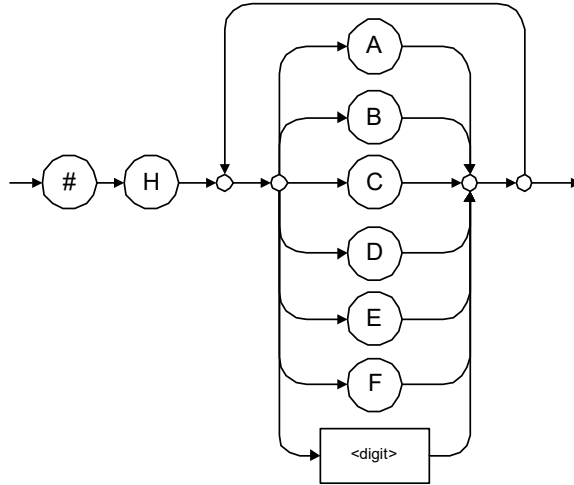

Examples: #HA3C5, #H0123C, #H010F

Data Types

Applicable Data Types for Output —IEEE 488.2

➤ <OCTAL NUMERIC RESPONSE DATA>

This data type will be used by a device to return integer representations in octal (base 8).

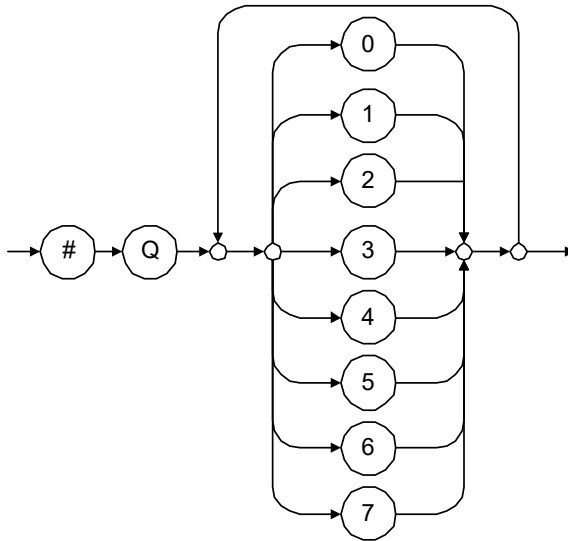

Examples: #Q753214, #Q0124, #Q0725

➤ **<BINARY NUMERIC RESPONSE DATA>**

This data type will be used by a device to return integer representations in binary (base 2).

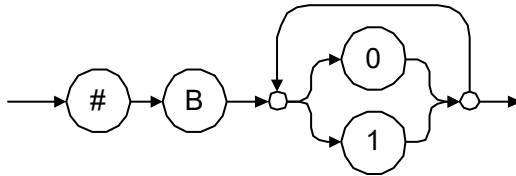

Examples: #B11011110101, #B110100, #B0100

➤ **<STRING RESPONSE DATA>**

This data type will be used by a device to return strings containing 7-bit ASCII characters and especially when text has to be displayed since even the non-printable characters are also returned.

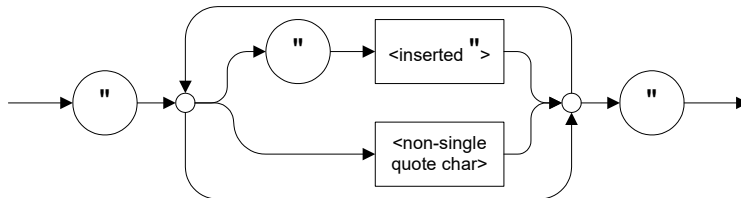

Examples: "SCPI Commands", "SCPI ""Commands""

Data Types

Applicable Data Types for Output —IEEE 488.2

➤ <DEFINITE LENGTH ARBITRARY BLOCK RESPONSE DATA>

This data type is used by a device to return blocks of 8-bit binary information with a fixed and predetermined length.

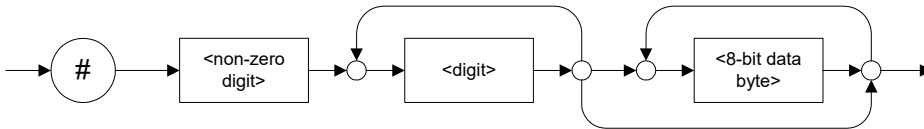

The actual length of the retrieved data has the following structure:

- The first byte contains the # character.
- The byte that immediately follows contains the number of subsequent bytes that you have to check to know the total length.

For example, if you receive this response (here, values are expressed in decimal instead of binary for easier readability):

2 1 3 7 6 8 9 2 ...

The byte that immediately follows the # contains 2, which means that you have to read the two following bytes to know the length (in bytes) of the retrieved data. The bytes indicate 1 and 3. The length will then be 13 bytes. The actual response will begin at byte number 5, in this case.

Examples: #14<DAB> <DAB> <DAB> <DAB> ,

#3004<DAB> <DAB> <DAB> <DAB>

where “<DAB>” stands for data byte

➤ <INDEFINITE LENGTH ARBITRARY BLOCK RESPONSE DATA>

This data type is used by a device to return blocks of 8-bit binary information when the block length was not predefined or when data has to be computed later.

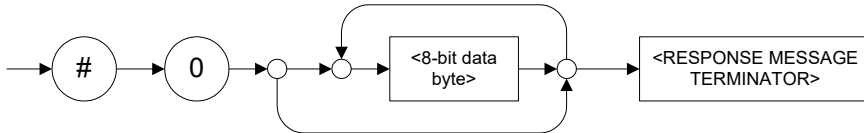

Note: *If you receive a zero as the first digit (#0), it is necessarily followed by a <RESPONSE PROGRAM MESSAGE TERMINATOR> so that you will detect the end of the <INDEFINITE LENGTH ARBITRARY BLOCK RESPONSE DATA>.*

Example: #0<DAB><DAB><DAB><DAB><terminator> where “<DAB>” stands for data byte.

Applicable Data Types for Input—SCPI

SCPI data types include the IEEE 488.2 data types (see *Applicable Data Types for Input—IEEE 488.2* on page 312) with certain additional restrictions.

- `<numeric_value>`: abbreviated form of the decimal numeric element. It differs from the `<DECIMAL NUMERIC PROGRAM DATA>` “`<NRf>`” described in IEEE 488.2.

Several forms of `<CHARACTER PROGRAM DATA>` are defined as special forms of numbers. These are: MINimum, MAXimum, DEFault, UP, DOWN, Not A Number (NAN), INFinity and Negative INFinity (NINF). The following special forms are likely to be used by EXFO’s instruments in certain commands or queries:

- `DEFault`: This special `<numeric_value>` parameter forces the instrument to select a value, which is deemed to be convenient to the user.
- `MINimum` | `MAXimum`: These special `<numeric_value>` parameters refer to the instrument’s limit values. `MINimum` corresponds to the value closest to negative infinity that the function can accept. `MAXimum` corresponds to the largest value that the function can accept.
- `<Boolean Program Data>`: This form is often used as a shorthand of the `<DECIMAL NUMERIC PROGRAM DATA>ON|OFF` form.

`<Boolean Program Data>` parameters have a value of 0 or 1 and are not followed by any unit.

On input, an `<NRf>` is rounded to an integer.

A non-zero result is interpreted as 1.

ON and OFF are accepted on input for readability purposes. They correspond respectively to 1 and 0. However, on output, they appear as 1 or 0, never ON or OFF.

Data Types

Special Numeric Values Received on Output

Special Numeric Values Received on Output

It is possible that an instrument returns unusual values in certain cases. For information on these values, see Applicable Data Types for Output —IEEE 488.2 *on page 321*.

B *IEEE 488.2 and Specific Command Reference*

This chapter presents detailed information about the commands and queries supplied with your unit.

IEEE 488.2 Commands–Quick Reference

The unit recognizes the required commands identified in IEEE 488.2. The table below summarizes these commands. These commands are fully explained on the following pages.

Command	Function
*CLS	Clear status command
*ESE	Standard event status enable command
*ESE?	Standard event status enable query
*ESR?	Standard event status register query
*IDN?	Identification query
*OPC	Operation complete command
*OPC?	Operation complete query
*RST	Reset command
*SRE	Service request enable command
*SRE?	Service request enable query
*STB?	Read status byte query
*TST?	Self-test query
*WAI	Wait for pending operations to be completed

IEEE 488.2 Required Commands

		*CLS
Description	The *CLS command clears the Standard Event Status Register and the Error/Event Queue.	
Syntax	*CLS	
Parameter(s)	None	

ESE*Description**

The *ESE command sets the Standard Event Status Enable Register bits, as defined in the table below. This register contains a mask value for the bits to be enabled in the Standard Event Status Register.

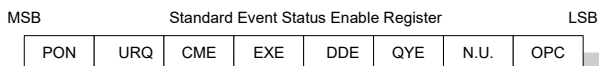
**Syntax**

*ESE<wsp> <RegisterValue>

Parameter(s)

RegisterValue:

The program data syntax for <RegisterValue> is defined as a <DECIMAL NUMERIC PROGRAM DATA> element.

The <RegisterValue>, expressed in base 2, represents the bit values of the Standard Event Status Enable Register.

IEEE 488.2 and Specific Command Reference

IEEE 488.2 Required Commands

***ESE**

The table below shows the contents of this register.

Bit	Weight	Meaning
PON	128	Power ON Enable
URQ	64	User ReQuest Enable
CMD	32	CoMmanD Error Enable
EXE	16	Execution Error Enable
DDE	8	Device Dependent Error Enable
QRY	4	QueRry Error Enable
N.U.	2	Not used
OPC	1	Operation Complete Enable

A value of 1 in the Enable Register enables the corresponding bit in the Status Register, a value of 0 disables the bit. The value of the <RegisterValue> shall be in the range of 0 through 255.

Example(s)

*ESE 25
where 25 = (bit EXE, bit DDE and bit OPC)

*ESE 0
clears the content of the Standard Event Status Enable register

See Also

*ESE?
*ESR?

***ESE?**

Description With the *ESE? query you can determine the current contents of the Standard Event Status Enable Register. See the contents of this register below.

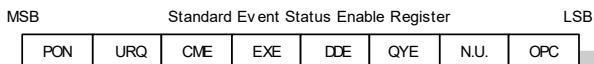

Syntax *ESE?

Parameter(s) None

Response Syntax <RegisterValue>

IEEE 488.2 and Specific Command Reference

IEEE 488.2 Required Commands

***ESE?**

Response(s)

RegisterValue:

The response data syntax for <RegisterValue> is defined as a <NR1 NUMERIC RESPONSE DATA> element.

The <RegisterValue> ranges from 0 through 255.

The <RegisterValue> value expressed in base 2 (binary) represents the bit values of the Standard Event Status Enable register. See below.

Bit	Weight	Meaning
PON	128	Power ON Enable
URQ	64	User ReQuest Enable
CMD	32	CoMmanD Error Enable
EXE	16	Execution Error Enable
DDE	8	Device Dependent Error Enable
QRY	4	QueRry Error Enable
N.U.	2	Not used
OPC	1	Operation Complete Enable

Example(s)

*ESE? returns 133
where 133 = (bit PON, bit QYE and bit OPC)

See Also

*ESE
*ESR?

*ESR?

Description With the *ESR? query you can determine the current contents of the Standard Event Status Register. Reading the Standard Event Status Register clears it. See the contents of this register below.

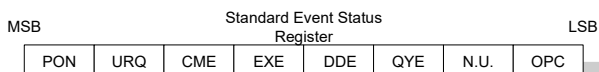

Syntax *ESR?

Parameter(s) None

Response Syntax <RegisterValue>

IEEE 488.2 and Specific Command Reference

IEEE 488.2 Required Commands

*ESR?

Response(s)

RegisterValue:

The response data syntax for <RegisterValue> is defined as a <NR1 NUMERIC RESPONSE DATA> element.

The <RegisterValue> ranges from 0 through 255.

The <RegisterValue> value expressed in base 2 (binary) represents the bit values of the Standard Event Status register. See below.

Bit	Weight	Meaning
PON	128	Power ON Enable
URQ	64	User ReQuest Enable
CMD	32	CoMmanD Error Enable
EXE	16	Execution Error Enable
DDE	8	Device Dependent Error Enable
QRY	4	QueRry Error Enable
N.U.	2	Not used
OPC	1	Operation Complete Enable

Example(s)

*ESR? returns 33
where 33 = (bit CME and bit OPC)

See Also

*ESE
*ESE?

***IDN?**

Description	The intent of the *IDN? query is for the unique identification of devices over the system interface.
Syntax	*IDN?
Parameter(s)	None
Response Syntax	<Identification>
Response(s)	<p><i>Identification:</i></p> <p>The response data syntax for <Identification> is defined as an <ARBITRARY ASCII RESPONSE DATA> element.</p>

The response syntax for the *IDN? query, <Identification> is defined as an <ARBITRARY ASCII RESPONSE DATA> element. This implies that the *IDN? query should be the last <QUERY MESSAGE UNIT> in a <TERMINATED PROGRAM MESSAGE>.

The response is organized into four fields separated by commas. The field definitions are as follows:

Field 1 (Manufacturer): EXFO Inc.
 Field 2 (Model): Instrument Model

IEEE 488.2 and Specific Command Reference

IEEE 488.2 Required Commands

***IDN?**

Field 3 (Serial number): ASCII character (0 if not available)

Field 4 (Firmware level): ASCII character (0 if not available)

ASCII character 0 represents a single ASCII-encoded byte with a value of 30 (48 decimal).

The presence of data in all fields is mandatory. If either field 3 or 4 is not available, the ASCII character 0 shall be returned for that field. A field may contain any 7-bit ASCII-encoded bytes in the range of 20 through 7E (32 through 126 decimal) except commas (2C, 44 decimal) and semicolons (3B, 59 decimal).

Example(s)

*IDN? returns EXFO Inc., LTB-8,125-2A55,1.0.1.97

Notes

The overall length of the *IDN? response is less than or equal to 72 characters.

***OPC**

Description	The *OPC command makes synchronization between the instrument and an external controller possible. The *OPC command causes the instrument to set bit 0 (Operation Complete) in the Standard Event Status Register to the TRUE (logic 1) state when the instrument completes all pending operations. Detection of the Operation Complete message can be accomplished by continuous polling of the Standard Event Status Register using the *ESR? common query command. However, using a service request eliminates the need to poll the Standard Event Status Register thereby freeing the controller to do other useful work.
Syntax	*OPC
Parameter(s)	None
See Also	*OPC? *WAI

*OPC?

Description	The *OPC? query makes possible the synchronization between the instrument and an external controller by reading the Output Queue or by waiting for a service request on the Message Available (MAV) bit in the Status Byte Register. The *OPC? query causes the instrument to place an ASCII character, 1, into its Output Queue when the device completes all pending operations. A consequence of this action is that the MAV bit in the Status Byte Register is set to state 1.
Syntax	*OPC?
Parameter(s)	None
Response Syntax	<Acknowledge>
Response(s)	<i>Acknowledge:</i> The response data syntax for <Acknowledge> is defined as a <NR1 NUMERIC RESPONSE DATA> element. The <Acknowledge> response is a single ASCII-encoded byte corresponding to 1. The receipt of an <Acknowledge> response indicates that all pending selected device operations have been completed.
Example(s)	*OPC? returns 1
See Also	*OPC *WAI

RST*Description**

The *RST command performs a device reset. This command is the third reset level in a three-level reset strategy. The Reset command shall do the following:

- a) Sets the device-specific functions to a known state that is independent of the past-use history of the device.
- b) Forces the device into OCIS state (Operation complete Command Idle State).
- c) Forces the device into OQIS state (Operation complete Query Idle State).

The Reset command explicitly DOES NOT affect the following:

- a) The state of the Communication interface.
- b) The Output Queue.
- c) Any Event Enable Register setting, including the Standard Event Status Enable Register setting.
- d) Any Event Register setting, including the Standard Event Status Register settings.
- e) Calibration data that affects device specifications.
- f) The Service Request Enable Register setting.

Syntax

*RST

Parameter(s)

None

IEEE 488.2 and Specific Command Reference

IEEE 488.2 Required Commands

***SRE**

Description

The *SRE command sets the Service Request Enable Register bits. See the contents of this register below. This register contains a mask value to enable the bits in the Status Byte Register.

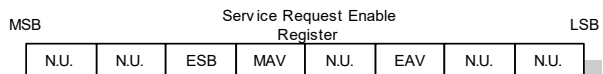

Syntax

*SRE<wsp> <RegisterValue>

Parameter(s)

RegisterValue:

The program data syntax for <RegisterValue> is defined as a <DECIMAL NUMERIC PROGRAM DATA> element.

The <RegisterValue> value ranges from 0 through 255.

The <RegisterValue>, expressed in base 2 (binary), represents the bit values of the Service Request Enable Register.

***SRE**

See the contents of this register below.

Bit	Weight	Meaning
N.U.	128	Not used
N.U.	64	Not used
ESB	32	Event Summary Bit Enable
MAV	16	Message AVailable Enable
N.U.	8	Not used
EAV	4	Error / Event AVailable Enable
N.U.	2	Not used
N.U.	1	Not used

A bit value of zero shall indicate a disabled condition.

Example(s)

*SRE 52
where 52 = (bit ESB, bit MAV and bit EAV)

See Also

*SRE?
*STB?

IEEE 488.2 and Specific Command Reference

IEEE 488.2 Required Commands

*SRE?

Description

With the *SRE? query you can determine the current contents of the Service Request Enable Register. See the contents of this register below.

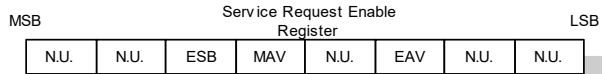

Bit	Weight	Meaning
N.U.	128	Not used
N.U.	64	Not used
ESB	32	Event Summary Bit Enable
MAV	16	Message AAvailable Enable
N.U.	8	Not used
EAV	4	Error / Event AAvailable Enable
N.U.	2	Not used
N.U.	1	Not used

Syntax

*SRE?

Parameter(s)

None

Response Syntax

<RegisterValue>

***SRE?**

Response(s)

RegisterValue:

The response data syntax for <RegisterValue> is defined as a <NR1 NUMERIC RESPONSE DATA> element.

The <RegisterValue> ranges from 0 through 255.

When converted to binary (base 2), the <RegisterValue> represents the current bit values of the Service Request Enable Register.

Example(s)

*SRE returns 32 (bit ESB)

See Also

*SRE
*STB?

IEEE 488.2 and Specific Command Reference

IEEE 488.2 Required Commands

*STB?

Description

With the *STB? query you can read the status byte and Master Summary Status bit. See the content of this register below.

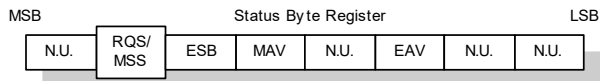
**Syntax**

*STB?

Parameter(s)

None

Response Syntax

<RegisterValue>

STB?*Response(s)***RegisterValue:*

The response data syntax for <RegisterValue> is defined as a <NR1 NUMERIC RESPONSE DATA> element.

The <RegisterValue> ranges from 0 through 255.

The <RegisterValue> value, expressed in base 2 (binary) represents the bit values of the Status Byte Register. See the contents of this register below.

Bit	Weight	Meaning
N.U.	128	Not used
RQS/ MSS	64	ReQuest Service (read by serial polling)/MaSter Summary bit (read by *STB?)
ESB	32	Event Summary Bit Enable
MAV	16	Message AVailable Enable
N.U.	8	Not used
EAV	4	Error / Event AVailable Enable
N.U.	2	Not used
N.U.	1	Not used

Example(s)

*STB? returns 68
where 68 = (bit MSS and bit EAV)

See Also

*SRE
*SRE?

IEEE 488.2 and Specific Command Reference

IEEE 488.2 Required Commands

*TST?	
Description	The *TST? query causes an internal self-test and places a response into the Output Queue indicating whether or not the device completed the self-test without any detected errors. Upon successful completion of *TST?, the device settings is restored to their values prior to the *TST?.
Syntax	*TST?
Parameter(s)	None
Response Syntax	<Result>
Response(s)	<p><i>Result:</i></p> <p>The response data syntax for <Result> is defined as a <NR1 NUMERIC RESPONSE DATA> element.</p> <p>The <Result> value ranges from -32767 through +32767.</p> <p>A <Result> with a value of zero indicates that the self-test has been completed without errors detected. A <Result> with a value not equal to zero indicates that the self-test was not completed or was completed with errors detected.</p>
Example(s)	*TST? returns 0 (self-test was completed with success)

***WAI**

Description	The *WAI command shall prevent the device from executing any further commands or queries until the no-operation-pending flag becomes TRUE.
Syntax	*WAI
Parameter(s)	None
Example(s)	*WAI
See Also	*OPC *OPC?

Specific Commands—Quick Reference

The table below contains a summary of the specific commands for your unit. These commands are fully explained on the following pages.

Command						Parameter(s)
FORMat	[DATA]					AScii[,<Length>]
	[DATA]?					
INSTrument	CATalog?					
	CATalog	FULL?				
SOFTware	CATalog?					
	CATalog	FULL?				
SYSTem	DATE					<Year>,<Month>,<Day>
	DATE?					
	ERRor	[NEXT]?				
	TIME					<Hour>,<Minute>,<Seconds>
	TIME?					
	VERSIon?					

Specific Commands

:FORMat[:DATA]

Description

The FORMat[:DATA] command selects the data format and <Length>. The <Length> parameter is optional for all data format, its meaning is dependent on the data format selected.

The ASCii-type data is automatically identified by its syntax. Therefore, in these cases, the FORMat subsystem is only necessary to determine the output format.

At *RST, ASCii is selected as the default data format and the <Length> is set to 0.

Syntax

:FORMat[:DATA]<wsp>ASCii[,<Length>]

Parameter(s)

► *Type:*

The program data syntax for the first parameter is defined as a <CHARACTER PROGRAM DATA> element. The allowed <CHARACTER PROGRAM DATA> element for this parameter is: ASCii.

:FORMat[:DATA]

In ASCII format, the numeric data is transferred to ASCII bytes in <NR1 NUMERIC RESPONSE DATA>, <NR2 NUMERIC RESPONSE DATA> or <NR3 NUMERIC RESPONSE DATA> representation, as appropriate.

► *Length:*

The program data syntax for <Length> is defined as a <DECIMAL NUMERIC PROGRAM DATA> element.

When ASCII data format is selected, the optional <Length> parameter specifies the number of significant digits to be returned. A <Length> value of zero indicates that the device selects the number of significant digits to be returned. When a <Length> of zero has been specified, the FORMat[:DATA]? query returns zero as its second parameter.

Example(s)

FORM ASC
FORM ASC,6

See Also

FORMat[:DATA]?

:FORMat[:DATA]?

Description	<p>The FORMat[:DATA]? query returns the data format and the <Length>.</p> <p>At *RST, ASCii is selected as the default data format and the <Length> is set to 0.</p>
Syntax	:FORMat[:DATA]?
Parameter(s)	None
Response Syntax	<Type>, <Length>
Response(s)	<p>► <i>Type:</i></p> <p>The response data syntax for <Type> is defined as a <CHARACTER RESPONSE DATA> element.</p> <p>The ASCII <Type> is returned when numeric data is transferred to ASCII bytes in <NR1 NUMERIC RESPONSE DATA>, <NR2 NUMERIC RESPONSE DATA> or <NR3 NUMERIC RESPONSE DATA> representation, as appropriate.</p> <p>► <i>Length:</i></p> <p>The response data syntax for <Length> is defined as a <NR1 NUMERIC RESPONSE DATA> element.</p>

:FORMat[:DATA]?

When the data is returned in ASCII, the <Length> is the number of significant digits to be returned. A <Length> value of zero indicates that the device selects the number of significant digits to be returned.

Example(s)

FORM? returns ASCII,6

See Also

FORMat[:DATA]?

:INSTRument:CATalog?

Description	<p>The INSTRument:CATalog? query returns a comma-separated list of <STRING RESPONSE DATA>, which contains the names of all logical instruments and groups. If no logical instruments are defined, a single null <STRING RESPONSE DATA> is returned.</p> <p>This is not affected by a *RST command.</p>
Syntax	:INSTRument:CATalog?
Parameter(s)	None
Response Syntax	<Catalog>
Response(s)	<p><i>Catalog:</i></p> <p>The response data syntax for <Catalog> is defined as a <STRING RESPONSE DATA> element.</p> <p>The list of <STRING PROGRAM DATA> contains the names of all logical instruments and groups.</p>
Example(s)	INST:CAT? returns “FTBx-2150-2346B-4-EA Optical Light Source”, “FTBx-5245-P-EI Optical Spectrum Analyzer”
See Also	INSTRument:CATalog:FULL?

:INSTrument:CATalog:FULL?

Description	<p>The INSTrument:CATalog:FULL? query returns a list of <STRING RESPONSE DATA> - <NR1 NUMERIC RESPONSE DATA> pairs. The <STRING RESPONSE DATA> contains the name of the logical instrument. The immediately following <NR1 NUMERIC RESPONSE DATA> formatted number is its associated logical instrument number. All response data elements are separated by commas. If no logical instrument is defined, a null <STRING RESPONSE DATA> value followed by a zero is returned.</p> <p>This is not affected by a *RST command.</p>
Syntax	:INSTrument:CATalog:FULL?
Parameter(s)	None
Response Syntax	<Catalog>
Response(s)	<p><i>Catalog:</i></p> <p>The response data syntax for <Catalog> is defined as a <STRING RESPONSE DATA> element.</p> <p>The list of <STRING RESPONSE DATA> contains the names of all logical instruments and groups. The immediately following <NR1 NUMERIC RESPONSE DATA> formatted number is its associated logical instrument number.</p>
Example(s)	INST:CAT:FULL? returns “FTBx-2150-2346B-4-EA Optical Light Source”,1,”FTBx-5245-P-EI Optical Spectrum Analyzer”,2
See Also	INSTrument:CATalog?.

:SOFTware:CATalog?

Description	<p>The SOFTware:CATalog? query returns a list of <STRING RESPONSE DATA> - <STRING RESPONSE DATA> elements corresponding to the software product packs installed on the system with their versions, in simplified format.</p> <p>All response data are separated by commas.</p> <p>This is not affected by a *RST command.</p>
Syntax	:SOFTware:CATalog?
Parameter(s)	None
Response Syntax	<Catalog>, where each element of the list is presented as <Product Pack Name>,<Version [Service Pack]>

:SOFTware:CATalog?

Response(s)

Catalog:

The response data syntax for <Catalog> is defined as a <STRING RESPONSE DATA> element.

For each item of the <Catalog>, the <STRING RESPONSE DATA> contains the name of the installed software product pack.

The immediately following <STRING RESPONSE DATA> contains the product pack version, usually presented in a "major.minor" format, followed by an optional service pack version.

The product pack and optional service pack versions are separated by a space.

Example(s)

SOFTware:CATalog? returns
"ToolBox Core","1.8 SP1","ConnectorMax2",
"3.15", "PowerBlazer","1.35","Optical Spectrum
Analyzer","6.4"

See Also

SOFTware:CATalog:FULL?

:SOFTware:CATalog:FULL?

Description	<p>The INSTRument:CATalog:FULL? query returns a list of <STRING RESPONSE DATA> - <STRING RESPONSE DATA> - <STRING RESPONSE DATA> - <STRING RESPONSE DATA> - <STRING RESPONSE DATA> - <STRING RESPONSE DATA> elements corresponding to the software product packs installed on the system with their versions, in both simplified and detailed formats.</p> <p>All response data are separated by commas.</p> <p>This is not affected by a *RST command.</p>
Syntax	:SOFTware:CATalog:FULL?
Parameter(s)	None
Response Syntax	<Catalog>, where each element of the list is presented as <Product Pack Name> <Simplified Version [Service Pack]>, <Detailed Version>, <Identifier 1>, <Identifier 2>, <Identifier 3>

:SOFTWARE:CATALOG:FULL?

Response(s)

Catalog:

The response data syntax for <Catalog> is defined as a <STRING RESPONSE DATA> element.

For each item of the <Catalog>, the <STRING RESPONSE DATA> contains the name of the installed software product pack.

The immediately following <STRING RESPONSE DATA> contains the simplified product pack version, usually presented in a "major.minor" format, followed by an optional service pack version.

The product pack and optional service pack versions are separated by a space.

The immediately following <STRING RESPONSE DATA> contains the detailed product pack version.

The immediately following <STRING RESPONSE DATA> contains the associated product pack HotFix (HF) identifier.

The immediately following <STRING RESPONSE DATA> contains the associated product pack NS identifier.

The immediately following <STRING RESPONSE DATA> contains the associated product pack CS identifier.

:SOFTware:CATalog:FULL?

Example(s)	SOFTware:CATalog:FULL? returns "ToolBox Core","1.8 SP1","1.8.1.2554","0","0","0", ConnectorMax2","3.15","3.15.017265","0","0","0", "PowerBlazer","1.35","1.35.0.74","0","0","0", "Optical Spectrum Analyzer","6.4", "6.4.0.18191","0","0","0"
See Also	SOFTware:CATalog?

:SYSTem:DATE

Description	<p>The SYSTem:DATE command is used to set the device's internal calendar.</p> <p>This is not affected by a *RST command.</p>
Syntax	:SYSTem:DATE<wsp><Year>,<Month>,<Day>
Parameter(s)	<p>➤ <i>Year:</i></p> <p>The program data syntax for <Year> is defined as a <DECIMAL NUMERIC PROGRAM DATA> element.</p> <p>The <Year> is rounded to the nearest integer. Its range is limited by the capability of the device. The year shall be entered as a four-digit number, including century and millennium information.</p> <p>➤ <i>Month:</i></p> <p>The program data syntax for <Month> is defined as a <DECIMAL NUMERIC PROGRAM DATA> element.</p> <p>The <Month> is rounded to the nearest integer. Its range is 1 to 12 inclusive. The number 1 corresponds to January, 2 to February, and so on.</p>

:SYSTem:DATE**► Day:**

The program data syntax for <Day> is defined as a <DECIMAL NUMERIC PROGRAM DATA> element.

The <Day> is rounded to the nearest integer. It ranges from 1 to the number of days in the month from the previous parameter. This command keeps track of the number of days in each month, accounting for leap years through the range of years that it accepts.

Example(s)

SYST:DATE 2016,07,29

See AlsoSYSTem:DATE?

:SYSTem:DATE?

Description	The SYSTem:DATE query returns the instrument's internal calendar. This is not affected by a *RST command.
Syntax	:SYSTem:DATE?
Parameter(s)	None
Response Syntax	<Year>, <Month>, <Day>

:SYSTem:DATE?**Response(s)****► Year:**

The response data syntax for <Year> is defined as a <NR1 NUMERIC RESPONSE DATA> element.

The <Year> is a four-digit number, including century and millennium information.

► Month:

The response data syntax for <Month> is defined as a <NR1 NUMERIC RESPONSE DATA> element.

The <Month> ranges from 1 to 12, inclusively. The number 1 corresponds to January, 2 to February, and so on.

► Day:

The response data syntax for <Day> is defined as a <NR1 NUMERIC RESPONSE DATA> element.

The <Day> ranges from 1 to the number of days in the month from the previous field. This command keeps track of the number of days in each month, accounting for leap years through the range of years that it accepts.

Example(s)

SYST:DATE? returns 2016,07,29

See Also

SYSTem:DATE

:SYSTem:ERRor[:NEXT]?

Description	<p>The SYSTem:ERRor[:NEXT]? queries the error/event queue for the next item and removes it from the queue. The response message consists of two fields separated by commas <Code>,<Description[,Info]>.</p> <p>SYSTem:ERRor[:NEXT]? is a query only and, therefore, does not have an associated *RST state.</p>
Syntax	:SYSTem:ERRor[:NEXT]?
Parameter(s)	None
Response Syntax	<Code>,<Description[,Info]>
Response(s)	<p>► <i>Code:</i></p> <p>The response data syntax for <Code> is defined as a <NR1 NUMERIC RESPONSE DATA> element.</p> <p>The <Code> is a unique integer in the range [-32768, 32767]. All positive numbers are instrument-dependent. All negative numbers are reserved by the SCPI standard with certain standard error/event codes described in an appendix of this document. The zero value is also used to indicate that no error or event has occurred.</p> <p>► <i>Description[,Info]:</i></p> <p>The response data syntax for <Description[,Info]> is defined as a <STRING RESPONSE DATA> element.</p>

:SYSTem:ERRor[:NEXT]?

The <Description[,Info]> parameter of the full response is a quoted string containing a description followed by information text [,Info]. Each <Code> has a unique and fixed <Description> associated with it. The <Date> and <Time> are appended to the [,info] separated by a semi-colon using the following format:

<Date><wsp><Time> where

<Date> = Year/Month/Day

<Time> = Hour,Minute,Second (24 hour time)

The maximum length of <Description[,Info]> is 255 characters. For standard defined error/event <Codes>, the <Description> is sent exactly as indicated in the appendix of this document.

Example(s)

SYST:ERR:NEXT? returns -222,"Data out of range"
SYST:ERR:NEXT? returns -222,"Data out of range,instrument monomodule 5240S, 2016/07/29 14:56:16.259"

:SYSTem:TIME

Description	<p>This device has an internal clock and implements the SYSTem:TIME command to set the clock time over the interface.</p> <p>This is not affected by a *RST command.</p>
Syntax	:SYSTem:TIME<wsp><Hour>,<Minute>,<Seconds>
Parameter(s)	<p>➤ <i>Hour:</i></p> <p>The program data syntax for <Hour> is defined as a <DECIMAL NUMERIC PROGRAM DATA> element.</p> <p>The <Hour> is always rounded to the nearest integer. It ranges from 0 to 23 inclusively. The device accepts hour information in 24-hour format.</p> <p>➤ <i>Minute:</i></p> <p>The program data syntax for <Minute> is defined as a <DECIMAL NUMERIC PROGRAM DATA> element.</p> <p>The <Minute> is always rounded to the nearest integer. It ranges from 0 to 59 inclusively.</p>

:SYSTem:TIME**► Seconds:**

The program data syntax for <Seconds> is defined as a <DECIMAL NUMERIC PROGRAM DATA> element.

The <Second> is rounded to the resolution of the clock. It ranges from 0 to 60. A value of 60 is allowed since rounding may cause a number greater than 59.5 to be rounded to 60. When this element is rounded to 60 it shall be set to 0 and the minute value incremented. Any other carries shall be rippled through the date.

Example(s)

SYST:TIME 12,47,29

See AlsoSYSTem:TIME?

:SYSTem:TIME?

Description	This device has an internal clock and implements the SYSTem:DATE? query to get the clock time over the interface. This is not affected by a *RST command.
Syntax	:SYSTem:TIME?
Parameter(s)	None
Response Syntax	<Hour>,<Minute>,<Second>

:SYSTem:TIME?**Response(s)****► Hour:**

The response data syntax for <Hour> is defined as a <NR1 NUMERIC RESPONSE DATA> element.

The <Hour> ranges from 0 to 23. The instruments returns hour information in 24-hour format.

► Minute:

The response data syntax for <Minute> is defined as a <NR1 NUMERIC RESPONSE DATA> element.

The <Minute> ranges from 0 to 59.

► Second:

The response data syntax for <Second> is defined as a <NR1 NUMERIC RESPONSE DATA> element.

The <Second> ranges from 0 to 59. The resolution of the clock is the second.

Example(s)

SYST:TIME? returns 16,55,38

See Also

SYSTem:TIME

:SYSTem:VERsion?

Description	<p>The SYSTem:VERsion? query returns a value corresponding to the SCPI version number to which the device complies.</p> <p>The SYSTem:VERsion? is a query only and, therefore, does not have an associated *RST state.</p>
Syntax	:SYSTem:VERsion?
Parameter(s)	None
Response Syntax	<Version>
Response(s)	<p><i>Version:</i></p> <p>The response data syntax for <Version> is defined as a <NR2 NUMERIC RESPONSE DATA> element.</p> <p>The <Version> is shown in the form Year.Revision, where Year represents the year-version (that is 1990) and Revision represents an approved revision number for that year. If no approved revisions are claimed, then this extension is 0.</p>
Example(s)	SYSTem:VERsion? returns 1999.0 (no approved revisions are claimed)

C SCPI-Based Errors

Error Number	Description	Probable Cause
-100	“Command error”	This is the generic syntax error for devices that cannot detect more specific errors. This code indicates only that a Command Error as defined in IEEE 488.2, 11.5.1.1.4 has occurred.
-101	“Invalid character”	A syntactic element contains a character which is invalid for that type; for example, a header containing an ampersand, SETUP&. This error might be used in place of errors -114, -121, -141, and perhaps some others.
-102	“Syntax error”	An unrecognized command or data type was encountered; for example, a string was received when the device does not accept strings.
-103	“Invalid separator”	The parser was expecting a separator and encountered an illegal character; for example, the semicolon was omitted after a program message unit, *EMC 1:CH1:VOLTS 5.
-104	“Data type error”	The parser recognized a data element different than one allowed; for example, numeric or string data was expected but block data was encountered.
-105	“GET not allowed”	A Group Execute Trigger was received within a program message (see IEEE 488.2, 7.7).
-108	“Parameter not allowed”	More parameters were received than expected for the header; for example, the *EMC common command only accepts one parameter, so receiving *EMC 0,1 is not allowed.
-109	“Missing parameter”	Fewer parameters were received than required for the header; for example, the *EMC common command requires one parameter, so receiving *EMC is not allowed.

SCPI-Based Errors

Error Number	Description	Probable Cause
-110	“Command header error”	An error was detected in the header. This error message should be used when the device cannot detect the more specific errors described for errors -111 through -119.
-111	“Header separator error”	A character which is not a legal header separator was encountered while parsing the header; for example, no white space followed the header, thus *GMC"MACRO" is an error.
-112	“Program mnemonic too long”	The header contains more than twelve characters (see IEEE 488.2, 7.6.1.4.1).
-113	“Undefined header”	The header is syntactically correct, but it is undefined for this specific device; for example, *XYZ is not defined for any device.
-114	“Header suffix out of range”	The value of a numeric suffix attached to a program mnemonic (see IEEE 488.2, Syntax and Style section 6.2.5.2) makes the header invalid.
-115	“Unexpected number of parameters”	The number of parameters received does not correspond to the number of parameters expected. This is typically due to an inconsistency with the number of instruments in the selected group (see section on INSTRument:DEFine:GROup).
-120	“Numeric data error”	This error, as well as errors -121 through -129, are generated when parsing a data element which appears to be numeric, including the non-decimal numeric types. This particular error message should be used if the device cannot detect a more specific error.
-121	“Invalid character in number”	An invalid character for the data type being parsed was encountered; for example, an alpha in a decimal numeric or a "9" in octal data.

Error Number	Description	Probable Cause
-123	“Exponent too large”	The magnitude of the exponent was larger than 32000 (see IEEE 488.2, 7.7.2.4.1).
-124	“Too many digits”	The mantissa of a decimal numeric data element contained more than 255 digits excluding leading zeros (see IEEE 488.2, 7.7.2.4.1).
-128	“Numeric data not allowed”	A legal numeric data element was received, but the device does not accept one in this position for the header.
-130	“Suffix error”	This error, as well as errors -131 through -139, are generated when parsing a suffix. This particular error message should be used if the device cannot detect a more specific error.
-131	“Invalid suffix”	The suffix does not follow the syntax described in IEEE 488.2, 7.7.3.2, or the suffix is inappropriate for this device.
-134	“Suffix too long”	The suffix contained more than 12 characters (see IEEE 488.2, 7.7.3.4).
-138	“Suffix not allowed”	A suffix was encountered after a numeric element which does not allow suffixes.
-140	“Character data error”	This error, as well as errors -141 through -149, are generated when parsing a character data element. This particular error message should be used if the device cannot detect a more specific error.
-141	“Invalid character data”	Either the character data element contains an invalid character or the particular element received is not valid for the header.
-144	“Character data too long”	The character data element contains more than twelve characters (see IEEE 488.2, 7.7.1.4).
-148	“Character data not allowed”	A legal character data element was encountered where prohibited by the device.

SCPI-Based Errors

Error Number	Description	Probable Cause
-150	“String data error”	This error, as well as errors -151 through -159, are generated when parsing a string data element. This particular error message should be used if the device cannot detect a more specific error.
-151	“Invalid string data”	A string data element was expected, but was invalid for some reason (see IEEE 488.2, 7.7.5.2); for example, an END message was received before the terminal quote character.
-158	“String data not allowed”	A string data element was encountered but was not allowed by the device at this point in parsing.
-160	“Block data error”	This error, as well as errors -161 through -169, are generated when parsing a block data element. This particular error message should be used if the device cannot detect a more specific error.
-161	“Invalid block data”	A block data element was expected, but was invalid for some reason (see IEEE 488.2, 7.7.6.2); for example, an END message was received before the length was satisfied.
-168	“Block data not allowed”	A legal block data element was encountered but was not allowed by the device at this point in parsing.
-170	“Expression error”	This error, as well as errors -171 through -179, are generated when parsing an expression data element. This particular error message should be used if the device cannot detect a more specific error.
-171	“Invalid expression”	The expression data element was invalid (see IEEE 488.2, 7.7.7.2); for example, unmatched parentheses or an illegal character.
-178	“Expression data not allowed”	A legal expression data was encountered but was not allowed by the device at this point in parsing.

Error Number	Description	Probable Cause
-180	"Macro error"	This error, as well as errors -181 through -189, are generated when defining a macro or executing a macro. This particular error message should be used if the device cannot detect a more specific error.
-181	"Invalid outside macro definition"	Indicates that a macro parameter placeholder (\$<number>) was encountered outside of a macro definition.
-183	"Invalid inside macro definition"	Indicates that the program message unit sequence, sent with a *DDT or *DMC command, is syntactically invalid (see IEEE 488.2, 10.7.6.3).
-184	"Macro parameter error"	Indicates that a command inside the macro definition had the wrong number or type of parameters.
-200	"Execution error"	This is the generic syntax error for devices that cannot detect more specific errors. This code indicates only that an Execution Error as defined in IEEE 488.2, 11.5.1.1.5 has occurred.
-201	"Invalid while in local"	Indicates that a command is not executable while the device is in local due to a hard local control (see IEEE 488.2, 5.6.1.5); for example, a device with a rotary switch receives a message which would change the switches state, but the device is in local so the message can not be executed.
-202	"Settings lost due to rtl"	Indicates that a setting associated with a hard local control (see IEEE 488.2, 5.6.1.5) was lost when the device changed to LOCS from REMS or to LWLS from RWLS.
-203	"Command protected"	Indicates that a legal password-protected program command or query could not be executed because the command was disabled.

SCPI-Based Errors

Error Number	Description	Probable Cause
-210	“Trigger error”	-----
-211	“Trigger ignored”	Indicates that a GET, *TRG, or triggering signal was received and recognized by the device but was ignored because of device timing considerations; for example, the device was not ready to respond. Note: a DT0 device always ignores GET and treats *TRG as a Command Error.
-212	“Arm ignored”	Indicates that an arming signal was received and recognized by the device but was ignored.
-213	“Init ignored”	Indicates that a request for a measurement initiation was ignored as another measurement was already in progress.
-214	“Trigger deadlock”	Indicates that the trigger source for the initiation of a measurement is set to GET and subsequent measurement query is received. The measurement cannot be started until a GET is received, but the GET would cause an INTERRUPTED error.
-215	“Arm deadlock”	Indicates that the arm source for the initiation of a measurement is set to GET and subsequent measurement query is received. The measurement cannot be started until a GET is received, but the GET would cause an INTERRUPTED error.
-220	“Parameter error”	Indicates that a program data element related error occurred. This error message should be used when the device cannot detect the more specific errors described for errors -221 through -229.
-221	“Settings conflict”	Indicates that a legal program data element was parsed but could not be executed due to the current device state (see IEEE 488.2, 6.4.5.3 and 11.5.1.1.5).

Error Number	Description	Probable Cause
-222	"Data out of range"	Indicates that a legal program data element was parsed but could not be executed because the interpreted value was outside the legal range as defined by the device (see IEEE 488.2, 11.5.1.1.5).
-223	"Too much data"	Indicates that a legal program data element of block, expression, or string type was received that contained more data than the device could handle due to memory or related device-specific requirements.
-224	"Illegal parameter value"	Used where exact value, from a list of possible, was expected.
-225	"Out of memory"	The device has insufficient memory to perform the requested operation.
-226	"Lists not same length"	Attempted to use LIST structure having individual LIST's of unequal lengths.
-230	"Data corrupt or stale"	Possibly invalid data; new reading started but not completed since last access.
-231	"Data questionable"	Indicates that measurement accuracy is suspect.
-232	"Invalid format"	Indicates that a legal program data element was parsed but could not be executed because the data format or structure is inappropriate. For example when loading memory tables or when sending a SYSTem:SET parameter from an unknown instrument.

SCPI-Based Errors

Error Number	Description	Probable Cause
-233	“Invalid version”	Indicates that a legal program data element was parsed but could not be executed because the version of the data is incorrect to the device. This particular error should be used when file or block data formats are recognized by the instrument but cannot be executed for reasons of version incompatibility. For example, a not supported file version, a not supported instrument version
-240	“Hardware error”	Indicates that a legal program command or query could not be executed because of a hardware problem in the device. Definition of what constitutes a hardware problem is completely device-specific. This error message should be used when the device cannot detect the more specific errors described for errors -241 through -249.
-241	“Hardware missing”	Indicates that a legal program command or query could not be executed because of missing device hardware; for example, an option was not installed. Definition of what constitutes missing hardware is completely device-specific.
-250	“Mass storage error”	Indicates that a mass storage error occurred. This error message should be used when the device cannot detect the more specific errors described for errors -251 through -259.
-251	“Missing mass storage”	Indicates that a legal program command or query could not be executed because of missing mass storage; for example, an option that was not installed. Definition of what constitutes missing mass storage is device-specific.
-252	“Missing media”	Indicates that a legal program command or query could not be executed because of a missing media; for example, no disk. The definition of what constitutes missing media is device-specific.

Error Number	Description	Probable Cause
-253	"Corrupt media"	Indicates that a legal program command or query could not be executed because of corrupt media; for example, bad disk or wrong format. The definition of what constitutes corrupt media is device-specific.
-254	"Media full"	Indicates that a legal program command or query could not be executed because the media was full; for example, there is no room on the disk. The definition of what constitutes a full media is device-specific.
-255	"Directory full"	Indicates that a legal program command or query could not be executed because the media directory was full. The definition of what constitutes a full media directory is device-specific.
-256	"File name not found"	Indicates that a legal program command or query could not be executed because the file name on the device media was not found; for example, an attempt was made to read or copy a nonexistent file. The definition of what constitutes a file not being found is device-specific.
-257	"File name error"	Indicates that a legal program command or query could not be executed because the file name on the device media was in error; for example, an attempt was made to copy to a duplicate file name. The definition of what constitutes a file name error is device-specific.
-258	"Media protected"	Indicates that a legal program command or query could not be executed because the media was protected; for example, the write-protect tab on a disk was present. The definition of what constitutes protected media is device-specific.

SCPI-Based Errors

Error Number	Description	Probable Cause
-260	“Expression error”	[Indicates that a expression program data element related error occurred. This error message should be used when the device cannot detect the more specific errors described for errors -261 through -269.]
-261	“Math error in expression”	[Indicates that a syntactically legal expression program data element could not be executed due to a math error; for example, a divide-by-zero was attempted. The definition of math error is device-specific.]
-270	“Macro error”	[Indicates that a macro-related execution error occurred. This error message should be used when the device cannot detect the more specific errors described for errors -271 through -279.]
-271	“Macro syntax error”	[Indicates that a syntactically legal macro program data sequence, according to IEEE 488.2, 10.7.2, could not be executed due to a syntax error within the macro definition (see IEEE 488.2, 10.7.6.3).]
-272	“Macro execution error”	[Indicates that a syntactically legal macro program data sequence could not be executed due to some error in the macro definition (see IEEE 488.2, 10.7.6.3).]
-273	“Illegal macro label”	[Indicates that the macro label defined in the *DMC command was a legal string syntax, but could not be accepted by the device (see IEEE 488.2, 10.7.3 and 10.7.6.2); for example, the label was too long, the same as a common command header, or contained invalid header syntax.]
-274	“Macro parameter error”	[Indicates that the macro definition improperly used a macro parameter placeholder (see IEEE 488.2, 10.7.3).]

Error Number	Description	Probable Cause
-275	“Macro definition too long”	[Indicates that a syntactically legal macro program data sequence could not be executed because the string or block contents were too long for the device to handle (see IEEE 488.2, 10.7.6.1).]
-276	“Macro recursion error”	[Indicates that a syntactically legal macro program data sequence could not be executed because the device found it to be recursive (see IEEE 488.2, 10.7.6.6).]
-277	“Macro redefinition not allowed”	[Indicates that a syntactically legal macro label in the *DMC command could not be executed because the macro label was already defined (see IEEE 488.2, 10.7.6.4).]
-278	“Macro header not found”	[Indicates that a syntactically legal macro label in the *GMC? query could not be executed because the header was not previously defined.]
-280	“Program error”	[Indicates that a downloaded program-related execution error occurred. This error message should be used when the device cannot detect the more specific errors described for errors -281 through -289. A downloaded program is used to add algorithmic capability to a device. The syntax used in the program and the mechanism for downloading a program is device-specific.]
-281	“Cannot create program”	[Indicates that an attempt to create a program was unsuccessful. A reason for the failure might include not enough memory.]
-282	“Illegal program name”	[The name used to reference a program was invalid; for example, redefining an existing program, deleting a nonexistent program, or in general, referencing a nonexistent program.]
-283	“Illegal variable name”	[An attempt was made to reference a nonexistent variable in a program.]

SCPI-Based Errors

Error Number	Description	Probable Cause
-284	“Program currently running”	[Certain operations dealing with programs may be illegal while the program is running; for example, deleting a running program might not be possible.]
-285	“Program syntax error”	[Indicates that a syntax error appears in a downloaded program. The syntax used when parsing the downloaded program is device-specific.]
-286	“Program runtime error”	-----
-290	“Memory use error”	[Indicates that a user request has directly or indirectly caused an error related to memory or <data_handle>, this is not the same as “bad” memory.]
-291	“Out of memory”	-----
-292	“Referenced name does not exist”	-----
-293	“Referenced name already exist”	-----
-294	“Incompatible type”	[Indicates that the type or structure of a memory item is inadequate]
-300	“Device-specific error”	[This is the generic device-dependent error for devices that cannot detect more specific errors. This code indicates only that a Device-Dependent Error as defined in IEEE 488.2, 11.5.1.1.6 has occurred.]
-310	“System error”	[Indicates that some error, termed "system error" by the device, has occurred. This code is device-dependent.]
-311	“Memory error”	[Indicates some physical fault in the device's memory, such as parity error.]

Error Number	Description	Probable Cause
-312	“PUD memory lost”	[Indicates that the protected user data saved by the *PUD command has been lost.]
-313	“Calibration memory lost”	[Indicates that nonvolatile calibration data used by the *CAL? command has been lost.]
-314	“Save/Recall memory lost”	[Indicates that the nonvolatile data saved by the *SAV? command has been lost.]
-315	“Configuration memory lost”	[Indicates that nonvolatile configuration data saved by the device has been lost. The meaning of this error is device-specific.]
-320	“Storage fault”	[Indicates that the firmware detected a fault when using data storage. This error is not an indication of physical damage or failure of any mass storage element.]
-321	“Out of memory”	[An internal operation needed more memory than was available.]
-330	“Self-test failed”	-----
-340	“Calibration failed”	-----
-350	“Queue overflow”	[A specific code entered into the queue in lieu of the code that caused the error. This code indicates that there is no room in the queue and an error occurred but was not recorded.]
-360	“Communication error”	[This is the generic communication error for devices that cannot detect the more specific errors described for errors -361 through -363.]
-361	“Parity error in program message”	[Parity bit not correct when data received for example, on a serial port.]
-362	“Framing error in program message”	[A stop bit was not detected when data was received for example, on a serial port (for example, a baud rate mismatch).]

SCPI-Based Errors

Error Number	Description	Probable Cause
-363	“Input buffer overrun”	[Software or hardware input buffer on serial port overflows with data caused by improper or nonexistent pacing.]
-365	“Time out error”	[This is a generic device-dependent error.]
-400	“Query error”	[This is the generic query error for devices that cannot detect more specific errors. This code indicates only that a Query Error as defined in IEEE 488.2, 11.5.1.1.7 and 6.3 has occurred.]
-410	“Query INTERRUPTED”	[Indicates that a condition causing an INTERRUPTED Query error occurred (see IEEE 488.2, 6.3.2.3); for example, a query followed by DAB or GET before a response was completely sent.]
-420	“Query UNTERMINATED”	[Indicates that a condition causing an UNTERMINATED Query error occurred (see IEEE 488.2, 6.3.2.2); for example, the device was addressed to talk and an incomplete program message was received.]
-430	“Query DEADLOCKED”	[Indicates that a condition causing an DEADLOCKED Query error occurred (see IEEE 488.2, 6.3.1.7); for example, both input buffer and output buffer are full and the device cannot continue.]
-440	“Query UNTERMINATED after indefinite response”	[Indicates that a query was received in the same program message after an query requesting an indefinite response was executed (see IEEE 488.2, 6.5.7.5).]
-500	“Power on”	[The instrument has detected an off to on transition in its power supply.]
-600	“User request”	[The instrument has detected the activation of a user request local control.]

Error Number	Description	Probable Cause
-700	"Request control"	[The instrument requested to become the active IEEE 488.1 controller-in-charge.]
-800	"Operation complete"	[The instrument has completed all selected pending operations in accordance with the IEEE 488.2, 12.5.2 synchronization protocol.]

D *COM Properties and Events*

The unit also provides objects based on Microsoft Component Object Model (COM). COM defines a common way to access and create software components and services.

COM promotes the integration and the reuse of software components, as well as interoperability. In order to interoperate, components developed in different languages must adhere to a binary structure specified by Microsoft.

OLE and ActiveX are based on COM. Many programming languages can create and use COM components.

You can build your own programs using the provided properties and events via the `IcSCPIAccess` interface (available on your unit). For information on how to configure your unit for DCOM control, see *Configuring DCOM Access to Your Unit* on page 196.

ActiveX (COM/DCOM)—Quick Reference

The following diagram illustrates the different properties and events available.

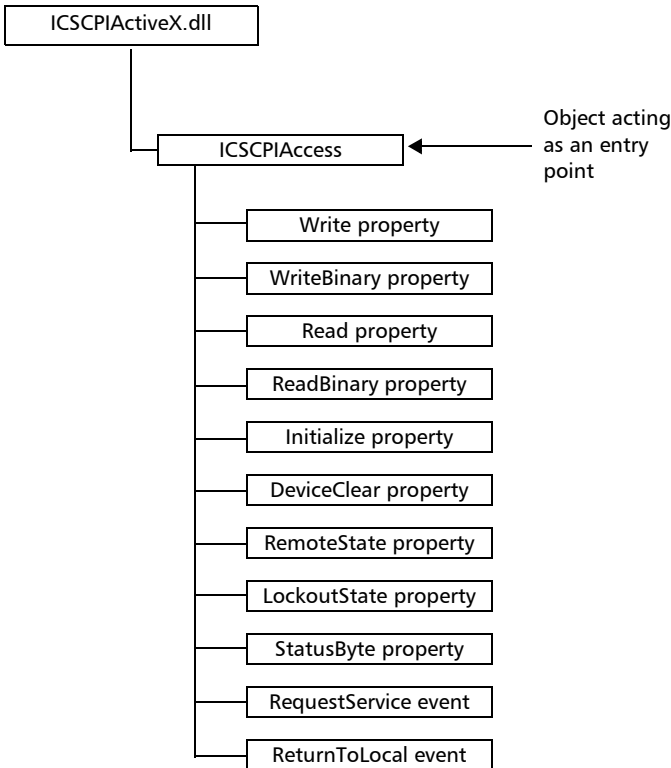

These properties and events are fully explained on the following pages.

Properties

Write

Description	With this method you can send a program message (single command or compound of commands) to the device input buffer.
Syntax	object. <i>Write</i> (<i>Message</i>)
Parameter(s)	<i>Message</i> : Required. A string value corresponding to the program message to be sent.
Possible error(s)	<i>Timeout</i> : This error will occur if the operation could not be completed within the allowed delay. For information on timeout setting, see <i>Initialize</i> on page 399.

WriteBinary

Description	With this method you can send a program message (single command or compound of commands) as an array of bytes into the device input buffer.
Syntax	<code>object.Write (BinaryArray)</code>
Parameter(s)	<i>BinaryArray</i> : Required. An array of bytes corresponding to the program message to be sent.
Notes	Use this method instead of the <i>Write</i> method if you need to send commands in binary (COM is UNICODE).
Possible error(s)	<i>Timeout</i> : This error will occur if the operation could not be completed within the allowed delay. For information on timeout setting, see <i>Initialize</i> on page 399.



IMPORTANT

Before you retrieve data with the *Read* or *ReadBinary* methods, you must specify the format in which the information must be returned. Details on how to correctly set the format can be found below.

Read

Description	With this method you can retrieve all the data from the device output queue in a UNICODE format.
Syntax	<code>object.Read</code>
Parameter(s)	None.
Response(s)	A string value (in UNICODE format).
Notes	<p>This method must be used in conjunction with the <i>Write</i> method. Always ensure that a query has been previously sent before attempting to read a response from the output queue.</p> <p>To properly set the data format, send the following command (using the <i>Write</i> method): FORM:DATA<wsp>ASCII <number_of_digits> where <number_of_digits> corresponds to the number of digits after the decimal point that you require.</p> <p>Remember that the retrieved data will have to be converted to a numeric format before you can use it in calculations, for example.</p>
Possible error(s)	<p><i>Timeout</i>: This error will occur if the allowed delay has expired before the preceding <i>Write</i> operation could send a response to the output queue. For information on timeout setting, see <i>Initialize</i> on page 399.</p> <p><i>QueryUnterminated</i>: This error will occur if the output queue is empty (for example, no query has been made previously).</p>

ReadBinary

Description	With this method you can retrieve data from the device output queue in a binary format.
Syntax	<code>object.ReadBinary</code>
Parameter(s)	None.
Response(s)	An array of bytes.
Notes	<p>This method must be used in conjunction with the <i>Write</i> method. Always ensure that a query has been previously sent before attempting to read a response from the output queue.</p> <p>To properly set the data format, send the following command (using the <i>Write</i> method): FORM:DATA<wsp>ASCIi</p> <p>The retrieved data <i>does not</i> need to be converted to a numeric format before you can use it in calculations, for example.</p> <p>To help you know the actual length of the retrieved data, it has the following structure:</p> <ul style="list-style-type: none">➤ The first byte contains the # character.➤ The byte that immediately follows contains the number of subsequent bytes that you have to check to know the total length.

ReadBinary

For example, if you receive this response (here, values are expressed in decimal instead of binary for easier readability):

```
# 2 1 3 7 5 8 9 2 ...
```

The byte that immediately follows the # contains 2, which means that you have to read the two following bytes to know the length (in bytes) of the retrieved data. The bytes indicate 1 and 3. The length will then be 13 bytes. The actual response will begin at byte number 5, in this case.

Possible error(s)

Timeout: This error will occur if the allowed delay has expired before the preceding *Write* operation could send a response to the output queue. For information on timeout setting, see *Initialize* on page 399.

QueryUnterminated: This error will occur if the output queue is empty (for example, no query has been made previously).

Initialize

Description

With this method you can configure the timeout value that is, the allowed delay for Read and Write operations, in milliseconds.

Syntax

```
object.Initialize(Timeout)
```

Parameter(s)

Timeout: Required. A numeric value corresponding to the delay in milliseconds.

Notes

If the *Initialize* method is not invoked, the default value is 10 000 milliseconds.

COM Properties and Events

Properties

DeviceClear	
Description	This method performs a <i>Device Clear</i> operation as specified in the IEEE 488.1 standard.
Syntax	<code>object.DeviceClear</code>
Parameter(s)	None.

RemoteState	
Description	This property returns or sets the device's remote state.
Syntax	<code>object.RemoteState</code> (to retrieve the state) <code>object.RemoteState=State</code> (to set the state) <i>State</i> : a Boolean value corresponding to: True: Remote False: Local
Parameter(s)	None.
Response(s)	If the property is used to get the device's remote state, the property will return a Boolean value.
Access	Get/Set

LockoutState

Description	This property returns or sets the device's lockout state.
Syntax	<p>object.<i>LockoutState</i> (to retrieve the state)</p> <p>object.<i>LockoutState</i>=<i>State</i> (to set the state)</p> <p><i>State</i>: a Boolean value corresponding to:</p> <p style="padding-left: 40px;">True: Lockout</p> <p style="padding-left: 40px;">False: No lockout</p>
Parameter(s)	None.
Response(s)	If the property is used to get the device's lockout state, the property will return a Boolean value.
Access	Get/Set

StatusByte

Description	This read-only property returns the device's status byte. Refer to IEEE 488.2 standard for status byte description.
Syntax	object. <i>StatusByte</i>
Parameter(s)	None.
Response(s)	A value corresponding to the device's status byte.
Notes	This property can be used in conjunction with <i>RequestService</i> event (see <i>RequestService</i> on page 402) to find out why the device caused a Service Request (SRQ).
Access	Get

Events

RequestService	
Description	This event is triggered whenever the device causes a Service Request (SRQ).
Parameter(s)	None.
Notes	<p>It is the user's responsibility to configure the different registers (*SRE, *ESE) as stated in the IEEE 488.2 standard to receive SRQ.</p> <p>When used in conjunction with <i>StatusByte</i> property (see <i>StatusByte</i> on page 401), this event allows you to determine the cause of the SRQ.</p>

ReturnToLocal	
Description	This event is triggered when the user presses the Local button from the controller's front panel when the device is in Remote state.
Parameter(s)	None.

E **Communicating Through TCP/IP Over Telnet**

The EXFO Instrument Control provides SCPI automation or remote control over Telnet through TCP/IP as a Windows Service that continuously listens to a port from a Telnet server (FTB/IQS/LTB) on which modules to be tested are connected.

Two types of commands that can be sent over Telnet: SCPI commands and internal protocol commands of the TCP/IP over Telnet service. The internal commands allow you to perform certain actions such as send SCPI commands as a script instead of one by one, force the disconnection of an active session, view the status of modules and of connected clients, etc.

Executing SCPI Commands Over Telnet

You can remotely control the modules by executing SCPI commands through TCP/IP over Telnet. The commands are sent remotely from the Telnet client (on a computer) to the Telnet server (in this case, the IQS, FTB, or LTB unit).

You can connect from a remote Windows or Linux (or Unix) client.

Note: *The Telnet client is available on almost all units in case you intend to use these units as computers to connect to a Telnet server. However, on an FTB-1v2, FTB-2, or LTB-1 running Windows Embedded 8 Standard, the Telnet client is not available. With these units, you must use the PuTTY application to establish communication.*

Before being able to send SCPI commands, you must first establish a connection to the Telnet service.

Note: *Socket (raw) connections are also available to send SCPI commands through TCP/IP, but these connections do not support the internal protocol commands listed hereafter. Such connections are similar to a communication over GPIB or RS-232 where you send SCPI commands to the instrument and read back responses over the opened socket connection, but without the extra message information found in Telnet.*

Communicating Through TCP/IP Over Telnet

Executing SCPI Commands Over Telnet

To execute SCPI commands over Telnet from a remote Windows client:

- 1.** Establish a connection to the Telnet service as follows:
 - 1a.** From your computer, start Windows.
 - 1b.** On the taskbar, click **Start** (Start button () under Windows 8.1 and Windows 10) and select **Run**.

Note: Depending on the operating system, Run can sometimes be found under Windows System.

- 1c.** In the **Open** box, type *telnet*, and then click **OK**.

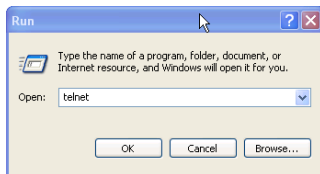

Note: If you receive an error message, it probably means that the Telnet client is not already activated on your computer. In this case, in the **Open** box, type `pkgmgr /iu:TelnetClient`, and then click **OK** to enable the client. Once it is done, perform step 3 again.

Communicating Through TCP/IP Over Telnet

Executing SCPI Commands Over Telnet

- 1d.** In the displayed Telnet editor window, type the `OPEN <IP_ADDRESS_OF_TELNET_SERVER> <PORT>` command to connect to the TCP/IP Telnet Service.

Example: `open 10.192.2.45 5024`

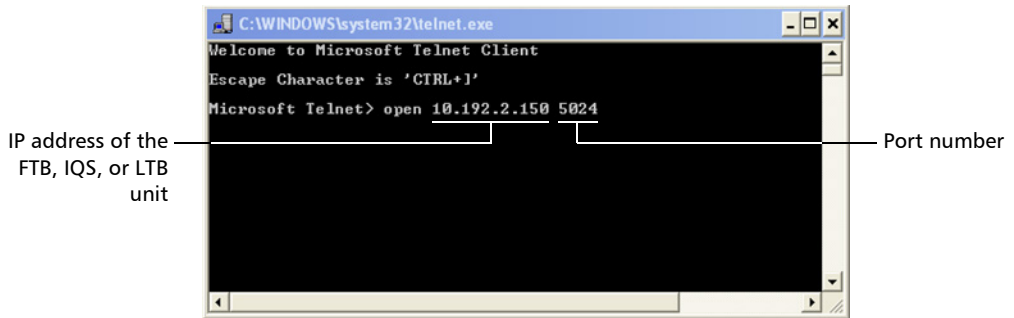

Note: Port 5024 is designated for sending SCPI commands in the Telnet protocol.

- 1e.** Press ENTER to establish a connection with the Service.

Once the connection is established, the `READY>` prompt is displayed in the Telnet editor window.

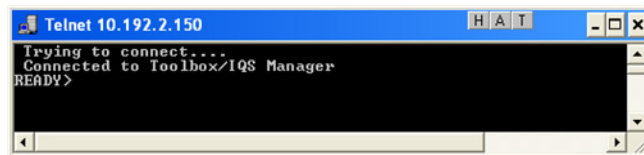

Note: If the connection cannot be established, the *Connection to host lost* message is displayed instead.

Communicating Through TCP/IP Over Telnet

Executing SCPI Commands Over Telnet

2. Enter the desired SCPI commands as follows:

- For a single SCPI command: Type or copy the desired command in the Telnet editor window, and then press ENTER to execute it.

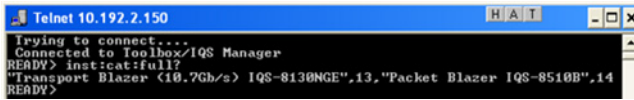

```
Telnet 10.192.2.150
Trying to connect...
Connected to Toolbox/IQS Manager
READY> inst:cat:full?
Transport Blazer (10.7Gb/s) IQS-8130NGE",13,"Packet Blazer IQS-8510B",14
READY>
```

- For multiple SCPI commands: Copy the desired commands from any script file, enclose them in a BEGIN and END block in the Telnet editor window, and then press ENTER. For more information, see *Internal Commands of the TCP/IP over Telnet Protocol* on page 411.

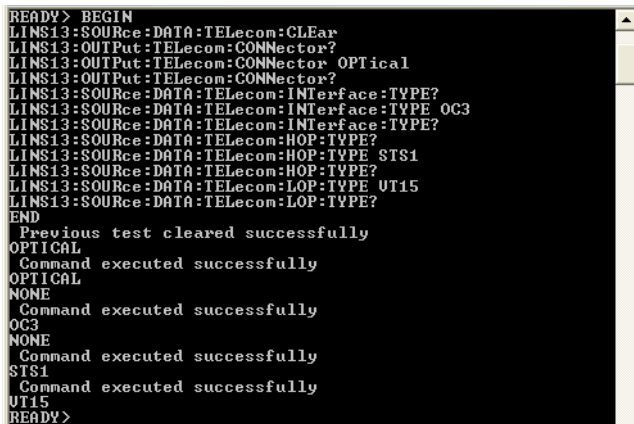

```
READY> BEGIN
LINS13:SOURce:DATA:TELEcom:CLEAr
LINS13:OUTPut:TELEcom:CONNector?
LINS13:OUTPut:TELEcom:CONNector OPTical
LINS13:OUTPut:TELEcom:CONNector?
LINS13:SOURce:DATA:TELEcom:INTerface:TYPE?
LINS13:SOURce:DATA:TELEcom:INTerface:TYPE OC3
LINS13:SOURce:DATA:TELEcom:INTerface:TYPE?
LINS13:SOURce:DATA:TELEcom:HOP:TYPE?
LINS13:SOURce:DATA:TELEcom:HOP:TYPE STS1
LINS13:SOURce:DATA:TELEcom:HOP:TYPE?
LINS13:SOURce:DATA:TELEcom:LOP:TYPE UT15
LINS13:SOURce:DATA:TELEcom:LOP:TYPE?
END
Previous test cleared successfully
OPTICAL
Command executed successfully
OPTICAL
NONE
Command executed successfully
OC3
NONE
Command executed successfully
STS1
Command executed successfully
UT15
READY>
```

3. Click  to close the session.

To execute SCPI commands over Telnet from a remote Linux client:

1. Establish a connection to the Telnet service as follows:
 - 1a. From your computer, right-click on the desktop, and then click **Open Terminal**.

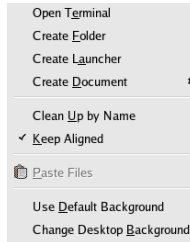

The command prompt is displayed in the Telnet editor window.

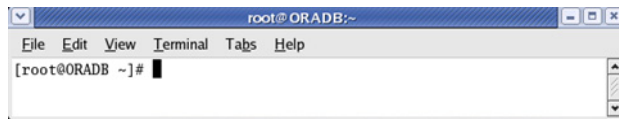

- 1b. Connect to the TCP/IP Telnet Service by typing the `OPEN <IP_ADDRESS_OF_TELNET_SERVER> <PORT>` command:

Example: `open 10.192.2.45 5024`

Note: Port 5024 is designated for sending SCPI commands in the Telnet protocol.

The connection is established when the message **Connected to Toolbox/IQS Manager** is displayed in the Telnet editor window.



Communicating Through TCP/IP Over Telnet

Executing SCPI Commands Over Telnet

2. Enter the desired SCPI commands as follows:
 - For a single SCPI command: Type or copy the desired command in the Telnet editor window, and then press ENTER to execute it.

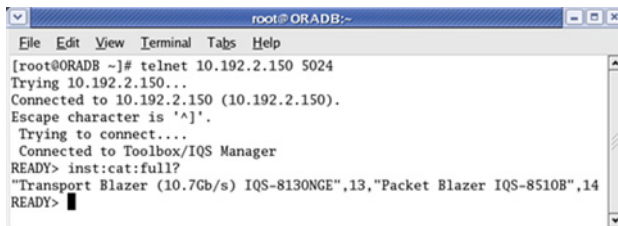

```
root@ORADB:~  
File Edit View Terminal Tabs Help  
[root@ORADB ~]# telnet 10.192.2.150 5024  
Trying 10.192.2.150...  
Connected to 10.192.2.150 (10.192.2.150).  
Escape character is '^]'.  
Trying to connect...  
Connected to Toolbox/IQS Manager  
READY> inst:cat:full?  
"Transport Blazer (10.7Gb/s) IQS-8130NGE",13,"Packet Blazer IQS-8510B",14  
READY> █
```

- For multiple SCPI commands: Copy the desired commands from any script file, enclose them in a BEGIN and END block in the Telnet editor window, and then press ENTER. **For more information, see *Internal Commands of the TCP/IP over Telnet Protocol* on page 411.**
3. Click  to close the session.

Accessing Modules

A session can directly access an instrument using valid LINS commands such as LINS10:SOURce:DATA:TELEcom:CLEar.

However, in a context of multiple sessions, additional commands are available to inform other sessions that an instrument is currently in use.

When a session uses the CONNECT LINS command, another session using the same CONNECT LINS command will receive an error indicating that the instrument is already in use.

For example:

- SESSION 1 sends this command:
CONNECT LINS10

The command returns...OK

- SESSION 2 sends this command:
CONNECT LINS10

The commands returns...Error

At this moment, SESSION 2 knows that LINS10 is already in use by another session.

Note: *Both sessions must use these commands to ensure that they receive accurate information.*

Communicating Through TCP/IP Over Telnet

Accessing Modules

A module is released by one of the following actions:

- Executing the `CLOSE LINS` command to disconnect the link with the module. For more information, see *CLOSE LINS* on page 415.
- Executing the `CLOSE` command to end the current session once the execution of all the desired commands has been completed. For more information, see *CLOSE* on page 414.
- Closing the current session by clicking the Close button on the Telnet editor windows' title bar.
- Shutting down and restarting the client computer.
- A network interruption.

A module can also be released when you terminate the communication by using the `KILL LINS` command. For more information, see *KILL LINS* on page 419.

Internal Commands of the TCP/IP over Telnet Protocol

The internal commands allow you to perform certain actions such as send SCPI commands as a script instead of one by one, force the disconnection of an active session, view the status of modules and of connected clients, etc. The internal commands are not case-sensitive.

ABORT BEGIN

Description The ABORT BEGIN command prevents the execution of the SCPI commands that are enclosed in a BEGIN and END block, and returns to the READY> prompt in the Telnet editor window.

Syntax ABORT BEGIN

Examples

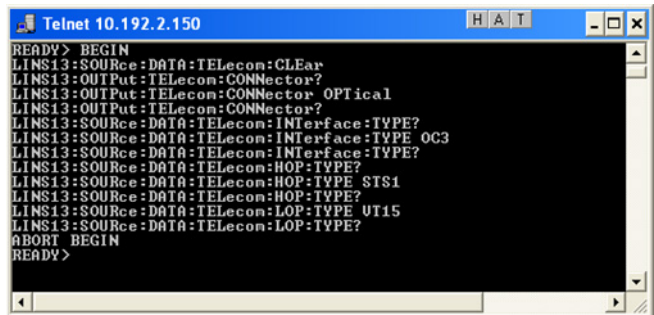

```
Telnet 10.192.2.150  H|A|T  - _ x
READY> BEGIN
LINS13:SOURce:DATA:TELEcon:CLEAr
LINS13:OUTPut:TELEcon:CONNector?
LINS13:OUTPut:TELEcon:CONNector Optical
LINS13:OUTPut:TELEcon:CONNector?
LINS13:SOURce:DATA:TELEcon:INTErface:TYPE?
LINS13:SOURce:DATA:TELEcon:INTErface:TYPE OC3
LINS13:SOURce:DATA:TELEcon:INTErface:TYPE?
LINS13:SOURce:DATA:TELEcon:HOP:TYPE?
LINS13:SOURce:DATA:TELEcon:HOP:TYPE STS1
LINS13:SOURce:DATA:TELEcon:HOP:TYPE?
LINS13:SOURce:DATA:TELEcon:LOP:TYPE UT15
LINS13:SOURce:DATA:TELEcon:LOP:TYPE?
ABORT BEGIN
READY>
```

Communicating Through TCP/IP Over Telnet

Internal Commands of the TCP/IP over Telnet Protocol

BEGIN and END

Description	The BEGIN and END commands allow to define blocks of SCPI commands (script) in a Telnet editor window. The SCPI commands enclosed in BEGIN and END blocks will be executed in batch.
Syntax	BEGIN <SCPI_command> <SCPI_command> ... END

BEGIN and END

Examples

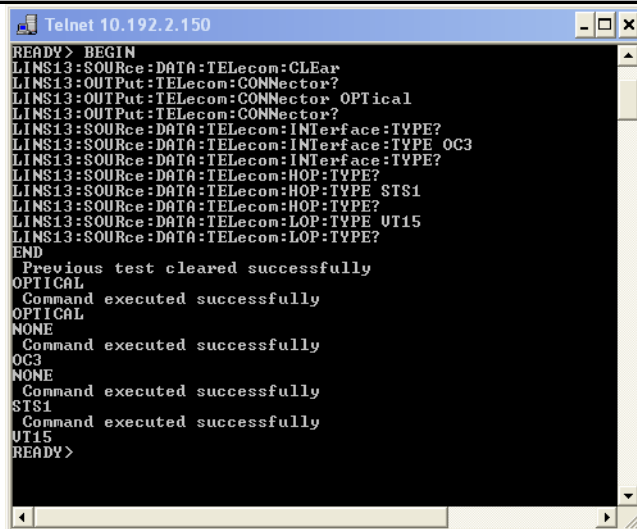

```
Telnet 10.192.2.150
READY> BEGIN
LINS13:SOURCE:DATA:TELEcom:CLEAr
LINS13:OUTPut:TELEcom:CONNector?
LINS13:OUTPut:TELEcom:CONNector OPTical
LINS13:OUTPut:TELEcom:CONNector?
LINS13:SOURCE:DATA:TELEcom:INTErface:TYPE?
LINS13:SOURCE:DATA:TELEcom:INTErface:TYPE OC3
LINS13:SOURCE:DATA:TELEcom:INTErface:TYPE?
LINS13:SOURCE:DATA:TELEcom:HOP:TYPE?
LINS13:SOURCE:DATA:TELEcom:HOP:TYPE STS1
LINS13:SOURCE:DATA:TELEcom:HOP:TYPE?
LINS13:SOURCE:DATA:TELEcom:LOP:TYPE UT15
LINS13:SOURCE:DATA:TELEcom:LOP:TYPE?
END
Previous test cleared successfully
OPTICAL
Command executed successfully
OPTICAL
NONE
Command executed successfully
OC3
NONE
Command executed successfully
STS1
Command executed successfully
UT15
READY>
```

Notes

- To execute a single command, simply type or paste the command in the Telnet editor window.
- You cannot enclose internal commands in a BEGIN and END block, except the ABORT BEGIN command.

Communicating Through TCP/IP Over Telnet

Internal Commands of the TCP/IP over Telnet Protocol

CLOSE

Description The CLOSE command terminates the current Telnet session.

Syntax CLOSE

Examples

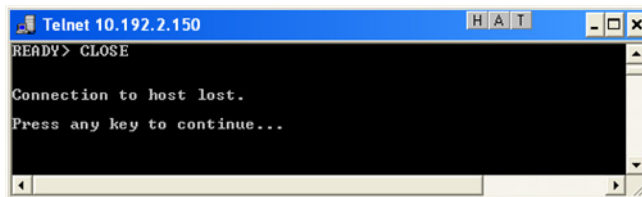

```
Telnet 10.192.2.150 H A T
READY> CLOSE
Connection to host lost.
Press any key to continue...
```

CLOSE LINS

Description	This command allows to close any active connections that have been previously established with the CONNECT LINS command (see <i>CONNECT LINS</i> on page 417). You can send this command to close all client's connections to any module, including the current connection.
Syntax	<p>The syntax of the command vary according to the type of platform you are using.</p> <ul style="list-style-type: none">➤ For FTB-500 and IQS-600: CLOSE LINS<Unit_Number> <Slot_Number> You must specify the unit number and the slot number identifying the module for which you want to close the connections.➤ For FTB-1v2/FTB-1v2 Pro, FTB-2/ FTB-2 Pro/FTB-4 Pro, LTB-1, and LTB-2/LTB-8/LTB-12: CLOSE LINS<Logical_Instrument_Number> You must specify the logical instrument number corresponding to the module for which you want to close the connections. This number is configurable from the Remote Control Configuration application.

Communicating Through TCP/IP Over Telnet

Internal Commands of the TCP/IP over Telnet Protocol

CLOSE LINS

Examples

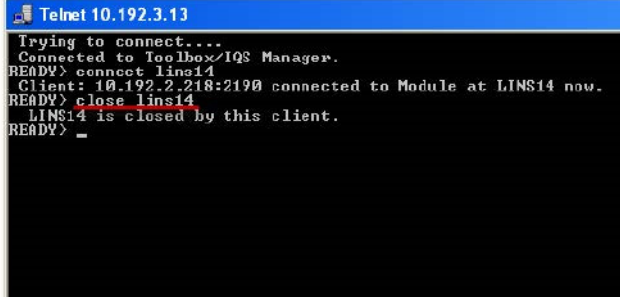

```
Telnet 10.192.3.13
Trying to connect...
Connected to Toolbox/IQS Manager.
READY> connect lins14
Client: 10.192.2.218:2190 connected to Module at LINS14 now.
READY> close lins14
LINS14 is closed by this client.
READY> _
```

Notes

- If the command is not executed successfully, a possible reason could be that the provided information does not correspond to a valid LINS.
- On all platforms except FTB-500 and IQS-600, CLOSE LINS does not prevent another session from accessing the instrument using a direct LINS command.

CONNECT LINS

Description	This command allows to inform other sessions that you are connected to one or more instruments.
Syntax	<p>The syntax of the command vary according to the type of platform you are using.</p> <ul style="list-style-type: none">➤ For FTB-500 and IQS-600: CONNECT LINS<Unit_Number><Slot_Number> You must specify the unit number and the slot number identifying the module to which the session will connect.➤ For FTB-1v2/FTB-1v2 Pro, FTB-2/ FTB-2 Pro/FTB-4 Pro, LTB-1, and LTB-2/LTB-8/LTB-12: CONNECT LINS<Logical_Instrument_Number> You must specify the logical instrument number corresponding to the module to which the session will connect. This number is configurable from the Remote Control Configuration application.

Communicating Through TCP/IP Over Telnet

Internal Commands of the TCP/IP over Telnet Protocol

CONNECT LINS

Examples



```
Telnet 10.192.3.13
Trying to connect...
Connected to Toolbox/IQS Manager.
READY> connect lins14
Client: 10.192.2.218:2190 connected to Module at LINS14 now.
READY> _
```

Notes

- On all platforms except FTB-500 and IQS-600, for compatibility reasons, you can connect to a module with a valid instrument command and a valid LINS (such as Lins10:SOURce:DATA:TELEcom:CLEAr). However, there will be no way for other sessions to know that you are connected to this instrument.
 - If the command is not executed successfully, the possible reasons could be:
 - The module is already connected to a different client session.
 - The provided information does not correspond to a valid LINS.
-

KILL LINS

Description This command allows any user to terminate the session that contains the specified connection (LINS), if this connection has been previously established with the CONNECT LINS command (see *CONNECT LINS* on page 417). This means that it will terminate all active connections that belong to a session if these connections have been previously established with CONNECT LINS.

Syntax The syntax of the command vary according to the type of platform you are using.

- For FTB-500 and IQS-600:
KILL LINS<Unit_Number> <Slot_Number>
You must specify the unit number and the slot number identifying the module for which you want to terminate the session.
- For FTB-1v2/FTB-1v2 Pro, FTB-2/ FTB-2 Pro/FTB-4 Pro, LTB-1, and LTB-2/LTB-8/LTB-12:
KILL LINS<Logical_Instrument_Number>
You must specify the logical instrument number corresponding to the module for which you want to terminate the session. This number is configurable from the Remote Control Configuration application.

Examples

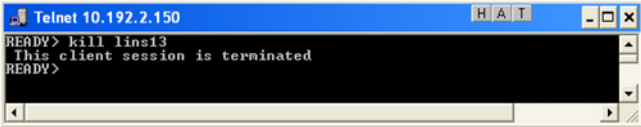

```
Telnet 10.192.2.150  H A T  - _ x
READY> kill lins13
This client session is terminated
READY>
```

Communicating Through TCP/IP Over Telnet

Internal Commands of the TCP/IP over Telnet Protocol

KILL LINS

Notes

- To know the status of the modules before terminating connections using the KILL LINS command, you can first enter the STATUS CLIENT command. For more information, see *STATUS CLIENT* on page 421.

In the example below, two modules are connected: LINS13 and LINS10.

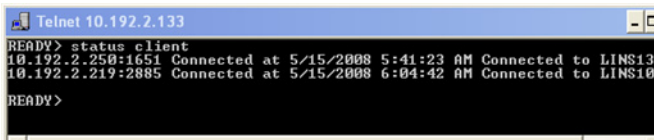

```
Telnet 10.192.2.133
READY> status client
10.192.2.250:1651 Connected at 5/15/2008 5:41:23 AM Connected to LINS13
10.192.2.219:2885 Connected at 5/15/2008 6:04:42 AM Connected to LINS10
READY>
```

- To disconnect the LINS10 module used by another session, enter the *kill lins10* command. A confirmation message is displayed once the module is disconnected.

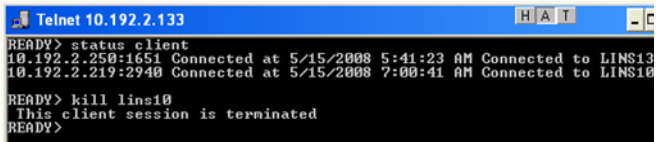

```
Telnet 10.192.2.133
READY> status client
10.192.2.250:1651 Connected at 5/15/2008 5:41:23 AM Connected to LINS13
10.192.2.219:2940 Connected at 5/15/2008 7:00:41 AM Connected to LINS10
READY> kill lins10
This client session is terminated
READY>
```

- Enter again the STATUS CLIENT command to confirm the termination of the module (LINS10 in our example). Only the information of the remaining connected client is displayed.

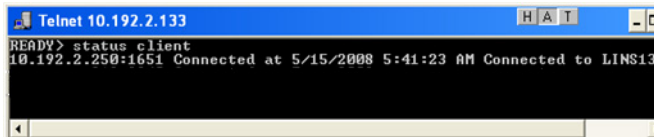

```
Telnet 10.192.2.133
READY> status client
10.192.2.250:1651 Connected at 5/15/2008 5:41:23 AM Connected to LINS13
```

STATUS CLIENT

Description This command lists out all clients with their connection time and modules.

Syntax STATUS CLIENT

Examples

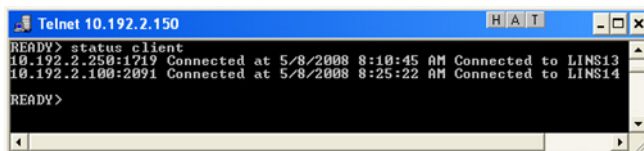

```
Telnet 10.192.2.150 H A I T
READY> status client
10.192.2.250:1719 Connected at 5/8/2008 8:10:45 AM Connected to LINS13
10.192.2.100:2091 Connected at 5/8/2008 8:25:22 AM Connected to LINS14
READY>
```

STATUS CONNECTION

Description This command lists out all the connections with their *Idle* or *Active* status.

Syntax STATUS CONNECTION

Examples



```
Telnet 10.192.2.150 H A I T
READY> status connection
10.192.2.250:1719 Active
READY>
```

Notes By default, any connection that is idle for 5 minutes or more is identified as *Idle*.

Communicating Through TCP/IP Over Telnet

Internal Commands of the TCP/IP over Telnet Protocol

STATUS MODULE

Description This command lists out all the modules with the slot numbers where they are located (FTB-500 and IQS-600), or with their LINS (all other platforms).

Syntax STATUS MODULE

Examples

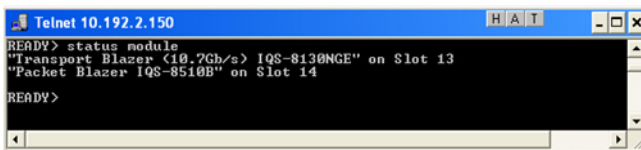

```
Telnet 10.192.2.150
READY> status module
"Transport Blazer <10.7Gb/s> IQS-8130NGE" on Slot 13
"Packet Blazer IQS-8510B" on Slot 14
READY>
```

WHO M I?

Description This command retrieves the IP address and the communication port of the current session.

Syntax WHO M I?

Examples

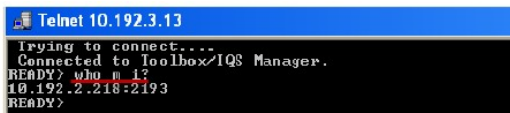

```
Telnet 10.192.3.13
Trying to connect...
Connected to Toolbox/IQS Manager.
READY> who m i?
10.192.2.218:2193
READY>
```

Index

A

AC	
adapter	21
connection	4, 6, 9, 54, 58
power	39, 53, 58
requirements	23, 24
accessing	
online help	297
ToolBox X	71
ActiveX	
control	179
linking units	183
output units and formats	186
selecting	192
adjusting date, time and time zone	98
after-sales service	298
amber LED	10
AMT	
changing administrator password	131
changing user password	133
connecting with tool	121
creating accounts	133
deleting accounts	137
installing connection tool	120
modifying accounts	135
remote shutdown/start	138
angled brackets	234
antivirus software	80
appearance, date and time	96
applications	
installing	75
module, starting	72
ToolBox X, starting	118
ASCII format	187
audio ports	6, 9

automatic	
fan speed	25
IP address	129
Windows updates	244
automation	179, 191
available disk space	144

B

black LED	10
blinking LED	10
blue LED	10
boot, first	66, 119
braces	234
brackets	
angled	234
square	233
browsing Web	109
bumpers, platform	36
bus timing	186
buttons	13

C

cabinet installation	31
capacitors	22
capacity, storage	144
caution	
of personal hazard	15
of product hazard	15
changing	
AMT accounts	135
communication settings	190
date and time	98
language	87
choosing	
language	87
time zone	98

Index

- cleaning
 - disk 145
 - front panel 243
- codes, error 238
- colon 234
- colors, LEDs 10
- COM, local control 179
- COM/DCOM
 - events 402
 - properties 395
- comma 235
- commands
 - IEEE 488.2 334
 - SCPI 232
 - specific 355
 - TCP/IP 411–422
- communication
 - ActiveX 179
 - changing settings 190
 - Ethernet TCP/IP 179
 - GPIB 180
 - RS-232 179, 180
 - TCP/IP 403
 - TCP/IP over Telnet 180
- configuring
 - GPIB 181
 - unit 66, 119
- connecting
 - speakers 6, 9
 - to a VPN 149
 - to AMT 120, 121, 131, 133
 - unit to AC power 53, 58
 - unit to DC power 53, 54
- ConnectorMax2 141
- consulting PDF files 108
- control
 - ActiveX 179
 - Ethernet TCP/IP 179
 - GPIB 180
 - module 179
 - remote 179

- RS-232 180
- TCP/IP over Telnet 180
- conventions, programming 232, 235, 236
- conventions, safety 15
- copying
 - commands into text document 241
 - files and folders 144
- covers, unit 22
- creating
 - AMT accounts 133
 - PDF files 107
- current modules view 72
- current, electrical 23, 24
- customer service 308

D

- data input
 - IEEE 488.2 312
 - SCPI 331
- data output IEEE 488.2
 - special 324, 332
 - standard 321
- data types 311
- date and time
 - adjusting 98
 - formats 96
- DC power 39, 53, 54
- DCOM
 - configuring computers 196
 - technology 179
- deleting
 - AMT accounts 137
 - files and folders 144
 - unused system files 145
- description, function buttons 13
- digit 233
- dirty fibers 141
- Disk Cleanup 145
- disk space, free 144
- documentation 297
- documents, printing 107

- dry contact relays 42
DVI 6, 7, 9
- E**
- eject button 13
ejecting module, undo 74, 263
equipment returns 308
error messages in remote control 238
error, status 12, 73
Ethernet port
 location 3, 4, 5, 6, 9, 122, 124
 reconfiguring 129
Ethernet TCP/IP
 control 179
 port 183
ETSI racks 31
exiting ToolBox X 71
Explorer, Internet 109
external power supply 21
- F**
- fan speed 25
fiber probe 141
files and folders, managing 144
first startup 66, 119
flashing LED 10
freeing disk space 145
front panel, cleaning 243
function buttons description 13
fuse
 replacement 22, 258
 type 22, 258
- G**
- GPIB
 address 180
 capability 182
 chain 180
 configuring parameters 193
 control 180
- hardware configuration 181
 optimizing performance 186
 output units and formats 186
 port 183
 restrictions 181
 selecting 192
green LED 10
grounding unit 39
- H**
- handshake rate 186
hard disk
 LED 11
 location 250
hazard, laser radiation 20
headset port 6, 9
help, online 297
high speed (HS488) 181, 186, 193
hour, setting 98
- I**
- identification label 298
identifying defects on fibers 141
IEEE 488.1 protocol 181, 186
IEEE 488.2 commands 334
in use, status 11, 73
indoor use 22
input
 current 23, 24
 IEEE 488.2 data types 312
 SCPI data types 331
inserting module 48
inspection probe 141
installing
 remote tool 120
 software 75
 third-party software 80
 unit in rack 31, 34
 unit, requirements 22
 VPN clients 149
instrument control settings 190

Index

- interface, changing language..... 87
- Internet connection..... 109
- IP address, reconfiguring..... 129
- IPv4 and IPv6..... 129

- K**
- keywords, SCPI 234

- L**
- label, identification 298
- LAN network 180
- language, selecting 87
- laser safety information 20
- launching probe application 141
- LED
 - hard disk..... 11
 - indicators..... 10
 - power 10
 - system 10
- legs, platform..... 36
- linking units
 - Ethernet port..... 183
 - GPIB port 183
- list separator 234
- local control 179
- lug, grounding 39

- M**
- main power switch..... 4, 6, 9, 54, 58
- maintenance
 - front panel 243
 - general information..... 243
 - port 4, 6, 9
- managing files and folders..... 144
- mandatory commands 334
- manuals 297
- maximum input current 23, 24
- microphone port..... 6, 9
- mnemonic, definition..... 234
- modifying AMT accounts 135

- module
 - controlling 179
 - insertion..... 48
 - reconnection..... 74, 263
 - removal..... 48
 - statuses..... 73
- monitor ports 6, 7, 9
- monitoring remote commands..... 239
- mounting brackets 31
- moving files and folders 144
- multiple capabilities 233

- N**
- navigating the Internet..... 109
- network, LAN/WAN 180
- new AMT user 133

- O**
- off LED 10
- online help 297
- opening user guides 108
- operation language..... 87
- options
 - software..... 77
 - ToolBox X..... 101
- orange LED..... 10
- output IEEE 488.2
 - special..... 324, 332
 - standard 321

- P**
- password, changing 131, 133
- PDF files
 - generating 107
 - viewing 108
- pinout of the relays 42
- pipe character 234

- platform
 - bumpers 36
 - commands 355
 - legs 36
 - plugging unit 53
 - port
 - DVI 6, 7, 9
 - Ethernet 3, 4, 5, 6, 9, 122, 124, 183
 - GPIB 183
 - serial 7
 - USB 3, 4, 5, 6, 8, 9
 - VGA 6, 7, 9
 - power
 - button 13
 - connecting 53
 - LED 10
 - relay 42
 - sources 23, 24
 - supply 21
 - switch 6, 9
 - switch, main 4, 54, 58
 - preventing connection, AMT 137
 - printing documents 107
 - product
 - identification label 298
 - specifications 14
 - programmable instruments,
 - standards 179, 232
 - protocol
 - HS488 181
 - IEEE 488.1 181
 - purchased options 77
- R**
- rack
 - dimensions 31
 - installing units in 34
 - radiation hazard, laser 20
 - RAID disks 250
 - reading PDF files 108
 - ready status 73
 - receiving data
 - with Ethernet port 183
 - with GPIB port 183
 - reconfiguring local ports 129
 - reconnecting a module 74, 263
 - red LED 10
 - regional and language settings 66
 - register
 - diagram 230, 231
 - ESE 228
 - ESR 228
 - SRE 228
 - STB 228
 - regulatory information vii, x
 - relays, dry contact 42
 - remaining disk space 144
 - remote
 - access (AMT) 120, 121
 - operations 138
 - remote control
 - ActiveX (DCOM) 179, 183
 - configuring 191, 196
 - description of commands 232
 - error messages 238
 - GPIB 180, 183
 - limitations 181
 - methods 179
 - monitoring 239
 - RS-232 179, 180
 - TCP/IP 180, 403, 411–422
 - removing
 - AMT accounts 137
 - module 48
 - repairing unit 22
 - replaceable hard disks 250
 - replacing fuses 258
 - return merchandise authorization (RMA) .. 308
 - returned values, setting 186
 - RJ-45 port 4, 6, 9

Index

- RS-232
 - communication 179
 - configuring parameters 193
 - control 180
 - selecting 192
- RTU-2, installing 34
- rules
 - programming 236
 - syntax 235
 - syntax conventions 232
- S**
- safe to remove, status 11, 73
- safety
 - caution 15
 - conventions 15
 - grounding unit 39
 - information 20
 - warning 15
- SCPI
 - commands 232
 - data types 331
 - guidelines 179, 232
- selecting
 - language 87
 - startup applications 85
 - time zone 98
- semicolon 235
- sending data
 - with Ethernet port 183
 - with GPIB port 183
- separator 234, 235
- serial port 7
- service and repairs 308
- service centers 309
- service request enable register (SRE) 228
- setting
 - date and time 96, 98
 - instrument control utility 190
- shipping to EXFO 308
- short and long formats, date 96
- shutdown mode 64
- software
 - accessing 71
 - exiting 71
 - installing 75
 - options 77
 - upgrading 75
- space 233
- speaker port 6, 9
- specific commands 355
- specifications, product 14
- square brackets 233
- standard event status
 - enable register (ESE) 228
 - register (ESR) 228
- standard status data structure
 - diagram 230, 231
 - general 228
- starting
 - applications 72, 118
 - probe application 141
 - ToolBox X 71
- startup, selecting applications for 85
- static IP
 - address 129
 - port 4, 6, 9
- status byte register (STB) 228
- statuses, modules 73
- storage requirements 243
- surfing the Internet 109
- symbols, safety 15
- syntax
 - rules 232, 235
 - SCPI 232
 - symbols 233
- system
 - LED 10
 - relay 42

- T**
- TCP/IP
- commands.....411–422
 - configuring parameters 193
 - connecting to Linux 407
 - connecting to Windows..... 403
 - control 179, 180
 - introduction..... 403
 - release examples..... 409
 - selecting 192
- technical specifications..... 14
- technical support 298
- temperature for storage..... 243
- test or measurement underway, status 11
- third-party software 80
- time zone, selecting 98
- ToolBox X
- applications 118
 - language 87
 - options 101
- transition, status 11
- transportation requirements 243, 303
- troubleshooting operations..... 138
- turning unit on/off 61, 64, 138
- type of fuses..... 22
- types, data 311
- U**
- unit
- connecting to AC power 58
 - connecting to DC power 54
 - covers 22
 - first configuration..... 66, 119
 - grounding 39
 - installing..... 22, 34
 - repairing 22
 - ventilation 22
- updating
- EXFO applications..... 75
 - Windows applications 244
- USB ports 3, 4, 5, 6, 8, 9
- V**
- ventilation 22
- vertical bar..... 234
- VGA 6, 7, 9
- video ports 6, 7, 9
- viewing
- current modules..... 72
 - PDF files 108
- virtual private network (VPN)..... 149
- W**
- WAN network..... 180
- warranty
- certification..... 307
 - exclusions 307
 - general..... 305
 - liability 307
 - null and void 305
- Web browser 109
- white space 233
- Windows, update of applications 244
- Windows.old folder 145
- wizard, configuration 66, 119
- wsp 233
- Y**
- yellow LED 10
- user accounts, AMT 133
- user guides 297

CHINESE REGULATION ON RESTRICTION OF HAZARDOUS SUBSTANCES (RoHS)

中国关于有害物质限制的规定

NAMES AND CONTENTS OF THE TOXIC OR HAZARDOUS SUBSTANCES OR ELEMENTS
CONTAINED IN THIS EXFO PRODUCT

包含在本 EXFO 产品中的有毒有害物质或元素的名称及含量

Part Name 部件名称	Lead 铅 (Pb)	Mercury 汞 (Hg)	Cadmium 镉 (Cd)	Hexavalent Chromium 六价铬 (Cr(VI))	Polybrominated biphenyls 多溴联苯 (PBB)	Polybrominated diphenyl ethers 多溴二苯醚 (PBDE)
Enclosure 外壳	O	O	O	O	O	O
Electronic and electrical sub-assembly 电子和电气组件	X	O	X	O	X	X
Optical sub-assembly ^a 光学组件 ^a	X	O	O	O	O	O
Mechanical sub-assembly ^a 机械组件 ^a	O	O	O	O	O	O

Note:

注:

This table is prepared in accordance with the provisions of SJ/T 11364.

本表依据 SJ/T 11364 的规定编制。

O: Indicates that said hazardous substance contained in all of the homogeneous materials for this part is below the limit requirement of GB/T 26572.

O: 表示该有害物质在该部件所有均质材料中的含量均在 GB/T 26572 标准规定的限量要求以下。

X: indicates that said hazardous substance contained in at least one of the homogeneous materials used for this part is above the limit requirement of GB/T 26572. Due to the limitations in current technologies, parts with the "X" mark cannot eliminate hazardous substances.



X: 表示该有害物质至少在该部件的某一均质材料中的含量超出 GB/T 26572 标准规定的限量要求。

标记 "X" 的部件, 皆因全球技术发展水平限制而无法实现有害物质的替代。

a. If applicable.

如果适用。

MARKING REQUIREMENTS
标注要求

Product 产品	Environmental protection use period (years) 环境保护使用期限 (年)	Logo 标志
This EXFO product 本 EXFO 产品	10	
Battery ^a 电池	5	

a. If applicable.
如果适用。

P/N: 4.0.1.1

www.EXFO.com · info@EXFO.com

CORPORATE HEADQUARTERS 400 Godin Avenue

Quebec (Quebec) G1M 2K2 CANADA
Tel.: 1 418 683-0211 · Fax: 1 418 683-2170

TOLL-FREE (USA and Canada)

1 800 663-3936

© 2023 EXFO Inc. All rights reserved.
Printed in Canada (2023-06)

