

OX1

Optical Explorer



Copyright © 2019–2022 EXFO Inc. All rights reserved. No part of this publication may be reproduced, stored in a retrieval system or transmitted in any form, be it electronically, mechanically, or by any other means such as photocopying, recording or otherwise, without the prior written permission of EXFO Inc. (EXFO).

Information provided by EXFO is believed to be accurate and reliable. However, no responsibility is assumed by EXFO for its use nor for any infringements of patents or other rights of third parties that may result from its use. No license is granted by implication or otherwise under any patent rights of EXFO.

EXFO's Commerce And Government Entities (CAGE) code under the North Atlantic Treaty Organization (NATO) is 0L8C3.

The information contained in this publication is subject to change without notice.

Trademarks

EXFO's trademarks have been identified as such. However, the presence or absence of such identification does not affect the legal status of any trademark.

Where applicable, the Bluetooth[®] word mark and logos are registered trademarks owned by Bluetooth SIG, Inc. and any use of such marks by EXFO Inc. is under license. Other third party trademarks and trade names are those of their respective owners.

Units of Measurement

Units of measurement in this publication conform to SI standards and practices.

Patents

The exhaustive list of patents is available at EXFO.com/patent.

Version number: 5.0.0.1

Contents

Regulatory Information	vii
1 Introducing the OX1 Optical Explorer	1
Main Features	2
Available Options	5
LED Indicator Description	7
Battery Status Icon Description	8
Power Sources	8
Test Functions and Tools	10
Using Your OX1 as a Standalone Unit	11
Using Your OX1 With a Smart Device or PC	11
Technical Specifications	11
Conventions	12
2 Safety Information	13
General Safety Information	13
Other Safety Symbols on Your Unit	15
Laser Safety Information	16
Electrical Safety Information	18
3 Getting Started with Your Unit	21
Turning on Your Unit	21
Turning off Your Unit	22
Configuring Your Unit at First Startup	23
Understanding Fiber Explorer™	24
Viewing Notifications	27
Working With Launch and Receive Test Cords	29
Cleaning and Connecting Optical Fibers	35
Temperature Management	37

Contents

- 4 Setting up Your Unit 39**
 - Adjusting Brightness 39
 - Enabling or Disabling Sound Notifications 40
 - Selecting the Language of Operation 43
 - Adjusting the Date, Time and Time Zone 45
 - Selecting the Distance Units 51
 - Configuring Sleep Mode 54
 - Selecting Test Wavelengths 56
 - Enabling or Disabling Power Measurements 61
 - Enabling or Disabling Auto Save 66
 - Enabling or Disabling Auto Navigation 68
 - Working With Custom Pass/Fail Thresholds or EXFO Advisor 70
 - Working With the PON Tool 80
 - Working With a Demarcation Section 87
 - Configuring the IOR Value 95
 - Reverting to Factory Settings 98

- 5 Working With Jobs 101**
 - Understanding the My Jobs Page 102
 - Understanding the Test Points Page 103
 - Generating Valid Test Point Identifiers 104
 - Creating Local Jobs 110
 - Deleting Local Jobs 117
 - Adding Test Points to a Local Job 120
 - Deleting Test Points From a Local Job 123

- 6 Testing Fibers 127**
 - Performing Measurements 128
 - Working With Link Results 133
 - Working With Link Overview 135
 - Working With Link View 136
 - Performing Tests When Light Is Detected on the Network 138

- 7 Using the Power Checker 139**
 - Setting Thresholds 140
 - Setting Reference Values on Your Power Checker 146
 - Measuring Power or Loss 148

- 8 Using the Light Source 151**

9	Managing Test Results	159
	Viewing Measurements	159
	Changing an Element Type	163
	Understanding the Unit’s Behavior When Saving Measurements	165
	Generating Measurement Reports With a Bluetooth Connection	170
	Generating Measurement Reports With a USB Connection	173
	Generating Measurement Reports With a Wi-Fi Connection	174
10	Working With the TestFlow/Exchange Mobile Application	175
	Installing the TestFlow/Exchange Mobile Application on Your Smart Device	176
	Establishing or Closing a Connection With a Smart Device Via the Bluetooth Technology	177
	Enabling or Disabling the Wireless Communication	181
	Working With a Wireless Network	186
	Transferring a Cloud-Based Job to the OX1	200
	Performing a Measurement Again	204
	Synchronizing Job Results With the Smart Device and the Cloud Server	206
	Generating Job Measurement Reports	209
	Accessing the Online Documentation From the Smart Device	211
11	Maintenance	213
	Cleaning SC Connectors	214
	Cleaning the Touchscreen	215
	Recharging the Battery	215
	Battery Maintenance Recommendations	218
	Replacing the Battery	220
	Verifying the Optical Output of Your Unit	228
	Determining the Condition of the Click-Out Optical Connector (Pro Units Only)	232
	Replacing the Click-Out Optical Connector (Pro Units Only)	234
	Recalibrating the Unit	238
	Upgrading Applications and Software With a Wi-Fi connection	240
	Upgrading Applications and Software With FastReporter 3	243
	Upgrading Applications and Software With a USB Connection	244
	Recycling and Disposal	245
12	Troubleshooting	247
	Solving Common Problems	247
	Restoring Your Unit to Normal Operation	251
	Testing the Touchscreen	258
	Accessing the Online Documentation From the OX1	261
	Contacting the Technical Support Group	265
	Sharing Information With the Technical Support Group	266
	Viewing System Information	269
	Transportation	270

Contents

13 Warranty	271
General Information	271
Gray Market and Gray Market Products	272
Liability	273
Exclusions	273
Certification	273
Service and Repairs	274
EXFO Service Centers Worldwide	275
A Installing the Hand Strap	277
Index	281

Regulatory Information

USA Electromagnetic Interference Regulatory Statement

Electronic test and measurement equipment is exempt from FCC part 15, subpart B compliance in the United States of America. However, EXFO Inc. makes reasonable efforts to ensure compliance to the applicable standards.

The limits set by these standards are designed to provide reasonable protection against harmful interference when the equipment is operated in a commercial environment. This equipment generates, uses, and can radiate radio frequency energy and, if not installed and used in accordance with the user documentation, may cause harmful interference to radio communications. Operation of this equipment in a residential area is likely to cause harmful interference in which case the user will be required to correct the interference at his own expense.

Modifications not expressly approved by the manufacturer could void the user's authority to operate the equipment.

Canada Electromagnetic Interference Regulatory Statement

This equipment generates, uses, and can radiate radio frequency energy and, if not installed and used in accordance with the instruction manual, may cause harmful interference to radio communications. Operation of this equipment in a residential area is likely to cause harmful interference.

Cet équipement génère, utilise et peut émettre de l'énergie radio-fréquence et, s'il n'est pas installé et utilisé conformément à la documentation de l'utilisateur, il peut occasionner une interférence néfaste aux communications radio. L'utilisation de cet équipement dans une zone résidentielle est susceptible d'occasionner une interférence néfaste.

Caution: This equipment is not intended for use in residential environments and may not provide adequate protection to radio reception in such environments.

Attention : Cet appareil n'est pas destiné à être utilisé dans des environnements résidentiels et peut ne pas assurer la protection adéquate à la réception radioélectrique dans ce type d'environnements.

This is a class A, group 1 product.

Ceci est un produit de classe A, groupe 1.

- ▶ **Class A equipment:** Equipment that is, by virtue of its characteristics, highly unlikely to be used in a residential environment, including a home business shall be classified as class A and shall comply with the class A limits specified in the applicable ICES standard. Characteristics considered in this assessment include price, marketing and advertising methodology, the degree to which the functional design inhibits applications suitable to residential environments, or any combination of features that would effectively preclude the use of such equipment in a residential environment.

Classe A : Matériel qui, en raison de ses caractéristiques, ne sera fort probablement pas utilisé dans un milieu domiciliaire ni par des entreprises établies à domicile. Parmi les caractéristiques considérées dans cette évaluation, il y a le prix, les méthodes de commercialisation et de publicité, la mesure dans laquelle les fonctions de l'appareil font qu'il ne se prête pas à des applications convenant au milieu domiciliaire ou toute combinaison de ces caractéristiques qui aurait pour conséquence d'en prévenir effectivement l'utilisation à domicile. Utilisé également pour indiquer les limites d'émission correspondantes qui s'appliquent à un tel matériel.

- ▶ **Class B equipment:** Equipment that cannot be classified as Class A shall comply with the Class B limits specified in the applicable ICES standard.

Classe B : Matériel qui ne peut pas être inclus dans la classe A. Utilisé également pour indiquer les limites d'émission correspondantes qui s'appliquent à un tel matériel.

Regulatory Information

- Group 1 equipment: group 1 contains all equipment which is not classified as group 2 equipment, and includes equipment such as laboratory and scientific equipment, industrial process, measurement and control equipment.

Group 2 equipment: group 2 contains all ISM RF equipment in which radio-frequency energy in the frequency range 9 kHz to 400 GHz is intentionally generated and used or only used locally, in the form of electromagnetic radiation, inductive and/or capacitive coupling, for the treatment of material for inspection/analysis purposes, or for transfer of electromagnetic energy.

Appareils du groupe 1 : le groupe 1 réunit tous les appareils compris dans le domaine d'application de la présente Norme, qui ne sont pas classés comme étant des appareils du groupe 2. Le groupe 1 inclut les appareils scientifiques et de laboratoire, les processus industriels, appareils de mesure ou de contrôle.

Appareils du groupe 2 : le groupe 2 réunit tous les appareils ISM à fréquences radioélectriques dans lesquels de l'énergie à fréquences radioélectriques dans la plage de fréquences comprises entre 9 kHz et 400 GHz est produite et utilisée volontairement ou uniquement utilisée localement sous forme de rayonnement électromagnétique, de couplage inductif et/ou capacitif, pour le traitement de la matière, à des fins d'examen ou d'analyse ou pour le transfert d'énergie électromagnétique.

Supplier's Declaration of Conformity (SDoC)

The SDoC for your product is as follows:

CAN ICES-001 (A) / NMB-001 (A)

EU and UK Electromagnetic Compatibility Regulatory Statement

Warning: This is a class A product. In a domestic environment, this product may cause radio interference in which case the user may be required to take adequate measures. Your product is suitable for use in industrial electromagnetic environments.

General Wireless Compliance Related Information (Units With Wireless Capabilities Only)

Your unit comes with an internal wireless module (adapter) and two antennas for which the information hereafter applies:

This product does not contain any wireless user-serviceable components. Any unauthorized product changes or modifications will invalidate warranty and all applicable regulatory certifications and approvals.

Canada and USA Wireless Compliance Related Information (Units With Wireless Capabilities Only)

Your unit comes with an internal wireless module (adapter) and two antennas for which the information hereafter applies:

- This device complies with Part 15 of the FCC Rules.
- This device complies with Innovation, Sciences and Economic Development Canada license-exempt RSS standards.
- Operation is subject to the following two conditions:
 - (1) This device may not cause harmful interference
 - and
 - (2) this device must accept any interference received, including interference that may cause undesired operation.

Regulatory Information

Use in Specific Environments:

- The use of wireless products in hazardous locations is limited by the constraints posed by the safety directors of such environments.
- The use of wireless products on airplanes is governed by the Federal Aviation Administration (FAA).
- The use of wireless products in hospitals is restricted to the limits set forth by each hospital.
- Do not operate a portable transmitter near unshielded blasting caps or in an explosive environment.

Radiation Exposure Statement:

- The product complies with the US/Canada portable RF exposure limit set forth for an uncontrolled environment and is safe for intended operation as described in this user documentation.
- Further RF exposure reduction can be achieved if the device can be kept as far as possible from the user's body.

RF Function and Frequency Range:

Your unit is designed to operate in the Bluetooth and WLAN 2.4 GHz bands.

The information about the Bluetooth and Wi-Fi frequency bands is as follows:

- Bluetooth: Channels 1 through 11 - Between the frequencies 2412 MHz - 2462 MHz.
The output power is 11.7 dBm typical.
- Wi-Fi: Channels 1 through 11 - Between the frequencies 2412 MHz - 2462 MHz.
The maximum output power is 18.5 dBm.

EU and UK Wireless Compliance Related Information (Units With Wireless Capabilities Only)

Your unit is designed to operate in the Bluetooth and WLAN 2.4 GHz bands.

The information about the Bluetooth and Wi-Fi frequency bands is as follows:

- **Bluetooth:** Channels 1 through 13 - Between the frequencies 2412 MHz - 2472 MHz.
The output power is 11.7 dBm typical.
- **Wi-Fi:** Channels 1 through 13 - Between the frequencies 2412 MHz - 2472 MHz.
The maximum output power is 18.5 dBm typical.

This is a wideband transmission system (transceiver), intended for use in all EU member states, United Kingdom, and EFTA countries, except in France and Italy where restrictive use applies.

In Italy, the end-user should apply for a license at the national spectrum authorities in order to obtain authorization to use the device for setting up outdoor radio links and/or for supplying access to telecommunications and/or network services.

This device may not be used for setting up radio links in France, and in some areas the RF output power may be limited to 10 mW EIRP in the frequency range of 2454 - 2483.5 MHz. For detailed information, the end-user should contact the national spectrum authority in France.

Local Restrictions on 802.11a, 802.11b, 802.11d, 802.11g, 802.11n, and 802.11ac Radio Usage

Due to the fact that the frequencies used by 802.11a, 802.11b, 802.11d, 802.11g, 802.11n, and 802.11ac wireless LAN devices may not yet be harmonized in all countries, 802.11a, 802.11b, 802.11d, 802.11g, 802.11n, and 802.11ac products are designed for use only in specific countries, and are not allowed to be operated in countries other than those of designated use. As a user of these products, you are responsible for ensuring that the products are used only in the countries for which they were intended and for verifying that they are configured with the correct selection of frequency and channel for the country of use.

Simplified EU and UK Declaration of Conformity

For units equipped with wireless capabilities: Hereby, EXFO declares that the radio equipment type “OX1” is in compliance with European Directive 2014/53/EU and the UK legislation S.I. 2017/1206 Radio Equipment Regulations 2017.

The full text of the declaration of conformity is available at the following Internet address: www.exfo.com/en/resources/legal-documentation.

EU Economic Operator

EXFO Solutions SAS
2, rue Jacqueline Auriol,
Saint-Jacques-de-la-Lande,
35091 Rennes Cedex 9
FRANCE

Japanese Technical Conformity Mark for Radio Law (Units With Wireless Capabilities Only)

This equipment contains specified radio equipment that has been certified to the Technical Regulation Conformity Certification for Japan, under the Radio Law.

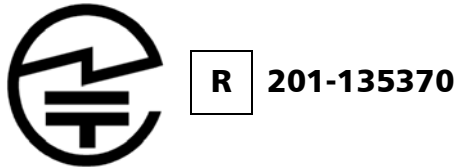

Japan Wireless Compliance Related Information (Units With Wireless Capabilities Only)

Your unit is designed to operate in the Bluetooth and WLAN 2.4 GHz bands.

The information about the Bluetooth and Wi-Fi frequency bands is as follows:

- Bluetooth: Channels 1 through 13 - Between the frequencies 2412 MHz - 2472 MHz.
The output power is 11.7 dBm typical.
- Wi-Fi: Channels 1 through 13 - Between the frequencies 2412 MHz - 2472 MHz.
The maximum output power is 18.5 dBm.

1 Introducing the OX1 Optical Explorer

The OX1 Optical Explorer is a handheld, ultra-simple, and ultra-fast tool offering multiple test functions to verify any short- to medium-length (up to 40 km) optical links and their components. It is particularly well suited for installation and repair jobs.

For units with wireless capabilities, it can work in association with a smart device equipped with the TestFlow/Exchange mobile application allowing you to document the test results, archive them, and generate reports.

All measurements are part of a job. A local job can be created on your unit or a cloud-based job can be created using the TestFlow/Exchange mobile application and transferred to your unit. All measurements are kept in memory.

You can also open, in turn, the power checker and the source page.

Note: *Depending on the type of smart device you are using, the appearance of the Optical Explorer tool (available from the TestFlow/Exchange mobile application) may vary slightly from the illustrations presented in this documentation. Unless otherwise specified, the information applies both to the Android- and iOS-based smart devices.*

Note: *Both on your unit and in the TestFlow/Exchange mobile application, the period is used as the decimal separator in numerical values, when applicable.*

Main Features

- Fiber length, loss and optical return loss (ORL) measured in a single-ended process, in a few seconds
- Easy detection and location of common causes of failure with the Fault Xplorer™ function
- Quality evaluation of the installations with EXFO Advisor™. Measurements are rated using a five-star system.
- PDF report creation
- Job management and cloud storage
- Replaceable Click-Out™ optical connector (Pro units only)

Front panel

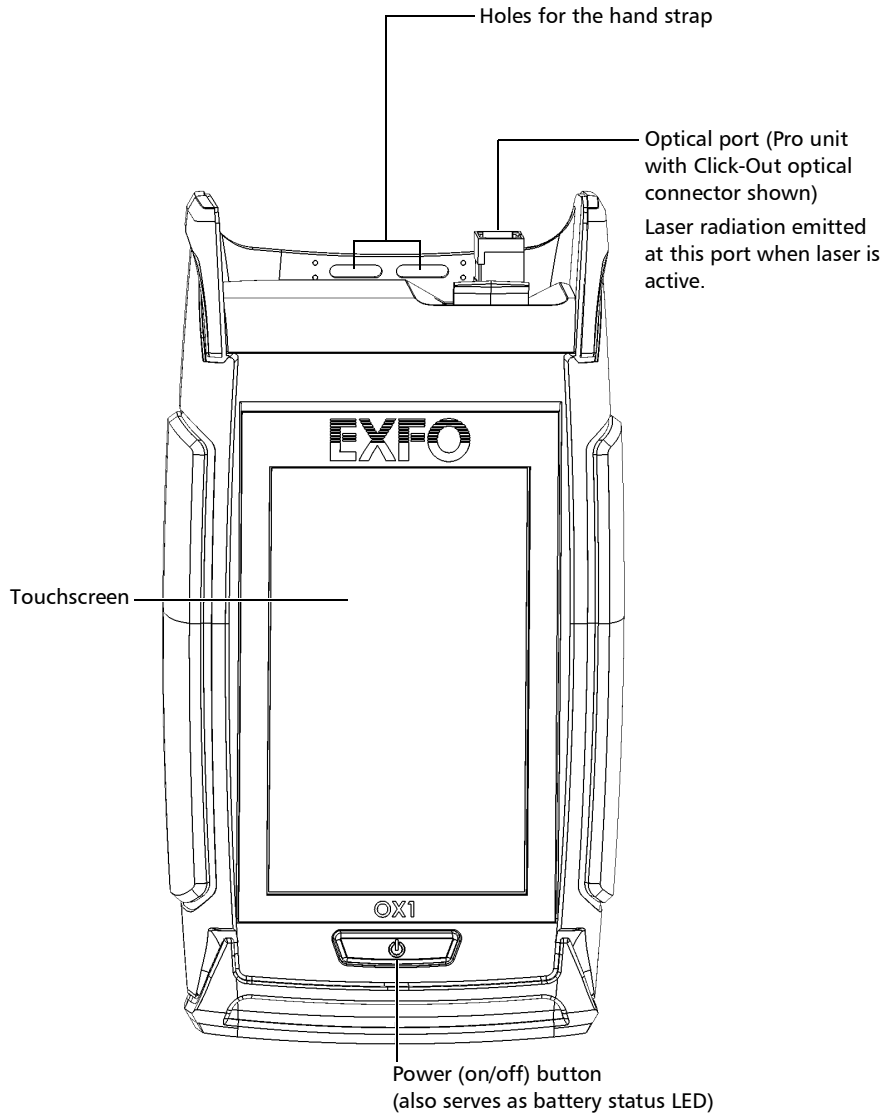

Introducing the OX1 Optical Explorer

Main Features

Top panel

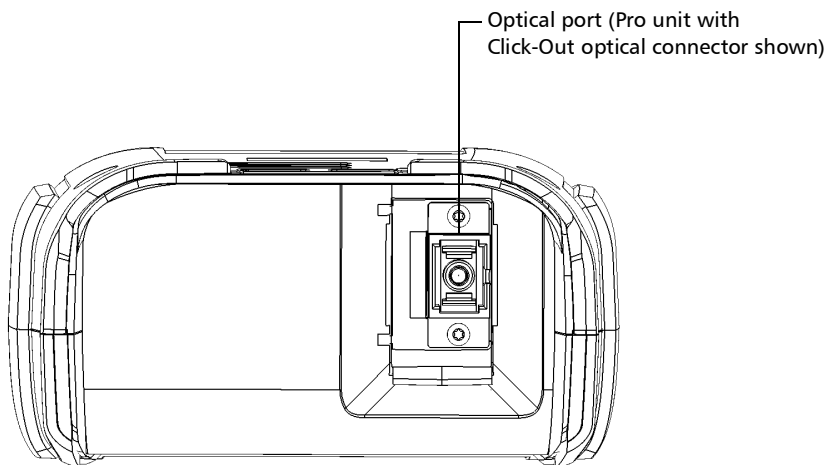

Bottom panel

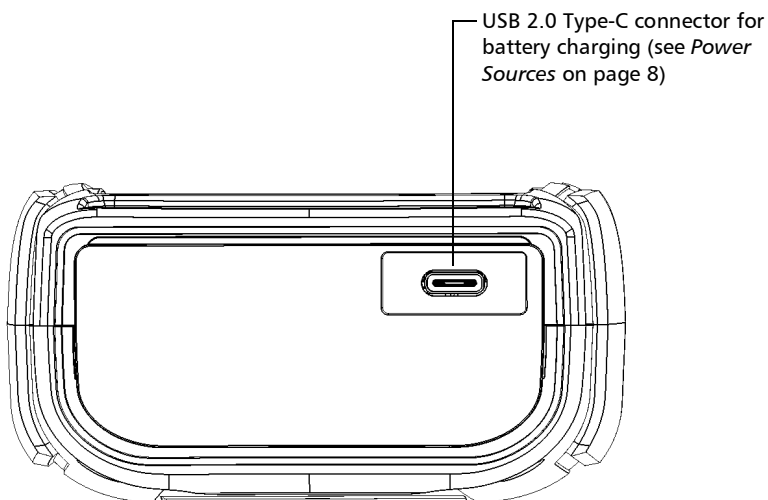

Available Options

Several options are available for the Optical Explorer:

Option	Description
M	<ul style="list-style-type: none">➤ Optical Explorer designed for the maintenance of live fibers➤ 1650 nm + 10 nm, filtered
PRO-M	<ul style="list-style-type: none">➤ Optical Explorer Pro designed for the maintenance of live fibers➤ 1650 nm + 10 nm, filtered➤ Click-Out optical connector➤ Link Mapper test function
PRO-M-PPM	<ul style="list-style-type: none">➤ Optical Explorer Pro designed for the maintenance of live fibers➤ 1650 nm + 10 nm, filtered➤ Click-Out optical connector➤ Link Mapper test function➤ Broadband and dual-channel PON power checker

Introducing the OX1 Optical Explorer

Available Options

Option	Description
I	<ul style="list-style-type: none">➤ Optical Explorer designed for installation or repair of dark fibers➤ 1310/1550 nm \pm30 nm
PRO-I	<ul style="list-style-type: none">➤ Optical Explorer Pro designed for installation or repair of dark fibers➤ 1310/1550 nm \pm30 nm➤ Click-Out optical connector➤ Link Mapper test function
PRO-I-NRF	<ul style="list-style-type: none">➤ Optical Explorer Pro designed for installation or repair of dark fibers➤ Wi-Fi/Bluetooth factory disabled. Wi-Fi/Bluetooth can be enabled by returning the unit to an authorized EXFO service center➤ 1310/1550 nm \pm30 nm➤ Click-Out optical connector➤ Link Mapper test function
PRO-MI	<ul style="list-style-type: none">➤ Optical Explorer Pro designed for both installation or repair of dark fibers, and maintenance of live fibers➤ 1310/1550 nm \pm30 nm➤ 1650 nm +10 nm, filtered➤ One output port➤ Click-Out optical connector➤ Link Mapper test function

LED Indicator Description

The power button, located on the front panel of your unit, also serves as a LED indicator providing you with information about the battery status.

Unit	Status	Meaning
Connected to an external power source	Blue	The battery is fully charged.
	Blue, blinking – long pulse ^a	The battery is charging.
	Blue, blinking – short pulse ^b	The battery charge has been interrupted, possibly because the unit may not be within the recommended charging temperatures. For more information, see <i>Equipment Ratings</i> on page 19.
	Red, fast blinking	Charge or temperature error.
	Red, steady for 10 seconds	The battery level is too low to start the unit.
	White	The unit is starting up.
Not connected to an external power source	Off	The unit is not connected to an external power source.
	Red, steady for 10 seconds	The unit is off and the battery level is too low to start the unit.
	White	The unit is starting up.

a. LED lit during 50 % of duty cycle.



b. LED lit during 10 % of duty cycle.

Introducing the OX1 Optical Explorer

Battery Status Icon Description

Battery Status Icon Description

The battery status icon is shown in the upper right corner of the title bar. It complements the information provided by the unit's LED.

Icon	Meaning
	The portion of the icon that appears in white in the title bar (in black here) reflects the current battery level.
	A red icon indicates that the battery level is running low and that you should connect the unit to a power outlet.
	A flash symbol indicates that the unit is connected to an external power source.

Power Sources

The Optical Explorer operates with the following power sources:

- Indoor use only: USB power adapter connected to a power outlet (fastest way to charge the battery).

Note: *The standard USB ports of a computer cannot power your unit or charge its battery while the unit is on. If you connect your unit to such a USB port with the USB cable, the unit will still consume battery power. If the unit is off when you connect it to the USB port of a computer, its battery could charge, but slowly.*

Note: *If you have a vehicle equipped with dedicated USB charging ports, you could connect your unit to one of these ports to charge the battery. The actual results will vary with each vehicle. You could also use a certified USB power bank (portable charger) to charge your unit.*

- Indoor and outdoor use:
 - One lithium-ion (Li-ion) or one lithium-polymer (Li-Po) rechargeable battery (main battery that automatically takes over if you disconnect the unit from its external power source).

Possible to switch from an external power source to battery power or vice versa without affecting operation.
 - Rechargeable battery for real-time clock. This battery can keep the date and time for weeks even if the unit is not connected to AC power and the lithium-ion battery or the lithium-polymer (main battery) is depleted.

Note: *Both the main battery and the clock battery recharge automatically when the unit is connected to an external power source. However, the clock battery will only charge when the unit is on or in sleep mode.*

Note: *You can replace the main battery yourself (see Replacing the Battery on page 220), but not the clock battery.*

Note: *When the ambient temperature is below 0 °C (32 °F) or when it reaches or exceeds about 40 °C (104 °F), the main battery can either charge more slowly than usual, or not charge at all, depending on the internal temperature of your unit.*

For more information, see *Electrical Safety Information* on page 18.

Test Functions and Tools

Your Optical Explorer offers functions and tools to help you with common testing situations such as fiber break location, optical link verification, identification and location of common causes of networks failure.

Each test functions offers an increasing level of detail. See *Testing Fibers* on page 127 for details.

- Flash Advisor™: Offers a quick verification of the continuity and overall quality of simple fiber links. This function, which is selected by default, measures the link length, the insertion loss and the ORL.
- Fault Xplorer: Provides an overall verification of fiber links as well as an automatic identification and investigation of potential causes of failure. This function measures the link length, the insertion loss, the ORL, the loss, the reflectance, and the distance to faults. It also localizes the connectors and identifies the fault types such as splices or macrobends.
- Link Mapper: Provides the mapping of the optical link including fiber sections and all detectable elements over the link. This function measures the link length, the insertion loss, the ORL, the loss, the reflectance, the distance to elements and identifies the element types such as splices, connectors and macrobends.

Note: *Only Pro units offer the Link Mapper function.*

- Power checker: This tool measures the absolute power and the insertion loss. It can also detect the tone coming from the light source. See *Using the Power Checker* on page 139 for details.
- Light source: You can use this tool to perform measurements with a power meter. The modulation can be continuous or set to another value. See *Using the Light Source* on page 151 for details.

Note: *If you choose to work with a modulated signal on the source, ensure that the power meter you are using supports a modulated signal as well.*

Using Your OX1 as a Standalone Unit

You can perform measurements for verification using one of the test functions (Flash Advisor, Fault Explorer, or Link Mapper), the light source or the power checker. See *Test Functions and Tools* on page 10, and *Testing Fibers* on page 127.

You can generate single-measurement reports with the measurements stored on your OX1. If your unit is equipped with wireless capabilities, you will need a smart device equipped with the TestFlow/Exchange mobile application. See *Generating Measurement Reports With a Bluetooth Connection* on page 170. You can also generate reports with a PC using EXFO's FastReporter 3. For more information, see the documentation on FastReporter 3.

Using Your OX1 With a Smart Device or PC

If your unit is equipped with wireless capabilities, you can also use your OX1 in association with a smart device equipped with the TestFlow/Exchange mobile application allowing you to document your results, archive them on a cloud server, and generate reports (single or multiple results). See *Working With the TestFlow/Exchange Mobile Application* on page 175.

You can create local jobs on your OX1. See *Creating Local Jobs* on page 110. The results are saved on the OX1 under a list of sequential test point identifiers that you define and are generated by your unit during the local job creation process. See *Generating Valid Test Point Identifiers* on page 104. To view the measurement results, see *Viewing Measurements* on page 159.

Technical Specifications

To obtain this product's technical specifications, visit the EXFO Web site at www.exfo.com.

Conventions

Before using the product described in this guide, you should understand the following conventions:



WARNING

Indicates a potentially hazardous situation which, if not avoided, could result in *death or serious injury*. Do not proceed unless you understand and meet the required conditions.



CAUTION

Indicates a potentially hazardous situation which, if not avoided, may result in *minor or moderate injury*. Do not proceed unless you understand and meet the required conditions.



CAUTION

Indicates a potentially hazardous situation which, if not avoided, may result in *component damage*. Do not proceed unless you understand and meet the required conditions.



IMPORTANT

Refers to information about this product you should not overlook.

2 **Safety Information**

General Safety Information



WARNING

Do not install or terminate fibers while a light source is active. Never look directly into a live fiber and ensure that your eyes are protected at all times.



WARNING

The use of controls, adjustments and procedures, namely for operation and maintenance, other than those specified herein may result in hazardous radiation exposure or impair the protection provided by this unit.



WARNING

If the equipment is used in a manner not specified by the manufacturer, the protection provided by the equipment may be impaired.



WARNING

Use only accessories designed for your unit and approved by EXFO. For a complete list of accessories available for your unit, refer to its technical specifications or contact EXFO.

Safety Information

General Safety Information



IMPORTANT

Refer to the documentation provided by the manufacturers of any accessories used with your EXFO product. It may contain environmental and/or operating conditions limiting their use.



IMPORTANT

When you see the following symbol on your unit , make sure that you refer to the instructions provided in your user documentation. Ensure that you understand and meet the required conditions before using your product.



IMPORTANT

When you see the following symbol on your unit , it indicates that the unit is equipped with a laser source, or that it can be used with instruments equipped with a laser source. These instruments include, but are not limited to, modules and external optical units.













IMPORTANT

Other safety instructions relevant for your product are located throughout this documentation, depending on the action to perform. Make sure to read them carefully when they apply to your situation.

Other Safety Symbols on Your Unit

One or more of the following symbols may also appear on your unit.

Symbol	Meaning
	Direct current
	Alternating current
	The unit is equipped with an earth (ground) terminal.
	The unit is equipped with a protective conductor terminal.
	The unit is equipped with a frame or chassis terminal.
	On (Power)
	Off (Power)
 OR 	On/off (Power)
	Fuse

Laser Safety Information

Your instrument is in compliance with standard IEC 60825-1: 2014.



WARNING

Viewing the laser output with telescopic optical instruments (for example, telescopes and binoculars) may pose an eye hazard and thus the user should not direct the beam into an area where such instruments are likely to be used.

Laser radiation may be encountered at the optical output port.

The following label indicates that the product contains a Class 1M source:



INVISIBLE LASER RADIATION
DO NOT VIEW DIRECTLY WITH OPTICAL INSTRUMENTS
DO NOT EXPOSE USERS OF TELESCOPIC OPTICS
CLASS 1M LASER PRODUCT

RAYONNEMENT LASER INVISIBLE
NE PAS OBSERVER DIRECTEMENT À L'AIDE D'INSTRUMENTS D'OPTIQUE
NE PAS EXPOSER LES UTILISATEURS DE DISPOSITIF OPTIQUE
TÉLESCOPIQUE
APPAREIL À LASER DE CLASSE 1MINVISIBLE LASER RADIATION
DO NOT VIEW DIRECTLY WITH OPTICAL INSTRUMENTS
DO NOT EXPOSE USERS OF TELESCOPIC OPTICS
CLASS 1M LASER PRODUCT

Wavelength: / Longueur d'onde Wavelengths: 1250 nm-1600 nm

Pulse width: / Largeur de l'impulsion Pulse width:  $\leq 20 \mu s$

Max. peak power: / Puissance crête maximum Max. peak power: 
 $\leq 100 \text{ mW}$

Wavelength: / Longueur d'onde Wavelengths: 1600 nm-1700 nm

Pulse width: / Largeur de l'impulsion Pulse width:  $\leq 20 \mu s$

Max. peak power: / Puissance crête maximum Max. peak power: 
 $\leq 150 \text{ mW}$

Electrical Safety Information



WARNING

If you need to ensure that the unit is completely turned off, disconnect the power cable and remove the battery. For more information on how to remove the battery, see the section about replacing the battery in this user documentation.



WARNING

- ▶ Use the external power supply (USB power adapter) indoors only.
- ▶ Never connect the unit to the AC mains (with the USB power adapter) when it is used outdoors.
- ▶ To avoid electrical shock, do not operate the unit if any part of the outer surface (covers, panels, etc.) is damaged.
- ▶ Only authorized personnel should carry out adjustments, maintenance or repair of opened units under voltage. A person qualified in first aid must also be present. Do not replace any components while the USB cable and battery are connected.
- ▶ Unless otherwise specified, all interfaces are intended for connection to ES1 circuits only.
- ▶ Use only the listed and certified USB power adapter provided by EXFO with your unit. It provides reinforced insulation between primary and secondary, and is suitably rated for the country where the unit is sold.
- ▶ Capacitors inside the unit may be charged even if the unit has been disconnected from its electrical supply.



CAUTION

- Position the unit so that the air can circulate freely around it.
- When you use the unit outdoors, ensure that it is protected from liquids, dust, direct sunlight, precipitation, and full wind pressure.



CAUTION

The use of voltages higher than those indicated on the label affixed to your unit may damage the unit.

Equipment Ratings	
Temperature ➤ Operation ^a ➤ Storage	<ul style="list-style-type: none"> ➤ unit powered by battery: -10 °C to 45 °C (14 °F to 113 °F)^b ➤ unit connected to AC power (with USB power adapter): 0 °C to 40 °C (32 °F to 104 °F)^c ➤ unit – short-term storage^d: -40 °C to 70 °C (-40 °F to 158 °F) ➤ unit – long-term storage^e: 10 °C to 35 °C (50 °F to 95 °F)
Relative humidity ^f	<ul style="list-style-type: none"> ➤ unit: ≤ 93 % non-condensing ➤ USB power adapter: 10 % to 90 % non-condensing
Maximum operation altitude	<ul style="list-style-type: none"> ➤ 2000 m (6562 ft) (unit connected to external power source) ➤ 5000 m (16405 ft) (unit operated from battery)

Safety Information

Electrical Safety Information

Equipment Ratings	
Pollution degree	<ul style="list-style-type: none">➤ 2 (unit connected to external power source)➤ 3 (unit operated from battery)^g
Overvoltage category	<ul style="list-style-type: none">➤ unit: I➤ USB power adapter: II
Measurement category	Not rated for measurement categories II, III, or IV
Input power ^h	<ul style="list-style-type: none">➤ unit: 5 V ---; 2 A➤ USB power adapter: 100 - 240 V ~; 50/60 Hz; 1 A max

- a. For Fault Xplorer tests performed in normal conditions: minimal brightness and typically a 15-second measurement every 180 seconds.
The operation temperature varies with the test function and intensity of tests:
Fault Xplorer - intensive use (with minimal brightness and typically a 15-second measurement every 60 seconds): -10 °C to 35 °C (14 °F to 95 °F).
- b. When the unit is used at an altitude of 5000 m, the maximum operating temperature is 27 °C (80.6 °F).
- c. When the ambient temperature is below 0 °C (32 °F) or when it reaches or exceeds about 40 °C (104 °F), the main battery can either charge more slowly than usual, or not charge at all, depending on the internal temperature of your unit.
- d. Short-term storage corresponds to the storage of the unit for a maximum of 48 hours.
- e. Long-term storage corresponds to the storage of the unit for more than three months.
- f. Measured in 0 °C to 31 °C (32 °F to 87.8 °F) range, decreasing linearly to 50 % at 40 °C (104 °F).
- g. Equipment must be normally protected against exposure to direct sunlight, precipitation and full wind pressure.
- h. Not exceeding $\pm 10\%$ of the nominal voltage.

3 Getting Started with Your Unit

Turning on Your Unit

When you turn on the unit for the very first time, a wizard is displayed, enabling you to set the operation language, read and accept the EXFO license agreement, and set other regional settings (see the section about the first startup for more information).

Note: *The settings you modify at startup can be modified later if necessary.*

To turn on the unit:

Press the on/off button until the unit beeps once. Its LED will light up and remain lit during the whole startup process (until the splash screen is displayed).

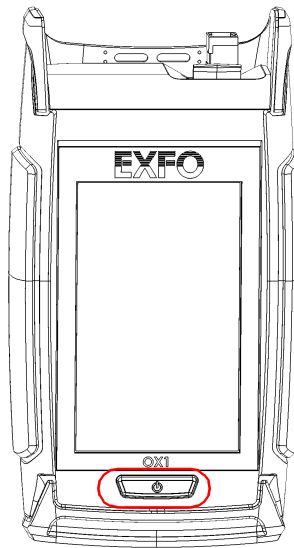

Turning off Your Unit

Unless specified otherwise in this documentation, the settings you configure on your unit are kept in memory even when you turn the unit off.

There are several ways to turn off the unit, including the following:

- *Sleep*: keeps the unit's status information in memory (RAM). The next time you turn your unit on, you will quickly return to your work environment (running applications will still be running). If you intend to leave your unit in sleep mode for more than a few hours, you should perform a shutdown instead to save battery power. After four hours in sleep mode, your unit will go into shutdown mode automatically to save battery power.
- *Shutdown*: completely cuts power to the unit; the unit will perform a complete restart routine the next time you use it. You should perform a shutdown if you do not intend to use your unit for several hours.

After a shutdown, the unit will start in Fiber Explorer.

Note: *Should the unit ever stop responding, you can force a hardware reset by pressing and holding down the on/off button for at least 10 seconds. To restart your unit, release the on/off button, and then press it again as you would normally do to start your unit.*

To enter the sleep mode:

Press the on/off button. The unit's backlight will turn off and the touchscreen will be deactivated.

To exit the sleep mode and resume your work:

Press the on/off button.

To turn off the unit completely (shutdown):

Press the on/off button for about three seconds. The unit will beep once and its LED will light up briefly.

Configuring Your Unit at First Startup

The first time you turn on the unit, a wizard is displayed, enabling you to set the operation language, read and accept the EXFO license agreement, configure the date and time, and select the desired distance units.

Note: *You can change the regional parameters later if necessary.*

Once the configuration is complete, you are presented with an overview of the main features of your unit. This getting started guide will be available at all times from your unit for future reference (see *Accessing the Online Documentation From the OX1* on page 261).

To configure your unit at first startup:

- 1.** If it is not already done, turn on the unit.
- 2.** When the wizard prompts you, select the desired operation language. If you select a language other than English, the unit will restart automatically to apply the change.
- 3.** Read and accept the EXFO license agreement, then tap **NEXT**.
- 4.** Follow the on-screen instructions to configure the other regional parameters and view the getting started guide.
- 5.** If possible, configure a Wi-Fi network allowing you to retrieve the updates and archive your results on the cloud server (see *Configuring a Wireless Network* on page 189).

You are now ready to start working with your OX1.

Getting Started with Your Unit

Understanding Fiber Xplorer™

Understanding Fiber Xplorer™

Fiber Xplorer can be seen as the starting point of the application. You can perform measurements in one of the test functions and navigate through the results. If your unit has wireless capabilities, it provides information on many elements such as the Bluetooth connection, Wi-Fi connection and signal strength.

From Fiber Xplorer, you can also open the three-line menu to access the test tools, parameters, and notifications.

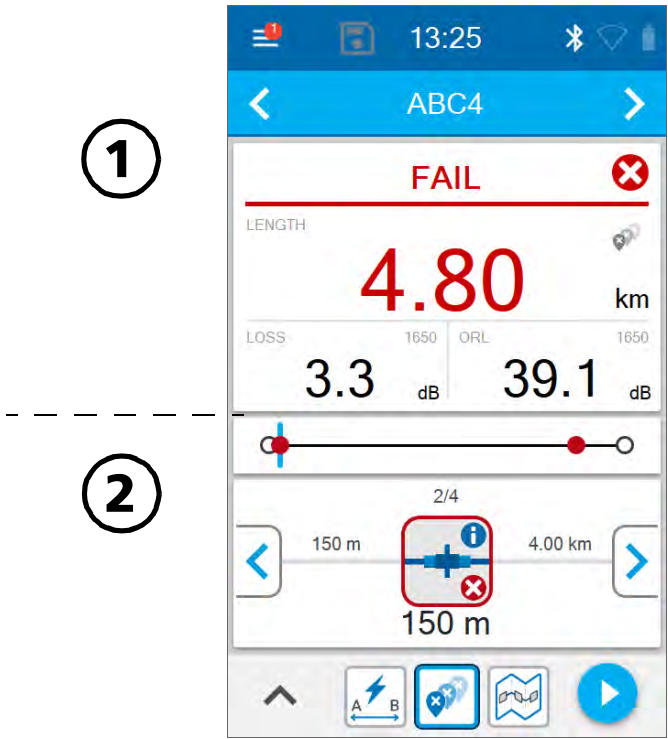

1

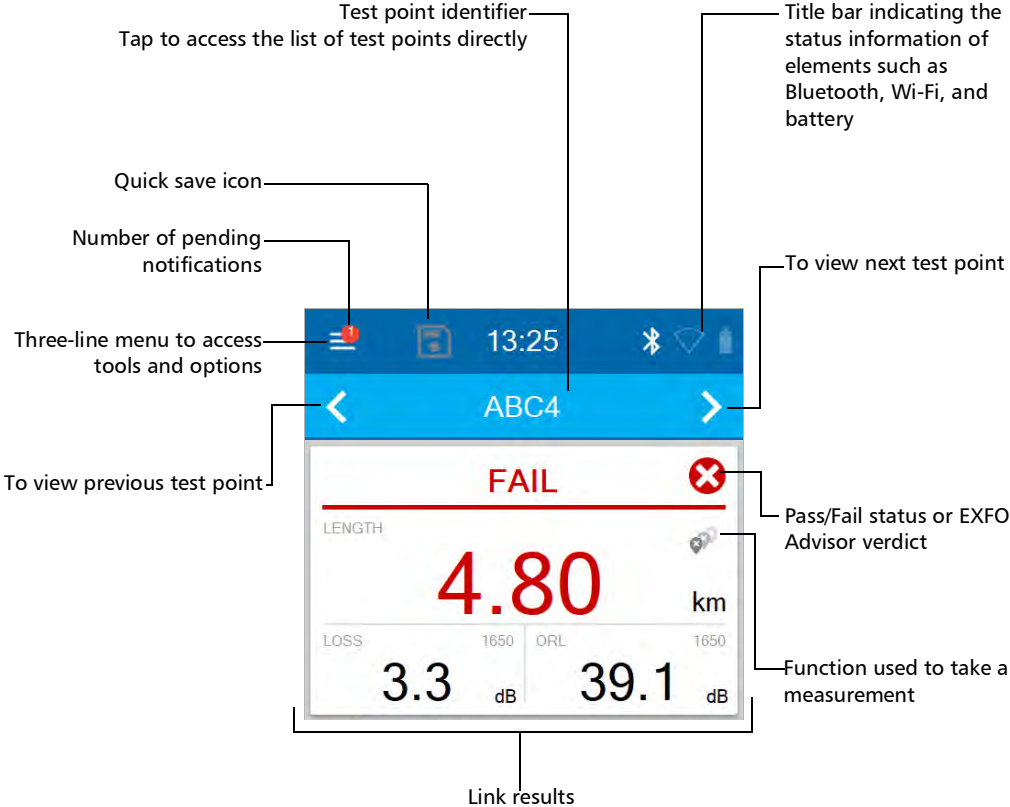

Getting Started with Your Unit

Understanding Fiber Xplorer™

2

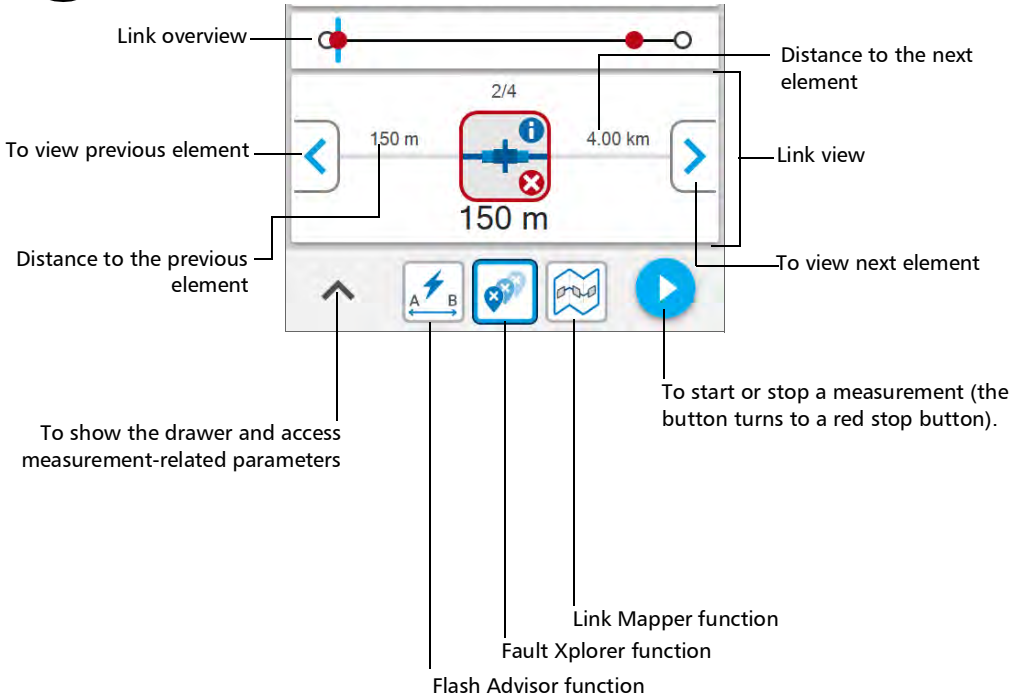

Viewing Notifications

The OX1 informs you when there are pending notifications on your unit that require your attention. The number of pending notifications is displayed in a red bubble directly on the three-line menu icon  and in the main menu. These notifications are displayed when:

- the optical output diagnosis has failed (see *Verifying the Optical Output of Your Unit* on page 228)
- your unit's memory is approaching full capacity
- your unit's internal temperature reaches a critical threshold that prevents the unit from taking measurements within defined specifications

The notification related to the optical output diagnosis can only be erased when the result of the verification is pass.

Note: *The notification of the failed diagnosis is kept in memory even if you revert to factory settings.*

You can delete a notification when it has been read.

Getting Started with Your Unit

Viewing Notifications

To view notifications:

- 1.** From the main menu, tap **Notifications**.

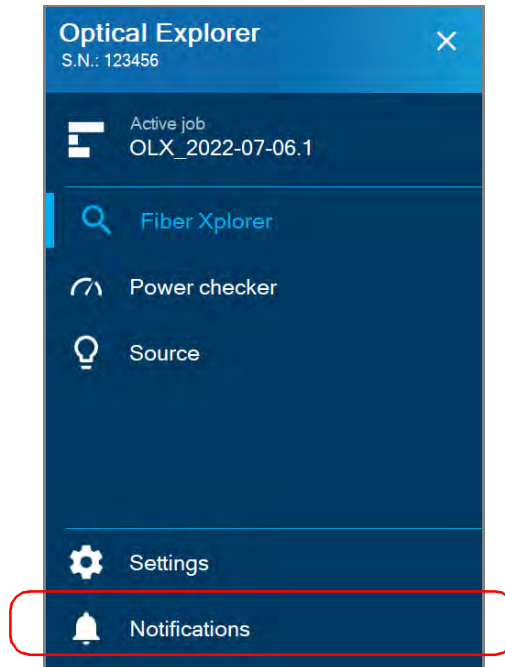

The pending notifications are displayed in a list.

- 2.** You can delete the notification you have read with the X.
- 3.** When the unit prompts you, tap **YES**.

Working With Launch and Receive Test Cords

For easier handling and optimum performance when you work with launch and receive cords, EXFO strongly recommends to use the cords especially designed by EXFO for your OX1 unit. However, you can use your own test cords. By default, the use of launch and receive cords is disabled, but you can enable it and specify the lengths of the cords you intend to use. The length of both cords is set to 20 meters by default, but you can change it. You can also change the meters for feet if you prefer. All your settings are kept in memory even when you turn off the unit.

The launch and receive cords and their connectors should always be in good condition. The connectors should also be clean before using the cords.

The launch cords used with units having APC-type connectors are 20 meters long. Since these connectors tend to be less reflective even when they are showing signs of wear, 20 meters is usually enough to cover the dead zone located between the OX1 and the actual fiber being measured.

The OX1 units equipped with UPC-type connectors require 60-meter long launch cables. The reflectance between the unit and the actual fiber being measured should be below -35 dB. This value can be significantly affected by connectors that are dirty and showing signs of wear.

Refer to the technical specifications of your unit to have a complete list of all the launch and receive cords available.

Getting Started with Your Unit

Working With Launch and Receive Test Cords

To configure the launch and receive cords lengths from the Settings page:

1. From the main menu, tap **Settings**.

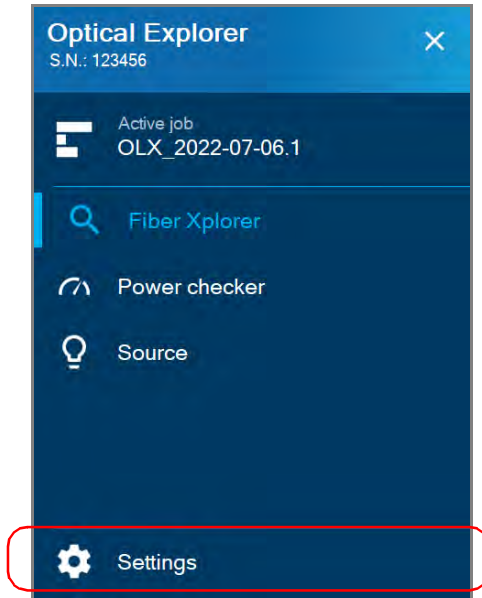

- From the **Optical Explorer** section, tap **Test cords**.

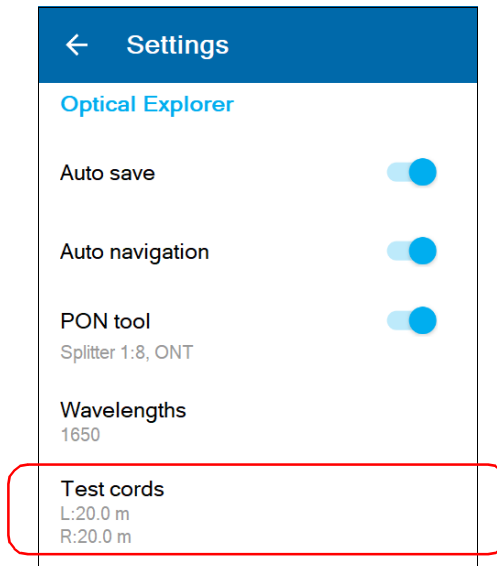

- To configure the launch and receive cords settings, proceed as follows:
 - If necessary, activate the feature with the corresponding toggle.

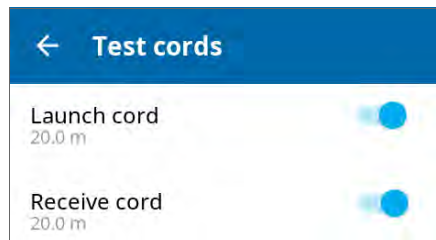

- Under the desired test cord, tap the displayed length to edit it.

Getting Started with Your Unit

Working With Launch and Receive Test Cords

- 3c.** Select the length of the cable you want to use for your measurement. If you have selected **Custom**, enter the length with the numeric keypad.

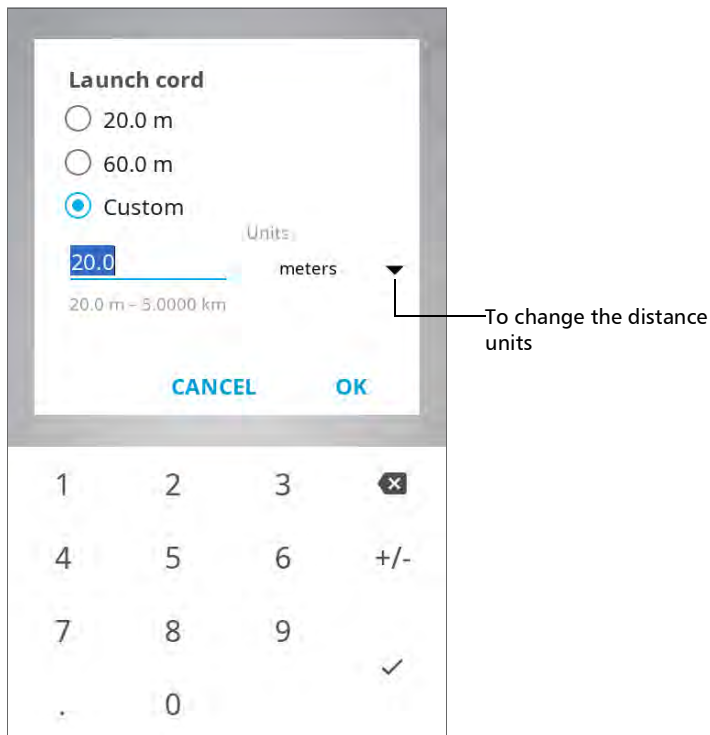

- 3d.** If necessary, change the distance units.

- 3e.** Tap **OK** to confirm.

The new selection is taken into account for the next measurement.

To configure the launch and receive cords lengths from Fiber Xplorer:

1. From Fiber Xplorer, tap the arrow to access the drawer.

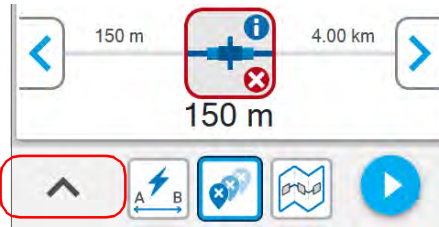

2. Tap **Test cords**.

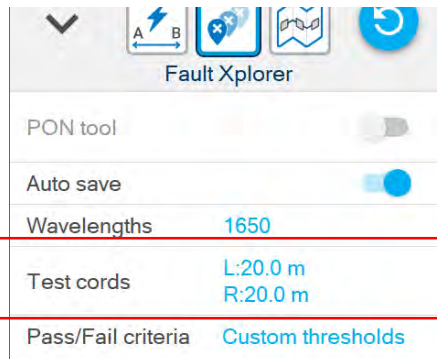

3. To configure the launch and receive cords settings, proceed as follows:
 - 3a. If necessary, activate the feature with the corresponding toggle.

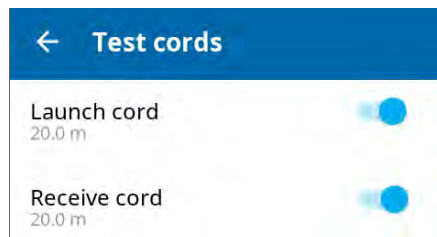

Getting Started with Your Unit

Working With Launch and Receive Test Cords

- 3b.** Under the desired test cord, tap the displayed length to edit it.
- 3c.** Select the length of the cable you want to use for your measurement. If you have selected **Custom**, enter the length with the numeric keypad.

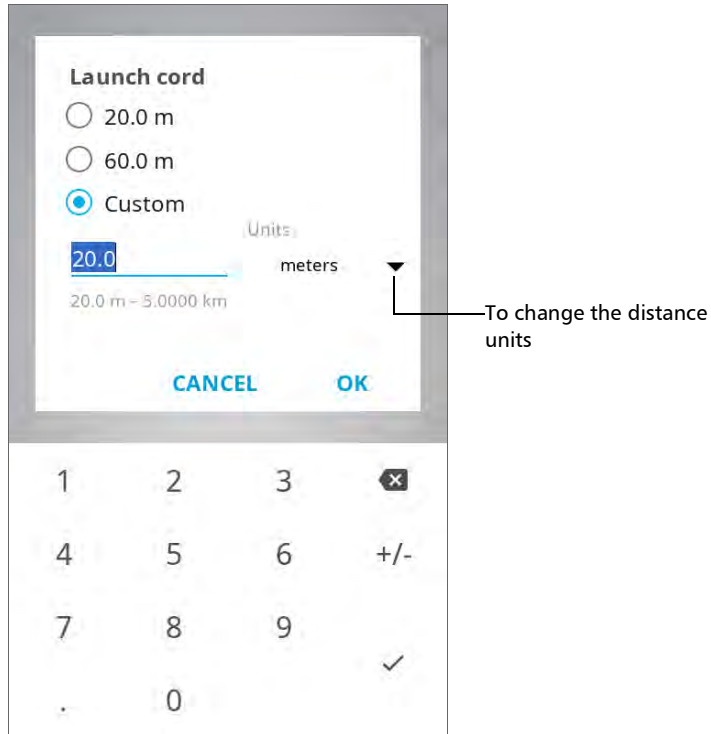

- 3d.** If necessary, change the distance units.
- 3e.** Tap **OK** to confirm.

The new selection is taken into account for the next measurement.

Cleaning and Connecting Optical Fibers



IMPORTANT

To ensure maximum power and to avoid erroneous readings:

- Always inspect fiber ends and make sure that they are clean as explained below before inserting them into the port. EXFO is not responsible for damage or errors caused by bad fiber cleaning or handling.
- Ensure that your patchcord has appropriate connectors. Joining mismatched connectors will damage the ferrules.

To connect the fiber-optic cable to the port:

- 1.** Inspect the fiber using a fiber inspection scope (or probe). If the fiber is clean, proceed to connecting it to the port. If the fiber is dirty, clean it as explained below.
- 2.** Clean the fiber ends as follows:
 - 2a.** Gently wipe the fiber end with a lint-free swab dipped in optical-grade liquid cleaner.
 - 2b.** Use a dry swab to dry the connector completely.
 - 2c.** Visually inspect the fiber end to ensure its cleanliness.

Getting Started with Your Unit

Cleaning and Connecting Optical Fibers

3. Carefully align the connector and port to prevent the fiber end from touching the outside of the port or rubbing against other surfaces.

If your connector features a key, ensure that it is fully fitted into the port's corresponding notch.

4. Push the connector in so that the fiber-optic cable is firmly in place, thus ensuring adequate contact.

If your connector features a screw sleeve, tighten the connector enough to firmly maintain the fiber in place. Do not overtighten, as this will damage the fiber and the port.

Note: *If your fiber-optic cable is not properly aligned and/or connected, you will notice heavy loss and reflection.*

EXFO uses good quality connectors in compliance with EIA-455-21A standards.

To keep connectors clean and in good condition, EXFO strongly recommends inspecting them with a fiber inspection scope (or probe) before connecting them. Failure to do so may result in permanent damage to the connectors and degradation in measurements.

Temperature Management

The internal temperature of your unit will vary with the ambient temperature, but also with the type of tests you perform and their intensity.

To regulate its temperature, your unit will determine the most appropriate fan speed, depending on the power requirements.

Your unit has also been designed to adapt its behavior as necessary to regulate its temperature. For this reason, in high-temperature conditions, you could receive warning messages. If the temperature keeps rising and reaches the limit your unit will turn off as self-protection.

For more information on the effects of temperature on battery charging, see *Power Sources* on page 8.



IMPORTANT

For optimum performance of your unit:

- Ensure that it remains within the recommended operation and storage temperatures (see *Equipment Ratings* on page 19).
- Avoid leaving your unit in an overheated vehicle. You may have to let your unit cool down before being able to use it.
- Ensure that your unit is normally protected from direct sunlight (during use and storage).

4 **Setting up Your Unit**

Adjusting Brightness

You may want to adjust the display brightness yourself to better fit your work environment or preferences.

You may also want to reduce the display brightness to save battery power (the higher the brightness level, the higher the power consumption).

The brightness value is kept in memory even when you turn the unit off.

To adjust the display brightness:

1. From the main menu, tap **Settings**.

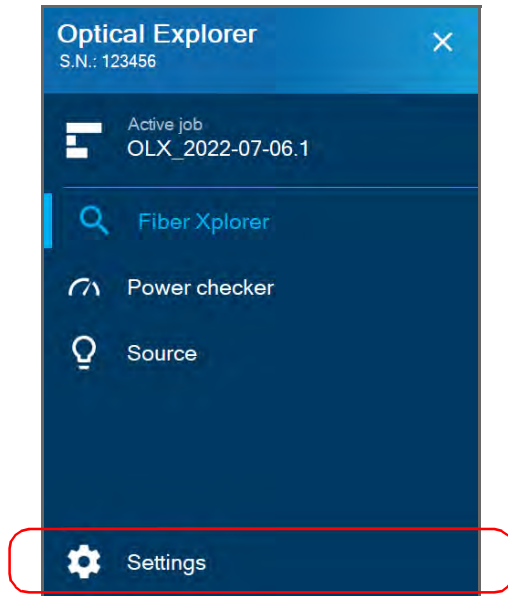

Setting up Your Unit

Enabling or Disabling Sound Notifications

2. Under **Brightness**, tap the dots until the screen appearance is to your liking. You can also tap the desired brightness icon to quickly set the brightness to the minimum or the maximum value.

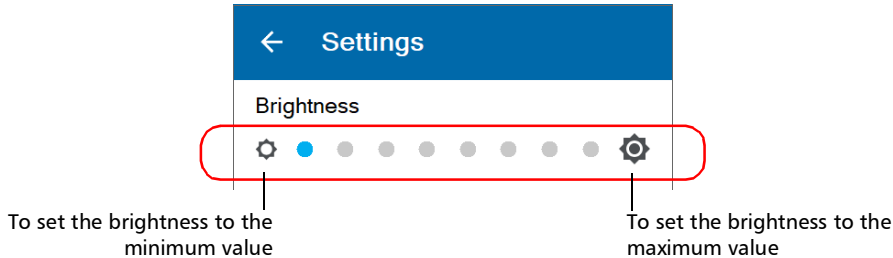

The new brightness value is taken into account immediately.

Enabling or Disabling Sound Notifications

By default, your unit emits a sound at the end of a measurement and when the power checker detects a tone.

This sound varies with the type of notification, which means that you will hear a different sound in each of these situations:

- At the end of a measurement performed using EXFO Advisor thresholds.
- At the end of a measurement performed using custom thresholds when its status is Pass.
- At the end of a measurement performed using custom thresholds when its status is Fail.
- When the power checker detects a tone from a source.

You can disable the sound notifications if you prefer. Your preference is kept in memory even when you turn the unit off.

To enable or disable the sound notifications on your unit:

1. From the main menu, tap **Settings**.

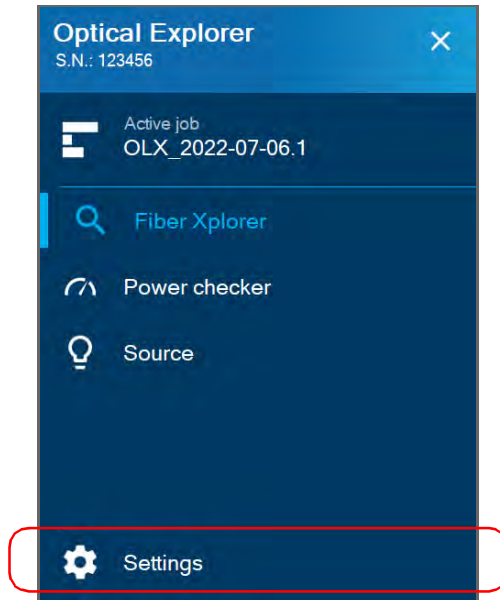

2. Scroll down to the **Device settings** section.

Setting up Your Unit

Enabling or Disabling Sound Notifications

3. With the **Sounds** toggle, enable or disable the sound notifications.

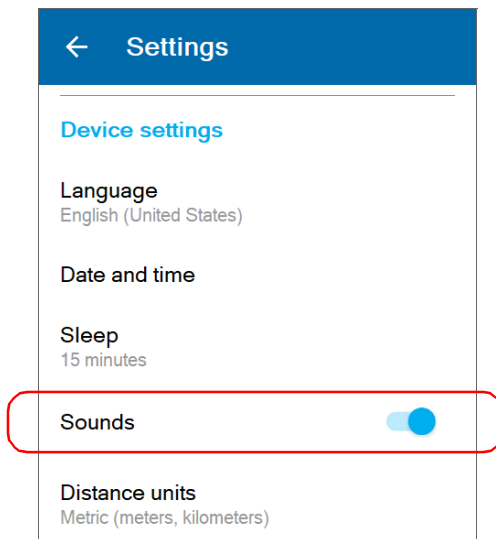

The new value is taken into account immediately.

Selecting the Language of Operation

You may display the user interface in one of the available languages. English is the default language.

The value is kept in memory even when you turn the unit off.

To select a new interface language:

1. From the main menu, tap **Settings**.

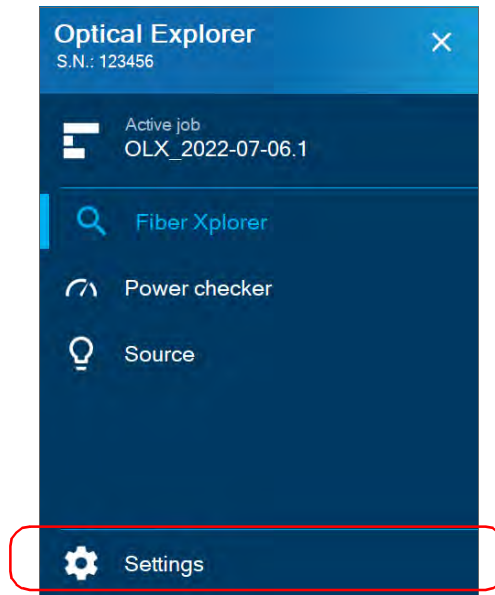

2. Scroll down to the **Device settings** section.

Setting up Your Unit

Selecting the Language of Operation

3. Tap **Language**.

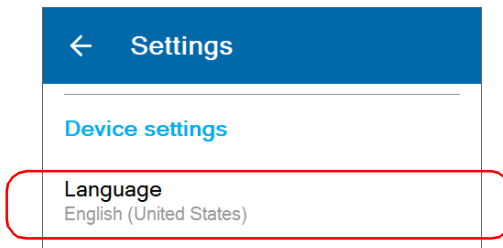

4. Select the desired language from the list.

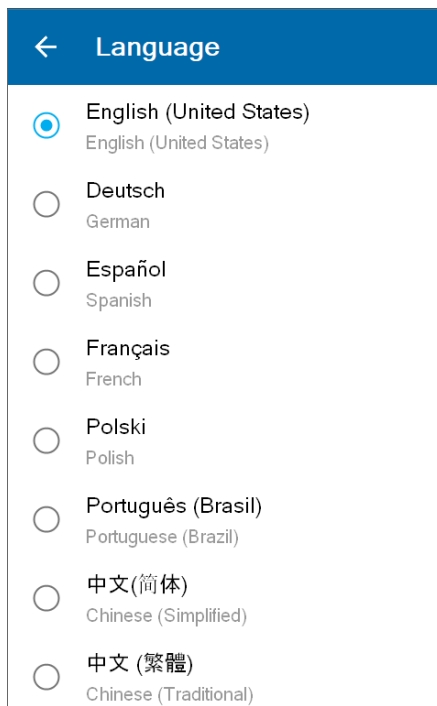

5. Your unit will need to restart to complete the change of language. When the unit prompts you, confirm with **OK**.

Adjusting the Date, Time and Time Zone

The time is displayed in the title bar. When saving results, the unit also saves the corresponding date and time.

By default, the time is expressed in a 24-hour format, but you can select a 12-hour format (AM/PM) if you prefer.

Note: *You cannot modify the format in which the date is displayed.*

You can set the date and time manually or let the unit synchronize them automatically with the TestFlow/Exchange mobile application if your unit has wireless capabilities.

If you use your unit in conjunction with a smart device, each time a connection is established between the two, by default, the date, time and time zone of the unit are synchronized with those of the smart device. You can disable the automatic synchronization if you prefer.

Setting up Your Unit

Adjusting the Date, Time and Time Zone

To modify the date format:

1. From the main menu, tap **Settings**.

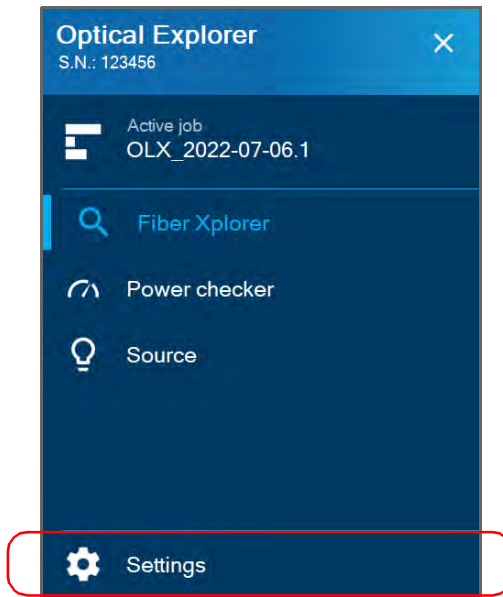

2. Scroll down to the **Device settings** section.
3. Tap **Date and time**.

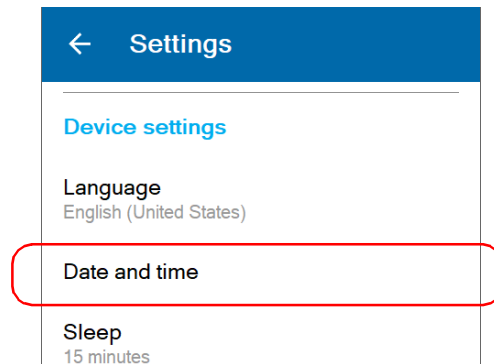

4. With the **Use 24-hour format** toggle, enable or disable the option, depending on your preference. If you prefer to view the time in a 12-hour (AM/PM) format, ensure that the **Use 24-hour format** option is disabled.

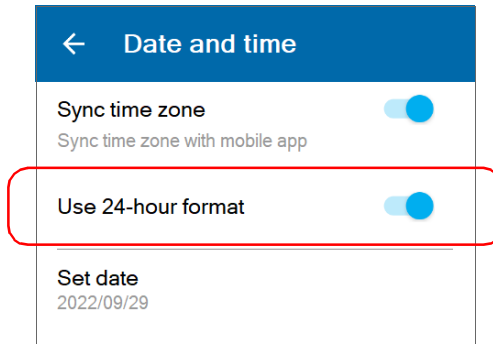

The new time format is taken into account immediately.

Setting up Your Unit

Adjusting the Date, Time and Time Zone

To enable or disable the synchronization of date, time and time zone with the TestFlow/Exchange mobile application (units with wireless capabilities):

1. From the main menu, tap **Settings**.

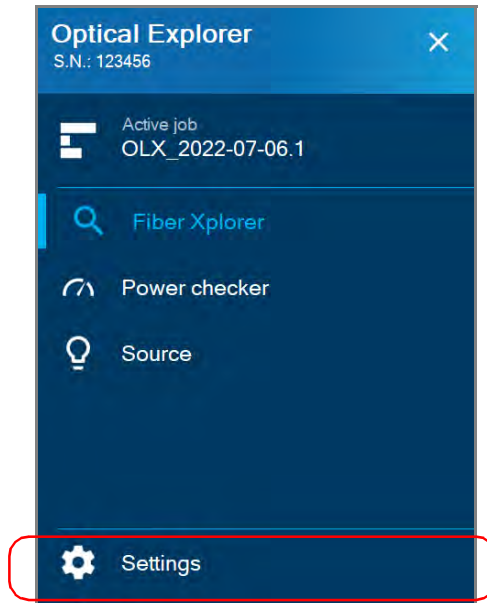

2. Scroll down to the **Device settings** section.
3. Tap **Date and time**.

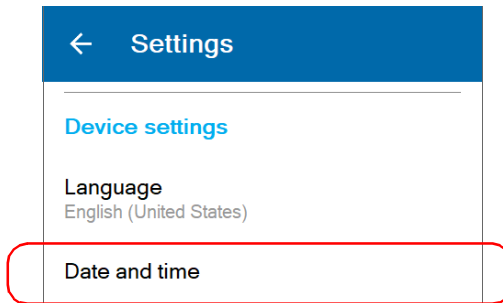

4. With the **Sync time zone** toggle, enable or disable the synchronization of date and time with the TestFlow/Exchange mobile application.

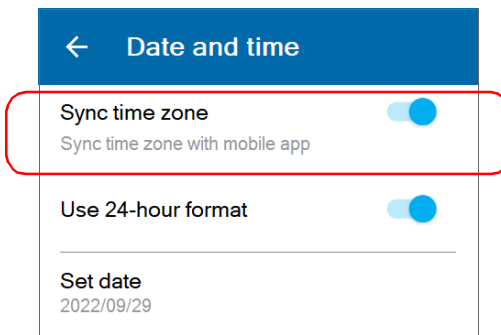

To adjust the date, time or time zone manually:

1. From the main menu, tap **Settings**.

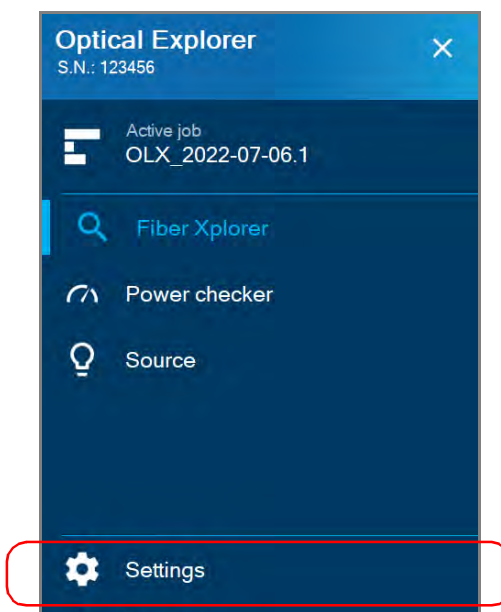

Setting up Your Unit

Adjusting the Date, Time and Time Zone

2. Scroll down to the **Device settings** section.
3. Tap **Date and time**.

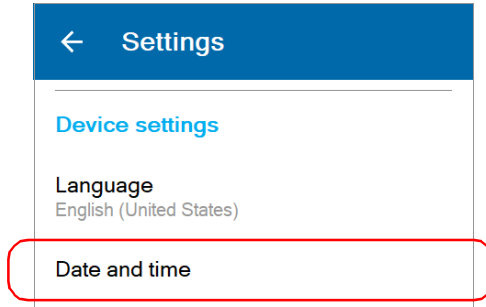

4. Tap the element corresponding to the value that you want to modify.

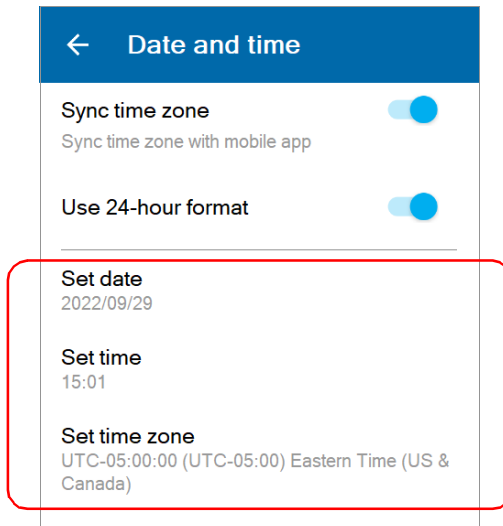

5. Modify the settings according to your needs, and then tap **OK** to confirm, when applicable.

The new values are taken into account immediately.

Selecting the Distance Units

You can select the measurement units that your unit will use to display distance and length values.

By default, the unit uses metric distance units (meters and kilometers), but you can change for imperial units (feet and kilofeet) if you prefer.

Note: *Values of less than 1 kilometer or 1 kilofeet will be expressed, respectively, in meters or feet for more precision.*

Note: *The measurement units used on your OX1 are independent from those used in cloud-based jobs. This means that you may have to make changes to ensure consistency in the selected measurement units.*

The value that you set is kept in memory even when you turn the unit off.

Setting up Your Unit

Selecting the Distance Units

To select the distance units:

1. From the main menu, tap **Settings**.

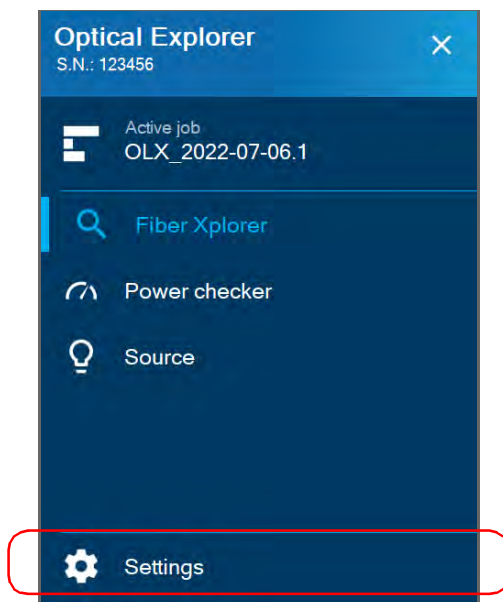

2. Scroll down to the **Device settings** section.

3. Tap Distance units.

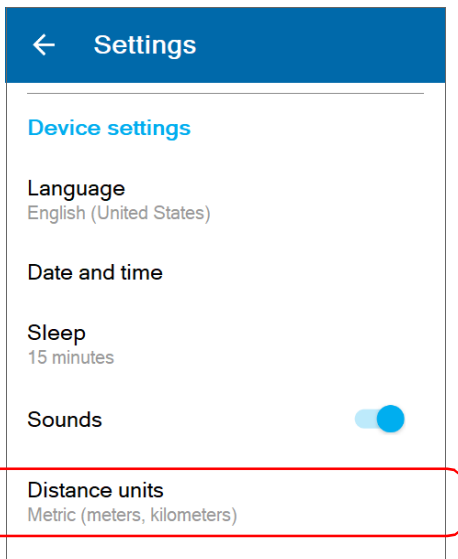

4. Select the desired distance units.

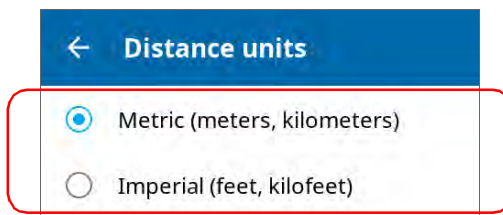

The new value is taken into account immediately.

Configuring Sleep Mode

To help you get the optimum performance out of your unit, it comes with a predefined set of parameters to manage power.

When you do not use your unit for a while, it will go into sleep mode automatically to save power (see *Turning off Your Unit* on page 22).

Note: *Any data transfer that was underway will continue normally unless the battery level becomes too low. In the event of a low battery, there would be no data loss as no data is erased from your unit until the transfer of all data is complete (to the TestFlow/Exchange mobile application or to the cloud server if your unit has wireless capabilities).*

By default, the duration after which the unit goes into sleep mode is fifteen minutes, but you can select another value.

The value that you set is kept in memory even when you turn the unit off.



IMPORTANT

- ▶ If you intend to leave your unit in sleep mode for more than a few hours, you should turn it off (shutdown) to save battery power. After four hours in sleep mode, your unit will go into shutdown mode automatically to save battery power.
- ▶ The unit will not enter sleep mode while you perform tests or use tools such as the source or the power checker.
- ▶ To avoid a possible battery drainage, do not forget to stop the source manually if you have deactivated its timer. Also, do not forget to close the power checker page when you have finished your work.
- ▶ If you have set a timer for the source, the unit will start calculating the idle time after the timer has reached zero. For more information about the source timer, see *Using the Light Source* on page 151.

To configure the duration after which the unit enters sleep mode:

1. From the main menu, tap **Settings**.

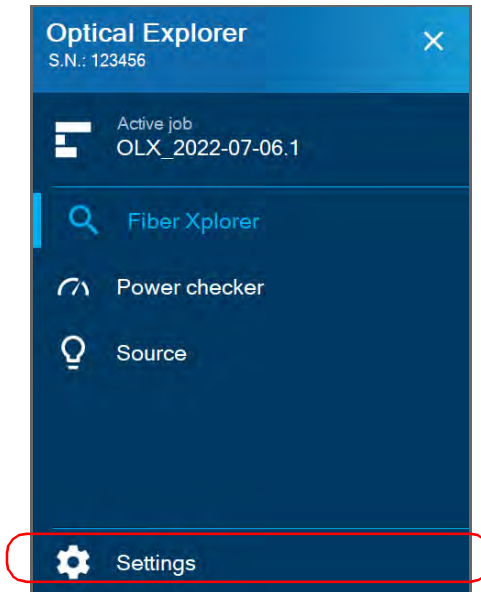

2. Scroll down to the **Device settings** section.
3. Tap **Sleep**.

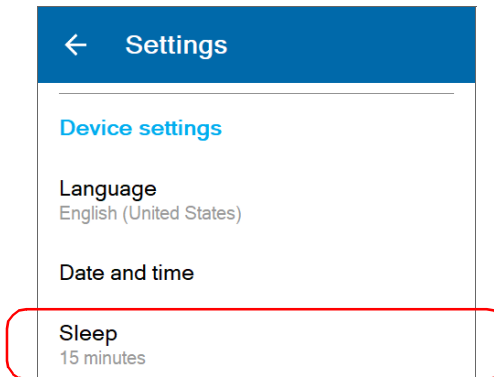

Setting up Your Unit

Selecting Test Wavelengths

4. Select the desired number of minutes.

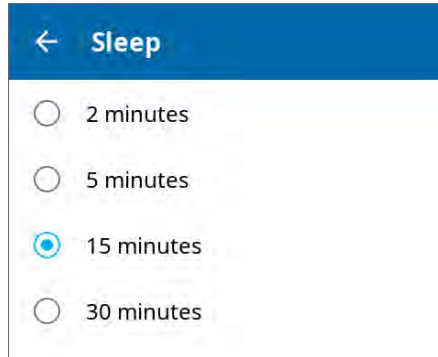

The new value is taken into account immediately.

Selecting Test Wavelengths

You can select the wavelengths you want to use for your measurements or let the unit select the most appropriate wavelengths. The manual or automatic selection of the wavelengths is kept in memory when you turn off the device as well as the wavelengths you have chosen. By default, the automatic option is deactivated.

Note: *The automatic wavelength selection is not possible on units with only one wavelength available.*

Note: *When you use the automatic wavelength selection on a unit with both filtered and non-filtered ports, the unit selects the filtered port by default if the OX1 detects a live fiber.*

You can make your selection in the Settings page or directly in Fiber Xplorer.

To select test wavelengths from the Settings page:

1. From the main menu, tap **Settings**.

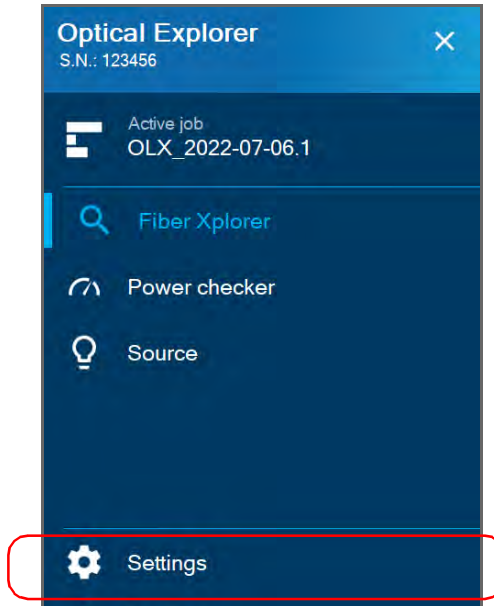

Setting up Your Unit

Selecting Test Wavelengths

2. Under **Optical Explorer**, tap **Wavelengths**.

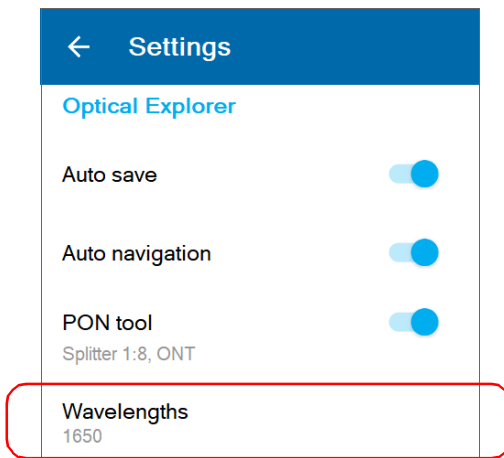

3. If you want to let the unit select the most appropriate wavelengths, use the **Auto** toggle to enable the option.

OR

If you prefer to choose the wavelengths yourself, ensure that the **Auto** option is deactivated (use the toggle if necessary), and then select the wavelengths you want to use for your tests.

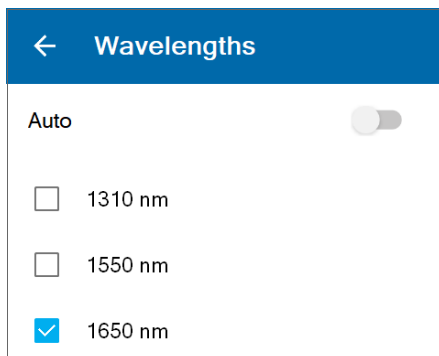

The new selection will be taken into account for the next measurement.

To select test wavelengths from Fiber Xplorer:

1. From Fiber Xplorer, tap the arrow to access the drawer.

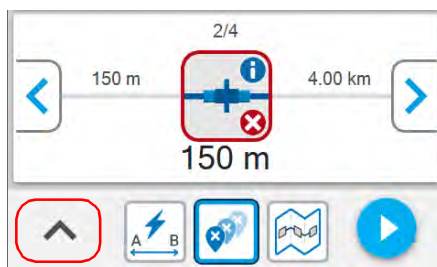

2. Tap **Wavelengths**.

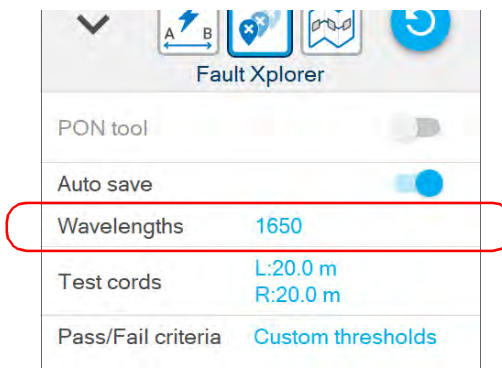

Setting up Your Unit

Selecting Test Wavelengths

3. If you want to let the application select the most appropriate wavelengths, use the **Auto** toggle to enable the option.

OR

If you prefer to choose the wavelengths yourself, ensure that the **Auto** option is deactivated (use the toggle if necessary), and then select the wavelengths you want to use for your tests.

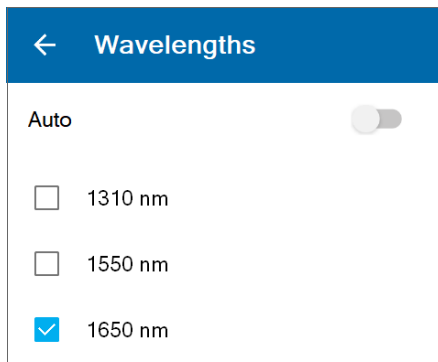

The new selection will be taken into account for the next measurement.

Enabling or Disabling Power Measurements

You can include the optical power of a link in the measurements that you perform with the OX1.

When you enable this feature (disabled by default), you need to choose a wavelength at which the OX1 will calculate the power of a link.

If you are working with a dual-channel unit, you must select a pair of wavelengths, or let the unit automatically interpret the received signal(s) and suggest which PON-type channel(s) could be present on your network. The dual-channel unit supports the following wavelengths related to PON networks:

- 1490 nm – GPON
- 1550 nm – RF Video
- 1577 nm – XGS-PON

If you select a pair of wavelengths, the unit will take two downstream measurements simultaneously on your link.

If you select the automatic detection, your unit will take one or two downstream measurements simultaneously on your link, depending on your PON network configuration. In all cases, with the automatic detection, your unit will identify the type of network and the corresponding wavelength at which the power of the link is calculated (ex.: GPON - 1490 nm). By default, the network type is set to GPON if the unit cannot identify your specific network type.

Note: *Should the unit receive atypical signals, the suggested types of channels could differ from your actual network configuration. In this case, you could simply manually select the pair of wavelengths corresponding to your testing needs.*

Setting up Your Unit

Enabling or Disabling Power Measurements

The value is displayed in the Fiber Explorer page as soon as you start an acquisition.

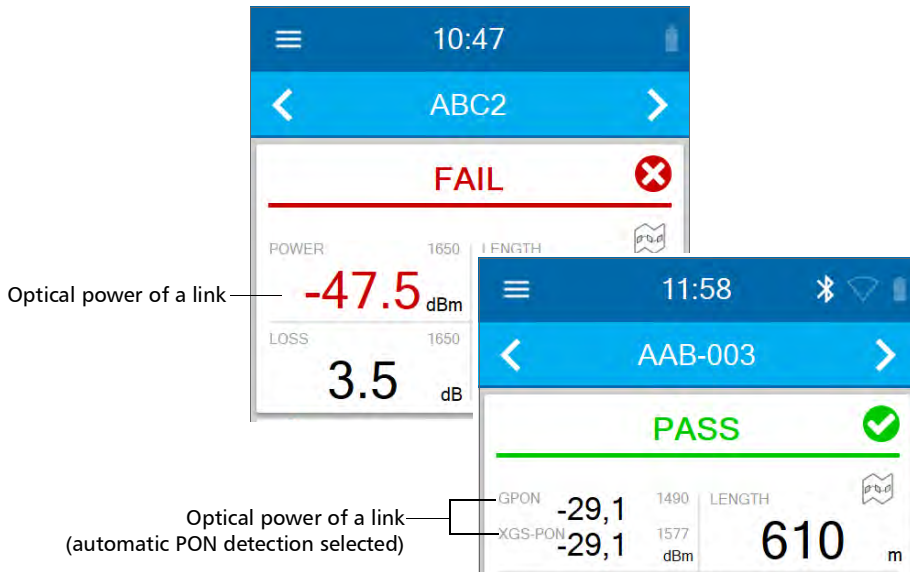

Once the measurement is complete, the power value is also displayed in the Link details page. See *Working With Link Results* on page 133 for details.

The OX1 includes the pass/fail status of the power measurement in the status of the global acquisition.

To enable or disable power measurements:

1. From the main menu, tap **Settings**.

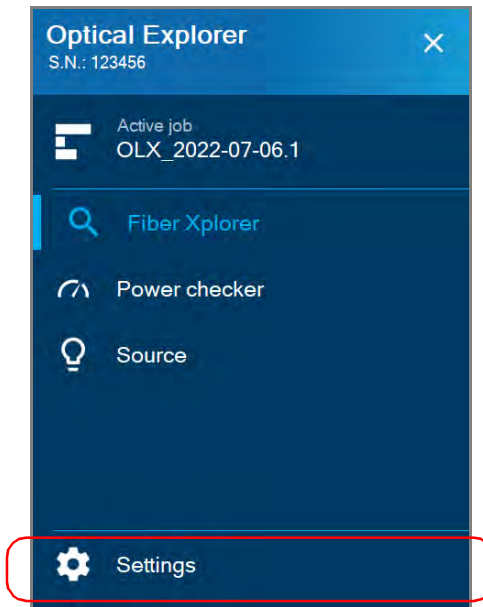

Setting up Your Unit

Enabling or Disabling Power Measurements

2. Under **Optical Explorer**, activate the feature with the toggle button, and then tap **Power measurement** to display the wavelengths available.

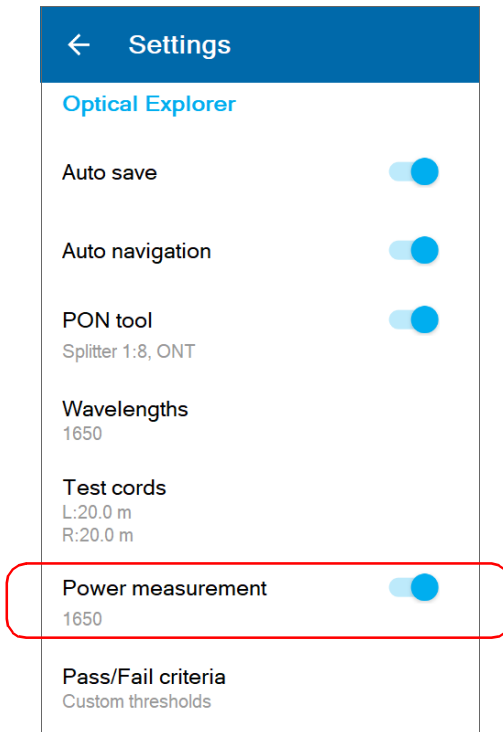

- 3.** In the **Power measurement** page, select the desired wavelength. If you are working with a dual-channel unit, you must also select a pair of wavelengths. If you prefer to let the unit interpret the received signals (power) for your network automatically, select **Detect PON**.

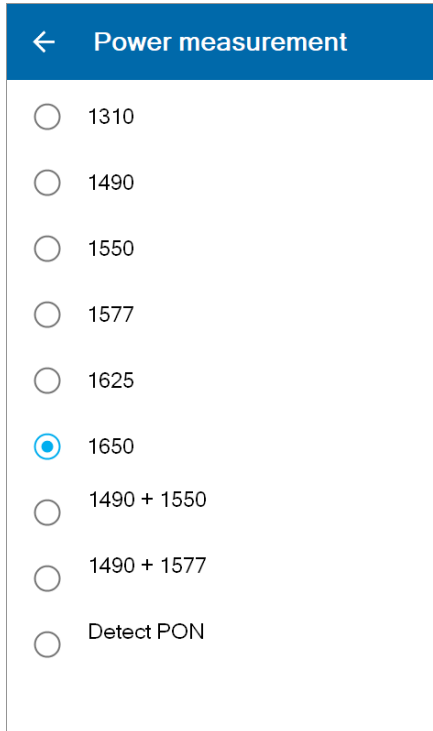

The screenshot shows a mobile application interface for selecting power measurement parameters. At the top, there is a blue header bar with a white left-pointing arrow and the text "Power measurement". Below the header, a list of radio button options is displayed. The options are: 1310, 1490, 1550, 1577, 1625, 1650, 1490 + 1550, 1490 + 1577, and Detect PON. The "1650" option is selected, indicated by a blue dot in the center of its radio button.

Option	Selected
1310	No
1490	No
1550	No
1577	No
1625	No
1650	Yes
1490 + 1550	No
1490 + 1577	No
Detect PON	No

Setting up Your Unit

Enabling or Disabling Auto Save

Enabling or Disabling Auto Save

When performing measurements in Fiber Xplorer, you can define the unit's behavior after the measurement process is complete. You can enable the automatic saving of each measurement or you can disable the automatic saving and just save the measurements that you wish to keep by using the quick save feature.

Enabling or disabling the auto save feature applies to both local and cloud-based jobs. By default, the auto save feature is enabled. Your preference is kept in memory when you turn the unit off.

The auto save feature can be enabled or disabled from both the Settings menu and from Fiber Xplorer.

To enable or disable auto save from the Settings menu:

1. From the main menu, tap **Settings**.

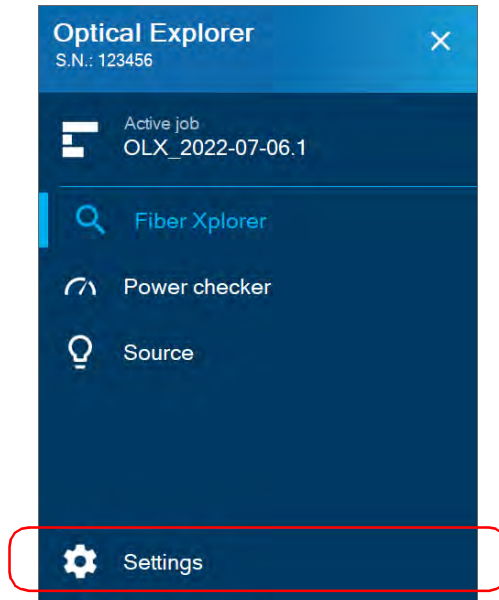

2. Scroll down to the **Optical Explorer** section.

3. Enable or disable the auto save with the corresponding toggle.

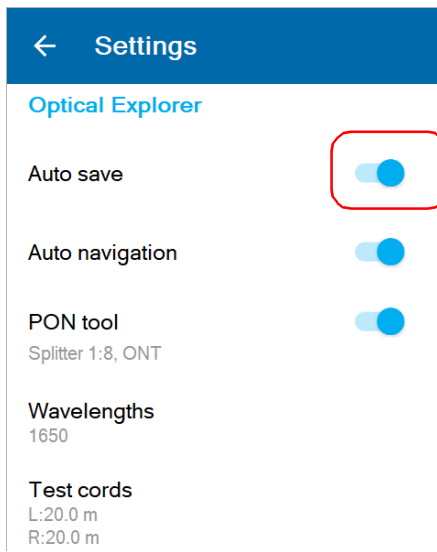

The new selection will be taken into account for the next measurement.

To enable or disable auto save from Fiber Xplorer:

1. From Fiber Xplorer, tap the arrow to access the drawer.

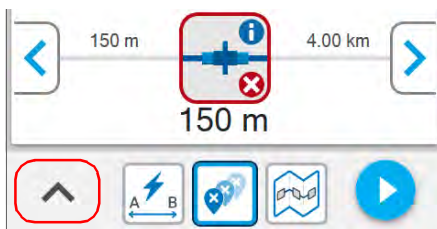

Setting up Your Unit

Enabling or Disabling Auto Navigation

2. Enable or disable the auto save with the corresponding toggle.

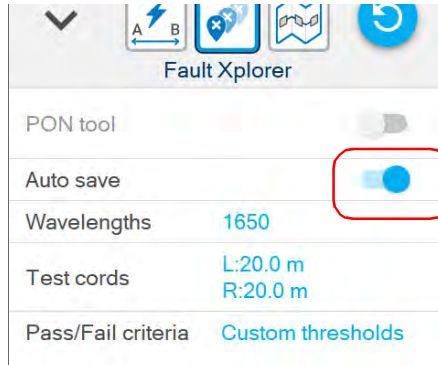

The new selection will be taken into account for the next measurement.

Enabling or Disabling Auto Navigation

You may want to enable or disable the auto navigation feature on your unit according to your preferences when taking measurements. Enabling or disabling the auto navigation feature applies to both local and cloud-based jobs.

You can enable the automatic navigation to the next available test point or have your unit remain on the same test point once the measurement process is complete.

By default, the auto navigation feature is disabled. Your preference is kept in memory when you turn the unit off.

To enable or disable auto navigation:

1. From the main menu, tap **Settings**.

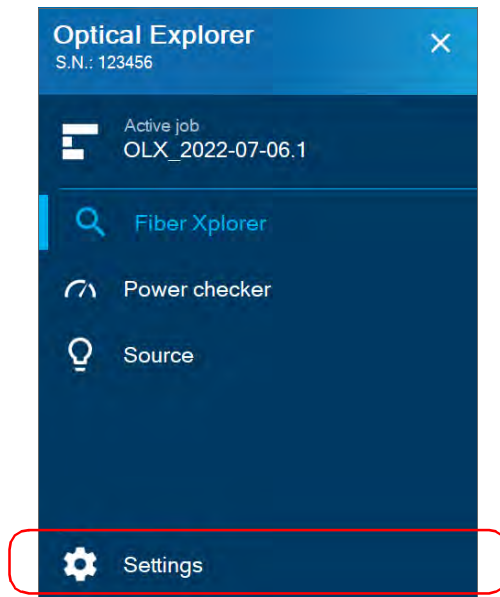

2. Scroll down to the **Optical Explorer** section.
3. Enable or disable the auto navigation with the corresponding toggle.

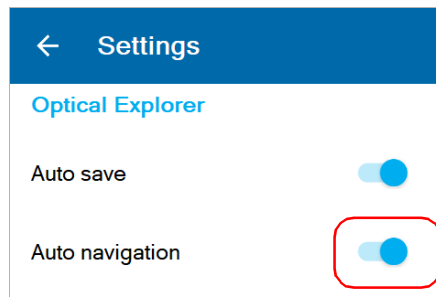

The new selection will be taken into account for the next measurement.

Setting up Your Unit

Working With Custom Pass/Fail Thresholds or EXFO Advisor

Working With Custom Pass/Fail Thresholds or EXFO Advisor

As soon as a measurement is complete, the application displays a status:

- Pass
- Fail
- Unknown
- Quality star rating

The application displays a Pass/Fail status when custom thresholds are applied. It is displayed in the Link Results area and it can be pass, fail, or unknown. See *Working With Link Results* on page 133 for details.

You can also let EXFO Advisor rate the quality of the results. The rating ranges from zero to five stars (half stars are possible).

Note: *EXFO Advisor is always applied when working with Flash Advisor.*

By default, the link thresholds (loss, length, ORL) are disabled. You can enable and customize them when you use Fault Xplorer or Link Mapper. You can also customize thresholds related to the elements (connector loss and reflectance, splice loss). The threshold values, for both the link and elements, are applied automatically to all wavelengths and are kept in memory when you turn off the unit.

To configure custom thresholds or select EXFO Advisor from the Settings page:

1. From the main menu, tap **Settings**.

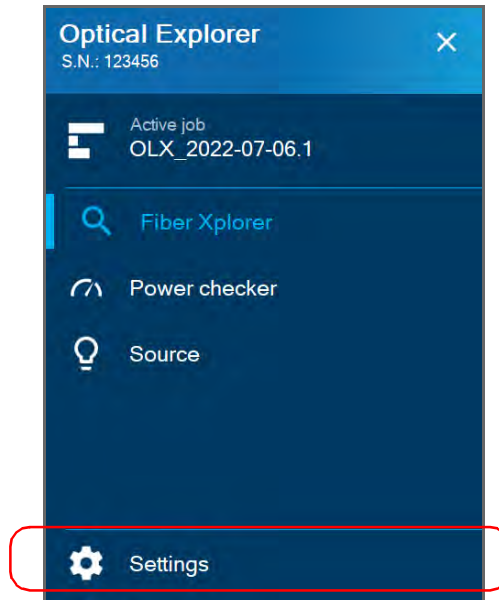

Setting up Your Unit

Working With Custom Pass/Fail Thresholds or EXFO Advisor

2. Under **Optical Explorer**, tap **Pass/Fail criteria**.

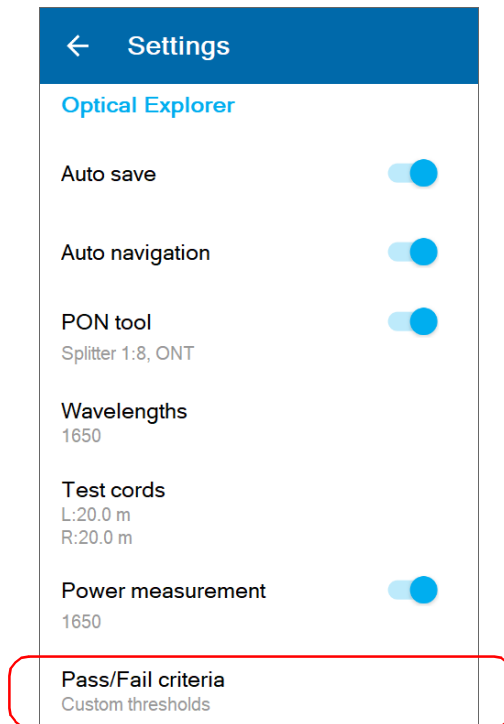

3. If you want to let the application rate the quality of the results, select **EXFO Advisor**.

OR

If you prefer to customize the values of the thresholds, select **Custom thresholds**.



4. To edit the threshold values, proceed as follows:
 - 4a. If necessary, activate the threshold with the toggle button.

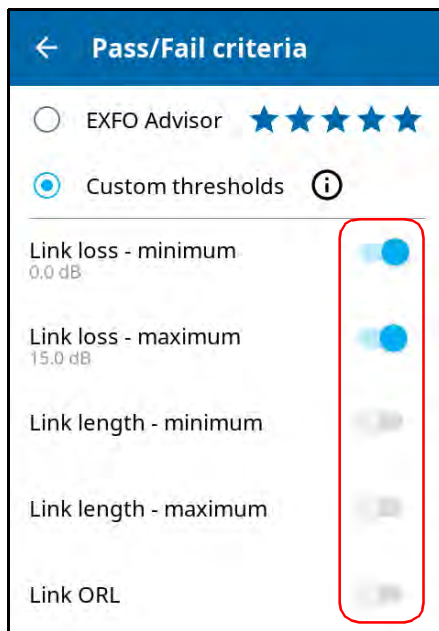

Setting up Your Unit

Working With Custom Pass/Fail Thresholds or EXFO Advisor

4b. Tap the threshold you want to modify.

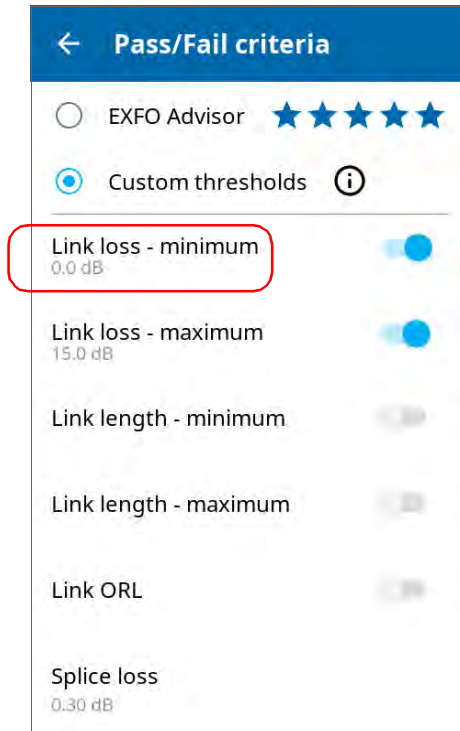

4c. Enter a new value.

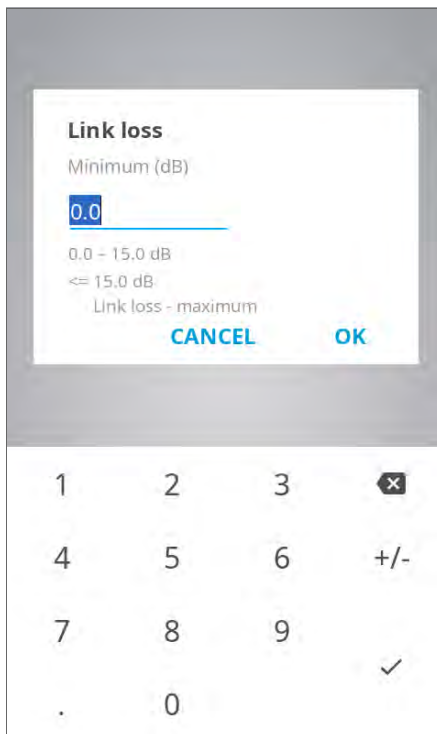

Link loss
Minimum (dB)

0.0 - 15.0 dB
<= 15.0 dB
Link loss - maximum
CANCEL **OK**

1 2 3 ✕
4 5 6 +/-
7 8 9 ✓
. 0

4d. Tap **OK** to return to the **Pass/Fail criteria** page.

The new thresholds are taken into account for the next measurement.

Setting up Your Unit

Working With Custom Pass/Fail Thresholds or EXFO Advisor

To configure custom thresholds or EXFO Advisor from Fiber Xplorer:

1. From Fiber Xplorer, tap the arrow to access the drawer.

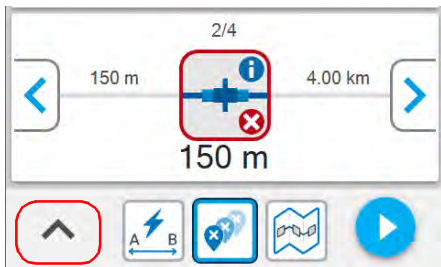

2. Tap **Pass/Fail criteria**.

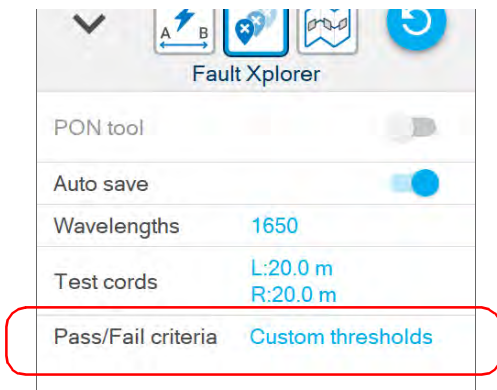

3. If you want to let the application rate the quality of the results, select **EXFO Advisor**.

OR

If you prefer to customize the values of the thresholds, select **Custom thresholds**.

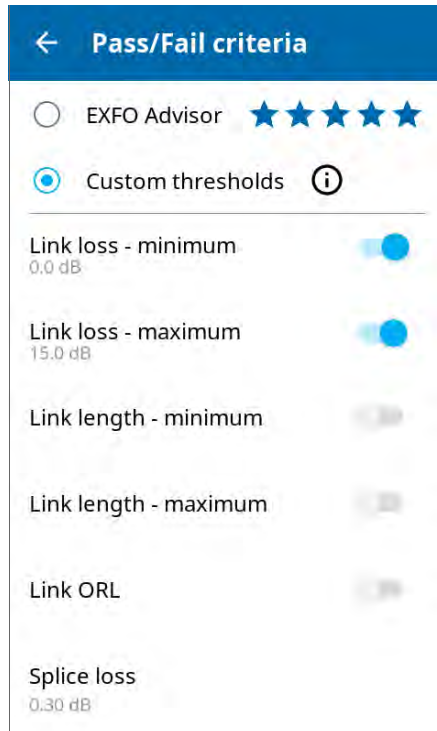

Setting up Your Unit

Working With Custom Pass/Fail Thresholds or EXFO Advisor

4. To edit the threshold values, proceed as follows:
 - 4a. If necessary, activate the threshold with the toggle button.

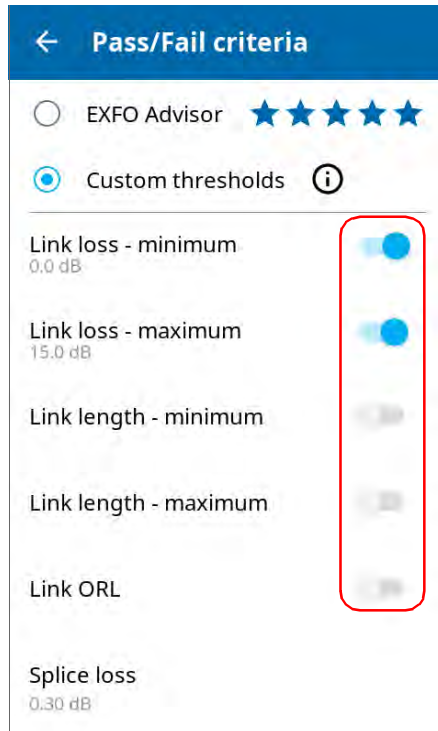

4b. Tap the threshold you want to modify.

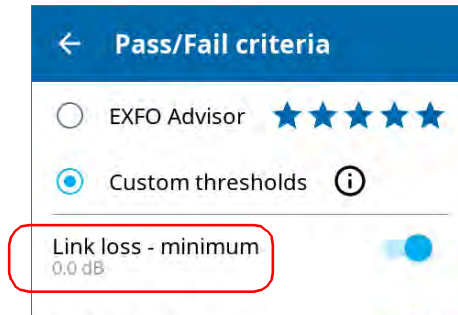

4c. Enter a new value.

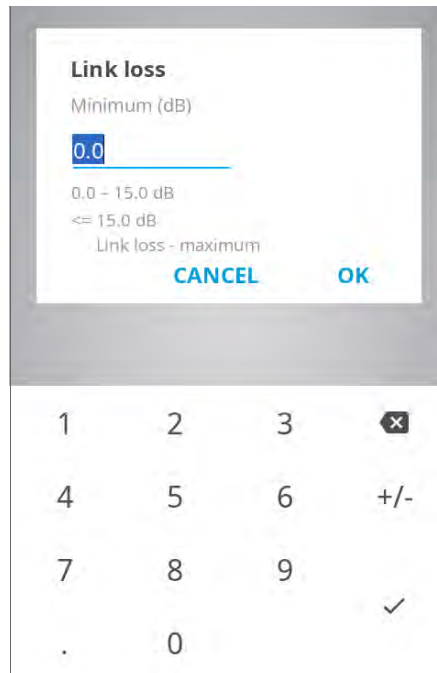

4d. Tap **OK** to return to the **Pass/Fail criteria** page.

Working With the PON Tool

The PON tool has been designed and optimized to work with specific use cases related to the FTTx architecture. With this tool, you can perform splitter detection tests (from the ONT to the splitter) and ONT detection tests (from the splitter to the ONT).

As it is a tool for specific cases, the PON tool is disabled by default. As soon as you enable it, both the splitter and ONT detection tests are enabled. You can disable either the splitter or the ONT detection test if desired. You can also configure your unit to show the PON tool in the drawer if desired.

Note: *You can use the PON tool with PRO models only.*

- The splitter detection test verifies if the subscriber is connected to the splitter by allowing the OX1 to distinguish a splitter from a fiber end or break. When no splitter is detected, the unit displays a splitter element with a fail status. The unit also provides you with a diagnosis giving additional information about the detected problems to assist you in troubleshooting.

The splitter detection test requires the selection of the appropriate splitter ratio configuration. In the case of cascaded splitters, you should always select the splitter ratio of the splitter which is closer to the location where you perform an acquisition. If the distance between both levels of splitters does not fit within the minimal length specifications, the splitter detection will fail.

- The ONT detection test helps you identify a bad connection to the ONT or a malfunction of the ONT, from outside the subscriber's premises. When no ONT is detected, the unit displays an ONT element with a fail status. The unit provides you with a diagnosis giving additional information about the detected problems or potential problems to assist you in troubleshooting.

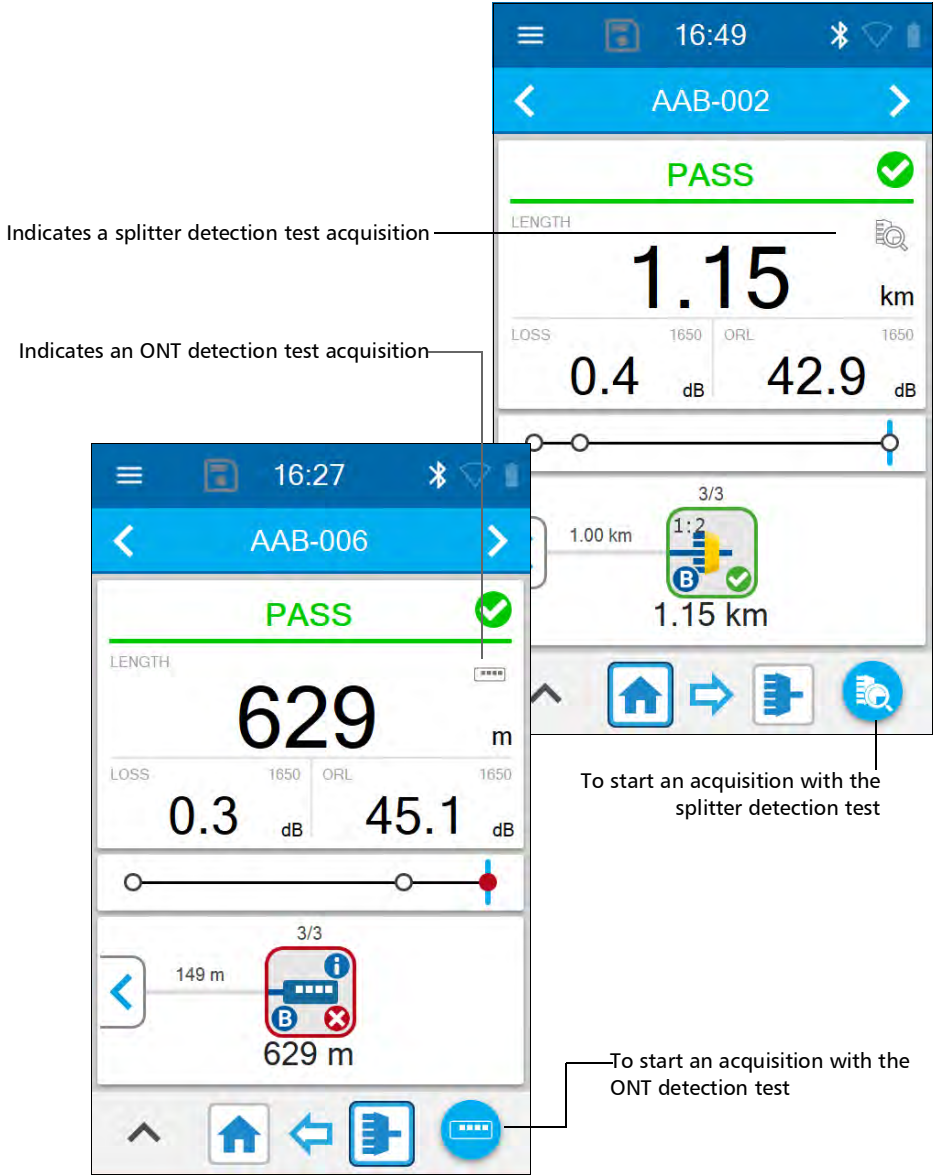

Setting up Your Unit

Working With the PON Tool

To configure the PON tool:

1. From the main menu, tap **Settings**.

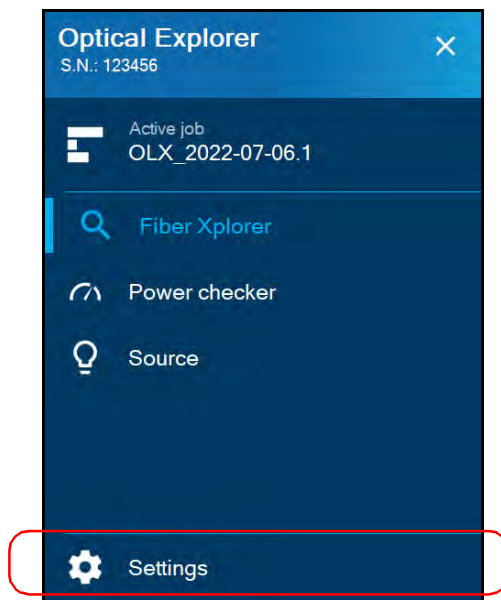

2. Under **Optical Explorer**, activate the feature with the toggle button and tap **PON tool**.

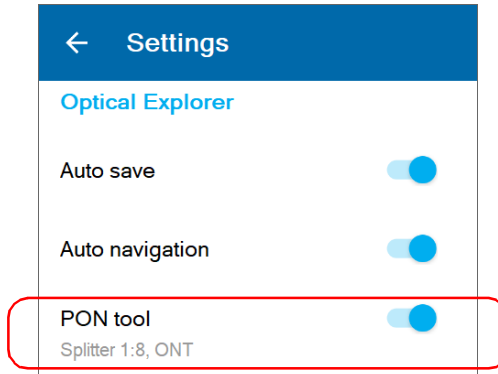

Note: *If you do not see **PON tool** in the settings, it means that your current OX1 unit is not a PRO model.*

3. Ensure that the test selection suits your needs. Use the toggle buttons to enable or disable a test.



Setting up Your Unit

Working With the PON Tool

4. If you intend to work with the splitter detection test, select the split ratio you want to use to test the link.

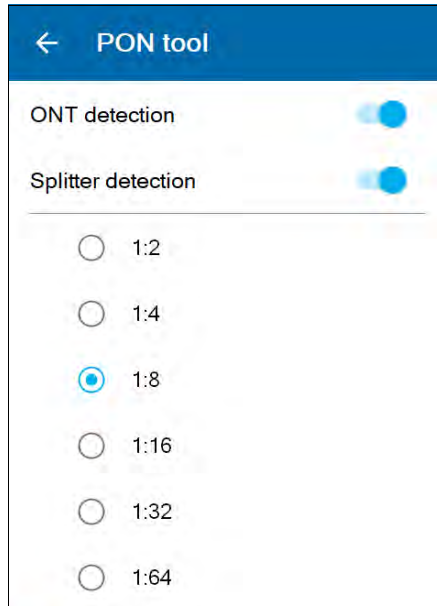

Note: *When working with cascaded splitters, you should always select the splitter ratio of the splitter which is closer to the location where you perform an acquisition. If the distance between both levels of splitters does not fit within the minimal length specifications, the splitter detection will fail.*

5. If you want to be able to access the PON tool settings directly from the drawer, select the **Show in drawer** check box.

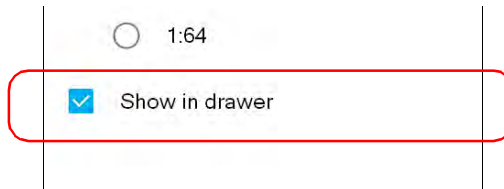

To configure the PON tool from Fiber Xplorer:

1. From Fiber Xplorer, tap the arrow to access the drawer.

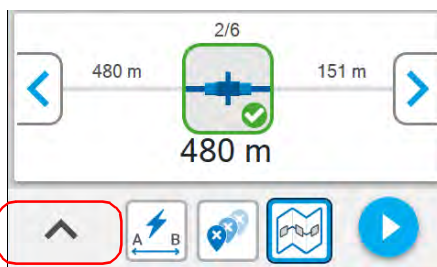

2. If necessary, activate the feature with the toggle button and tap **PON tool**.

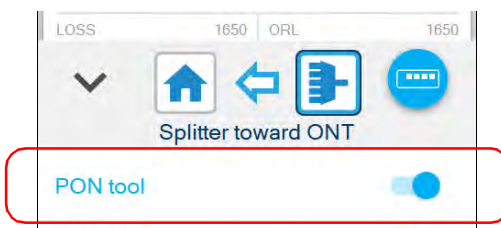

Note: If you do not see **PON tool** in the drawer, it probably means that its display has not been enabled from the **Settings** menu or that your current OX1 unit is not a PRO model.

3. Ensure that the test selection suits your needs. Use the toggle buttons to enable or disable a test.



Setting up Your Unit

Working With the PON Tool

4. If you intend to work with the splitter detection test, select the split ratio you want to use to test the link.

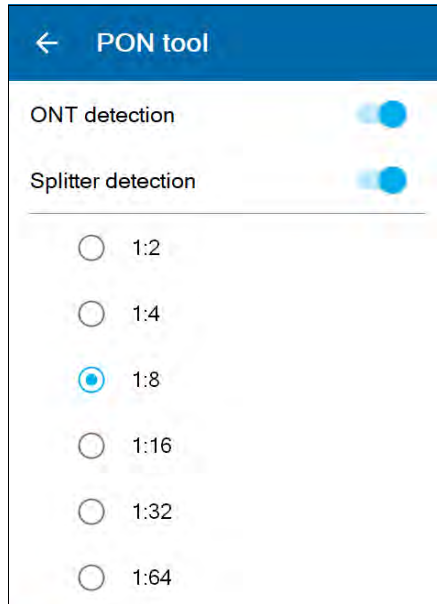

Note: *When working with cascaded splitters, you should always select the splitter ratio of the splitter which is closer to the location where you perform an acquisition. If the distance between both levels of splitters does not fit within the minimal length specifications, the splitter detection will fail.*

Working With a Demarcation Section

Note: *You can only use this feature with the Fault Xplorer and Link Mapper test functions.*

You can define a demarcation section when you need to validate the loss over a portion of the link.

You can configure related parameters such as the length and the loss thresholds.

You can also define the unit's behavior in case it detects the end of the link before the end of the demarcation section. By default, in this situation, the unit identifies the last event as a fiber break (Fail). However, you can modify this setting so that the last event is identified as the actual end of fiber instead (Pass). This could be particularly useful if you know, for example, that your link's end is located within the demarcation section.

Note: *The start of the demarcation section always corresponds to the testing point.*

Setting up Your Unit

Working With a Demarcation Section

To set the demarcation section thresholds from the Settings page:

1. From the main menu, tap **Settings**.

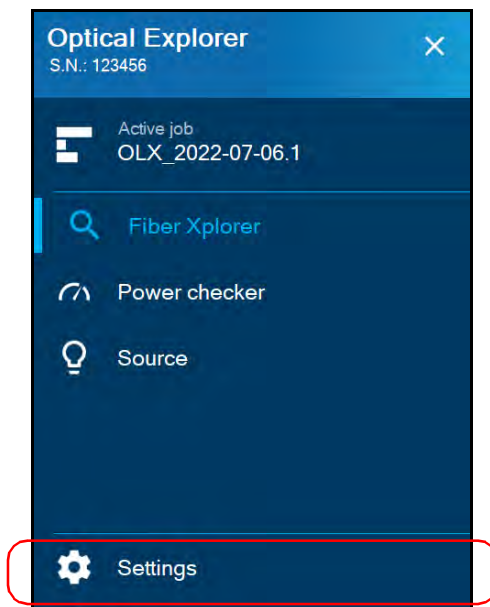

2. Under **Optical Explorer**, tap **Pass/Fail criteria**.

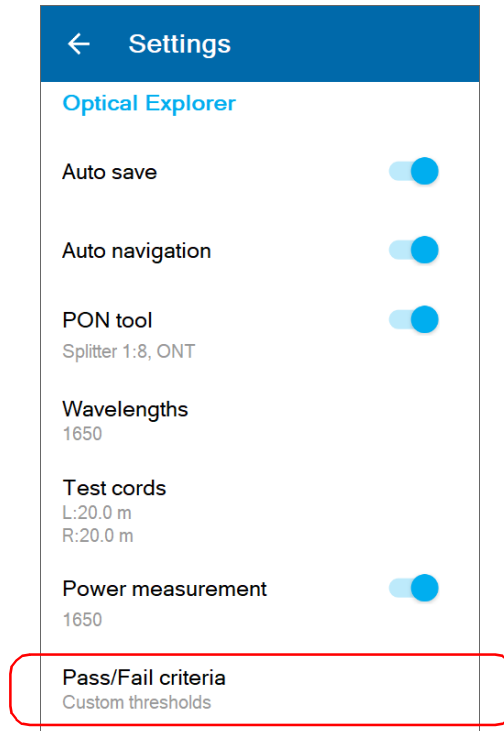

3. Ensure that **Custom thresholds** is selected.



Setting up Your Unit

Working With a Demarcation Section

4. If necessary, activate the threshold group with the toggle button and tap **Demarcation section** to modify the parameters.

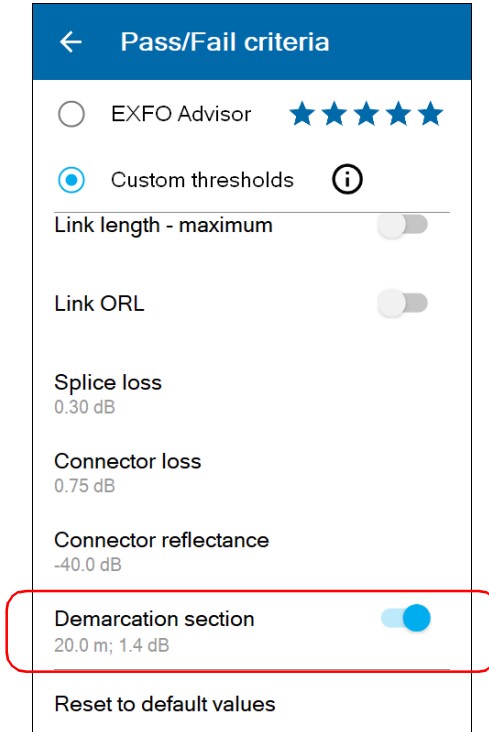

5. Modify the thresholds as follows:

5a. Tap the threshold that you want to modify.

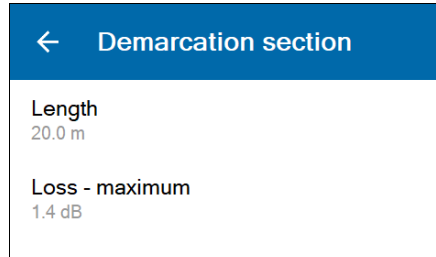

5b. Enter a new value.

5c. Tap **OK** to return to the **Demarcation section** page.

6. Use the **Allow link < demarcation** toggle button to define the behavior of the unit when it detects the end of the link before the end of the demarcation.

- To have the last event identified as the actual end of fiber (Pass), enable the feature.
- To have the last event identified as a fiber break (Fail), disable the feature.

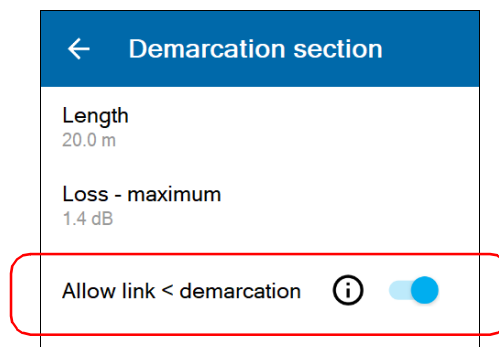

The new settings will be taken into account for the next measurement.

Setting up Your Unit

Working With a Demarcation Section

To set the demarcation section thresholds from Fiber Xplorer:

1. From Fiber Xplorer, tap the arrow to access the drawer.

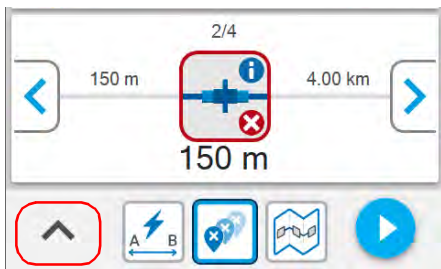

2. Tap **Pass/Fail criteria**.

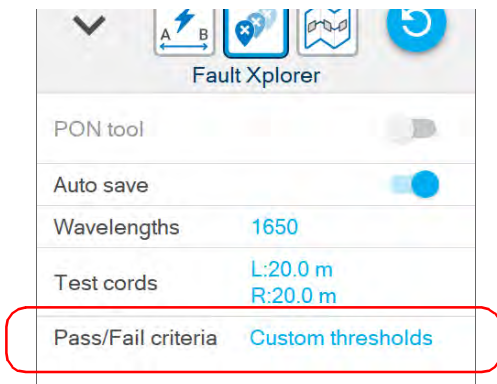

3. Ensure that **Custom thresholds** is selected.



4. To edit the demarcation section, proceed as follows:
 - 4a. If necessary, activate the threshold with the toggle button and tap **Demarcation section** to modify different parameters.

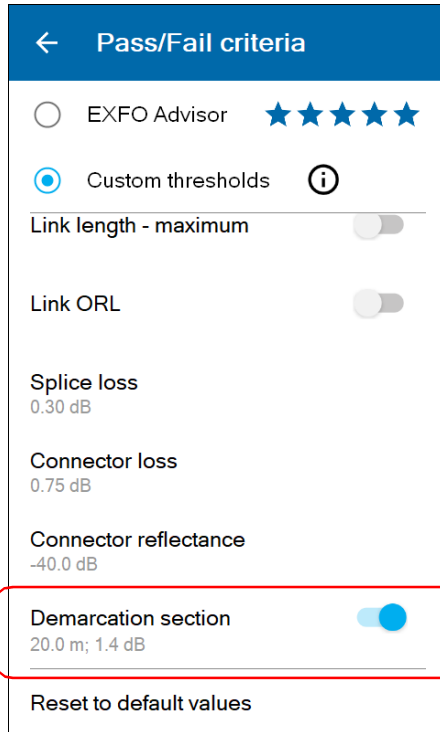

Setting up Your Unit

Working With a Demarcation Section

4b. Tap the threshold that you want to modify.

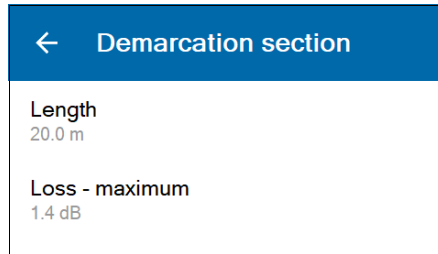

4c. Enter a new value.

4d. Tap **OK** to return to the **Demarcation section** page.

5. Use the **Allow link < demarcation** toggle button to define the behavior of the unit when it detects the end of the link before the end of the demarcation.

- To have the last event identified as the actual end of fiber (Pass), enable the feature.
- To have the last event identified as a fiber break (Fail), disable the feature.

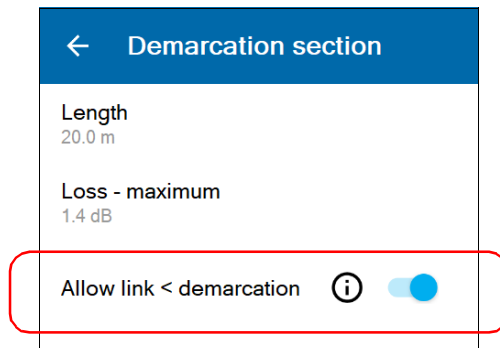

The new thresholds will be taken into account for the next measurement.

Configuring the IOR Value

Having the proper index of refraction (IOR) is crucial for all measurements associated with distance (element position, total length, etc.). By doing so, you ensure that the distances are more accurate for your measurements.

You can edit the IOR value associated with the 1550 nm wavelength only. The unit automatically finds the corresponding IOR value for other wavelengths.

IOR is provided by the cable or fiber manufacturer.

To configure the IOR value:

1. From the main menu, tap **Settings**.

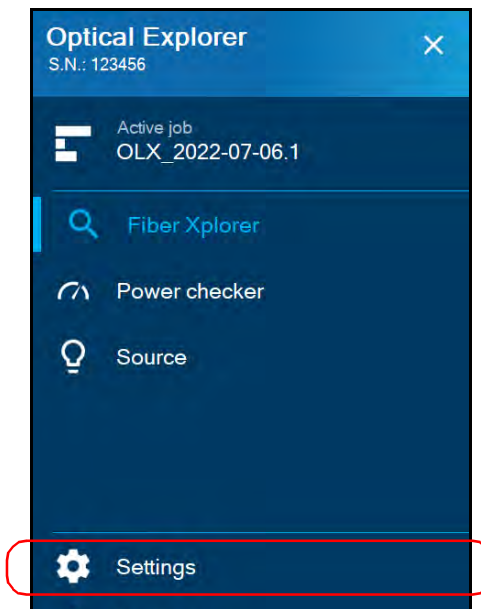

Setting up Your Unit

Configuring the IOR Value

2. Under **Optical Explorer**, tap **IOR (@1550 nm)**.

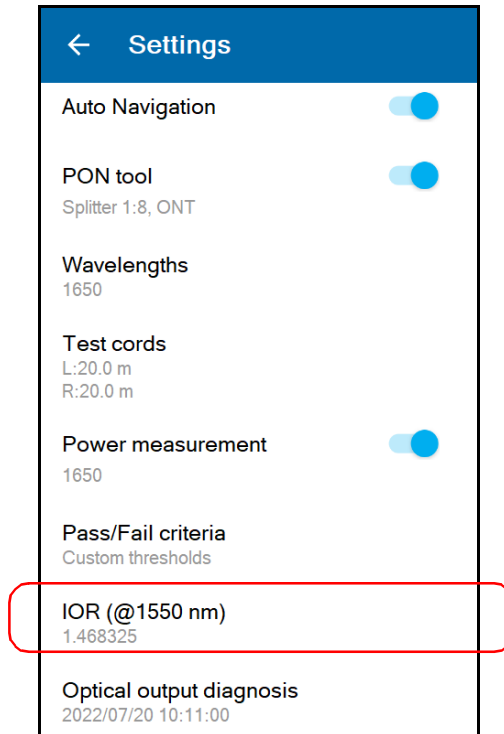

3. Enter the new value.

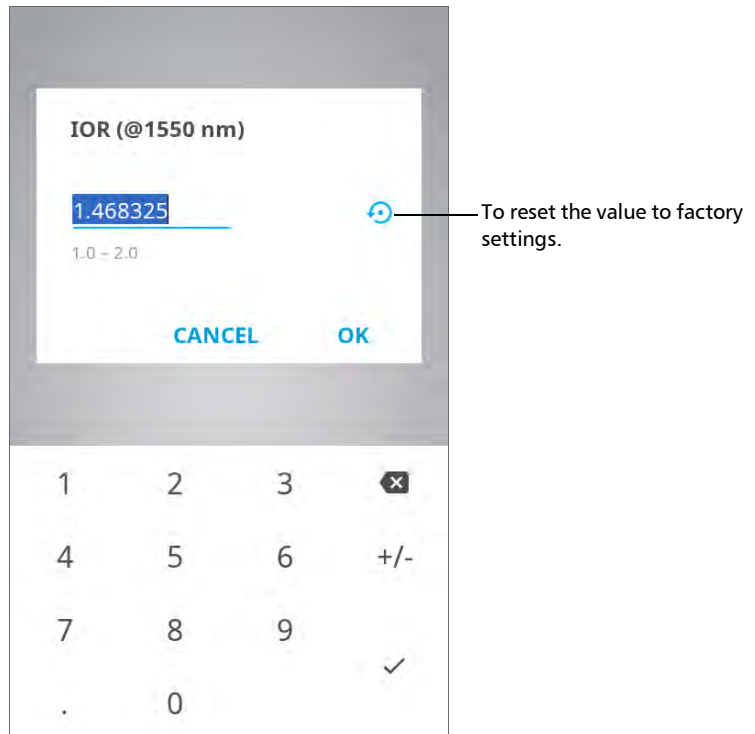

4. Tap **OK** to confirm the new value and return to the **Settings** page.
The new value will be taken into account for the next measurement.

Setting up Your Unit

Reverting to Factory Settings

Reverting to Factory Settings

At any time, you can use one of these options, according to your needs:

- reset all settings of the unit that you have customized, such as the thresholds, to their default values
- reset the OX1 to factory settings (all customized settings and erase all measurements)
- reset the battery indicator information once you have replaced the battery (see *Replacing the Battery* on page 220 for details)

To revert values to factory settings:

1. From the main menu, tap **Settings**.

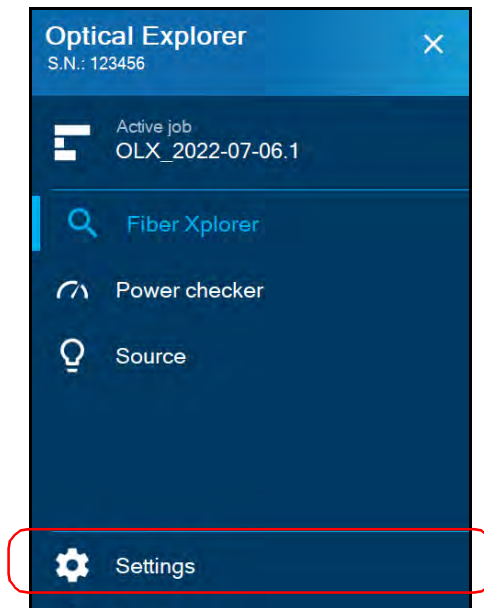

2. Scroll down to the **Device settings** section.
3. Tap **Reset options**.

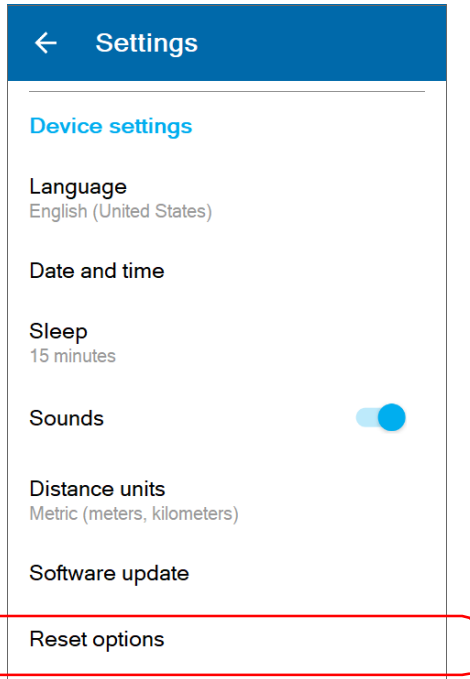

4. Select the desired option.

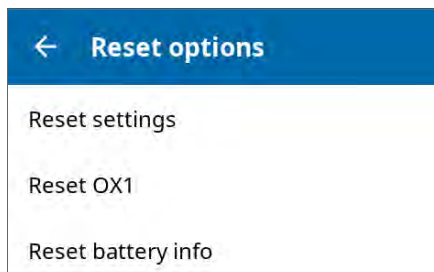

5. Tap **OK** to confirm your choice.

5 *Working With Jobs*

Every measurement you take with your unit is part of a local job or a cloud-based job for units with wireless capabilities. You can work with local jobs that you create directly on your unit or with cloud-based jobs that have already been created and assigned to you. You can change the active job, create and edit jobs directly on your unit.

When working with jobs, you can perform certain tasks such as:

- Select/change the active job
- Create/delete local jobs
- Create/delete test points for local jobs
- View the synchronization status of cloud jobs
- View properties for jobs and test points
- View the job creation date
- View the total number of measurements saved
- View the pass/fail status or EXFO Advisor verdict, if any, for each test point
- View the date/time of the latest measurement, if any, for each test point

Working With Jobs

Understanding the My Jobs Page

Understanding the My Jobs Page

- From the **My jobs** page, you can see the complete list of jobs that you have created and saved on your unit or that have been already created and assigned to you.
- You can create and delete local jobs. For more information, see *Creating Local Jobs* on page 110 and *Deleting Local Jobs* on page 117.
- You can see the current synchronization status with the cloud for each job.
- You can select a new active job from this page.
- You can delete cloud-based jobs from the unit.

The screenshot shows a mobile application interface titled "My jobs". It features a list of four job entries, each with a radio button for selection, a job name, a creation date and time, and the number of test points completed out of a total. The third job, "OLX_2022-07-06.1", is selected. At the bottom, there are "Delete" and "Create" buttons.

Job Name	Creation Date/Time	Test Points (Completed/Total)	Status
OLX-Job1	2022/07/20, 15:02:16	(2/15 results)	Not Active
OLX_2022-07-12.1	2022/07/12, 12:54:23	(2/14 results)	Not Active
OLX_2022-07-06.1	2022/07/06, 13:32:30	(10/41 results)	Active
Job-ABC	2022/07/04, 09:49:29	(1/31 result)	Not Active

Annotations in the image:

- "To select the active job" points to the radio button of the first job.
- "Job creation date" points to the date and time of the second job.
- "Number of test points completed/total number of test points" points to the "(10/41 results)" of the third job.
- "Job synchronization status" points to the radio button of the fourth job.
- "To delete a job" points to the "Delete" button.
- "To create a new job" points to the "Create" button.
- "Job name" points to the name "OLX_2022-07-12.1" of the second job.
- "To view the test points for the job" points to the right arrow of the third job.

Understanding the Test Points Page

Every job includes at least one test point. You can add and delete test points for local jobs. For more information, see *Adding Test Points to a Local Job* on page 120 and *Deleting Test Points From a Local Job* on page 123.

For local jobs, your unit can generate a list of test points based on the information you provide. For more information, see *Generating Valid Test Point Identifiers* on page 104.

The screenshot displays the 'Test points' section of the 'OLX_2022-07-06.1' job. The interface includes a header with a back arrow and the job name, and a tabbed view with 'Test points' selected. The test points list is as follows:

Test point identifier	Test verdict	Date/time of the latest measurement for the test point
A1	Failed (Red X)	2022/07/15, 16:19:17
A2	Failed (Red X)	2022/07/15, 16:23:19
A3	Passed (Blue Star)	2022/07/15, 16:12:58
A4	Failed (Red X)	2022/07/15, 16:14:18
A5	Passed (Blue Star)	2022/07/15, 16:15:01
A6	Failed (Red X)	2022/07/15, 16:41:18
AAA-01	Passed (Blue Star)	2022/07/15, 16:08:49
AAA-02	Unknown (Grey Circle)	---
AAA-03	Unknown (Grey Circle)	---

At the bottom of the screen, there are two buttons: 'Delete' and 'Add'. The 'Delete' button is used to remove a test point, and the 'Add' button is used to add a new test point to the job.

Note: When you select a test point from a job that is not the active job, the active job changes to the job the test point belongs to.

Generating Valid Test Point Identifiers

All test points must be part of a job. For more information on creating a local job, see *Creating Local Jobs* on page 110. You can create a list of test point identifiers by providing the first and last identifiers. Your unit then automatically and sequentially generates all test point identifiers between the values you provide for the first and last identifiers.

For your unit to create a valid list of sequential test point identifiers, you must provide a first and last identifier according to the rules listed in the table below.

Note: *If you leave the first and last identifier fields blank, your unit will create and display the default auto-naming of identifiers OLX-000 to OLX-999.*

Rule	Correct	Incorrect
The total number of test points must be less than or equal to 1000.	<ul style="list-style-type: none"> ➤ First identifier: OLX-000 ➤ Last identifier: OLX-999 	<ul style="list-style-type: none"> ➤ First identifier: OLX-0000 ➤ Last identifier: OLX-1200
The first identifier must not be left empty. Entering only a first identifier results in the creation of one identifier only.	<ul style="list-style-type: none"> ➤ First identifier: OLX-000 ➤ Last identifier: OLX-999 ➤ First identifier: OLX-1 ➤ Last identifier: 	<ul style="list-style-type: none"> ➤ First identifier: ➤ Last identifier: OLX-999
The first and last identifiers must have the same number of characters	<ul style="list-style-type: none"> ➤ First identifier: OLX-000 ➤ Last identifier: OLX-999 	<ul style="list-style-type: none"> ➤ First identifier: OLX-000 ➤ Last identifier: OX-999

Rule	Correct	Incorrect
The first and last identifiers must consist of letters, numbers, or the following special characters: . @ # \$ _ & - ^ () ' ; ! SPACE	<ul style="list-style-type: none"> ➤ First identifier: OLX&000 ➤ Last identifier: OLX&999 	<ul style="list-style-type: none"> ➤ First identifier: OLX% ➤ Last identifier: OLX%
For the first and last identifiers, the letters at each position must be the same or follow alphabetical order (identifiers are case-sensitive).	<ul style="list-style-type: none"> ➤ First identifier: AAA-000 ➤ Last identifier: AAB-010 	<ul style="list-style-type: none"> ➤ First identifier: AAB-000 ➤ Last identifier: AAA-010
Special characters must match between the first and last identifiers.	<ul style="list-style-type: none"> ➤ First identifier: O@X&000 ➤ Last identifier: O@X&999 	<ul style="list-style-type: none"> ➤ First identifier: O@X&000 ➤ Last identifier: O#X!999
For the first and last identifiers, character types (letters, numbers, special characters) must match at each position. Letters are case-sensitive.	<ul style="list-style-type: none"> ➤ First identifier: A&A-000 ➤ Last identifier: A&B-010 	<ul style="list-style-type: none"> ➤ First identifier: A&A-00A ➤ Last identifier: &AB-010
Numbers in the last identifier must be equal to or greater than the numbers in the first identifier.	<ul style="list-style-type: none"> ➤ First identifier: OLX-000 ➤ Last identifier: OLX-119 	<ul style="list-style-type: none"> ➤ First identifier: OLX-119 ➤ Last identifier: OLX-000
The incrementing part of the identifier is limited to 18 characters in length.	<ul style="list-style-type: none"> ➤ First identifier: 9999999999999999991 ➤ Last identifier: 999999999999999999 	<ul style="list-style-type: none"> ➤ First identifier: 09999999999999999999 ➤ Last identifier: 10000000000000000000

Working With Jobs

Generating Valid Test Point Identifiers

Your unit will display a message if you provide an invalid test point identifier with respect to the rules listed above.

To generate valid test point identifiers for local jobs:

1. From the main menu, tap **Active job**.

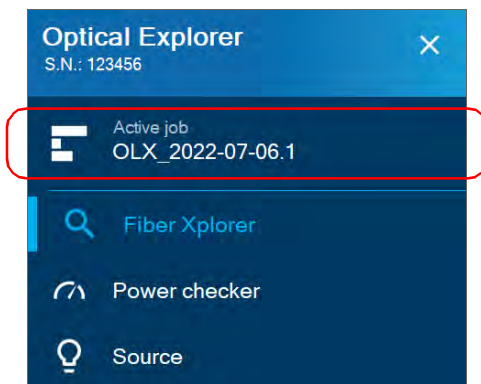

2. From the **My jobs** screen, tap the blue arrow next to the job for which you want to add test points. If you want to create a new local job, see *Creating Local Jobs* on page 110.

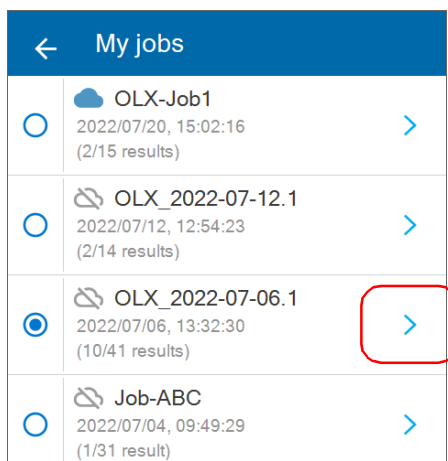

- 3.** From the list of test points displayed for the selected job, tap **Add**.

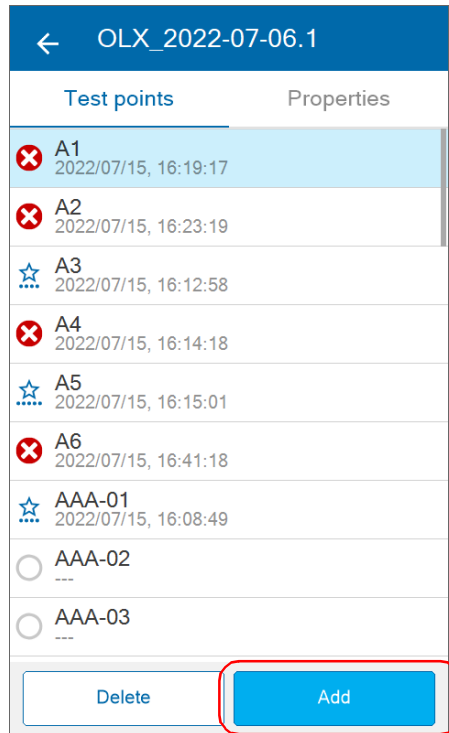

Working With Jobs

Generating Valid Test Point Identifiers

4. Enter values for the **First identifier** and the **Last identifier** (see the list of rules above for more information). If there are more than six test points, your unit displays the first three and last three identifiers in the **Preview** section along with the total number of test points generated. You can tap **Clear values** at the bottom of the screen if you wish to clear the values you entered for the first and last identifiers and return to the default auto-naming of identifiers.

The screenshot shows a dialog box titled "Test points" with a blue header. In the top right corner of the header is a "Save" button. Below the header, there are two input fields: "First identifier" containing "AAA-01" and "Last identifier" containing "AAB-09". Each input field has a small "X" icon on the right side. Below these fields is a section titled "Preview (18 test points)" which contains a list of identifiers: "AAA-01", "AAA-02", "AAA-03", "...", "AAB-07", "AAB-08", and "AAB-09". At the bottom of the dialog box is a button labeled "Clear values".

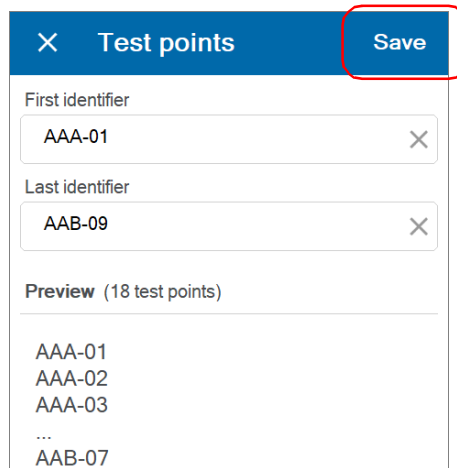
5. Tap Save.

The screenshot shows a dialog box titled "Test points" with a blue header bar. On the right side of the header bar, the "Save" button is highlighted with a red rounded rectangle. Below the header, there are two input fields: "First identifier" with the value "AAA-01" and "Last identifier" with the value "AAB-09". Below these fields is a "Preview" section showing a list of 18 test points, with the first three being "AAA-01", "AAA-02", and "AAA-03", followed by an ellipsis and "AAB-07".

6. Tap a test point to go directly to Fiber Explorer.

OR

Tap the three-line menu icon to return to the main menu.

The new test points are added to the job.

Creating Local Jobs

You can create a local job and its associated test points directly from your unit. With local jobs, you can perform and save measurements on your unit.

The results are saved on the OX1 under a list of sequential test point identifiers that you define and are generated by your unit during the local job creation process.

To create local jobs:

1. From the main menu, tap **Active job**.

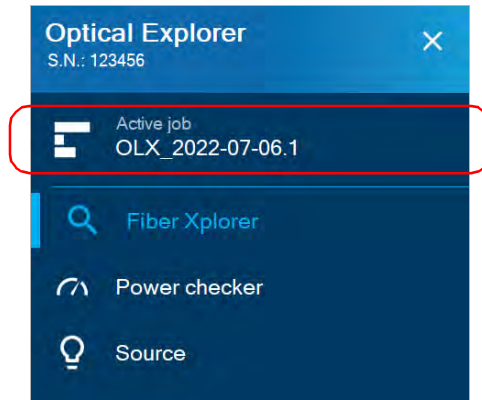

2. Tap Create.

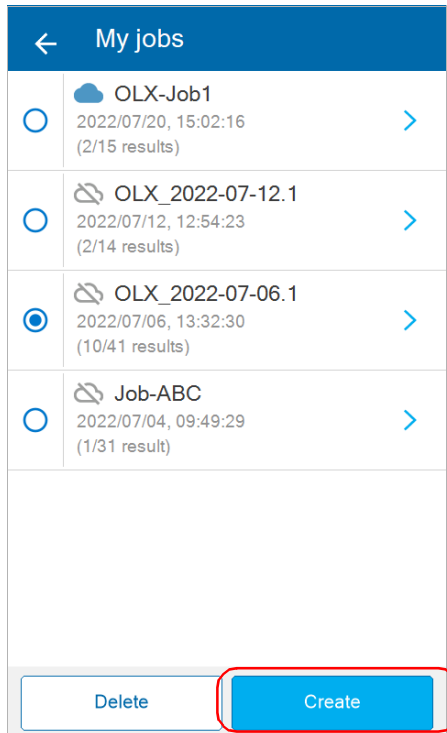

Working With Jobs

Creating Local Jobs

3. In the **Create job** screen, you can enter a name for the new job, or use the name your unit provides by default. The default name consists of 'OLX' followed by the current date. The number after the decimal point increases by one every time a new job is created on the same date using the default name.
 - 3a. Enter a name for the job or use the default name your unit provides. A job name is mandatory.



The screenshot shows a mobile application interface for creating a job. At the top, there is a blue header bar with a white 'X' icon on the left, the text 'Create job' in the center, and a white 'Next' button on the right. Below the header, there is a white input field labeled 'Name' containing the text 'OLX_2022-08-17.1' and a small 'X' icon on the right side of the field.

- 3b. If you wish, you may also enter operator, company and customer names. When you have finished entering information, tap **Next**.

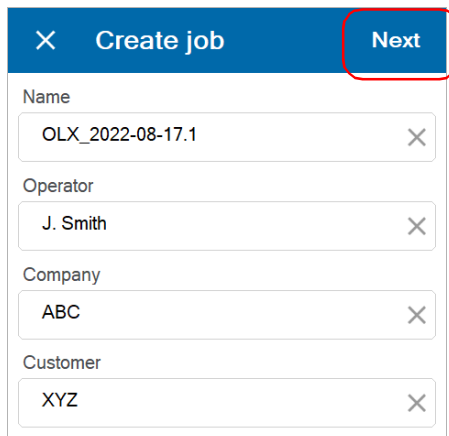

The screenshot shows the same 'Create job' screen as above, but with additional information entered. The 'Name' field contains 'OLX_2022-08-17.1'. Below it, there are three more input fields: 'Operator' with 'J. Smith', 'Company' with 'ABC', and 'Customer' with 'XYZ'. Each field has a small 'X' icon on the right. The 'Next' button in the blue header bar is now highlighted with a red rounded rectangle.

4. In the **Test points** screen, enter values for the **First identifier** and the **Last identifier**. Tap **Clear values** if you wish to clear the values you entered for both the first and last identifiers. For more information on generating valid test point identifiers, see *Generating Valid Test Point Identifiers* on page 104.

Note: *If you wish to keep the default values your unit provides for the identifiers, your unit generates a list of 1000 test points with OLX-000 as the **First identifier** and OLX-999 as the **Last identifier**.*

Note: *If you enter a value for the **First identifier** only, your unit generates a list of one test point with the value you provide.*

× Test points Save

First identifier
AAA-01 ×

Last identifier
AAB-09 ×

Preview (18 test points)

AAA-01
AAA-02
AAA-03
...
AAB-07
AAB-08
AAB-09

Clear values

Working With Jobs

Creating Local Jobs

5. When you have finished, tap **Save**.

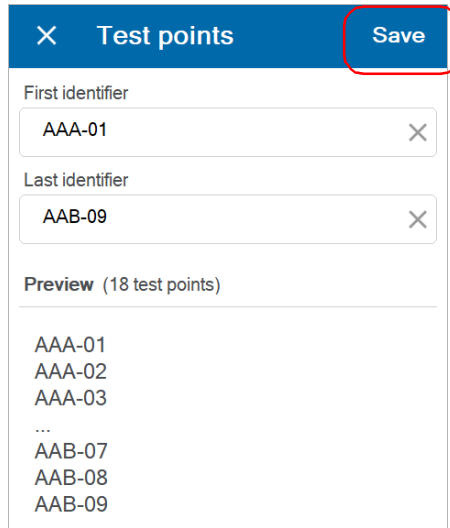

The screenshot shows a mobile application interface for configuring test points. At the top, there is a blue header bar with a white 'X' icon on the left, the text 'Test points' in the center, and a white 'Save' button on the right. Below the header, there are two input fields: 'First identifier' with the value 'AAA-01' and 'Last identifier' with the value 'AAB-09'. Each input field has a white 'X' icon on the right. Below these fields is a section titled 'Preview (18 test points)' which lists the identifiers: AAA-01, AAA-02, AAA-03, ..., AAB-07, AAB-08, and AAB-09.

6. The new job you create becomes the active job in the **My jobs** page and it is placed at the top of the list as jobs are ordered from newest to oldest. Tap the blue arrow to see the list of test points that your unit generated in the previous step.

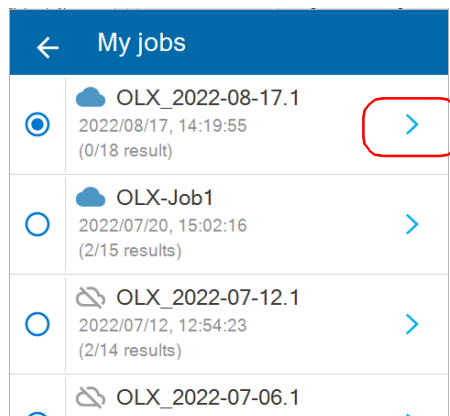

The screenshot shows a mobile application interface for viewing jobs. At the top, there is a blue header bar with a white back arrow on the left and the text 'My jobs' in the center. Below the header, there is a list of jobs. Each job entry consists of a circular icon on the left, the job name, the date and time, and the number of results. The first job is 'OLX_2022-08-17.1' with a blue cloud icon, dated '2022/08/17, 14:19:55', and '(0/18 result)'. A blue arrow icon is highlighted with a red circle to the right of this job. The second job is 'OLX-Job1' with a blue cloud icon, dated '2022/07/20, 15:02:16', and '(2/15 results)'. The third job is 'OLX_2022-07-12.1' with a blue cloud icon, dated '2022/07/12, 12:54:23', and '(2/14 results)'. The fourth job is 'OLX_2022-07-06.1' with a blue cloud icon, dated '2022/07/06, 12:54:23', and '(2/14 results)'. A blue arrow icon is also visible to the right of the fourth job.

7. Tap a test point to go directly to Fiber Xplorer.

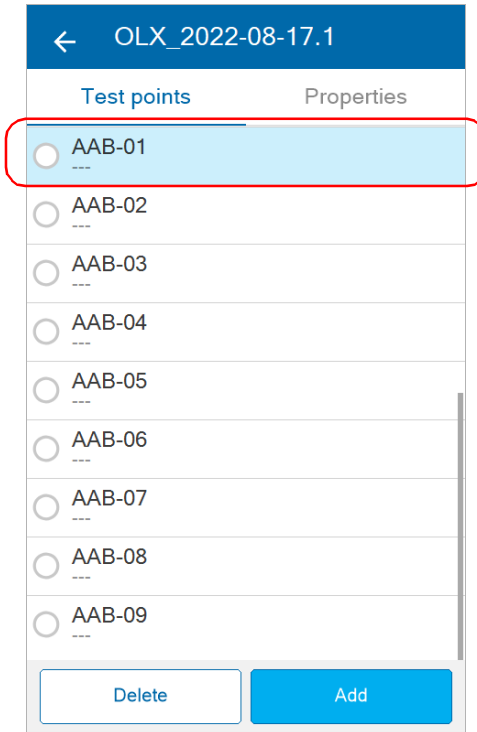

Working With Jobs

Creating Local Jobs

8. You are now ready to perform the tests in the local job (see *Performing Measurements* on page 128 for details). Tap the three-line menu icon to return to the main menu.

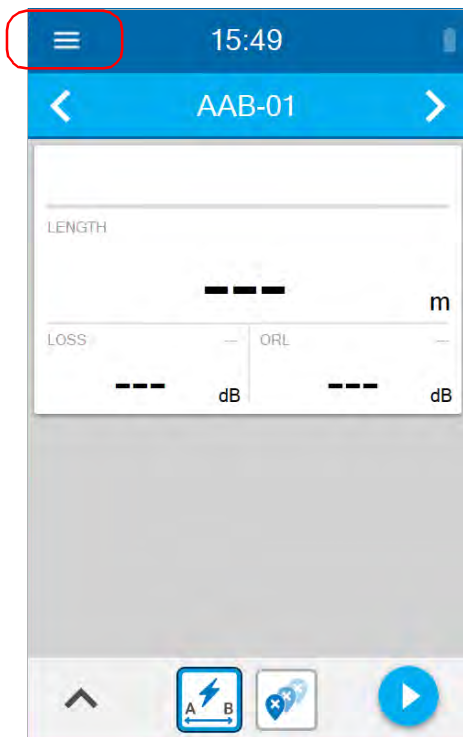

Note: If your unit does not have wireless capabilities, you can also view measurements from the Optical Explorer tool in the TestFlow/Exchange mobile application. For more information, see *Synchronizing Job Results With the Smart Device and the Cloud Server* on page 206.

Deleting Local Jobs

You can delete local and cloud-based jobs from your unit. A message will be displayed to confirm the deletion or if you still wish to delete a job that has unsynchronized test points.

You must delete local jobs when your unit's memory becomes full. As your unit's memory approaches full capacity, messages will prompt you to delete jobs so that you can continue working with your unit.

Note: *You cannot delete an active job. If the job you wish to delete is the active one, you must first select another job to make it active.*

To delete a local job:

1. From the main menu, tap **Active job**.

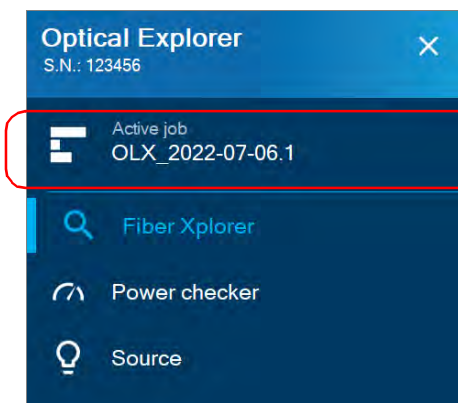

Working With Jobs

Deleting Local Jobs

- From the list of jobs in the **My jobs** page, tap **Delete** to access the job list for deletion.

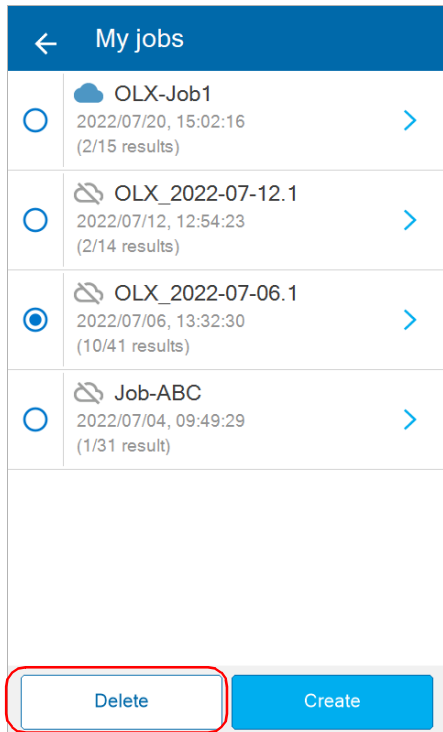

- You can only delete non-active jobs. Select the job(s) you want to delete by selecting the corresponding check box. If you prefer to select all jobs at once, tap **Select all**.

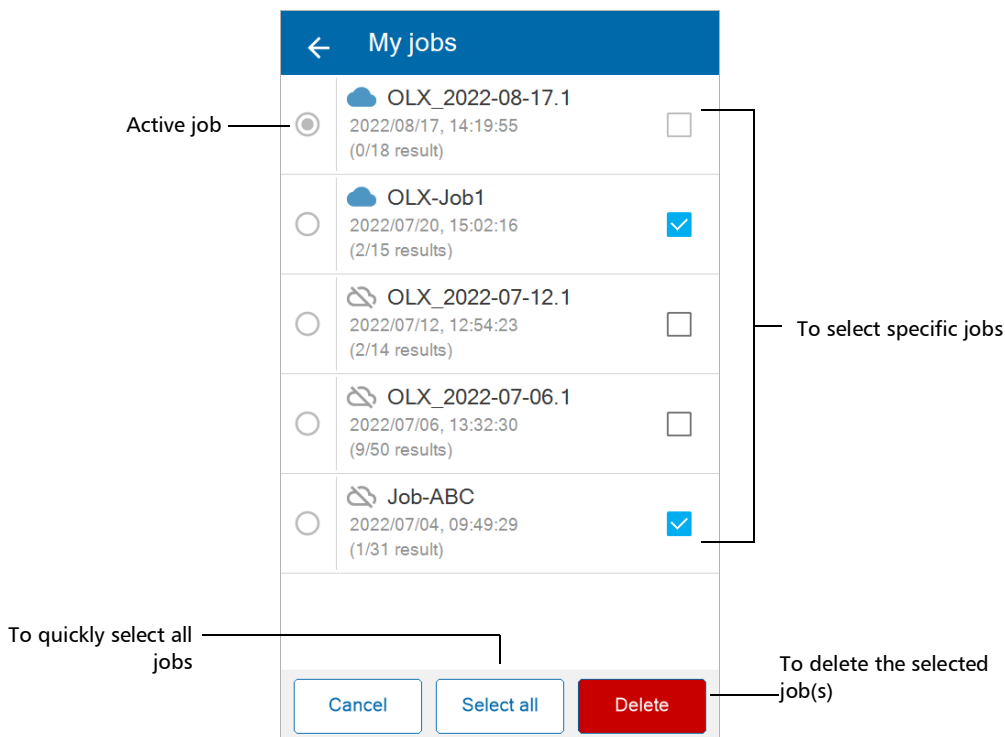

- Tap **Delete**. A message will be displayed to confirm you want to delete the selected job(s) permanently.

The selected jobs are deleted from the list.

Note: You will receive a warning message to confirm you wish to delete a job and a warning message when at least one job you wish to delete has unsynchronized or partially synchronized results with the cloud server.

Working With Jobs

Adding Test Points to a Local Job

You can manually add test points to a local job on your unit.

Note: You cannot add test points to a cloud-based job from your unit.

To manually add test points to a local job:

1. From the main menu, tap **Active job**.

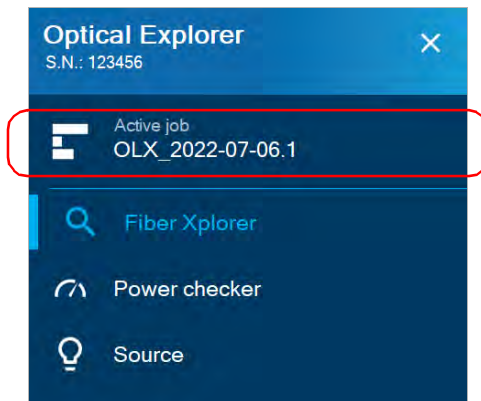

2. From the **My jobs** page, tap the blue arrow next to the job to display its current list of test points.

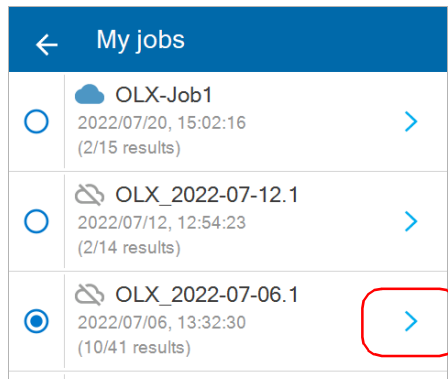

3. From the list of test points, tap **Add**.

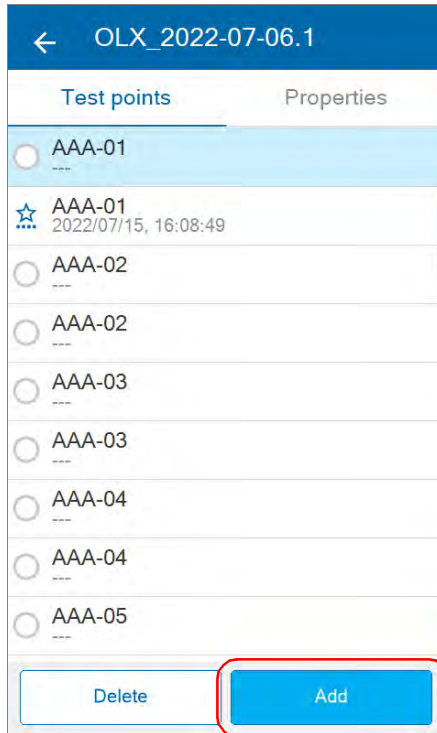

Working With Jobs

Adding Test Points to a Local Job

4. Enter values for the **First identifier** and the **Last identifier**. For more information on generating valid test point identifiers, see *Generating Valid Test Point Identifiers* on page 104.

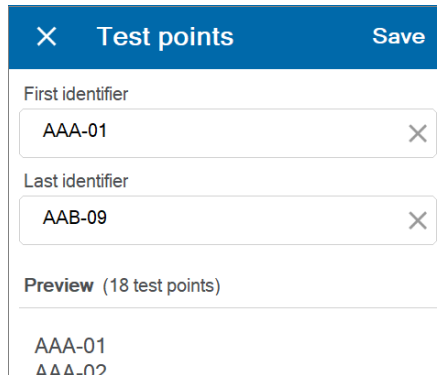

×

Test points

Save

First identifier

AAA-01

Last identifier

AAB-09

Preview (18 test points)

AAA-01
AAA-02

5. Tap **Save**.

The new test points are added to the existing list in numerical and alphabetical order.

Deleting Test Points From a Local Job

You can manually delete test points that are part of a local job.

Note: You cannot delete test points that are part of a cloud-based job from your unit.

To manually delete test points from a local job:

1. From the main menu, tap **Active job**.

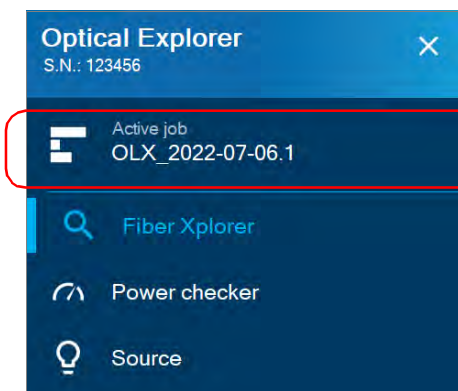

2. From the **My jobs** page, tap the blue arrow next to the job to display its list of test points.

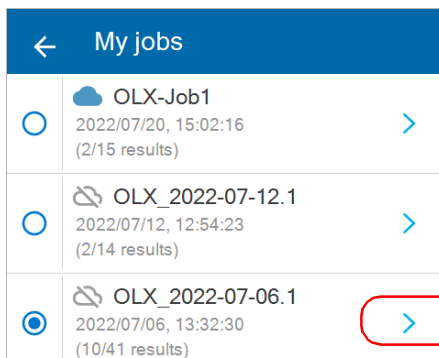

Working With Jobs

Deleting Test Points From a Local Job

3. Tap **Delete** to access the list of test points for deletion.

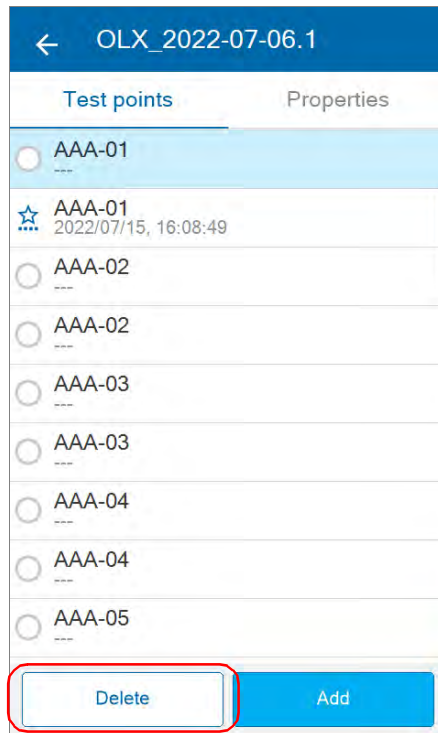

4. Select the test point(s) you want to delete by selecting the corresponding check box. If you prefer to select all test points at once, tap **Select all**.

Note: You cannot delete an active test point.

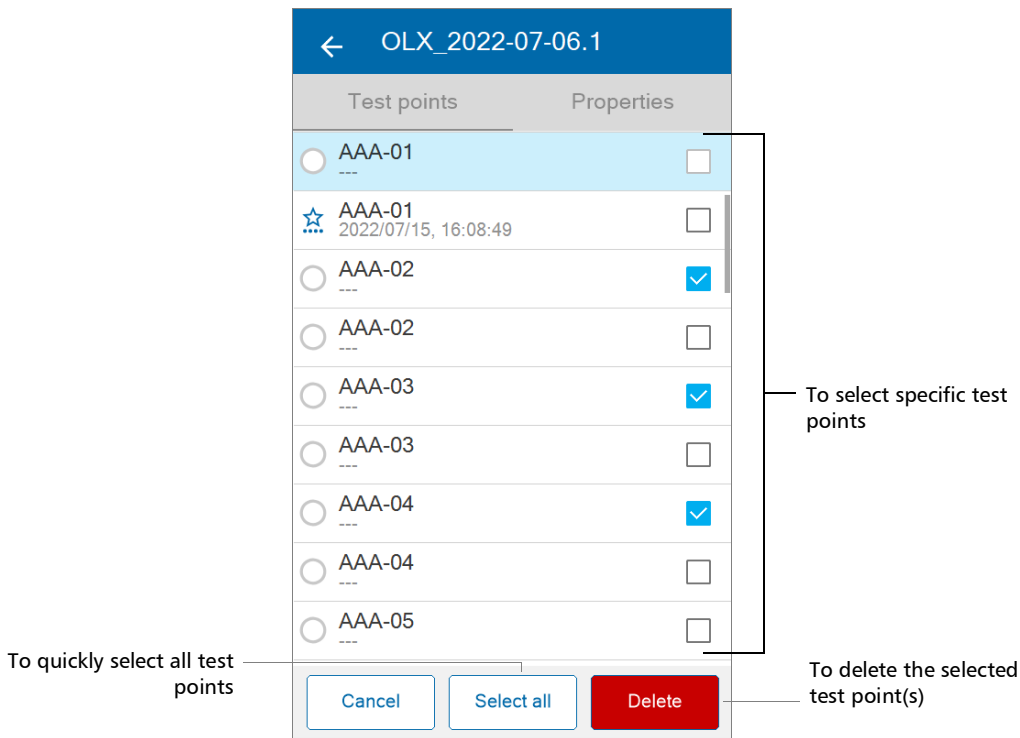

5. Tap **Delete**.

Note: You will receive a warning message to confirm you wish to delete a test point and a warning message when at least one test point you wish to delete has unsynchronized or partially synchronized results with the cloud server.

6 Testing Fibers

The OX1 offers different test functions providing you with the level of detail you want to see when testing a fiber link.

Note: *When a measurement is underway, it is automatically stopped as soon as you open the power checker or the light source tool.*

The table below presents each test functions.

Test Functions	Characteristics
Flash Advisor For length, IL, and ORL that	<ul style="list-style-type: none">▶ Very fast measurement time.▶ The link assessment is always performed using the EXFO Advisor settings. The rating displayed suggests the link may contain faults.
Fault Xplorer For length, IL, ORL, and fault exploration.	<ul style="list-style-type: none">▶ Fast measurement time when no problems are found on the fiber link.▶ Localizes and identifies the fault types on the fiber link.
Link Mapper (Pro units only) For length, IL, ORL, and mapping of all detectable elements.	<ul style="list-style-type: none">▶ Since the unit identifies and measures all elements on a link, the duration of the measurement is systematically longer.▶ Identifies, measures and locates all detectable elements on a link.

Performing Measurements

The OX1 allows you to test fibers with different test functions. You may want to set basic parameters before starting a measurement according to your needs:

- the wavelengths at which you want to perform the measurements (see *Selecting Test Wavelengths* on page 56 for details)
- the thresholds associated with the pass/fail criteria (customized or EXFO Advisor) (see *Working With Custom Pass/Fail Thresholds or EXFO Advisor* on page 70 for details)
- the length of the launch and receive test cords (see *Working With Launch and Receive Test Cords* on page 29 for details)
- the IOR value (see *Configuring the IOR Value* on page 95 for details)
- the automatic saving of measurements (see *Enabling or Disabling Auto Save* on page 66)
- the automatic navigation of test points (see *Enabling or Disabling Auto Navigation* on page 68)

Note: *When a measurement is underway, the navigation arrows are disabled and you cannot browse through the measurements you have already performed.*

To perform measurements:

1. Clean the connectors properly.
2. Connect the launch cord or the fiber under test to the OX1 port.



CAUTION

Ensure that the connector of the launch or receive cord always matches the connector of the unit (APC or UPC). Joining mismatched connectors will damage the ferrules.

3. On your unit, ensure that the parameters have been set according to your needs.
4. From the main menu, tap **Active job** to access the **My Jobs** page and select a test point. For more information, see *Understanding the My Jobs Page* on page 102.

OR

Tap **Fiber Xplorer** to go to the active test point from the active job.

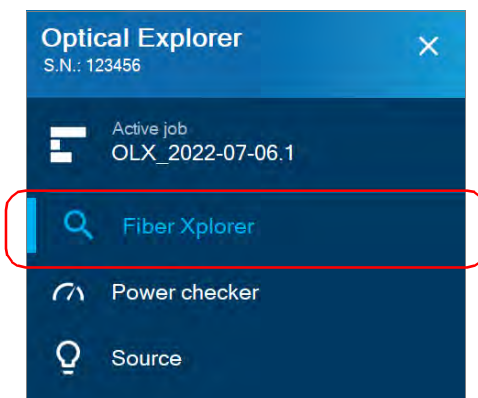

Testing Fibers

Performing Measurements

5. To change the test point, tap the left or right navigation arrows.

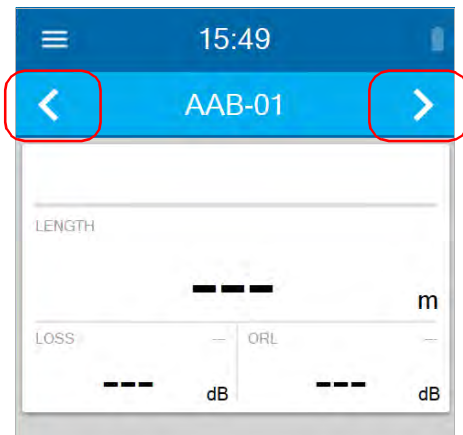

OR

Tap the test point identifier to access the list of test points associated with the active job.

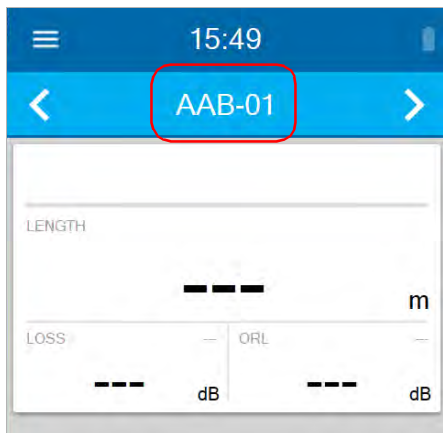

6. Tap on a test point identifier to go to Fiber Xplorer.

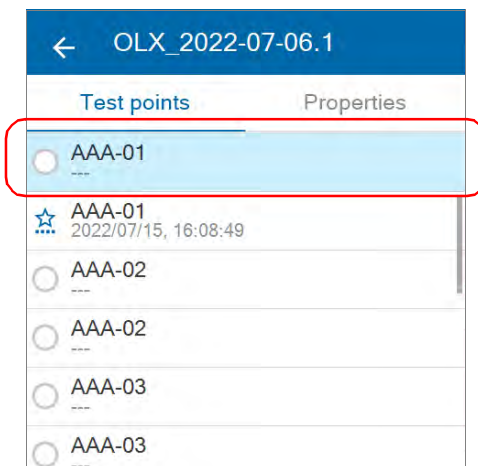

7. If you intend to perform a standard test, select a test function (see *Test Functions and Tools* on page 10 for details).

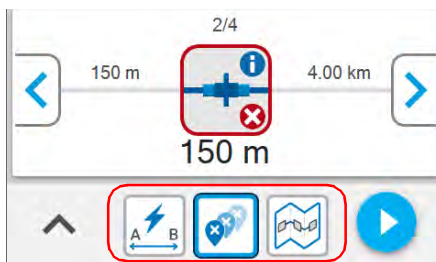

OR

If you intend to perform a test using the PON tool with a PRO model, tap the button corresponding to the test you want to perform (see *Working With the PON Tool on page 80* for details).

Testing Fibers

Performing Measurements

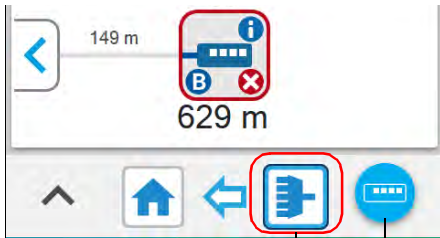

To test toward the ONT
(with or without ONT
detection)

To start an acquisition with the
ONT detection test

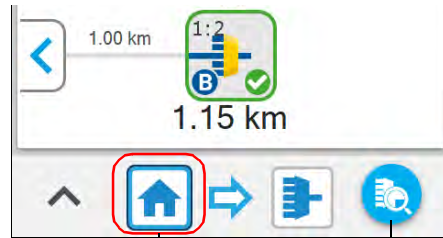

To test toward the splitter
(with or without splitter
detection)

To start an acquisition with the
splitter detection test

8. Tap the  button to start the measurement.

Note: *The start button differs if you are working with a splitter or an ONT detection test.*

Once a measurement is performed, you can view the results in different parts of the screen. See *Working With Link Results* on page 133, *Working With Link Overview* on page 135, and *Working With Link View* on page 136.

For information on configuring your unit's behavior when saving measurements, see *Understanding the Unit's Behavior When Saving Measurements* on page 165.

Working With Link Results

You can view, at a glance, the pass/fail status of the link, the link length, the loss and ORL values for the link. The pass/fail status depends on the status of each value and it will be:

- Pass: when each element on the link has a pass status
- Fail: when at least one of the element on the link has a fail status
- Unknown: when no threshold is configured or a span value (length, loss, ORL) is not available

Note: *If you choose to include the optical power of a link in the measurement, the value will be displayed in the Fiber Xplorer page. This value is taken into account in the status of the global acquisition. See Enabling or Disabling Power Measurements on page 61 for details.*

In Fault Xplorer and Link Mapper, the application displays a pass/fail status when custom thresholds are applied.

Since you cannot use custom thresholds in Flash Advisor, EXFO Advisor rates the quality of the results according to the parameters used for the measurement. The rating ranges from zero to five stars (half stars are possible). The same rating is applied to all wavelengths. If you use the EXFO Advisor thresholds in Fault Xplorer and Link Mapper, there will be no pass/fail status displayed either.

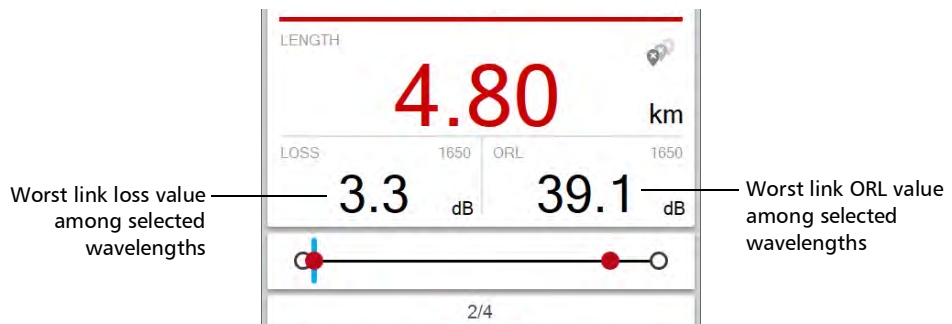

Testing Fibers

Working With Link Results

By tapping directly on the space dedicated to the link results, you can access specific values by wavelength. The page also displays the length for both the launch and receive test cords.

Note: If the link ORL value is displayed with a < symbol, the value is exceeding the saturation level of the detector.

Note: If the reflectance value is displayed with a > symbol, the value is exceeding the saturation level of the detector.

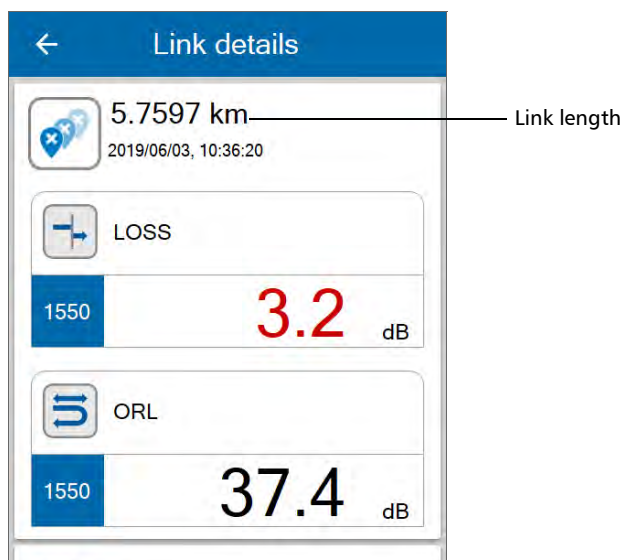

Working With Link Overview

This graphic representation shows the entire link, all of its faults (Fault Xplorer), or all of its detectable elements (Link Mapper), from the link start (A) to the link end (B). The elements are displayed using a proportional distance. During a Fault Xplorer acquisition, the OX1 flags elements that could be potential faults.

When you select an element in the link overview, it is automatically selected in the link view. See *Working With Link View* on page 136 for details.

Note: *The link overview is not available in Flash Advisor.*

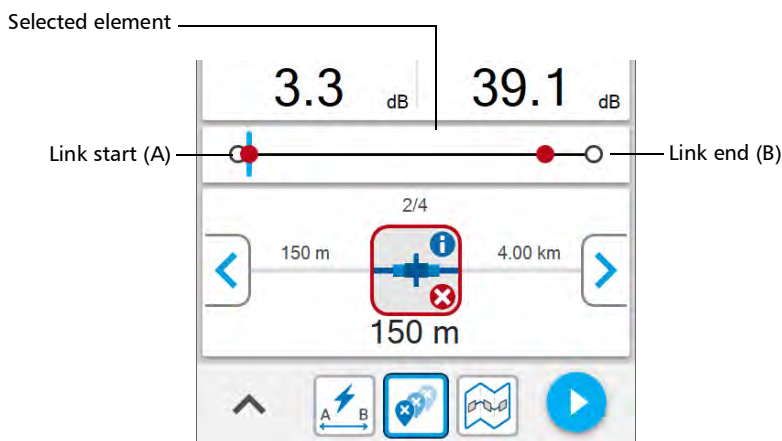

Working With Link View

This graphic representation displays, one at a time, all of its faults (Fault Xplorer), or all of its detectable elements (Link Mapper), present on the link from the first connector to the last element detected. You have to use the navigation arrows to see each element.



During a Fault Xplorer acquisition, the elements which are considered as potential faults are tagged with the connector or splice element type icons.





When you select an element in the link view, it is automatically selected in the link overview as long as it is located within the link start and the link end. See *Working With Link Overview* on page 135 for details.

Note: *The link view is not available in Flash Advisor.*

The application assigns a sequential number to each element or fault displayed along the link between the link start (A) and the link end (B). Only one identification number is assigned for a group of elements.

The elements are represented by the following icons:

Element Name	Element Icon	Meaning
Splice		The splice can indicate the junction of two fiber sections, or any non-reflective loss induced by a bend or coupler, for instance.
Connector		The connector is used to join two fibers.
Connector A		Connector A corresponds to the link start.

Element Name	Element Icon	Meaning
Connector B		Connector B corresponds to the link end.
Macrobends		Macrobends can be displayed in the link view when more than one wavelength is present in the measurement.
Out of range		This element is displayed when the application cannot detect the end of fiber because of insufficient dynamic range.
Group		Several link elements or faults are combined when they cannot be independently identified.

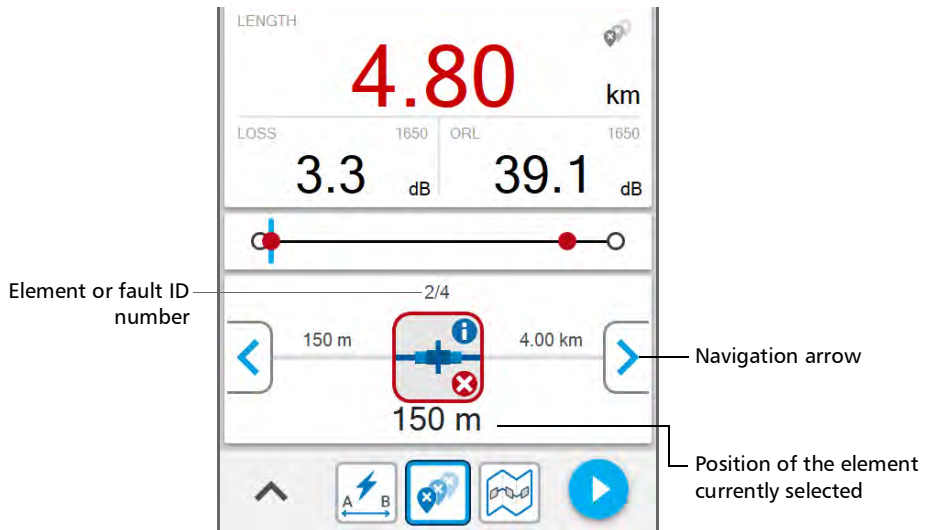

Testing Fibers

Performing Tests When Light Is Detected on the Network

The application can detect several link elements or faults that are too close to one another to be independently identified. When this is the case, the application will display the link elements as groups and provide as much information as possible for each individual sub-element. The application will also apply a pass/fail status to each sub-element whenever possible, and a global status for the group.

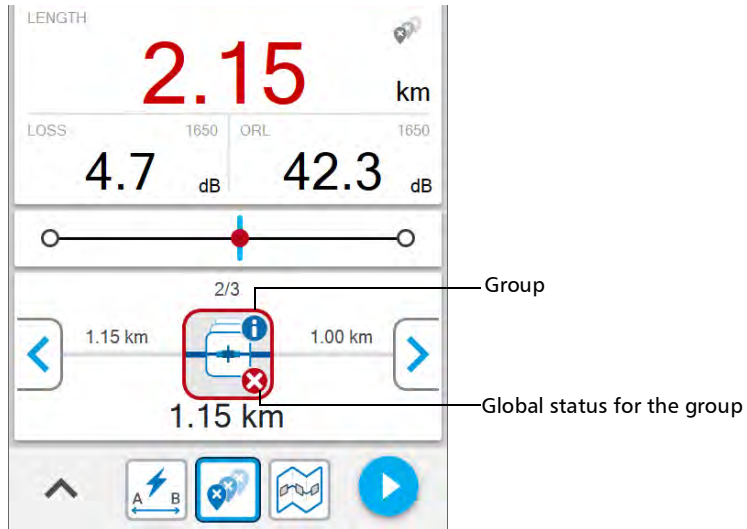

Performing Tests When Light Is Detected on the Network

When you work with networks on which light is detected, the Optical Explorer units offering the 1650 nm wavelength with a filtered port are more appropriate because they are equipped with a reception filter which rejects incoming light.

In both cases, if the amount of light that hits the OX1 detector is too important, the unit displays a message to notify you.

7 **Using the Power Checker**

Your unit is equipped with a power checker to measure absolute power (dBm) or insertion loss (dB). It can detect modulated signals (270 Hz, 330 Hz, 1 kHz, and 2 kHz). The OX1 automatically detects the tone coming from the light source. It also indicates when no tone can be detected by displaying CW.

The results are clearly displayed with the global status (pass, fail or unknown) and the unit indicates when the power signal is low.

The power checker can perform measurements as soon as you open the corresponding page and as long as the page remains open.



IMPORTANT

- **When you exit the power checker page, the measurements are automatically stopped and your unit does not save the information. Ensure that the power checker page remains open as long as you need to perform measurements.**
- **Do not forget to close the power checker page when the measurements are complete. Otherwise, the power checker will perform measurements constantly and could drain the battery of the unit.**

Setting Thresholds

You can define thresholds to specify minimum and maximum power or loss values for each wavelength or you can apply the same thresholds to all wavelengths.

You can also choose not to define any threshold values by disabling this feature. All values can be reverted to factory settings at any time. The values you have entered are kept in memory when you close the page.

The threshold values affect the global status (pass, fail or unknown) of the absolute power and the insertion loss.

You can set the thresholds directly from power checker or in the Settings page.

To set power or loss thresholds directly from the power checker page:

1. Tap Thresholds.

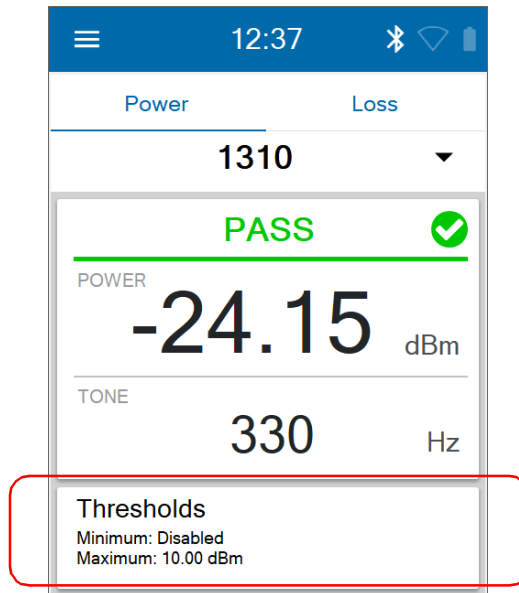

2. If you want to use the same threshold values for all wavelengths, select **All wavelengths**.

OR

If you prefer to define thresholds per wavelength, select **By wavelength**.

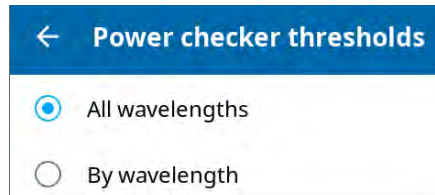

3. To edit the threshold values, proceed as follows:
 - 3a. If necessary, activate the threshold with the toggle button.

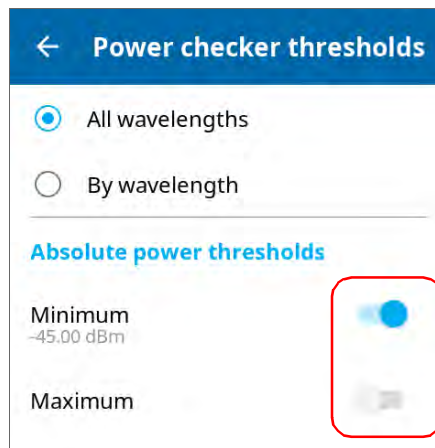

Using the Power Checker

Setting Thresholds

3b. Tap the displayed numbers.

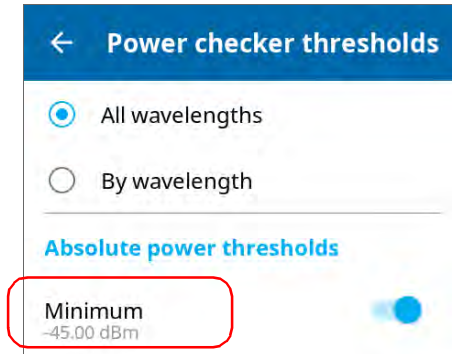

3c. Enter a new value.

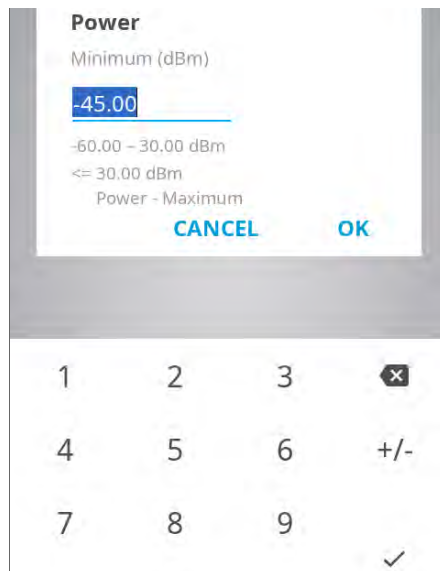

3d. Tap **OK** to return to the **Power checker thresholds** page.

Note: You can revert to factory settings at any time by tapping **Reset to default values**.

To set power or loss thresholds from the Settings page:

1. From the main menu, tap **Settings**.

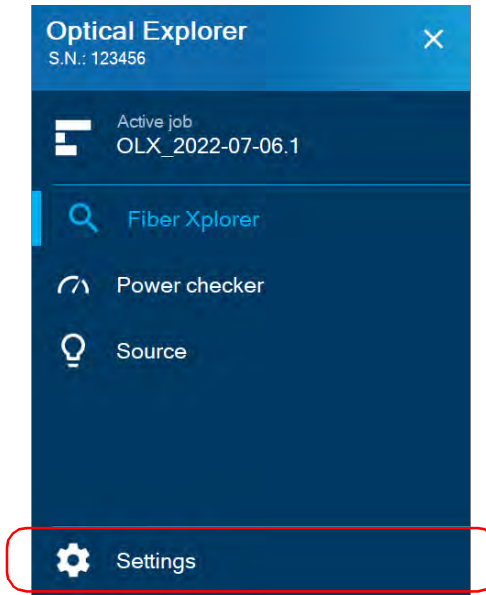

2. Scroll down to the **Power checker** section.
3. Tap **Thresholds**.

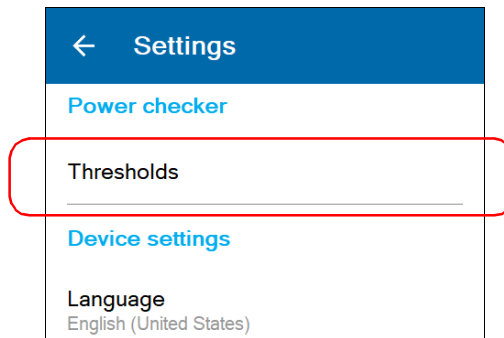

Using the Power Checker

Setting Thresholds

4. If you want to use the same threshold values for all wavelengths, select **All wavelengths**.

OR

If you prefer to define thresholds per wavelength, select **By wavelength**.

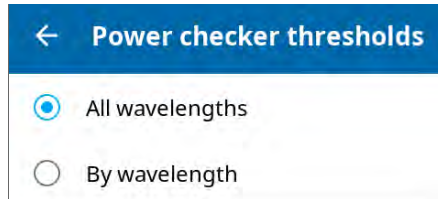

5. To edit the threshold values, proceed as follows:

5a. If necessary, activate the threshold with the toggle button.

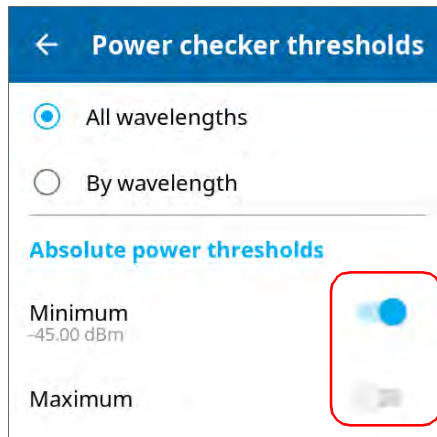

5b. Tap the displayed numbers.

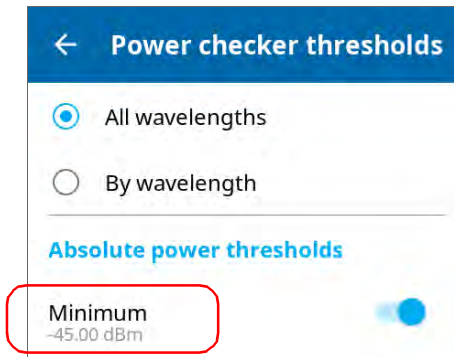

5c. Enter a new value.

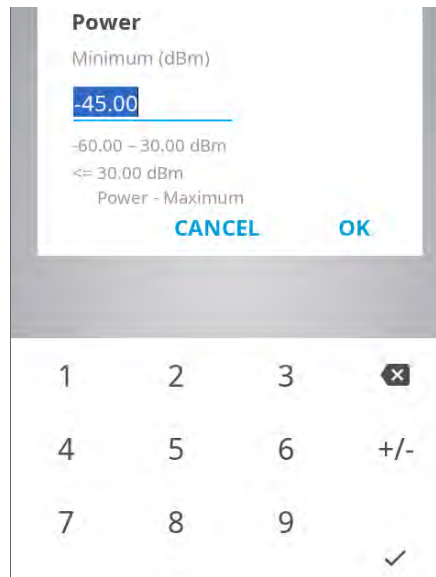

5d. Tap **OK** to return to the **Power checker thresholds** page.

Note: You can revert to factory settings at any time by tapping **Reset to default values**.

Using the Power Checker

Setting Reference Values on Your Power Checker

In loss measurement mode, your unit displays on screen the loss created by the fiber under test only, since it subtracts a reference value from the measured power.

You can set a different reference value for each wavelength. The reference value remains available as long as you do not restart the unit. By default, the reference value is set to 0.00 dBm.

Note: *You can only set reference values in loss measurement mode, which is available when a single wavelength is selected. If a pair of wavelengths or the automatic PON detection are selected on a dual-channel unit, you only have access to the power measurement mode (no reference values).*

To set reference values:

1. Inspect your fibers and clean them properly.
2. Using the proper adapter and test jumpers, connect a light source to your unit.
3. From the **Loss** tab, select a wavelength and activate the source at the same wavelength.

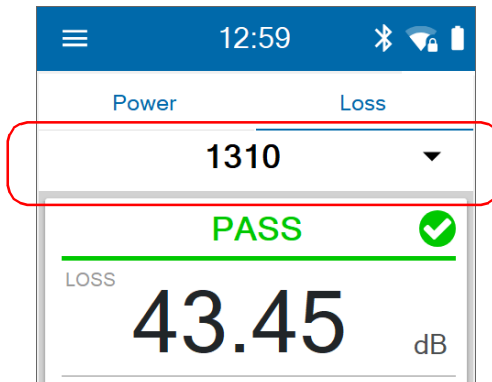

Using the Power Checker

Setting Reference Values on Your Power Checker

4. Tap **TAKE REF.** to save the current power value as the new reference.

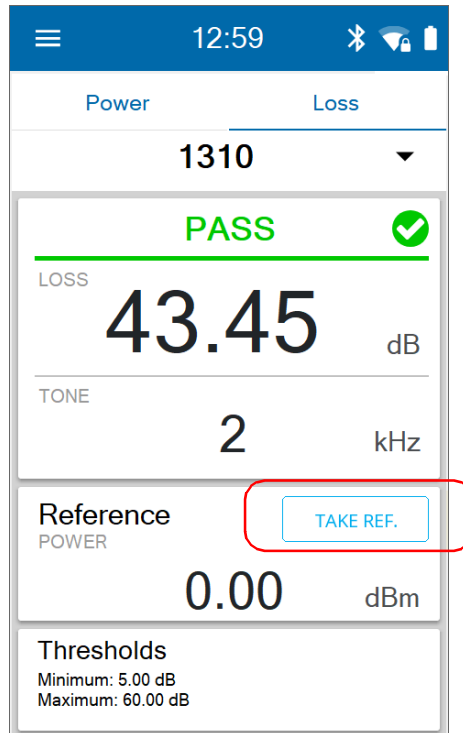

Note: The **TAKE REF.** button is disabled when the power value is unknown or too low and the application displays **LOW** or "---" on screen.

Measuring Power or Loss

Measuring absolute power or link loss is done the same way, except for the referencing step.

If you are working with a dual-channel unit, you must select a pair of wavelengths, or let the unit automatically interpret the received signal(s) from your PON network, to measure power. The dual-channel unit supports the following wavelengths related to PON networks:

- 1490 nm – GPON
- 1550 nm – RF Video
- 1577 nm – XGS-PON

Note: *The loss measurement is only possible when a single wavelength is selected. If a pair of wavelengths or the automatic PON detection are selected on a dual-channel unit, you can only perform power measurements.*

To perform power or loss measurements:

1. Inspect your fibers and clean them properly.
2. For loss measurements, reference your power checker to a light source (see *Setting Reference Values on Your Power Checker* on page 146), then deactivate the light source.
3. If you have used a single reference patchcord, disconnect it *from the power checker port only*, then attach a second reference patchcord to the power checker.

OR

If you have used two reference patchcords, disconnect both of them at the bulkhead.

4. Using bulkhead adapters or the system patch panels, connect a fiber under test to reference the patchcord attached to the light source and power checker.

5. Tap the **Power** or **Loss** tab.

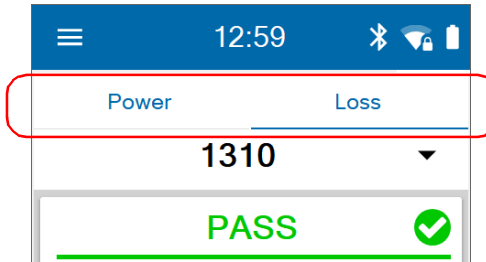

6. Select a wavelength and activate the source at the same wavelength.

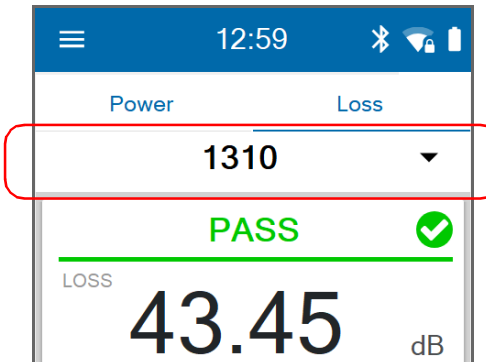

Note: *If you connect a single-wavelength source to a dual-channel unit and you select a pair of wavelengths, you will see the power value measured at the received wavelength. The unit will display “LOW” for the other channel. If you select the automatic PON detection, you will only see the power value measured at the received wavelength.*

7. Repeat the procedure for other wavelengths if desired.

The absolute power or link loss value appears on screen.

8 **Using the Light Source**

You can use the OX1 as a light source to perform measurements with a power meter. By default, the modulation is set to CW (continuous), but you can select another value, depending on the type of tests you want to perform.

- For loss measurement, you should choose a continuous pattern.
- For fiber identification, you should choose any modulation value other than continuous. This will allow the person at the other end of the link to identify the fiber under test, which is particularly useful when working with cables containing many fibers.

When the light source is on (off by default), it emits light constantly until you turn it off, but you can set a timer allowing light emission only for a certain period of time (up to 999 minutes). The first time you work with the source, the timer is disabled. The default value is set to 30 minutes when it is enabled. As soon as the timer reaches zero, the light emission stops automatically. If you enable this feature and decide not to edit the number of minutes during which you want the source to emit light, it will stop after 30 minutes. The application displays clearly the countdown on screen. The state of the timer (on or off) and the value you have entered are kept in memory when you close the page.



IMPORTANT

- **When you exit the source page, the light source continues to emit light. The light emission stops automatically when you open the power checker or the Fiber Xplorer page.**
- **If you have not set a timer to automatically turn off the source, do not forget to turn it off when the test is complete. Otherwise, the source will emit constantly and could drain the battery of the unit.**

Using the Light Source

To use the light source:

1. From the main menu, tap **Source**.

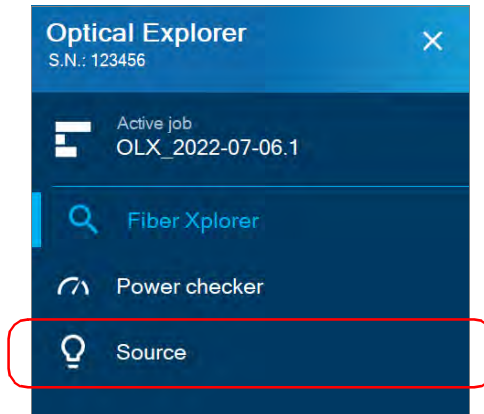

2. Select a wavelength.



3. Select a modulation.

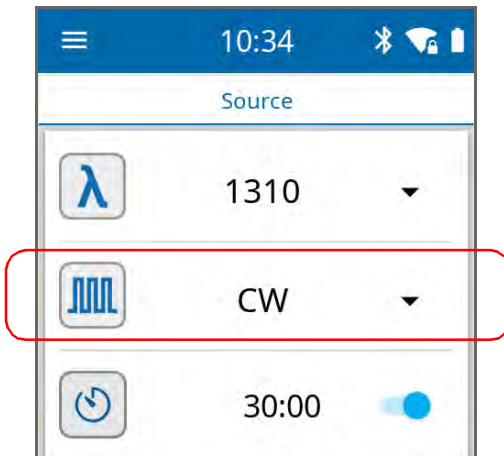

IMPORTANT

The OX1 Optical Explorer can be used in continuous source mode (CW) to perform optical power measurements and it is compatible only with the following: high power Germanium (GeX) versions of the 300 and 600 Series, the PX1-H and PX1-PRO-H, as well as any unit's built-in GeX power meter.

The EPM-50 power meter and MPC-100 power checker are not compatible for measurements using an OX1 Optical Explorer in continuous setting.

Using the Light Source

4. To set the timer, proceed as follows:
 - 4a. If necessary, activate the feature with the toggle button.

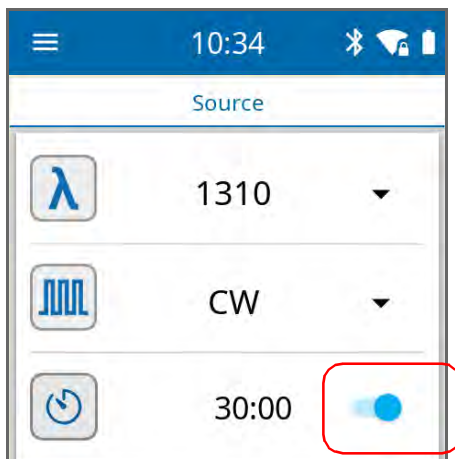

Note: *If you do not want to set the timer, deactivate the feature with the toggle button.*

4b. Tap the displayed numbers.

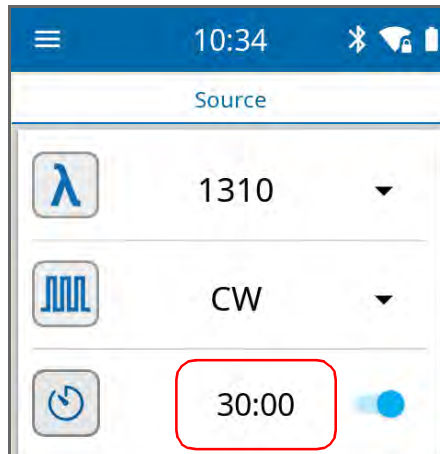

4c. Enter the number of minutes during which you want the source to emit light.

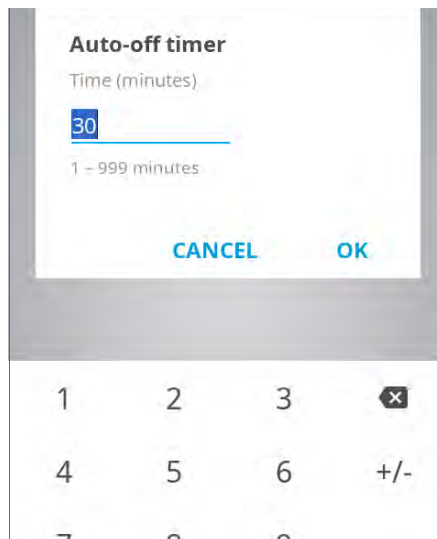

4d. Tap **OK** to return to the **Source** page.

Using the Light Source

5. Tap  to start the light emission.

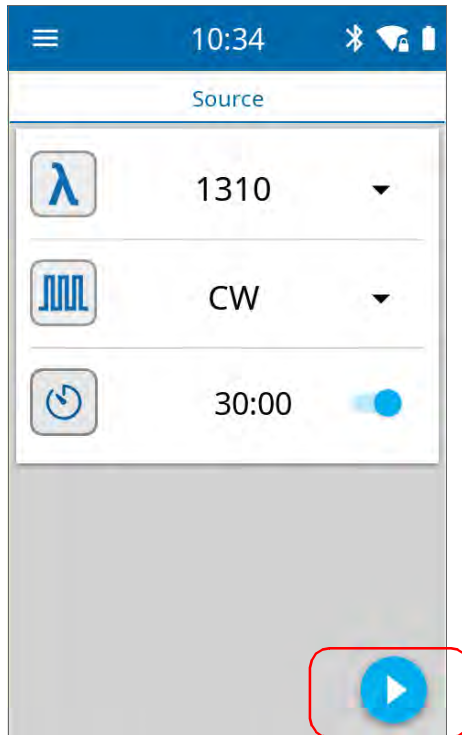

A blinking icon and a red banner clearly indicate when the light source is emitting.

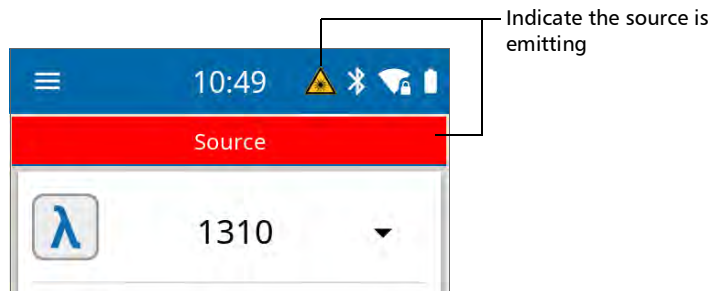

6. To avoid draining the battery of the unit, tap  to stop the light emission as soon as your tests are complete.

Note: *If you have set the timer, the light emission stops when the value you have entered reaches zero.*



9 **Managing Test Results**

You can view measurements directly from your unit. You can also manually delete measurements that are not part of a cloud-based job by selecting all measurements or some of them only. You cannot delete measurements that are part of a cloud-based job but you can perform a measurement that has already been done again. See *Performing a Measurement Again* on page 204 for details.

To generate measurement reports you can use the TestFlow/Exchange mobile application application if your unit has wireless capabilities. See *Generating Measurement Reports With a Bluetooth Connection* on page 170, and *Generating Job Measurement Reports* on page 209.

Note: *If desired or if your unit does not have wireless capabilities, you can transfer the measurement from your unit to a computer with EXFO's FastReporter 3 using a USB connection. With FastReporter 3, you can generate reports. See *Generating Measurement Reports With a USB Connection* on page 173 for more information.*

Viewing Measurements

The measurements you perform on your unit are saved under a test point that you create in a local job or in a job that someone has created for you with the TestFlow/Exchange mobile application for units with wireless capabilities.

You can view measurements from their dedicated test points that are either part of a local or cloud-based job.

Managing Test Results

Viewing Measurements

To view measurements from Fiber Xplorer:

1. From the main menu, tap **Fiber Xplorer**.

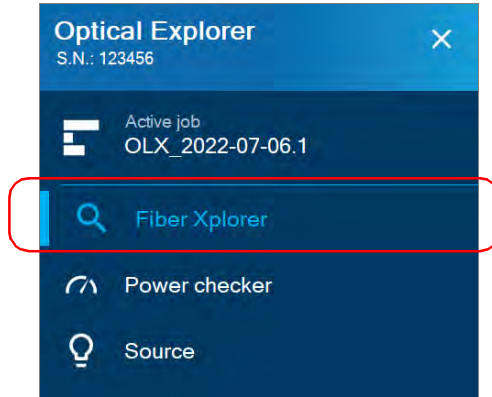

2. From Fiber Xplorer, use the  and  arrows to view the available measurements, in turn.

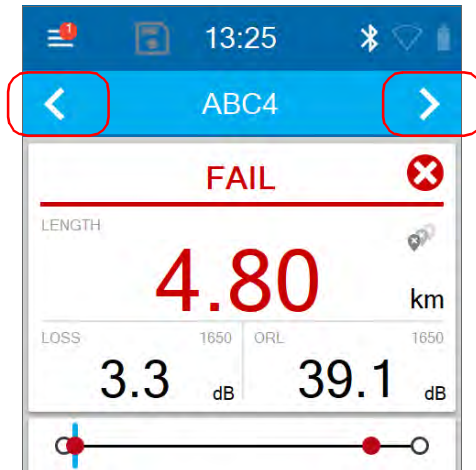

To view measurements from the list of test point identifiers:

1. From the main menu, tap **Active job**.

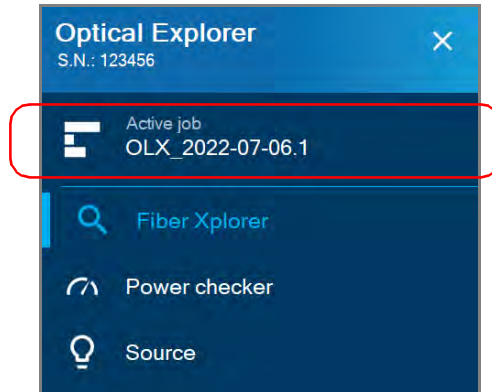

2. From the **My jobs** page, tap the blue arrow to display the list of test points in a job.

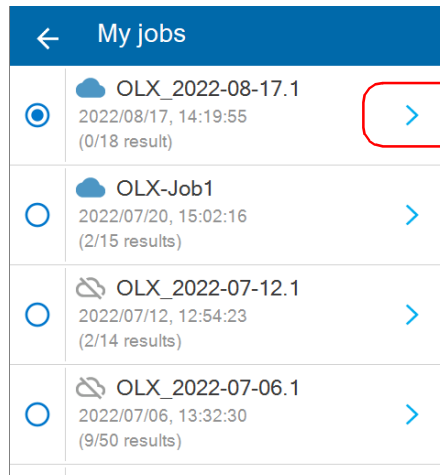



Managing Test Results

Viewing Measurements

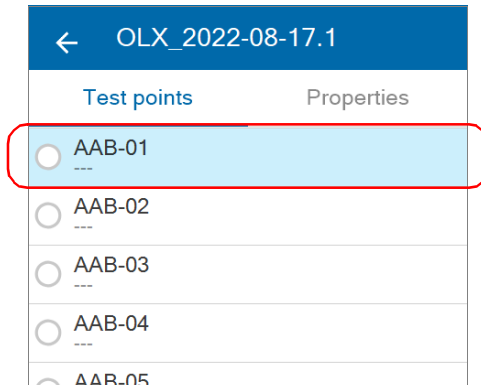
- From the list of test points, tap a test point to see the corresponding measurement in Fiber Xplorer.



- From Fiber Xplorer, use the  and  arrows to view the available measurements, in turn.

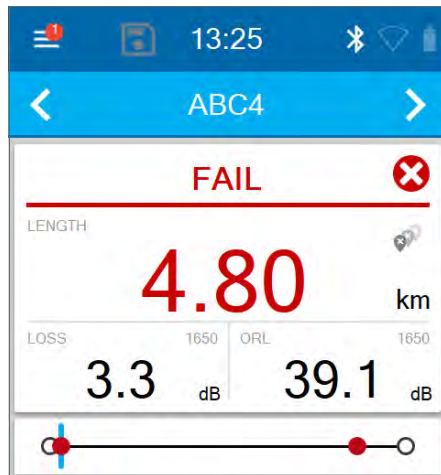

For more information, see *Working With Link Results* on page 133, *Working With Link Overview* on page 135, and *Working With Link View* on page 136.

Changing an Element Type

In Fault Explorer and Link Mapper, you can change the element type identified as “splice” to the element type “connector”. The splice must be between the link start and the link end. A “*” sign is displayed to notify you that the former splice is now considered as a connector. Once the element type has been changed, the unit reanalyzes the measurement automatically by reapplying the thresholds of the connector. Both the pass/fail status of the element as well as the status of the whole link are refreshed.

Note: You can change back the element type now identified as “connector” to the element type “splice” but the “*” sign will still be displayed.

Note: No confirmation message will be displayed to confirm your change.

To change an element type:

1. In the link results area, tap the element you want to modify.
See *Working With Link Results* on page 133 for details.
2. Use the blue arrows  to change the element type.

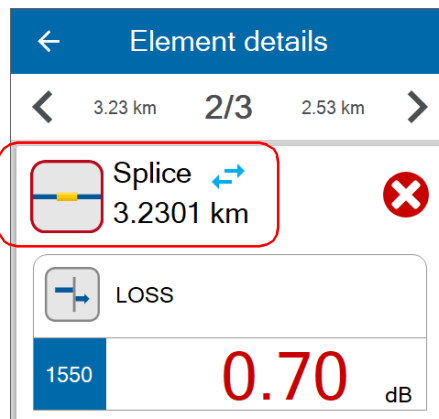

Managing Test Results

Changing an Element Type

A "*" sign is displayed both in Element details and in Fiber Explorer to indicate the change of element type.

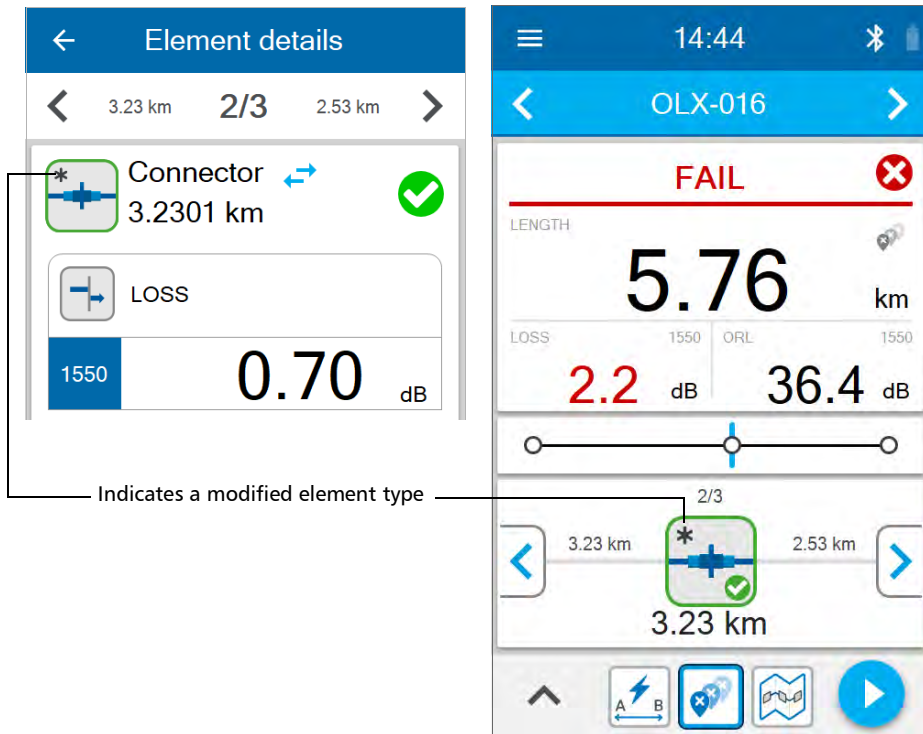

Understanding the Unit's Behavior When Saving Measurements

You can use your unit to perform quick measurements without saving every result.

You can also define your unit's behavior once the measurement process is complete. You can enable the automatic saving of each measurement taken or you can disable the automatic saving in order to only save the measurements you wish to keep by using the quick save feature. For more information on enabling or disabling the automatic saving of measurements, see *Enabling or Disabling Auto Save* on page 66.

You can also define the unit's behavior once the saving process is complete. You can enable the automatic navigation to the next available test point or have your unit remain on the same test point once the measurement and saving processes are complete. For more information on enabling or disabling the auto navigation to the next test point, see *Enabling or Disabling Auto Navigation* on page 68.

Performing Measurements With the Auto Save Enabled

If you have enabled the automatic saving of measurements, your unit automatically saves the measurement once the process is complete.

If you have also enabled the automatic navigation, your unit navigates to the next available test point in Fiber Explorer once the measurement and saving processes are complete.

Note: *If you have enabled the auto navigation, the new result will be shown for a few seconds before moving to the next test point. The name of the test point on the banner will flash. If you wish to cancel the auto navigation, you can tap anywhere on the screen.*

Note: *If you have disabled the auto navigation, your unit stays on the same test point.*

Managing Test Results

Understanding the Unit's Behavior When Saving Measurements

Performing Measurements With the Auto Save Disabled

You can define the unit's behavior once the measurement process is complete.

To perform measurements with the auto save disabled:

1. Select the desired test point to perform a measurement. For more information on selecting test points, see *Performing Measurements* on page 128
2. If it is not already done, disable the auto save.
 - 2a. From **Fiber Xplorer**, tap the arrow to access the drawer.

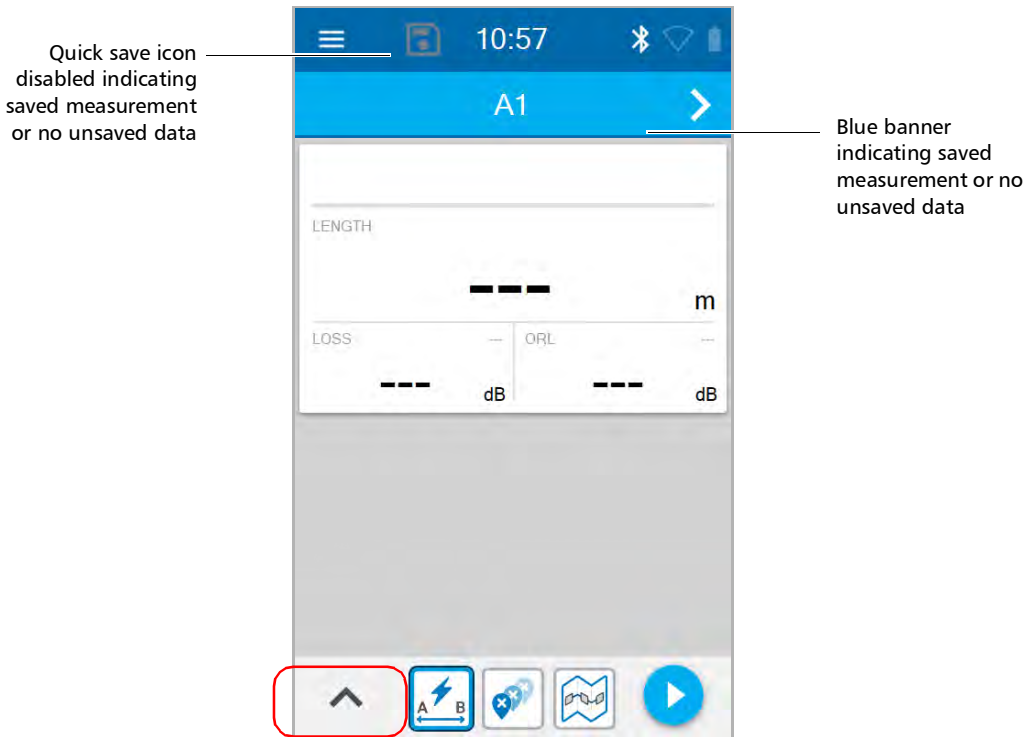



Managing Test Results

Understanding the Unit's Behavior When Saving Measurements

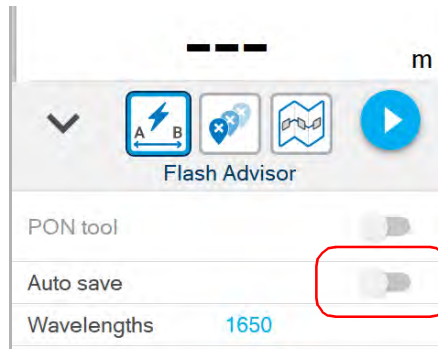
2b. If necessary, disable the feature with corresponding toggle.



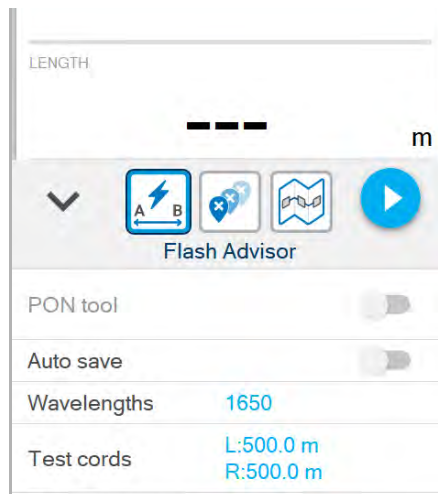

Note: When you disable the auto save, a quick save icon  appears next to the three-line menu in Fiber Xplorer.

3. Tap the  button to perform the measurement.



Managing Test Results

Understanding the Unit's Behavior When Saving Measurements

- 4. The quick save icon changes from  to  indicating that the current measurement is not saved. Also, the navigation bar changes color from blue to gray and also serves as a visual aid to remind you that the current measurement is not saved.

When you attempt to navigate to the previous or next test point, you will receive a warning message that the current measurement will be lost. Tap the quick save icon to save the current measurement.

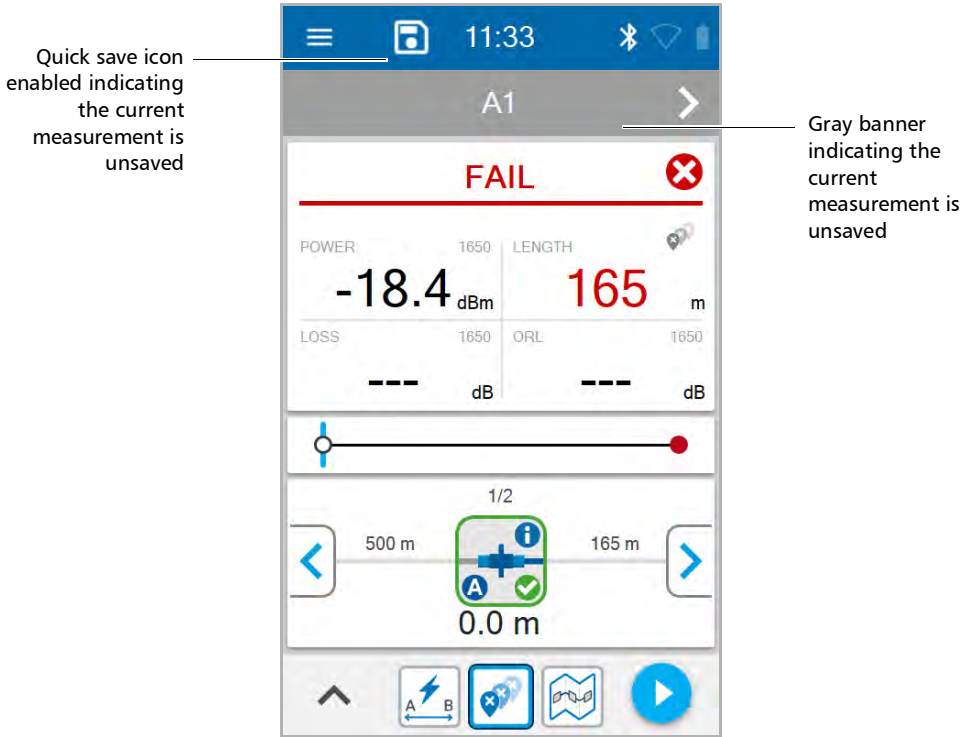

Managing Test Results

Understanding the Unit's Behavior When Saving Measurements

5. Your unit saves the measurement. The quick save icon is disabled and the navigation banner changes color from gray to blue. If you enabled auto navigation, your unit navigates to the next test point. If you disabled auto navigation, your unit stays on the current test point after saving the measurement.

Tap the  button to redo the measurement on the same test point.

OR

Tap the  button to navigate to the next test point.

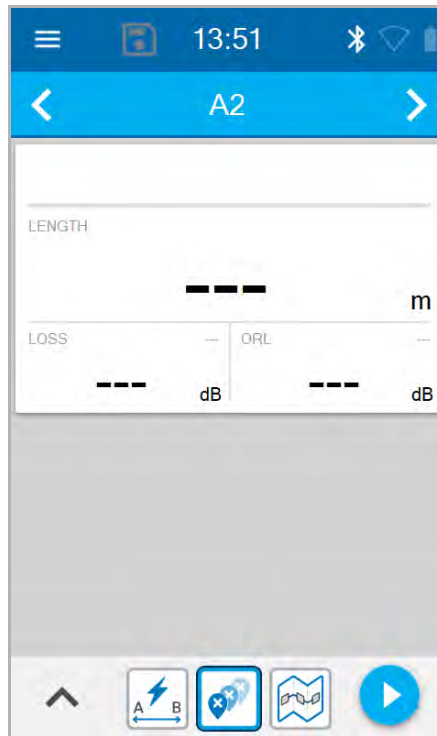

Your unit is ready for a new measurement.

Generating Measurement Reports With a Bluetooth Connection

If your unit has wireless capabilities, you can generate PDF reports with the TestFlow/Exchange mobile application.

Once the report has been generated, you can consult it right away with the viewer available on your smart device. Since the PDF is not saved on the smart device, you will need to generate the report again if you close it, unless you transfer it with your smart device.

To generate measurement reports with a wireless connection:

- 1.** Ensure that a Bluetooth connection has already been established between your unit and a smart device (see *Establishing or Closing a Connection With a Smart Device Via the Bluetooth Technology* on page 177).

As soon as a connection is established between the OX1 and a smart device, the list of results in the TestFlow/Exchange mobile application is refreshed automatically.

- 2.** On the smart device, if it is not already done, open the TestFlow/Exchange mobile application and access the Optical Explorer tool.

3. From the measurements list, tap the entry corresponding to the measurement for which you want to generate a report.

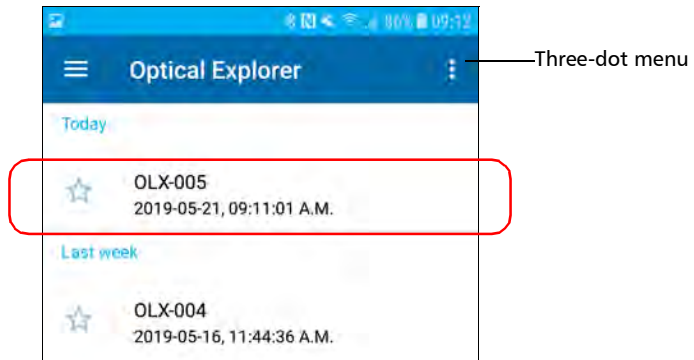

4. From the three-dot menu, select **PDF report**.

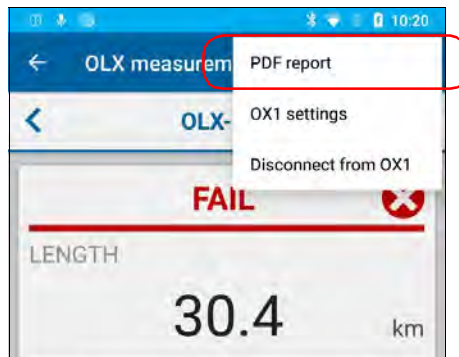

Managing Test Results

Generating Measurement Reports With a Bluetooth Connection

5. If desired, modify the report information by tapping the desired field. All the fields are editable, including the report title.

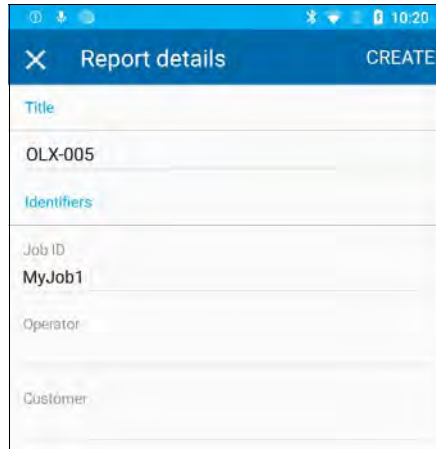

The screenshot shows a mobile application interface for creating a report. At the top, there is a blue header bar with a back arrow on the left, the text 'Report details' in the center, and a 'CREATE' button on the right. Below the header, the form contains several input fields: 'Title' with the value 'OLX-005', 'Identifiers' which is a blue link, 'Job ID' with the value 'MyJob1', 'Operator', and 'Customer'.

6. When you have finished editing the report information, tap **CREATE** to start the report creation.

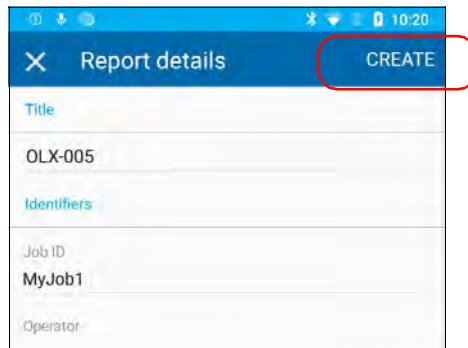

This screenshot is identical to the previous one, showing the 'Report details' form. The 'CREATE' button in the top right corner of the blue header bar is highlighted with a red circle.

Note: *As soon as the report is generated, you can transfer it with the tools available from your smart device as you would do with any other PDF file.*

Generating Measurement Reports With a USB Connection

You can transfer measurements from your unit to a PC using a USB connection. You must connect to a PC that has EXFO's FastReporter 3 that generates the reports in PDF format.

To generate measurement reports with a USB connection:

1. Using a USB cable, connect your unit to a PC that has EXFO's FastReporter 3 already installed.

Note: *Connect the USB cable directly to your unit without using a hub.*

2. If it is not already done, turn on your unit and your PC.
3. Launch FastReporter 3 on your PC.
4. From FastReporter 3, download the measurement.
5. To generate the measurement report, see EXFO's FastReporter 3 documentation for more information.

Generating Measurement Reports With a Wi-Fi Connection

If your unit has wireless capabilities, you can transfer measurements from your unit to a PC using a Wi-Fi connection. You must connect to a PC that has EXFO's FastReporter 3 that generates the reports in PDF format

This connection is possible when your unit and computer are connected to the same Wi-Fi network.

Note: *If you turn off your unit during a data transfer, the Wi-Fi connection will be interrupted, but no data will be lost.*

To generate measurement reports with a Wi-Fi connection:

- 1.** If it is not already done, turn on your unit and your PC.
- 2.** Ensure the **Wi-Fi data transfer to FR3** is enabled on your unit and that both your unit and your PC are connected to the same Wi-Fi network.. For more information, see *Enabling or Disabling the Wireless Communication* on page 181.
- 3.** Launch FastReporter 3 on your PC.
- 4.** From FastReporter 3, download the measurement.
- 5.** To generate the measurement report, see EXFO's FastReporter 3 documentation for more information.

10 Working With the TestFlow/Exchange Mobile Application

You can use your OX1 in association with a smart device equipped with the TestFlow/Exchange mobile application allowing you to document your results, archive them on a cloud server, and generate reports.

Note: *If your unit does not have wireless capabilities, you cannot work with the TestFlow/Exchange mobile application.*

Note: *In addition to all the other features explained throughout this documentation, you also have access to the features presented hereafter if you work with cloud-based jobs.*

Note: *The TestFlow/Exchange mobile application gives you access to certain features even if you do not log on to your TestFlow/Exchange mobile application account. However, to benefit from all the available features, you will need to log in. The procedures presented throughout this user documentation will indicate if a logon is required.*

Note: *Depending on the type of smart device you are using, the appearance of the Optical Explorer tool (available from the TestFlow/Exchange mobile application) may vary slightly from the illustrations presented in this documentation. Unless otherwise specified, the information applies both to the Android- and iOS-based smart devices.*

Note: *The measurement units used on your OX1 are independent from those used with TestFlow/Exchange mobile application jobs. This means that you may have to make changes to ensure consistency in the selected measurement units.*

Installing the TestFlow/Exchange Mobile Application on Your Smart Device

Before you start working, if you intend to work with cloud-based jobs and archive information on the cloud, you will need to install the TestFlow/Exchange mobile application on your smart device.

To install the TestFlow/Exchange mobile application:

1. Ensure that you have access to an Internet connection.
2. From your Android-based smart device, open the Google Play Store (usually **Play Store** or **Play** icon).

OR



From your iOS-based smart device, open the App Store (usually **App Store** icon).

3. From the Play Store or the App Store, search for *EXFO* to localize the TestFlow or Exchange mobile application.
4. Start the installation and follow the on-screen instructions.

Establishing or Closing a Connection With a Smart Device Via the Bluetooth Technology

When you want to work with the TestFlow/Exchange mobile application jobs, perform tasks such as generate reports (single or multiple measurements), or configure Wi-Fi networks to receive updates for your unit, interactions are necessary between the unit and a smart device equipped with the TestFlow/Exchange mobile application. These interactions are accomplished using the Bluetooth technology. By default, the Bluetooth communication is enabled on your unit, but if you have disabled it, you must enable it before trying to connect to a smart device (see *Enabling or Disabling the Wireless Communication* on page 181).

On your OX1 unit, the status of the Bluetooth communication is indicated with an icon in the title bar. The table below shows the possibilities.

Icon	Meaning
Not visible	The Bluetooth communication is disabled.
	The Bluetooth communication is enabled, but no connection has been established yet between the unit and a smart device.
	A connection has been established between the unit and a smart device.

If a connection has been established with a smart device already, but you wish to use your unit with another smart device, you can close the current connection directly from your unit. Similarly, if a connection exists already, but you wish to connect a smart device to another OX1 unit, you can close the connection from the smart device (Optical Explorer tool in the TestFlow/Exchange mobile application).

Working With the TestFlow/Exchange Mobile Application

Establishing or Closing a Connection With a Smart Device Via the Bluetooth Technology

To establish a connection via the Bluetooth technology:

1. If necessary, enable the Bluetooth communication on your unit (see *Enabling or Disabling the Wireless Communication* on page 181).
2. If it is not already done, install the TestFlow/Exchange mobile application on your smart device (see *Installing the TestFlow/Exchange Mobile Application on Your Smart Device* on page 176).
3. On the smart device, establish the connection as follows.
 - 3a. Open the TestFlow/Exchange mobile application.
 - 3b. If the application prompts you to sign in to a TestFlow/Exchange mobile application account, tap **NOT NOW**, since you do not need to connect to a TestFlow/Exchange mobile application account to establish the connection between your unit and a smart device.
 - 3c. Tap the three-line icon to access the main menu.

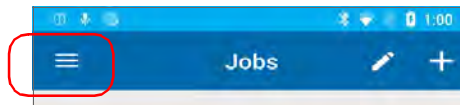

- 3d. Under **Tools**, tap **Optical Explorer**.

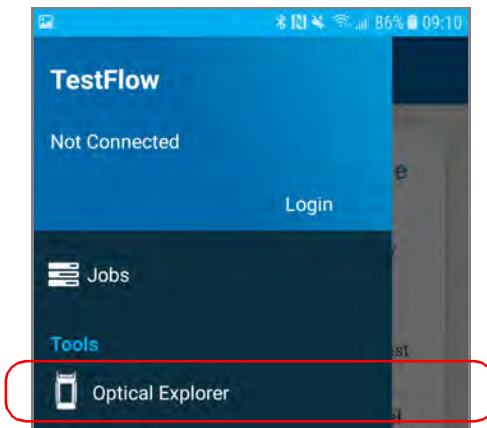

Working With the TestFlow/Exchange Mobile Application

Establishing or Closing a Connection With a Smart Device Via the Bluetooth Technology

- 3e.** If the application prompts you to authorize it to access your smart phone's location, tap **ALLOW**. Otherwise, you will not be able to access the list of OX1 units.
- 3f.** From the list of OX1 units, tap the item corresponding to the desired unit.

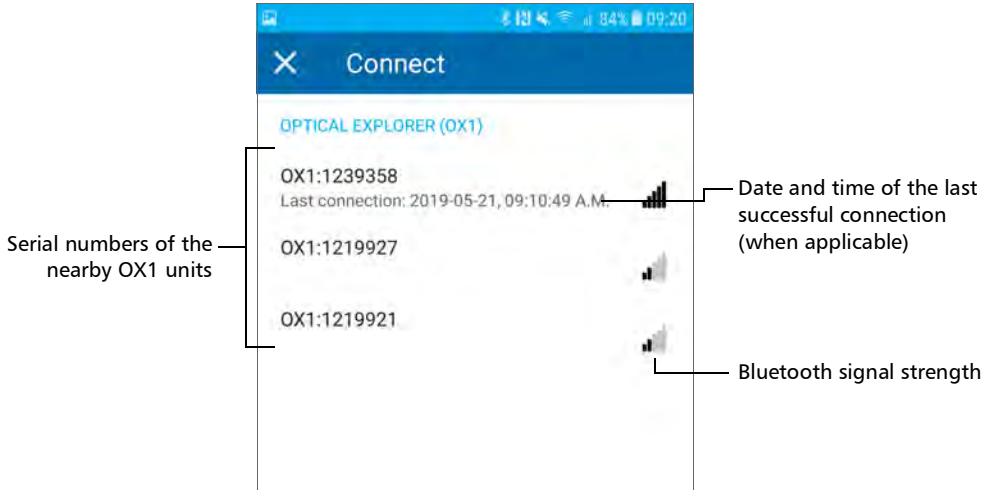

The application establishes the communication automatically. When the connection is successful, the  icon appears in the title bar of your OX1 unit.

Note: *If the OX1 unit that you want to use is already connected to another smart device, you must first close the connection between the OX1 unit and the other smart device before being able to connect to this specific OX1.*

Working With the TestFlow/Exchange Mobile Application

Establishing or Closing a Connection With a Smart Device Via the Bluetooth Technology

To close the connection with a smart device from your unit:

1. From the main menu, tap **Settings**.

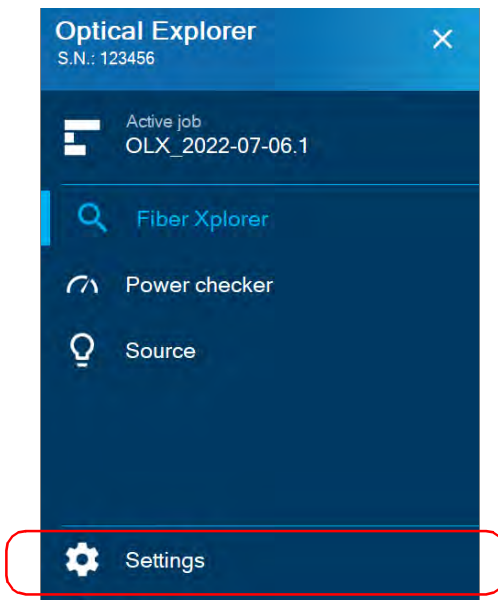

2. From the **Wireless** section, tap **Disconnect mobile app**.

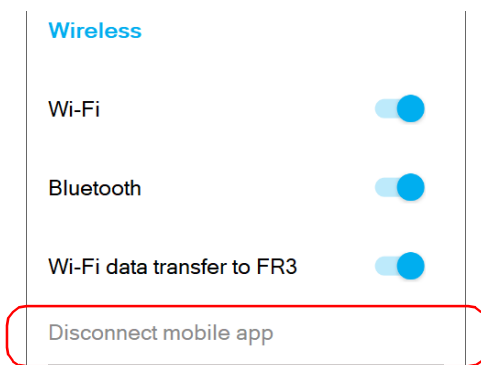

To close the connection with an OX1 from a smart device:

- 1.** From the measurements list or the measurement details page, open the three-dot menu.
- 2.** Tap **Disconnect from OX1**.

The smart device is no longer connected to the OX1 and you are ready to connect it to another unit.

Enabling or Disabling the Wireless Communication

The interactions between your unit and a smart device are accomplished using the Bluetooth technology.

The interactions between your unit and the cloud server as well as the EXFO update server (to retrieve firmware and software updates), are accomplished using a connection to a wireless network.

By default, the Bluetooth communication is enabled on your unit, but the Wi-Fi and Wi-Fi data transfer to FR3 are not.

You can enable or disable the Bluetooth communication from your unit only, and the Wi-Fi communication both from your unit and from the smart device (Optical Explorer tool in the TestFlow/Exchange mobile application).

If you do not need to connect to a wireless network for a certain period of time, you may wish to disable the Wi-Fi communication to save battery power.

Working With the TestFlow/Exchange Mobile Application

Enabling or Disabling the Wireless Communication

To enable or disable the wireless communication from your unit:

1. From the main menu, tap **Settings**.

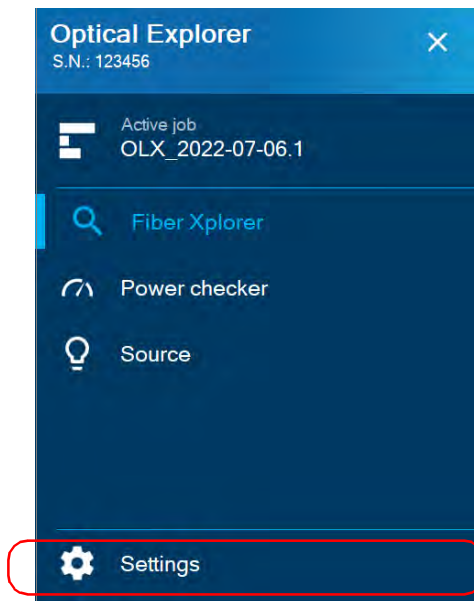

Working With the TestFlow/Exchange Mobile Application

Enabling or Disabling the Wireless Communication

2. Use the **Wi-Fi**, **Bluetooth** or **Wi-Fi data transfer to FR3** toggle to enable or disable the communication as needed.

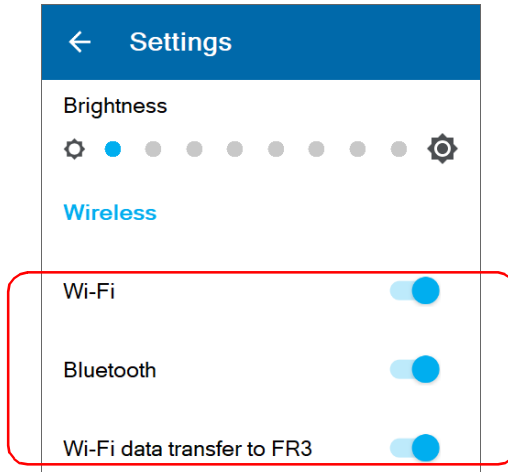

The changes are taken into account immediately.

Working With the TestFlow/Exchange Mobile Application

Enabling or Disabling the Wireless Communication

To enable or disable the Wi-Fi communication from the smart device:

1. On the smart device, open the TestFlow/Exchange mobile application and access its main menu (☰ menu).
2. Under **Tools**, tap **Optical Explorer**.

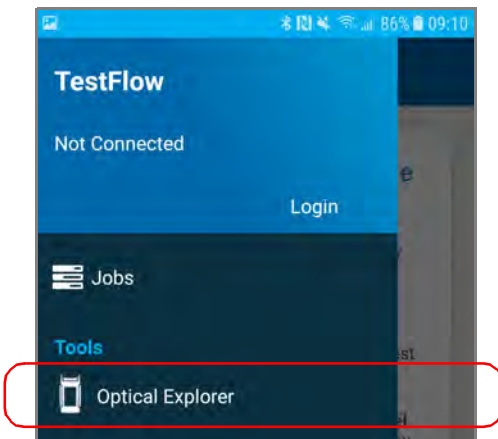

3. From the Optical Explorer tool, open the three-dot menu, and then select **OX1 settings** to access the parameters.

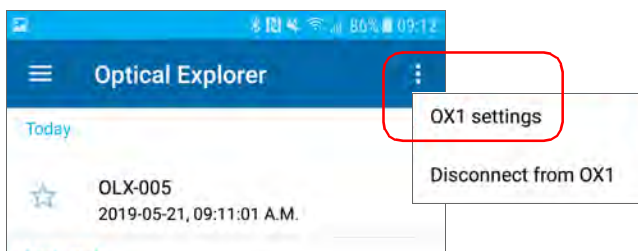

Working With the TestFlow/Exchange Mobile Application

Enabling or Disabling the Wireless Communication

4. Tap the **Wi-Fi** line.



5. Use the **OX1 Wi-Fi** toggle to enable or disable the Wi-Fi communication.



The change is taken into account immediately.

Working With a Wireless Network

By connecting your unit to a wireless network, you can fully synchronize the results and save them to the cloud server once they have been synchronized with the TestFlow/Exchange mobile application.

Also, by connecting your unit to a wireless network, you can check for updates, download these updates and install them directly on your unit (see *Upgrading Applications and Software With a Wi-Fi connection* on page 240).

By default, the Wi-Fi connection is disabled, both on the OX1 unit and in the Optical Explorer tool of the TestFlow/Exchange mobile application. You must enable it before trying to connect to a wireless network (see *Enabling or Disabling the Wireless Communication* on page 181).

Before being able to connect your unit to a Wi-Fi network, you must first configure the desired networks directly from your unit or with the TestFlow/Exchange mobile application.

Once the configuration and first connection are successful, the configured network is automatically added to the list of possible networks on your unit.

The list of configured networks as well as the last network used are kept in memory even when you turn your unit off. This means that the next time you work with your unit, it will automatically connect to the last network used, unless this network is not available or its password has changed in the meantime (reconfiguration necessary). Should a network failure occur while the unit is connected to it, the unit will try to reconnect to this network automatically as soon as it becomes available again.

You can remove configured networks from the list to prevent automatic connections to these networks. If you remove the network currently in use, the unit (or the Optical Explorer tool in the TestFlow/Exchange mobile application) will try to connect to the next configured network on the list that is available.

Your unit supports IPv4 wireless routers having the following characteristics:

- With dynamic IPv4 address assignment
- Not secured, or secured with WPA/WPA2-Personal standards (WPA-PSK/WPA2-PSK versions)
- Broadcasting their network names (SSID) or not (SSID visible or hidden)
- Configured with a 2.4 GHz Wi-Fi band (b/g/n frequencies).

Note: *Your unit does not support the WEP and WPS standards.*

Note: *Your unit does not support public Wi-Fi hotspots requiring authentication from a Web page.*



Note: *Every work environment has its own specifications. If you need information about the configuration of your router, contact your network administrator.*

Note: *To save battery power, you may wish to disable the wireless communication when you do not use it.*

Working With the TestFlow/Exchange Mobile Application

Working With a Wireless Network

The information about the Wi-Fi connection is indicated with an icon appearing both in the title bar (on your unit) and next to the name of the wireless networks (on your unit and in the TestFlow/Exchange mobile application). The table below shows the possibilities.

Icon	Meaning
No Wi-Fi icon visible in the title bar	The Wi-Fi communication is disabled.
Faint Wi-Fi icon visible in the title bar 	The Bluetooth communication is enabled, but the unit is not connected to any wireless network.
	The portion of the icon that appears in white (title bar) or in dark gray (list of wireless networks) reflects the strength of the signal.
	Password-protected (secured) networks are identified by a lock.

Configuring a Wireless Network

Before being able to connect your unit to a Wi-Fi network, you must first configure the desired networks directly on your unit or with the TestFlow/Exchange mobile application. Once the configuration and first connection are successful, the configured network is automatically added to the list of possible networks on your unit.

The list of configured networks as well as the last network used are kept in memory for future use even when you turn your unit off.

To configure a wireless network directly from your unit:

1. From the main menu, tap **Settings**.

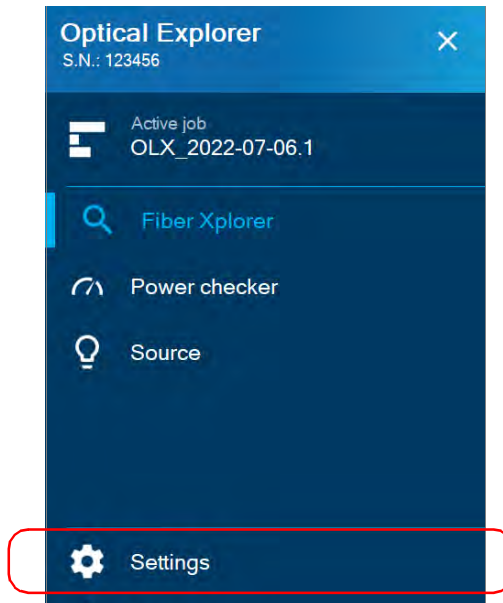

Working With the TestFlow/Exchange Mobile Application

Working With a Wireless Network

2. If it is not already done, enable the Wi-Fi communication on your unit using the corresponding toggle.

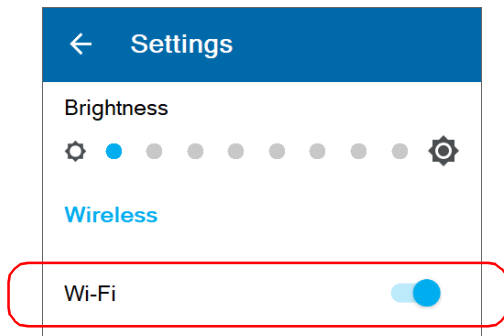

3. Tap **Wi-Fi**.
4. Under **Available networks**, tap the item corresponding to the wireless network that you want to configure.

Note: *No garbage can icon appears next to the networks that have not been configured yet.*

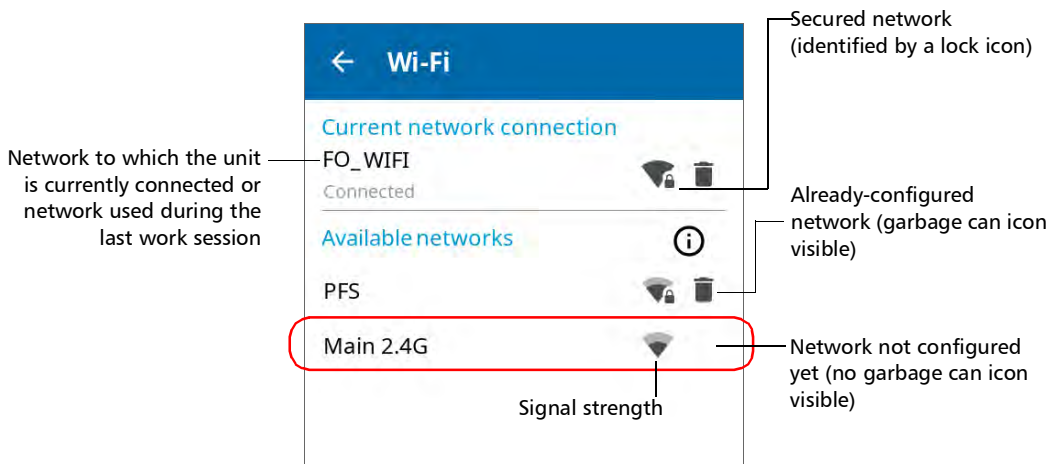

5. If the network is protected by a network security key (password), enter it.

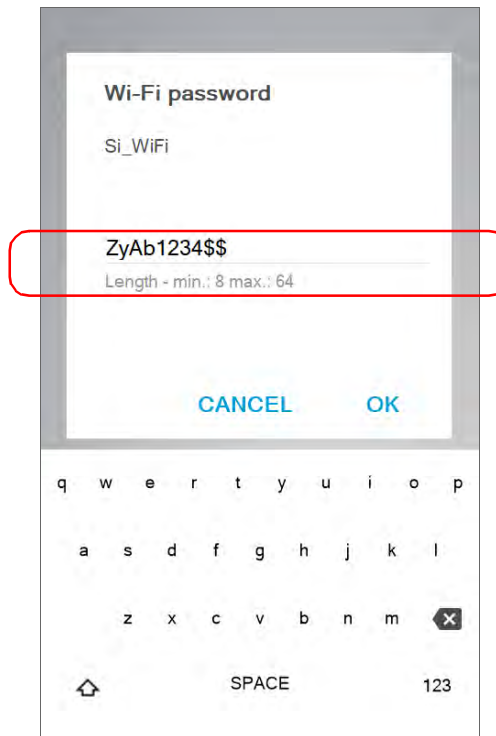

The application establishes the communication automatically.

Working With the TestFlow/Exchange Mobile Application

Working With a Wireless Network

To configure a wireless network with the TestFlow/Exchange mobile application:

1. Ensure that a Bluetooth connection has already been established between your unit and a smart device (see *Establishing or Closing a Connection With a Smart Device Via the Bluetooth Technology* on page 177).
2. If necessary, enable the Wi-Fi communication on your unit (see *Enabling or Disabling the Wireless Communication* on page 181).
3. On the smart device, open the TestFlow/Exchange mobile application and access its main menu (☰ menu).
4. Under **Tools**, tap **Optical Explorer**.

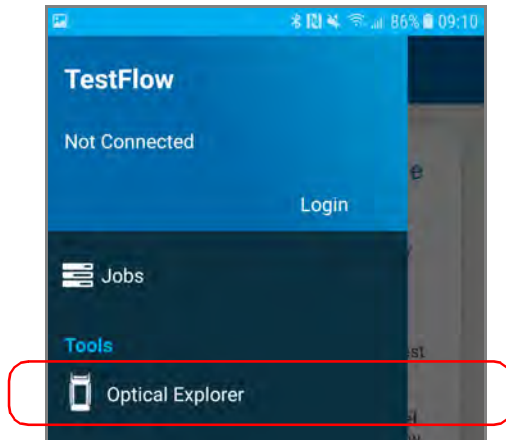

Working With the TestFlow/Exchange Mobile Application

Working With a Wireless Network

- From the Optical Explorer tool, open the three-dot menu, and then select **OX1 settings** to access the parameters.

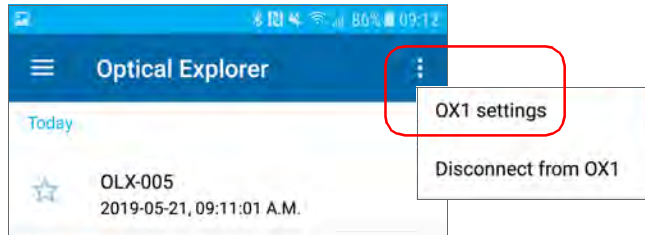

- Tap the **Wi-Fi** line.

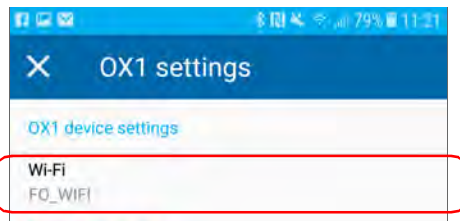

- Tap the item corresponding to the wireless network that you want to configure.

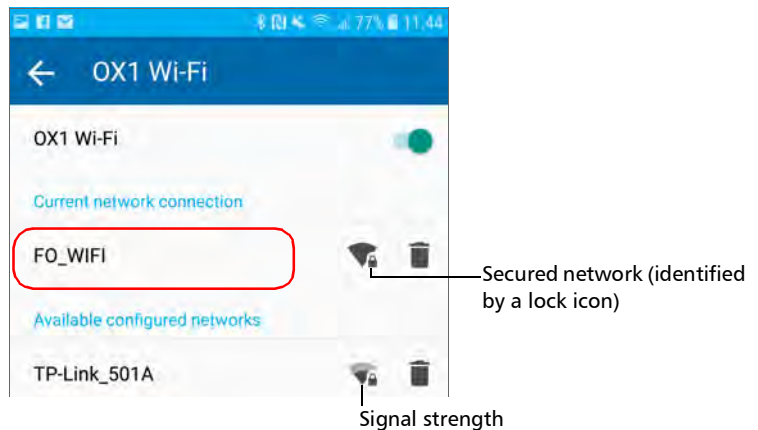

Working With the TestFlow/Exchange Mobile Application

Working With a Wireless Network

8. If the network is protected by a network security key (password), enter it.

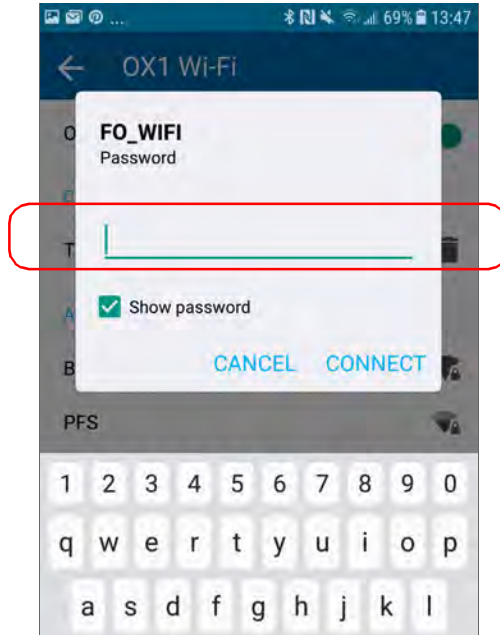

9. Tap **CONNECT**.
10. Follow the on-screen instructions.

The application establishes the communication automatically.

Note: *You may want to ensure that the TestFlow/Exchange mobile application has been able to establish a first connection with the Wi-Fi network before attempting to connect to this network from your OX1 unit. This is particularly useful in the case of secured networks to ensure that the provided password is good.*

Connecting to a Wireless Network From Your Unit

When you start a new work session with your unit, it will automatically connect to the last network used, unless this network is not available or its password has changed in the meantime (reconfiguration necessary). Should a network failure occur while the unit is connected to it, the unit will try to reconnect to this network automatically as soon as it becomes available again.

To connect to a wireless network from your unit:

1. Ensure that a connection has already been established between your unit and a smart device via the Bluetooth technology (see *Working With a Wireless Network* on page 186).
2. From the main menu, tap **Settings**.

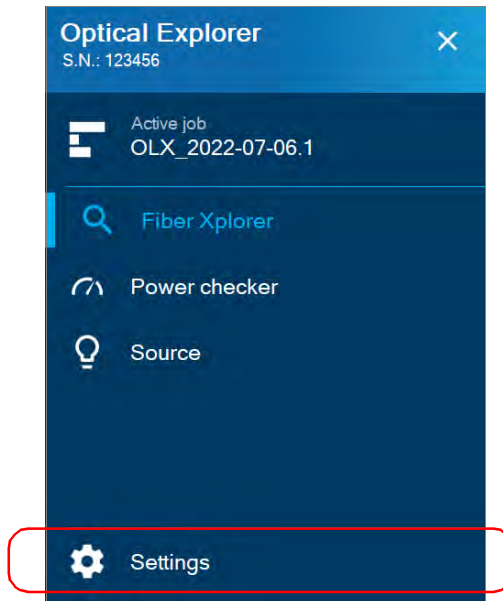

Working With the TestFlow/Exchange Mobile Application

Working With a Wireless Network

3. If it is not already done, enable the Wi-Fi communication on your unit using the corresponding toggle.

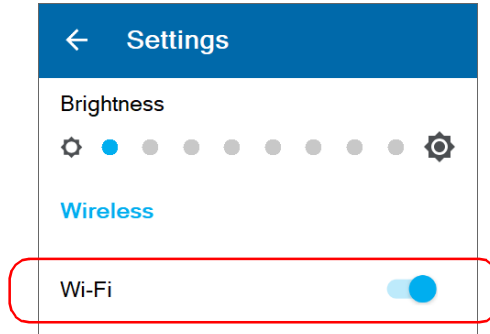

4. Tap **Wi-Fi**.
5. Under **Available networks**, tap the item corresponding to the wireless network to which you want to connect.

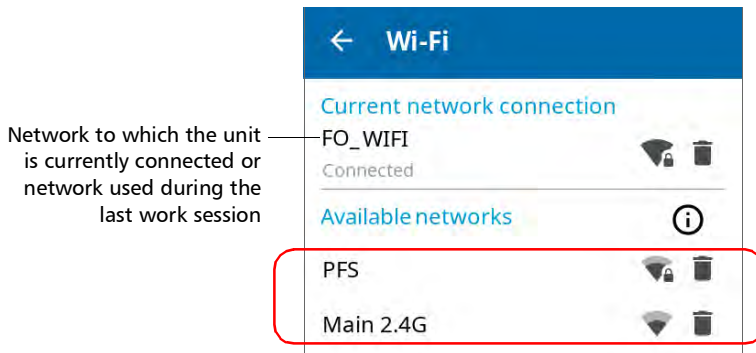

The application establishes the communication automatically.

Note: *If you select a network different than the one used during your last work session and the connection to this new network fails, the application will automatically switch to the last network used to try and establish a connection.*

Removing Configured Networks From the List

You can remove configured networks from the list to prevent automatic connections to these networks (forget network feature). If you remove the network currently in use, the unit (or the TestFlow/Exchange mobile application) will try to connect to the next configured network on the list that is available.

On your unit, removed networks are no longer visible unless you reconfigure these networks (from your unit or the TestFlow/Exchange mobile application). If these networks are still in range, they will reappear on the list of available networks as if they have never been configured before. This means that for secured networks, their passwords will need to be re-entered if you decide to reconfigure these networks.

Working With the TestFlow/Exchange Mobile Application

Working With a Wireless Network

To remove a configured network from the list:

1. From your unit or from the Optical Explorer tool in the TestFlow/Exchange mobile application, go to the main menu, and then tap **Settings** (from the unit) or **OX1 settings** (from the TestFlow/Exchange mobile application).

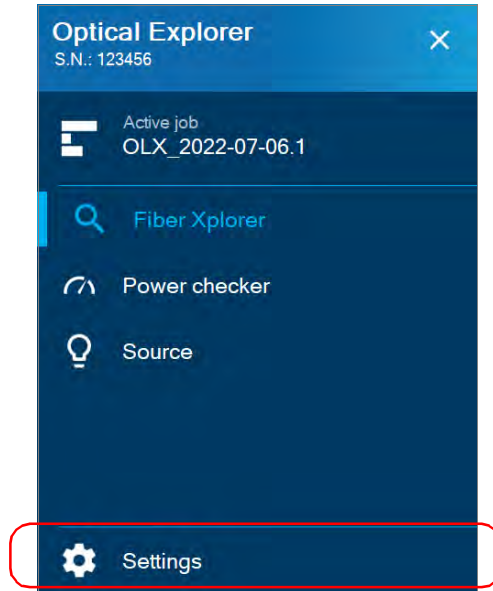

Note: *In the Optical Explorer tool (in the TestFlow/Exchange mobile application), the main menu is accessible by opening the three-dot menu.*

2. Tap **Wi-Fi**.

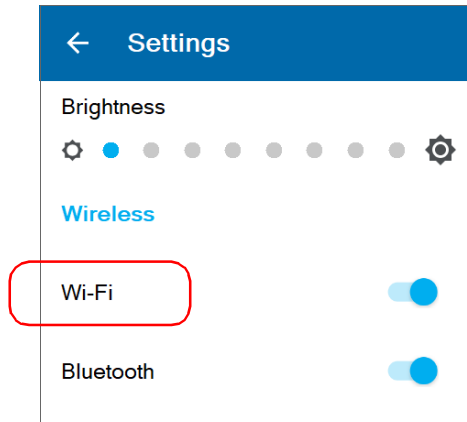

3. Tap the  icon corresponding to the wireless network that you want to remove.

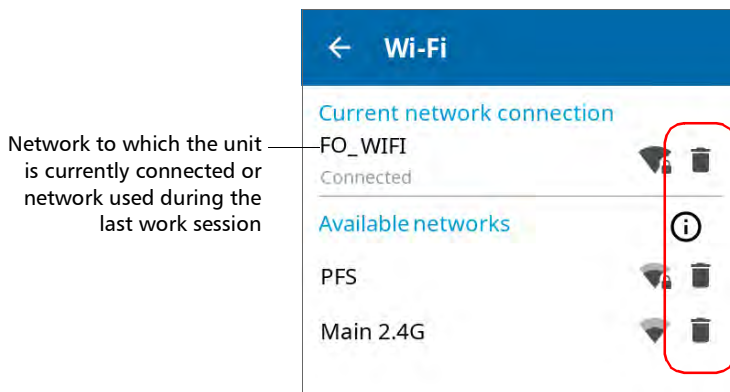

4. When the application prompts you to confirm the removal of the network, confirm by tapping **Forget**.

The network is removed from the list automatically.

If these networks are still in range, they will reappear on the list of available networks.

Transferring a Cloud-Based Job to the OX1

Once you have created a cloud-based job or someone from your organization has created one and has assigned it to you, you have to synchronize the job with your OX1 to be able to perform the associated tests. The transfer is done via Bluetooth.

You can retrieve a brand new job from the TestFlow/Exchange mobile application. You can also resume a job that has already been started by someone else on another unit and transfer it to the OX1 you are using for your tests.

Note: *No results are erased from your OX1 when you switch between jobs.*

As soon as the TestFlow/Exchange mobile application retrieves a job, it is set as the active job even if there was already a job underway. The results of the tests in the job that was already started are kept in memory and you will be able to synchronize them with the TestFlow/Exchange mobile application later. To do so, you will have to set the job as active again to be able to perform the synchronization process. When the active job changes, the tests that have not been performed yet on the previous job will be available the next time you switch back to this job.

Note: *You can only synchronize one job at a time.*

To transfer a cloud-based job to the OX1:

1. Before being able to retrieve a job from the cloud to transfer it to your OX1, ensure that you meet the following requirements:
 - you have a TestFlow/Exchange mobile application account or you have received an invitation from your organization to activate your account
 - you have installed the TestFlow or Exchange mobile application on your smart device and logged on to your TestFlow or Exchange mobile application account (see *Installing the TestFlow/Exchange Mobile Application on Your Smart Device* on page 176)
 - you have created a job (directly from the TestFlow/Exchange mobile application or someone from your organization has created one on the cloud server and has assigned it to you)

Note: *If you have created a job from the cloud server, transfer it to the TestFlow/Exchange mobile application.*

- you have configured a Wi-Fi network (see *Working With a Wireless Network* on page 186)
- you have established a connection, via Bluetooth, between your smart device and the OX1 (see *Establishing or Closing a Connection With a Smart Device Via the Bluetooth Technology* on page 177 for details)

Working With the TestFlow/Exchange Mobile Application

Transferring a Cloud-Based Job to the OX1

2. In the TestFlow/Exchange mobile application, tap the row corresponding to the job you want to transfer to your OX1.
3. Once you are in a job, tap one of the empty bubbles corresponding to a test.

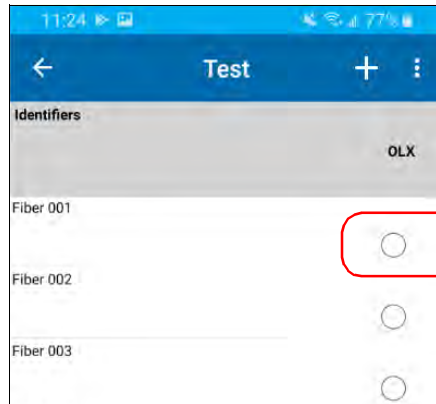

4. When the unit prompts you, tap **Sync**.

Note: *If you are not already connected to an OX1 unit, the application will prompt you to select the unit you want to use.*

Note: *You can also access the job sync feature from the three-dot menu.*

Working With the TestFlow/Exchange Mobile Application

Transferring a Cloud-Based Job to the OX1

5. In the OX1, from the main menu, tap the name of the job you have just transferred.

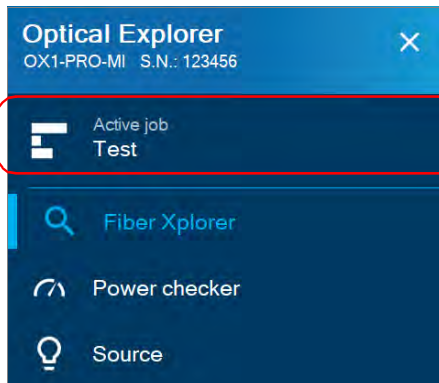

6. Tap the blue arrow to access the list of test points.

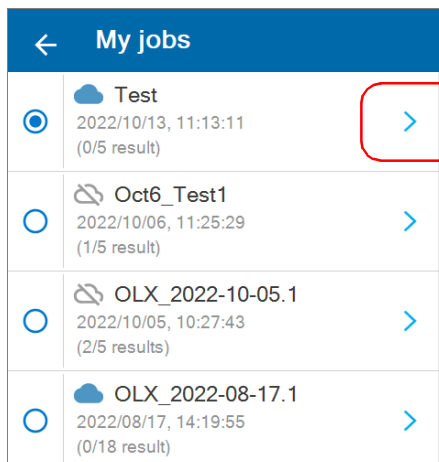

7. Tap the test point you want to perform.

You are now ready to perform the tests in a job (see *Performing Measurements* on page 128 for details).

Performing a Measurement Again

All measurements are performed the same way either you are using your OX1 with or without a cloud-based job. See *Performing Measurements* on page 128.

However, you can redo a measurement that has already been taken in a job.

Note: *When a measurement is underway, the navigation arrows are disabled and you cannot browse through the measurements you have already performed.*



IMPORTANT

Once you redo an existing measurement, the previous result is deleted. Only the new result will be available when the measurement is complete.

To perform a measurement again:

1. Select the measurement you want to perform again.

2. Tap the  button to redo the measurement.

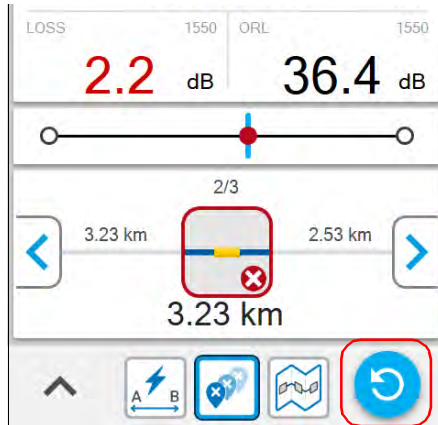

3. When the unit prompts you, tap **YES**.

The new result is available as soon as the measurement is complete.

Once a measurement is performed, you can view the results in different parts of the screen. See *Working With Link Results* on page 133, *Working With Link Overview* on page 135, and *Working With Link View* on page 136.

Synchronizing Job Results With the Smart Device and the Cloud Server

The TestFlow/Exchange mobile application manages the measurements associated with jobs automatically for you.

The synchronization of the results is done in two steps. You can start the synchronization process as soon as a Bluetooth connection is established between your unit and the smart device. Test results are sent to the mobile application to allow report creation without filling the smart device's memory. By sending the results to the TestFlow/Exchange mobile application, you can synchronize the entire job or the tests already done in a job. This way, you can resume a job that has already been started by someone else on another unit and transfer it to the OX1 you are using for your tests. You cannot view the details for the tests already completed and transferred to another unit.

There are two different types of data that can be synchronized between your unit and the cloud server. The table below shows the differences between complete and summary data.





Data	Characteristics
Summary	<ul style="list-style-type: none">➤ Test name (identifiers)➤ Test verdict (pass/fail status or EXFO Advisor™ verdict)➤ Time and date of the test
Complete	The summary data and the results your unit displays in Fiber Xplorer

The complete test results data will be sent automatically from your unit to the cloud server via a Wi-Fi for results that have summary data already synchronized with the cloud server.

Working With the TestFlow/Exchange Mobile Application

Synchronizing Job Results With the Smart Device and the Cloud Server

The cloud icon next to the job name indicates the current synchronization status of each job with the cloud server. The table below shows the different possible synchronization statuses and their respective meanings.

Icon	Meaning
	The job is fully synchronized with the cloud server. This icon also displays for jobs without any saved measurement.
	The summary data of all results in the job is synchronized with the cloud server.
	The job is partially synchronized with the cloud server.
	There are no results that have synchronized summary data with the cloud server.

When a synchronization is in progress with the smart device or the cloud server, no data is lost if the battery level of the unit is too low or your OX1 is disconnected from the Wi-Fi network. The synchronization process resumes once the OX1 is connected to a power outlet and a Wi-Fi connection is established.

Working With the TestFlow/Exchange Mobile Application

Synchronizing Job Results With the Smart Device and the Cloud Server

To synchronize job results with the smart device and the cloud server:

1. Ensure that a Bluetooth connection has already been established between your unit and a smart device (see *Establishing or Closing a Connection With a Smart Device Via the Bluetooth Technology* on page 177).

As soon as a connection is established between the OX1 and a smart device, the list of results in the TestFlow/Exchange mobile application is refreshed automatically.

2. If necessary, enable the Wi-Fi communication on your unit (see *Enabling or Disabling the Wireless Communication* on page 181).
3. On the smart device, open the TestFlow/Exchange mobile application and access the Optical Explorer tool.
4. Tap the job you want to synchronize with the cloud server.
5. Once you are in a job, tap one of the bubbles corresponding to a test.
6. When the unit prompts you, tap **Sync**.

Note: *If you are not already connected to an OX1 unit, the application will prompt you to select the unit you want to use.*

Note: *You can also access the job sync feature from the three-dot menu.*

Generating Job Measurement Reports

You can generate PDF reports with the TestFlow/Exchange mobile application.

Once the report has been generated, you can consult it right away with the viewer available on your smart device. Since the PDF is not saved on the smart device, you will need to generate the report again if you close it, unless you transfer it with your smart device.

It is possible to generate single- or multi-measurement reports with the TestFlow/Exchange mobile application.

To generate job measurement reports:

- 1.** Ensure that a Bluetooth connection has already been established between your unit and a smart device (see *Establishing or Closing a Connection With a Smart Device Via the Bluetooth Technology* on page 177).

As soon as a connection is established between the OX1 and a smart device, the list of results in the TestFlow/Exchange mobile application is refreshed automatically.

- 2.** On the smart device, if it is not already done, open the TestFlow/Exchange mobile application.

Working With the TestFlow/Exchange Mobile Application

Generating Job Measurement Reports

3. Under **Tools**, tap **Optical Explorer**.

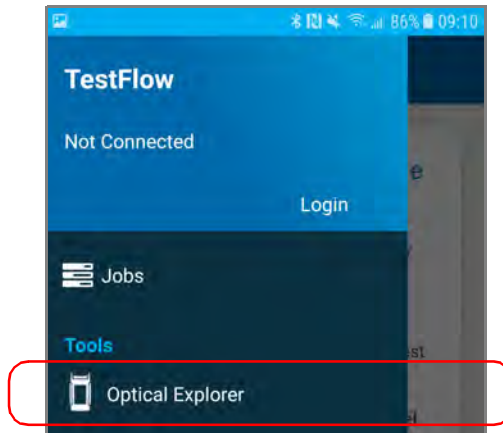

4. Select the job for which you want to generate single- or multi-measurement reports.
5. If you want to generate a single-measurement report, tap the desired measurement.

OR

If you want to generate a multi-measurement report, tap the three-dot menu.

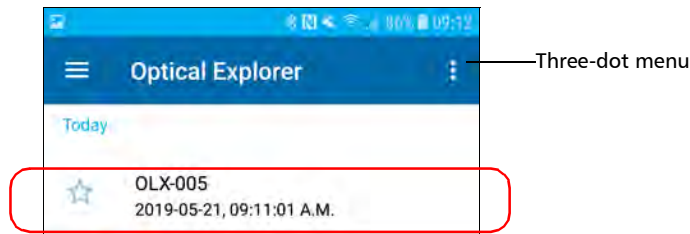

6. Select **PDF report**.

Note: *As soon as the report is generated, you can transfer it with the tools available from your smart device as you would do with any other PDF file.*

Accessing the Online Documentation From the Smart Device

You can access the getting started guide from your unit.

For more detailed information, you can also access the user guide at all times from your smart device:

- by scanning the QR code displayed on your unit
- by using the corresponding link in the TestFlow/Exchange mobile application

To view the user documentation from the TestFlow/Exchange mobile application:

1. If it is not already done, establish a connection between your unit and a smart device (see *Establishing or Closing a Connection With a Smart Device Via the Bluetooth Technology* on page 177).
2. If it is not already done, on the smart device, open the TestFlow/Exchange mobile application and access its main menu ( menu).
3. Under **Tools**, tap **Optical Explorer**.

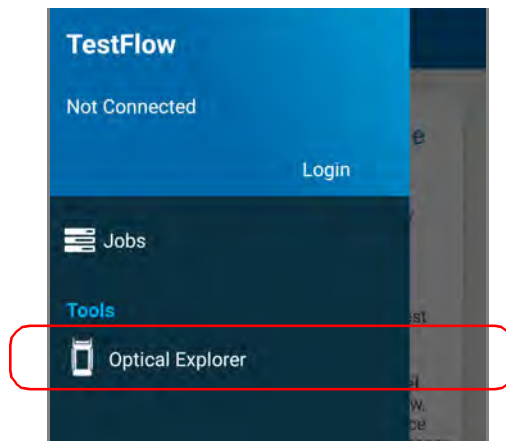

Working With the TestFlow/Exchange Mobile Application

Accessing the Online Documentation From the Smart Device

4. From the Optical Explorer tool, open the three-dot menu, and then select **OX1 settings** to access the parameters.

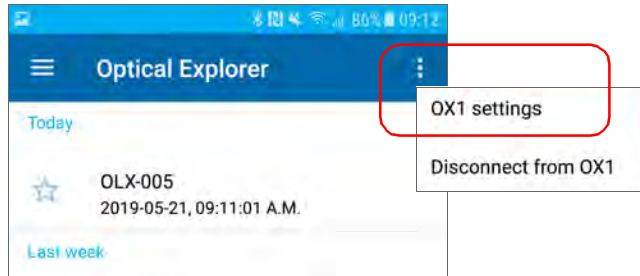

5. Under **Help**, tap **OX1 user guide**.

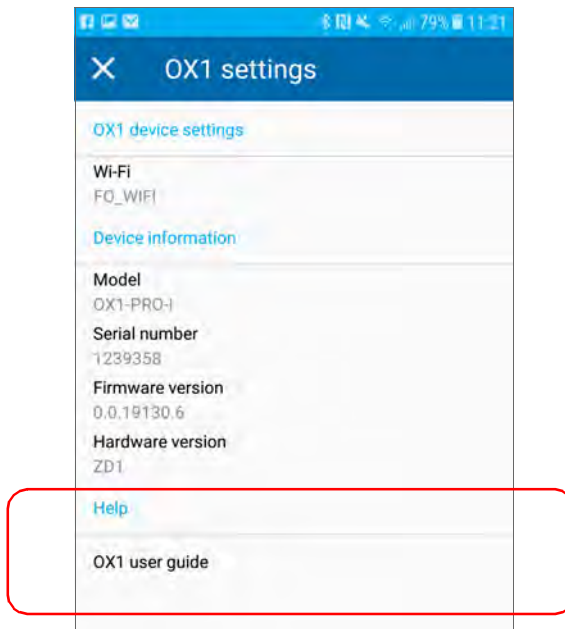

11 Maintenance

To help ensure long, trouble-free operation:

- Always inspect fiber-optic connectors before using them and clean them if necessary.
- Keep the unit free of dust.
- Clean the unit casing and front panel with a cloth slightly dampened with water.
- Store unit at room temperature in a clean and dry area. Keep the unit out of direct sunlight.
- Avoid high humidity or significant temperature fluctuations.
- Avoid unnecessary shocks and vibrations.
- If any liquids are spilled on or into the unit, turn off the power immediately, disconnect from any external power source, remove the batteries and let the unit dry completely.



WARNING

The use of controls, adjustments and procedures, namely for operation and maintenance, other than those specified herein may result in hazardous radiation exposure or impair the protection provided by this unit.

Cleaning SC Connectors

Your unit is equipped with an SC connector that can be cleaned using a mechanical cleaner.



WARNING

Verifying the surface of the connector with a fiber-optic microscope **WHILE THE UNIT IS ACTIVE** will result in permanent eye damage.

To clean a connector using a mechanical cleaner:

1. Insert the cleaning tip into the optical adapter, and push the outer shell into the cleaner.

Note: *The cleaner makes a clicking sound to indicate that the cleaning is done.*

2. Verify connector surface with a fiber inspection probe (for example, EXFO's FIP).

Cleaning the Touchscreen

Clean the touchscreen with a soft, non-abrasive cloth, such as one used for cleaning reading glasses, dampened with water.



CAUTION

Using anything else than water can damage the special coating of the touchscreen.

Recharging the Battery

Your unit uses one smart lithium-ion (Li-ion) or one lithium-polymer (Li-Po) battery.

- The charge status is shown in the upper right corner of the title bar. A red icon indicates that the battery level is running low and that you should connect the unit to a power outlet. For more information, see *Battery Status Icon Description* on page 8.
- The unit also indicates the charge status with the LED on its front panel (see *LED Indicator Description* on page 7).



CAUTION

Only charge the battery with the USB power adapter provided by EXFO with your unit.

Maintenance

Recharging the Battery



IMPORTANT

- ▶ The battery is not charged at the factory. You must fully charge it before using the unit for the first time. The battery is fully charged after a few hours or when the battery LED indicator is steady blue.
- ▶ The time required to charge the battery depends on various factors such as the type of tests currently performed and the ambient temperature.
- ▶ To ensure that the battery functions properly, keep it in temperatures between $-10\text{ }^{\circ}\text{C}$ and $45\text{ }^{\circ}\text{C}$ ($14\text{ }^{\circ}\text{F}$ and $113\text{ }^{\circ}\text{F}$). Store it between $10\text{ }^{\circ}\text{C}$ to $35\text{ }^{\circ}\text{C}$ ($50\text{ }^{\circ}\text{F}$ to $95\text{ }^{\circ}\text{F}$).
When the ambient temperature is below $0\text{ }^{\circ}\text{C}$ ($32\text{ }^{\circ}\text{F}$) or when it reaches or exceeds about $40\text{ }^{\circ}\text{C}$ ($104\text{ }^{\circ}\text{F}$), the battery can either charge more slowly than usual, or not charge at all, depending on the internal temperature of your unit.
- ▶ Do not leave a battery discharged for several days.
- ▶ After 300 cycles (approximately 18 months of use), you may want to replace the battery with a new one to maintain optimal operation conditions. Otherwise, the operating time might be reduced.



IMPORTANT

- If you need to store the unit (or a battery) for an extended period of time, ensure that the battery is charged at around 50 % of its capacity, and then turn the unit off (shutdown).
- Place the unit (or the battery) in a cool dry place, and ensure that the battery is charged at around 50 % of its capacity. Every three months during the storage period, verify the battery level. Recharge the battery when necessary, so that its charge level remains around 50 % of the total capacity. This will ensure that you get the optimum performance out of the battery.

To recharge the battery:

Connect the unit to a power outlet using the USB power adapter (fastest way to charge the battery).

Note: *The standard USB ports of a computer cannot power your unit or charge its battery while the unit is on. If you connect your unit to such a USB port with the USB cable, the unit will still consume battery power. If the unit is off when you connect it to the USB port of a computer, its battery could charge, but slowly.*

Note: *If you have a vehicle equipped with dedicated USB charging ports, you could connect your unit to one of these ports to charge the battery. The actual results will vary with each vehicle. You could also use a certified USB power bank (portable charger) to charge your unit.*

The charge cycle will start and end automatically.

Note: *The clock battery also recharges when the unit is connected to an external power source if the unit is on or in sleep mode.*

Battery Maintenance Recommendations



WARNING

Your unit uses the following type of batteries: one smart lithium-ion (Li-ion) or one lithium-polymer (Li-Po).

These are batteries with built-in protection that have been especially designed for EXFO. For this reason, you can only replace them with EXFO-approved batteries of the same type and model.



WARNING

The use of unapproved batteries may result in the batteries expanding or igniting (that is, catching fire).



WARNING

Risk of explosion if battery is replaced by an incorrect type. Dispose of used batteries according to the manufacturer's instructions.



WARNING

Do not throw batteries into fire or water and do not short-circuit their electrical contacts. Do not disassemble.



IMPORTANT

Recycle or dispose of used batteries properly, in accordance with local regulations. Do not dispose of them in ordinary garbage receptacles. For more information, see the section about recycling and disposal in this user documentation.

- At EXFO, we take the safety of our customers very seriously and want to make sure any battery replacement is done properly.

The batteries of all EXFO-branded products are tested, certified, and in compliance with these international safety standards:

- United Nations (UN) Transport Regulations UN38.3: Covers battery safety during air transport.
- UL 61010-1, CAN/CSA C22.2 61010-1 and International Standard IEC/EN 61010-1: Covers the use of batteries for test and measurement equipment.
- International Standard IEC 62133: Covers secondary cells and batteries containing alkaline or other non-acid electrolytes.
- In some countries, when required, EXFO-approved batteries have been certified and are marked as per local regulation.
- To get pricing and correct part number for replacement batteries for your products, please contact (via email):
 - For Americas: Isales.us@exfo.com
 - For Europe: Isales.emea@exfo.com
 - For APAC: Isales.apac@exfo.com
 - For China: Isales.China@exfo.com
- You may also obtain replacement batteries for your products by contacting your local distributor:
<https://www.exfo.com/en/how-to-buy/find-distributor>
- You may return your unit for service at your local service center:
<https://www.exfo.com/en/services/field-network-testing/exfo-service-centers/>

Replacing the Battery

Your unit can be powered either by battery or from an appropriate power outlet when used with the provided USB power adapter.

Note: *You cannot replace the clock battery yourself.*

For more information on the available power sources for your unit, as well as their characteristics, refer to the *Technical Specifications* of your product.



CAUTION

Electrostatic discharge (ESD) damage can cause complete or intermittent equipment failures.

- Always use an ESD-preventive wrist or ankle strap when replacing the battery. Ensure that the antistatic strap makes good skin contact and that the end of its wire is grounded properly.
- Never touch any component inside the unit other than those identified in the procedure hereafter, either with tools or your fingers.

To replace the battery:

1. Turn off the unit (shutdown) and disconnect the fiber and USB cable (if applicable).
2. Position the unit so that its front panel rests on a flat surface such as a table.
3. On the back of the unit, using a 2.5 mm hex socket screwdriver, turn the screws (4) counterclockwise until they are loose, and remove them.

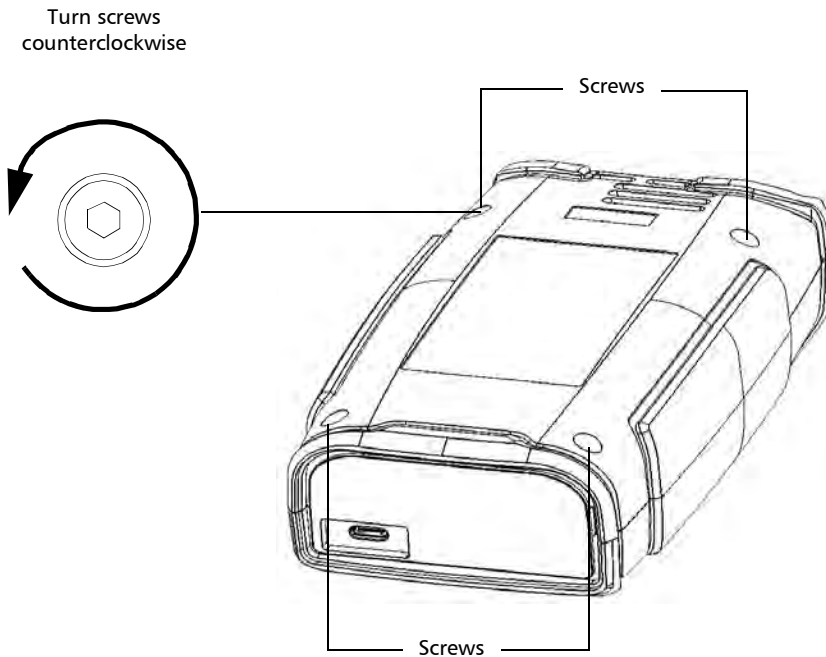

Maintenance

Replacing the Battery

4. Hold the back panel by its sides and pull it up to remove it.

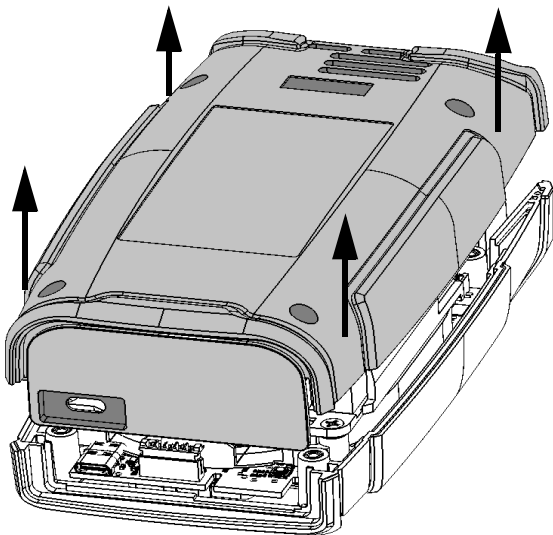

5. Gently pull on the battery's connector to disconnect it from its socket.

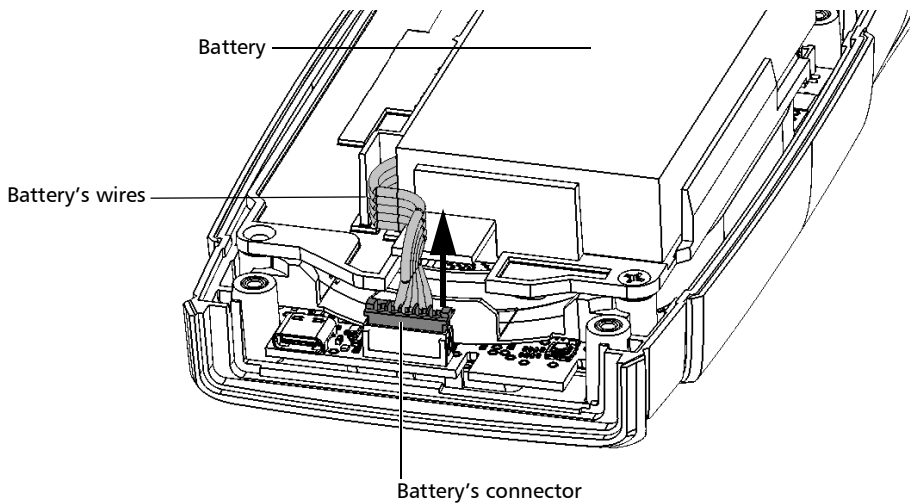

6. Pull the battery up to remove it.

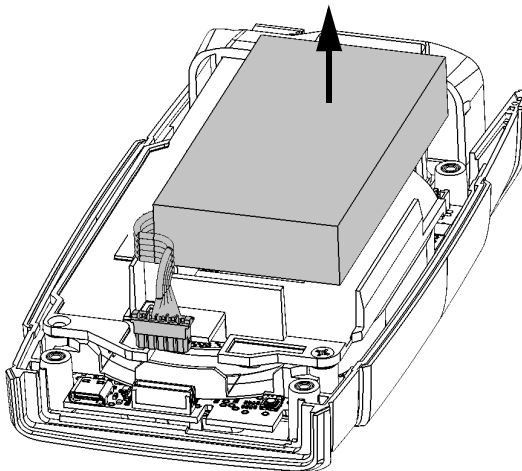

7. Place the new battery so that its wires are located on the left side, toward the front.

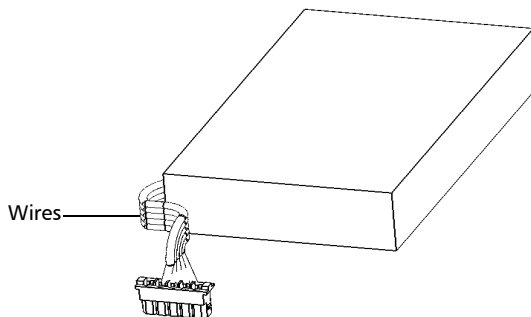

Maintenance

Replacing the Battery

8. Push the new battery toward the bottom of the case until it stops.

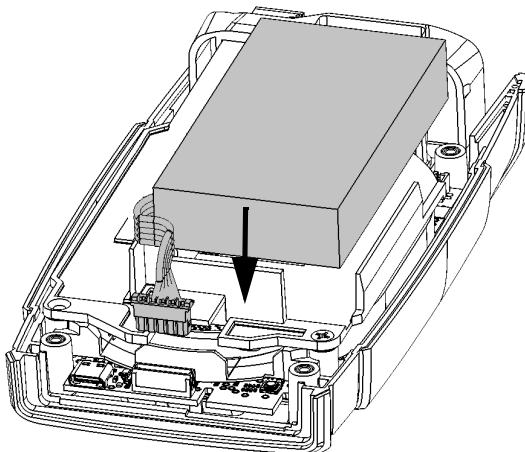

9. Ensure that the battery's wires are *above* the plastic tab (not under), and then connect the battery's connector to the corresponding socket.

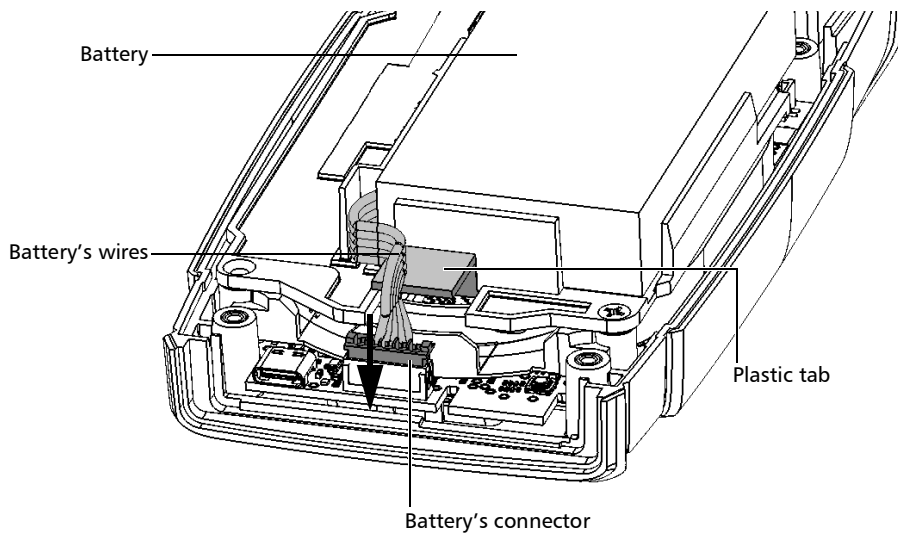

- 10.** Place the back panel on the unit, making sure that it is aligned properly with the front of the unit. The sides of the back panel should be flush with those of the front. There should be no gap between the back panel and the front of the unit. If necessary, slightly move the back panel until alignment is correct.

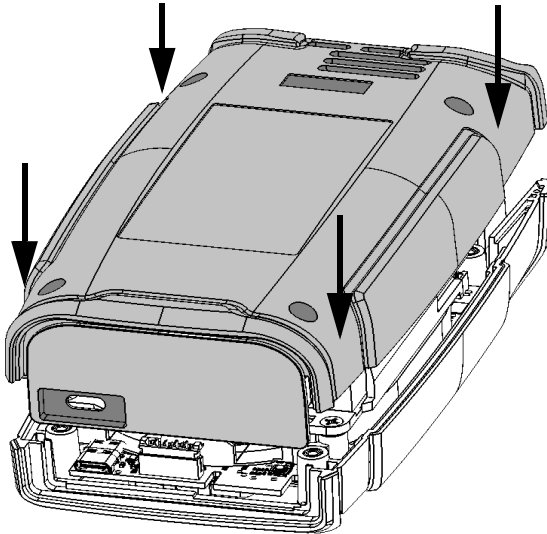

- 11.** Using a 2.5 mm hex socket screwdriver, turn the screws (4) clockwise until they are tightened.

This will secure the back panel into place.



IMPORTANT

To allow the unit to take into account the new battery, reset the battery information as explained hereafter.

Maintenance

Replacing the Battery

12. Reset the battery information as follows:

12a. Connect the unit to a power outlet using the USB power adapter.

12b. Turn on your unit.

12c. From the main menu, go to **Settings** > **Reset options**.

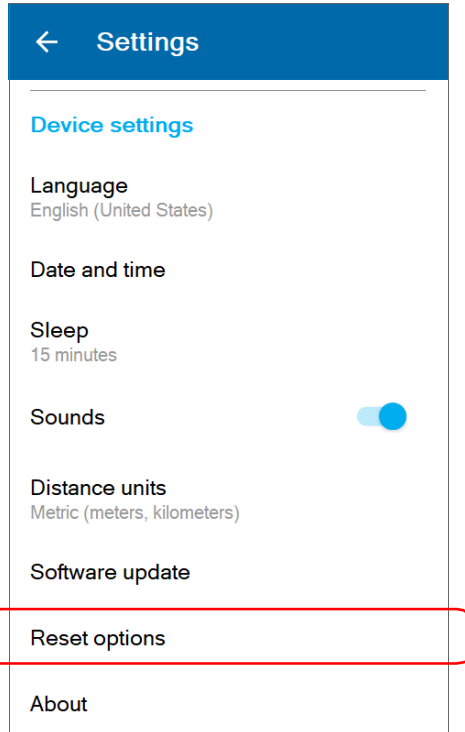

12d. Tap **Reset battery info**.

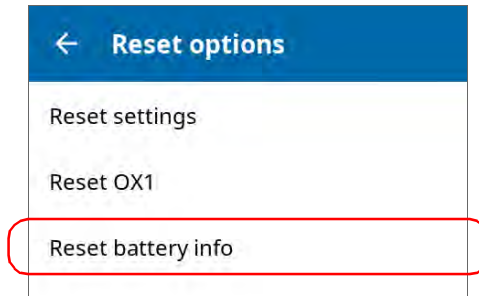

12e. When your unit prompts you, confirm the operation.



IMPORTANT

- If the unit's LED turns to red when you turn on the unit, simply connect the unit to a power outlet and let the new battery charge for a few minutes.
- It could take a few charge/discharge cycles before the unit's LED indicator and the on-screen battery status icon reflect the actual power level of the new battery.

Verifying the Optical Output of Your Unit

Your unit comes with a wizard that verifies the optical output and provides you with information about the condition of the external and the internal optical connectors.

Once its verification is complete, the wizard rates the result from zero to five stars (half-stars are possible). Any verification receiving a three-star rating or less requires your attention. This can help you determine if the optical connectors are still working properly or if a replacement is necessary.

- If you have a Pro unit, it is equipped with a Click-Out optical connector that you can replace should it become damaged with time. You can purchase new Click-Out connectors from EXFO.
- If your unit is not equipped with a Click-Out optical connector and a connector replacement is necessary, you will need to contact EXFO.



CAUTION

To ensure that the internal optical connection remains in the best condition possible, **DO NOT REMOVE** the Click-Out connector from your unit unless it is absolutely necessary.



IMPORTANT

Your unit has been designed not to require frequent calibrations (see *Recalibrating the Unit* on page 238). However, to ensure that the performance of your unit remains optimum, EXFO recommends to perform regular optical output verifications on it.

To verify the optical output of your unit:

1. Inspect and clean the unit's optical port.
2. If the port is damaged and you have a Pro unit, replace the Click-Out connector (see *Replacing the Click-Out Optical Connector (Pro Units Only)* on page 234). If the port is damaged and your unit is not equipped with a Click-Out connector, contact EXFO (see *Service and Repairs* on page 274).

OR

If the port seems fine, continue with the remaining steps of this procedure.

3. Inspect and clean the connector of the launch cord that you will be connecting to the optical port during the verification process.
4. On your unit, from the main menu, tap **Settings**.

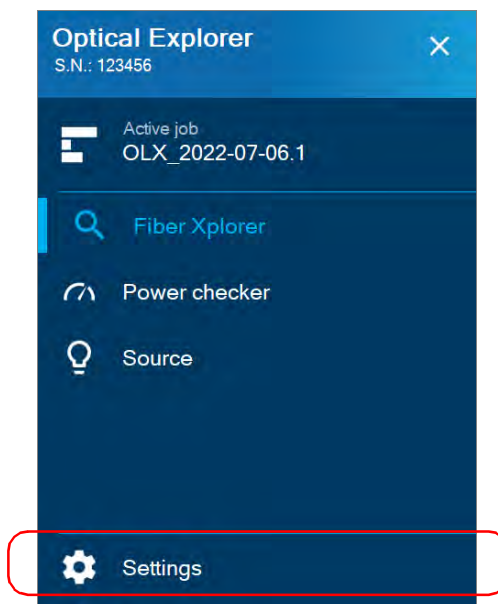

Maintenance

Verifying the Optical Output of Your Unit

5. Scroll down to the **Optical Explorer** section.
6. Tap **Optical output diagnosis**.

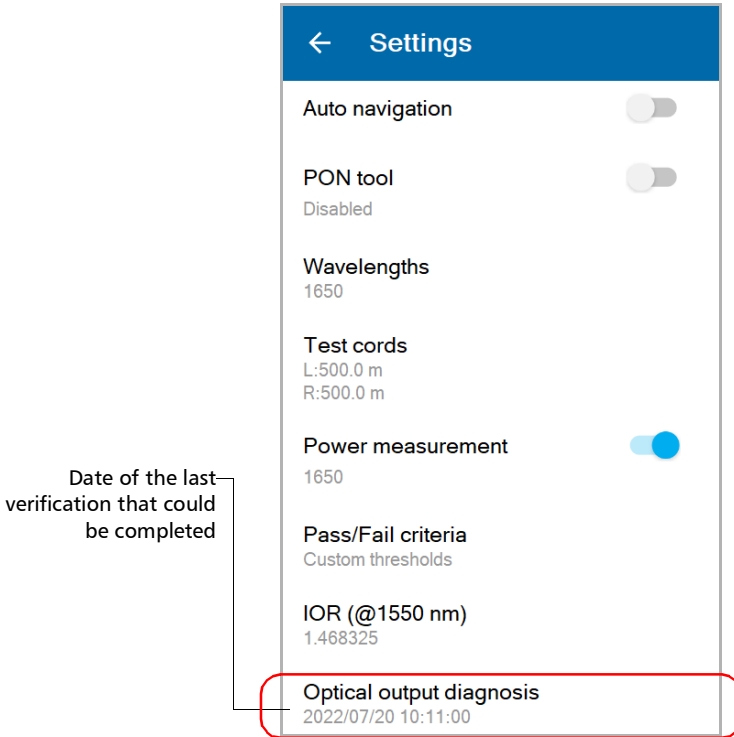

7. Follow the on-screen instructions.

Note: During the verification process, you will connect one end of the launch cord to the optical port of your unit. The other end of the cord must remain unconnected.

Once the test is complete, the unit displays the result of the verification as well as recommendations, when applicable. If you have finished your work, tap **DONE**. If you want to perform the verification again, tap **BACK** from the lower left corner of the screen.

Note: *If you have a Pro unit and want to know if the internal connector is damaged or if you could only replace the Click-Out connector, see Determining the Condition of the Click-Out Optical Connector (Pro Units Only) on page 232. If your unit is not equipped with a Click-Out connector and the unit needs a connector replacement, you have to contact EXFO (see Service and Repairs on page 274).*

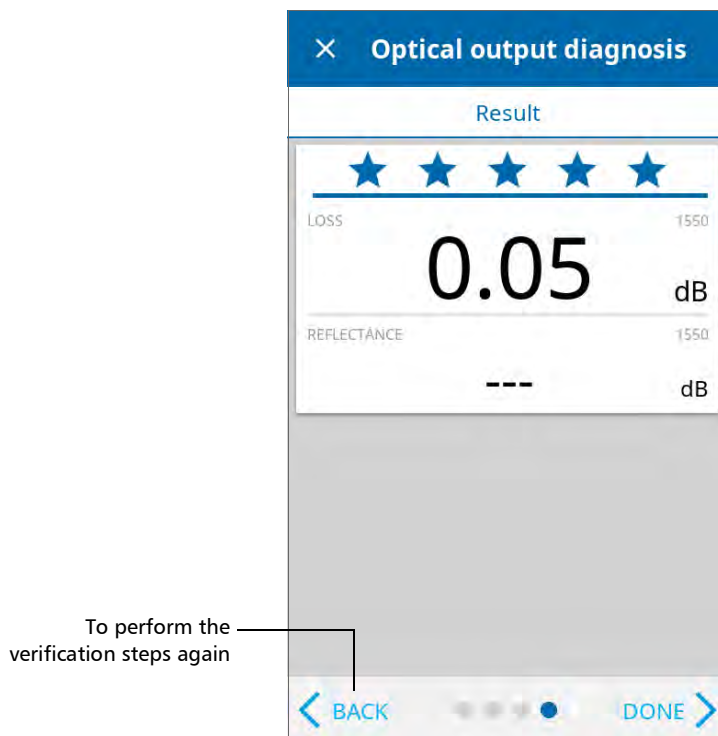

Maintenance

Determining the Condition of the Click-Out Optical Connector (Pro Units Only)

Determining the Condition of the Click-Out Optical Connector (Pro Units Only)

If you have a Pro unit, you can perform a procedure to help you determine if there is a problem with the internal connector or only with the replaceable Click-Out connector.

To determine if the Click-Out connector only needs to be replaced:

1. Remove the Click-Out connector from the unit (see the corresponding procedure in *Replacing the Click-Out Optical Connector (Pro Units Only)* on page 234).
2. Clean and inspect the optical port and the optical connector that connects inside the unit.

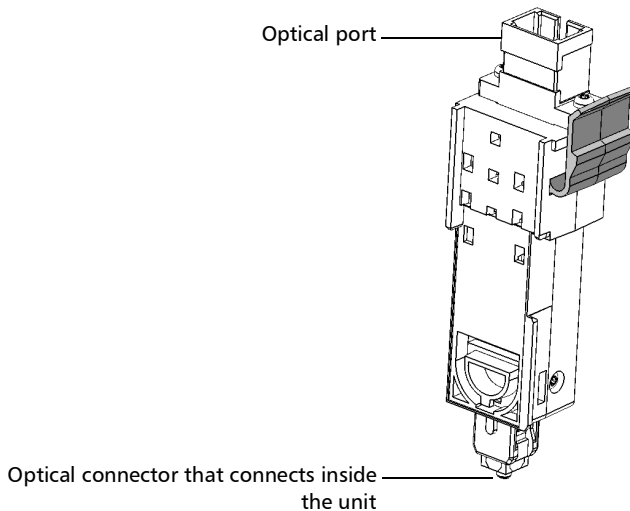

Determining the Condition of the Click-Out Optical Connector (Pro Units Only)

3. If the port or the connector is damaged, replace the Click-Out connector (see *Replacing the Click-Out Optical Connector (Pro Units Only)* on page 234).

OR

If the port and connector seem fine, continue with the remaining steps of this procedure.

4. It is not necessary nor recommended to clean or inspect the internal connector. However, if you still need to clean the internal connector, you can do so from the Click-Out connector bay by using a 2.5 mm pencil cleaner.

Note: *If you do not have a 2.5 mm pencil cleaner, you can use a dry lint-free swab.*

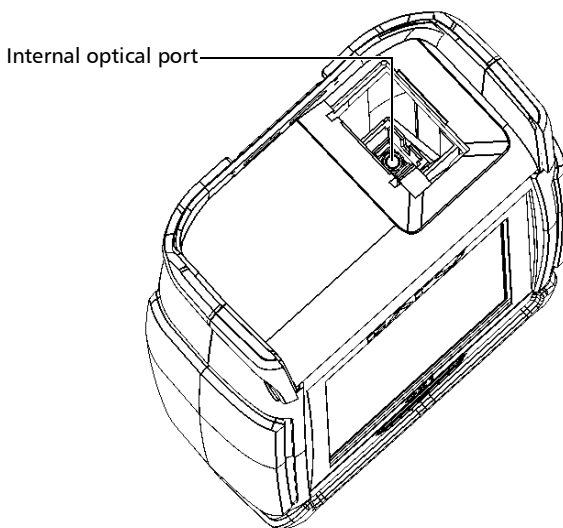

Maintenance

Replacing the Click-Out Optical Connector (Pro Units Only)

5. Place the Click-Out connector back in the unit (see the corresponding procedure in *Replacing the Click-Out Optical Connector (Pro Units Only)* on page 234).
6. Perform an optical output test again.
7. If the rating remains low (three stars or less), you could repeat the steps above. If after a couple of tries the rating remains low, it probably means that the internal connector needs to be replaced. In this case, contact EXFO (see *Service and Repairs* on page 274).

Replacing the Click-Out Optical Connector (Pro Units Only)

All Pro units come with a Click-Out optical connector that you can replace should you need a different connector type (APC or UPC), or should it become damaged with time. You can purchase new Click-Out connectors from EXFO.

If your unit is not equipped with a Click-Out optical connector and the connector has to be replaced, you need to contact EXFO (see *Service and Repairs* on page 274).

To remove the Click-Out optical connector:

1. Disconnect the fiber and USB cable from the unit, if applicable.
2. Position the unit so that you can see its Click-Out connector and easily access it.

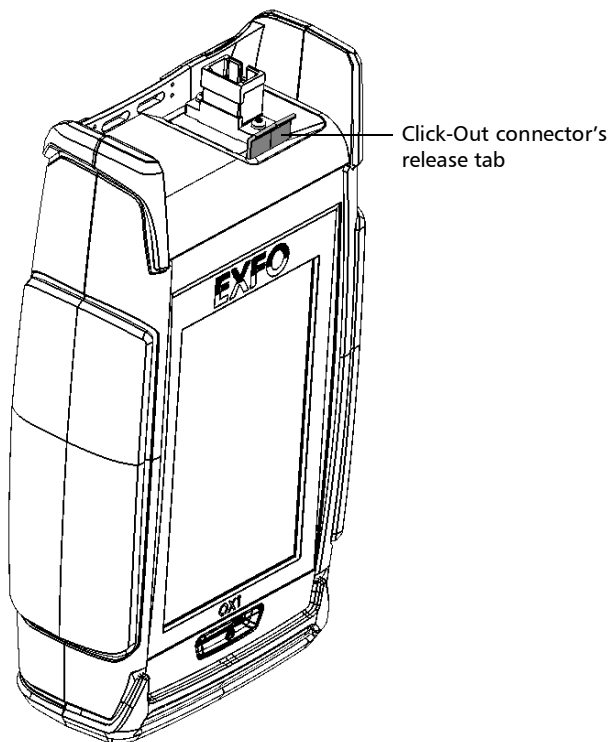

Maintenance

Replacing the Click-Out Optical Connector (Pro Units Only)

3. While pushing the release tab toward the back of the unit, pull the Click-Out connector out of the unit.

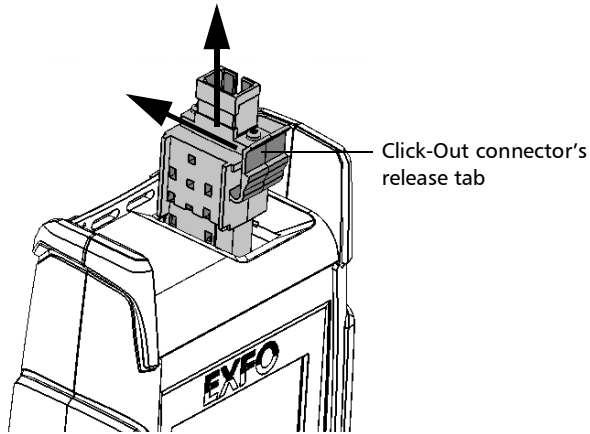

To replace (or reinstall) the Click-Out optical connector:

1. Position the new Click-Out connector vertically so that you can see its release tab and that the optical port is pointing upwards.

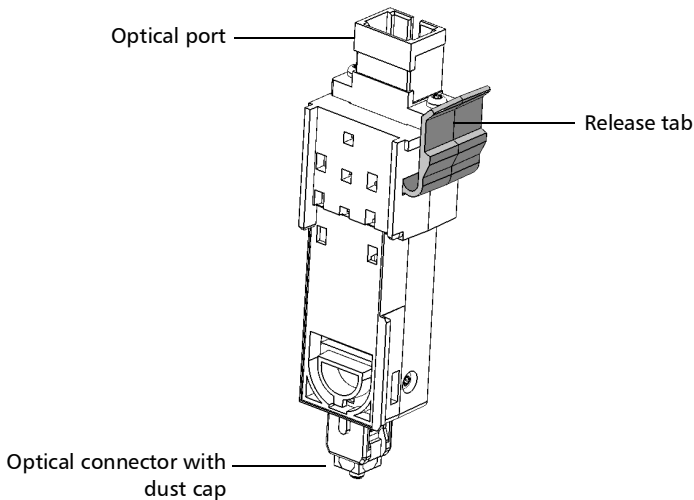

2. Remove the dust cap protecting the optical connector (which should be pointing downwards), being careful not to touch the optical connector.
3. Inspect the optical connector (from which you have just removed the dust cap), and clean it if necessary.
4. Slide the Click-Out connector into the unit until it clicks into place.

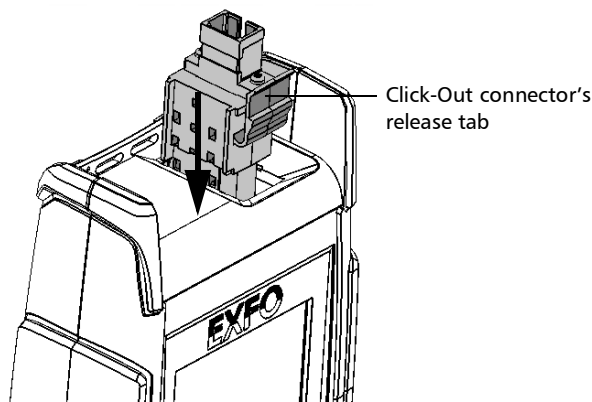

There should be no gap between the edges of the Click-Out connector and its bay when it is inserted properly.

5. Inspect and clean the optical port if necessary.
6. Turn on the unit.
7. Perform an optical output verification to ensure that the new Click-Out connector is installed properly and that the unit takes into account the right connector type (see *Verifying the Optical Output of Your Unit* on page 228).

Note: *If the optical output verification detects issues, see the step about how to clean the internal connector in Determining the Condition of the Click-Out Optical Connector (Pro Units Only) on page 232.*

Your unit is ready to use.

Recalibrating the Unit

EXFO manufacturing and service center calibrations are based on the ISO/IEC 17025 standard (*General Requirements for the Competence of Testing and Calibration Laboratories*). This standard states that calibration documents must not contain a calibration interval and that the user is responsible for determining the re-calibration date according to the actual use of the instrument.

The validity of specifications depends on operating conditions. For example, the calibration validity period can be longer or shorter depending on the intensity of use, environmental conditions and unit maintenance, as well as the specific requirements for your application. All of these elements must be taken into consideration when determining the appropriate calibration interval of this particular EXFO unit.

Under normal use, the recommended interval for your OX1 Optical Explorer is: ten years.

For newly delivered units, EXFO has determined that the storage of this product for up to six months between calibration and shipment does not affect its performance.

To help you with calibration follow-up, EXFO provides a special calibration label that complies with the ISO/IEC 17025 standard and indicates the unit calibration date and provides space to indicate the due date. Unless you have already established a specific calibration interval based on your own empirical data and requirements, EXFO would recommend that the next calibration date be established according to the following equation:

Next calibration date = Shipping date + Recommended calibration period (ten years)

To ensure that your unit conforms to the published specifications, calibration may be carried out at an EXFO service center or, depending on the product, at one of EXFO's certified service centers. Calibrations at EXFO are performed using standards traceable to national metrology institutes.

The original calibration date is available on the calibration certificate that came with your unit. Since this date is printed on a sticker, if desired, you could affix it to your unit for easier reference. The most recent calibration date is also available from your unit (Main menu > **Settings** > **About** > **Calibration date**).

Upgrading Applications and Software With a Wi-Fi connection

All the necessary applications have been preinstalled and configured at the factory. However, you may have to upgrade some of them or upgrade the software when new versions become available.

Your unit allows you to check for updates, download these updates and install them directly.

Note: *Your unit must have access to an Internet connection (via Wi-Fi) to be able to download updates and install them.*



IMPORTANT

For a trouble-free upgrade, ensure that you connect your unit to a power outlet and that your unit remains on during the entire upgrade process.

To upgrade applications or software with a Wi-Fi connection:

- 1.** Connect your unit to an external power source with the provided USB power adapter.
- 2.** If it is not already done, turn on your unit.
- 3.** Ensure that your unit has access to the Internet (see *Working With a Wireless Network* on page 186).

4. From the main menu, tap **Settings**.

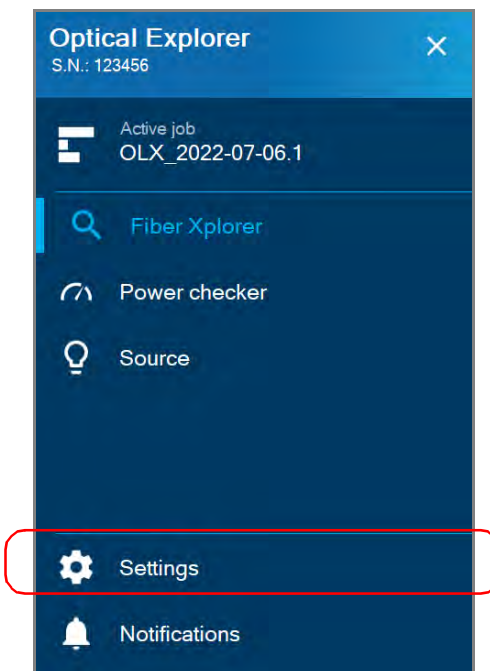

5. Scroll down to the **Device settings** section.

Maintenance

Upgrading Applications and Software With a Wi-Fi connection

6. Tap **Software update**. The unit will start to check for updates automatically.

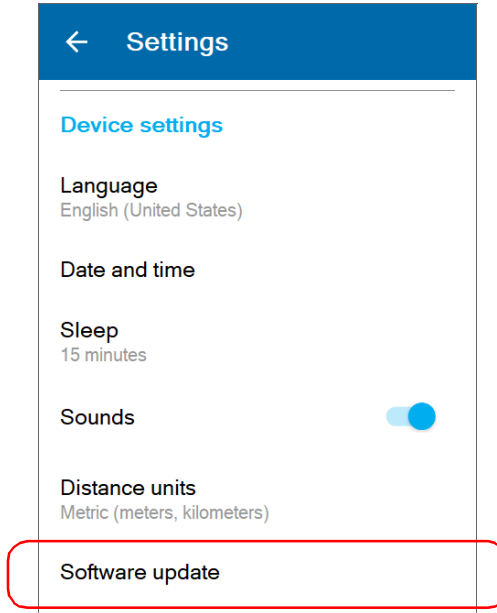

7. Follow the on-screen instructions. If an update is available and you choose to install it, your unit will restart automatically at the end to complete the process.

Upgrading Applications and Software With FastReporter 3

All the necessary applications have been preinstalled and configured at the factory. However, you may have to upgrade some of them or upgrade the software when new versions become available.

If you have a PC with FastReporter 3 already installed and connected to your unit with a Wi-Fi connection, you can check for the software version currently installed. You can also install the software upgrade from FastReporter 3 if you wish to do so.



IMPORTANT

For a trouble-free upgrade, ensure that you connect your unit to a PC connected to a power outlet and that your unit remains on during the entire upgrade process.

To upgrade applications and software with FastReporter 3:

- 1.** If it is not already done, turn on your unit and your PC.
- 2.** Ensure the **Wi-Fi data transfer to FR3** is enabled on your unit. For more information, see *Enabling or Disabling the Wireless Communication* on page 181.
- 3.** Launch FastReporter 3 on your PC.
- 4.** Click the Update icon in the Instrument section and follow the instructions.

Upgrading Applications and Software With a USB Connection

All the necessary applications have been preinstalled and configured at the factory. However, you may have to upgrade some of them or upgrade the software when new versions become available.

Your unit allows you to check for updates, download these updates and install them directly.

If you are working with a unit that does not have wireless capabilities, you can perform the necessary upgrades with a USB connection.

Note: *Your unit will go into sleep mode after being connected by USB to a PC for six hours.*



IMPORTANT

For a trouble-free upgrade, ensure that you connect your unit to a to a PC connected to a power outlet and that your unit remains on during the entire upgrade process.

To upgrade applications and software with a USB connection:

1. Using a USB cable, connect your unit to a PC that has EXFO's FastReporter 3 already installed.

Note: *Connect the USB cable directly to your unit without using a hub.*

2. If it is not already done, turn on your unit and your PC.
3. Click the Update icon in the Instrument section and follow the instructions.

Recycling and Disposal



This symbol on the product means that you should recycle or dispose of your product (including electric and electronic accessories) properly, in accordance with local regulations. Do not dispose of it in ordinary garbage receptacles.

For complete recycling/disposal information, visit the EXFO Web site at www.exfo.com/recycle.

12 Troubleshooting

Solving Common Problems

Problem	Possible Cause	Solution
My unit does not start.	The battery is completely discharged (if the battery level allows it, the unit's LED will remain red for about 10 seconds when you try to turn on the unit).	Connect the unit to an external power source to recharge the battery. If the battery is no longer charging properly, you may need to replace it with a new one (see <i>Replacing the Battery</i> on page 220).
	The system has encountered a problem.	Press the on/off button for at least ten seconds to force a hardware reset on the unit. If the problem persists, restore your unit to normal operation (see <i>Restoring Your Unit to Normal Operation</i> on page 251).
	Some files essential to the normal operation of the unit have been corrupted.	Press the on/off button for at least ten seconds to force a hardware reset on the unit. If the problem persists, try resetting the OX1 to its factory settings (see <i>Reverting to Factory Settings</i> on page 98). If the problem still persists, restore your unit to normal operation (see <i>Restoring Your Unit to Normal Operation</i> on page 251).
My unit is not responding.	The system has encountered a problem.	Press the on/off button for at least ten seconds to force a hardware reset on the unit.

Troubleshooting

Solving Common Problems

Problem	Possible Cause	Solution
The battery is not recharging.	Ambient temperature is too high or too low.	<p>In this case, the unit's LED is blue and blinks slowly.</p> <p>Make sure that the temperature in the location where you recharge the battery is within the specifications.</p>
	The USB power adapter is not connected properly.	<p>Make sure that the USB power adapter is connected to the unit and the AC outlet.</p> <p>In this case, the unit's LED is not blinking at all, but there is a battery icon with a flash symbol displayed on screen.</p> <p>If the USB power adapter is connected properly and the problem persists, it could mean that the USB power adapter is defective. In this case, try replacing the adapter. You can purchase new USB power adapters from EXFO.</p>
I have just replaced the battery and the unit's LED turns to red when I turn on the unit.	The unit may take a little time to detect the level of a new battery.	<p>Connect the unit to a power outlet with the provided USB power adapter and let the battery charge for a few minutes. After a short while, the unit should turn on. However, it could take a few charge/discharge cycles before the unit's LED indicator and the on-screen battery status icon reflect the actual power level of the new battery.</p>

Problem	Possible Cause	Solution
On my unit, no wireless network is listed.	No network has been configured yet.	You must first configure the desired networks on your smart device, using the OX1 tool in the TestFlow/Exchange mobile application (see <i>Working With a Wireless Network</i> on page 186).
My unit does not connect automatically to the wireless network that I have used during my last work session.	There is a connection problem with the network.	<ul style="list-style-type: none"> ▶ Ensure that the Wi-Fi connection is enabled on your unit (see <i>Enabling or Disabling the Wireless Communication</i> on page 181). ▶ In the case of a secured network, ensure that the password has not changed since the initial configuration of this network. If the password is no longer valid, you will have to update it using the TestFlow/Exchange mobile application (see <i>Working With a Wireless Network</i> on page 186). ▶ Ensure that the network is working normally.
I cannot delete a job.	The job you want to delete is the active job.	To delete a job, you must first select another job to make it the active job.
I cannot delete a test point.	The test point is part of a cloud-based job	To delete a test point that is part of a cloud-based job, you must use the TestFlow/Exchange mobile application.

Troubleshooting

Solving Common Problems

Problem	Possible Cause	Solution
I cannot enable Wi-Fi and Bluetooth connections.	Your unit does not have wireless capabilities.	You must use a unit that has wireless capabilities to enable Wi-Fi and Bluetooth connections.
My unit does not connect to the wireless network that I choose from the list of configured networks.	There is a connection problem with the network.	<ul style="list-style-type: none">➤ Ensure that the Wi-Fi connection is enabled on your unit (see <i>Enabling or Disabling the Wireless Communication</i> on page 181).➤ In the case of a secured network, ensure that the right password has been entered and that it has not changed since the initial configuration of this network. You will have to re-enter the password or update it using the OX1 tool in the TestFlow/Exchange mobile application (see <i>Working With a Wireless Network</i> on page 186).➤ Ensure that the network is working normally.
My unit cannot connect to a Wi-Fi network even though I have configured all parameters correctly.	Since every network has its own specifications, there may be elements that are not compatible with your unit.	Configure a Wi-Fi hotspot on a smart device or a laptop that you will use to give your unit access a wireless network. When it is done, add this Wi-Fi hotspot to the list of configured networks as you would with any Wi-Fi networks (see <i>Configuring a Wireless Network</i> on page 189).

Problem	Possible Cause	Solution
I cannot use the TestFlow/Exchange mobile application anymore.	The SSL certificate is no longer valid.	<ul style="list-style-type: none"> ➤ You need to update the TestFlow/Exchange mobile application on the smart device and establish a Bluetooth connection with the OX1. ➤ If this does not work, contact EXFO.

Restoring Your Unit to Normal Operation

If you ever encounter major problems with your unit (for example, the unit does not behave the way it used to), you can revert it to its initial state (as it was at time of purchase).



CAUTION

- Once the recovery operation is started, it cannot be cancelled. Make sure to transfer any data that you wish to keep prior to starting the recovery operation, as they will be permanently lost.
- Follow the procedure below carefully and connect your unit to a power outlet using the provided USB power adapter when you are instructed to do so.

Troubleshooting

Restoring Your Unit to Normal Operation



CAUTION

Electrostatic discharge (ESD) damage can cause complete or intermittent equipment failures.

- ▶ Always use an ESD-preventive wrist or ankle strap when opening your unit. Ensure that the antistatic strap makes good skin contact and that the end of its wire is grounded properly.
- ▶ Never touch any component inside the unit other than those identified in the procedure hereafter, either with tools or your fingers.

To restore you unit to normal operation:

1. If desired, transfer the data that you wish to keep (see *Generating Measurement Reports With a Bluetooth Connection* on page 170 and *Synchronizing Job Results With the Smart Device and the Cloud Server* on page 206).

Note: *If desired or if your unit does not have wireless capabilities, you can transfer the data that you wish to keep using EXFO's FastReporter 3 by connecting a USB cable to a PC with FastReporter 3 (see *Generating Measurement Reports With a USB Connection* on page 173).*

2. Ensure that the battery level of your unit will be sufficient to start the unit when instructed to do so (no red battery icon on screen or red, steady LED on the unit's front panel).
3. Turn off your unit (shutdown).
4. If applicable, disconnect the USB cable. This is necessary to be able to open the unit as explained hereafter.
5. Position the unit so that its front panel rests on a flat surface such as a table.

6. On the back of the unit, using a 2.5 mm hex socket screwdriver, turn the screws (4) counterclockwise until they are loose.

Note: You can remove the screws completely if you want, but you can also leave them in their holes, as long as the back cover can be moved.

Turn screws
counterclockwise

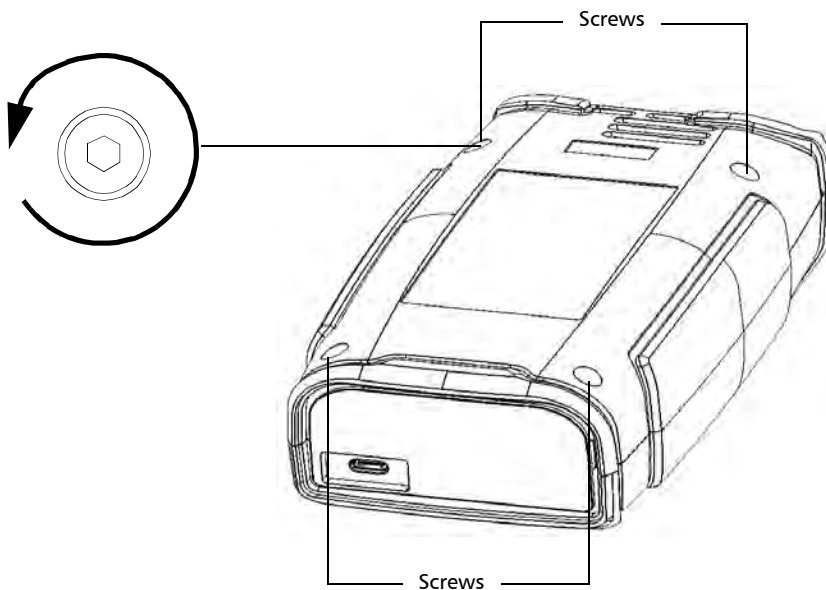

Troubleshooting

Restoring Your Unit to Normal Operation

7. Hold the back panel by its sides and pull it up to remove it.

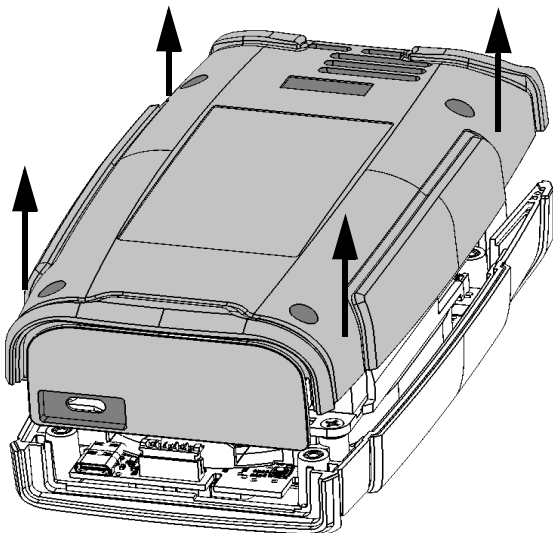

8. Slide your left hand under your unit so that you can have access to the on/off button, being careful not to touch inside your unit.

Note: You may find helpful to slightly move the unit towards the edge of the table so that its on/off button is more accessible.

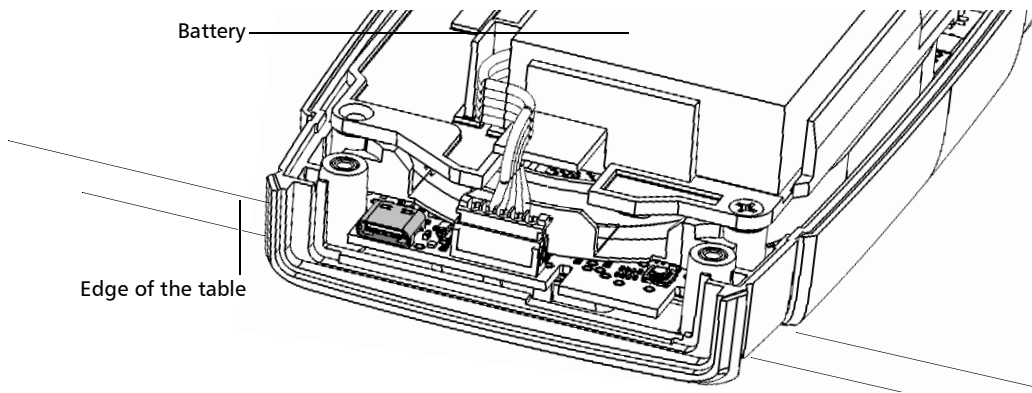



CAUTION

To avoid damaging your unit, do not use metallic objects such as the ball of a pen to push the reset button. Always use your finger or a non-metallic object.

9. While pressing and holding the reset button, push the on/off button. Release the on/off button as soon as the unit beeps once, but continue to hold the reset button as long as the unit's LED is lit or for about 10 seconds.

Note: *The light is visible through the notch in the electronic board.*

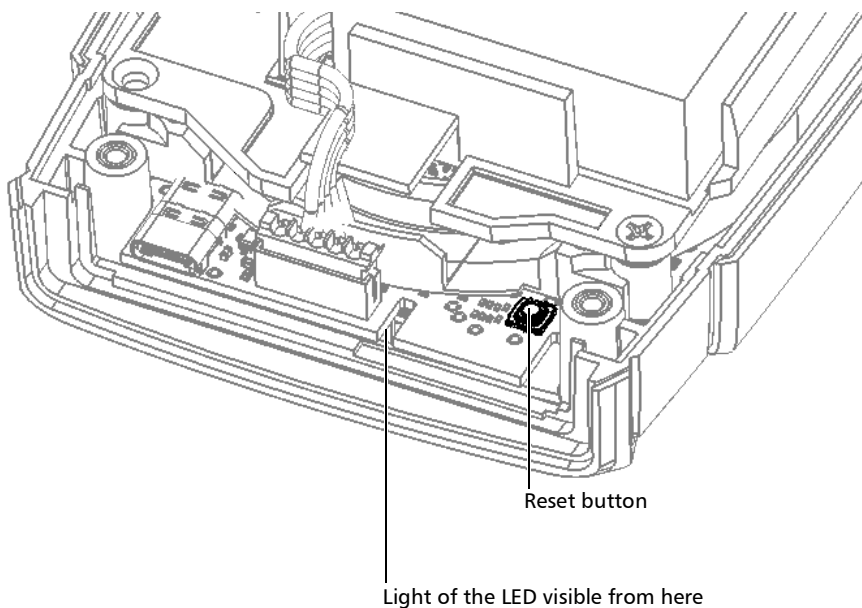

Troubleshooting

Restoring Your Unit to Normal Operation

- 10.** Place the back panel on the unit, making sure that it is aligned properly with the front of the unit. The sides of the back panel should be flush with those of the front. There should be no gap between the back panel and the front of the unit. If necessary, slightly move the back panel until alignment is correct.

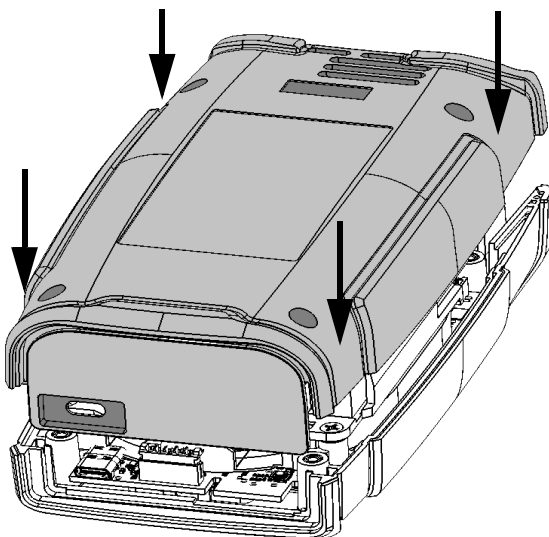

- 11.** Using a 2.5 mm hex socket screwdriver, turn the screws (4) clockwise until they are tightened.

This will secure the back panel into place.

- 12.** Turn your unit over so that you can see its touchscreen.



CAUTION

DO NOT TURN OFF your unit while the recovery operation is underway. Doing so may damage your unit. Damaged units will need to be sent back to EXFO for repair.

- 13.** Connect your unit to a power outlet using the provided USB power adapter. This will ensure that your unit remains powered on during the whole recovery operation.
- 14.** Tap **FACTORY RESET** to launch the recovery operation. If you prefer not to perform the recovery operation for the moment, tap **CANCEL** to simply start the unit without making any changes.

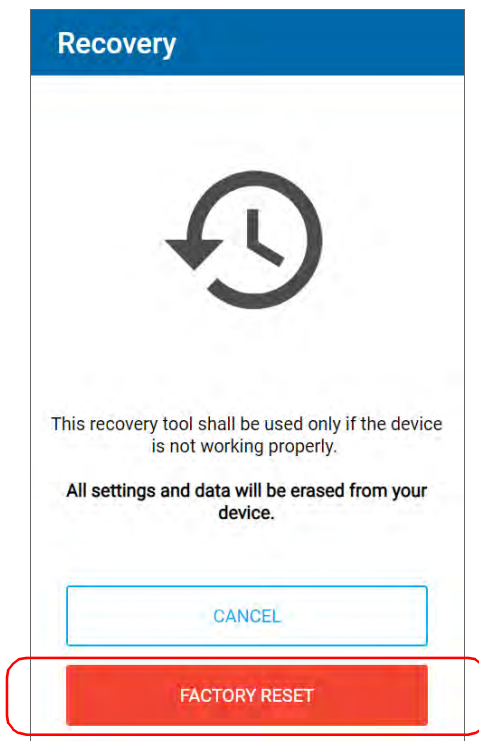

Troubleshooting

Testing the Touchscreen

- 15.** Read the warnings, and then tap **FACTORY RESET**. If you prefer not to perform the recovery operation for the moment, tap **CANCEL**.
- 16.** When the operation is complete and the application prompts you, tap **RESTART**.
- 17.** Once your unit has restarted, set the operation language, read and accept the EXFO license agreement, configure the date and time, and select the desired distance units as you did when you first received your unit (see *Configuring Your Unit at First Startup* on page 23).

Testing the Touchscreen

Your unit comes with a tool enabling you to verify that the touchscreen is working as expected.

To help you verify the behavior of the touchscreen, you will see the following:

- A red dot displayed for each quick tap on the screen.
- A blue dot displayed for each long tap.
- A blue line appearing as you move the tip of your finger around the screen while applying pressure.

To test the touchscreen:

1. From the main menu, tap **Support**.

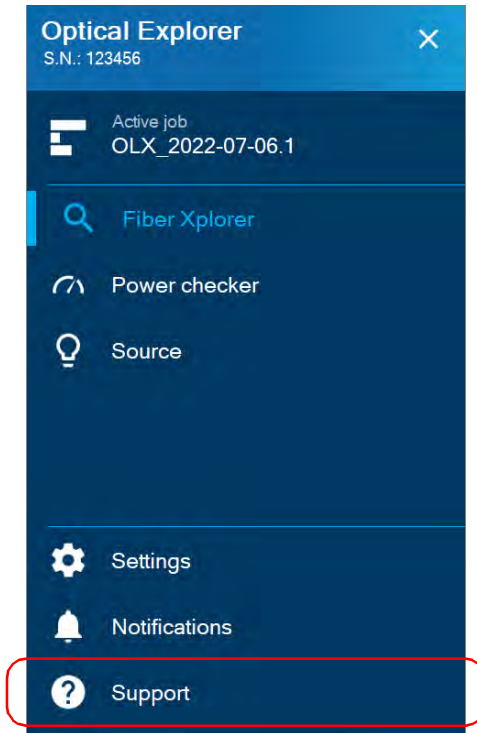

2. Scroll down to the **Troubleshooting** section.

Troubleshooting

Testing the Touchscreen

3. Tap Touchscreen test.

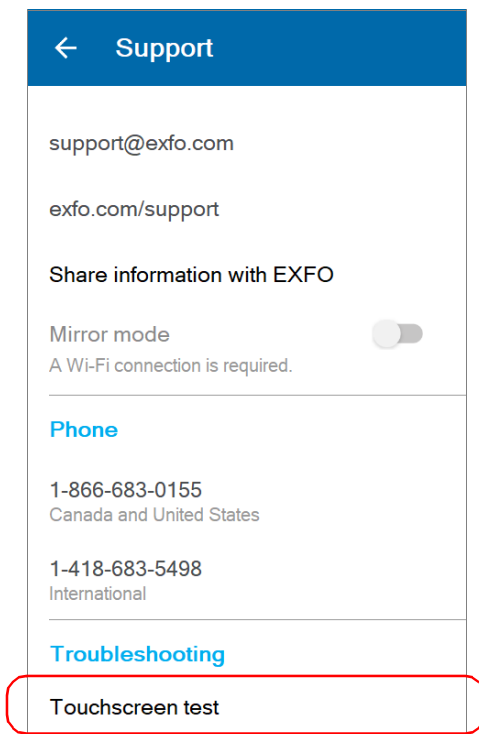

4. Perform quick taps, long taps or move your finger on the screen to test it.
5. When you have finished your verification, tap **X** to exit the touchscreen tool.

Accessing the Online Documentation From the OX1

You can access the getting started guide from your unit.

For more detailed information, you can also access the user guide at all times from your smart device:

- by scanning the QR code displayed on your unit
- if your unit has wireless capabilities, by using the corresponding link in the TestFlow/Exchange mobile application (see *Accessing the Online Documentation From the Smart Device* on page 211)

Troubleshooting

Accessing the Online Documentation From the OX1

To view the getting started guide from your unit:

1. From the main menu, tap **Support**.

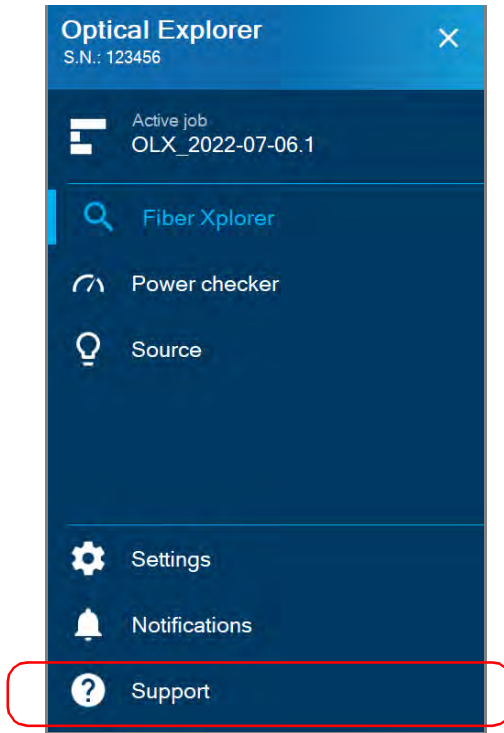

2. Under **User documentation**, tap **Getting started guide**.

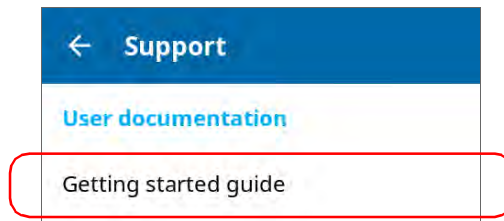

Note: You can exit the Getting started guide at any time by tapping the X.

To access the user guide with the QR code:

1. From the main menu, tap **Support**.

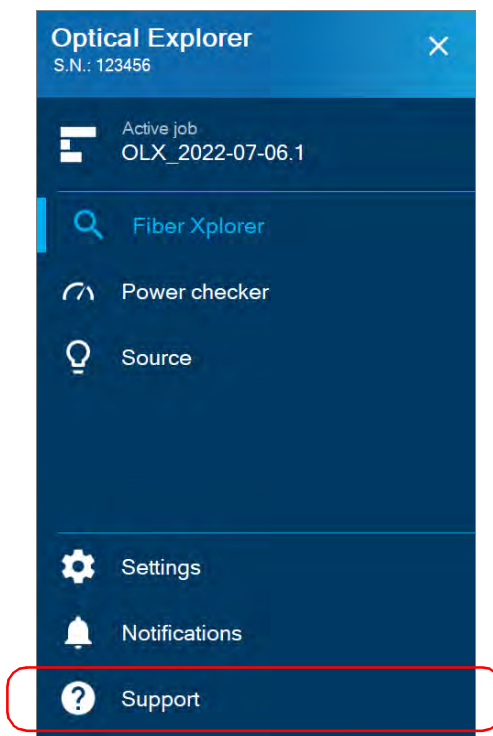

Troubleshooting

Accessing the Online Documentation From the OX1

2. Under **User documentation**, scan the QR code with your smart device.

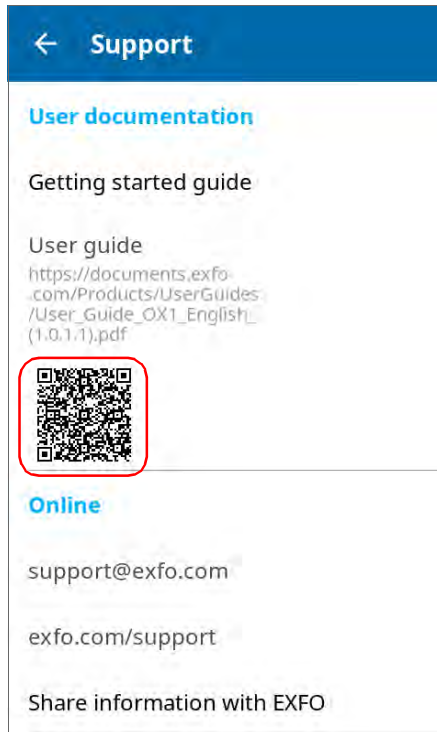

Contacting the Technical Support Group

To obtain after-sales service or technical support for this product, contact EXFO at one of the following numbers. The Technical Support Group is available to take your calls from Monday to Friday, 8:00 a.m. to 7:00 p.m. (Eastern Time in North America).

Technical Support Group

400 Godin Avenue
Quebec (Quebec) G1M 2K2
CANADA

1 866 683-0155 (USA and Canada)
Tel.: 1 418 683-5498
Fax: 1 418 683-9224
support@exfo.com

For detailed information about technical support, and for a list of other worldwide locations, visit the EXFO Web site at www.exfo.com.

If you have comments or suggestions about this user documentation, you can send them to customer.feedback.manual@exfo.com.

To accelerate the process, please have information such as the name and the serial number (see the product identification label), as well as a description of your problem, close at hand.

Sharing Information With the Technical Support Group

After contacting EXFO for support, you may need to share some of the measurements or error reports with the technical support group for further investigation.

Note: *You must contact the technical support group before sharing measurements or error reports. Otherwise, no measurements or error reports will be processed or archived.*

Note: *You must contact the technical support group if you want to share job measurements.*

Your unit must have wireless capabilities and have access to a Wi-Fi connection to be able to share results. If you have not configured any Wi-Fi network yet, see *Working With a Wireless Network* on page 186.

Note: *To be able to send measurements and error reports to the technical support group, you must read and accept the privacy and security policies.*

To share information with the technical support group:

1. From the main menu, tap **Support**.

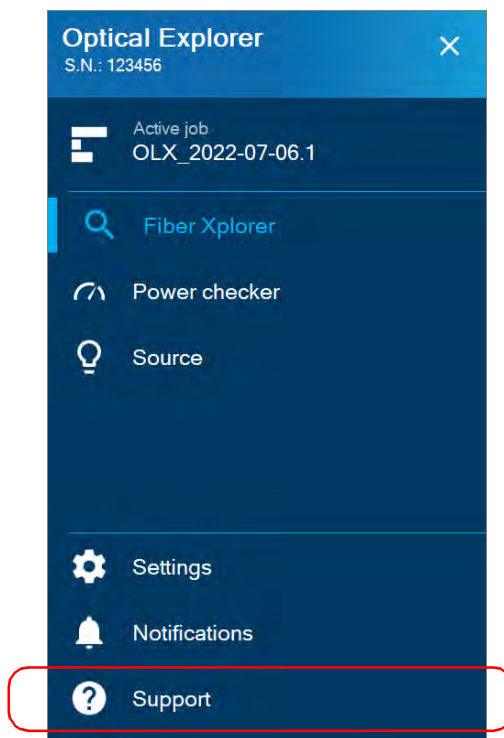

2. Tap **Share information with EXFO**.



Troubleshooting

Sharing Information With the Technical Support Group

3. Select the check boxes corresponding to the measurement files that you want to share.

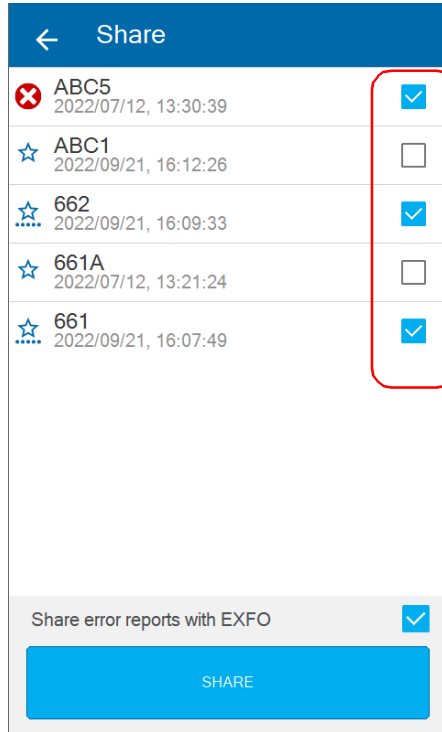

4. You can also share error reports with EXFO by selecting the corresponding check box.
5. Once your selection is complete, tap **SHARE**.

A confirmation message is displayed as soon as the transfer is complete.

Viewing System Information

You can easily access important information such as the model of your unit, the serial number, the software and hardware versions, as well as the latest hardware calibration, directly from your unit. You can also find the contact information if you ever need to reach EXFO.

To view the system information:

From the main menu, tap **Settings**, and then **About**.

The information you want to view is displayed on screen.

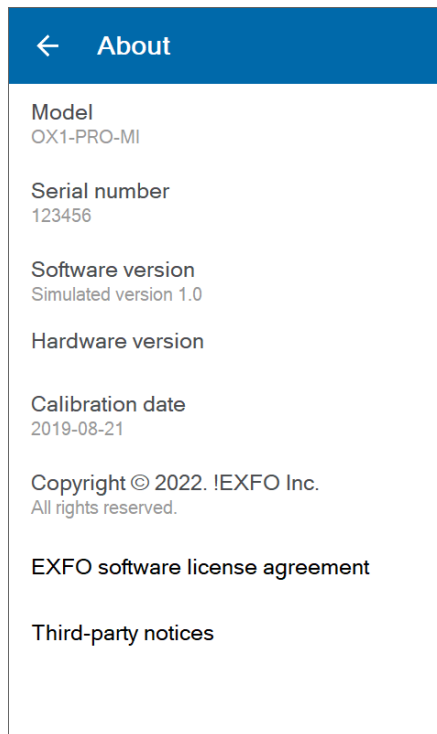

Troubleshooting

Transportation

To retrieve the contact information:

From the main menu, tap **Support**.

The information you want to view is displayed on screen.

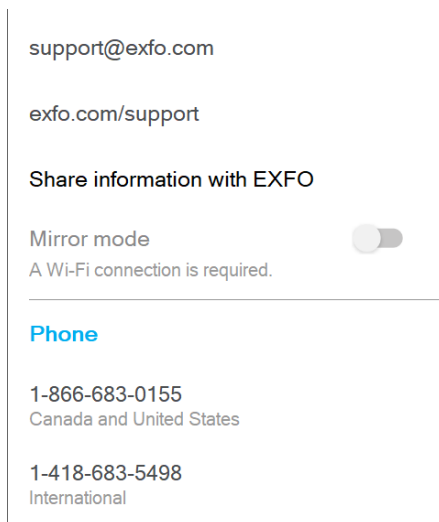

Transportation

Maintain a temperature range within specifications when transporting the unit. Transportation damage can occur from improper handling. The following steps are recommended to minimize the possibility of damage:

- Pack the unit in its original packing material when shipping.
- Avoid high humidity or large temperature fluctuations.
- Keep the unit out of direct sunlight.
- Avoid unnecessary shocks and vibrations.

13 Warranty

General Information

EXFO Inc. (EXFO) warrants this equipment against defects in material and workmanship for a period of one year from the date of original shipment. EXFO also warrants that this equipment will meet applicable specifications under normal use.

During the warranty period, EXFO will, at its discretion, repair, replace, or issue credit for any defective product, as well as verify and adjust the product free of charge should the equipment need to be repaired or if the original calibration is erroneous. If the equipment is sent back for verification of calibration during the warranty period and found to meet all published specifications, EXFO will charge standard calibration fees.



IMPORTANT

The warranty can become null and void if:

- unit has been tampered with, repaired, or worked upon by unauthorized individuals or non-EXFO personnel.
- warranty sticker has been removed.
- case screws, other than those specified in this guide, have been removed.
- case has been opened, other than as explained in this guide.
- unit serial number has been altered, erased, or removed.
- unit has been misused, neglected, or damaged by accident.

THIS WARRANTY IS IN LIEU OF ALL OTHER WARRANTIES EXPRESSED, IMPLIED, OR STATUTORY, INCLUDING, BUT NOT LIMITED TO, THE IMPLIED WARRANTIES OF MERCHANTABILITY AND FITNESS FOR A PARTICULAR PURPOSE. IN NO EVENT SHALL EXFO BE LIABLE FOR SPECIAL, INCIDENTAL, OR CONSEQUENTIAL DAMAGES.

Warranty

Gray Market and Gray Market Products

Gray Market and Gray Market Products

Gray market is a market where products are traded through distribution channels that are legal but remain unofficial, unauthorized, or unintended by the original manufacturer. Intermediaries using such channels to distribute products are considered to be part of the gray market (hereafter unauthorized intermediary).

EXFO considers that a product originates from the gray market (hereafter gray market product) in the following situations:

- A product is sold by an unauthorized intermediary.
- A product is designed and destined for a particular market and sold on a second market.
- A product is resold, despite being reported lost or stolen.

When products are purchased on the gray market, rather than through an authorized EXFO distribution channel, EXFO is unable to guarantee the source and quality of those products nor the local safety regulations and certifications (CE, UL, etc.).

EXFO will not honor warranty, install, maintain, repair, calibrate, provide technical support nor make any support contracts available for gray market products.

For complete information, refer to EXFO's policy regarding gray market products at www.exfo.com/en/how-to-buy/sales-terms-conditions/gray-market/

Liability

EXFO shall not be liable for damages resulting from the use of the product, nor shall be responsible for any failure in the performance of other items to which the product is connected or the operation of any system of which the product may be a part.

EXFO shall not be liable for damages resulting from improper usage or unauthorized modification of the product, its accompanying accessories and software.

Exclusions

EXFO reserves the right to make changes in the design or construction of any of its products at any time without incurring obligation to make any changes whatsoever on units purchased. Accessories, including but not limited to fuses, pilot lamps, batteries and universal interfaces (EUI) used with EXFO products are not covered by this warranty.

This warranty excludes failure resulting from: improper use or installation, normal wear and tear, accident, abuse, neglect, fire, water, lightning or other acts of nature, causes external to the product or other factors beyond the control of EXFO.



IMPORTANT

In the case of products equipped with optical connectors, EXFO will charge a fee for replacing connectors that were damaged due to misuse or bad cleaning.

Certification

EXFO certifies that this equipment met its published specifications at the time of shipment from the factory.

Service and Repairs

EXFO commits to providing product service and repair for five years following the date of purchase.

To send any equipment for service or repair:

1. Call one of EXFO's authorized service centers (see *EXFO Service Centers Worldwide* on page 275). Support personnel will determine if the equipment requires service, repair, or calibration.
2. If equipment must be returned to EXFO or an authorized service center, support personnel will issue a Return Merchandise Authorization (RMA) number and provide an address for return.
3. If possible, back up your data before sending the unit for repair.
4. Pack the equipment in its original shipping material. Be sure to include a statement or report fully detailing the defect and the conditions under which it was observed.
5. Return the equipment, prepaid, to the address given to you by support personnel. Be sure to write the RMA number on the shipping slip. *EXFO will refuse and return any package that does not bear an RMA number.*

Note: *A test setup fee will apply to any returned unit that, after test, is found to meet the applicable specifications.*

After repair, the equipment will be returned with a repair report. If the equipment is not under warranty, you will be invoiced for the cost appearing on this report. EXFO will pay return-to-customer shipping costs for equipment under warranty. Shipping insurance is at your expense.

Routine recalibration is not included in any of the warranty plans. Since calibrations/verifications are not covered by the basic or extended warranties, you may elect to purchase FlexCare Calibration/Verification Packages for a definite period of time. Contact an authorized service center (see *EXFO Service Centers Worldwide* on page 275).

EXFO Service Centers Worldwide

If your product requires servicing, contact your nearest authorized service center.

EXFO Headquarters Service Center

400 Godin Avenue
Quebec (Quebec) G1M 2K2
CANADA

1 866 683-0155 (USA and Canada)
Tel.: 1 418 683-5498
Fax: 1 418 683-9224
support@exfo.com

EXFO Europe Service Center

Winchester House, School Lane
Chandlers Ford, Hampshire S053 4DG
ENGLAND

Tel.: +44 2380 246800
Fax: +44 2380 246801
support.europe@exfo.com

EXFO Telecom Equipment (Shenzhen) Ltd.

3rd Floor, Building C,
FuNing Hi-Tech Industrial Park, No. 71-3,
Xintian Avenue,
Fuhai, Bao'An District,
Shenzhen, China, 518103

Tel: +86 (755) 2955 3100
Fax: +86 (755) 2955 3101
support.asia@exfo.com

To view EXFO's network of partner-operated Certified Service Centers nearest you, please consult EXFO's corporate website for the complete list of service partners:

<http://www.exfo.com/support/services/instrument-services/exfo-service-centers>.

A ***Installing the Hand Strap***

If desired, you can install the provided hand strap on your unit.

To install the hand strap:

- 1.** Position your unit so that its front panel rests on a flat surface such as a table.
- 2.** Pinch the string loop of the strap between your index finger and your thumb.
- 3.** Slide the string loop down through the first hole of the unit's casing until it stops.

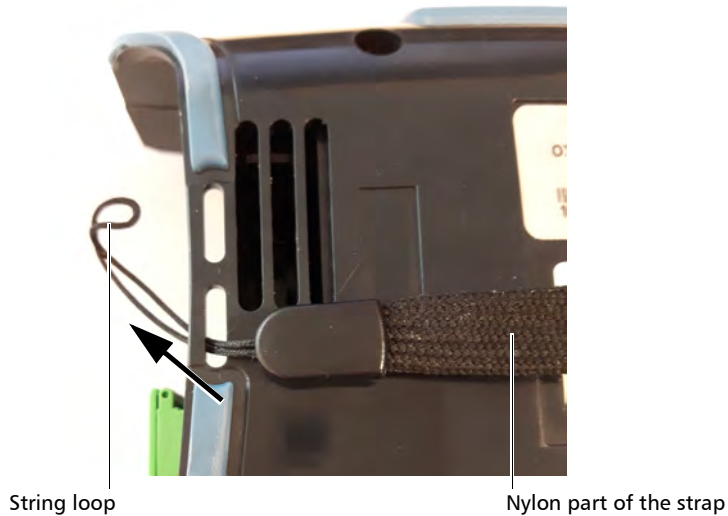

Installing the Hand Strap

4. While holding the strap with one hand, slide the string loop up through the second hole of the unit's casing. You may need to push the string with your finger.



5. Slide the nylon part of the strap entirely *through* the string loop.



6. Gently pull on the hand strap to secure the knot.



You are now ready to use the hand strap.

Index

---	147
*	163
<	134
>	134

A

absolute power	139, 140, 148
AC requirements	19, 20
accessing online help	
from the smart device	211
from the unit	261
adapter	18
additional verifications on connectors	232
adjusting	
brightness	39
date, time and time zone	45
after-sales service	265
anchors for hand strap	3, 277
APC-type connector	29, 129
applications, installing	240
arrows, navigation	136, 160
auto navigation	
disabling	68
enabling	68
auto save	
disabling	66
enabling	66
automatic	
connection to network	195
fan speed	37
PON detection	61
available models	5

B

backlight, setting	39
battery	
clock	8, 217, 220
level	215, 227, 248
maintenance recommendations	215, 218
purchasing new	219
recharging	4, 8, 215, 217
replacing or removing	220, 221
resetting information	98, 226
status icons	8, 215, 227, 248
status LED	3, 7, 215, 227, 248
beep, enabling or disabling	40, 41
beginning of the link	135, 163
blinking LED	7
blue LED	7
Bluetooth	
closing connection	177
data transfer	177
establishing connection	177, 178
frequency band data	xii, xiii, xv
signal strength	179
status	177, 179
boot, first	23
brightness	
adjusting	39
icon	40
button, on/off	3, 7, 217, 221

C

capacitors	18
cascaded splitters	80
caution	
of personal hazard	12
of product hazard	12
changing	
battery	220, 221
connector	234

Index

- date and time 45
 - distance units 51
 - element type 163
 - IOR value 95
 - language 43
 - time zone 45
 - wavelengths 56
 - charge
 - icon 215, 227
 - status of the battery 215, 227, 248
 - charger 18
 - charging battery 4
 - cleaning
 - fiber ends 35
 - front panel 213
 - SC connectors 214
 - touchscreen 215
 - Click-Out
 - connector verifications 228
 - optical connector 3, 4, 232, 234
 - clock battery 8, 217, 220
 - closing a connection 177
 - colors, LEDs 7
 - configured networks 186, 189
 - configuring
 - automatic connection 195
 - brightness 39
 - custom pass/fail thresholds or EXFO Advisor
70
 - date and time 45
 - delay before sleep 54
 - distance units 51
 - IOR value 95
 - language 43
 - modulation 151, 153
 - reference value 146
 - sound notifications 41
 - test cord lengths 30, 33
 - thresholds, power checker 140
 - time zone 45
 - timer, source 151, 153, 157
 - unit 23
 - Wi-Fi communication 181
 - wireless network 186
 - connecting
 - to wireless network 186, 195
 - via Bluetooth 177, 178
 - connector
 - A 135, 163
 - APC 29, 129
 - B 135, 163
 - cleaner 214
 - on link 136
 - UPC 29, 129
 - verifications 228, 232
 - continuous modulation 151, 153
 - conventions, safety 12
 - creating
 - job measurement reports 209
 - measurement reports 170
 - current, electrical 20
 - custom pass/fail thresholds 70, 133
 - customer service 274
 - customizing report information 172
- ## D
- damaged connector on unit 234
 - data transfer 177
 - date and time, adjusting 45
 - deactivating Wi-Fi 181
 - decimal separator 1
 - default values 98, 226, 251
 - demarcation section 87
 - detecting modulated signal and tone 139
 - detector, saturation level 134
 - disabling
 - power measurements 61
 - sounds 40, 41
 - disconnecting from Bluetooth 177
 - distance units 51
 - documentation 211, 261
 - drawer 26, 33, 59, 76, 85, 92
 - dynamic range, insufficient 136

- E**
- editing
 - IOR value 95
 - report information 172
 - element
 - connector 136, 163
 - group 136
 - macrobend 136
 - out of range 136
 - splice 136, 163
 - types, changed 163
 - enabling
 - power measurements 61
 - sounds 40, 41
 - Wi-Fi 181
 - end
 - of acquisition, audible signal 40
 - of the link 135, 163
 - equipment returns 274
 - establishing a connection
 - via Bluetooth 177, 178
 - with a wireless network 195
 - EXFO Advisor
 - audible signal 40
 - rating system 70, 127, 133
 - existing measurement 204
 - external power supply 18
- F**
- factory settings 98, 226, 251
 - fail status 70, 133, 139, 140
 - fan speed 37
 - Fault Xplorer 10, 26, 127, 131, 133
 - favorite networks 186, 189
 - feet, distance units 51
 - fiber ends, cleaning 35
 - Fiber Xplorer 24
 - fibers, testing 128, 204
 - filter, incoming light 138
- G**
- generating
 - job measurement reports 209
 - measurement reports 170
 - GPON detection 61
 - group of elements 136, 138
- H**
- hand strap
 - anchoring 3, 277
 - installation 277
 - help, online 211, 261
 - high temperature 37
 - hour, setting 45
- I**
- icon
 - battery status 8, 215, 227, 248
 - Bluetooth status 177, 179
 - brightness 40
 - connectors 136
 - group 136
 - macrobend 136
 - out of range 136
 - quick save 25
 - source, on 156
 - splice 136
 - Wi-Fi status 188
 - identification
 - measurement 25
 - number 136
 - identification label 265
- I**
- first
 - element on link 135, 163
 - startup 23
 - Flash Advisor 10, 26, 127, 131, 133
 - forget networks 197
 - frequency, Bluetooth and Wi-Fi xii, xiii, xv
 - front panel, cleaning 213

Index

- imperial units 51
- incrementing measurement name..... 159
- indoor use 18
- input current..... 20
- inserting battery..... 220, 221
- insertion loss 139, 140, 148
- installing
 - hand strap 277
 - software 240
 - TestFlow/Exchange
 - mobile application..... 176
- interface, changing language..... 43
- internal
 - connector 228, 232, 234
 - temperature 9, 37
- IOR value, setting 95
- IPv4 wireless routers characteristics..... 187

- J**
- job measurements
 - creating reports 209
 - performing again..... 204
- jobs
 - creating 110
 - deleting 117
 - understanding 102
- junction between fiber sections 136

- K**
- kilofeet, distance units 51
- kilometer, distance units 51

- L**
- label, identification 265
- language, selecting 43
- last element on link..... 135, 163
- launch cord
 - length 134
 - specifications..... 29, 129
- LED
 - battery status..... 3, 215, 227, 248
 - indicators 7
- light
 - emission..... 151, 153, 157
 - on detector 138
 - source 10
- Li-ion/Li-Po battery 8, 215
- link
 - end, letter B 135, 163
 - overview area..... 26, 135
 - start, letter A..... 135, 163
 - worst loss and ORL values..... 133
- Link Mapper 10, 26, 127, 131, 133
- link results
 - area..... 25
 - pass/fail status 133
- link view
 - area..... 26, 136
 - connectors 136
 - group of elements 136, 138
 - macrobend 136
 - out of range..... 136
 - splice..... 136
- list
 - of configured networks 186, 189
 - of networks, removing item from 197
- loss value, by wavelength 134
- low signal 139, 147

- M**
- macrobend 136
- main features 2
- maintenance
 - battery 215, 218
 - front panel..... 213
 - general information 213
 - screen 215
- manuals..... 211, 261

maximum
 input current 20
 power loss value 140
 measurement
 distance units 51
 identification 25
 incrementing name 159
 performing 128
 status..... 70, 133, 139, 140
 stopped, power checker 139
 stopped, source 151, 157
 viewing 159, 160
 measuring absolute power
 and insertion loss 139, 148
 mechanical connector cleaning 214
 meter, distance units 51
 metric units 51
 minimum power loss value 140
 models
 available 5
 with Click-Out connector 228, 232, 234
 without Click-Out connector..... 228, 234
 modifying
 element type..... 163
 report information..... 172
 modulated signal, power checker 139
 modulation, light source 151, 153
 muting unit 40, 41

N

naming measurements..... 159
 navigation arrows 25, 128, 136, 160, 204
 network
 failure 195
 password 189
 settings..... 189
 notifications 25, 27
 number of pending notifications..... 25, 27
 nylon band, hand strap 278

O

obtaining batteries 219
 off LED 7
 on/off button..... 3, 7, 217, 221
 online help 211, 261
 ONT detection 80
 operation language 43
 optical
 Click-Out connector 232, 234
 output diagnosis..... 228
 port..... 3, 4
 options, Bluetooth..... 177
 ORL, value by wavelength..... 134
 out of range element..... 136
 overwritten measurements..... 159

P

pass status..... 70, 133, 139, 140
 pass/fail
 audible signal..... 40
 status displayed 133, 139, 140
 status for a group of elements..... 138
 threshold values, power checker 140
 PDF format for reports..... 170, 209
 pending notifications 25, 27
 performing
 job measurements again..... 204
 measurements 11, 128
 power and loss measurements..... 148
 PON
 detection 61
 tool 80
 port
 filtered 138
 USB 4
 power
 adapter 8, 217
 bank..... 8, 217
 button..... 3, 7, 217, 221
 management 54
 measurements, configuring settings..... 61

Index

see also battery
see also USB power adapter
sources 20
supply 18
value, unknown 147
power checker
absolute power and insertion loss 139, 140,
148
audible signal 40
low signal 139, 147
measurement stopped 139
setting reference values 146
threshold values 140
tool 10
preferred networks 186, 189
preventing automatic Wi-Fi connection 197
product
identification label 265
specifications 11
purchasing new batteries 219

Q

quick save icon 25

R

receive cord
length 134
specifications 29, 129
receiving data via Bluetooth 177
reception filter 138
recharging the battery 8, 215, 217
recovery operation 251
red LED 7, 248
reference values, power checker 146
regional and language settings 23
regulatory information vii, viii, xi
removing
battery 220, 221
configured networks 197
repairing unit 18
replaceable Click-Out connector 228, 232, 234

replacement batteries 219
replacing
battery 98, 220, 221
connector 234
report creation
job measurements 209
single measurements 170
resetting battery info 226
retrieving a job from TestFlow 200
return merchandise authorization (RMA) .. 274
reverting unit to initial state 251
RF VIDEO detection 61

S

safety
caution 12
conventions 12
warning 12
saturation level, detector 134
saved networks 186, 189
SC connectors, cleaning 214
secured network
configuring 189
icon 190, 193
selecting
distance units 51
language 43
modulation 151, 153
specialized tests 80
time zone 45
wavelengths 56
sending data via Bluetooth 177
separator, decimal value 1
sequential
name 159
number 136
service and repairs 274
service centers 275
setting
automatic connection 195
brightness 39

- custom pass/fail thresholds..... 70
 - date and time..... 45
 - demarcation section thresholds..... 87
 - EXFO Advisor..... 70
 - IOR value..... 95
 - power measurements..... 61
 - reference value..... 146
 - reset..... 98, 226, 251
 - sleep mode..... 54
 - software update..... 240
 - sound notifications..... 41
 - test cords length..... 30, 33
 - threshold values, power checker..... 140
 - timer, source..... 151, 153, 157
 - Wi-Fi communication..... 181
 - wireless network..... 186
 - shipping to EXFO..... 274
 - shutting down..... 22
 - signal
 - low, power checker..... 139, 147
 - modulated..... 139
 - strength, Bluetooth..... 179
 - strength, Wi-Fi..... 188, 190, 193
 - single measurements, creating reports..... 170
 - sleep mode..... 22, 54
 - software, installing and upgrading..... 240
 - sound notifications..... 40, 41
 - source
 - measurement stopped..... 151, 157
 - modulation..... 151, 153
 - on, icon..... 156
 - performing measurements..... 151, 152
 - specialized tests..... 80
 - specifications, product..... 11
 - splice..... 136, 163
 - splitter
 - detection..... 80
 - ratio..... 80
 - status
 - Bluetooth..... 177, 179
 - fail..... 133, 139, 140
 - pass..... 133, 139, 140
 - star rating..... 70, 133
 - unknown..... 133, 139, 140
 - Wi-Fi..... 188
 - stopping
 - measurement, power checker..... 139
 - measurement, source..... 151, 157
 - Wi-Fi communication..... 181
 - storage requirements..... 213
 - strength of the signal..... 188, 190, 193
 - sub-element in grouped elements..... 138
 - symbols, safety..... 12
 - synchronizing job results..... 206
- T**
- taking a reference value..... 146
 - technical specifications..... 11
 - technical support..... 265
 - temperature for storage..... 213
 - temperature management..... 37
 - test cords
 - setting..... 30, 33
 - specifications..... 29, 129
 - test points
 - adding..... 120
 - deleting..... 123
 - generating identifiers..... 104
 - understanding..... 103
 - TestFlow/Exchange mobile application, installing..... 176
 - testing
 - fibers..... 128, 204
 - touchscreen..... 258
 - three-line menu..... 25
 - thresholds
 - demarcation section..... 87
 - power checker..... 140
 - time zone, selecting..... 45
 - timer, light emission..... 151, 153
 - title bar..... 25, 188
 - tone, power checker..... 139

Index

tool
 light source..... 10
 power checker 10
touchscreen
 cleaning 215
 location 3
 testing tool 258
transferring
 data via Bluetooth 177
 jobs..... 200
transportation requirements 213, 270
turning on/off
 sounds 40, 41
 unit..... 21, 22
 Wi-Fi 181
types of connectors..... 29, 129

U

understanding Fiber Explorer 24
unit
 damaged connector 234
 first configuration..... 23
 repairing 18
 restoring 251
 unexpected shutdown 37
 ventilation 19
unknown
 power value, power checker 147
 status..... 70, 133, 139, 140
UPC-type connector 29, 129
updating applications 240
USB
 port 4
 power adapter..... 8, 217
 power bank 8, 217
user guides..... 211, 261
using
 light source..... 151, 152
 test cords..... 29, 30, 33, 129
 unit..... 11

V

value
 loss and ORL, by wavelength 134
 worst link loss and ORL 133
ventilation 19
verifications before repairs 232
verifying
 the optical output..... 228
 the touchscreen 258
viewing
 link results..... 133
 measurements 159, 160
 notifications..... 27
 results in link overview..... 135
 results in link view 136

W

warranty
 certification..... 273
 exclusions 273
 general..... 271
 liability 273
 null and void 271
wavelengths
 defining thresholds, power checker 140
 setting 56
 viewing values 134
Wi-Fi
 connecting 186
 frequency band data..... xii, xiii, xv
 status 188
wireless
 IPv4 routers characteristics..... 187
 network configuration 189
 networks 186, 189
 networks removed from list 197
wizard, configuration 23
working with
 custom pass/fail thresholds..... 70
 demarcation section 87
 EXFO Advisor 70

jobs..... 200
link overview..... 135
link results 133
link view 136
specialized tests 80
test cords..... 29, 30, 33
worst link loss and ORL values..... 133
wrist band 277, 278

X

XGS-PON detection 61

CHINESE REGULATION ON RESTRICTION OF HAZARDOUS SUBSTANCES (RoHS)
中国关于有害物质限制的规定

NAMES AND CONTENTS OF THE TOXIC OR HAZARDOUS SUBSTANCES OR ELEMENTS
CONTAINED IN THIS EXFO PRODUCT
包含在本 EXFO 产品中的有毒有害物质或元素的名称及含量

Part Name 部件名称	Lead 铅 (Pb)	Mercury 汞 (Hg)	Cadmium 镉 (Cd)	Hexavalent Chromium 六价铬 (Cr(VI))	Polybrominated biphenyls 多溴联苯 (PBB)	Polybrominated diphenyl ethers 多溴二苯醚 (PBDE)
Enclosure 外壳	O	O	O	O	O	O
Electronic and electrical sub-assembly 电子和电气组件	X	O	X	O	X	X
Optical sub-assembly ^a 光学组件 ^a	X	O	O	O	O	O
Mechanical sub-assembly ^a 机械组件 ^a	O	O	O	O	O	O

Note:

注:

This table is prepared in accordance with the provisions of SJ/T 11364.

本表依据 SJ/T 11364 的规定编制。

O: Indicates that said hazardous substance contained in all of the homogeneous materials for this part is below the limit requirement of GB/T 26572.

O: 表示该有害物质在该部件所有均质材料中的含量均在 GB/T 26572 标准规定的限量要求以下。

X: indicates that said hazardous substance contained in at least one of the homogeneous materials used for this part is above the limit requirement of GB/T 26572. Due to the limitations in current technologies, parts with the "X" mark cannot eliminate hazardous substances.

X: 表示该有害物质至少在该部件的某一均质材料中的含量超出 GB/T 26572 标准规定的限量要求。



标记 "X" 的部件, 皆因全球技术发展水平限制而无法实现有害物质的替代。

a. If applicable.

如果适用。

MARKING REQUIREMENTS

标注要求

Product 产品	Environmental protection use period (years) 环境保护使用期限 (年)	Logo 标志
This EXFO product 本 EXFO 产品	10	
Battery ^a 电池	5	

a. If applicable.
如果适用。

P/N: 5.0.0.1

www.EXFO.com · info@EXFO.com

CORPORATE HEADQUARTERS 400 Godin Avenue

Quebec (Quebec) G1M 2K2 CANADA
Tel.: 1 418 683-0211 · Fax: 1 418 683-2170

TOLL-FREE (USA and Canada)

1 800 663-3936

© 2022 EXFO Inc. All rights reserved.
Printed in Canada (2022-11)

